

THE
ENCYCLOPÆDIA BRITANNICA

ELEVENTH EDITION

FIRST	edition, published in three	volumes,	1768—1771.
SECOND	” ” ten	”	1777—1784.
THIRD	” ” eighteen	”	1788—1797.
FOURTH	” ” twenty	”	1801—1810.
FIFTH	” ” twenty	”	1815—1817.
SIXTH	” ” twenty	”	1823—1824.
SEVENTH	” ” twenty-one	”	1830—1842.
EIGHTH	” ” twenty-two	”	1853—1860.
NINTH	” ” twenty-five	”	1875—1889.
TENTH	” ninth edition and eleven supplementary volumes,		1902—1903.
ELEVENTH	” published in twenty-nine volumes,		1910—1911.

COPYRIGHT
in all countries subscribing to the
Bern Convention
by
THE CHANCELLOR, MASTERS AND SCHOLARS
of the
UNIVERSITY OF CAMBRIDGE

All rights reserved

THE
ENCYCLOPÆDIA BRITANNICA

A
DICTIONARY
OF
ARTS, SCIENCES, LITERATURE AND GENERAL
INFORMATION

ELEVENTH EDITION

VOLUME XVIII
MEDAL to MUMPS

New York
Encyclopædia Britannica, Inc.
342 Madison Avenue

Copyright, in the United States of America, 1911,

by

The Encyclopædia Britannica Company.

INITIALS USED IN VOLUME XVIII. TO IDENTIFY INDIVIDUAL
CONTRIBUTORS,¹ WITH THE HEADINGS OF THE
ARTICLES IN THIS VOLUME SO SIGNED.

A. Ca.	ARTHUR CAYLEY, LL.D., F.R.S. See the biographical article, CAYLEY, ARTHUR.	Monge, Gaspard.
A. E. G.	REV. ALFRED ERNEST GARVIE, M.A., D.D. Principal of New College, Hampstead. Member of the Board of Theology and the Board of Philosophy, London University. Author of <i>Studies in the inner Life of Jesus</i> ; &c.	Miracle.
A. E. S.	ARTHUR EVERETT SHIPLEY, M.A., D.Sc., F.R.S. Master of Christ's College, Cambridge. Reader in Zoology, Cambridge University. Joint-editor of the <i>Cambridge Natural History</i> .	Mesozoa.
A. F. P.	ALPERT FREDERICK POLLARD, M.A., F.R.HIST.S. Professor of English History in the University of London. Fellow of All Souls' College, Oxford. Assistant Editor of the <i>Dictionary of National Biography</i> , 1893-1901. Lothian Prizeman (Oxford), 1892; Arnold Prizeman, 1898. Author of <i>England under the Protector Somerset</i> ; <i>Henry VIII.</i> ; <i>Life of Thomas Cranmer</i> ; &c.	Morton, John.
A. Go.*	REV. ALEXANDER GORDON, M.A. Lecturer on Church History in the University of Manchester.	Menius; Mennonites; Menno, Simons; Morone.
A. G. D.	ARTHUR GEORGE DOUGHTY, M.A., LITT.D., C.M.G. Dominion Archivist of Canada. Member of the Geographical Board of Canada. Author of <i>The Cradle of New France</i> ; &c. Joint-editor of <i>Documents relating to the Constitutional History of Canada</i> .	Mercier, Honoré.
A. Ha.	ADOLF HARNACK. See the biographical article, HARNACK, ADOLF.	Millennium; Montanism.
A. H.-S.	SIR A. HOUTUM-SCHINDLER, C.I.E. General in the Persian Army. Author of <i>Eastern Persian Irak</i> .	Meshed.
A. J. G.	REV. ALEXANDER JAMES GRIEVE, M.A., B.D. Professor of New Testament and Church History at the United Independent College, Bradford. Sometime Registrar of Madras University and Member of Mysore Educational Service.	Missions (<i>in part</i>).
A. J. L.	ANDREW JACKSON LAMOURÉUX. Librarian, College of Agriculture, Cornell University. Formerly Editor of the <i>Rio News</i> , Rio de Janeiro.	Mexico: Geography.
A. L.	ANDREW LANG. See the biographical article, LANG, ANDREW.	Molière.
A. M. C.	AGNES MARY CLERKE. See the biographical article, CLERKE, A. M.	Mouchez.
A. N.	ALFRED NEWTON, F.R.S. See the biographical article, NEWTON, ALFRED.	Megapode; Merganser; Mocking Bird; Moor-Hen; Morillon; Motmot; Mouse-Bird.
A. Se.*	ADAM SEDGWICK, M.A., F.R.S. Professor of Zoology at the Imperial College of Science and Technology, London. Fellow, and formerly Tutor, of Trinity College, Cambridge. Professor of Zoology in the University of Cambridge, 1907-1909.	Metamorphosis.
A. V. G.	BARON ALFRED VON GUTSCHMID. See the biographical article, GUTSCHMID, ALFRED, BARON VON.	Moses of Chorene (<i>in part</i>).
A. Wa.	ARTHUR WAUGH, M.A. New College, Oxford. Newdigate Prize, 1888. Author of <i>Gordon in Africa</i> ; <i>Alfred, Lord Tennyson</i> . Editor of <i>Johnson's Lives of the Poets</i> ; editions of <i>Dickens</i> , <i>Tennyson</i> , <i>Arnold</i> , <i>Lamb</i> ; &c.	Morris, William.

¹ A complete list, showing all individual contributors, appears in the final volume.

- B. J.** BERNHARD JÜLG (1825-1886).
Formerly Professor of Classical Philology in the University of Innsbrück. Author of *Mongolische Märchensammlung; Über Wesen und Aufgabe der Sprachwissenschaft; and On the Present State of Mongolian Researches.* } **Mongols: Language.**
- B. M.*** BUDGETT MEAKIN (1866-1906).
Formerly Editor of the *Times of Morocco*. Author of *The Land of the Moors; The Moorish Empire; Life in Morocco; &c.* } **Morocco (in part).**
- C. A.** CLEVELAND ABBE, A.M., LL.D.
Professor of Meteorology, U.S. Weather Bureau, Washington. Director of the Cincinnati Observatory, 1863-1873. Editor of *Monthly Weather Review*; and *Bulletin of Mount Weather Observatory*. Author of *Meteorological Apparatus and Methods; &c.* } **Meteorology.**
- C. B. W.*** CHARLES BERTIE WEDD, F.G.S.
Joint-author of various memoirs and maps of the Geological Survey. } **Millstone Grit; Miocene.**
- C. C.** CHARLES CREIGHTON, M.A., M.D.
King's College, Cambridge. Author of *A History of Epidemics in Britain; Jenner and Vaccination; Plague in India; &c.* } **Monster (in part); Morgagni.**
- C. EL.** SIR CHARLES NORTON EDGUMBE ELIOT, K.C.M.G., C.B., M.A., LL.D., D.C.L.
Vice-Chancellor of Sheffield University. Formerly Fellow of Trinity College, Oxford. H.M.'s Commissioner and Commander-in-Chief for the British East Africa Protectorate; Agent and Consul-general at Zanzibar; and Consul-general for German East Africa, 1900-1904. } **Mordvinians.**
- C. F. A.** CHARLES FRANCIS ATKINSON.
Formerly Scholar of Queen's College, Oxford. Captain, 1st City of London (Royal Fusiliers). Author of *The Wilderness and Cold Harbour.* } **Medal: War Decoration, (in part).**
- C. F. B.** CHARLES FRANCIS BASTABLE, M.A., LL.D.
Regius Professor of Laws and Professor of Political Economy in the University of Dublin. Author of *Public Finance; Commerce of Nations; Theory of International Trade; &c.* } **Monetary Conferences: Money.**
- C. G. Ala.** CHALONER GRENVILLE ALABASTER.
Barrister-at-Law, Inner Temple. } **Money-Lending.**
- C. J. B.** CHARLES JASPER BLUNT, A.O.D.
Major, Royal Artillery. Chief Ordnance Officer, Singapore. Served through Chitral Campaign. } **Mohmand Campaign.**
- C. J. F.*** CONSTANCE JOCELYN FPOULKES.
Translator of Morelli's *Italian Painters; &c.* } **Morelli.**
- C. J. L.** SIR CHARLES JAMES LYALL, K.C.S.I., C.I.E., LL.D. (Edin.).
Secretary, Judicial and Public Department, India Office. Fellow of King's College, London. Secretary to Government of India in Home Department, 1889-1894. Chief Commissioner, Central Provinces, India, 1895-1898. Author of *Translations of Ancient Arabic Poetry; &c.* } **Mofaddallyat.**
- C. MI.** CHEDOMILLE MIJATOVICH.
Senator of the Kingdom of Servia. Envoy Extraordinary and Minister Plenipotentiary of the King of Servia to the Court of St James's, 1895-1900, and 1902-1903. } **Michael Obrenovich III.; Milosh Obrenovich I.**
- C. Mo.** WILLIAM COSMO MONKHOUSE.
See the biographical article, MONKHOUSE, WILLIAM COSMO. } **Millais.**
- C. PI.** CHRISTIAN PFISTER, D-ÈS.-L.
Professor at the Sorbonne, Paris. Chevalier of the Legion of Honour. Author of *Études sur le règne de Robert le Pieux.* } **Merovingians.**
- C. R. B.** CHARLES RAYMOND BEAZLEY, M.A., D.LITT., F.R.G.S., F.R.HIST.S.
Professor of Modern History in the University of Birmingham. Formerly Fellow of Merton College, Oxford, and University Lecturer in the History of Geography, Lothian Prize-man, Oxford, 1889. Lowell Lecturer, Boston, 1908. Author of *Henry the Navigator; The Dawn of Modern Geography; &c.* } **Mela, Pomponius (in part); Mercator; Monte Corvino.**
- C. R. W. B.** C. R. W. BIGGAR, M.A., K.C. } **Mowat, Sir Oliver.**
- C. S. R.** HON. CHARLES STEWART ROLLS, M.A., F.R.G.S. (1877-1910).
Trinity College, Cambridge. British Pioneer of Motoring and Aviation. Formerly Managing Director of Rolls-Royce, Ltd. } **Motor Vehicles: Light Vehicles.**
- C. We.** CECIL WEATHERLY.
Formerly Scholar of Queen's College, Oxford. Barrister-at-Law. } **Monument.**
- D. B. Ma.** DUNCAN BLACK MACDONALD, M.A., D.D.
Professor of Semitic Languages, Hartford Theological Seminary, U.S.A. Author of *Development of Muslim Theology, Jurisprudence and Constitutional Theory; Selections from Ibn Khaldun; Religious Attitude and Life in Islam; &c.* } **Mufti.**
- D. F. T.** DONALD FRANCIS TOVEY.
Author of *Essays in Musical Analysis*: comprising *The Classical Concerto, The Goldberg Variations*, and analyses of many other classical works. } **Melody; Mendelssohn-Bartholdy (in part); Motet; Mozart (in part).**
- D. GI.** SIR DAVID GILL, K.C.B., LL.D., F.R.S., F.R.A.S., D.Sc.
H.M. Astronomer at Cape of Good Hope, 1879-1907. Served on Geodetic Survey of Egypt, and on the expedition to Ascension Island to determine the Solar Parallax by observations of Mars. Directed Geodetic Survey of Natal, Cape Colony, and Rhodesia. Author of *Geodetic Survey of South Africa; Catalogues of Stars for the Equinoxes, 1850, 1860, 1885, 1890, 1900; &c.* } **Micrometer.**

- D. G. H.** DAVID GEORGE HOGARTH, M.A.
Keeper of the Ashmolean Museum, Oxford. Fellow of Magdalen College, Oxford, Fellow of the British Academy. Excavated at Paphos, 1888; Naucratis 1899 and 1903; Ephesus, 1904-1905; Assiut, 1906-1907. Director, British School at Athens, 1897-1900. Director, Cretan Exploration Fund, 1899. } **Mersina; Miletus.**
- D. H.** DAVID HANNAY.
Formerly British Vice-Consul at Barcelona. Author of *Short History of the Royal Navy; Life of Emilio Castelar*; &c. } **Meloria; Mina.**
- D. LI. T.** DANIEL LLEUFER THOMAS.
Barrister-at-Law, Lincoln's Inn. Stipendiary Magistrate at Pontypridd and Rhondda. } **Merthyr Tydfil.**
- D. Ma.** DAVID MASSON, LL.D.
See the biographical article, MASSON, DAVID. } **Milton (in part).**
- D. Mn.** REV. DUGALD MACFADYEN, M.A.
Minister of South Grove Congregational Church, Highgate. Author of *Constructive Congregational Ideals*; &c. } **Melville, Andrew.**
- D. N. P.** DIARMID NOEL PATON, M.D., F.R.C.P. (Edin.).
Regius Professor of Physiology in the University of Glasgow. Formerly Superintendent of Research Laboratory of Royal College of Physicians, Edinburgh. Biological Fellow of Edinburgh University, 1884. Author of *Essentials of Human Physiology*; &c. } **Metabolic Diseases.**
- D. R.-M.** DAVID RANDALL-MACIVER, M.A., D.Sc.
Curator of Egyptian Department, University of Pennsylvania. Formerly Worcester Reader in Egyptology, University of Oxford. Author of *Medieval Rhodesia*; &c. } **Monomotapa.**
- D. S. M.*** DAVID SAMUEL MARGOLIOUTH, M.A., D.LITT.
Laudian Professor of Arabic, Oxford. Fellow of New College. Author of *Arabic Papyri of the Bodleian Library; Mohammed and the Rise of Islam; Cairo, Jerusalem and Damascus.* } **Meroe.**
- E. A. M.** EDWARD ALFRED MINCHIN, M.A., F.Z.S.,
Professor of Protozoology in the University of London. Formerly Fellow of Merton College, Oxford. } **Medusa.**
- E. B. T.** EDWARD BURNETT TYLOR, D.C.L., LL.D.
See the biographical article, TYLOR, EDWARD BURNETT. } **Mexico: Ancient History (in part).**
- E. C. B.** RIGHT REV. EDWARD CUTHBERT BUTLER, O.S.B., D.LITT.
Abbot of Downside Abbey, Bath. Author of "The Lausiatic History of Palladius" in *Cambridge Texts and Studies*, vol. vi. } **Mendicant Movement and Orders; Monasticism; Monte Cassino.**
- E. E. A.** ERNEST E. AUSTEN.
Assistant in Department of Zoology, Natural History Museum, South Kensington. } **Mosquito.**
- E. F. S. D.** LADY DILKE.
See the biographical article, DILKE, SIR C. W., BART. } **Millet, Jean François.**
- E. Gr.** ERNEST ARTHUR GARDNER, M.A.
See the biographical article, GARDNER, PERCY. } **Megalopolis; Megara (in part); Melos.**
- E. H. B.** SIR EDWARD HERBERT BUNBURY, BART., M.A., F.R.G.S. (d. 1895).
M.P. for Bury St Edmunds, 1847-1852. Author of *A History of Ancient Geography*; &c. } **Mela, Pomponius (in part).**
- E. H. M.** ELLIS HOVELL MINNS, M.A.
University Lecturer in Palaeography, Cambridge. Lecturer and Assistant Librarian at Pembroke College, Cambridge. Formerly Fellow of Pembroke College. } **Melanchlaeni.**
- E. K.** EDMUND KNECHT, PH.D., M.Sc. TECH. (Manchester), F.I.C.
Professor of Technological Chemistry, Manchester University. Head of Chemical Department, Municipal School of Technology, Manchester. Examiner in Dyeing, City and Guilds of London Institute. Author of *A Manual of Dyeing*; &c. Editor of *Journal of the Society of Dyers and Colourists.* } **Mercerizing.**
- Ed. M.** EDUARD MEYER, PH.D., D.LITT. (Oxon.), LL.D.
Professor of Ancient History in the University of Berlin. Author of *Geschichte des Alterthums; Geschichte des alten Aegyptens; Die Israeliten und ihre Nachbarstämme.* } **Media; Memnon of Rhodes; Menander (MILINDA) (in part); Mentor of Rhodes; Mithradates.**
- E. O.*** EDMUND OWEN, M.B., F.R.C.S., LL.D., D.Sc.
Consulting Surgeon to St Mary's Hospital, London, and to the Children's Hospital, Great Ormond Street, London. Chevalier of the Legion of Honour. Late Examiner in Surgery at the Universities of Cambridge, London and Durham. Author of *A Manual of Anatomy for Senior Students.* } **Mortification; Mouth and Salivary Glands (Surgery).**
- E. Pr.** EDGAR PRESTAGE.
Special Lecturer in Portuguese Literature in the University of Manchester. Examiner in Portuguese in the Universities of London, Manchester, &c. Commendador, Portuguese Order of S. Thiago. Corresponding Member of Lisbon Royal Academy of Sciences, Lisbon Geographical Society; &c. Editor of *Letters of a Portuguese Nun; Azurara's Chronicle of Guinea*; &c. } **Moraes.**

- E. R. L.** SIR EDWIN RAY LANKESTER, K.C.B., F.R.S., M.A., D.Sc., LL.D.
Hon. Fellow of Exeter College, Oxford. President of the British Association, 1906.
Professor of Zoology and Comparative Anatomy in University College, London, 1874-1890. Linacre Professor of Comparative Anatomy at Oxford, 1891-1898.
Director of the Natural History Departments of the British Museum, 1898-1907.
Vice-President of the Royal Society, 1896. Romanes Lecturer at Oxford, 1905.
Author of *Degeneration; The Advancement of Science; The Kingdom of Man*; &c.
- E. St.** EUGENE STOCK.
Formerly Editorial Secretary of the Church Missionary Society.
- E. S. S.** EDWARD SHRAPNELL SMITH.
Editor of *The Commercial Motor*. Hon. Treasurer of the Commercial Motor Users Association. Organiser of the Lancashire Heavy Motor Trials of 1898, 1899-1901.
- F. C. C.** FREDERICK CORNWALLIS CONYBEARE, M.A., D.Th. (Giessen).
Fellow of the British Academy. Formerly Fellow of University College, Oxford.
Editor of *The Ancient Armenian Texts of Aristotle*. Author of *Myth, Magic and Morals*; &c.
- F. G. M. B.** FREDERICK GEORGE MEESON BECK, M.A.
Fellow and Lecturer of Clare College, Cambridge.
- F. G. P.** FREDERICK GYMER PARSONS, F.R.C.S., F.Z.S., F.R.ANTHROP.INST.
Vice-President, Anatomical Society of Great Britain and Ireland. Lecturer on Anatomy at St Thomas's Hospital and the London School of Medicine for Women, London. Formerly Hunterian Professor at the Royal College of Surgeons.
- F. H. No.** FRANCIS HENRY NEVILLE, M.A., F.R.S.
Fellow and Lecturer in Natural Science, Sidney Sussex College, Cambridge.
- F. J. H.** FRANCIS JOHN HAVERFIELD, M.A., LL.D., F.S.A.
Camden Professor of Ancient History in the University of Oxford. Fellow of Brasenose College. Fellow of the British Academy. Author of Monographs on Roman History, especially Roman Britain; &c.
- F. Ll. G.** FRANCIS LLEWELLYN GRIFFITH, M.A., Ph.D., F.S.A.
Reader in Egyptology, Oxford University. Editor of the Archaeological Survey and Archaeological Reports of the Egypt Exploration Fund. Fellow of Imperial German Archaeological Institute.
- F. N. M.** COLONEL FREDERIC NATUSCH MAUDE, C.B.
Lecturer in Military History, Manchester University. Author of *War and the World's Policy; The Leipzig Campaign; The Jena Campaign*.
- F. O. B.** FREDERICK ORPEN BOWER, M.A., D.Sc., F.R.S.
Regius Professor of Botany in the University of Glasgow. Author of *Practical Botany for Beginners*; &c.
- F. We.** FREDERICK WEDMORE.
See the biographical article, WEDMORE, FREDERICK.
- F. W. R.*** FREDERICK WILLIAM RUDLER, I.S.O., F.G.S.
Curator and Librarian of the Museum of Practical Geology, London, 1879-1902.
President of the Geologists' Association, 1887-1889.
- G. A. B.** GEORGE A. BOULENGER, D.Sc., Ph.D., F.R.S.
In charge of the collections of Reptiles and Fishes, Department of Zoology, British Museum. Vice-President of the Zoological Society of London.
- G. C. W.** GEORGE CHARLES WILLIAMSON, Litt.D.
Chevalier of the Legion of Honour. Author of *Portrait Miniatures; Life of Richard Cosway, R.A.; George Engleheart; Portrait Drawings*; &c. Editor of new edition of Bryan's *Dictionary of Painters and Engravers*.
- G. E. D.** SURGEON-MAJOR GEORGE EDWARD DOBSON, M.A., M.B., F.Z.S., F.R.S. (1848-1895).
Army Medical Department, 1868-1888. Formerly Curator of the Royal Victoria Museum, Netley. Author of *Monograph of the Asiatic Chroptera, &c.; A Monograph of the Insectivora, Systematic and Anatomical*.
- G. F. B.** GEORGE F. BARWICK.
Assistant Keeper of Printed Books and Superintendent of Reading-room, British Museum.
- G. G. S.** GEORGE GREGORY SMITH, M.A.
Professor of English Literature, Queen's University, Belfast. Author of *The Days of James IV.; The Transition Period; Specimens of Middle Scots*; &c.
- G. H. Fo.** GEORGE HERBERT FOWLER, F.Z.S., F.L.S., Ph.D.
Formerly Berkeley Research Fellow, Owens College, Manchester; and Assistant Professor of Zoology at University College, London.
- G. P. R.** GERALD PHILIP ROBINSON.
President of the Society of Mezzotint Engravers. Mezzotint Engraver to Queen Victoria and to King Edward VII.
- G. Sa.** GEORGE SAINTSBURY, LL.D., D.C.L.
See the biographical article, SAINTSBURY, G.
- G. Sn.** GRANT SHOWERMAN, A.M., Ph.D.
Professor of Latin in the University of Wisconsin. Member of the Archaeological Institute of America. Member of American Philological Association. Author of *With the Professor; The Great Mother of the Gods*; &c.
- Metamerism;**
Mollusca (in part).
- Missions** (in part).
- Motor Vehicles:**
Heavy Commercial Vehicles.
- Moses of Chorene** (in part).
- Mercia.**
- Mouth and Salivary Glands.**
- Metallography** (in part).
- Mona.**
- Memphis; Menes;**
Moeris, Lake of;
Mummy.
- Metz.**
- Mohl, Hugo von.**
- Méryon.**
- Moldavite.**
- Mormyr.**
- Miniature;**
Morland, George.
- Mole** (in part).
- Midhat Pasha.**
- Montgomerie.**
- Microtomy.**
- Mezzotint.**
- Mérimée; Michelet, Jules;**
Montaigne; Montesquieu;
Montpensier, Duchesse de
- Mithras.**

INITIALS AND HEADINGS OF ARTICLES

- G. W. T. REV. GRIFFITHES WHEELER THATCHER, M.A., B.D.
Warden of Camden College, Sydney, N.S.W. Formerly Tutor in Hebrew and Old Testament History at Mansfield College, Oxford. { Mubarrad.
- H. B. Wo. HORACE BOLINGBROKE WOODWARD, F.R.S., F.G.S.
Formerly Assistant Director of the Geological Survey of England and Wales. President, Geologists' Association, 1893-1894. Wollaston Medallist, 1908. { Miller, Hugh.
- H. Ch. HUGH CHISHOLM, M.A.
Formerly Scholar of Corpus Christi College, Oxford. Editor of the 11th edition of the *Encyclopaedia Britannica*. Co-editor of the 10th edition. { Meredith, George;
Milan Obrenovitch IV.;
Morley, Viscount.
- H. E. KARL HERMANN ETHÉ, M.A., PH.D.
Professor of Oriental Languages, University College, Aberystwyth (University of Wales). Author of *Catalogue of Persian Manuscripts in the India Office Library, London* (Clarendon Press); &c. { Mirkhond.
- H. Fr. HENRI FRANTZ.
Art Critic, *Gazette des beaux arts*, Paris. { Meissonier.
- H. F. B. HORATIO ROBERT FORBES BROWN, LI.D.
Editor of the *Calendar of Venetian State Papers*, for the Public Record Office. Author of *Life on the Lagoons; Venetian Studies; John Addington Symonds, a Biography*; &c. { Milan (in part).
- H. F. G. HANS FRIEDRICH GADOW, F.R.S., PH.D.
Strickland Curator and Lecturer on Zoology in the University of Cambridge. Author of "Amphibia and Reptiles," in the *Cambridge Natural History*. { Migration: Zoology;
Moa.
- H. H. L. HENRY HARVEY LITTLEJOHN, M.A., M.B., C.M., F.R.C.S. (Edin.), F.R.S. (Edin.)
Professor of Forensic Medicine in the University of Edinburgh. { Medical Jurisprudence
(in part).
- H. L. H. HARRIET L. HENNESSY, M.D. (Brux.), L.R.C.P.I., L.R.C.S.I. { Medical Education, U.S.A.
(in part).
- H. L. S. H. LAWRENCE SWINBURNE (d. 1907). { Medal: War Decorations
(in part).
- H. M. S. HENRY MORSE STEPHENS, M.A.
Balliol College, Oxford. Professor of History and Director of University Extension, University of California. Author of *History of the French Revolution; Modern European History*; &c. { Mirabeau, Honoré.
- H. N. D. HENRY NEWTON DICKSON, M.A., D.Sc., F.R.S. (Edin.), F.R.G.S.
Professor of Geography at University College, Reading. Formerly Vice-President, Royal Meteorological Society. Lecturer in Physical Geography, Oxford. Author of *Meteorology; Elements of Weather and Climate*; &c. { Mediterranean Sea;
Mexico, Gulf of.
- H. O. HERMANN OELISNER, M.A., PH.D.
Taylorian Professor of the Romance Languages in University of Oxford. Member of Council of the Philological Society. Author of *A History of Provençal Literature*; &c. { Mistral.
- H. St. HENRY STURT, M.A.
Author of *Idola Theatri; The Idea of a Free Church; Personal Idealism*. { Metempsychosis.
- H. S. J. HENRY STUART JONES, M.A.
Formerly Fellow and Tutor of Trinity College, Oxford, and Director of the British School at Rome. Member of the German Imperial Archaeological Institute. Author of *The Roman Empire*; &c. { Mosaic: Ancient (in part).
- H. S. M. HENRY SMITH MUNROE, D.Sc., PH.D.
Professor of Mining, Columbia University, New York. { Mining.
- H. S. W. HENRY SPENSER WILKINSON, M.A.
Chichele Professor of Military History, University of Oxford. Fellow of All Souls' College. Author of *The Brain of an Army*; &c. { Moltke, Count von.
- H. T. A. REV. HERBERT THOMAS ANDREWS.
Professor of New Testament Exegesis, New College, London. Author of "The Commentary on Acts" in the *Westminster New Testament; Handbook on the Apocryphal Books* in the "Century" Bible. { Missions (in part).
- H. W. H. HOPE W. HOGG, M.A.
Professor of Semitic Languages and Literatures in the University of Manchester. { Mesopotamia.
- H. W. C. D. HENRY WILLIAM CARLESS DAVIS, M.A.
Fellow and Tutor of Balliol College, Oxford. Fellow of All Souls' College, Oxford, 1895-1902. Author of *England under the Normans and Angevins; Charlemagne*. { Montfort, Simon de.
- H. W. R.* REV. HENRY WHEELER ROBINSON, M.A.
Professor of Church History in Rawdon College, Leeds. Senior Kennicott Scholar, Oxford, 1901. Author of *Hebrew Psychology in Relation to Pauline Anthropology* (in *Mansfield College Essays*); &c. { Micah (in part).
- I. A. ISRAEL ABRAHAM, M.A.
Reader in Talmudic and Rabbinic Literature in the University of Cambridge. Formerly President, Jewish Historical Society of England. Author of *A Short History of Jewish Literature; Jewish Life in the Middle Ages; Judaism*; &c. { Meir; Meir of Rothenburg;
Menasseh ben Israel;
Mendelssohn, Moses;
Mocatta; Molko.
- I. A. C. SIR JOSEPH ARCHER CROWE, K.C.M.G.
See the biographical article, CROWE, SIR J. A. { Memline (in part).

INITIALS AND HEADINGS OF ARTICLES

- J. A. F.** JOHN AMBROSE FLEMING, M.A., F.R.S., D.Sc.
Pender Professor of Electrical Engineering in the University of London. Fellow of University College, London. Formerly Fellow of St John's College, Cambridge, and Lecturer on Applied Mechanics in the University. Author of *Magnets and Electric Currents*. } **Meier, Electric.**
- J. A. S.** JOHN ADDINGTON SYMONDS, LL.D.
See the biographical article, SYMONDS, JOHN ADDINGTON. } **Metastasio.**
- J. A. V.** REV. J. A. VANES.
Professor of New Testament Exegesis, Wesleyan College, Richmond. } **Methodism (in part).**
- J. Bt.** JAMES BARTLETT.
Lecturer on Construction, Architecture, Sanitation, Quantities, &c., at King's College, London. Member of Society of Architects. Member of Institute of Junior Engineers. } **Mortar.**
- J. B. T.** SIR JOHN BATTY TUKE, M.D., F.R.S. (Edin.), D.Sc., LL.D.
President of the Neurological Society of the United Kingdom. Medical Director of New Saughton Hall Asylum, Edinburgh. M.P. for the Universities of Edinburgh and St Andrews, 1900-1910. } **Medical Education.**
- J. D. B.** JAMES DAVID BOURCHIER, M.A., F.R.G.S.
King's College, Cambridge. Correspondent of *The Times* in South-Eastern Europe. Commander of the Orders of Prince Danilo of Montenegro and of the Saviour of Greece, and Officer of the Order of St Alexander of Bulgaria. } **Montenegro.**
- J. E. H.** REV. JOSEPH EDMUND HUTTON, M.A.
Author of *History of the Moravian Church*. } **Moravian Brethren.**
- J. F. K.** JAMES FURMAN KEMP, D.Sc.
Professor of Geology, Columbia University, New York. Geologist to United States and New York Geological Surveys. Author of *Handbook of Rocks*; &c. } **Mineral Deposits.**
- J. F. P.** JOSEPH FRANK PAYNE, M.A., M.D., F.R.C.P. (1840-1910).
Formerly Harveian Librarian, Royal College of Physicians, London. Hon. Fellow of Magdalen College, Oxford. Fellow of the University of London. Author of *Lectures on Anglo-Saxon Medicine*; &c. } **Medicine: History (in part).**
- J. G. H.** JOSEPH G. HORNER, A.M.I.MECH.E.
Author of *Plating and Boiler Making*; *Practical Metal Turning*; &c. } **Metal-Work: Industrial.**
- J. G. R.** JOHN GEORGE ROBERTSON, M.A., Ph.D.
Professor of German at the University of London. Formerly Lecturer on the English Language, Strassburg University. Author of *History of German Literature*; &c. } **Meistersinger.**
- J. G. Sc.** SIR JAMES GEORGE SCOTT, K.C.I.E.
Superintendent and Political Officer, Southern Shan States. Author of *Burma*; *The Upper Burma Gazetteer*. } **Mekong; Minbu.**
- J. H. F.** JOHN HENRY FREESE, M.A.
Formerly Fellow of St John's College, Cambridge. } **Menander;
Mirror: Ancient;
Moesia.**
- J. H. Je.** JAMES HOPWOOD JEANS, M.A., F.R.S.
Stokes Lecturer in the University of Cambridge. Formerly Fellow of Trinity College. Author of *Mathematical Theory of Electricity and Magnetism*; &c. } **Molecule.**
- J. H. M.** JOHN HENRY MIDDLETON, M.A., Litt.D., F.S.A., D.C.L. (1846-1896).
Slade Professor of Fine Art in the University of Cambridge, 1886-1895. Director of the Fitzwilliam Museum, Cambridge, 1889-1892. Art Director of the South Kensington Museum, 1892-1896. Author of *The Engraved Gems of Classical Times*; *Illuminated Manuscripts in Classical and Mediaeval Times*. } **Metal-Work: Art
(in part);
Monreale;
Mosaic: Ancient (in part).**
- J. H. R.** JOHN HORACE ROUND, M.A., LL.D.
Author of *Feudal England*; *Studies in Peerage and Family History*; *Peerage and Pedigree*. } **Mortain;
Mowbray: Family.**
- J. Hl. R.** JOHN HOLLAND ROSE, M.A., Litt.D.
Lecturer on Modern History to the Cambridge University Local Lectures Syndicate. Author of *Life of Napoleon I.*; *Napoleonic Studies*; *The Development of the European Nations*; *The Life of Pitt*; &c. } **Mollien, Count;
Montholon, Marquis de.**
- J. Le.** REV. JAMES LEGGE, D.D.
See the biographical article, LEGGE, JAMES. } **Mencius.**
- J. L. W.** JESSIE LAIDLAY WESTON.
Author of *Arthurian Romances unrepresented in Malory*. } **Merlin.**
- J. M. Bu.** REV. JAMES MONROE BUCKLEY, D.D., LL.D.
Editor of the *Christian Advocate*, New York. Author of *History of Methodism in the United States*; &c. } **Methodism: United States.**
- J. M. M.** JOHN MALCOLM MITCHELL.
Sometime Scholar of Queen's College, Oxford. Lecturer in Classics, East London College (University of London). Joint-editor of Grote's *History of Greece*. } **Mill, John Stuart
(in part);
Miltiades; Mnemonics.**
- Jno. S.** SIR JOHN SCOTT, K.C.M.G., M.A., D.C.L.
Formerly Deputy Judge-Advocate-General to His Majesty's Forces. Judge, afterwards Vice-President, International Court of Appeal in Egypt. 1874-1882; Judge of High Court, Bombay, 1882-1890. Judicial Adviser to the Khedive of Egypt, 1890-1898. Vice-President, International Law Association. } **Military Law.**

- J. S. Bl.** JOHN SUTHERLAND BLACK, M.A., LL.D.
Assistant Editor, 9th edition, *Encyclopaedia Britannica*. Joint-editor of the
Encyclopaedia Biblica. { **Missal**.
- J. S. F.** JOHN SMITH FLETT, D.Sc., F.G.S.
Petrographer to the Geological Survey. Formerly Lecturer on Petrology in
Edinburgh University. Neill Medallist of the Royal Society of Edinburgh. Bigsby
Medallist of the Geological Society of London. { **Metamorphism;**
Metasomatism;
Mica-Schist;
Mieropegmatite;
Monzonite.
- J. S. G.** JOHN STARKIE GARDNER, F.S.A.
Expert Metal Worker. Author of *Armour in England; Ironwork* (for the Educational
Department); &c. { **Metal-Work: Modern Art**.
- J. S. Ma.** JAMES SAUMAREZ MANN, M.A.
Formerly Fellow and Lecturer of Trinity College, Oxford. Professor of Greek at
Bedford College, London. Joint-editor of *Social England*. { **Mexico: Modern History**.
- J. T. Be.** JOHN THOMAS BEALBY.
Joint-author of *Stanford's Europe*. Formerly Editor of the *Scottish Geographical*
Magazine. Translator of Sven Hedin's *Through Asia, Central Asia and Tibet*; &c. { **Merv; Minsk (in part);**
Moscow (in part).
- J. T. C.** JOSEPH THOMAS CUNNINGHAM, M.A., F.Z.S.
Lecturer on Zoology at the South-Western Polytechnic, London. Formerly Fellow
of University College, Oxford. Assistant Professor of Natural History in the
University of Edinburgh. Naturalist to the Marine Biological Association. { **Mollusca (in part);**
Mullet.
- J. T. S.*** JAMES THOMSON SHOTWELL, PH.D.
Professor of History in Columbia University, New York City. { **Middle Ages**.
- K. A. M.*** KATE A. MEAKIN (Mrs Budgett Meakin). { **Morocco (in part)**.
- K. S.** KATHLEEN SCHLESINGER.
Editor of the *Portfolio of Musical Archaeology*. Author of *The Instruments of the*
Orchestra. { **Monochord; Mouthpiece**.
- L. Bl.** LOUIS BELL, PH.D.
Consulting Engineer, Boston, U.S.A. Chief Engineer, Electric Power Transmission
Department, General Electric Co., Boston. Formerly Editor of *Electrical World*,
New York. Author of *Electric Power Transmission*; &c. { **Motors, Electric**.
- L. Bo.** LUDWIG BOLZMANN (1844-1906).
Formerly Professor of Theoretical Physics, Universities of Munich, Vienna and
Leipzig. Author of *Lectures on the Theory of Gas; Lectures on Maxwell's Theory*
of Electricity and Light. { **Model**.
- L. F.** LAZARUS FLETCHER, M.A., F.R.S.
Director of Natural History Departments of the British Museum. Keeper of
Minerals, British Museum, 1880-1909. Secretary to the Mineralogical Society.
Formerly Fellow of University College, Oxford. Author of *Introduction to the Study*
of Meteorites; &c. { **Meteorite**.
- L. J. S.** LEONARD JAMES SPENCER, M.A.
Assistant in Department of Mineralogy, British Museum. Formerly Scholar of
Sidney Sussex College, Cambridge, and Harkness Scholar. Editor of the *Mineral-
ogical Magazine*. { **Melaconite; Mica;**
Microlinite; Millerite;
Mimetite; Mineralogy;
Mispickel; Molybdenite;
Monazite.
- M. H. C.** MONTAGUE HUGHES CRACKANTHORPE, M.A., D.C.L., K.C.
Honorary Fellow, St John's College, Oxford. Bencher of Lincoln's Inn. Formerly
Member of the General Council of the Bar and of the Council of Legal Education,
and Standing Counsel to the University of Oxford. President of the Eugenics
Education Society. { **Mediation**.
- M. H. S.** MARION H. SPIELMANN, F.S.A.
Formerly Editor of the *Magazine of Art*. Member of Fine Art Committee of
International Exhibitions of Brussels, Paris, Buenos Aires, Rome, and the Franco-
British Exhibition, London. Author of *History of "Punch"*; *British Portrait*
Painting to the opening of the Nineteenth Century; Works of G. F. Watts, R.A.; British
Sculpture and Sculptors of To-Day; Henriette Ronner; &c. { **Medal (in part)**.
- M. N. T.** MARCUS NIEBUHR TOD, M.A.
Fellow and Tutor of Oriel College, Oxford. University Lecturer in Epigraphy.
Joint-author of *Catalogue of the Sparta Museum*. { **Messene; Messenia**.
- M. O. B. C.** MAXIMILIAN OTTO BISMARCK CASPARI, M.A.
Reader in Ancient History at London University. Lecturer in Greek at Birming-
ham University, 1905-1908. { **Megara (in part)**.
- M. P.** REV. MARK PATTISON.
See the biographical article, PATTISON, MARK. { **More, Sir Thomas**.
- N. W. T.** NORTHCOTE WHITRIDGE THOMAS, M.A.
Government Anthropologist to Southern Nigeria. Corresponding Member of the
Société d'Anthropologie de Paris. Author of *Thought Transference; Kinship and*
Marriage in Australia; &c. { **Medium**.
- O. Ba.** OSWALD BARRON, F.S.A.
Editor of *The Ancestor*, 1902-1905. Hon. Genealogist to Standing Council of the
Honourable Society of the Baronetage. { **Montagu (Family).**
Mortimer (Family).
- O. C. W.** OWEN CHARLES WHITEHOUSE, M.A., D.D.
Theological Tutor and Lecturer in Hebrew, Cheshunt College, Cambridge. { **Messiah (in part)**.

- O. Hr. OTTO HENKER, PH.D.
On the Staff of the Carl Zeiss Factory, Jena, Germany. { Microscope.
- P. A. K. PRINCE PETER ALEXEIVITCH KROPOTKIN.
See the biographical article, KROPOTKIN, PRINCE P. A. { Minsk (in part);
Mongolia; Moscow.
- P. C. M. PETER CHALMERS MITCHELL, M.A., F.R.S., F.Z.S., D.Sc., LL.D.
Secretary to the Zoological Society of London. University Demonstrator in
Comparative Anatomy and Assistant to Linacre Professor at Oxford, 1888-1891.
Author of *Outlines of Biology*; &c. { Monster (in part);
Morphology (in part).
- P. Ge. PATRICK GEDDES, F.R.S. (Edin.).
Professor of Botany, University College, Dundee. Formerly Lecturer on Natural
History in School of Medicine, Edinburgh. Part-author of *Evolution of Sex*.
Author of *Chapters in Modern Botany*. { Morphology (in part).
- P. G. K. PAUL GEORGE KONODY.
Art Critic of the *Observer* and the *Daily Mail*. Formerly Editor of *The Artist*.
Author of *The Art of Walter Crane*; *Velasquez, Life and Work*; &c. { Memline (in part).
- P. La. PHILIP LAKE, M.A., F.G.S.
Lecturer on Physical and Regional Geography in Cambridge University. Formerly
of the Geological Survey of India. Author of *Monograph of British Cambrian
Trilobites*. Translator and Editor of Keyser's *Comparative Geology*. { Mexico: Geology.
- P. V. PASQUALE VILLARI.
See the biographical article, VILLARI, PASQUALE. { Medici (Family).
- R. A. S. M. ROBERT ALEXANDER STEWART MACALISTER, M.A., F.S.A.
St John's College, Cambridge. Director of Excavations for the Palestine Explora-
tion Fund. { Michmash; Mizpah;
Moriah.
- R. C. P. REGINALD CRUNDALL PUNNETT, M.A.
Professor of Biology in the University of Cambridge. Fellow of Gonville and Caius
College. Superintendent of the Museum of Zoology. { Mendelism.
- R. H. C. REV. ROBERT HENRY CHARLES, M.A., D.D., D.Litt.
Grinfield Lecturer, and Lecturer in Biblical Studies, Oxford. Fellow of the British
Academy. Formerly Professor of Biblical Greek, Trinity College, Dublin. Author
of *Critical History of the Doctrine of a Future Life*; *Book of Jubilees*; &c. { Moses, Assumption of.
- R. I. P. REGINALD INNES POCKOCK, F.Z.S.
Superintendent of the Zoological Gardens, London. { Millipede; Mimicry;
Mite.
- R. K. D. SIR ROBERT KENWAY DOUGLAS.
Formerly Keeper of Oriental Printed Books and MSS. at the British Museum; and
Professor of Chinese, King's College, London. Author of *The Language and
Literature of China*; &c. { Mongols.
- R. L.* RICHARD LYDEKKER, M.A., F.R.S., F.G.S., F.Z.S.
Member of the Staff of the Geological Survey of India, 1874-1882. Author of
Catalogues of Fossil Mammals, Reptiles and Birds in British Museum; *The Deer of
All Lands*; *The Game Animals of Africa*; &c. { Megatherium; Mole (in
Monodelphia);
Monotremata; Mouse;
Multituberculata.
- R. M.-S. RICHMOND MAYO-SMITH, PH.D.
See the biographical article, MAYO-SMITH, RICHMOND. { Migration (in part).
- R. N. B. ROBERT NISBET BAIN (d. 1909).
Assistant Librarian, British Museum, 1883-1909. Author of *Scandinavia, the
Political History of Denmark, Norway and Sweden, 1513-1900*; *The First Romanovs,
1613-1725*; *Slavonic Europe, the Political History of Poland and Russia from 1469
to 1796*; &c. { Menshikov;
Michael, Tsar;
Moltke, Count A. G.;
Moltke, Count A. W.
- R. P. S. R. PHENÉ SPIERS, F.S.A., F.R.I.B.A.
Formerly Master of the Architectural School, Royal Academy, London. Past
President of Architectural Association. Associate and Fellow of King's College,
London. Corresponding Member of the Institute of France. Editor of *Fergusson's
History of Architecture*. Author of *Architecture: East and West*; &c. { Mosque; Mouldings.
- R. S. C. ROBERT SEYMOUR CONWAY, M.A., D.Litt. (Cantab.).
Professor of Latin and Indo-European Philology in the University of Manchester.
Formerly Professor of Latin in University College, Cardiff; and Fellow of Gonville
and Caius College, Cambridge. Author of *The Italic Dialects*. { Messapii.
- S. A. C. STANLEY ARTHUR COOK, M.A.
Lecturer in Hebrew and Syriac, and formerly Fellow, Gonville and Caius College,
Cambridge. Editor for the Palestine Exploration Fund. Examiner in Hebrew
and Aramaic, London University, 1904-1908. Council of Royal Asiatic Society,
1904-1908. Author of *Glossary of Aramaic Inscriptions: The Law of Moses and the
Code of Hammurabi*; *Critical Notes on Old Testament History*; *Religion of Ancient
Palestine*; &c. { Melchizedek (in part);
Menahem; Midrash;
Mizraim; Moab;
Moloch (in part);
Moses.
- Š. C. SIDNEY COLVIN, LL.D.
See the biographical article, COLVIN, SIDNEY. { Michelangelo.
- ŠI. C. VISCOUNT ST. CYRES.
See the biographical article, IDDESLEIGH, 1ST EARL OF. { Molinos.
- S. N. SIMON NEWCOMB, D.Sc., LL.D.
See the biographical article, NEWCOMB, SIMON. { Mercury; Moon.

f. As.	THOMAS ASHBY, M.A., D.LITT. (Oxon). Director of British School of Archaeology at Rome. Formerly Scholar of Christ Church, Oxford. Craven Fellow, 1897. Conington Prizeman, 1906. Member of the Imperial German Archaeological Institute. Author of <i>The Classical Topography of the Roman Campagna</i> .	Mediolanum; Megara Hyblaea; Messina; Metapontum; Milan (in part); Minturnae; Misenum; Monteale (in part); Monteleone Calabro; Motya; Monument: Italy. Medical Jurisprudence (in part); Midwife; Migration (in part).
T. A. I.	THOMAS ALLAN INGRAM, M.A., LL.D. Trinity College, Dublin.	
T. Ca.	THOMAS CASE, M.A. President of Corpus Christi College, Oxford. Formerly Waynflete Professor of Moral and Metaphysical Philosophy in the University of Oxford, and Fellow of Magdalen College.	Metaphysics.
T. C. A.	SIR THOMAS CLIFFORD ALBUTT, K.C.B., M.A., M.D., D.Sc., LL.D., F.R.S. Regius Professor of Physic in the University of Cambridge. Physician to Addenbrooke's Hospital, Cambridge. Fellow of Gonville and Caius College, Cambridge. Editor of <i>Systems of Medicine</i> .	Medicine: Modern Progress.
T. H. H.*	COLONEL SIR THOMAS HUNGERFORD HOLDICH, K.C.M.G., K.C.I.E., D.Sc. Superintendent Frontier Surveys, India, 1892-1898, Gold Medallist, R.G.S. (London), 1887. Author of <i>The Indian Borderland; The Countries of the King's Award; India; Tibet; &c.</i>	Mohmand.
T. K. R.	THOMAS KIRKE ROSE, D.Sc. Chemist and Assayer, The Royal Mint, London. Author of <i>Metallurgy of Gold; The Precious Metals; &c.</i>	Mint.
Th. N.	THEODOR NÖLDEKE, PH.D. See the biographical article, NÖLDEKE, THEODOR.	Mo'allakat.
T. S. W.	THEODORE SALISBURY WOOLSEY, LL.D. Professor of International Law, Yale University. Editor of <i>Woolsey's International Law</i> . Author of <i>America's Foreign Policy; &c.</i>	Monroe Doctrine.
T. W. R. D.	THOMAS WILLIAM REYS DAVIDS, LL.D., PH.D. Professor of Comparative Religion, Manchester University. President of the Pali Text Society. Fellow of the British Academy. Secretary and Librarian of Royal Asiatic Society, 1885-1902. Author of <i>Buddhism; Sacred Books of the Buddhists; Early Buddhism; Buddhist India; Dialogues of the Buddhas; &c.</i>	Medhankara; Menander (Milinda).
W. A. B. C.	REV. WILLIAM AUGUSTUS BREVOORT COOLIDGE, M.A., F.R.G.S., PH.D. (Bern). Fellow of Magdalen College, Oxford. Professor of English History, St David's College, Lampeter, 1880-1881. Author of <i>Guide du Haut Dauphiné; The Range of the Tödi; Guide to Grindelwald; Guide to Switzerland; The Alps in Nature and in History; &c.</i> Editor of <i>The Alpine Journal</i> , 1880-1881; &c.	Melringen; Meran; Merian; Mont Cenis; Morat; Müller, Johannes von.
W. A. P.	WALTER ALISON PHILLIPS, M.A. Formerly Exhibitioner of Merton College and Senior Scholar of St John's College, Oxford. Author of <i>Modern Europe; &c.</i>	Mehemet All; Mephistopheles; Metternich; Minister; Mitre.
W. B. RI.	SIR WILLIAM BLAKE RICHMOND, K.C.B. See the biographical article, RICHMOND, SIR WILLIAM BLAKE.	Mosaic: Modern.
W. B. S.*	WILLIAM BARCLAY SQUIRE, M.A. Assistant in Charge of Printed Music, British Museum.	Morley, Thomas.
W. C. R.-A.	SIR WILLIAM CHANDLER ROBERTS-AUSTEN, K.C.B., D.C.L., F.R.S. See the biographical article, ROBERTS-AUSTEN, SIR W. C.	Metallography (in part).
W. F. C.	WILLIAM FELDEN CRAIES, M.A. Barrister-at-Law, Inner Temple. Lecturer on Criminal Law, King's College, London. Editor of Archbold's <i>Criminal Pleading</i> (23rd edition).	Misdemeanour.
W. F. D.	WILLIAM FREDERICK DENNING, F.R.A.S. Gold Medallist, R.A.S. President, Liverpool Astronomical Society, 1877-1878. Author of <i>Telescopic Work for Starlight Evenings; The Great Meteoric Shower; &c.</i>	Meteor.
W. F. Sh.	WILLIAM FLEETWOOD SHEPPARD, M.A. Senior Examiner in the Board of Education. Formerly Fellow of Trinity College, Cambridge. Senior Wrangler, 1884.	Mensuration.
W. H. F.	SIR WILLIAM HENRY FLOWER, F.R.S. See the biographical article, FLOWER, SIR W. H.	Mink.
W. H. H.	WILLIAM HENRY HOWELL, M.D., PH.D., LL.D. Dean of the Medical Faculty and Professor of Physiology, Johns Hopkins University, Baltimore. President of the American Physiological Association. Associate-editor of <i>American Journal of Physiology</i> .	Medical Education, U.S.A (in part).
W. H. M.	WILLIAM HERRICK MACAULAY, M.A. Fellow and Tutor of King's College, Cambridge.	Motion, Laws of.
W. L.*	WALTER LEHMANN, D.M. Directorial Assistant, Royal Ethnographical Museum, Munich. Author of <i>Methods and Results in Mexican Research; &c.</i>	Mexico: Ancient History (in part).

INITIALS AND HEADINGS OF ARTICLES

W. M.	WILLIAM MINTO, LL.D. See the biographical article, MINTO, WILLIAM.	{ Mill, John Stuart (<i>in part</i>).
W. M. C.	SIR W. MARTIN CONWAY. See the biographical article, CONWAY, SIR W. M.	{ Mountaineering.
W. M. R.	WILLIAM MICHAEL ROSSETTI. See the biographical article, ROSSETTI, DANTE, G.	{ Moroni.
W. P. A.	LIEUT.-COLONEL WILLIAM PATRICK ANDERSON, M.INST.C.E., F.R.G.S. Chief Engineer, Department of Marine and Fisheries of Canada. Member of the Geographic Board of Canada. Past President of Canadian Society of Civil Engineers.	{ Michigan, Lake.
W. R. M.	WILLIAM RICHARD MORFILL, M.A. (d. 1910). Formerly Professor of Russian and the other Slavonic Languages in the University of Oxford. Curator of the Taylorian Institution Oxford. Author of <i>Russia; Slavonic Literature</i> ; &c.	{ Mickiewicz, Adam.
W. R. S.	WILLIAM ROBERTSON SMITH, LL.D. See the biographical article, SMITH, WILLIAM ROBERTSON.	{ Medina; Melchizedek (<i>in part</i>); Messiah (<i>in part</i>); Micah (<i>in part</i>); Moloch (<i>in part</i>).
W. R. S.*	WILLIAM ROY SMITH, M.A., PH.D. Associate Professor of History, Bryn Mawr College, Pennsylvania. Author of <i>Sectionalism in Pennsylvania during the Revolution</i> ; &c.	{ Missouri Compromise.
W. S. R.	WILLIAM SMYTH ROCKSTRO. Author of <i>A General History of Music from the Infancy of the Greek Drama to the Present Period</i> ; and other works on the history of music.	{ Mendelssohn-Bartholdy (<i>in part</i>); Mozart (<i>in part</i>).

PRINCIPAL UNSIGNED ARTICLES

Melbourne.
Melon.
Meningitis.
Mercantile System.
Mercury (Chemistry).
Mermaids.
Metal.
Metallurgy.

Michigan.
Micronesia.
Militia.
Milk.
Mineral Waters.
Ministry.
Minnesingers.

Minnesota.
Mississippi.
Mississippi River.
Missouri.
Monaco.
Monmouthshire.
Monopoly.

Montana.
Moors.
Moravia.
Mormons.
Morphine.
Mortgage.
Mounted Infantry.

ENCYCLOPÆDIA BRITANNICA

ELEVENTH EDITION

VOLUME XVIII

MEDAL (Fr. *médaille*, from Lat. *metallum*), strictly the term given to a memorial piece, originally of metal, and generally in the shape of a coin, used however not as currency but as an artistic product. "Medallion" is a similar term for a large medal, but is now usually restricted to a form of bas-relief in sculpture. The term "medal" is, artistically, extended by analogy to pieces of the same character not necessarily shaped like coins. The history of coins and medals is inseparable, and is treated under the general heading of NUMISMATICS. That article may be supplemented here by an account of (1) the more recent progress in the art of the medallist, and (2) the use of medals for war decorations.

1. The medal—as it is understood to-day—enjoys a life entirely independent of the coin on the one hand, and, on the other, of the sculptured medallion, or bas-relief; and its renaissance is one of the chief phenomena in art during the period since about 1870. It is in France that it has risen to the greatest perfection. Its popularity there is well-nigh universal; it is esteemed not only for memorials of popular events and of public men, but also for private celebrations of all kinds. No other nation approaches in excellence—in artistic feeling, treatment, and sensitiveness of execution—the artists and the achievements of France. In England, although the Royal Academy seeks to encourage its students to practise the art, the prize it offers commonly induces no competition. The art of the medallist is not properly appreciated or understood, and receives little or no support. The prevailing notion concerning it is that it consists in stamping cheap tokens out of white metal or bronze, on which a design, more or less vulgar, stands out in frosty relief from a dazzling, glittering background. These works, even the majority of military and civic medals, demonstrate how the exquisite art of the Renaissance had been degraded in England—almost without protest or even recognition—so that they are, to a work of Rötty or Chaplain, what a nameless daub would be to a picture by Rembrandt or Velasquez.

It is probable that Jacques Wiener (d. 1899), of Belgium, was the last of the medallists of note who habitually cut his steel dies entirely with his own hand without assistance, though others in some measure do so still. Although most modern workers, exclusively medallists, have themselves cut dies, they now take advantage of the newest methods; and the *graveur en médailles* has become simply a *médailleur*. His knowledge of effects is the same—though the effect sought is different: in earlier times the artist thought chiefly of his *shadownes*; now he mainly regards his *planes*. Otherwise his aims are not dissimilar. At the present day the medallist, after making conscientious studies from life (as if he were about to paint a picture), commonly works out his design in wax, or similar substance, on a disk of plaster about 12 or 14 inches

in diameter. From that advanced model a simple mould, or matrix, is made, and a plaster cast is taken, whereupon the artist can complete his work in the utmost perfection. Then, if a struck medal is required, a steel cast is made, and from that a reduction to the size required for the final work is produced by means of the machine—the *tour à réduire*. It is this machine which has made possible the modern revival, and has revolutionized the taste of designers and public alike. It was invented by Contamin, who based it upon that *tour à portrait* which Houlot produced in 1766, and which helped to fame several engravers now celebrated. This machine was first exhibited in Paris in 1839, and was sold to the Munich Mint; while a similar invention, devised at the same time by the English engraver Hill, was acquired by Wyon for £2000, and was ultimately disposed of to a private mint in Paris. From that city comes the machine, based by the French inventor M. Ledru upon the two already referred to, now in use at the Royal Mint in London. A well-served medallist, therefore, need trouble himself nowadays about little beyond the primary modelling and the final result, correcting with his own hand only the slightest touches—refining, perfecting—but sometimes merely confining himself to giving his directions to the professional engraver.¹

The great majority of the artistic medals at present in the world (in the great collection of France there is a total of not fewer than 200,000 medals) are cast, not struck. There is in them a charm of surface, of patina, of the metal itself, which the struck medal, with all the added beauties which it allows of delicate finish and exquisite detail, can hardly give. But the production of the cast medal is much slower, much more uncertain, and the number of fine copies that can be produced is infinitely smaller. All the early medals were cast, being first modelled in wax, and then cast by the *cire perdue* (waste wax)

¹ The method of preparing the dies, &c., is the same for medals as for coins, save that for larger and heavier work more strokes are required, as in the case of L. Coudray's popular "Orphée"—rather a sculpture-relief than a medal. The dies are capable of a great yield before becoming quite worn-out; it is said that no fewer than three million copies were struck of Professor J. Tautenhayn's Austrian jubilee medal of the Emperor Francis Joseph. In France, Thonellier's perfected machine, substituting the lever for the screw, has been in use for coins since 1844; but for the striking of medals the same old-fashioned screw-press is retained which had till then been employed both for coins and medals since the time of Louis XIV. In its present form the machine consists of an iron or bronze frame, of which the upper part is fitted with a hollow screw wherein works an inner screw. This screw, moved by steam or electricity, drives the dies, set in iron collars, so that they strike the blank placed between them. This machine can deliver a strong blow to produce a high relief, or a delicate touch to add the finest finish. In the Paris Mint large medals can be struck with comparative ease and rapidity. A hydraulic press of nearly two million pounds pressure is utilized for testing the dies

process, and were usually worked over by the chaser afterwards; indeed, it was not until the beginning of the 16th century that dies, hitherto used only for coins executed in low relief, were employed for larger and bolder work. The medallists of those days always cast in bronze or lead, and only proceeded to use silver and gold as a luxurious taste began to demand the more precious metals. There is little doubt that the material to be preferred is dull silver (*mat* or *sablé*—sand-blasted), as the work, with all its variations of light and shade, can be better seen in the delicate grey of the surface.

The medal, properly considered, is not sculpture. Vasari was happy in his definition when he described the medallist art as the link between sculpture and painting—that is to say, painting in the round with the colour left out. Less severe than sculpture, it need not be less dignified; it is bound down by the conventions of low relief, and by compulsions of composition and design, dependent on shape, from which sculpture, even when the relief is the lowest, is in a great measure free. In the medal, otherwise than in sculpture, elaborate perspective and receding planes are not out of place. The genius of the modern Frenchman rebelled against the rule that commonly governed the medal during the decadence, and has triumphed in his revolt, justifying the practice by his success. The modern medal and the *plaque* aim at being decorative yet vigorous, reticent and dignified, delicate and tender, graceful and pure; it may be, and often is, all these in turn. Imagination, fancy, symbolism, may always be brought into play, allied to a sense of form and colour, of arrangement and execution. By the demonstration of these qualities the artist is to be differentiated from the skillful, mechanical die-sinker, who spreads over the art the blight of his heavy and insensitive hand and brain. So with portraiture. Accurate likeness of feature as well as character and expression are now to be found in all fine works, such as are seized only by an artist of keenly sensitive temperament. It is thus that he casts the events and the actions of to-day into metallic history, beautifully seen and exquisitely recorded; thus that the figure on the medal is no longer a mere sculpturesque symbol, but a thing of flesh and blood, suave and graceful in composition, and as pleasing in its purely decorative design as imagination can inspire or example suggest. It is thus that the art, while offering easy means of permanent memorial, has afforded to men of restricted means the eagerly seized opportunity of forming small collections of masterpieces of art at a small outlay.

France.—In France the example of Oudiné, coming after that of David d'Angers, did much to revolutionize the spirit animating the modern medallist, but Chapu, by his essentially modern treatment, did more. To Ponscarne (pupil of Oudiné) is chiefly due the idea of rendering *mat* the ground as well as the subject on the medal, the suppression of the raised rim, and the abandonment of the typographic lettering hitherto in vogue, together with the mechanical regularity of its arrangement. Degeorge, with his semi-pictorial treatment, was followed by Daniel Dupuy, whose delicate and playful fancy, almost entirely pictorial, makes us forget alike the material and the die. J. C. Chaplain is unsurpassed as a modeller of noble heads, including those of four presidents of the French Republic—Macmahon, Casimir-Perier, Faure and Loubet—and his allegorical designs are finely imagined and admirably worked out (see Plate); but L. Oscar Roty (pupil of Ponscarne) is at the head of the whole modern school, not only by virtue of absolute mastery of the technique of his art, but also of his originality of arrangement, of the poetic charm of his symbolism and his allegories, the delicate fancy, the exquisite touch, the chasteness and purity of taste—wedding a modern sentiment to an obvious feeling for the Greek. Though expressly less virile than Chaplain, Roty is never effeminate. To Roty belongs the credit of having first revived the form of the *plaque*, or rectangular medal, which had been abandoned and forgotten along with many other traditions of the Renaissance (see Plate). Alphonse Dubois, Lagrange, and Borrel must be mentioned among those who are understood to engrave their own dies. Followers are to be found in Mouchon, Lechever, Vernon, Henri Dubois, Fately, Bouteé (see Plate)—all sterling artists if not innovators. Medallists of more striking originality but less finish, and of far less elegance are Michel Cazin, Levillain who loves as much as Bandinelli to make over-display of his knowledge of muscular anatomy), Charpentier, and their school, who aim at a manner which makes less demand of highly educated artistry such as that of Roty or of Chaplain. It is learned and accomplished in

its way, but lumpy in its result; breadth is gained, but refinement and distinction are in a great measure lost. It may be added—to give some idea of the industry of the modern medallist, and the encouragement accorded to him—that between 1879 and 1900 M. Roty executed more than 150 pieces, each having an obverse and a reverse.

Austria.—The two leading medallists of the Austrian school are Josef Tautenhay (see Plate) and Anton Scharif, both highly accomplished, yet neither displaying the highest qualities of taste, ability and "keeping," which distinguishes the French masters. About 330 pieces have come from the hand of Anton Scharif, Stefan Schwartz, Franz Pawlik, Staniek, Marschall and J. Tautenhay, junior, are the only other artists who have risen to eminence.

Germany.—A characteristically florid style is here cultivated, such as lends itself to the elaborate treatment of costume, armorial bearings, and the like; but delicacy, distinction, and the highest excellence in modelling and draughtsmanship—qualities which should accompany even the most vigorous or elaborate designs—are lacking in a great degree. Professors Hildebrand and Kowarski have wrought some of the most artistic works there produced.

Belgium.—Although sculpture so greatly flourishes in Belgium, medal work shows little promise of rivaling that of France. The influence of the three brothers Wiener (Jacques, Léopold and Charles)—good medallists of the old school—has not yet been shaken off. The remarkable architectural series by the first-named, and the coinage of the second, have little affinity with the spirit of the modern medal. Lemaire has perhaps done as well as any, followed by Paul Dubois, J. Dens (a follower of the French), G. Decees and Vinckeles (see Plate)—whose *plaque* for the Brussels Exhibition award (1887) is original, but more admirable in design than in finish.

Holland.—In Holland not very much has been done. Patriotism has called forth many medals of Queen Wilhelmina, and the best of them are doubtless those of Bart van Hove and Wortman. Baars is a more virile artist, who follows Chaplain at a distance. Wiencke is interesting for the sake of his early Netherlandic manner; the incongruity is not unpleasant.

Switzerland.—The medal is also popular in Switzerland. Here Bovy is the leader of the French tradition and Hans Frei of a more national school; the latter medalist, is more remarkable as a revivalist than as an original artist.

Great Britain.—In England only two medallists of repute can be counted who practically confine themselves to their art—G. W. de Saulles, of the Royal Mint, best known by the Diamond Jubilee medal of Queen Victoria and by his medal of Sir Gabriel Stokes, and Frank Bowcher (see Plate) by that of Thomas Huxley. These artists both cut their own dies when necessary. Emil Fuchs, working in England in the manner of the French medallists, but with greater freedom than is the wont of the older school, has produced several examples of the art; the medals commemorative of the South African War and of Queen Victoria (two versions), all of 1900; and many portrait medals and *plaquettes* of small size have come from the same hand. Besides these, the leading English sculptors have produced medals—Lord Leighton, Sir Edward Poynter, Hamo Thornycroft, T. Brock, Onslow Ford, G. Frampton and Goscombe John; but, practising more continually in sculpture, they do not claim rank as medallists, nor have they sought to acquire that class of dexterity which constant habit alone can give. Alphonse Legros, who has cast a certain number of portrait medals, is usually included in the French school.

United States.—Among American medallists Augustus St Gaudens (see Plate) is perhaps the most prominent; but he is not, strictly speaking, a medallist, but a sculptor who can model in the flat.

AUTHORITIES.—F. Parkes Weber, *Medals and Medallions of the 19th Century relating to England by Foreign Artists* (London, 1894); Roger Marx, "The Renaissance of the Medal in France," *The Studio* (vol. xv, 1898); M. H. Spielmann, "Frank Bowcher, Medallist, with some Comment on the Medallist Art," *The Magazine of Art* (February 1900); *Spink & Son's Monthly Numismatic Circular* (*passim*), 1892 onwards (in English, French and German); Roger Marx, *Les Médailleurs français depuis 1793* (Paris, 1897); *Les Médailleurs français contemporains* (Plates) (Paris, 1899); *Le Monnaie de Paris à l'Exposition Universelle* (Paris, 1900); *Cent ans de numismatique française* (2 vols., 1893-1895); F. Mazzerolle, L. O. Roty: *Biographie et catalogue de son œuvre* (Paris, 1897); J. F. Choplain: *Biographie et catalogue de l'œuvre* (Paris, 1897); Dr H. J. de Dompère de Chaupeüi, *Les Médailles et médailles modernes* (in Dutch and French) (Haarlem, 1897); A. R. v. Locher, *Wiener Medallieur, 1809*. (Vienna, 1899); A. Lichtwar, "Die Wiedererweckung der Medaille," *Wart*, 1895, pp. 34-40; 1896, pp. 31-18; *Die Modern Medal*, in *The Numismatic Magazine* (London, 1896); L. Forrer, *Biographical Dictionary of Medallists*, vol. I. A-D. (London, 1902).

(M. H. S.)

MEDALS AS WAR DECORATIONS

Although the striking of medals to commemorate important events is a practice of considerable antiquity, yet the custom of using the medal as a decoration, and especially as a decoration to do honour to those who have rendered service to the state

MEDAL



DUPLESSIS PLAQUETTE.
Roty.



STUDY.
Roty.



BOULANGER PLAQUETTE.
Roty.



MAURICE ALBERT
PORTRAIT.
Roty.



WEDDING MEDAL.
Roty.



AMBROISINE MERLIN
From the Medal by
MICHEL CAZIN.

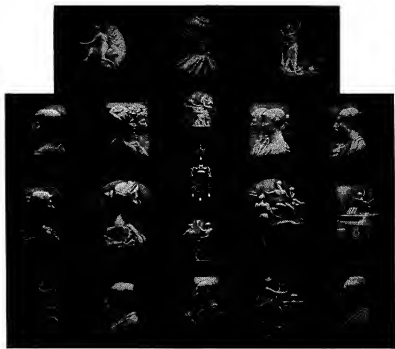

MEDALS AND PLAQUETTES.
JULES CHAPLAIN.



HENRI DUBOIS.



MEDAL OF AWARD FOR THE COPE
AND NICOL SCHOOL OF PAINTING.
F. BOWCHER.



FRANCE, 1870.
ROTY.



GREAT GOLD MEDAL, BRUSSELS, 1898.
Designed by P. WOLFERS. Engraved by VINCOTTE.



GOLD MEDAL, VIENNA
1894.
By JOSEPH TAUTENHAYN.



PARIS UNIVERSAL EXHIBITION, 1889.
By LOUIS BOTTÉ.



INTERNATIONAL EXHIBITION, CHICAGO, 1893.
By AUGUSTUS ST GAUDENS.

in time of war, is comparatively modern. It has been supposed that the circular ornaments on the Roman standards had medals in their centres, but there is no evidence to show that this was the case, and the standards shown on the column of Trajan appear only to have had plain bosses in their centres. It is true that the Chinese are said to have used military medals during the Han dynasty (1st century A.D.), but, as far as the West is concerned, we have to come to the 16th century before we find the custom of wearing medals as decorations of honour a recognized institution.

The wearing of decorative medals was common in England in the reign of Henry VIII., but the first medals commemorating a particular event that were evidently intended as a personal decoration, and were in all probability (though there is no absolute proof) bestowed as reward for military services rendered to the Crown, are the "Armada" medals of Queen Elizabeth, 1588-1589. Of these there are two. The earliest, generally styled the "Ark in flood" medal, is a large oval medal of silver (2 by 1.75 in.), and bears on the obverse a profile bust of the queen surrounded by the inscription, ELIZABETH D. G. ANGLIÆ. F. ET HI. REG. On the reverse is an ark on waves, with above the rays of the sun, and around the legend, SÆVAS TRANQVILLA PER VNDA. This medal dates from 1588, and in the following year there was given another medal, a little larger (2.3 by 2.1 in.) and struck in gold, silver and copper. The obverse of this second medal bore a full-face bust of Elizabeth, with the legend, characteristic both of the monarch and the period, DITIOR IN TOTO NON ALTER CIRCULUS ORBE. The reverse has an island around which ships are sailing and sea-monsters swimming, and on the island there are houses, a flourishing bay-tree, standing uninjured by a storm of wind, and lightning emerging from heavy clouds above. The island is inscribed NON IPSEA PERICVLA TANGVNT. These medals are of special interest as demonstrating thus early the existence of a doctrine of sea-power. In fact, in the medals of James I. (1603-1625), none of which have a distinct reference to war services, the "ark in flood" design was again reproduced on the reverse, this time with the legend slightly altered, viz. STET SALVVS IN VNDIS.

Other European nationalities were also about this period conferring decorative medals as a reward for war services, as for example, the "Medal to Volunteers" issued in Holland in 1622-1623 and the "Military Medal of Gustavus Adolphus" issued in Sweden in 1630. Here it may be noted that in following the history of medals as used as a decoration to reward military services, only those of British origin need be dealt with in detail, since Great Britain has utilized them in a much greater degree than any other nationality. The countless minor wars of the 19th century, waged by the forces of the Crown of every class, navy, army and auxiliary, have no equivalent in the history of other states, even in that of France, the United States and Russia. The great wars of the 19th century were divided by long intervals of peace, and the result is that with most of the great military powers the issue of campaign medals has been on a small scale, and in the main decorations have taken the form of "Orders" (see KNIGHTHOOD AND CHIVALRY: Orders), or purely personal decorations for some meritorious or exemplary service.

During the reign of Charles I. (1625-1649), we come across numerous medals and badges; a considerable number of these were undoubtedly associated with, and given, even systematically given, as rewards for war services; for a royal warrant "given at our Court of Oxford, the eighteenth day of May, 1643," which directed "Sir William Parkhurst, Knight, and Thomas Bushell, Esquire, Wardens of our Mint, to provide from time to time certain Badges of silver, containing our Royal image, and that of our dearest son, Prince Charles, to be delivered to wear on the breast of every man who shall be certified under the hands of their Commanders-in-Chief to have done us faithful service in the Forlorn-hope."

From the foregoing it must not be deduced that this medal

was in any way intended to reward special valour. In those days "forlorn-hopes" were not volunteers for some desperate enterprise, as to-day, but a tactical advanced guard which naturally varied, both in numbers and arm of the service, according to ground and circumstances. That a very free distribution of the award was contemplated is evident from the fact that "soldiers" alone were specified as recipients and that a clause was inserted in the warrant strictly forbidding the sale of the medal. This letter ran:—

"And we do, therefore, most straitly command, that no soldier at any time do sell, nor any of our subjects presume to buy, or wear, any of these said Badges, other than they to whom we shall give the same, and that under such pain and punishment as our Council of War shall think fit to inflict, if any shall presume to offend against this our Royal command."

As there are in existence several medals of this period which bear the effigies of both the king and Prince Charles, it is uncertain which in particular was used for the "forlorn-hope" award. Very probably it is one, an oval silver-gilt medal (1.7 by 1.3 in.) which bears on the obverse a three-quarters (r.) bust of Charles I., and on the reverse a profile (l.) bust of Prince Charles (see Mayo, *Medals and Decorations of the British Army and Navy*, vol. 1. No. 16, Plate 5, No. 3). During the Commonwealth (1649-1660), parliament was lavish in the award of medals in recognition of war services, and for the first time we find statutory provision made for their bestowal as naval awards, in the shape of acts of parliament passed Feb. 22, 1648 and April 7, 1649 (cap. 12, 1648 and cap. 21, 1649), and Orders in Council of May 8 and Nov. 19 and 21, 1649, and Dec. 20, 1652. There is no doubt whatever that there was a "Medal of the Parliament" for sea service issued in 1649. This medal, oval (.95 by .85 in.) and struck in gold and silver, had on the obverse an anchor, from the stock of which are suspended two shields, one bearing the cross of St. George, and the other the Irish harp. The motto is MERVISTI. On the anchor stock, T. S.¹ The reverse has on it the House of Commons with the Speaker in the chair. This medal is referred to in a minute of the Council of State of Nov. 15, 1649:—

"(5) That the Formes of the medalls which are now brought in to be given to the severall Mariners who have done good service this last Summer be approved off, viz^t: the Armes of the Common wealth on one side with *Marnisti* written above it, and the picture of the House of Coffons on the other."

That there was a "Medal of the Parliament" for land service as well, is proved by the following extract from the Journals of the House of Commons (vii. 6, 7):—

"Resolved, That a Chain of Gold, with the Medal of the Parliament, to the Value of One Hundred Pounds, be sent to Colonel Mackworth, Governor of Shrewsbury, as a mark of the Parliament's Favour, and good acceptance of his fidelity: And that the Council of State do take care for the providing the same, and sending it forthwith."

This order was duly carried out, as is shown in the minutes of the Council of State, June 2 and July 30, 1652, but there is no trace to-day of either medal or chain. It is not unlikely that this medal is one figured at page 117 of Evelyn's *Numismata* (the engraving, unnumbered, is placed between Nos. 39 and 40, and there is no allusion to it in the text), which has on the obverse a representation of the parliament, and on the reverse a bust of the Protector with a camp and troops in the background.

The most splendid of all the naval awards of this period were those given for the three victories over the Dutch in 1653, namely:—

¹ Thomas Simon, master and chief graver of the mint. Most of the medals of this period were his work, and they are considered to be amongst the best specimens of the medallic art that have been produced in the country.

1. The fight of Feb. 18/20, when Blake, Deane and Monk defeated Van Tromp and De Ruyter, the battle beginning off Portland and ending near Calais; (2) the fight of June 2 and 3, off the Essex coast, when Monk, Deane (killed), Penn and Blake, again defeated Van Tromp and De Ruyter; (3) the fight of 31st of July off the Texel, in which Monk, Penn and Lawson beat Van Tromp in what was the decisive action of the war. The authorization for these awards will be found recorded in the Journals of the House of Commons (vii. 296, 297), under date Aug. 8, 1653. The medals, all oval, and in gold, were given in three sizes, as described below:—

A (2·2 by 2 in.). Only four of these medals were issued, to Admirals Blake and Monk, each with a gold chain of the value of £300, and to Vice-Admiral Penn and Rear-Admiral Lawson, each with a gold chain of the value of £100. On the obverse is an anchor, from the stock of which are suspended three shields, bearing respectively St George's cross, the saltire of St Andrew, and the Irish harp, the whole encircled by the cable of the anchor. On the reverse is depicted a naval battle with, in the foreground, a sinking ship. Both obverse and reverse have broad, and very handsome, borders of naval trophies, and on the obverse side this border has imposed upon it the arms of Holland and Zealand. Of these four medals three are known to be in existence. One, lent by the warden and fellows of Wadham College, Oxford (Blake, it may be noted, was a member of Wadham College) was exhibited at the Royal Naval Exhibition of 1891. A second is in the royal collection at Windsor Castle. The third, with its chain, is in the possession of the family of Stuart of Tempsford House, Bedfordshire. This latter medal is known to have been the one given to Vice-Admiral Penn, an ancestor of the Stuart family. The one at Windsor is presumably Blake's, as Tancred states "the medal given to Blake was purchased for William IV. at the price of 150 guineas (Tancred, *Historical Records of Medals*, p. 30). The medal at Wadham was formerly in Captain Hamilton's collection. He purchased it at a low figure, but secrecy was kept as to the owner, and the original chain that was with it went into the melting-pot: there is therefore nothing to show whether it was Monk's or Lawson's, as the chain would have done. It was sold at Sotheby's in May 1882 for £305.

B (2 by 1·8 in.). Four of these medals were issued, each with a gold chain of the value of £40, to the "Flag Officers," i.e. to the flag captains who commanded the four flag-ships. The obverse and reverse of this medal are, with the exception of the borders, precisely as in (A). The borders on both sides are a little narrower than those of (A), and of laurel instead of trophies. One of these medals—that given to Captain William Haddock, who was probably Monk's flag-captain in the "Vanguard," in the February fight, as he had been in that ship in the previous year, and who commanded the "Hannibal," (44) in the June battle—is now (1909) in the possession of Mr C. D. Holworthy, who is maternally descended from Captain Haddock.

C (1·6 by 1·4 in.). This medal is precisely the same as (B), but has no border of any kind, and also was issued without the gold chains. It was in all probability one that was issued in some numbers to the captains and other senior officers of the fleet.

Some of these medals have in the plate of the reverse an inscription: FOR EMINENT SERVICE IN SAVING Y TRIUMPH FIERED IN FIGHT WH Y DVCH IN JULY 1653. The medal so inscribed was given only to those who served in the "Triumph," and commemorates a special service. Blake, incapacitated by wounds received in the fight of February, took no part in this action, but his historic flag-ship, the "Triumph," formed part of the fleet, and early in the battle was fired by the Dutch fire-ships. Many of the crew threw themselves overboard in a panic, but those who remained on board succeeded by the most indomitable and heroic efforts in subduing the flames, and so saving the vessel.

But undoubtedly the most interesting of all the medals of the Commonwealth period, is that known as the "Dunbar

Medal," authorized by parliament, Sept. 10, 1650, in a resolution of which the following is an extract:—

"Ordered, that it be referred to the Committee of the Army, to consider what Medals may be prepared, both for Officers and Soldiers, that were in this Service in Scotland; and set the Proportions and Values of them, and their number; and present the Estimate of them to the House. (*Journals of the House of Commons*, vi. 464-465.)

So come into being, what, in a degree, may be regarded as the prototype of the "war medal" as we know it to-day, for the "Dunbar Medal" is the very earliest that we know was issued to all ranks alike, to the humblest soldiers as well as to the commander-in-chief. It differed however in one very material point from the war medal of to-day—in that it was issued in two sizes, and in several different metals. There is no evidence to show what was the method that governed the issue of this medal; but the medal itself undoubtedly varied in size or metal, or both, according to the rank of the recipient. Of the two sizes in which the medal was issued the smaller, 1 by ·85 in. was apparently intended for seniors in the respective grades, for it was struck in gold, silver and copper. The larger, 1·35 by 1·15 in. was struck in silver, copper and lead (see Mayo. *op. cit.* i. 20-21).¹ On the obverse of both issues of the "Dunbar Medal" is a left profile bust of Oliver Cromwell, with, in the distance, a battle. The reverse of the larger medal has the parliament assembled in one House with the Speaker; and, on the left, a member standing addressing the chair. The reverse of the smaller medal is the same as that of the larger, except that the member addressing the House is omitted. Cromwell himself expressed a wish to the "Committee of the Army, at London," in a letter dated the 4th of February 1650/51, that his likeness, to procure which accurately the committee had sent Mr Simon to Scotland, should not appear on the medal. He writes:—

"If my poor opinion may not be rejected by you, I have to offer to which I think the most noble end, to wit, That Commemoration of that great Mercie att Dunbar; and the gratuitie to the Army, which might be better expressed upon the Medall, by engraving, as on the one side the Parliament which I hear was intended and will do singularly well, so on the other side an Army, with this inscription over the head of it, The Lord of Hosts which was our Word that day. Wherefore, if I may beg it as a favour from you, I most earnestly beseech you, if I may do it without offence, that it may be soe. And if you think not fit to have it as I offer, you may alter it as you see cause; only I doe think I may truly say, it will be very thankfully acknowledged by me, if you will spare the having my Effigies in it."

In spite of this request Cromwell's "Effigies" is made the prominent feature of the obverse of the medal, to which the representation of the "Army" is entirely subordinated. His wish that the "word" for the day should be commemorated is, however, observed in the legend on the obverse, as is also, on the reverse, his suggestion that on one side of the medal there should be a representation of the parliament.

During the reign of Charles II. the issue of medals was numerous, and though we have it on the authority of Evelyn that many of these were bestowed as "gratuities of respect," yet many were given as naval awards; and, for the first time, there appears official authorization for the conferring of particular awards on those who had succeeded in the very hazardous service of destroying an enemy's vessel by the use of fire-ships. In what are probably the earliest "Fighting Instructions" issued—those of Sir William Penn, in 1653, and again in an abridged form in 1655—no allusion to these awards is made, but that the custom of rewarding this special service prevailed, there is a piece of strong indirect evidence to show, in the shape of an amusing letter from a certain Captain Cranwill, of "ye Hare Pinke," to the Admiralty Committee, dated Feb. 4, 1655:—

¹ An excellent reproduction of this medal, both obverse and reverse, is given in Plate 8, figs. 4 and 5, of the same work, and on Plate 9 will be found equally well reproduced facsimiles of the three medals for "Victories over the Dutch, 1653," figs. 1, 2 and 3 and of the "Medal of the Parliament, for Sea Service, 1649," fig. 1.

"As for ye Pay yor Honrs were please to order mee for my service in ye Hare Pinke, I return most humble thanks, and am ready to serve yor Honrs and my Country for ye future

For though ye Hare be mewsed in ye sand
yet Cranwell at yor mercy still doth stand
A fire Ship now doth hee Crave,
And the Fox fain would hee Have,
then has hee had both Fox and Hare,
then Spanish Admirall stand ye cleare,
For Cranwell means ye Chaîne of goold to ware;
Sett penn to paper it is done,
for Cranwell still will be your man."

all of which goes to show that it had not been unusual to bestow gold chains, with or without medals, on the captains of fire-ships. By the "Fighting Instructions" issued 20th of April, 1665, by James, duke of York, lord high admiral, it was provided as follows. In the case of the destruction of an enemy's vessel of forty guns or more, each person remaining on board the fire-ship till the service was performed was to receive £10, "on board ye Admirall immediately after ye service done," and the captain a gold medal and "shuth other future encouragement by preferment and commande as shall be fitt both to reward him and induce others to perform ye like Service." If it was a flag-ship that was fired "ye Recompense in money shall be doubled to each man performing itt, and ye medall to ye Commander shall be shuth as shall particularly express ye Eminensye of ye Service, and his with ye other officers preferment shalbe suitable to ye merit of itt." This was followed by an "Order of the King in Council" dated Whitehall 12th of January 1669-1670, in which the lord high admiral is authorized "to distribute a Medall and Chaîne to such Captaines of Fire Shippes as in the last Dutch Warr have burnt any Man of Warr, as also to any of them that shall perform any such service in the present Warr with Algiers. Which Medalls and Chaines are to be of the price of Thirty Pounds each or thereabouts"

To complete the story of fire-ship awards, it may here be noted (though out of chronological order) that in 1703 revised "Fighting Instructions" were issued by Admiral Sir George Rooke, in which it was provided that the captain was to have his choice between a gratuity of £100, or a gold medal and chain of that value. Lastly an order of the king in council, dated, St James's, 16th of December, 1742, ordered that all lieutenants of fire-ships (which originally carried no officers of this rank) should be entitled to a gratuity of £50 "in all cases where the Captain is entitled to the Reward of £100." Though probably others were conferred, so thorough an investigator as the late John Horsley Mayo, for many years assistant military secretary at the India office, who had special opportunities of access to official records, traced but three authenticated fire-ship awards. Those were: (1) to Captain John Guy, who blew up his fire-ship the "Vesuvius" under the walls of St Malo in 1693; (2) to Captain Smith Callis who, with his fire-ship the "Duke," in 1742, destroyed five Spanish galleys which had put into St Tropez, to the eastward of Marseilles; (3) to Captain James Wooldridge, who commanded the British fire-ships in Aix Roads on the 11th of April 1809, when four French sail of the line were burnt. This latter is believed to be the last award of the kind that was issued. Fire-ships awards are of special interest as affording a precedent, in future naval wars, for the award of special decorations for torpedo services.

It is in this reign also that we first find a case of medals being granted by the Honourable East India Company. The earliest of these would appear to have been a gold medal of the value of £20, conferred on Sir George Oxinden, president at Surat, 1622-1669, in 1668, for considerable civil and military services. Surat was then and until 1687, when Bombay took its place, the seat of government of the Western Presidency, and the most eminent of Sir George's services was the defence of the Company's treasures and possessions at that place against Sivajee and the Mahrattas in 1664. It is not known what has become of this medal, but there is indirect evidence to

show that it was a circular medal, three inches in diameter. On the obverse the "Arms of the Governor and Company of Merchants of London trading to the East Indies, with crest, supporters, and mottoes," and around the legend NON MINOR EST VIRTUS QUAM QVAERERE PARTA TVERI. The reverse was probably blank to admit of an inscription. This award was the forerunner of many given by the H.E.I. Co., several of which were "general distributions" of the very highest interest, which will be dealt with together later on.

The awards made in the reigns of James II., William and Mary, William III., Anne, George I., George II., may be very briefly dealt with. Almost without an exception they were either naval or conferred by the Hon. East India Company, and with only perhaps one or two exceptions, they were "personal" as distinct from "general" awards. Of the very few medals awarded by James II., one was an undoubted military award, though curiously enough the recipient was a bishop. This was Peter Mew, who had been made bishop of Bath and Wells in 1672, was translated to Winchester 1684, "and next year was commanded by the king, in compliance with the request of the gentry of Somerset, to go against Monmouth, and did eminent service at the battle of Sedgmoor, where he managed the artillery; for which he was rewarded with a rich medal" (Hutchins's *History of Dorset*, 3rd ed., vol. iv. p. 149).

The possible exceptions in the way of a "general" distribution of a medal during the reigns under review are the cases of the medals struck after the battles of La Hogue, 1692, and Culloden, 1746. By an act of parliament passed in 1692 (4 Gul. and Mar. c. 25), it was enacted that a tenth part of the prize money taken by the navy should be set apart "for Medalls and other Rewards for Officers, Mariners, and Seamen in their Majesties Service at Sea who shall be found to have done any signal or extraordinary service." (Later a Royal Declaration of Queen Anne, the 1st of June 1702, provided that all medal and monetary awards "shall be also paid out of Her Majesties Shares of Prizes.") This is the first case in naval records authorizing the issue of medals to men as well as to officers, and the conferring of the "La Hogue" medal was the first case in which the enactment was carried into effect, at any rate as far as admirals and officers are concerned. Seamen and soldiers had a more substantial reward, for the queen sent £30,000 to be distributed amongst them, whilst gold and silver medals were struck for the admirals and officers. The medal, which was circular, 1.95 in. in diameter, had on the obverse the busts conjoined of William and Mary, r., with around GVL ET MAR D G M B F ETH REX ET REGINA. On the reverse was a representation of the fight, showing the French flag-ship, "Le Soleil Royal," in flames, with above the legend, NOX NVLLA SECVTA EST, and, in the exergue, PVGN NAV INT ANG ET FR 21 MAY 1692.

As regards the medal struck after Culloden, fought on the 16th of April 1746, and in which the adherents of the young Pretender were completely routed, there is nothing even to show that it was issued even by the authority of the government, though it was undoubtedly worn, and (if a contemporary portrait is to be relied upon, that of an ancestor of Mr W. Chandos-Pole of Radbourne Hall in Derbyshire) around the neck attached to a crimson ribbon with a green edge. There is no doubt it was struck in gold, silver and copper, but how it was awarded there is no proof, probably only to officers. The obverse had an r., bust of the duke of Cumberland, with above CUMBERLAND, below YEO f (Richard Yeofecit), and, on the reverse, an Apollo, laureate, leaning upon his bow and pointing to a dragon wounded by his arrow. The reverse legend was ACTUM EST ILLIC PERIIT, and, in the exergue PROEL COLOD AP XVI MDCCXLVI. The medal is a strikingly handsome one, with an ornamental border and ring for suspension, oval, 1.75 by 1.45 in., but very few specimens are known to exist. Those in gold were probably only given to officers commanding regiments and a very fine specimen of these, originally conferred on Brigadier-General Fleming (at one time in command of the 36th Foot) is now in the collection of Major-General Lord

Cheylesmore. In his monograph, *Naval and Military Medals*, Lord Cheylesmore mentions another "Culloden" medal in his collection, "a slightly larger one in white metal, which leads one to suppose that it was given in inferior metal to the more junior branches, probably officers; but whether this was the case or no I am unable authoritatively to state." However, one thing is fairly certain, that the issue of the "Culloden" medal was in no sense "general," as we now understand the term, nor as were the issues for "Dunbar" or the issues of the Honourable East India Company, which will next be dealt with.

No medal awards were made to either the naval or military services for the Seven Years' War, and the American War of Independence. In fact George III. had been more than thirty years on the throne when the first medal award by the Crown was given, in the shape of the navy gold medals, first issued in 1794. It will however be more convenient to deal later with these medals and the army gold medals and crosses given for services in the long and arduous struggle of 1793-1815, and to describe here in sequence those medals which were issued by the Honourable East India Company, the issue of which was, with certain limitations, "general," thus reverting to the precedent first established in the "Dunbar" award, namely an issue to all ranks. They are nine in number, and are described below in the chronological order of the military operations for which they were awarded.

1. The "DECCAN" medal. Authorized, first in 1784, and again 1785. Obverse: Figure of Britannia seated on a military trophy, with her right hand holding a wreath of laurel and extended towards a fortress over which the British flag flies. Reverse: Persian inscriptions—In centre, "Presented by the Calcutta Government in memory of good service and intrepid valour, A.D. 1784, A.H. 1199;" around, "Like this coin may it endure in the world, and the exertions of those lion-hearted Englishmen of great name, victorious from Hindostan to the Deccan, become exalted." This medal was issued in two sizes, diameters 1.6 and 1.25 in. The larger medal was struck both in gold and silver, the smaller in silver only, and both were worn round the neck suspended from a yellow cord. This medal was awarded to two large detachments of the Bengal army, denominated the "Bombay Detachment" (authorized 1784), and the "Carnatic Detachment" (authorized 1785), which respectively fought in the west of India and Guzerat, 1778-84, and in the south of India, 1780-84. The medal was not given to any Europeans, only to natives; the larger medal in gold to Subadars, and in silver to Jemadars; the smaller silver medal to non-commissioned officers and sepoy. By a minute of council, dated the 15th of July 1784, a further boon was granted to the "Bombay Detachment," inasmuch as it exempted the Hindus of that detachment from payment of the duties levied by the authorities on pilgrims to Coya in Behar. As the large majority of the troops were high caste Hindus, and Coya was, and is the Mecca of Hinduism, this favour must have been much appreciated by the recipients of the medal. This is the earliest Anglo-Indian example of a medal issued alike to all ranks.

2. The "MYSORE" medal. Authorized, 1793. Obverse: A sepoy holding in his right hand the British colours, in his left an enemy's standard reversed, whilst his left foot rests on a dismounted cannon. A fortified town is in the background. Reverse: Within a wreath, "The Honourable East India Company." Between wreath and rim is an inscription in Persian: "A memorial of devoted services to the English government at the war of Mysore. Christian Era, 1791-1792, equivalent to the Mahomedan Era, 1205-1206." Like the "Deccan" this medal was in two sizes, diameters 1.7 in. and 1.5 in., the larger being struck both in gold and silver, the smaller in silver only, and both were worn suspended from the neck by a yellow cord. The medal was awarded for the operations against Tippos Sultan, and was bestowed on the "Native Officers and Sepoys of the Infantry and Cavalry, and on the Artillery Lascars, who either marched by land, or proceeded by sea from the Carnatic to return to Bengal." For services in Mysore were given the Subadars, the large silver to "Jemadars and Serangs," the small silver medals to "Havildars, Naicks, Tindals, Sepoys and Lascars." The award therefore, followed precisely the precedent set in the "Deccan" medal. One of the very rare gold specimens of this medal is in the collection of Captain Whitaker, late 5th Fusiliers, whose collection, and that of Lord Cheylesmore, are probably the two finest that have as yet been brought together.

3. The "CEYLON" medal. Authorized, 1807. Obverse: An English inscription: "For Services on the Island of Ceylon, A.D. 1795-6." Reverse: A Hindoo inscription: "The Medal was presented to commemorate good services in Ceylon during the years of the Hegira 1209-10." This medal was issued in only one size, 2 in. diameter, and was awarded to a small force of Bengal native artillery which formed a fraction of a large body of British and native troops (the rest did not receive the medal) which captured Ceylon

from the Dutch in 1795-96. It is the only instance of a war medal that has merely a verbal design on both obverse and reverse, and moreover it sets a precedent that was destined to be followed only too often in that it was only granted twelve years after the services that had earned it had been rendered. Only 123 medals were struck, two in gold for native officers, and 121 in silver for other ranks. Like the two preceding, it was worn from the neck suspended from a yellow cord.

4. The "SERINGAPATAM" medal. Authorized, 1799, for services in Lord Harris's campaign of that year, and the storming of Seringapatam. Obverse: A representation of the storming of the breach at Seringapatam, with the meridian sun denoting the time of the storm. In the exergue is a Persian inscription: "The Fort of Seringapatam, the gift of God, the 4th May 1799." Reverse: A British lion overcoming a tiger, the emblem of Tippos Sultan. Above is a standard, with, in the innermost part of the hoist immediately contiguous to the staff, the Union badge, and, in the fly, an Arabic legend signifying "The Lion of God is the Conqueror." In the exergue: IV. MAY, MDCCXCIX. (the date of the assault). It was in one size, 1.9 in. but of five different kinds. Although the medal was authorized in 1799, it was 1801 before orders for the preparation of 30 gold medals, 185 silver-gilt, 850 silver, 5000 copper bronzed, and 45,000 pure tin, were given, the artist being C. H. Kuchler, and the medals made by Matthew Boulton at the Soho Mint, Birmingham. It was 1808 before they came out to India for distribution, and it was not till 1815 that the Company's European officers had the prince regent's sanction to wearing them on public occasions. For the first time the issue was absolutely "general," to Europeans as well as natives, to Crown troops as well as to those of the H.E.I. Co. but it was not till 1851, when the First India C.S. Medal was awarded, that official sanction was given to their being worn by Europeans in uniform. The medal was given in gold to general officers, in silver-gilt to field officers, in silver to captains and subalterns, in copper bronzed to non-commissioned officers, and in pure grain tin to privates and sepoy. With regard to this medal there is an incident that is worth recording. The bulk of the troops engaged at Seringapatam were Crown forces, or belonged to the Madras and Bombay presidencies; the only Bengal troops taking part being five battalions of infantry, and artillery detachments. On their return to Bengal no steps were taken with regard to medals till 1807, when medals copied from the Soho Mint one, by 28 in. only 1 in. diameter, were made at the Calcutta Mint. Following the Bengal precedents as set in the "Deccan," "Mysore" and "Ceylon" medals, the medals were struck in gold for officers, and in silver for the other ranks. A Bengal native officer therefore wore just the same medal as a general officer of any of the other forces, and similarly a Bengal sepoy wore the same medal as a British captain or subaltern of the Crown. The Bengal medal can easily be distinguished from the others, for in the reverse the artist's initials C.H.K. are rendered "C.H.H." Some officers, amongst them Lord Harris himself and his second-in-command Sir David Baird, wore the medal with the red, blue and white ribbon, which is the same as that worn with the Army Gold Medal (see below) and was in fact the only authorized military ribbon then in use; but though no ribbon was issued with the medal, recipients were given to understand that the ribbon would be of a deep maize colour and watered, the shading on the ribbon symbolizing the stripes in the fur of the tiger, Tippos Sultan's favourite emblem. The duke of Wellington's medal (silver gilt), has the maize (or yellow as it is often termed) ribbon, and the medal was undoubtedly more generally worn with this ribbon than with the red and blue one. There are also apparently occasional instances of it having been worn with a plain white ribbon.

5. The "EGYPT" medal. Authorized, 1802. Obverse: A Sepoy holding the Union Flag in his right hand; in the background a camp. In exergue, in Persian: "This medal has been presented in commemoration of the defeat of the French Army in Egypt by the victorious and brave English Army." Reverse: A British ship sailing towards the coast of Egypt. In the background, an obelisk and four pyramids. In the exergue, MDCCCL. This medal was only awarded to native officers and men of the small force of Bengal and Bombay troops which formed part of the expeditionary force from India, that operated in Sicily and the Abruzzi in 1801. It was in one size, 1.9 in. diameter. This was another case of a belated issue (1811 for the Bengal troops and two years later for the Bombay troops). The medal was issued in only one size, 1.9 in. diameter. For the Bengal troops 776 medals were struck, 16 in gold for commissioned officers, 760 in silver for other ranks. The Bombay government obtained the approval of the court of directors for the issue of the medal to their troops in 1803, but apparently did nothing till 1812, when they asked the Calcutta Mint for a copy of the medal to enable them to prepare similar ones. The Bombay Mint would not however appear to have been equal to the occasion, and the sample was returned to Calcutta with the request that 1430 medals might be struck there. This was accordingly done, but all of these medals were made of silver, and so the medal went to the Bombay troops in all ranks alike. As in the case of the "Deccan" medal, Hindu sepoy, who had volunteered for Egypt, were exempted from the duties levied on pilgrims. This medal was worn suspended from the neck by a yellow cord.

WARS OF THE FRENCH REVOLUTION AND NAPOLEON ERAS



Navy Gold Medal, 1794-1815.



Army Gold Medal and Cross, 1810-1808-14.



Waterloo, 1815.



Navy General Service, 1848.
1793-1840.
Medal dated 1848 but authorized 1847.



Army General Service, 1848.
1793-1814.
Medal dated 1848 but authorized 1847.
Since 1799 the medal is worn on a ribbon for which awarded those prior to 1847.

INDIA. AWARDS BY THE HON. EAST INDIA COMPANY



Seringapatam, 1801.



Ghazni, 1841.
1839.
The Ghazni Medal was carried out by the British East India Company after the capture of the city of Ghazni in 1841.



Military Ribbon of India, 1842.
The Medal was with the ribbon an "A" shape. The ribbon was of the colors of the British East India Company. The ribbon was of the colors of the British East India Company. The ribbon was of the colors of the British East India Company.



Sutlej, 1845.
1845-46.



Punjab, 1849.
1840-49.

INDIA. AWARD H. B. I. CO.



First India G.S., 1851.
1799-1856.

Date given is as in error, but the first action for which the Medal was awarded did not take place until 1801. This Medal is now termed "Army of India Medal".

INDIA. AWARDS BY THE CROWN



Second India G.S., 1854.
1852-1858



Indian Mutiny, 1858.
1857-58.



Afghanistan, 1879.
1878-80.
Second Afghan War.



Third India G.S., 1895.
Since 1895.
The award of March 1904 made the 7th Class.

RUSSIAN WAR



Crimea, 1854.
1854-56.



Turkish Crimes, 1855.
1854-56.



Baltic, 1856.
1854-55.



New Zealand, 1869.
1845-47, 1860-66.

EGYPT AND THE SUDAN



Egypt, 1882.
1882-89.



Khedive's Star, 1883.
1883-90.



Khedive's Sudan, 1897.
1896-98, and since.
This was the first award of the Medal. It was awarded to the British Army and the British Navy.

RECONQUEST OF THE SUDAN



Queen's Sudan, 1899.
1896-98.

NOTE.—Date following Title is that of authorization of first award, those under Titles are the year, or years, in which the operations for which the Medal was awarded took place.

6. The "RODRIGUES, BOURBON AND MAURITIUS" medal. Authorized, 1811. Obverse: A sepoy, holding in his right hand the British flag, in his left a musket with bayonet fixed, stands with his left foot trampling a French eagle and standard; beside the figure a cannon, and, in the background the sea and ships. Reverse: Within a wreath, in Persian: "This medal was conferred in commemoration of the bravery and devotion exhibited by the Sepoys of the English Company in the capture of the Islands of Rodrigues, Bourbon, and Mauritius, in the year of the Hegira 1226." In the circumference, in English: RODRIGUES VI. JULY MDCCCIX. BOURBON VIII. JULY AND ISLE OF FRANCE III. DEC. MDCCCX. This medal was awarded to the native troops of the Bengal Presidency that formed part of the combined naval and military forces that effected the reduction of the islands in 1809. The government of Bengal also suggested "for the consideration of the governments of Fort St George and Bombay, that corresponding Medals shall be conferred on the native troops from those Establishments;" but those governments do not appear to have complied with the suggestion, a distinct injustice to the Madras and Bombay troops employed. The medals, struck at the Calcutta Mint for the Bengal troops, were 1.9 in. in diameter, and in gold and silver, 45 gold for native officers, 2156 silver for all other ranks. They were worn as was customary in so many cases with yellow silk cord suspended from the neck.

7. The "JAVA" medal. Authorized, 1812. Obverse: A representation of the storming of Fort Cornelis. On a flag-staff the British flag is shown flying above a Dutch one, and over all is the word Cornelis. Reverse: In Persian: "This medal was conferred in commemoration of the bravery and courage exhibited by the Sepoys of the English Company in the capture of Java, 1228 Hegira." In circumference, in English: "JAVA CONQUERED XXVI. AUGUST MDCCCXI." This medal was awarded to the native troops of the Honourable East India Company (all Bengal), which took part in the expedition under Lieut.-General Sir Samuel Auchmuty which effected the capture of Java from the Dutch in 1811. The medal, 1.9 in. in diameter, was struck in gold and silver, 133 in the former metal for native officers, and 6519 in silver for other ranks, and was worn in the usual manner with a yellow silk cord.

8. The "NEPAL" medal. Authorized, 1816. Obverse: Hills crowned with stockades. In right foreground the colours and bayonets of an attacking force, to the left a cannon. Reverse: In Persian: "This Medal was conferred by the Nawab Governor-General Bahadur in testimony of the energy, good service, skill and rapidity, which were displayed in the Hills in the years of the Hegira 1229 and 1230." This medal was awarded to the native troops of the East India Company who took part in the arduous operations in Nepal in 1814-16. This medal, 2 in. in diameter, marks a very interesting new departure, for it was struck only in silver, and given to all ranks precisely alike, whether the recipient was commissioned or not. It was worn from the usual yellow silk cord.

9. The "BURMAH" medal. Authorized, 1826. Obverse: Representation of the storming of the great pagoda at Rangoon; on the left, a palm tree under which the general and staff, and the river with steamer and boats of the Irrawaddy flotilla joining in the attack. In exergue, in Persian: "The Standard of the victorious Army of England upon Ava." Reverse: The White Elephant of Burma crouching in submission before the British Lion; behind the lion, the British flag flying broad, behind the elephant, the Burma flag, drooping and between the two flags palm trees. In the exergue, in Persian: "The elephant of Ava submits to the lion of England, year 1826." This, one of the most beautiful of all war medals, was designed by W. Daniell, R.A., and executed by W. Wyon; and was awarded to all the Company's native troops, that participated in the First Burmese War, 1824-26. The medal, 1.5 in. in diameter, was issued in gold to native officers, in silver to other ranks. In all there were struck: for Bengal troops, 308 gold, 13,108 silver; and for those of Madras, 456 gold, 20,028 silver. Of the Madras medals however never nearly half were still unclaimed in 1840. It is with this medal that we first find, as regards Indian medals, definite instructions as to the use of a ribbon, and the manner in which medals should be worn. In 1831, it was officially ordered that the colour should be red with blue edges—it was in fact precisely similar to the Waterloo ribbon (for which see Plate I.)—and the instructions were that the medal "be worn perfectly square upon the centre of the left breast, the upper edge of the ribbon being even with the first button for the ranks wearing Sword Belts and even with the second button for ranks wearing Cross Belts." Like the Waterloo medal also, it was mounted on a steel clip and ring, and the medals were struck at the Royal Mint instead of, as heretofore, in India.¹

¹ Most of the authorities on medals, including Mr Thomas Carter and Captain Tancred, style as the reverse of the medal what above is styled the obverse and vice versa. We, however, prefer to agree with the description of the medal as given by Mayo and for this reason. The side of the medal which is described above as the obverse depicts a chief incident of the war; the allegorical representation on the other side is after all but the pictorial equivalent of a verbal inscription, and so is properly the reverse of the medal.

This closes the list of the Indian medals, which, with the exception of that for Seringapatam, were issued only to the native troops of the Honourable East India Company. All are now very rare and very highly valued by collectors.

As has already been stated, the first war medals awarded by the Crown in the reign of George III., were the navy gold medals, instituted on the occasion of Lord Howe's great victory over the French fleet on the 1st of June 1794. On the 26th of that month the king and queen visited Portsmouth, and, on the deck of the "Queen Charlotte," Lord Howe's flag-ship, presented the victorious admiral with a diamond-hilted sword of the value of three thousand guineas. Gold chains, from which the medals were afterwards to be suspended, were also conferred on Admiral Lord Howe; Vice-Admirals Graves and Sir Alexander Hood; Rear-Admirals Gardner, Bowyer and Pasley; and Captain of the Fleet Sir Roger Curtis. At the same time the king announced his intention of conferring gold medals on each of the officers named, and similar, but smaller medals on the captains. The medals were delivered in 1796, the Admiralty ordering "The Admirals to wear the Medal suspended by a ribbon round their necks. The Captains to wear the Medal suspended to a ribbon, but fastened through the third or fourth button-hole on the left side. The colour of the ribbon, blue and white."

The ribbon, which is white with broad blue borders (see Plate I.), did not of course supersede the gold chain in the case of those officers on whom chains had been conferred. They wore their chain with the ribbon, and the medal of Admiral Bowyer (now in the collection of Lord Chylesmore) is so suspended. The same splendid and intensely interesting medal was later conferred for various fleet and ship actions deemed worthy of special acknowledgment; and so came into being the first "regulation" medal for naval officers.

The two medals are, with but one slight distinction, identical in design, the larger being 2, and the smaller 1.3, in. in diameter. The design is:—

Obverse: The fore part of an antique galley, on the prow of which rests a figure of Victory who is placing a wreath on the head of British Britannia standing on the galley, the right foot resting upon a helmet, her left hand holding a spear. Behind Britannia is a "union" shield, charged with the Cross of St George and the Saltire of St Andrew. (Ireland had not then been added to the Union). Reverse: Within a wreath of oak and laurel, the name of the recipient, the event for which the medal was conferred, and the date. (In the smaller medal the wreath is omitted.)

In all, eighteen actions were recognized by this medal, the complete list of which is as follows:—

The "Glorious First of June" (7 large and 18 small medals); St Vincent (Feb. 14, 1797) (6 large and 15 small medals); Camperdown Oct. 11, 1797 (2 large, 15 small medals); The Nile (Aug. 1, 1798) (1 large and 15 small medals); Red Bank (the frigate "Hermione" from the Spaniards by the boats of H.M.S. "Surprise" at Porto Cavallo (Oct. 25, 1799) (1 small medal); Trafalgar (Oct. 21, 1805) (3 large and 27 small medals); Action off Ferrol (Nov. 4, 1805) (4 small medals); Action off St Domingo (Feb. 5, 1806) (3 large and 7 small medals); Capture of Curacoa (Jan. 1, 1807) (2 small medals); Capture of the Turkish frigate "Lion" (Feb. 2, 1807) by H.M.S. "Spartan" (1 small medal); Capture of the French frigate "Thetis" by H.M.S. "Amethyst" (Nov. 10, 1808) (1 small medal); Capture of the French frigate "Furieuse" by H.M. ship-sloop "Bonne Citoyenne" July 6, 1809 (1 small medal); Capture of the Island of Banda Neira (Aug. 9, 1810) (1 small medal); Captain W. Hoste's action off Lissa (March 13, 1811) (4 small medals); Capture of the French 74-gun ship "Fouquier" by H.M.S. "Victorious" (Feb. 22, 1812) (1 small medal); The "Chesapeake" and "Shannon" (June 1, 1813) (1 small medal); Capture of the French frigate "Erolle" by H.M.S. "Hebrus" (March 27, 1814) (1 small medal); Capture of the American frigate "President" by H.M.S. "Endymion" (Jan. 15, 1815) (1 small medal).

In all 22 large medals, and 117 small, were awarded; but this does not say that all who were entitled to the medal received it. This is most notably the case with regard to the "Glorious First of June." When the issue was made, in 1796, the medals were given only to those flag officers who had received gold chains, and to such captains as were specially mentioned in Lord Howe's despatch of the 21st of June, despite the fact that the admiral specially put it on record that the selection therein made, "should not be construed to the disadvantage of the other commanders, who may have been equally

deserving of the approbation of the Lords Commissioners of the Admiralty, although I am not enabled to make a particular statement of their merits." For this reason the medal was never awarded to Rear-Admiral B. Caldwell, fifth in command on the great day, to his flag-captain, Captain G. B. Westcott, and to seven other captains of line of battle ships engaged. One captain however, who was not mentioned in despatches, succeeded in gaining the medal, by a *tour de force* eminently characteristic of the superb breed of naval officers that the great wars had brought into being. This was Collingwood, who was retained to Bower in the "Barfleur." When Collingwood was awarded the medal for St Vincent, where he commanded the "Excellent," he flatly refused to receive it unless that for the First of June was also conferred upon him, which was done. For St Vincent, the Nile and Trafalgar, all flag officers and captains engaged received the medal. At the Nile, Troubridge's ship, the "Culloden," grounded in entering the bay, and so, strictly speaking, he was never engaged in the action; but the king specially included him in the award, "for his services both before and since, and for the great and wonderful exertions he made at the time of the action, in saving and getting off his ship."

For Camperdown, one captain, afterwards found guilty by court-martial of failure in duty, did not receive the medal. Several numerous awards of the smaller medals were made to the relatives of officers who were either killed in action or died of wounds. These were: on the first of June, Captains Hutt ("Queen"), Montagu ("Montagu"), Harvey ("Brunswick"); at Camperdown, Captain Burgess ("Ardent"); at the Nile, Captain Westcott ("Majestic"); at Trafalgar, Captains Duff ("Mars") and Cooke ("Bellerophon"). Captain Westcott was doubly unfortunate, for he was one of the First of June captains who should have received the medal but did not. Captain Miller of the "Theseus" also did not receive his medal for the Nile, for, though not killed in the action, he perished at Acre in an accidental powder explosion the May following, the medal arriving after his death, and being returned to the Admiralty. In only two cases were large medals conferred on officers below flag-rank, these being Sir R. Curtis, captain of the fleet to Lord Howe on the First of June, and Nelson, who only flew a commodore's broad pendant at St Vincent. Following this latter precedent Sir R. Strachan should have had the large medal for the action of the 4th of November 1805, for he also was a commodore, but it was denied him for what seems quite an inadequate reason, namely that he was junior in rank to Captain Hervey of the "Temeraire," who was the senior of the Trafalgar captains. Hervey was promoted to rear-admiral for Trafalgar on the 9th of November, and Strachan to the same rank on the following day.

The small medal too was conferred in only three cases on officers below the rank of post-captain. These were Commander Mounsey of the "Boon," Citizenry for the capture of the "Furieuse" and Lieuts. Pilfold and Stockham, who at Trafalgar commanded respectively the "Ajax" and the "Thunderer," the captains of those two ships being at the time of the action in England giving evidence at the court-martial of Sir Robert Calder. In all, of the eighteen awards of the Navy Gold Medal, eight were for fleet actions (one of which was between squadrons of frigates), seven for single ship actions, one between line of battleships, six in which frigates were engaged, two for shore operations (in both cases the taking of islands from the Dutch), and lastly the re-capture of the "Hermione" by the "Surprise." This last mentioned award is one particularly memorable, not only because it was the first time that the medal was awarded to a frigate captain, but also because it is the only case in which the medal was awarded for boat service pure and simple.

Nelson's two great victories, the Nile and Trafalgar, also earned a medal for all ranks that participated in them, but these awards were not made by the Crown but by the generosity of two private individuals, though of course with the king's approval and permission. The first of these is "Davison's Nile Medal," which Mr Alexander Davison, Nelson's prize agent and a valued friend, caused to be struck at a cost of near £2000, and one of which was presented to every officer and man engaged at the Nile. The medal, 1.85 in. in diameter, was given in gold to Nelson and his captains, in silver to lieutenants and officers of corresponding rank, in copper gilt to warrant and petty officers, and in copper bronze to seamen and marines.

Obverse: Hope, standing on a rock in the sea, holding in her right hand an olive branch, and supporting with her left side a shield on which is the bust of Nelson surrounded by the legend: "EUROPE'S HOPE AND BRITAIN'S GLORY." Behind the figure and shield is an anchor, whilst around all is inscribed: "REAR-ADMIRAL LORD NELSON OF THE NILE." Reverse: The French fleet at anchor in Aboukir Bay, the British fleet advancing to the attack; a setting sun denotes the time of the action. Around: "ALMIGHTY GOD HAS BLESSED HIS MAJESTY'S ARMS"; and, in exergue: "VICTORY OF THE NILE AUGUST 1 1801." It is the reverse the engraver when sinking the die forgot to transpose the position of the objects, and so the sun is made to set in the east instead of in the west, and the land which is shown on the right should properly be on the left.

Davison's Nile medal was struck at the Soho Mint, Birmingham, by Boulton, and it was this that probably inspired the latter to present a medal to all who took part in the battle of Trafalgar.

"Boulton's Trafalgar Medal" was 1.9 in. in diameter, and given in gold to the three admirals, in silver to captains and first-lieutenants, and in pewter to other ranks. In a very considerable number of cases the pewter medals were either returned, or thrown overboard the recipients being disgusted at what they deemed the paltriness of the reward. Obverse: A bust of Lord Nelson in uniform with around: HORATIO, VISCOUNT NELSON, K.B. DUKE OF BRONTE, &c. Reverse: A representation of the battle, with around on a scroll: ENGLAND EXPECTS EVERY MAN WILL DO HIS DUTY. In exergue: TRAFALGAR OCT. 21 1805.

Both the Davison and the Boulton medals were worn suspended from a blue ribbon. These are the only two cases in which officers and men of the navy and army have accepted and worn medals presented by a private individual.

The Gold Medal given by George III. to the superior officers in command at the battle of Maida, in Sicily, on the 4th of July 1806 is an award of special interest, for not only was it the first military award made by the Crown during the reign, but it was moreover the prototype of the superb army gold medals and crosses which were so widely distributed during the years that followed. A general order of the duke of York, commander-in-chief, dated Horse Guards, 22nd of February 1808, awarded a gold medal for Maida to Sir John Stuart, K.B., his three brigadiers, and nine other officers. Subsequently four other officers received it, so in all seventeen officers received the award. It was prescribed that the medal "should be worn suspended by a Ribband of the colour of the Sash, with a blue edge, from a button of the coat on the left side." It was in fact to be worn in the same way as the small Navy Gold Medal, and as this grant established blue and white as the specific navy ribbon, so did the Maida award establish red with a blue border as the regulation military ribbon. The Maida ribbon is in fact precisely the same as the Waterloo ribbon shown in Plate I. The Maida medal was 1.5 in. in diameter and struck in gold only. It was issued precisely alike, quite irrespective of rank, to each of its seventeen recipients.

Obverse: Head of George III., laureated and facing left, with below the legend: GEORGIUS TERTIUS REX. Reverse: Britannia casting a spear with her right hand, and on her left arm the Union shield, above, and approaching her is a Flying Victory holding out a wreath. In front of Britannia in four lines, is MAL/DIVI/MCCCVI; behind her the triquetra or trinacria, the symbol of the Island of Sicily. In the exergue are crossed spears.

Two and a half years after the Maida award the king authorized the "Army Gold Medal," the first grant of which was notified by the commander-in-chief, in a Horse Guards general order dated the 9th of September 1810. This authorized the bestowal of the medal on 107 senior officers mentioned by name. The battles commemorated were Roleia, Vimiera (1808), the cavalry actions of Sahagun and Benevente (1808), Corunna and Talavera (1809). The Army Gold Medal so awarded was in two sizes, large, 2.1 in. in diameter, for general officers, small, 1.3 in. in diameter, for officers of lower rank; and the regulations provided that it should be worn from a red ribbon edged with blue, the larger round the neck, the smaller on the left breast from a button-hole of the uniform. The ribbon was the same width, 1.4" for both ribbons, and precisely the same later on for the Gold Cross. Both large and small medals were of identical design, in fact there was no difference, either in medals or in ribbons, except in size and the style in which they were worn.

Obverse: Britannia seated on a globe, holding in her right hand a laurel wreath, and in her left, which rests upon a Union shield resting against the globe, a palm leaf; at her feet to her right, a lion. Reverse: A wreath of laurel, encircling the name of the battle or operations for which the medal was granted.

In the following years subsequent orders similar to the original grant extended the award of the Army Gold Medal, until eventually twenty-four distinct awards were made, commemorating twenty-six actions, or series of operations, which took place not only in the Peninsula, but also in North America, and both the East and the West Indies.

The Peninsula medals were for Roleia and Vimiera, Sahagun and Benevente, Corunna, Talavera, Busaco, Barrosa, Fuentes d'Onor, Albuera, Ciudad Rodrigo (1812), Badajoz (1812),

Salamanca, Vittoria, Pyrenees, St Sebastian, Nivelles, Nive, Orthes, Toulouse. The West Indies medals were for Martinique (Feb. 1809) and Gaudoupe (Jan.-Feb. 1810), the North American for Fort Detroit (Aug. 16, 1812), Chateauguay (Oct. 26, 1813) and Chrystler's Farm (Nov. 11, 1813), and there was, lastly, a medal awarded for Java (Aug.-Sept. 1811).

From the above it will be seen that as time went on many officers became entitled to two, three and even more medals, and as this was found inconvenient, the method of granting the award was very materially amended as notified by the commander-in-chief, in a general order, dated Horse Guards, October 7, 1813. This order formulated regulations which were as follows:—

1. That one medal only was to be borne by each officer recommended for the distinction.
2. That for a second and a third action a gold clasp was to be attached to the ribbon from which the medal was suspended inscribed with the name of the action.
3. When a fourth distinction was earned, the medal and two clasps were to be replaced by a Gold Cross having the four actions for which it was awarded inscribed upon it, one upon each arm.
4. On every occasion the recipient was awarded the decoration after the fourth a Gold Clasp worn on the ribbon was added to the Cross.

The regulations further laid down that only officers should be recommended who had been "personally and particularly engaged" on the occasion, and that officers were to be named by "special selection and report of the Commander of the Forces upon the spot, as having merited the distinction by conspicuous service. Further, the Commander of the Forces was restricted in his selection to General Officers, C.Os. of Brigades, C.Os. of Artillery or Engineers, and certain staff officers holding field rank, and Commanding Officers of Units, and Officers succeeding to such command during an engagement.¹ It was also ordered that awards earned by deceased officers should be transmitted "to their respective families." The Gold Cross that was, under these regulations, instituted is as follows:—

A Maltese Cross, $\frac{1}{2}$ inches square, with an ornamental border; in the centre, a lion, facing right; in each limb of the cross the name of one of the actions for which it was conferred. The back of the cross is the same as the front. The cross was precisely the same irrespective of whether it replaced a large or a small medal.

The clasps were all of the same pattern, whether worn with the cross, the large gold medal, or the small gold medal. They are 2 in. in length by $\frac{1}{2}$ in. in width, and bear, within a border of laurel, the name of the action for which they were conferred. At the close of the war in the Peninsula the issue of this handsome and much coveted decoration was discontinued, the enlargement of the Order of the Bath (January 1815) affording another method of reward which the Crown deemed more appropriate. On the occasion of this extension all officers who had obtained the cross with one clasp, *i.e.* who had been decorated for five or more actions, were made Knights Commander of the Bath. In all 847 awards of this superb decoration were made. The medal alone went to 469 officers, whilst 143 received it with one clasp, and 72 with two clasps. The cross was issued singly in 61 cases, with one clasp in 46, with two in 18, with three in 17, with four in 8, and with five clasps in 7 cases. The cross with six clasps was gained by Sir Colin Campbell (Lord Clyde), Sir Alexander Dickson (d. 1840) and Sir George Murray (d. 1846). Two officers, Viscount Beresford and Sir Denis Pack (d. 1823) received it with seven clasps. The duke of Wellington's had nine, the decoration thus commemorating fourteen out of the twenty-six battles, sieges or operations for which the Gold Medals, Cross and Clasps were awarded. On the limbs of this cross are, ROLEIA AND VIMIERA, TALAVERA, BUSACO, FUENTES DE ONOR. The clasps are for CIUDAD RODRIGO, BADAJOZ, SALAMANCA, VITTORIA, PYRENEES, NIVELLES, NIVE, ORTHES and TOULOUSE. Not until

¹ Captain Sayers of the royal navy, who commanded the "Leda" N° 36, and landed in command of the 500 seamen who erected and manned the batteries for the attack of Fort Cornelis, received the small medal for Java. This is the only case of the Army Gold Medal having been conferred on a naval officer.

after the close of the Great War, however, do we meet with the real prototype of the war medal as we know it to-day; for the Waterloo Medal of 1815 is the first actual "general" medal that was ever issued, because it was issued precisely alike to all ranks. In the twelve cases in which we have seen that a medal was given to all ranks, the medals differed either in size or in metal, or in both, according to the rank of the recipient, and in eight out of the nine issued by the Hon. East India Company the award was withheld from the British officers and men employed. Again in none of the cases quoted were the awards made by the Crown. The "Dunbar" medal was awarded by the Commonwealth parliament. The men of the Nile and Trafalgar wore their medals through the generosity of private individuals. In the other nine cases the award was made by the directors of the Hon. East India Company. It was with the issue of the Waterloo Medal that all this was changed and for this well-merited and much prized boon the Services owe all gratitude to the duke of Wellington. Writing from Orville on June 28, 1815, to H.R.H. the duke of York, he says:—

"I would likewise beg leave to suggest to your Royal Highness (the then Commander-in-chief) the expediency of giving to the non-commissioned officers and soldiers engaged in the battle of Waterloo, a medal. I am convinced it would have the best effect in the army; and, if that battle should settle our concerns, they will well deserve it."

Again, writing from Paris, Sept. 17, 1815, to Lord Bathurst, then war secretary:—

"I have long intended to write to you about the medal for Waterloo. I recommend that we should all have the same medal, hung to the same ribbon as that now used with the medals."

(*i.e.* the army gold medals and crosses). It is also fair to point out that in his place in the House of Commons, and on the day after the duke's letter to the commander-in-chief had been penned, William Watkins Wynn urged that medals should be given to the survivors of Waterloo, and that they should be the same for both officers and men, "so that they who had been fellows in danger might bear the same badge of honour." And so came into being that type of "general" medal, which beginning with Waterloo has continued down to the present.

The description of these later medals, and the points of interest about them, will now be given as fully as exigencies of space will allow.

1. *Waterloo*, 1815.—Awarded by the Prince Regent, 1816. Obverse: Bust of the Prince Regent. Leg. GEORGE P. REGENT. Reverse: Figure of Victory seated; in her right hand, a palm branch; in her left, an olive branch. Above, WELLINGTON; below, WATERLOO, JUNE 18, 1815. Ribbon: Crimson with blue borders (Plate I.). Clasps: Nil.

The notification of this award was made in a memorandum by H.R.H. the commander-in-chief, dated Horse Guards, March 10, 1816, and it is worth noting that the prince regent commanded that the ribbon "shall never be worn but with the medal suspended to it." The medal was conferred on all the British troops, including the King's German Legion, present on the 16th June at Quatre Bras, on the 17th in the fighting that took place during the retirement through Gemappe to Waterloo, and on the 18th at Waterloo. It was also given to four regiments, 2nd Batt. 35th, 1st Batt. 54th, 2nd Batt. 59th, and 1st Batt. 91st Regiments of Foot, which formed Sir Charles Colville's Brigade, which was detached. The reverse of this medal would appear to have been copied from the Greek Coin of Elis, about 450 B.C., a specimen of which is in the British Museum. The medals most prized by collectors are those of the 1st, 2nd, and 6th Dragoons (the "Union Brigade"), and the 28th and 42nd Regiments of Foot, as those regiments suffered very severely and consequently fewer survivors received the medal than in other corps.

2. *Ghuznee*, 1839.—Awarded by the Government of India, 1842. Obverse: The Gateway of the Fortress. Below, GHUZNEE. Reverse: In centre a space for name of recipient; above, 23rd July; below, a mural crown with underneath it 1839; the whole within a wreath of laurel. Ribbon: Particoloured, crimson and green (Plate I.). Clasps: Nil.

This medal originated with Shah Soojah, whose part the Indian government took in the Afghan troubles of the time. His downfall and death having taken place before the medals were ready, the actual award was made by the Government of India. It was originally ordered (Bengal Military Proceedings, May 27, 1842; Nos. 151 and 152) that the ribbon should be green and yellow, and it was undoubtedly so worn by some recipients; but there is no official record to show why the colours were altered to green and crimson.

The medal was awarded to all troops both of the Crown and of the Company that were actually present at the siege and capture of the fortress, July 21, 22, and 23, 1839.

3. *Syria*, 1840.—Awarded by the Sultan of Turkey, 1841. Obverse: A fortress on which the Turkish flag is flying, and above six stars; below, in Turkish, "The People of Syria; and the Citadel of Acre, A.H. 1258." Reverse: Cypher of the Sultan, within a laurel wreath. Ribbon: Red with yellow clasps.

The St Jean d'Acre medal, as it is commonly called, was awarded to the officers and men of the British fleet that were engaged in the operations off the coast of Syria, against Mehemet Ali, which culminated in the bombardment and capture of St Jean d'Acre, Nov. 3, 1840. The medal, 1½ in. in diameter, is purely a naval medal therefore, although a few artillery and engineer officers doing duty in the fleet received it. It was given in gold to officers of flag rank and captains (or field officers), in silver to quarter-deck and warrant officers, and in copper to lower ranks. This is the only instance of there being a difference made according to the rank of the recipient since the "Burma" medal.

4. *China*, 1840-42 (1st Medal); *China*, 1857-60 (2nd Medal).—Awarded by Queen Victoria, 1842, 1861. Obverse: Head of Queen Victoria, diademed, l. Leg. VICTORIA REGINA. Reverse: Naval and military trophy, with behind a palm tree, and in front a shield of the Royal Arms. Above, ARMIS EXPOSCERE PACEM. In exergue, CHINA 1842. Ribbon: Red with yellow borders (Plate I.). Clasps: 1st medal, nil; 2nd medal, six.—*China*, 1842. FORTS SHANTON 1857; TAKU FORTS 1858; TAKU FORTS 1860; PEKIN 1860.

The first China medal was awarded to all the naval and military forces, both of the Crown and of the Hon. East India Company, that took part in the first China War, 1840-42. Another medal was struck, and is to be found in proof, but it was never issued as it was deemed it might give offence to China. Of this the obverse is the same as that described above; but the reverse had, under the same motto, the British lion trampling upon the Chinese dragon, and in the exergue, NANKING 1842. The second China medal was similarly awarded to both the naval and military forces, British and Indian, that took part in the second China war, 1857-60. To those, however, who were already in possession of the first China medal the second medal was not awarded, they receiving a clasp CHINA 1842 to go on their original medal, together with the clasps to which their services in the second war had entitled them. The second medal was in fact not a new decoration but a re-issue. The first China medal was the first to be issued with the effigy of Queen Victoria upon it. The first medal with clasps for the second China war is very rare, and in almost every case probably to be found on a naval officer's medal. The second medal only one was issued with all the five new clasps. This was to a Royal Marine Artilleryman, and it is now in the Chevlesmore collection. Medals specially valued by collectors are those given to the 1st Dragoon Guards with the two clasps TAKU FORTS 1860 and PEKIN 1860, as only two squadrons of the regiment were present. In a G.O. by Lord Ellenborough, governor-general of India, dated Simla, Oct. 14, 1842, it was intimated that the Government of India would present to the Indian Army a medal, the design of which was indicated in the order; but this idea was of course abandoned when the queen intimated her intention of making the award.

5. *Jellalabad*, 1842.—Awarded by the Government of India, 1842. First medal.—Obverse: A mural crown; above, JELLALABAD. Reverse: VII April 1842. Second medal.—Obverse: Head of Queen Victoria as in China medal, but legend, VICTORIA VINDEX. Reverse: Figure of Victory flying, in her right hand two wreaths, in her left the British flag. Beneath, the town of Jellalabad. Above, JELLALABAD VII APRIL; in exergue, MDCCCLXII. Ribbon (both medals): Military ribbon of India (Plate I.). Clasps: Nil. In a G.O. dated Allahabad, April 30, 1842, Lord Ellenborough announced that the Government of India would present a medal to the Company's troops, and with the consent of Her Majesty, to those of the Crown, that held Jellalabad, under Sir Robert Sale (Nov. 12, 1842—April 7, 1842). The queen's consent to her troops (13th Foot, now Somersetshire Light Infantry) receiving the medal was granted in August. The governor-general being dissatisfied with the first medal, made at the Calcutta Mint, the second (generally known as the "Flying Victory") was ordered in England, and it was notified that on their arrival the first medals, all of which had been distributed, could be exchanged for the second. The new issue was ready by March 13, 1845, but the recipients apparently preferred the original medals, for very few were exchanged. Both are very rare, for only 2596 medals were issued. The "military ribbon of India" is a tri-colour composed of the three primary colours shading into one another. It was designed by Lord Ellenborough, and is intended to symbolize an Oriental sunrise.

6. *Afghanistan*, 1842 (1st Afghan)—Awarded by Government of India, 1842. Obverse: Head of Queen Victoria as on First China Medal. Reverse: The Gwalior Campaign, 1843, within a laurel wreath; above, a crown. No. 2. GHUZZEE CABUL each within a laurel wreath; above, a crown; below, 1842. No. 3. CANDAHAR

GHUZZEE CABUL 1842 all within a laurel wreath; above, a crown. No. 4. CABUL 1842 within a laurel wreath; above, a crown. Ribbon: Military ribbon of India (Plate I.). Clasps: Nil.

The authority for this medal is a G.O. of the governor-general dated October 4, 1842. It was awarded to all troops, both of the Crown and the Hon. East India Company, who took part in the operations in Afghanistan in 1842, that is to say the second phase of the First Afghan War. The medals, Nos. 2 and 3, were awarded to those troops that were with Major-General Sir William Nott in Candahar, and took part in the operations around that place, recaptured Ghuznee, and then joined hands with the column under Major-General Pollock at Cabul. The medal with reverse 4 was awarded to the column which advanced from Peshawar on Cabul, being joined en route by the victorious garrison at Jellalabad. This is the first of the four occasions on which the reverse of a medal has been used to denote the actual part taken in the operations by the recipient, in the manner that is now done by clasps. Of these medals the one with the No. 1 reverse is the rarest, as its issue was confined to the small portion of his army that Major-General Nott left behind him in Candahar. The medal with the No. 2 reverse is also rare, as its distribution was very limited.

7. *Kelat-Ghilzie*, 1842.—Awarded by Government of India, 1842. Obverse: A shield inscribed KELAT I GHILZIE encircled by a laurel wreath, and surmounted by a mural crown. Reverse: A military trophy, beneath, on a tablet, INVICTA MDCCCLXII. Ribbon: Military ribbon of India (Plate I.). Clasps: Nil.

The authority for this medal is the same as that for the First Afghan Medal, and the medal itself was awarded to the troops of the Hon. East India Company, which defended this hill fortress for several months, and finally, before they were eventually relieved from Candahar utterly routed and drove off a force of four thousand men. As the medal was given only to 950 in all (forty being European artillerymen, the remainder native troops), it is naturally very scarce.

8. *Sinde*, 1843.—Awarded by Queen Victoria to the forces of the Crown, and by the Government of India to the troops of the Company. Obverse: The Gwalior Campaign, 1843, within a laurel wreath. Reverse: 1. MEEANEE 1843. 2. HYDERABAD 1843. 3. MEEANEE HYDERABAD 1843. In each case the inscription is surrounded by a laurel wreath, and surmounted by a crown. Ribbon: Military ribbon of India (Plate I.). Clasps: Nil.

The award of a medal for Sir Charles Napier's conquest of Sind was first notified, as far as the troops of the Crown were concerned, by a letter from Lord Stanley, then war secretary, to the president of the India Board, dated July 18, 1843, and it is worth noting that this is the only instance of any medals for Indian service being paid for by the Crown. The medals were issued to the troops of the Government of India to their own troops, followed in a G.O. by the governor-general, dated September 22, 1843. The award was confined to those who had been present at either Meeanee or Hyderabad, and the medals were issued according as to which actions the recipient had been present, no one of course receiving more than one medal for the campaign. In addition to the land forces of the Hon. East India Company, the medal was also given to the naval officers and crews of the Company's *Botilla* on the Indus. The only Crown regiment that received this medal was the 22nd Foot.

9. *Gwalior*, 1843 ("Maharajpoo" and "Punniar" Stars).—Awarded by the Government of India, 1844. This decoration took the form of a bronze star of six points, 2 in. in diameter. Obverse: In centre a silver star, 1½ in. in diameter, around the centre of which is a circle in which is inscribed either MAHARAJPOOR 1843 or PUNNIAR 1843, and in centre of circle the date 29th DECR. Reverse: Plain for name and regiment, or corps, of recipient. Ribbon: Military ribbon of India (Plate I.). Clasps: Nil.

The award of a medal to the troops of the Crown and the Hon. East India Company engaged in the Gwalior Campaign of 1843 was first notified in a governor-general's G.O., dated Camp, Gwalior Residency, January 4, 1844; and the queen's permission for it to be worn by Crown troops given June 26, 1844. The force moved in two columns, the main and larger under Sir Hugh (Viscount) Gough, the smaller under Major-General Gray. Each force fought an action on the same day, December 29, 1843, the former at Maharajpoo, the latter at Punniar, and the star was inscribed according to which action the recipient was engaged. The stars were manufactured from the metal of the captured guns. The star given to Sir Hugh Gough had in the centre a silver elephant in lieu of a silver star, and it was originally intended that all should be the same, but the silver star was substituted for reasons of economy. As there were fewer troops at Punniar that star is of course the more uncommon.

10. *Sulej*, 1845-46 (1st Sikh War).—Awarded by Government of India, 1845. Obverse: Head of Queen Victoria as on First China Medal. Reverse: Figure of Victory, standing, with in right hand outstretched a wreath, in left a palm branch; at her feet a trophy of captured Sikh weapons and armour. In exergue, name and year of the first battle of the war: SULEJ 1845. In centre of star these inscriptions are four, viz. MOODKEE 1845, FEROZESHUHR 1845, ALIWAH 1846, SOBRAON 1846. Ribbon: Blue with crimson borders (Plate I.). Clasps: FEROZESHUHR, ALIWAH, SOBRAON.

¹ The second medal has no date.

² Royal Navy and Royal Marines only.

This award, given to all the troops, both Crown and Hon. East India Company engaged in the First Sikh War, was first notified in governor-general's G.O., dated Camp, Ferozepore, December 25, 1845, the queen's consent for Crown troops to receive the medal being given six months later. As there was a considerable number of troops engaged in this campaign, the medal is not a very rare one, but a very rare combination is the medal with Ferozesuhur in the exergue and the clasp "Alwal," as only the company of native artillery was given these medals and in no other. This is a specially noticeable medal, for it is the first time that "claps" were issued with a "general" medal, the precedent followed being that of the Army Gold Medal. For every action after his first battle, which was inscribed on the medal itself, the recipient received a clasp. Thus a medal with "Moodkee" in the exergue might carry one, two or three clasps; a "Sobraon" medal could have no clasps. This and the "Punjab" medal, to be described later, are generally considered to be the two finest pieces of medal work by W. Wyon, R.A.

11. *Navy General Service, 1793-1840.*—Awarded by Queen Victoria, 1847. Obverse: Head of Queen Victoria as on First China Medal; under head, 1848. Reverse: Britannia seated on a sea horse; in her right hand, a trident; in her left, a laurel branch. Ribbon: White, with dark blue borders (Plate I.). Clasps: 231 clasps in all were granted, of which 55 were for "Boat Service."

An Admiralty memorandum dated June 1, 1847, notified the grant of this award to commemorate the services of the fleet during the wars commencing in 1793 and ending in 1815, and this award is usually considered the award to those operations for which the Navy Gold Medal (see ante) had been conferred. Subsequently, however, a board of admirals was appointed to consider claims, and on their recommendation an Admiralty memorandum dated June 7, 1848, extended the grant. Clasps were to be given for: (1) All Gold Medal actions or operations. (2) All actions in which first lieutenants or commanders were promoted, as had been customary after important and meritorious engagements. (3) All "Boat Service" operations in which the officer conducting the operations was promoted. (4) For co-operation with the land forces, the sieges and capture of Martinique, 1800, Guadaloupe, 1810, Java, 1811, and St Sebastian, 1813, for all of which operations the Army Gold Medal had been awarded; and (5) The Bombardment of Algiers, 1816; the Battle of Navarino, 1827; and operations on the coast of Syria, 1840.

Although the medal is purely a naval one, yet it was conferred on a few soldiers who had done duty in the fleet in actions or operations, for which the medal was granted. Forty military officers in all received the Navy G.S. medal, one, Captain Caleb Chute, 69th Foot, with two clasps, the 14th Mar, 1795, and "St Vincent." It is very difficult to compile an absolutely accurate list of all the clasps issued, for in several cases more than one clasp was given for the same action, and there were moreover nine or ten clasps allowed for which no claims appear to have been made good. The combination of the clasps is endless, but it is curious to note that medals with more than one, or two clasps are rare; with four or five clasps, very rare; and the highest number of clasps issued with any one medal is six. Amongst very rare clasps the following may be mentioned. One survivor only—Lieut. Baugh, the officer in command, was alive to claim the clasp "Rapid, 24th April, 1808." Only two claims were proved for "Surly, 24th April, 1810"; six for "Castor, 17th June, 1809"; seven for "Amazon, 13th January, 1797"; eight for "Confiance, 14th January, 1809"; and ten for "Acheron, 3rd February, 1805." Of "Boat Service" clasps only three were claimed for "20th December, 1799"; four for "9th June, 1799"; and eight for "10th July, 1799." (All "Boat Service" clasps are inscribed "Boat Service" with the day and month on the left, and the year on the right.) In all nearly thirty thousand claims were proved for the medal.

12. *Army General Service, 1793-1841.*—Awarded by Queen Victoria, 1847. Obverse: Head of Queen Victoria as on First China Medal; under head, 1848. Reverse: Queen Victoria on a dais is placing a wreath on the head of the duke of Wellington, who kneels on his left knee before her, holding in his right hand the baton of a Field Marshal; at the side of the dais is a lion dormant. Legend: TO THE BRITISH ARMY. In exergue: 1793-1841. Ribbon: Crimson with blue borders (Plate I.). Clasps: EGYPT, MAIDA, ROULEIA, VIMIERA, SAHAGUN, BENEVENTE, SAHAGUN, BENEVENTE, BENEVENTE, SAHAGUN, MARTINIQUE, TALAUERA, GUADALOUPE, BUSACO, BARROSA, FUENTES D'ONOR, ALBUERA, JAVA, CIUDAD RODRIGO, BADAJOZ, SALAMANCA, FORT DETROIT, CHATEAUGUAY, CHRYSLETER'S FARM, VITTORIA, PYRENEES, ST SEBASTIAN, NIVELLE, NIVE, ORTHES, TOULOUSE.

This medal, frequently erroneously termed the "Peninsular War" medal, was awarded to the survivors of the military forces of the Crown that had taken part in the Peninsular War and in contemporaneous operations in other parts of the world. It was also given with the clasp "Java" to the European troops of the Hon. East India Company; with the clasps "Martinique" and "Guadaloupe" to certain local West Indian Corps; and with the clasps "Fort

Detroit," "Chateaugay," and "Chrystler's Farm," to some Canadian militia and local levies, as well as to some Indian auxiliaries. The award of the medal, and all the clasps except "Egypt," bear date June 1, 1847, but the clasp "Egypt" was not granted till February 12, 1850. Although the medal is supposed to commemorate services "during the wars commencing in 1793, and ending in 1814," the earliest operations for which the medal was awarded did not take place until 1801. No medal was issued with a clasp, and as will be seen the medal was awarded only for those actions or operations for which the Army Gold Medals (including that for Maida) had been awarded; and in addition for the operations in Egypt in 1801. The combination of clasps is endless but only two medals were issued with fifteen clasps, though several survivors proved their claim to fourteen clasps. In fact medals with seven, eight or nine clasps are not common, those with ten, or more, distinctly rare. For example, taking only medals issued to officers (including those of the King's German Legion) three were issued with 14 clasps, three with 13, nine with 12, twelve with 11, thirty-six with 10, fifty-eight with 9, ninety with 8, and one hundred and fourteen with 7. By far the rarest of all clasps is "Benevente," as according to the War Office lists only three would appear to have been issued, viz. to Captain Eveleigh, R.H.A., Pte. G. Barrett, 10th Hussars, and Pte. M. Gilmour, 18th Hussars, although a medal with this clasp having every appearance of being genuine and issued to Pte. William Lyne, 7th Hussars, was in the collection of Colonel Murray of Polmadie, Edinburgh. The "Benevente" clasp, as it has been recorded by fifteen men of the 15th Hussars and a few others. The three North American clasps are also very rare, especially Chateaugay. Leaving out awards to Indian warriors, the statistics regarding the issue of the North American clasps are approximately as follows. At Chateaugay some 300 men fought, and 132 survivors proved for the clasp, of which all except three of the Royal Artillery were Canadians. For Chrystler's Farm, the next rare clasp, out of about 800 engaged 176 claims were proved; viz. 79 of the 89th Foot, 50 Canadians, 44 of the 49th Foot, and 4 Royal Artillery. At Fort Detroit 332 men were engaged, and those who proved for the clasp included 210 Canadians, 42 of the 1st Foot, 5 Royal Artillery, and one man of the 41st Foot (who also got the clasp for Chrystler's Farm). One man proved for all three clasps, another for "Fort Detroit" and "Chateaugay," a third for "Chateaugay" and "Chrystler's Farm." The former medal is said to be in the cabinet of a New York collector. Two "regulars" also proved for the medal with clasps for "Fort Detroit" and "Chrystler's Farm," the one belonging to the Royal Artillery, the other to the 49th Foot. The medals of the King's German Legion are numbered 1 to 25.

13. *Punjab, 1848-49 (2nd Sikh War).*—Awarded by Government of India, 1849. Obverse: Head of Queen Victoria as in First China Medal. Reverse: Sikh chiefs delivering up their arms to Sir Walter Raleigh Gilbert, near Rawal Pindi, March 14, 1849. ABOVE, TO THE ARMY OF THE PUNJAB. In exergue, MDCCCLXIX. Ribbon: Blue with yellow stripes at side (Plate I.). Clasps: MOOLTAN, CHILIANWALA, GOOJERAT.

The award of this medal was first notified by a G.O. of the governor-general, dated Camp, Ferozepore, April 2, 1849. The medal is one of special interest, for it establishes the principle that now rules, viz. that every one participating in a campaign (including for the first time civilians) was entitled to receive the medal, apart from those who received the medal together with a clasp for a specific action. The medal in fact was granted "to every officer and soldier who has been employed within the Punjab in this campaign to the date of the occupation of Peshawur." In other words it was granted to all who had served "during this campaign within the territories of Maharajah Duleep Singh," irrespective of whether they had qualified for any of the clasps. A very large number of medals was therefore issued without clasps. Another interesting point about this award is that after its grant it was laid down that in future no medals were to be issued by the Government of India without the consent of the Crown. As a matter of fact the Government of India was for the future only concerned in the grant of the two medals that followed, namely the First and Second India General Service Medals. No medals were issued with more than two of the three clasps, the combination being given to "Mooltan" and "Goojerat" or "Chilianwala" and "Goojerat." Very rare medals are those of the 24th Foot with the clasp for "Chilianwala," as in that action they lost more than half their strength, their casualties amounting to 497, of whom 250 were killed or died of wounds. Another rare medal is that given without a clasp to the officers and men of the Indian Marine that manned the Indus Flotilla; and more rare still is the same medal with the "Mooltan" clasp which was given to a naval brigade landed from the same flotilla.

14. *India, 1793-1826 (1st India G.S., officially styled "India, 1851").*—Awarded by the Government of India, 1851. Obverse: Head of Queen Victoria as in First China Medal. Reverse: Victory seated, in her right hand a laurel branch, in her left a wreath; on the ground beside her a lotus flower, and in the left background a palm tree and trophy of Eastern arms. Above, TO THE ARMY OF INDIA. In exergue, 1799-1826. Ribbon: Sky blue (Plate I.). Clasps: ALLIGHUR, BATTLE OF DELHI, ASSYE, ASSEERGHUR, LASWARREE, ARGAMU, GAWLGHUR, DEFENCE OF DELHI, BATTLE OF DEIG, CAPTURE OF

¹ Whether in one or both actions, only one clasp awarded.

² A similar clasp was given with the Navy G.S. medal.

DEIG, NEPAUL, KIRKEE,¹ POONA,¹ KIRKEE-POONA,¹ SEETABULDEE,¹ NAGPORE,¹ SEETABULDEE-NAGPORE,¹ MAHEIDPORE, CORYGAUM, AVA, BHURTPPOOR.

This medal was awarded "to the surviving officers and soldiers of the Crown and of the East India Company" who took part in any one of seventeen specified actions and operations which occurred in India, Nepal and Burma, during the first twenty-five years of the 19th century, "including the officers and seamen of the Royal Navy and the Company's Marines who took part in the first Burmese War." The queen's consent to the grant of this medal was announced in the London Gazette by a Notice of the Court of Directors, dated March 21, 1851. It was subsequently notified to the British Army by a Horse Guards G.O., dated March 21, 1851; to the Royal Navy by an Admiralty memorandum of the same date; and to the Army in India by a governor-general's G.O., dated April 14, 1851. In this medal again there is a discrepancy in dating, for though it is dated 1799-1826, the first action for which it was awarded, the storming of Allighur, took place on September 24, 1803. No medals were issued without clasps, the largest combination of clasps known being five. According to the India Office records there were apparently men entitled to as many as seven clasps, but whether any medal was issued with more than five is very doubtful. That awarded to the duke of Wellington had three clasps, "Assye," "Argaum" and "Gawilghur." With the exception of medals issued with the Ava and Bhurtport clasps, this medal is a rare one, and with a large number of the clasps, all except perhaps those for Nepal and Maheidpore, an extremely rare one. The rarest of all is "Seetabuldee," as only two Europeans and two natives are known to have received it. Defence of Delhi "is also a very rare clasp, as were gallantly symbolizing the connection of the medal with India. As also "Corygaum," which was issued to only two Europeans; "both officers," and seventy-five natives. The only European troops present at Corygaum were an officer and twenty-six men of the Madras Artillery, of whom the officer and twelve men were killed and eight wounded. As the "Burma" medal had already been given to the Company's native officers and soldiers for the First Burmese War, only the European officers and men of the Company's service received the medal with "Ava" clasp; but as the "Nepaul" medal had not been given to all the native troops who actually served with the British in the medal's clasp "Assye" was granted to those native troops who had not received the Nepaul medal, as well as to all the Company's European officers and men.

15. *India, 1852-95* (2nd India G.S., officially styled "India, 1854").—Awarded by the Government of India as far as the first two issues with their clasps are concerned, all subsequent issues and clasps, with the exception of the last two, by Queen Victoria; the last two issues and clasps by King Edward VII. Obverse: Head of Queen Victoria as in First China Medal. Reverse: Victory standing, crowning a naked warrior sitting. In exergue, a lotus above and leafy symbolizing the west of the medal with India. Ribbon: Red, with two blue stripes, forming five 4-inch stripes (Plate I.). Clasps: PEGU,¹ PERSIA,¹ NORTH-WEST FRONTIER, UMBEYLA, BHOOTAN, LOOSHAI, PERAK 1875-76;¹ JOWAKI 1877-78, NAGA 1879-80, BURMA 1885-87;¹ SIKKIM 1888, HAZARA 1888, BURMA 1887-89, CHIN-LOOSHAI 1889-90, SAMANA 1891, HAZARA 1891, N.E. FRONTIER 1891, HUNZA 1891, BURMA 1889-92, LUSHAI 1889-92, WAZIRISTAN 1894-95, CHIN HILLS 1892-93, KACHIN HILLS 1892-93.

The queen's assent to this award, to those of H.M.'s Sea and Land Forces as well as those belonging to the East India Company's Establishment, engaged in the second Burmese War, was first made known to the Government of India in a letter from the Court of Directors, April 6, 1853. In a Minute by Lord Dalhousie, the governor-general, December 9, 1852, it had been suggested "whether it would not be better for the future, instead of issuing a separate Medal for each campaign, to have one Medal, such as the 'Indian Medal' (i.e. the 'India, 1851' Medal), which should be issued once to each individual entitled: the particular service for which it is granted being recorded on a Bar, and every subsequent service which may be thought to deserve distinction being recorded by an additional Bar. This plan would avoid the multiplication of Medals, which has accumulated of late years, which I humbly think is undesirable." In another letter from the Court of Directors to the Government of India, March 1, 1854, this suggestion is approved, and it was ordered that after "a suitable design" had been procured (L. C. Wyon designed the reverse), "the Medal to be now struck shall be of a general character, the particular service for which it is now granted, viz. 'Pegu,' being recorded on a Bar. In the event of the same soldiers being entitled hereafter to another similar distinction, the service will be recorded by an additional Bar to the same Medal. Occasional mistakes have however been made, for since the issue with the clasp for the Perak campaign, from which time it has become customary to date the clasp, many instances have occurred of men having received two medals with clasps for different campaigns. The issue to the Persian Expeditionary Force

(1856-1857), with the clasp "Persia," was awarded by the Court of Directors January 19, 1858, and sanctioned by the queen in the same month. The first issue of the medal by the Crown was authorized April 15, 1859, with the clasps "North-West Frontier" and "Umbeyla," the former covering various expeditions between 1849 and 1863, the latter the hard-fought Umbeyla Campaign of the latter mentioned year. All subsequent issues of the award were made by Queen Victoria, with the exception of those that carried with them the clasps "Chin Hill 1892-93," and "Kachin Hills 1892-93," which were only awarded ten years afterwards by King Edward VII., and notified in Army Order 9 of January 1903; the medal, which had meantime been superseded by the Third India G.S. medal described below, being re-issued with these last two clasps. The combination of clasps with this medal is very numerous, but medals with more than two or three clasps are rare. Seven is probably the greatest number awarded with any one medal, and a medal with this number, viz. "Umbeyla," "North-West Frontier," "Jowaki 1877-78," "Burma 1885-87," "Hazara 1888," "Samana 1891," and "Hunza 1891," was granted to Bhangra Singh, Sardar Bahadur, who retired as Subadar-Major of No. 4 (Derajat) Mountain Battery. Sir William Lockhart (g.c.) had the medal with six clasps. The rest of all the clasps is probably "Hunza 1891," as less than a thousand men were employed, and the majority of these were Cashmere Imperial Service Troops. No European troops received the clasps, "Looshai," "Naga 1879-80," or "Hunza 1891." "Sikkim 1888" is also a rare clasp as only some 2000 troops were employed, the only Europeans being two companies of the 2nd Derbyshire Regiment. So also is "N.E. Frontier 1891," for in the Manipur expedition for which this clasp was given about 3000 men were employed, the only Europeans being four companies of the King's Royal Rifle Corps. It was with the issue of this medal with the clasp "Burma 1885-87," that the precedent was set of awarding the medal and clasp in bronze to "all authorized followers," a precedent that was followed in all subsequent issues.

16. *South Africa, 1834-35, 1846-47, 1850-53*.—Awarded by Queen Victoria, 1854. (South Africa, 1877-79. Re-issue of first medal. Awarded by Queen Victoria, 1886.) Obverse: Head of Queen Victoria as in First China Medal. Reverse: A lion crouching behind a sugar bush (*Stylosanthes maderas*). Above, SOUTH AFRICA, 1834-35, 1853. In the exergue, a Zulu shield and a Zulu shield, the place of the date is taken by a trophy of four assegais and a Zulu shield. Ribbon: Orange watered, with two broad and two narrow blue stripes (Plate II.). Clasps: 1877-78-79, 1878-79, 1877-78, 1878, 1877, 1879.

The command of the queen that a medal should be awarded to the survivors of the forces that had been engaged in the first, second and third Kafir Wars (1834-35, 1846-47, and 1850-53) was notified by Viscount Hardinge, the commander-in-chief, in a G.O., dated Horse Guards, November 22, 1854. No clasps were issued with this medal. The medal was awarded only to the regular forces (including the Cape Mounted Rifles, so local levies did not receive it). In the third Kafir War a small Naval Brigade and a detachment of Royal Marines took part in the operations, and the survivors received the medal. The award of the re-issue was notified in a G.O. by the duke of Cambridge, commander-in-chief, August 1, 1880. It was to "be granted to Her Majesty's Imperial Forces, and to such of Her Majesty's Colonial Forces, European or Native, as were regularly organized and disciplined as combatants, whether raised by the Colonial Government or by the General Officer Commanding. The operations for which it was given were against the Galekas and Gaikas 1878-79, the Griqua 1878, Basuto 1879, Zulus 1879, and Sekeles 1878-79. In both the operations against the Galekas and Gaikas, and in the Zulu War of 1879, the Royal Navy and Royal Marines took part and received the medal. The clasps issued with this medal were as noted above and record the year, or years, of service covering all the operations in which the recipient was engaged. No one received a medal with more than one clasp. The medal without a clasp was issued to such troops as were employed in Natal from January to September 1879, but never crossed the border into Zululand.

17. *Crimea, 1854-56*.—Awarded by Queen Victoria in 1854. Obverse: Head of Queen Victoria as in First China Medal; below, 1854. Reverse: Victory crowning a Roman soldier, who holds a sword in his right hand, and bears on his left arm a shield on which is the figure of a lion. On the left, CRIMEA. Ribbon: Light blue, with narrow yellow borders (Plate I.). Clasps: ALMA, BALAKLAVA, INKERMANN, SEBASTOPOL, AZOFF.³

This medal, awarded to both Services, was first notified by a commander-in-chief's G.O., dated December 15, 1854. The grant was limited to all troops landing in the Crimea up to September 9, 1855—the day on which Sebastopol fell—unless they shall have been engaged after that date in some expedition or operation against the enemy." This latter proviso applied in the main to the naval clasp "AZOFF," the period for which award was extended to the 22nd of November. The clasps for this medal are very ornamental, being in the shape of oak leaves, ornamented with acorns. The Royal Navy and Royal Marines, besides the "Azoff" clasp, received the clasps "Balaklava," "Inkermann," "Sebastopol." The

¹ Whether in one or both actions, only one clasp awarded.

² The Royal Navy or Indian Marine, or both, received the medal with these clasps.

³ Royal Navy and Royal Marines.

largest number of clasps to any one medal is four. Certain non-combatants received the medal without a clasp.

18. *Baltic, 1854-55*.—Awarded by Queen Victoria, 1856. Obverse: Head of Queen Victoria as in First China Medal. Reverse: Britannia seated and holding a trident in her right hand. In the background forts. Above, *BALTIC*. In exergue, 1854-1855. Ribbon: Yellow, with pale blue borders (Plate I.). Clasp: Nil. This award was notified by Admiralty Order, June 5, 1856, as granted "to the officers and crews of Her Majesty's ships, as well as to such officers and Men of Her Majesty's Army as were employed in the operations in the Baltic in the years 1854 and 1855." The medal is, of course, practically a naval one, but two officers and ninety-nine men of the Royal Engineers were employed in the expedition, especially at Bomarsund, and received it.

19. *Turkish Crimea Medal*.—Awarded by the Sultan, 1856. Obverse: A trophy composed of a field piece, a mortar, and an anchor, the field piece standing on the Russian Imperial Standard, and having a map of the Crimea spread over the wheel and breech. Behind are the Turkish, British, French and Sardinian flags. The flag of the nation to which the recipient belonged is in the front with that of Turkey, the flags of the other two nationalities behind. In exergue, "Crimea 1855," "La Crimée 1855," or "La Crimea 1855," according as to whether the medal was intended for British, French or Sardinian recipients. Reverse: The Sultan's cypher, below, in Turkish, "Crimea," and the year of the Hégira, 1271. Ribbon: Crimson watered, with bright green edges (Plate I.). Clasp: Nil. This medal was distributed to all of the Allied Forces, both naval and military, which shared in the operations in the Black Sea and the Crimea. As the ship that conveyed a majority of the English medals was sunk, the remainder were issued indiscriminately, and a large number of the British received medals which were originally intended either for the French or Sardinians.¹

20. *Arctic, 1818-1855 (First Arctic)*.—Awarded by Queen Victoria, 1857. Obverse: Head of Queen Victoria, wearing a tiara. Legend, *VICTORIA REGINA*. Reverse: A ship blocked in the ice, icebergs to the left and left, and in foreground a sledging party. Above, *FOR ARCTIC DISCOVERIES*. In exergue, 1818-1855. Ribbon: White (Plate II.). Clasp: Nil.

This award was first notified in an Admiralty Notice dated, January 30, 1857. It was given to the crews of Her Majesty's ships employed in Arctic exploration, and also "to the officers of the French Navy, and to such volunteers as accompanied those expeditions"; also to those engaged in expeditions "equipped by the government and citizens of the United States"; also to the "commanders and crews of the vessels of the United States, in great and humanity of Her Majesty's subjects"; and finally to those who served "in the several land expeditions, whether equipped by Her Majesty's government, by the Hudson's Bay Company, or from private resources." The medal is worn on the left breast and takes rank as a war medal. It is octagonal in shape, 1.3 in., and has affixed to the upper edge a five-pointed star which is attached a ring for suspension. The head of the queen, which is the work of L. C. Wyon, has never been reproduced on any other medal.

21. *Indian Mutiny, 1857-58*.—Awarded by the Government of India, 1858. Obverse: Head of Queen Victoria as on First China Medal. Reverse: Britannia standing facing left with a lion on her right side; her right arm is extended holding out a wreath; on her left arm is the Union shield, and in her left hand a wreath. Above, *INDIA*. In exergue, 1857-1858. Ribbon: White, with two red stripes, forming five 1/2-inch stripes (Plate I.). Clasp: DELHI (May 30 to Sep. 14, 1857); DEFENCE OF LUCKNOW (June 20 to Sep. 25, 1857); RELIEF OF LUCKNOW (Nov. 1857); LUCKNOW (March 2 to 21, 1859); CENTRAL INDIA (Jan. to June 1858).

The grant of this award was first notified in a despatch from the Court of Directors to the Government which stated that "the Queen has been graciously pleased to command that a Medal shall be granted to the troops in the Service of Her Majesty, and of the East India Company, who have been, or may be, employed in the suppression of the Mutiny in India." This is the last medal given by the Honourable East India Company. The medal without clasp was awarded to all, including civilians, who had taken part in the operations against the rebels, and to those who were enumerated above to those who shared in the operations specified. Some two or three artillery men are known to have received the medal with the clasps "Delhi," "Relief of Lucknow," "Lucknow" and "Central India." The medal with three clasps, viz., "Delhi," "Relief of Lucknow" and "Lucknow" was given only to the 9th Lancers and the Bengal Horse Artillery, and of course

various officers who served on the staff, as, for example, Field Marshals Earl Roberts and Sir Henry Norman. With regard to the Royal Navy and Royal Marines, the "Shannon's" brigade, under Captain Peel, received the medal with one, or both, of the clasps "Relief of Lucknow," "Lucknow," the "Pearl's" brigade, under Captain Sotheby received the medal without clasp. This is the last medal that had on it the beautiful head of Queen Victoria which was first used for the China Medal of 1842, and of which W. Wyon, R.A., was the artist.

22. *Abyssinia, 1857-68*.—Awarded by Queen Victoria, 1868. Obverse: Bust of Queen Victoria, with diadem and veil; around an indented border, between the nine points of which are the letters A.B.Y.S.S.I.N.I.A. Reverse: Within a beaded circle the name of recipient, his corps, regiment or ship, the whole surrounded with a wreath of laurel. Ribbon: Red, with broad white borders (Plate I.). Clasp: Nil.

The sanction of this award is to be found in a letter from Sir J. S. Pakington, secretary of state for war, to H.R.H. the duke of Cambridge, field-marshal commanding-in-chief, which notifies the queen's pleasure "that a medal be granted to all Her Majesty's Forces and Indian Forces, Naval and Military, employed in the operations in Abyssinia, which resulted in the capture of Magdala." In all 20,000 medals were struck. The medal is smaller than the usual, 1 1/2 in. in diameter, and it is surmounted by an Imperial Crown, and a large silver ring for suspension. It is altogether an unusual type of medal, and in the use of an indented border it falls a very old precedent, that of a medal commemorating the victory of Valens over Procopius, A. D. 365. (See *Les Médailles de l'Empire romain*, by W. Froehner, Paris, 1878). The artists responsible for this medal are Joseph S. Wyon and Alfred B. Wyon, and this bust of the queen is reproduced on only one other medal, the New Zealand.

23. *New Zealand, 1845-47, 1860-66*.—Awarded by Queen Victoria, 1869. Obverse: Bust of Queen Victoria as on Abyssinia medal, but larger. Legend: *VICTORIA D:G:BRIT: REG:F:DE: Reverse: Dated, within a wreath of laurel, according to the period in which the recipient served. Above, NEW ZEALAND; below, VIRTUTIS HONOR*. Ribbon: Blue, with a broad red stripe down centre (Plate I.). Clasp: Nil.

The grant of this award to the Army was notified in an Army Order, dated March 1, 1869, and its extension to the Royal Navy and Royal Marines by an Admiralty Order, dated June 3, 1869. Owing to incompleteness in the returns many medals were issued undated. The dates on the reverse, in those issued dated, varied considerably for the Army, but the medal was issued to the Army with only one and to the Navy with five different dates; for the *Second Maori War*, the medal was issued to the Army with twenty-one, and to the Navy with five different dates. No medal was dated 1862, though many of the Army medals bore date of a period covering that year, although no naval medals did.

24. *West Africa, 1873-1900*.—Awarded (originally as the "Ashantee" medal) by Queen Victoria in 1874, with the exception of the last issue, with clasp "1900," which was awarded by H.M. King Edward VII. Obverse: Head of Queen Victoria, with diadem and veil behind, by L. C. Wyon. Legend: *VICTORIA REGINA*. Reverse: British soldiers fighting savages in thick bush, by Sir E. J. Poynter. Ribbon: Yellow, with black borders, and two narrow black stripes (Plate II.). Clasp: COOMASSIE, 1887-8, 1891-2, 1892, 1893-94; WITU, 1890-; LIWINDI, 1893-7; WITU, August 1893-; JUBA RIVER, 1893-; LAKE NYASSA, 1893-; GAMBIA, 1894-; BENIN RIVER, 1894-; BRASS RIVER, 1895-; MWELÉ, 1895-; NIGER, 1897; BENIN, 1897-; SIERRA LEONE, 1898-99; 1896-98, 1899-1898, 1899, 1900 (dated June 1).

This medal was first awarded by Army Order 43, dated June 1, 1874, to "all of Her Majesty's Forces who have been employed on the Gold Coast during the operations against the King of Ashantee," and in addition a clasp, "Coomassie," "in the case of those who were present at Amoafol and the actions between that place and Coomassie (including the capture of the capital), and of those who, during the five days of those actions, were engaged on the north of the Prah in maintaining and protecting the communications of the main army." In all, with and without the clasp, 1,000 medals were issued for the Ashantee campaign to both Services. Over eighteen years later this same medal was re-issued as a "general service" medal, the award being for operations in Central Africa, and on the East and West Coasts, during the period 1887-92, which were covered by the dated clasps "1887-8," "1891-2," and "1892." As such the issue was continued for operations down to the year 1900, although the official title "West

¹ These clasps were all naval awards, but two companies of the West India Regiment took part in the operations for which the clasp "Gambia, 1894," was awarded.

² Were awarded by the Admiralty to certain local forces which co-operated with the Naval Brigades.

³ "Mwélé, 1895," is not strictly speaking a clasp, as it is engraved on the edge of the medal. Recipients already in possession of the medal were entitled to have the action and date engraved thereon. It corresponds, however, to a clasp, in that it commemorates a particular service, and so has been included.

Africa Medal" (see Army Order 253, of Dec. 1894) is somewhat of a misnomer, for very frequently the medal has been granted for services in Central Africa and in the Hinterland of the East Coast as for services on the West Coast. In all issues since the original "Ashantee" medal, the clasp only was given to those who already had the medal, so subsequent issues do not make it a new award. As will be seen later, the same medal was subsequently issued with a different ribbon, and so constituted as an entirely new decoration, that could be worn in conjunction with the older one. With the exception of those issued with "Mwele, 1895" engraved on the medal, none of these medals have been issued without a clasp since the original issue for the campaign of 1873-74; and the clasp "Coomassie" that accompanied the first issue is the only one that has been issued to regimental units of the British Army as apart from the West India Regiment and local troops. The duke of Edinburgh was married in January of the year in which this medal was first awarded, and it is said that yellow and black (the Imperial Russian colours) were chosen as the colours of the ribbon, in compliment to his consort the grand duchess Marie of Russia.

25. **Arctic, 1876** (2nd Arctic Medal).—Awarded by Queen Victoria, 1876. Obverse: Bust of Queen Victoria, crowned and with veil by G. G. Adams. Legend: VICTORIA REGINA; underneath bust, 1876. Reverse: A ship packed in floe ice; above, an Arctic sky with fleecy clouds in a clear horizon. Ribbon: White (Plate II.). Clasp: Nil.

The award of this grant was notified in an Admiralty Order, dated Nov. 28, 1876, and the award is specified "to all persons, of every rank and class, who were serving on board Her Majesty's ships 'Alert' and 'Discovery' during the Arctic Expedition of 1875-1876, and on board the yacht 'Pandora,' in her voyage to the Arctic Regions in 1876." The 'Pandora' was owned and sailed by Commander (Sir Allen) Young, R.N.K., whose officers and crew rendered valuable services to Her Majesty's ships when in the Polar seas. Sixty-three medals were given on board the 'Alert,' fifty-seven on board the 'Discovery.' The bust on the obverse of this medal has not been reproduced on any other. The reverse (by L. C. Wyon) is copied from a photograph taken during the expedition of the 'Alert' and 'Discovery' under Sir George Nares, K.C.B.

26. **Afghanistan, 1878-80** (2nd Afghan). Awarded by Queen Victoria, 1880. Obverse: Bust of Queen Victoria, crowned and with veil, by J. E. Boehm. This is the first war medal bearing the imperial title. Legend: VICTORIA REGINA ET IMPERATRIX. Reverse: A column of troops emerging from a mountain-pass, headed by a heavy battery elephant carrying a gun; behind, mounted troops. Above, AFGHANISTAN. In exercise, 1878-79-80. Ribbon: Green, with crimson borders (Plate I.). Clasp: ALI MUSJID, PEIWAR KOTAL, CHARASIA, KABUL, AHMED KHEL, KANDAHAR.

On the conclusion of the first phase of the Second Afghan War, it was proposed that the (Second) India G.S. Medal should be issued for this campaign with clasps "Afghanistan," "Ali Musjid," "Peiwar Kotal," but, after the massacre of Sir P. L. N. Cavagnari and the members and escort of the Embassy at Kabul, Sep. 3, 1879, and the consequent renewal of the war, it was decided to grant a separate medal. The first official intimation of the award is in a telegram from the secretary of state for India to the viceroy, dated Aug. 7, 1880. The award, with the regulations to govern the issue, was promulgated in a G.O. by the governor-general, Dec. 10, 1880, and subsequent G.O.'s. The medal without clasp was awarded to all who had served across the frontier between Sep. 1, 1878, and May 26, 1879 (first phase of the war) and between Sep. 1879, and Aug. 15, 1880 for the Khyber and Kurram Lines, and Sep. 20, 1880, for Southern Afghanistan (second phase of the war). The 'Kabul' clasp was awarded to all who had shared in the operations "at and near that place from the 10th to the 23rd Dec., 1879, including the column under the command of Brigadier-General C. J. S. Gough, C.B., which joined Sir Frederick Roberts on the 24th Dec., 1879." The clasp for "Kandahar" did not include the whole garrison of the beleaguered city, but only the troops that were actually "engaged in the action fought under Sir Frederick Roberts' command against Sirdar Mahomed Ayub Khan on the 1st Sep., 1880." The greatest number of clasps with which the medal was issued was four, and the units to which such medals were issued are the 72nd Highlanders, 5th Ghoorkas, 5th Punjab Infantry and 23rd Punjab Pioneers. The bust of the Queen by Sir Edgar Boehm, R.A., has not been reproduced on other war medals.

27. **Kabul to Kandahar, 1880.**—Awarded by Queen Victoria, 1880. This decoration took the form of a five-pointed star, 1-1/2 in. across from point to point, with a ball between the points; between the two topmost points of the star is an Imperial Crown and ring for suspension. Obverse: In the centre the imperial monogram V. I. surrounded by a band inscribed KABUL TO KANDAHAR, 1880. Reverse: Plain, with a hollow centre, round which the recipient's name and regiment are indented in capital letters. The old rainbow-coloured military ribbon is worn with this star.

The grant of this award was first notified in a despatch from the secretary of state for India to the viceroy, dated Nov. 30, 1880. This awarded the decoration "to the force which marched from Kabul to Kandahar," and later, Aug. 26, 1881, a G.O. by the

Governor-General extended the grant "to the troops which then composed the garrison of Kelat-i-Ghilzai, and accompanied the force under the command of Lieutenant-General Sir F. S. Roberts, G.C.B., V.C., from that place to Kandahar."

28. **Egypt, 1882-1889.**—Awarded by Queen Victoria, 1882. Obverse: Head of Queen Victoria as in the West African Medal. Legend: VICTORIA REGINA ET IMPERATRIX. Reverse: A Sphinx; above, EGYPT; below, 1882. Ribbon: Blue, with two white stripes, forming five 3-inch stripes (Plate I.). Clasp: ALEXANDRIA, 11th JULY; TEL-EL-KEBIR, SUAKIN, 1884; EL-TEB, TAMAAI, EL-TEB-TAMAAI, THE NILE, 1884-85; ABU KLEA, KIRBEKAN, SUAKIN, 1885; TOFREK, GEMAJAH, 1888; TOSKI, 1889. This medal was first awarded (Admiralty Circular, Oct. 1882; G.O. by the commander-in-chief, Oct. 17, 1882; and G.O. by governor-general of India, Oct. 27, 1882); to all the Forces, naval and military, present and serving in Egypt between July 16, and Sep. 14, 1882. The first two clasps were also given with this issue. One military officer (Major-General Sir A. B. Tulloch, then of the Welsh Regiment) received the clasp "Alexandria, 11th July," as he was serving in the fleet as military adviser to Admiral Sir Beauchamp Seymour. A second issue was made in 1884, and with it the next four clasps were given: "Suakin, 1884," for those who landed at Suakin or Trikiat between Feb. 19 and March 26, 1884; was, however, only given to those with the 1882 medal, those not so possessed receiving the medal without a clasp. A third issue was made in 1885, the next five clasps accompanying it. "The Nile, 1884-85," was given to those who served south of Assouan or before March 7, 1885; "Suakin, 1885," to those who were engaged in the operations at Suakin between March and May 14, 1885; but the former clasp was only to go to those already possessed of the medal, others received the medal only. The medal alone was also given to all on duty at Suakin between March 27, 1884, and May 14, 1885. No medals were issued with single clasps for "Tofrek," recipients of which were also got clasp "Suakin, 1885," or "Abu Klea" and Kirbekan, recipients of which got also clasp "The Nile, 1884-85." In 1886, the medal without was issued to those who had not previously received it and had served at, and south of Wady Halfa, between Nov. 30, 1885 and Jan. 11, 1886, but no clasps went with this issue, although the operations included the battle of Ginnia. The last issue was made in 1890. The medal with clasp "Gemaizah, 1888," to all who were present at that action near Suakin, Dec. 20, 1888; the medal alone to all employed on the Nile at, and south of Korosko, on Aug. 3, 1889, and with clasp "Toski, 1889," to all present at that action, Aug. 3, 1889. Besides those already enumerated, who receive the medal without clasp, it was given to officers of line, to transports of the mercantile marine, to some civilians, native and European, to the Australian contingents that landed at Suakin, and to the Canadian boatmen employed on the Nile. In fact, not far short of fifty thousand of these medals have been struck, and the numbers issued have exceeded that of any other medal with the exception of that given for the South African War. Seven clasps: "Tel-el-Kebir," "Suakin, 1884," "El-Teb-Tamamai," "The Nile, 1884-85," "Abu Klea," "Gemaizah, 1888," and "Toski, 1889," were awarded to one officer, Major Beach, late 20th Hussars, who also received the Bronze Star with the clasp "Tokar, 1890." The medal with six clasps was earned by four men of the 19th Hussars who were Lord Wolsley's orderlies, and who after having earned the first five clasps enumerated in Major Beach's medal, went with Lord Wolsley to Suakin and so got the "Suakin, 1885" clasp.

29. **Egypt Bronze Star, 1882-93.**—Awarded by the Khedive 1883. This decoration is in the shape of a five-pointed star (1-1/2 in. diameter) connected by a small star and crescent to a laureated bar to which the ribbon is attached. Obverse: A front view of the Sphinx, with the desert and pyramids in the rear. Around a double band, upon which are, above, EGYPT, 1882, and below, in Arabic, "Khedive of Egypt, 1299" (the Hegira date). In the second and third issues the dates are respectively altered to 1884, 1301 and 1884-85 and 1301-4; the fourth and fifth issues are dateless. Reverse: A large raised circle inside which is the Khedival monogram, T. M. (Tewfik Mahomed), surmounted by a Crown and Crescent and Star. Ribbon: Dark blue (Plate I.). Clasp: TOKAR, 1890.

This star was awarded for the same operations as was the British Egyptian medal above described, but, except for a few officers and men of the Royal Navy, the issue of the clasp TOKAR was confined to British and native officers and men of the Egyptian service. (H. L. S.)













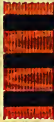

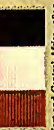



30. **Canada, 1885.**—Awarded by Queen Victoria, 1885. Obverse: Head of Queen Victoria as on the West African "Ashantee" Medal. Reverse: NORTH WEST CANADA and date, within a double line. Ribbon: Blue, with a crimson stripe on each side (Plate II.). Clasp: SASKATCHEWA.

This medal, commemorative of services in the Riel Rebellion, was awarded to Canadian forces only.

¹ Issued to the Royal Navy and Royal Marines only.

² For combatants present at both actions.















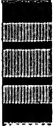







³ Only clasp not issued to Royal Navy and Royal Marines.

SOUTH AFRICA		WEST, EAST, AND CENTRAL AFRICA	
	King Edward VII. South Africa, 1901. 1899-1902. Boer War Medal.		Queen Victoria South Africa, 1899. 1897-99. Frequently termed the "Uganda" Medal.
	British South Africa Co., 1893. 1891, 1896, 1897. Frequently termed "abootela" or "Mathekietse" Medal.		Ashanti Star. 1896.
	Cape Colony General Service, 1900. 1886-81, 1896-97.		East and Central Africa, 1895. 1891-1894. Medal the same as West Africa, but the difference being that the ribbon is red, white, and black on each side of the center ribbon. This Medal is often mistaken for "Central Africa" Medal.
	South Africa, 1853. 1834-35, 1846-47, 1860-53, 1877-79. 1853 in error, but Medal actually authorized 1854.		West Africa, 1874. 1871-1900. Originally termed as "Ashanti Star," for campaign of 1873-74, and afterwards became a West African C. S. Medal.
CANADA		FOR PERSONAL GALLANTRY	
	Canada. 1885. Suspension of Aid's Rebellion in the North-West.		Conspicuous Gallantry. NAVY, 1874.
	Arctic Medal of 1857. Arctic Medal of 1876. Polar Medal of 1905.		Distinguished Conduct in the Field. ARMY, 1862.
	Canada General Service, 1899. 1866, 1870.		Transport Service, 1902 For Officers of the Mercantile Marine Up to 1902 two awards had been made, one for South Africa and one for China.
	Naval Gunnery, 1903. For best shot in ship during year with each nature of gun.		Imperial Yeomanry. 1904.
	Tibet, 1903 1903-04.		Volunteer Force. Long Service Medal. 1894.
	Ashanti. 1900.		Hon. Artillery Company. Long Service Medal. 1906.

NOTE.—Date following Title is that of authorization of first award, those under Title are the year, or years, in which the operations for which the Medal was awarded took place.

MEDALS AND DECORATIONS

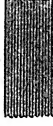
PLATE II.

SOUTH AFRICA		WEST, EAST, AND CENTRAL AFRICA		CANADA		FOR PERSONAL GALLANTRY		LONG SERVICE AND GOOD CONDUCT	
	South Africa, 1853. 1834-35, 1846-47, 1850-53, 1877-79 1853 in error, but Medal actually authorized 184.		Cape Colony General Service, 1900. 1886-81, 1896-97.		British South Africa Co., 1893. 1891, 1896, 1897. Frequently termed "abobodele" or "Makakichasi" Medal.		Queen Victoria South Africa, 1901. 1899-1902. Boer War Medal.		King Edward VII. Medal. 1899-1902.
	West Africa, 1874. 1872-1900. Originally named as "Ashanti Star," for campaign of 1873-74, and afterwards be- came a West African G. S. Medal.		East and Central Africa, 1895. 1891-1898. Medal the same as West Africa, but the differ- ence being that the ribbon is black and both the words were by a red ribbon. The Medal is often termed the "Central Africa" Medal.		Ashanti Star. 1896.		East and Central Africa, 1899. 1897-99. Frequently termed the "Uganda" Medal.		Ashanti. 1900.
	Arctic Medal of 1857. Arctic Medal of 1876. Polar Medal of 1905.		Canada. 1885. Suspension of King's Accolade in the North-West.		Canada General Service, 1899. 1866, 1870.		Africa General Service, 1902. Since 1901. The award of the 1897 made the 20th clasp to this Medal.		Tibet, 1903 1903-04.
	Distinguished Conduct in the Field. Army, 1862.		Conspicuous Gallantry. NAVY, 1874.		Transport Service, 1902 For Officers of the Mercantile Marine Up to 1908 two awards had been made, one for South Africa and one for China.		Naval Gunnery, 1903. For best shot in ship during year with each nature of gun.		Volunteer Force. Long Service Medal. 1894.
	Navy and Royal Marines 1831.		The "Medicine" Medal is worn with a similar Ribbon.		Militia. 1904.		Imperial Yeomanry. 1904.		Hon. Artillery Company. Long Service Medal. 1896.

Note.—Date following Title is that of authorization of first award, those under Titles are the year, or years, in which the operations for which the Medal was awarded took place.

31. *Canada (General Service)*.—Awarded, 1899. Obverse: Head of Queen Victoria, as in Third India G. S. Medal. Reverse: Within a maple wreath, the Dominion flag, above, CANADA. Ribbon: Red, with white centre (Plate II.). Clasp: FENIAN RAID, 1866; FENIAN RAID, 1870; RED RIVER, 1870. One battalion of the King's Royal Rifles received this medal with the Red River Clasp. Otherwise issued confined to Canadian forces.

32. *Queen's Sudan, 1866-1898*.—Awarded by Queen Victoria, 1899. Obverse: Half-length effigy of Queen Victoria holding sceptre, by De Saullès, as in "Uganda" medal described below. Reverse: A winged Victory, seated, with, on either hand, the Union Jack and the Egyptian flag. The left hand holds a laurel wreath, the right a palm branch. On a tablet below, SUDAN, and below this lotus leaves. Ribbon: Half black, half yellow, divided by a narrow red stripe (Plate I.). Clasp: none.

Given for the operations under the command of Sir Herbert (Lord) Kitchener, which led to the reconquest of the Sudan, 1898; issued in bronze to followers.

33. *Khedive's Sudan, 1896-1900*.—Awarded by the khedive in 1897. Obverse: "Abbas Hilmi II." and date, in Arabic. Reverse: A trophy of arms with a shield in the centre, on a tablet below "Recovery of the Sudan," in Arabic. Ribbon: Yellow, with blue centre (Plate I.). Clasp: FIRKET, HAFIR, SUDAN, 1897; SUDAN, 1898; ABU HAMED, THE ATBARA, KHAR-TOM, GEDAREF, SUDAN, 1899; SUDAN, 1900; CEDID, BAHR-EL-GHAZAL, 1900-1902; TEROK, NYAM NYAM, T. O. O. I.

This medal was awarded to officers and men of the British Navy and Army, to the Egyptian Army engaged in the reconquest of the Sudan and (in bronze without clasps) to followers.

34. *Cape Colony General Service, 1900*.—Awarded by the government of Cape Colony. Obverse: Bust of Queen Victoria as on the Volunteer Long Service Medal. Reverse: Arms of Cape Colony. Ribbon: Dark blue, with yellow centre (Plate II.). Clasp: BASUTOLAND, TRANSKEL, BECHUANALAND. Issued to Colonial troops only, for services in various minor campaigns.

35. *Matabeleland, 1893*.—Awarded by the British South Africa Company, 1896. Obverse: Bust of Queen Victoria. Reverse: A fighting lion. Ribbon: Orange, with three dark blue stripes (Plate II.). Clasp: RHODESIA and MASHONALAND, with dates.

This is the first war medal issued by a chartered company since the close of the Company's rule in India. It was awarded to British officers and men of the British service, to the Cape Mounted Rifles, Bechuanaland police, and the Chartered Company's own forces, engaged in the Matabeleland and Mashonaland Campaigns 1893, 1894, and 1897.

36. *East and Central Africa, 1891-98*.—Awarded by Queen Victoria in 1895. Obverse and Reverse: as in West African (or original Ashantee) Medal described above. Ribbon: Terra-cotta, white and black stripes (Plate II.). Clasp: CENTRAL AFRICA, 1894-96; CENTRAL AFRICA, 1899.

This medal only differs from the West African in that it has a different ribbon. It is suspended by a ring. Practically only the local forces (and of course their British officers) received this medal. But a few officers and men of the Indian Army and of the Royal Navy have also received it.

37. *East and Central Africa, 1899 (the "Uganda" Medal)*.—Awarded by Queen Victoria in 1899. Obverse: Half-length effigy of Queen Victoria, by De Saullès. Reverse: Britannia with lion, gazing over a desert towards a rising sun. Ribbon: Half red, half yellow (Plate II.). Clasp: LUBWA'S, UGANDA, 1897-98; UGANDA, 1899; UGANDA, 1900.

This medal was awarded to the local forces and also to officers and men of the Indian Army and Royal Navy.

38. *Ashanti Star, 1896*.—Awarded by Queen Victoria in 1896. Obverse: An imperial crown with "Ashanti, 1896" round it. Reverse: Inscribed "from the Queen." The star is four-pointed, and is crossed by a saltire or St Andrew's cross. Ribbon: Yellow with black stripes (Plate II.).

This medal was issued for the expedition against Prempeh in 1896. As there was no actual fighting, no medal was given, but sickness claimed many victims, amongst them Prince Henry of Battenberg. The decoration was issued to officers and men of the British Army, Royal Navy and local troops.

39. *Ashanti Medal, 1900*.—Awarded by King Edward VII. in 1901. Obverse: Head and bust of King Edward VII. in the uniform of a field-marshal, by De Saullès. Reverse: A lion standing on a cliff, in the background the rising sun. Ribbon: Green with black edges and black central stripe (Plate II.). Clasp: KUMASSI.

This medal was the first which was issued with an effigy of King Edward VII. It was given only to local forces, and the British officers employed on the staff or in commands.

40. *Africa General Service, 1899*.—Awarded by King Edward VII. in 1902. Obverse: As in Ashanti Medal of 1900. Reverse: As in "Uganda" Medal above described. Ribbon: Yellow, with black edges and two narrow green stripes (Plate II.). Clasp: N. NIGERIA, with various dates; S. NIGERIA, with various

dates; UGANDA, 1900; JUBALAND, GAMBIA, LANGO, 1901 and 1902; JIDBALLI, KISSI, 1905; SOMALILAND, 1901 and 1902-04; BRITISH CENTRAL AFRICA, 1899-1900; ARO, 1901-02.

This medal represents an almost incessant warfare of a minor, but exacting, nature. In the first eighteen months, eleven clasps were awarded, some awards being of course retrospective. The clasp "Jubaland" is chiefly a naval award, but all the rest are almost entirely confined to the West African Frontier Force and the King's African Rifles. It is worthy of remark that a contingent of Boer mounted riflemen took part in the Somaliland Campaign, within one year of the peace of Vereeniging, and received the medal and clasp. The "Somaliland, 1902-1904" clasp represents indeed a considerable campaign in which contingents from Great Britain and India took part.

41. *Queen's South African, 1899-1902*.—Awarded by King Edward VII. in 1901 shortly after Queen Victoria's death. Obverse: Bust of Queen Victoria, by De Saullès. Reverse: Britannia holding an outstretched laurel wreath towards a body of troops, in the background a coast line, the sea and war-ships. Ribbon: Centre orange bordered with blue, outside edges red (Plate II.). Clasp: see below.

The "Queen's" medal for troops engaged in the South African War was authorized, shortly after Queen Victoria's death, by Army Order 94 of 1901. It was given "to all officers, warrant officers, non-commissioned officers and men, of the British, Indian and Colonial forces, and to all Nurses and Nursing Sisters, who actually served in South Africa between 11th of October 1899, and a date to be fixed hereafter" (the war not being concluded) "to all troops stationed in Cape Colony and Natal at the outbreak of hostilities, and to troops stationed at St Helena between the 14th of April 1900, and a date to be fixed hereafter." The last provision shows a widening of the signification hitherto attaching to "war service," for the troops at St Helena were employed in guarding Boer prisoners. The A.O. referred to was supplemented by others in 1901 and 1902. Clasps were authorized as follows: BELMONT (Nov. 23, 1899); MODDER RIVER (Nov. 28, 1899); PAARDE-WEPEN (Feb. 17-26, 1900); DREIFONTAIN (March 10, 1900); WOPENER (Apr. 25, 1900); JOHANNESBURG (May 29, 1900); DIAMOND HILL (June 11-12, 1900); BELFAST (Aug. 26-27, 1900); WITTEBERGEN (July 1900); DEFENCE OF KIMBERLEY (Oct. 14, 1899, Feb. 15, 1900); RELIEF OF KIMBERLEY (Feb. 15, 1900); DEFENCE OF MAFEKING (Oct. 13, 1899-May 17, 1900); RELIEF OF MAFEKING (May 17, 1900); TALANA (Oct. 20, 1899); ELANDS-LAAGTE (Oct. 21, 1899); DEFENCE OF LADYSMITH (Nov. 3, 1899-Feb. 28, 1900); TUGELA HEIGHTS (Feb. 14-27, 1900); RELIEF OF LADYSMITH (Dec. 15, 1899-Feb. 28, 1900).

42. *LAING'S NEK (Lubwa's Nek)*.—Awarded by the CAPE COLONY, NATAL, ORANGE FREE STATE and RHODESIA, were given to troops who served within the limits of the respective colonies and states named during the war, without being present at any action, fought inside those limits, for which a clasp was awarded. Non-enlisted men, of whatever nationality, who drew military pay, were awarded the medal in bronze instead of silver and without clasps. Militia units which volunteered and were sent to Mediterranean stations to release the regulars for field service were awarded (Feb. 1902) the medal without clasp, "Mediterranean" being substituted for "South Africa" on the reverse. This was not, of course, issued to any one entitled to the Queen's Medal for South Africa.

43. *The King's South African Medal* was awarded by King Edward VII. in 1902, to be worn in addition to the "Queen's" by those who completed eighteen months' service in South Africa during the war. On the obverse of the medal is the effigy of King Edward, by De Saullès (as on the "Ashanti, 1900" Medal); the reverse is the same as that of the "Queen's" Medal. Ribbon: Green, with black stripe (Plate II.). The two clasps awarded were, in accordance with the terms of the award, general in character, to wit, SOUTH AFRICA, 1901 and SOUTH AFRICA, 1902.

44. *China, 1900*.—Awarded by King Edward VII. in 1902. Obverse: Bust of Queen Victoria as on "Queen's" South African Medal. Reverse: As on first China Medal, but with date altered. Ribbon: As in first China Medal (Plate I.). Clasp: DEFENCE OF LEGATIONS, RELIEF OF PEKIN, TAKU FORTS.

This medal was issued to the Royal Navy (including some Naval volunteers), British and Indian Armies, and the (Wei-hai-Wei) Chinese Regiment, for operations during the Boxer rebellion. This was the last war medal as the "First Africa, 1902" to bear Queen Victoria's effigy. Sir E. H. Seymour, the commander of the Tientsin relieving column, who had taken part in the former China War, received the new medal as well as the old.

45. *India, 1895 (Third India General Service)*.—Awarded by Queen Victoria in 1896. Obverse: Bust of Queen Victoria, by T. Brock R.A. Reverse: A British and Indian soldier supporting a standard; below, INDIA, 1895. Ribbon: Three red and two green stripes of equal width (Plate I.). Clasp: DEFENCE OF CHITRA, 1895; RELIEF OF CHITRAL, 1895; MALAKAND, 1898; PUNJAB FRONTIER, 1898; TIRAH, 1897; TIRAH, 1898; WAZIRISTAN, 1901-02.

The ribbon of this medal is perhaps more frequently seen than

¹ Awarded to Egyptian Army only.

that of any other British war medal except those for South Africa. In 1903 the medal was re-issued with the military effigy of King Edward VII. (as on the Ashanti, 1900, medal) on the obverse, and the date was omitted from the reverse. The medal is issued in bronze, without clasps, to followers.

46. *Tibet, 1903-04*.—Awarded by King Edward VII in 1905. Obverse: Military effigy of the king as on Ashanti, 1900, medal. Reverse: a representation of the Potala at Lhasa. Ribbon: Purple-red, edged with green and white stripes (Plate II.). Clasp: GYANTSE.

47. *India, 1908*.—A new India General Service Medal was authorized in 1908, to take the place of the medal granted by A.O. 43 of 1903. This was to be issued in silver to officers and men, and in bronze to non-enlisted men of all sorts. This medal with clasp bearing the name and date was given to the troops which took part in the North Western Frontier Expedition of 1908. The ribbon is dark blue edged with green.

48. *Transport Medal*.—Awarded by King Edward VII. in 1902. Obverse: Head and bust of the king in naval uniform, by De Saules. Reverse: A steamer at sea, and the five continents. Ribbon: red, with two thin stripes near the edge (Plate II.). Clasps: SOUTH AFRICA, 1899-1902; CHINA, 1900. This medal is restricted to officers of the mercantile marine serving in chartered troop-ships. It is a sort of general service medal, clasps being added as earned. Up to 1910 only the above clasps had been authorized.

49. *Polar Medal (or Antarctic Medal)*.—Awarded by King Edward VII, 1904. Obverse: Naval effigy of the king as on Transport Medal. Reverse: In the foreground a sledge and travelers, in the background the steamer "Discovery" (Capt. R. F. Scott's Expedition, 1904). Ribbon: As for 1st and 2nd Arctic Medals, white (Plate I.). The medal, like the Arctic Medal, is octagonal.

First awarded to officers and men of the "Discovery" whether belonging to the Royal Navy or not. It is given with a dated clasp for Antarctic exploration service.

Other Medals and Decorations.—The above forty-nine medals are given as rewards for participating in the operations they commemorate, and issued generally to all concerned, irrespective of individual distinction or bravery. There are other classes of medals and decorations, civil as well as military, which must be grouped with them, as being allied in character. These are either (i.) awards personal to the recipient, being an acknowledgment of reward for special individual services or good conduct (these are civil as well as military in respect of awards for bravery), or (ii.) awards that are simply of a commemorative kind, though worn as war medals and for the most part given to officers and soldiers. The more important of these two classes will be named. *Orders* given for service are dealt with, for the most part in the article KNIGHTHOOD; but particulars are given here of certain distinctively military orders that have no knighthood rights and duties, and indeed little meaning apart from the deeds or services which led to the award—being so to speak, records of the past, rather than badges of a present membership. Individual decorations for services may be classed as (i.) for gallantry, (ii.) for special merit, and (iii.) for long service and good conduct.

1. *Indian Order of Merit*.—Awarded by H.E.I. Company and notified by G.O. of governor-general, April 17, 1837. Obverse: 1st Class—A gold star, $\frac{1}{2}$ inch in diameter, in the centre, in gold, with a round of dark blue enamel, crossed swords within a circle around which is the legend, REWARD OF VALOUR, the whole encircled by a gold laurel wreath. 2nd Class—Star similar to that of 1st Class, but in silver. Wreath and centre as in 1st Class. 3rd Class—Star exactly similar to that of 2nd Class, but the wreath and centre in silver, and dark blue enamel and silver, respectively. Reverse: Engraved 1st, 2nd and 3rd Class Order of Merit, respectively, but the name of the recipient is not engraved on the decoration when issued. Ribbon: Dark blue, with red edges. This decoration is to be obtained only by a "conspicuous act of individual gallantry in the field or in the attack or defence of fortified places. It is open to all native officers or soldiers of the Indian Army without distinction of rank or grade." The 3rd Class is bestowed for the first act of gallantry for which the recipient is recommended. The 2nd Class is given only to those who possess the third, and for a second act of conspicuous gallantry. The 1st Class is given only to those who hold the 2nd, and for a third act of bravery. A recipient of the decoration receives an additional allowance equivalent in the 3rd Class to one-third, in the 2nd to two-thirds, and in the 1st to the whole of the ordinary pay of his rank, over and above that pay or his pension. The widow (in the case of plurality of wives, the first married) receives the pension of the Order for three years after her husband's death.

2. *Victoria Cross*.—Instituted by Royal Warrant, January 29, 1856. A bronze Maltese Cross, $\frac{1}{2}$ inch in diameter, with, in the centre, the Royal Crest (lion and crown), and below it a scroll

inscribed "FOR VALOUR." There is a bronze laureated bar for suspension, connected with the cross by a V. The reverse is plain, but the name, rank and corps of the recipient are engraved on the back of the laureated bar. Ribbon: Red for the army; blue for the navy. Clasp: For every additional act of bravery a clasp, bearing the date of such act, may be awarded.

Nothing save the merit of conspicuous bravery "gives claim for the decoration, and it must be evinced by "some signal act of valour or devotion to their country" performed "in the presence of the enemy." (The regulation italicized was for a short time abrogated, but soon restored to force.) The original Royal Warrant has been supplemented by various Royal Warrants (Oct. 1857, Aug. and Dec. 1858, Jan, 1867, April and Aug. 1881), and now every grade and rank of all ranks of all branches of His Majesty's Forces, British and Colonial, are eligible, with the single exception of native ranks of the Indian army, who have an equivalent decoration in their own Order of Merit. In the case of recipients who are not of commissioned rank, the Cross carries with it a pension of £10 a year, and an additional £5 a year for each class. A larger grant is sometimes given to holders of the V.C. who are in need of monetary help. In all, up to 1904, the Cross was awarded to 521 recipients (including 15 posthumous awards).

3. *Distinguished Conduct in the Field (Army)*.—Instituted by Royal Warrant, September 30, 1862. Obverse: A military trophy, with, in the centre, the Royal Arms (as in the Long Service and Good Conduct Medals). Reverse: inscribed "FOR DISTINGUISHED CONDUCT IN THE FIELD." Ribbon: Three stripes equal width, outside red, centre blue (Plate II.). Clasp: Royal Warrant, 7th of February 1881, authorized award of clasps for subsequent acts of gallantry.

Individual acts of distinguished conduct in the field in any part of the world "entitle to this medal, and only non-commissioned officers and men of the British forces are eligible for the award. Prior to its institution, distinguished gallantry was rewarded by the "Meritorious Service" medal. Single clasps have been constantly conferred, and there is more than one case of a recipient having earned two clasps to his medal.

4. *Albert Medal (for saving life at sea)*.—Instituted by Royal Warrant, 7th of March 1866. Gold oval badge, enamelled in dark blue, with a monogram composed of the letters V and A, interlaced with an anchor, erect, in gold, surrounded with a garber in bronze, inscribed "FOR BRAVERY AT SEA." FOR GALLANTRY IN VARIOUS AT SEA," and surmounted by a representation of the crown of the prince consort, the whole edged with gold. Ribbon: dark blue, with two white stripes. Clasps are awarded for any subsequent acts of bravery. By a subsequent Royal Warrant of the 12th of April 1867, the decoration was re-constituted in two classes, as follows. 1st Class—Badge precisely as already described. Ribbon: Dark blue, with four white stripes ($\frac{1}{2}$ inch wide). Clasps: As authorized in original warrant. 2nd Class—Badge exactly similar to that of the 1st Class, except that it is entirely worked in bronze, instead of gold and bronze. Ribbon: Dark blue, with two white stripes. Clasps: As authorized for 1st class.

The decoration is awarded only to those who "have, in saving or endeavouring to save the lives of others from shipwreck or other peril of the sea, endangered their own lives." The 1st Class is confined "to cases of extreme and heroic daring"; the 2nd for acts which, though great courage may be shown, are not sufficiently distinguished to deserve "the 1st Class of the decoration.

5. *New Zealand Cross*.—Instituted by an Order of the governor of New Zealand in council, 10th of March, 1869. Silver Maltese Cross with gold star on each of the four limbs and in the centre, in a circle within a gold laurel wreath, NEW ZEALAND. Above the Cross a crown in gold, and connected the top by a V, to a silver bar ornamented with laurel in gold. The name of recipient is engraved on reverse. Width of Cross, $\frac{1}{2}$ inch. Ribbon: Crimson. Clasps: Authorized for subsequent acts of valour. In authorizing this decoration Sir G. F. Bowen, the then governor, went outside his authority, but the queen ratified the colonial order in council, and intimated "Her gracious desire that the arrangements made by Her direct authority" it was, however, stipulated that the occasion was in no way to form a precedent. The award was to be for those "who may particularly distinguish themselves by their bravery in action, or devotion to their duty while on service," and only local "Militia, Volunteers, or Armed Constabulary" were to be eligible. In all only nineteen of these decorations were awarded. No clasps were awarded.

6. *Conspicuous Gallantry (Navy)*.—Instituted by an Order of the queen in Council, 7th of July, 1874. Obverse: Head of Queen Victoria, by W. Wyon, R.A. (as on China Medal). Reverse: A laurel wreath, and within FOR CONSPICUOUS GALLANTRY. Above, a crown. Ribbon: Three stripes of equal width, outside blue, centre white (Plate II.). Clasps: none authorized.

To reward "acts of pre-eminent bravery in Action with the Enemy." Only petty officers and seamen of the Royal Navy,

1 Now naval effigy of King Edward VII., as on Transport Service Medal.

and non-commissioned officers and privates of the Royal Marines, are eligible for this decoration. Prior to the institution of this decoration, acts of gallantry by sailors and marines were rewarded by the same medal as that given to the army before the "medal for distinguished conduct in the field" was instituted, viz. the "Meritorious Service" medal. If the holder be a Chief or First Class Petty Officer, or a Sergeant of Marines, the award carries with it an annuity of £20 per annum; and if a recipient's service end before reaching one of those ranks, he may receive a gratuity of £20 on discharge.

7. *Albert Medal* (for saving life on land).—Instituted by Royal Warrant, 30th of April 1877. 1st Class—Similar to that of the 1st Class for saving life at sea, but the enamelling is in red instead of blue, and there is no anchor interlaced with the monogram V.A. Ribbon: Crimson, with four white stripes. Clasp: for subsequent acts of same character. 2nd Class—Badge similar to that of the 2nd Class for saving life at sea, but the enamelling is in red instead of blue, and there is no anchor interlaced with the monogram V.A. Ribbon: Crimson, with two white stripes. Clasp: As authorized for 1st Class.

The conditions governing the award of this decoration are the same that govern the award for saving life at sea. Originally the award was restricted to acts of gallantry performed within British dominions, but this restriction was removed by Royal Warrant, 5th of June 1905.

8. *Distinguished Conduct in the Field (Colonial)*.—Instituted by a Royal Warrant, 24th of May 1894, which was later cancelled and superseded by Royal Warrant, 31st of May 1895. Obverse: same as the "Distinguished Conduct in the Field" (Army). Reverse: same as "Army" medal, but with the name of the colony inscribed above the words "For Distinguished Conduct in the Field." Ribbon: Crimson, with a line of the colonial colour in the centre. Clasp: Authorized for subsequent acts of valour. Every colony or protectorate, having permanently embodied forces, draws up regulations to govern the issue of these medals as suit its own particular requirements, but in all essentials these regulations are modelled on those that govern the award of the Distinguished Conduct in the Field (Army).

9. *Conspicuous Service Cross*.—Instituted by an Order in Council, 15th of June 1901. Silver cross, with the reverse side plain; on the obverse, in the centre, the Imperial and Royal Cypher, E.R.I., surmounted by the imperial crown. Ribbon: Three stripes equal width, outside white, centre blue. Clasp: none authorized.

This award is to recognize "Distinguished Service before the Enemy." Its grant is confined to "Warrant Officers or Subordinate Officers" of the Royal Navy. Such, not being of "lower-deck rating," are not eligible for the "Conspicuous Gallantry" medal; also, they, by reason of not holding a commission in the Royal Navy, are not eligible to any existing Order or Decoration.

10. *Edward Medal*.—Founded in 1907 to reward acts of courage in saving life in mines, this medal was extended in 1909 (R.W. Dec. 3) so as to be awarded "to those who in course of industrial employment endanger their own lives in saving or endeavouring to save the lives of others from perils incurred in connexion with such industrial employment."

Certain important medals and decorations for saving life are not the gift of the Crown. These are allowed to be worn in uniform on the right breast. They are the medals of the Royal Humane Society, those given by the Board of Trade for gallantry in saving life at sea, the medals of the Royal National Lifeboat Institution, those of the Shipwrecked Fishermen and Mariners' Royal Benevolent Society, Lloyd's Honorary Silver Medal, Liverpool Shipwrecked and Humane Society's Medals, and the Stanhope Gold Medal.

All these are suspended from a dark blue ribbon with the exception of the medals of the S.F. and M. Royal Benevolent Society, which has a light blue ribbon, and the Stanhope Gold Medal which has a broad dark blue centre, edged with yellow, and black borders. These medals are usually struck in silver or bronze, but occasionally gold medals are awarded. The Stanhope Gold Medal is annually awarded for the most gallant of all the acts of rescue for which the society have awarded medals during the year. This award has become frequently carried by officers or men of the Royal Navy. It is, in fact, the "Victoria Cross" of awards of this character.

The following are decorations for special merit:—

1. *Order of British India*.—Instituted by General Order of Governor-General of India, 17th of April 1837. 1st Class—A gold star of eight points radiated, 1½ in. in diameter, between the two top points the crown of England. In the centre, on a band of light blue enamel, a gold lion statant, within a band of dark blue enamel, containing in gold letters ORDER OF BRITISH INDIA. The whole is encircled by a gold laurel wreath. The whole hangs from the ribbon by a gold loop attached by a ring to the top of the crown, and is worn round the neck, outside the uniform. Ribbon: originally sky-blue, changed to crimson 1838. 2nd Class—Gold star similar to that of the 1st Class, but smaller, 1½ in. diameter,

and without the crown. The centre also is similar to that of the 1st Class star, but the enamelling is all dark blue. Suspended and worn as in the 1st Class. Ribbon: As in 1st Class.

This, the highest military distinction to which in the ordinary course native officers of the Indian Army can attain, and confined to them, is a reward for long, honourable and specially meritorious service. The 1st Class is composed exclusively of officers of and above the rank of Subadar in the artillery and infantry, or of a corresponding rank in the other branches of the service. The 2nd Class is open to all native commissioned officers, irrespective of their rank. Originally the order was limited to 100 in the 1st Class and the same number in the 2nd, but it now comprises 215 in the 1st Class and 324 in the 2nd Class. Officers in the 1st Class are entitled to the title of "Sirdar Bahadur," and receive a daily allowance of two rupees in addition to the pay, allowances or pension of their rank, while those of the 2nd Class are styled "Bahadur," and receive an extra one rupee per diem.

2. *Ability and Good Conduct*.—Instituted in 1842. Obverse: A paddle-wheel steamship. Reverse: Crown and anchor, and inscribed, FOR ABILITY AND GOOD CONDUCT. Ribbon: None authorized.

No official documents as regards the institution of this decoration are now to be found at the Admiralty, but only engineers were eligible for the award, and it carried no gratuity or annuity. Only six were ever awarded. When, in 1847, engineers were raised to the rank of warrant officers, the issue of this decoration was discontinued. It had a ring for suspension, and was probably worn with the narrow national blue ribbon of the "Long Service and Good Conduct" medal of the period.

3. *Meritorious Service (Army and Royal Marines)*.—Instituted by Royal Warrant, 19th December 1845, for army only; grant extended to Royal Marines by Order in Council, 15th January 1849. Obverse: Head of Queen Victoria as on China medal. Reverse: FOR MERITORIOUS SERVICE, within a laurel wreath. Ribbon: Crimson for army (Plate II.); navy blue for Royal Marines. Only non-commissioned officers of or above the rank of sergeant are eligible for this decoration. It carries with it an annuity of £20 per annum; but, as the total sum available is strictly limited, the number of these medals that is issued is small, and a non-commissioned officer who is recommended may have to wait many years before his turn comes and he receives the award. The qualification for recommendation is long, efficient and meritorious service, and need not necessarily, although in many cases it does, include any special display of personal gallantry in action. For many years the "meritorious service" medal was considered to cancel the "long service and good conduct" medal, but by A.O. 250 of 1902 both medals can be worn together.

4. *The Distinguished Service Order* (see KERRIDGE 1800) is given only to officers (and naval and military officials of officer rank, not including Indian native officers) for services in war. Often it is the reward of actual conspicuous gallantry under fire, but its purpose, as defined in the Royal Warrant instituting the order, is to reward "individual instances of meritorious or distinguished service in war;" and the same document declares that only those shall be eligible who have been mentioned "in despatches for meritorious or distinguished service in the field, or before the enemy." In the main, therefore, it is awarded for special services in war, and not necessarily officers; and, although the services rewarded are as a fact generally rendered in action, the order is in no sense a sort of second class of the Victoria Cross. Like the latter, the Distinguished Service Order is generally referred to by its initials.

5. *The Royal Red Cross* is also an Order. Membership is restricted to women (not necessarily British subjects), and is given as a reward for naval or military nursing service. Instituted 1883.

6. *The Kaisar-i-Hind Medal* is given for public services in India. 7. *The Volunteer Officers' Decoration*.—Instituted in 1892. An oval of silver, crossed at intervals with gold, in the centre the monogram V.R. and crown in gold. Worn from a ring. Ribbon: Dark green.

This decoration was instituted in 1892, and is the reward of twenty years' service in the commissioned ranks of the volunteer force. It is generally called the "V.D." Since the conversion of the Volunteer into the Territorial Force (1908) it has been replaced by THE TERRITORIAL OFFICERS' DECORATION. Officers of the Royal Naval Reserve and of the Royal Naval Volunteer Reserve are eligible for a similar decoration (1910).

8. *The Long Service and Good Conduct (Army) Medal* was instituted in 1873. Obverse: A trophy of arms. Reverse: FOR LONG SERVICE AND GOOD CONDUCT. Ribbon: Crimson, as for "Meritorious Service" medal (Plate II.).

This is a reward for "long service with irreproachable character and conduct," the qualifying period of service being 18 years.

¹ Now naval effigy of King Edward VII., as on Transport Service medal.

² Either "Meritorious" or "Long Service" medals worn with a crimson ribbon are the former Long Service medal of the H.E.I. Company's European troops and the Meritorious and Long Service medals of the Indian Native Army.

³ Now replaced by military effigy of King Edward VII.

9. The *Long Service and Good Conduct (Navy) Medal* was instituted in 1831. Ribbon: Blue, with white edges (Plate II.).

10. The *Volunteer Long Service Medal*.—Instituted in 1894. Has a green ribbon. Obverse: Effigy of Queen Victoria. Reverse: A scroll within a wreath, inscribed FOR LONG SERVICE IN THE VOLUNTEER FORCE. Replaced by the *Territorial Long Service Medal* (1908), of which the ribbon is green with a yellow centre; and the obverse a bust of the king. The *Militia Long Service Medal* (1904) has a light blue ribbon, the *Imperial Yeomanry Long Service Medal* a yellow ribbon, the *Honourable Artillery Company's Medal* a black, red and yellow ribbon. All these are shown on Plate II.¹

11. The Medal for the *Best Shot in the Army* was instituted in 1869. Obverse: Bust of Queen Victoria (now effigy of King Edward VII.). Reverse: A winged Victory crowning a warrior. Ribbon: Red, with two narrow black stripes on each edge, the two black stripes being divided by a narrow white one. There is also a "Best Shot" Medal for the Indian Native Army, which has an orange ribbon.

12. The Medal for *Naval Gunnery* was instituted in 1903. Ribbon: Red centre, flanked by two narrow white stripes, two broad blue stripes at edges (Plate II.).

Amongst medals of the last class may be mentioned the *Jubilee Medals* of 1887 and 1897, the *Coronation Medal* of 1902, the *Royal Victorian Medal* (this, however, is a sort of sixth class of the Royal Victorian Order, for which see KNIGHTHOOD) and the medals awarded for Durbars.

United States.—The war medals and decorations of the United States, although few in number, are interesting, as they follow a peculiar system in the colours of the ribbons.

The principal military decoration of the United States is the "Medal of Honor," which was founded for the reward of unusual bravery or special good conduct during the Civil War. In its present form it is a five-pointed star, with a medallion in the centre bearing a head of Minerva and round it UNITED STATES OF AMERICA in relief. On each ray of the star is an oak-leaf, and the points themselves are trefoil shaped. A laurel wreath, in green enamel, encircles the whole, and this wreath is surmounted by VALOR, which in turn is surmounted by an eagle that attaches the decoration to its ribbon. This last is blue, with thirteen white stars worked on it in silk. Accompanying this decoration there is a badge of lapel button, hexagonal, and made of blue silk with the thirteen stars in white.

The original form of the decoration had no encircling wreath; on the rays, instead of the oak-leaves, were small wreaths of laurel and oak, and the design in the central medallion was a figure of Minerva standing, with her left hand resting upon a cornucopia of fescues and her right warding off with a shield the figure of Discord. The background was formed by thirty-four stars. The decoration was surmounted by a trophy of crossed guns, swords, &c., with eagle above, and the ribbon was designed of the national colours, as follows: thirteen alternate red and white stripes, and across the ribbon at the top a broad band of blue (palewise gules and argent and a chief azure). The ribbon was attached to the coat by a clasp badge bearing two cornucopias and the arms of the U.S. The present decoration does not have this badge, but is suspended from a concealed bar brooch.

Another special decoration is the "Merit" Medal. This bears on the obverse an eagle, surrounded by the inscription VIRTUTIS ET AVDACIAE MÓNVMENTVM ET PRAEMIVM, and on the reverse the inscription FOR MERIT, surrounded by an oak-leaf wreath; in the upper part of the exergue is UNITED STATES ARMY, in the lower thirteen stars. The ribbon is red, white and blue, in six stripes, two red stripes divided by a fine white line in the centre, two white on either side of the red and two blue forming the two outer edges.

We come now to the war medals proper, issued generally to all those who took part in the events commemorated.

The Civil War Medal bears on the obverse the portrait of Lincoln, surrounded by an inscription taken from his famous Second Inaugural—WITH MALICE TOWARDS NONE, WITH CHARITY FOR ALL. On the reverse is the inscription THE CIVIL WAR, 1861-1865 surrounded by a wreath of oak leaves and olive branches. The ribbon is somewhat similar to that last described; the blue stripe, however, is in the centre, divided as before by a white line, and the red stripes form the outer edges.

The "Indian Wars" Medal is interesting from the fact that its reverse was copied on other medals, this making it, in a sense, a "general service" medal. On the obverse is a mounted Indian in full costume bearing a spear, and the upper part of the exergue INDIAN WARS, in the lower a buffalo's skull with arrowheads on either side. What we have called the "general service" design

¹By Royal Warrant of 31st of May 1895, medals both for distinguished conduct in the field and for long service were authorized to be awarded by the various colonies possessing regular or volunteer troops, "under regulations similar, as far as circumstances permit, to those now ranking for Our Regular and Auxiliary Forces."

on the reverse is composed of (a) an eagle perched on a cannon, supported by five standards (typifying the five great wars of the United States), rifles, Indian shield, spear and arrows, Filipino dagger and Cuban machete; (b) behind this trophy the words FOR SERVICE; (c) in exergue, above, UNITED STATES ARMY, below, thirteen stars.

Ribbon of the Indian Medal, vermilion, with deep red edges. The "War with Spain" Medal bears on the obverse a castle with two flanking towers; in exergue, above, WAR WITH SPAIN, below, the date 1898, with, on one side of it, a branch of the tobacco-plant, and on the other a sugar-cane. Reverse: As for "Indian Wars" Medal. Ribbon: Centre golden-yellow, with two red stripes close to the edges, the edges themselves being narrow strip of blue.

The "Philippine Insurrection" Medal bears on the obverse a coco-nut palm tree, with, on the left of it, a lamp (typifying Enlightenment), and on the right a balance (representing Justice). This is encircled by the inscription PHILIPPINE INSURRECTION 1899. The ribbon is blue, with two red stripes near the edges. Reverse: As in "Indian Wars" Medal.

Another medal connected with the Filipino insurrection is the so-called "Congressional" Medal, which was designed to commemorate the participation in the war of regulars and volunteers, Northerners and Southerners, side by side. On the obverse is a colour-carryer of the infantry with the national flag, the fly of the flag extending almost to the edge of the medal. Below is the date 1899, and above, in a semicircle, PHILIPPINE INSURRECTION. The reverse has the inscription FOR PATRIOTISM, FORTITUDE AND LOYALTY, surrounded by a wreath of oak-leaves (typifying the North) and palm branches (typifying the South). The ribbon is blue, edged by narrow stripes of the national colours, the blue being nearest the edge and the red nearest the centre.

The "China Relief" Medal bears on the obverse a Chinese dragon, surrounded by the inscription CHINA RELIEF EXPEDITION, and at bottom, the date 1900-1. Reverse: As for "Indian Wars" medal. Ribbon: Lemon-yellow, with narrow blue edges.

It is interesting to note that in the case of two of these medals the national colours of the enemy (Spain and China) furnish those of the ribbon. The national colours adopted by the Filipinos were red and blue, and these also figure, in spite of their similarity to the U.S. national colours, on the ribbon of the "Indian Wars" and "Congressional" Medals. The Indian ribbon is, similarly, of the colour of the enemy's war paint—vermilion. See, for illustrations and further details of all these medals and decorations, *Journal of the [U.S.] Military Service Institution*, May-June 1909. Some of the badges of membership of associations of veterans, such as the *Loyal Legion*, are allowed to be worn as war medals in uniform. The "Rescue" Medal, in gold or silver, is awarded for bravery in saving life by land or sea.

Other Countries.—As has been mentioned above, foreign decorations for military service usually take the form of Orders in many classes. There are, however, numerous long service decorations, which need not be specified. The most famous of the European war and service decorations are the Prussian Iron Cross, the French *Médaille Militaire*, and the Russian St George's Cross; all these are individual decorations.

The *Iron Cross* is given to officers and soldiers for distinguished service in war. It was founded, in the enthusiasm of the War of Liberation movement, on the 10th of March 1813, and revived at the outbreak of the "War for Unity" against France, 19th of July 1870. The cross is a Maltese cross of cast iron edged with silver. The 1813-15 crosses have the initials F. W. (Friedrich Wilhelm) in the centre, a crown in the upper limb of the cross, and the date in the lower. Those of 1870 have W. (Wilhelm) in the centre, crown on the upper and date on the lower limb of the cross. There are certain distinctions between the Grand Cross, which is worn at the neck, the 1st Class Cross which is worn as an Order suspended from a ribbon, and the 2nd Class Cross, which is worn on the breast. In 1870 war medals were given, bearing on the obverse a Maltese cross superposed on a many-pointed star, and having in its centre 1870-1871 within a wreath. The reverse has W. and a crown, with, for combatants the inscription *Dem siegreichen Heere*, and for non-combatants *Für Pflichttreue im Kriege*, in each case surrounded by the words *Gott war mit uns Ihm sei die Ehre*. The award of the Iron Cross to the rank and file carries with it an allowance of 3-6 marks monthly. (H. L. S. C. F. A.)

MEDEA (Gr. Μήδεια), in Greek legend, a famous sorceress, daughter of Aetes, king of Colchis. Having been thrown into prison by her father, who was afraid of being injured by her witchcraft, she escaped by means of her art and fled to the temple of Helios the Sun-god, her reputed grandfather. She fell in love with Jason the Argonaut, who reached Colchis at this time, and exacted a terrible revenge for his faithlessness (see ARGONAUTS and JASON). After the murder of Jason's

second wife and her own children, she fled from Corinth in her car drawn by dragons, the gift of Helios, to Athens, where she married king Aegeus, by whom she had a son, Medus. But the discovery of an attempt on the life of Theseus, the son of Aegeus, forced her to leave Athens (Apollodorus i. 9, 28; Pausanias ii. 3, 6-11; Diod. Sic. iv. 45, 46, 54-56). Accompanied by her son, she returned to Colchis, and restored her father to the throne, of which he had been deprived by his own brother Perses. Medus was regarded as the eponymous hero and progenitor of the Medes. Medea was honoured as a goddess at Corinth, and was said to have become the wife of Achilles in the Elysian fields. The chief seat of her cult, however, was Thessaly, which was always regarded as the home of magic. As time went on her character was less favourably described. In the case of Jason and the Argonauts, she plays the part of a kindly, good-natured fairy; Euripides, however, makes her a barbarous priestess of Hecate, while the Alexandrian writers depicted her in still darker colours. Some authorities regard Medea as a lunar divinity, but the ancient conception of her as a Thessalian sorceress is probably correct. The popularity of the story of Jason and Medea in antiquity is shown by the large amount of literature on the subject. The original story was probably contained in an old epic poem called *Μέδεια ῥοιῶτις*, the authorship of which was ascribed to Prodicus of Phocaea. It is given at some length in the fourth Pythian ode of Pindar, and forms the subject of the *Argonautica* of Apollonius Rhodius. There is a touching epistle (*Medea to Jason*) in the *Heroides* of Ovid. Medea is the heroine of extant tragedies of Euripides and Seneca; those of Aeschylus and Ennius (adapted from Euripides) are lost. Neophron of Sicyon and Melanthius wrote plays of the same name. Among modern writers on the same theme may be mentioned T. Corneille, F. Grillparzer and M. Cherubini (opera).

The death of Glauce and the murder of her children by Medea was frequently represented in ancient art. In the famous picture of Tomomachus of Byzantium Medea is deliberating whether or not she shall kill her children; there are copies of this painting in the mural decorations of Herculaneum and Pompeii.

See Léon Mallinger, *Médée: étude sur la littérature comparée*, an account of Medea in Greek, Roman, middle age and modern literature (1898); and the articles in Daremberg and Saglio's *Dictionnaire des antiquités* and Roscher's *Lexikon der Mythologie*.

MEDELLIN, a city of Colombia and capital of the department of Antioquia, 150 m. N.W. of Bogota, on a plateau of the Central Cordillera, 4823 ft. above sea-level. Pop. (1906 estimate), 50,000. Medellín, the foundation of which dates from 1674, stands in the valley of the Porce, a tributary of the Cauca, and is reputed to be one of the healthiest as well as one of the most attractive cities of the republic. It has a university, national college, school of mines and other educational institutions, assaying and refining laboratories, a public library and a mint. The principal industry of the surrounding country is mining, and gold and silver are exported in considerable quantities. Coffee and hides are also exported, but the trade of the city has been greatly impeded by difficulties of transportation. A railway from Puerto Berrio, on the Magdalena, was begun many years before the end of the 19th century, but political and financial difficulties interposed and work was suspended when only 43 m. were finished. The completion of the remaining 80 m. was part of a larger scheme proposed in 1906 for bringing the Cauca Valley into railway communication with the national capital.

MEDEMBLIK, a seaport of Holland, on the Zuider Zee, the terminus of a branch railway from Hoorn, 10½ m. S. Pop. (1903), 3012. Once the capital of West Friesland and a prosperous town, many of its streets and quays are now deserted, though the docks and basins constructed at the end of the 16th and beginning of the 17th centuries could still afford excellent accommodation for many ships. Close to the harbour entrance stands the castle built by Florens V., count of Holland, in 1285. It has been restored, and is used as a court of justice. The

West church, formerly called after St Boniface, the apostle of Germany, was once the richest in Friesland, and belonged from an early date to the cathedral chapter at Utrecht, where, until the Reformation, the pastor of Medemblik had a seat in the cathedral. It contains the tomb of Lord George Murray (q.v.). Among the public buildings are the town-hall (17th century), weigh-house, orphanage, the old almshouse, the house (1613) of the Water Commissioners, and a large building formerly belonging to the admiralty and now used as a state lunatic asylum. There are many interesting brick houses, dating chiefly from the first half of the 17th century, with curious gables and picturesque ornamentation, carvings and inscriptions.

MEDFORD, a city, including several villages, of Middlesex county, Massachusetts, U.S.A., on the Mystic river and Lakes, 5 m. N. by W. of Boston. Pop. (1900), 18,244, of whom 4327 were foreign-born; (1910 census) 23,150. The city is served by the Southern Division and a branch of the Western Division of the Boston & Maine railroad, and is connected with Boston and neighbouring cities by electric railways. The Mystic River, a tidewater stream, is navigable for small craft as far as the centre of the city. There are manufactures of considerable importance, including bricks and tiles, woollen goods, carriages and wagons, food products, iron and steel building materials and machinery. The city covers a land area of about 8 sq. m., along the Mystic river, and extending to the hills. The western portion borders the Upper and Lower Mystic Lakes, which are centres for boating. In the north-west portion of Medford is a part of the Middlesex Fells, a heavily wooded reserve belonging to the extensive Metropolitan Park System maintained by the state. The broad parkways of this system also skirt the Mystic Lakes, and here is the greater part (1907, 267 out of 291 acres) of the Mystic River Reservation of the Metropolitan System. Among the city parks are Hastings, Brooks, Logan, Tufts and Magoun. Within the city limits are some of the oldest and most interesting examples of colonial domestic architecture in America, including the so-called "Cradock House" (actually the Peter Tufts house, built in 1677-1680), the "Wellington House," built in 1657, and the "Royall House." The last was built originally by Governor John Winthrop for the tenants of his Ten Hills Farm, and was subsequently enlarged and occupied by Lieut.-Governor John Usher, and by Isaac Royall¹ (c. 1720-1781) and his son, Isaac Royall, Jun.

Medford has a public library of about 35,200 volumes, housed in the colonial residence (reconstructed) of Thatcher Magoun. The city has also a city hall, a high school and manual training school, an opera house, and one of the handsomest armory buildings in the country (the home of the Lawrence Light Guard), presented by General Samuel C. Lawrence (b. 1832), a liberal benefactor of Medford institutions and the first mayor of the city (1802-1894). The Salem St. Burying Ground, dating from 1689, is one of the oldest burial places in America. The Medford Historical Society maintains a library and museum in the birthplace of Lydia Maria Child. Medford is the seat of Tufts College, planned and founded as a Universalist institution in 1852 by Hosea Ballou, its first president, and others, and named in honour of Charles Tufts (1781-1876), a successful manufacturer, who gave the land on which it stands. The college, which had 1120 students and 217 instructors in 1909, comprises a college of letters, a divinity school, and a school of engineering (all in Medford), and medical and dental schools in Boston; it is now undenominational. Among the twenty college buildings, the Barnum Museum of Natural History (1885) founded by Phineas T. Barnum, and the Eaton Memorial Library (1907), presented by Mrs Andrew Carnegie in memory of her pastor, are noteworthy. The college endowment amounted in 1908 to \$2,300,000.

Medford was first settled in 1630. A considerable portion of its area formed the plantation of Matthew Cradock (d. 1641), first governor of the Massachusetts Bay Company, who in 1630¹ a prominent Loyalist, whose estate was seized during the War of Independence, but was restored to his heirs about 1800. He endowed the first professorship of law in America—at Harvard College.

sent out agents to settle his lands. John Winthrop's "Ten Hills Farm," partly within the present limits of Medford, was settled soon afterwards. One of the earliest industries was ship-building, John Winthrop's "Blessing of the Bay," built on the Mystic in 1631-1632, being one of the first keels laid on the continent. In 1802 Thatcher Magoun began building sea-going vessels, and many of the famous privateers of the War of 1812 were constructed here. By 1845 Medford employed fully a quarter of all the shipwrights of the state. The industry gradually lost its importance after the introduction of steamships, and the last keel was laid in 1873. Another early industry was the distilling of rum; this was carried on for two centuries, especially by the Hall family and, after about 1830, by the Lawrence family, but was discontinued in 1905. The manufacture of brick and tile was an important industry in the 17th century. The Cradock bridge, the first toll-bridge in New England, was built across the Mystic in 1638; over it for 150 years ran the principal thoroughfare, from Boston to Maine and New Hampshire. The course of Paul Revere's ride lay through Medford Square and High Street, and within a half-hour of his passage the Medford minute men were on their way to Lexington and Concord, where they took part in the engagements with the British. After the Battle of Saratoga many of Burgoyne's officers were quartered here for the winter. The Middlesex Canal was opened through Medford in 1803, and the Boston & Lowell railroad (now the southern division of the Boston & Maine) in 1831. Medford was chartered as a city in 1892.

See Charles Brooks, *History of the Town of Medford* (Boston, 1855; enlarged by J. M. Usher, Boston, 1886); *Historical Register of the Medford Historical Society* (1898 et seq.); *Proceedings of the 275th Anniversary of the Settlement of Medford* (Medford, 1905); S. A. Drake, *History of Middlesex County* (2 vols., Boston, 1880) and Helen Tilden Wild, *Medford in the Revolution* (Medford, 1903).

MEDHANKARA, the name of several distinguished members, in medieval times, of the Buddhist order. The oldest flourished about A.D. 1200, and was the author of the *Vinaya Artha Samuccaya*, a work in the Sinhalese language on Buddhist canon law. Next to him came Araññaka Medhankara, who presided over the Buddhist council held at Polonnaruwa, then the capital of Ceylon, in 1230. The third Vanaratana Medhankara, flourished in 1285, and wrote a poem in Pali, *Jina Carita*, on the life of the Buddha. He also wrote the *Payoga Siddhi*. The fourth was the celebrated scholar to whom King Parākrama Bāhu IV. of Ceylon entrusted in 1307 the translation from Pali into Sinhalese of the *Jātak* book, the most voluminous extant work in Sinhalese. The fifth, a Burmese, was called the Sangharāja Nava Medhankara, and wrote in Pali a work entitled the *Loka Padipa Sara*, on cosmogony and allied subjects.

See the *Journal of the Pali Text Society*, 1882, p. 126; 1886, pp. 62, 67, 72; 1890, p. 63; 1896, p. 43; *Mahāvamsa*, ch. xl., verse 85.

(T. W. R. D.)

MEDHURST, WALTER HENRY (1796-1857), English Congregationalist missionary to China, was born in London and educated at St Paul's school. He learned the business of a printer, and having become interested in Christian missions he sailed in 1816 for the London Missionary Society's station at Malacca, which was intended to be a great printing-centre. He became proficient in Malay, in a knowledge of the written characters of Chinese, and in the colloquial use of more than one of its dialects. He was ordained at Malacca in 1819, and engaged in missionary labours, first at Penang, then at Batavia, and finally, when peace was concluded with China in 1842, at Shanghai. There he continued till 1856, laying the foundations of a successful mission. His principal labour for several years, as one of a committee of delegates, was in the revision of existing Chinese versions of the Bible. The result was a version (in High Wen-li) marvellously correct and faithful to the original. With John Stronach he also translated the New Testament into the Mandarin dialect of Nanking. His Chinese-English and English-Chinese dictionaries (each in 2 vols.) are still valuable, and to him the British public owed its understanding of the teaching of Hung-Sew-Tseuen, the leader of the Tai-ping rising (1851-64).

The university of New York conferred upon him in 1843, the degree of D.D. Medhurst left Shanghai in 1856 in failing health, and died two days after reaching London, on the 24th of January 1857. His son, Sir Walter Henry Medhurst (1822-1885), was British consul at Hankow and afterwards at Shanghai.

MEDIA, the ancient name of the north-western part of Iran, the country of the Medes, corresponding to the modern provinces of Azerbaijan, Ardelan, Irak Ajemi, and parts of Kurdistan. It is separated from Armenia and the lowlands on the Tigris (Assyria) by the mighty ranges of the Zagros (mountains of Kurdistan; in its northern parts probably called Choatras, Plin. v. 98), and in the north by the valley of the Araxes (Aras). In the east it extends towards the Caspian Sea; but the high chains of mountains which surround the Caspian Sea (the Parachoathras of the ancients and the Elburz, separate it from the coast, and the narrow plains on the border of the sea (Gilan, the country of the Gelae and Amardi, and Mazandaran, in ancient times inhabited by the Tapuri) cannot be reckoned as part of Media proper. The greater part of Media is a mountainous plateau, about 3000-5000 ft. above the sea; but it contains some fertile plains. The climate is temperate, with cold winters, in strong contrast to the damp and unwholesome air of the shores of the Caspian, where the mountains are covered with a rich vegetation. Media contains only one river, which reaches the sea, the Sefid Rud (Amardus), which flows into the Caspian; but a great many streams are exhausted after a short course, and in the north-west is a large lake, the lake of Urumiah or Urmia.¹ From the mountains in the west spring some great tributaries of the Tigris, viz. the Diyala (Gyndes) and the Kerkkeh (Choaspes). Towards the south-east Media passes into the great central desert of Iran, which eastwards of Rhagae (mod. Rai, near Teheran), in the region of the "Caspian gates," reaches to the foot of the Elburz chain. On a tract of about 150 m. the western part of Iran is connected with the east (Khorasan, Parthya) only by a narrow district (Choarene and Comisene), where human dwellings and small villages can exist.

The people of the Mada, Medes (the Greek form *Mῆδοι* is Ionian for *Μῆδοι*) appear in history first in 836 B.C., when the Assyrian conqueror Salmanser II. in his wars against the tribes of the Zagros received the tribute of the Amadai (this form, with prosthetic α-, which occurs only here, has many analogies in the names of Iranian tribes). His successors undertook many expeditions against the Medes (Madaai). Sargon in 715 and 713 subdued them "to the far mountain Bikni," i.e. the Elburz (Demavend) and the borders of the desert. They were divided into many districts and towns, under petty local chieftains; from the names which the Assyrian inscriptions mention, we learn that they were an Iranian tribe and that they had already adopted the religion of Zoroaster. In spite of different attempts of some chieftains to shake off the Assyrian yoke (cf. the information obtained from prayers to the Sun-god for oracles against these rebels: Knudtzon, *Assyrische Gebete an den Sonnengott*), Media remained tributary to Assyria under Sargon's successors, Sennacherib, Esar-haddon and Assur-bani-pal.

Herodotus, i. 101, gives a list of six Median tribes (*γῆραι*), among them the Paraetaceni, the inhabitants of the mountainous highland of Paraetacene, the district of Isfahan, and the Magoi, i.e. the Magians, the hereditary caste of the priests, who in Media took the place of the "fire-kindlers" (*athraavan*) of the Zoroastrian religion, and who spread from Media to Persia and to the west. But the Iranian Medes were not the only inhabitants of the country. The names in the Assyrian inscriptions prove that the tribes in the Zagros and the northern parts of Media were not Iranians nor Indo-Europeans, but an aboriginal population, like the early inhabitants of Armenia, perhaps connected with the numerous tribes of the Caucasus.

¹ Anc. Mantiene, Strabo xi. 529; Martiane, Ptol. vi. 2, 5, probably identical with the name Matiane, Matiene, by which Herodotus i. 189, 202, iii. 94, v. 49, 52 (in i. 72 and vii. 72 they seem to be a different people in Asia Minor); Polyb. v. 44, 9; Strabo i. 49, ii. 73, xi. 509, 514, 523, 525; Plin. vi. 48, designate the northern part of Media.

We can see how the Iranian element gradually became dominant: princes with Iranian names occasionally occur as rulers of these tribes. But the Gelae, Tapuri, Cadusii, Amardi, Utii and other tribes in northern Media and on the shores of the Caspian were not Iranians. With them Polybius v. 44, 9, Strabo xi. 507, 508, 514, and Pliny vi. 46, mention the Anariaci, whom they consider as a particular tribe; but in reality their name, the "Not-Arians," is the comprehensive designation of all these small tribes.

In the second half of the 7th century the Medians gained their independence and were united by a dynasty, which, if we may trust Herodotus, derived its origin from Deioeces (q.v.), a Median chieftain in the Zagros, who was, with his kinsmen, transported by Sargon to Hamath (Hamah) in Syria in 715 B.C. The kings, who created the Median Empire, were Phraortes and his son Cyaxares. Probably they were chieftains of a nomadic Median tribe in the desert, the Manda, mentioned by Sargon; for the Babylonian king Nabonidus designates the Medians and their kings always as Manda. The origin and history of the Median Empire is quite obscure, as we possess almost no contemporary information, and not a single monument or inscription from Media itself. Our principal source is Herodotus, who wrongly makes Deioeces the first king and united of the whole nation, and dates their independence from c. 710—i.e. from the time when the Assyrian supremacy was at its height. But his account contains real historical elements, whereas the story which Ctesias gave (a list of nine kings, beginning with Arbaces, who is said to have destroyed Nineveh about 880 B.C., preserved in Diod. ii. 32 sqq. and copied by many later authors) has no historical value whatever, although some of his names may be derived from local traditions. According to Herodotus, the conquests of Cyaxares were interrupted by an invasion of the Scythians, who founded an empire in western Asia, which lasted twenty-eight years. From the Assyrian prayers to the Sun-god, mentioned above, we learn that the Median dynasts, who tried rebellions against the Assyrians in the time of Esar-haddon and Assur-bani-pal, were allied with chieftains of the Chimmerians (who had come from the northern shore of the Black Sea and invaded Armenia and Æt. Minor), of the Saparda, Ashguz and other tribes; and from Jeremiah and Zephaniah we know that a great invasion of Syria and Palestine by northern barbarians really took place in 626 B.C. With these facts the traditions of Herodotus must in some way be connected; but at present it is impossible to regain the history of these times. The only certain facts are that in 606 Cyaxares succeeded in destroying Nineveh and the other cities of Assyria (see PHRAORTES and DEIOECES).

From then the Median king ruled over the greatest part of Iran, Assyria and northern Mesopotamia, Armenia and Cappadocia. His power was very dangerous to their neighbours, and the exiled Jews expected the destruction of Babylonia by the Medes (Isa. xiii., xiv., xxi.; Jerem. i. ii.). When Cyaxares attacked Lydia, the kings of Cilicia and Babylon intervened and negotiated a peace in 585, by which the Halys was established as the boundary. Nebuchadrezzar married a daughter of Cyaxares, and an equilibrium of the great powers was maintained till the rise of Cyrus.

About the internal organization of the Median Empire we know only that the Greeks derive a great part of the ceremonial of the Persian court, the costume of the king, &c., from Media. But it is certain that the national union of the Median clans was the work of their kings; and probably the capital Ecbatana (q.v.) was created by them.

By the rebellion of Cyrus, king of Persia, against his suzerain Astyages, the son of Cyaxares, in 553, and his victory in 550, the Medes were subjected to the Persians. In the new empire they retained a prominent position; in honour and war they stood next to the Persians; the ceremonial of their court was adopted by the new sovereigns who in the summer months resided in Ecbatana, and many noble Medes were employed as officials, satraps and generals. After the assassination of the usurper Smerdis, a Mede Favartish (Phraortes), who pretended

to be of the race of Cyaxares, tried to restore the Median kingdom, but was defeated by the Persian generals and executed in Ecbatana (Darius in the Behistun inscr.). Another rebellion, in 409, against Darius II. (Xenophon, *Hellen.* i. 2, 19) was of short duration. But the non-Aryan tribes of the north, especially the Cadusians, were always troublesome; many abortive expeditions of the later kings against them are mentioned.

Under the Persian rule the country was divided into two satrapies. The south, with Ecbatana and Rhagae (Rai), Media proper, or "Great Media," as it is often called, formed in Darius' organization the eleventh satrapy (Herodotus iii. 92), together with the Paricanians and Orthocorybantians; the north, the district of Matiane (see above), together with the mountainous districts of the Zagros and Assyria proper (east of the Tigris) was united with the Alarodians and Saspirians in eastern Armenia, and formed the eighteenth satrapy (Herod. iii. 94; cf. v. 49, 52, vii. 72). When the empire decayed and the Carduchi and other mountainous tribes made themselves independent, eastern Armenia became a special satrapy, while Assyria seems to have been united with Media; therefore Xenophon in the *Anabasis* ii. 4, 27; iii. 5, 15; vii. 8, 25; cf. iii. 4, 8 sqq. always designates Assyria by the name of Media.

Alexander occupied Media in the summer of 330; in 328 he appointed Atropates, a former general of Darius (Arrian iii. 8, 4), as satrap (iv. 18, 3, vi. 29, 3), whose daughter was married to Perdiccas in 324 (Arrian vii. 4, 5). In the partition of his empire, southern Media was given to the Macedonian Peithon; but the north, which lay far off and was of little importance for the generals who fought for the inheritance of Alexander, was left to Atropates. While southern Media with Ecbatana passed to the rule of Antigonus, and afterwards (about 310) to Seleucus I.; Atropates maintained himself in his satrapy and succeeded in founding an independent kingdom. Thus the partition of the country, which the Persian had introduced, became lasting; the north was named Atropatene (in Plin. vi. 42, Atropatene; in Ptolem. vi. 2, 5, Tropatene; in Polyb. v. 44 and 55 corrupted in *ῥά τρωπαρτία καλοῦμενα*), after the founder of the dynasty, a name which is preserved in the modern Azerbaijan; cf. Nöldeke, "Atropatene," in *Zeitschrift der deutschen morgenl. Gesellschaft*, 34, 692 sqq. and Marquart, *Eran-shahr*, p. 108 sqq. The capital was Gazaca in the central plain, and the strong castle Phraaspa (Dio Cass. xlii. 26; Plut. *Anton.* 38; Ptol. vi. 2, 10) or Vera (Strabo xi. 523), probably identical with the great ruin Takhti Suleiman, with remains of Sassanid fire-altars and of a later palace. The kings had a strong and warlike army, especially cavalry (Polyb. v. 55; Strabo xi. 253). Nevertheless, King Artabazanes was forced by Antiochus the Great in 220 to conclude a disadvantageous treaty (Polyb. v. 55), and in later times the rulers became in turn dependent on the Parthians, on Tigranes of Armenia, and in the time of Pompey who defeated their king Darius (Appian, *Mithr.* 108), on Antonius (who invaded Atropatene) and on Augustus of Rome. In the time of Strabo (A.D. 17), the dynasty existed still (p. 523); in later times the country seems to have become a Parthian province.

Atropatene is that country of western Asia which was least of all influenced by Hellenism; there exists not even a single coin of its rulers. But the opinion of modern authors—that it had been a special refuge of Zoroastrianism—is based upon a wrong etymology of the name (which is falsely explained as "country of fire-worship"), and has no foundation whatever. There can be no doubt that the kings adhered to the Persian religion; but it is not probable that it was deeply rooted among their subjects, especially among the non-Aryan tribes.

Southern Media remained a province of the Seleucid Empire for a century and a half, and Hellenism was introduced everywhere. "Media is surrounded everywhere by Greek towns, in pursuance of the plan of Alexander, which protect it against the neighbouring barbarians," says Polybius (x. 27). Only Ecbatana retained its old character. But Rhagae became a Greek town, Europus; and with it Strabo (xi. 524) names Laodicea, Apamea, Heraclea or Achais (cf. Plin. vi. 48). Most of them were founded

by Seleucus I. and his son Antiochus I. In 227, the satrap Molon tried to make himself independent (there exist bronze coins with his name and the royal title), together with his brother Alexander, satrap of Persis, but they were defeated and killed by Antiochus the Great. In the same way, in 161, the Median-satrap Timarchus took the diadem and conquered Babylonia; on his coins he calls himself "the great king Timarchus"; but this time again the legitimate king, Demetrius I., succeeded in subduing the rebellion, and Timarchus was slain. But with Demetrius I. the dissolution of the Seleucid Empire begins, which was brought on chiefly by the intrigues of the Romans, and shortly afterwards, about 150, the Parthian king, Mithradates I. (q.v.), conquered Media (Justin xii. 6). From this time Media remained subject to the Arsacids, who changed the name of Rhagae, or Europus, into Asracia (Strabo xi. 524), and divided the country into five small provinces (Isidorus Charac.). From the Arsacids or Parthians, it passed in A.D. 226 to the Sassanids, together with Atropatene. By this time the old tribes of Aryan Iran had lost their character and had been amalgamated into the one nation of the Iranians. The revival of Zoroastrianism, which was enforced everywhere by the Sassanids, completed this development. It was only then that Atropatene became a principal seat of fire-worship, with many fire-altars. Rhagae now became the most sacred city of the empire and the seat of the head of the Zoroastrian hierarchy; the Sassanid *Aestae* and the tradition of the Parsees therefore consider Rhagae as the home of the family of the Prophet. Henceforth the name of Media is used only as a geographical term and begins to disappear from the living language; in Persian traditions it occurs under the modern form *Mah* (Armen. *Mai*; in Syriac the old name *Madai* is preserved; cf. Marquart, *Eranshahr*, 18 seq.).

For Mahomedan history see CALIPHATE; for later history SELJUKS and PERSIA. (ED. M.)

MEDIATION (Lat. *medius*, middle), in the international sense, the intervention of a third power, on the invitation or with the consent of two other powers, for the purpose of arranging differences between the latter without recourse to war. Mediation may also take place after war has broken out, with a view to putting an end to it on terms. In either case the mediating power negotiates on behalf of the parties who invoke or accept its aid, but does not go farther. Unlike an arbitrating power the mediator limits his intervention to suggestion and advice. His action is liable to be arrested at any time at the will of either party unless otherwise agreed, in which case to arrest it prematurely would be a breach of good faith. The difference between mediation and arbitration may be stated in the words of the Digest (lib. iv. tit. 8, § 13): "Recepisse autem arbitrium videtur, ut ait Pedius, qui iudicis partes suscepit finemque se sua sententia controversiis impositurum pollicetur. Quod si hactenus intervenit ut experiretur an concilio suo vel auctoritate discuti litem paterentur, non videtur arbitrium recepisse."

Some writers distinguish mediation from "good offices," but the distinction is of little practical value. We may, if we please, regard "good offices" as inchoate mediation, and "mediation" as good offices brought to the birth. Thus we may say that a third power renders "good offices" when it brings the parties together so as to make diplomatic negotiations between them possible; whilst if it takes an active part in those negotiations it becomes for the time being a mediator. The spontaneous yet successful effort made by President Roosevelt in 1905 to bring together the Russian and Japanese governments, and to secure their appointing delegates to discuss terms of peace, although not strictly mediation, was closely akin to it.

Of successful mediation in the strict sense there have been many instances: that of Great Britain, in 1825, between Portugal and Brazil; of France, in 1840-1850, when differences arose between Great Britain and Greece; of the Great Powers, in 1868-1869, when the relations of Greece and Turkey were strained to breaking-point by reason of the insurrection in Crete; of

Pope Leo XIII., in 1885, between Germany and Spain in the matter of the Caroline Islands. In these cases mediation averted war. The Austro-Prussian War of 1866, the war between Chile and Peru in 1882, and that between Greece and Turkey in 1897, are instances of wars brought to a close through the mediation of neutral powers. Mediation has also been occasionally employed where differences have arisen as to the interpretation of treaties or as to the mode in which they ought to be carried out: as when Great Britain mediated between France and the United States with regard to the Treaty of Paris of the 4th of July 1830. In one case at least mediation has been successful after a proposal for arbitration had failed. In 1844, when war between Spain and Morocco was threatened by reason of the frequent raids by the inhabitants of the Rif on the Spanish settlement of Ceuta, Spain declined arbitration on the ground that her rights were too clear for argument. But both she and Morocco subsequently accepted joint mediation at the hands of Great Britain and France.

The cause of mediation was considerably advanced by the Declaration of Paris of 1856. The plenipotentiaries of Great Britain, France, Austria, Russia, Sardinia and Turkey recorded in a protocol, at the instance of Lord Clarendon, their joint wish that "states between which any misunderstanding might arise should, before appealing to arms, have recourse so far as circumstances might allow (*en tant que les circonstances l'admettraient*) to the good offices of a friendly power." Article 8 of the Treaty of Paris, concluded in the same year, stipulated that "if there should arise between the Sublime Porte and one or more of the other signing powers any misunderstanding which might endanger the maintenance of their relations, the Porte and each of such powers, before having recourse to the use of force, shall afford the other contracting parties the opportunity of preventing such an extremity by means of mediation." These precedents (in which it will be seen that "good offices" and "mediation" are used interchangeably) were followed in the general act agreed to at the Conference held at Berlin in 1884-1885 the object of which was to secure religious and commercial liberty and to limit warlike operations in the Congo basin.

A special form of mediation was proposed by a delegate from the United States at the Peace Conference held at the Hague in 1899, and was approved by the representatives of the powers there assembled. The clause in which this proposal was embodied provided in effect that, whenever there is danger of a rupture between two powers, each of them shall choose a third power to which these differences shall be referred, and that, pending such reference, for a period not exceeding thirty days (unless the time is extended by agreement) the powers at issue shall cease to negotiate with each other and leave the dispute entirely in the hands of the mediating powers. The powers thus appealed to occupy a position analogous to that of seconds in a duel, who are authorized to arrange an "affair of honour" between their principals. This novel device has the advantage of toning down, if not of eliminating, personal and national prejudices by which controversy is frequently embittered. It also gets over the difficulty, often met with in arbitration, of choosing a referee satisfactory to both parties. The closer the relations between states become, the more their commercial interests are intertwined, the larger the part which mediation seems destined to play. It is true that states which have accepted the intervention of a mediator remain free to adopt or reject any advice he may give, but the advice of a disinterested power must always add considerable moral weight to the side towards which it inclines. (M. H. C.)

MEDIATIZATION (Ger. *Mediatisierung*, from Lat. *mediatus*, mediate, middle), the process by which at the beginning of the 19th century, a number of German princes, hitherto sovereign as holding *immediately* of the emperor, were deprived of their sovereignty and *mediatized* by being placed under that of other sovereigns. This was first done on a large scale in 1803, when by a recess of the imperial diet many of the smaller fiefs were mediatized, in order to compensate those German princes who had been forced to cede their territories on the left bank of the

Rhine to France. In 1806 the formation of the Confederation of the Rhine involved an extension of this mediatizing process, though the abolition of the empire itself deprived the word "mediatization" of its essential meaning. After the downfall of Napoleon the powers were besieged with petitions from the mediatized princes for the restoration of their "liberties"; but the congress of Vienna (1815) further extended the process of mediatization by deciding that certain houses hitherto *immediate* (i.e. Salm, Isenburg, Leyen) should only be represented mediately in the diet of the new Confederation. On the other hand, at Aix-la-Chapelle (1818) the powers, in response to the representations of the aggrieved parties, admonished the German sovereigns to respect the rights of the mediatized princes subject to them. Of these rights, which included the hereditary right to a seat in the estates, the most valued is that of *Ebenbürtigkeit* (equality of birth), which, for purposes of matrimonial alliance, ranks the mediatized princes with the royal houses of Europe.

See August Wilhelm Heffter, *Die Sonderrechte der Soweränen und der Mediatisirten, vormals reichsständischen Häuser Deutschlands* (Berlin, 1871). The mediatized families are included in the *Almanach de Gotha*.

MEDICAL EDUCATION. Up to 1858 each University, Royal College of Physicians or of Surgeons, and Apothecaries' **Great Britain and Ireland.** Hall in Great Britain and Ireland laid down its own regulations for study and examination, and granted its degree or licence without any State supervision. In that year, pursuant to the Medical Act, 21 & 22 Vict. c. 90, the General Medical Council of Medical Education and Registration was established, consisting of twenty-three members, of whom seventeen were appointed by the various licensing bodies and six by the Crown. This number was increased by the amended act of 1886 to twenty-nine, three of the six additional members being elected by the profession as "direct" representatives. The object of the act was "to enable persons requiring medical aid to distinguish qualified from unqualified practitioners." To this end the "Medical Register" was established, on which no person's name could be inscribed who did not hold a diploma or licence from one or more of the licensing bodies after examination. By the 1886 act a qualifying examination was defined as "an examination in medicine, surgery, and midwifery," conducted by universities or by medical corporations, of which one must be capable of granting a diploma in medicine, and one in surgery. The Council is authorized to require from the licensing bodies information as to courses of study and examinations, and generally as to the requisites for obtaining qualifications; and to visit and inspect examinations either personally or by deputy. If the visitors think the course of study and examination of any licensing body is not sufficient to ensure that candidates obtaining its qualification possess the requisite knowledge and skill for the efficient practice of their profession the Council, on a report being made, may represent the same to the Privy Council. The Privy Council may, if it sees fit, deprive the accused body of its power to grant registrable qualifications. From this statement it will be seen that the powers of the Council are limited; nevertheless, by their cautious application, and by the loyal manner in which the licensing bodies have acted on the recommendations and suggestions which have from time to time been made, the condition of medical education has been improved; and although there is not a uniform standard of examination throughout the United Kingdom, the Council has ensured that the minimum requirements of any licensing body shall be sufficient for the production of trustworthy practitioners.

One of the first subjects to which the Council applied itself was the establishment of a system of examinations in general knowledge. Such examinations have to be passed before beginning medical study. On presentation of a certificate to the registrars of the Council, and on evidence being produced that the candidate is sixteen years of age, his name is inscribed on the "Students' Register." The subjects of examinations are: (a) English language, including grammar and composition

(marks not exceeding 5% of the total obtainable in this section may be assigned to candidates who show a competent knowledge of shorthand); (b) Latin, including grammar, translation from specified authors, and translation of easy passages not taken from such authors; (c) mathematics, comprising arithmetic; algebra, as far as simple equations inclusive; geometry, the subject-matter of Euclid, Books I, II, and III, with easy deductions; (d) one of the following optional subjects—Greek, French, German, Italian or any other modern language. Certificates are accepted from all the universities of Great Britain and Ireland, from the leading Indian and colonial universities, from government examination boards, and from certain chartered bodies. The German Abiturienten Examen of the gymnasiums and *real-gymnasiums*, the French diplomas of Bachelier ès Lettres and Bachelier ès Sciences, and corresponding entrance examinations to other continental universities are also accepted.

As regards professional education, the Council divided its resolutions into "requirements" and "recommendations"; the former consisting of demands on the licensing bodies, non-compliance with which renders them liable to be reported to the Privy Council; the latter are regarded merely as suggestions for the general conduct of education and examination. The requirements may be summarized as follows: (a) Registration as a medical student. (b) Five years of bona-fide study between the date of registration and the date of the final examination for any diploma entitling the holder to be registered under the Medical Acts. (c) In every course of professional study and examination the following subjects must be contained, the Council offering no opinion as to the manner in which they should be distributed or combined for the purposes of teaching or examination, this being left to the discretion of the bodies or of the student—(i.) physics, including the elementary mechanics of solids and fluids, and the rudiments of heat, light and electricity; (ii.) chemistry, including the principles of the science, and the details which bear on the study of medicine; (iii.) elementary biology; (iv.) anatomy; (v.) physiology; (vi.) materia medica and pharmacy; (vii.) pathology; (viii.) therapeutics; (ix.) medicine, including medical anatomy and clinical medicine; (x.) surgery, including surgical anatomy and clinical surgery; (xi.) midwifery, including diseases peculiar to women and to new-born children; (xii.) theory and practice of vaccination; (xiii.) forensic medicine; (xiv.) hygiene; (xv.) mental disease. (d) The first of the four years must be passed at a school or schools of medicine recognized by any of the licensing bodies; provided that the first year may be passed at a university or teaching institution where the subjects of physics, chemistry and biology are taught; and that graduates in arts or science of any university recognized by the Council, who shall have spent a year in the study of these subjects, and have passed in them, shall be held to have completed the first of the five years of medical study. (e) The study of midwifery practice must consist of three months' attendance on the indoor practice of a lying-in hospital, or the student must have been present at not less than twenty labours, five of which shall have been conducted throughout under the direct supervision of a registered practitioner.

The fifth year of study is intended to be devoted to clinical work and may be passed at any one or more public hospitals or dispensaries, British or foreign, recognized by the licensing authorities; six months of this year may be passed as a pupil to a practitioner possessing such opportunities of imparting practical knowledge as shall be satisfactory to the medical authorities. This latter method is rarely employed.

The "recommendations" of the Council contain suggestions which may or may not be acted on by the bodies. For the most part they are connected with in connexion with the system of practical and clinical teaching.

The Council satisfies itself that its requirements are acted on, and that the examinations are "sufficient," by cycles of inspection about every five years. The examination of each licensing body is visited by an inspector, who forwards his report to the Council, which sends each report to the body for its information and remarks. As yet it has never been the duty of the Council to report to the Privy Council that any examination has not been found sufficient.

Most universities exact attendance at more classes than the colleges and halls; for instance, botany and natural history are taught to their students, who are also examined in them. But with these exceptions the system of practical education is fairly uniform. Since 1875 attendance on "practical" classes has been called for in all subjects. Under this system the larger classes in which the subjects are taught systematically are broken up, and the students are taught the use of apparatus and the employment of methods of investigation and observation. Tutorial instruction is superimposed on teaching by lecture. Much the same plan is adopted in respect of clinical instruction: not only is the student taught at the bedside by the lecturer, but he receives, either from the house-surgeon or house-physician or from a specially appointed clinical

tutor, an insight into methods of examination of diseases, and learns practically the use of the stethoscope and other aids to diagnosis, and of surgical and obstetrical instruments. In fact, it may be said that each subject of instruction is duplicated. If this is taken into account, it must be evident that the time of the student is fully occupied, and the belief is rapidly growing that five years is too short a period of study. As a matter of fact, the average time taken to obtain a British licence to practise is upwards of six years. The probability is that the solution of the difficulty will be found in the inclusion of such subjects as physics, biology and chemistry in a "preliminary scientific" examination, which may have to be undertaken before registration as a medical student, thus leaving the whole five years to be devoted to purely professional study.

The German regulations in regard to professional study are few. They are those for the *Staats Examen*, for which the university degree is no longer necessary. The regulations for the admission of candidates to the *Staats Examen* are contained in the royal proclamations of the 22nd of June 1883. They comprise: (a) Certificate of a course of study at a classical gymnasium of the German Empire. In exceptional cases, the same from a classical gymnasium outside the German empire may be considered sufficient. (For details of the course of study and examinations, see *Minutes of the General Medical Council*, vol. xxvii. appendix 3.) (b) Certificate from a university, certifying a course of medical study of at least nine half-years at a university of the German empire. (c) Certificate that the candidate has passed, entirely at a German university, the medical *Vorprüfung*, and thereafter has attended for at least four half-years the medical studies of a university. (d) The special testimony of the clinical directors bearing witness that the candidate has taken part as *Praktikant* (clerk or dresser) during two half-years at the medical, surgical, and gynaecological clinics; has himself delivered two cases of labour in the presence of his teachers or assistant physicians; and has attended for a half-year as *Praktikant* the clinic for diseases of the eye.

The medical *Vorprüfung* referred to is necessary alike for the *Staats Examen* and the degree of Doctor of Medicine. It takes place at the end of the second year (fourth semester), and includes the subjects of experimental physics, chemistry, botany, zoology, anatomy and physiology. It is conducted by a board appointed yearly by the Minister of Education.

No one can practise medicine in France who does not possess the diploma of Doctor of Medicine of a French university. The qualification of *Officier de santé* is no longer granted.

France. Before he can inscribe as a student of medicine the applicant must have obtained the diplomas of *Bachelier ès lettres* and *Bachelier ès sciences*. Although the course of professional study may be completed in four years, a longer time is generally taken before the student proceeds to the final examination for the doctor's degree. Each year is divided into four *trimestres*; at each *trimestre* the student must make a new inscription. The *trimestres* are (1) November and December, 56 days; (2) January, February, March, 86 days; (3) April, May, June, 86 days; (4) July, August, 56 days. Practically there are no regulations determining the division of the various subjects, or the number of lectures in each course, or requiring the student to attend the courses. The medical faculty of each university puts before the student a scheme recommending a certain order of studies (*Division des études*) for each of the four years of the medical course, and, as a matter of fact, this order of study is enforced by the system of intermediate examinations (*Examens du fin d'année*). All the lecture courses are free, as also are the clinics and the hospital service, and there is no system of ascertaining the regularity of attendance at lectures, or of certificate of attendance. If, however, the student fails to pass the *Examen du fin d'année* he is debarred from making the next trimestral inscription, and thus loses three months. The lectures are, however, closely attended. In contrast to the freedom in regard to attendance on systematic lectures, there are strict direction and control in regard to hospital attendance and practical courses. The student is required to sign a register *ad hoc* each time he goes in and out. From the beginning of the third year, e.g. from the ninth quarterly inscription, hospital attendance is enforced till the end of the fourth year. No one can renew his trimestral inscription without producing a schedule of his last trimestral

stage, showing that during it he had not absented himself more than five times without explanation. Practical work is obligatory during each of the four years.

Besides systematic courses of lectures, *Conférences* are held by the assistant-professors (*agrégés*) in natural history, physiology, general pathology, internal pathology, external pathology. At the end of the first year the student is examined in osteology, myology and the elements of physiology; at the end of the second year, in anatomy and physiology in all their branches; at the end of the third year, in medicine and surgery; at the end of the fourth year, an examination is held over the whole field of study.

No one is allowed to enter on the study of medicine without passing the *Artium examen* of a secondary school. This is the equivalent of the German Abiturienten Examen of Denmark, a classical gymnasium. After study for two semesters an examination must be passed in psychology, logic and history. The special professional examinations consist of (1) preliminary scientific, in botany, zoology, physics, chemistry; (2) first special or professional, anatomy (orally and by dissections), physiology, and pharmacology; (3) second special or professional, written examinations in medicine, surgery, medical jurisprudence; practical and oral in operative surgery, in clinical medicine, and clinical surgery; and oral in pathological anatomy, medicine, surgery, and midwifery. The completion of the full medical course takes six years, of which the first two are devoted to the study of the natural sciences.

AUTHORITIES.—The history of the development of medical education from the earliest times down to 1894 will be found treated generally in Puschmann's *Geschichte des medicinischen Unterrichts* (Leipzig, 1889-1905) translated by E. H. Hare (London, 1891). Those desiring more special information on the subject in regard to the details of British institutions should consult the annals of the various universities and colleges of Great Britain and Ireland. The following works supply much interesting information regarding the gradual rise and development of teaching and examination: *Annals of the Barber Surgeons*, by Sydney Young (1890); *History of the Royal College of Surgeons of Ireland*, by Cameron (1886); *Early Days of the Royal College of Physicians of Edinburgh*, by Peel Ritchie (1899); *Historical Sketch of the Royal College of Surgeons of Edinburgh*, by Gairdner (1866); *Memorials of the Faculty of Physicians and Surgeons of Glasgow*, by Duncan (1866); *The Story of the University of Edinburgh*, by Sir A. Grant (1884); *University of Glasgow*, by Stewart (1891).

As late as 1880 medical education in the United States was in a deplorable condition. In the early history of the country, before and shortly after the beginning of the 19th century, the few medical colleges had shown a disposition to require a liberal education on the part of those who entered upon their courses, and some effort was made, through the agency of state boards, to control the licence to practise. But as the country increased in population and wealth preliminary requirements were practically abolished, the length of the courses given each year was shortened to four or five months or less, and in the second and final year there was simply a repetition of the courses given during the first year. This is to be attributed mainly to the fact that there was no general national or state supervision of medical training. Medical colleges could obtain incorporation under state laws without difficulty, and brought considerable advantages in the way of prestige and increased practice to those concerned. That the existence of a college depended solely upon the fees of the students encouraged the tendency to make both entrance and graduation requirements as easy as possible, especially as there was no state supervision, and the mere possession of a diploma entitled the holder to practise. Fortunately, during this period the practical character of the clinical instruction given in the better colleges fitted the graduates in some measure for the actual necessities of practice, while the good traditions of medicine as a learned profession stimulated those who adopted it as a career, so that in the main the body of practitioners deserved and held the confidence and respect of the community. From the middle of the 19th century there has been constant agitation on the part of the physicians themselves for an improvement in medical education. The first notable result was an increase in the time of instruction from two to three years (Chicago Medical College, 1859; Harvard Medical School, 1871), the lengthening of each session to six

months or more, and the introduction of graded courses instead of a repetition of the same lectures every year. The improvement thus begun became marked during the decade 1800-1900, amounting almost to a revolution in the rapidity with which the course of instruction was amplified. Many factors co-operated to produce this result: the general development of scientific instruction in the colleges and secondary schools, the influence of the large number of medical graduates who completed their training by study in European schools, the adoption by many states of stringent regulations regarding the licence to practise within their borders, the good examples set by many leading schools in voluntarily raising their requirements for entrance and graduation, and, perhaps above all in its general effect, the agitation continually maintained by several national or state associations which in a measure have exerted the general regulating control that in other countries has been enforced by national legislation. Among the most influential of these associations are the American Medical Association, the American Academy of Medicine, the Association of American Medical Colleges, the Illinois State Board of Health, and the University of the State of New York.

The different states make their own general regulations as to the practice of medicine within their borders. Certain states recognize the medical diplomas granted by other states having equivalent standards of examination. Such certificates are generally required to be (a) of graduation from a "reputable medical school," (b) certificates of moral character, (c) the applicant must be at least twenty-one years of age. These enable the candidate to present himself before the state board for the state examination. In his states the applicant must satisfy the board not only as to his professional, but as to his general education. The standing of the various medical schools is usually left to the state boards, each one determining the matter for its own state, consequently a school may confer a degree recognized as reputable in several states but not in others. Only three or four states regulate the chartering of institutions. In other states any body of men may secure articles of incorporation of a college or school by paying the necessary state fee, without question as to the ability of the incorporator to furnish an education. So strong, however, has been the growth of American public opinion that a four-years' course of medical training has become the standard in medical schools, and in the majority this is in addition to one or two years' training in the natural sciences. There are some sixty-five state boards, and many have adopted strong medical practice acts.

The standard of preliminary requirements for entrance to the medical schools is being gradually raised, and a large number of the states demand a certificate of a high school education, while the colleges comprising the Association of Medical Colleges, which numbers more than half the American medical schools, accept as an entrance standard a certificate of at least one year's study at a high school. In the report for 1908 of the United States bureau of education of 77 schools, which report the number of their students having an arts degree, it is stated that a degree was held by only 15% of the candidates in medicine. These students were mostly distributed between the Johns Hopkins Medical School (which from the date of its foundation in 1893 has only admitted college graduates, and has in addition stipulated that candidates shall have a knowledge of French and German and have already completed a year's training in the natural sciences), Harvard Medical School and Columbia University, and the medical departments of the universities of California, Michigan and Chicago (Rush Medical College) require on entrance the equivalent of a two-years' college course, which must include French and German, together with physics, chemistry and biology. This tendency is in accordance with the recommended standard of medical education suggested by the Council of Medical Education and adopted by the House of Delegates of the American Medical Association, of which the following is a summary:—

1. (a) The preliminary of a four-years' high school education or an examination such as would admit to a recognized university.

(b) In addition a year of not less than nine months devoted to chemistry, physics and biology and one language (preferably French or German) to be taken in a college of the liberal arts.

2. Previous to entering a medical college every student should receive from the state board a "medical student's entrance certificate" to be given on the production of credentials of training as above.

3. Four years of study in a medical college having a minimum of a 30-weeks' course each year, with not less than 30 hours' work per week.

4. Graduation from college to entitle a candidate to present himself for examination before a state board.

5. A satisfactory examination to be passed before the state board.

Practically all medical schools admit women, but there are three separate schools of medicine for women: The Women's Medical College of Philadelphia, Pennsylvania; Women's Medical College, Baltimore, Maryland; New York Medical College and Hospital for Women—the last being one of the eighteen homoeopathic colleges of the United States.

AUTHORITIES.—J. M. Tower, *Contributions to the Annals of Medical Progress and Medical Education in the United States, before and during the War of Independence* (Washington Government Printing Office, 1874); N. S. Davis, *History of Medical Education and Institutions in the United States* (Chicago, 1851); *Contributions to the History of Medical Education and Medical Institutions in the United States* (Washington, Government Printing Office, 1877); J. B. Beck, *An Historical Sketch of the State of Medicine in the American Colonies* (Albany, 1850); *Bulletins of the American Academy of Medicine* (The Chemical Publishing Company, Easton, Pa.); H. L. Taylor, "Professional Education in the United States," College Department, University of the State of New York, *Bulletin 5, 1890*, and *Bulletin 8, 1900*; "Courses of Study in Medical Schools," *Report of the Commissioners of Education* (Washington, 1908); F. R. Packard, M.D., *The History of Medicine in the United States* (1902); *Journal of American Medical Association* (Aug. 14, 1909); Flewcer, *Medical Education in the U.S. and Canada* (1910). (W. H. H.; H. L. H.)

MEDICAL JURISPRUDENCE, or FORENSIC MEDICINE, that branch of state medicine which treats of the application of medical knowledge to certain questions of civil and criminal law. The term "medical jurisprudence," though sanctioned by long usage, is not really appropriate, since the subject is strictly a branch of medicine rather than of jurisprudence; it does not properly include sanitation or hygiene, both this and medical jurisprudence proper being distinct branches of state medicine. The connexion between medicine and the law was perceived long before medical jurisprudence was recognized, or had obtained a distinct appellation. It first took its rise in Germany, and more tardily received recognition in Great Britain. Forensic medicine, or medical jurisprudence proper as distinguished from hygiene, embraces all questions which bring the medical man into contact with the law, and embraces (1) questions affecting the civil rights of individuals, and (2) injuries to the person.

I.—QUESTIONS AFFECTING THE CIVIL OR SOCIAL RIGHTS OF INDIVIDUALS

1. *Development of the Human Frame.*—The development of the physical and mental powers of the human being is a factor of great consequence in determining criminal responsibility, civil responsibility, or the power of giving validity to civil contracts, and in determining the personal identity of a living person or of a corpse. Human life is usually divided into the five periods of *infancy, childhood, youth, manhood and old age*. Some writers increase the number of these unnecessarily to seven periods.

Infancy is the period from birth till the first or milk set of teeth begin to be shed—usually about the seventh year. During this period the body increases in size and stature more, relatively, than at any other period of existence; and the mental faculties undergo great development. The milk teeth, twenty in number, are evolved in a definite order, beginning with the central incisors at about six months, and ending with the second molars about the termination of the second year. From the size and stature of the body, the development of the teeth, and the more or less advanced state of ossification or solidification of the bony skeleton, conclusions may be drawn as to the probable age of the infant.

Childhood extends from the commencement of the shedding of the milk teeth to the age of puberty—usually from the seventh to the fourteenth or fifteenth year. During this period the body expands, as well as the bony structures, without any clearly marked difference in structure being observable between the sexes except as regards the genitals, so that it is impossible to distinguish absolutely between the male and the female skeleton during this period. The milk teeth are shed, and are replaced by the second or permanent set, thirty-two in number, though these do not usually all make their appearance during childhood. Marked differences between the proclivities of the sexes are noticeable even at an early period of childhood, and long before the characteristic functions begin to be developed.

Youth is marked at its commencement by the changes which occur at puberty—the development of the genitals in both sexes, the appearance of hair on the genitals, the appearance of a beard in the male, the development of the breasts in the female, the appearance of the monthly flow in the female, and the ability to secrete semen in the male. Marked mental changes now occur, and the generative functions are perfected. Youth terminates at the age of legal majority, twenty-one years, or perhaps the period ought to be extended to twenty-five years of age, as it is with some nations.

Manhood (or Womanhood) is the period of perfection of all the bodily and mental powers. It ceases in woman with the cessation of the monthly flow at about forty-five years of age; but in man it often extends to a much later period of life.

Old Age begins with the decay of the bodily and mental faculties, and is characterized by wrinkling of the skin, loss of the teeth, whitening of the hair, and feebleness of the limbs. In its later stages decay of the mental faculties, deafness, obscurity or loss of vision, and bowing of the spine are added.

2. **Duration of Human Life.**—The chances of human life form an important subject of inquiry, and on deductions from comparisons of birth and death rates is founded the system of annuities, insurance against loss in sickness, and the insurance of lives. Since the establishment of compulsory registration of deaths, our knowledge of the ordinary and extraordinary chances of human life has been extended, and surer data are available for calculations of probabilities of life, of survivorships, and of the payments which ought to be made in benefit clubs (see INSURANCE).

3. **Personal Identity.**—Where the identity has to be established or disproved after long absence, exposure to foreign climates and hardships, wounds, &c., the problem has often been extremely difficult. The data for identifying a person are individual and family likeness, stature, the colour of the eyes, peculiarities of garb and manner, recollection of antecedent events, but more especially marks on the persons either congenital or acquired. Such are *naevi* or mother's marks, scars, and disunited or badly united fractures, known to have existed upon the missing person (see IDENTIFICATION). In the case of the living, identification is more often a matter for the police officer than for the medical man. Bertillon and Galton have each devised methods for the identification of criminals (see ANTHROPOMETRY, and FINGER-PRINTS).

4. **Marriage.**—Under this head the medical jurist has to deal principally with the nubile age, viewed in the light of nature and according to legislative enactments, and with such physical circumstances as affect the legality of marriages, or justify divorce.

In Great Britain the age at which the sexes are first capable of propagating the species is later than in more southern climes. Ordinarily it does not occur before fifteen years of age for the male and fourteen for the female; exceptionally it occurs at the ages of thirteen and of twelve (or even less) respectively in the male and female. By law, nevertheless, parents and guardians may, in England at all events, forbid the marriage of young people till the age of legal majority. The only physical circumstances which in Great Britain form a bar to marriage are physical inability to consummate, and the insanity of one of the parties at the time of marriage. Both those circumstances have been pleaded and sustained in the law courts. In other countries minor physical circumstances, as disease, are held to invalidate marriage.

5. **Impotence and Sterility.**—These are of importance in connexion with legitimacy, divorce and criminal assaults. Impotence and sterility may arise from organic or from functional causes, and may be curable or incurable. Impotence (*q.v.*) is taken cognisance of by the law courts as a ground of divorce, and might, of course, be urged as a defence in a case of rape. Sterility is not a ground of divorce, but might be a question of importance in cases of legitimacy.

6. **Pregnancy.**—This subject presents one of the widest fields for medico-legal evidence. The limits of age between which it is possible, the limits of utero-gestation, and the signs of pregnancy may all in turn be the subjects of investigation.

The limits of age between which pregnancy is possible are usually fixed by the appearance and cessation of the monthly flow; and these ordinarily begin about fourteen and cease at forty-five years of age. Exceptionally they appear as early as the tenth year, and may not cease till the end of the fifth decade of life. Cases, however, have occurred where a woman has conceived before menstruating; and a few doubtful cases of conception are recorded in women upwards

of fifty or even sixty years of age. The general fact of pregnancy being limited by the age of puberty on the one hand and the cessation of the monthly flow—or fifty-three or fifty-four years as the extreme limit of age—must be accepted as the safest guide in practice.

The limits of utero-gestation are not in England fixed by legislation. The French code fixes the extreme limit of three hundred days. The ordinary period is forty weeks and a half, or two hundred and eighty-three days from the cessation of the last monthly flux. The limit of three hundred days, as fixed by the French code, is perhaps never exceeded, if ever reached. The uncertainty of females in fixing the exact date of conception has given rise to the discrepant opinions of physiologists on the subject. It is well known, however, that among the higher animals the period is not precise; and impregnation and conception need not necessarily be coincident.

The signs of pregnancy are of the utmost importance to the medical jurist. He may be called upon to pronounce upon the virtue of a female, to sustain or rebut a plea for divorce, to determine whether a capital sentence shall be carried out, or to determine whether it is probable that an heir will be born to an estate. Medical jurists classify the signs of pregnancy as uncertain or certain; it is the former which are most regarded by the public, but the latter are alone of probative value to the jurist. The usual and uncertain signs are the cessation of the monthly flow, nausea, sickness, a darkening of the areola and the formation of a secondary areola around the nipple, enlargement of the breasts, increased size of the abdomen, the formation of a tumour in the womb, quickening, and the motions of the foetus. Also uncertain are the uterine souffle, which is a peculiar soft sound heard over the abdomen and synchronous with the maternal pulse and ballottement or the examination for a floating tumour in the abdomen between the fifth and eighth months of pregnancy. The certain signs of pregnancy are the foetal limbs palpated through the abdomen by the physician, the pulsations being much quicker and not synchronous with the maternal pulse. This latter is inapplicable before the fourth month of gestation.

7. **Parturition.**—The imminence of the process of parturition is of comparatively little interest to the medical jurist; but the signs of recent delivery are all-important. These signs are the bruised, swollen, and lacerated state of the external genitals, relaxation and dilatation of the vagina and womb, the existence of a peculiar vaginal discharge known as the lochia, a relaxed and fissured condition of the abdominal walls, a peculiar aspect of the countenance, and the distended state of the breasts due to the secretion of milk. The lochial discharge is the most characteristic sign. All the signs may disappear within ten days of delivery, though this is not usual.

Connected with parturition, the question of *viability* (potentiality for life) of the child is not unimportant. After the intra-uterine age of seven months is reached a child is certainly viable. The period at which the foetus becomes viable cannot be stated with certainty; but five calendar months, or one hundred and fifty days, is perhaps the nearest approximation. The viability of a child is judged by its size and weight, its general state of development; the state of the skin, hair, and nails; its strength or feebleness, the ability to cry, and its power of taking maternal nourishment. The question of viability has important bearings upon the crime of infanticide. In the case of succession to property the meaning of "born alive" is different from the meaning of the same expression as used respecting infanticide. In questions of tenancy by the curtesy (*q.v.*) it has been decided that any kind of motion of the child, as a twitching and tremulous motion of the lips, is sufficient evidence of live-birth. By the French code, however, no child that is born alive can inherit, unless it is born viable. As regards infanticide, proof of a conclusive separate existence of the child is demanded before live-birth is admitted.

The subject of *superfoetation* and *superfecundation*, or the possibility of two conceptions having occurred resulting in the birth of twins with a considerable intervening interval, is obscure and has given rise to much controversy. There is much, however (*e.g.* the existence of a double or bifid uterus), to countenance the view that a double conception is possible.

8. **Monsters and Hermaphrodites.**—To destroy any living human birth, however unlike a human creature it may be, is to commit a crime. Blackstone states that a monster which hath not the shape of mankind hath no inheritable blood; but the law has not defined a monster, nor what constitutes a human form. The same author states that if, in spite of deformity, the product of birth has human shape, it may be an heir. Hermaphrodites are beings with malformations of the sexual organs, simulating a double sex. Physiologists do not admit, however, the existence of true hermaphrodites with double perfect organs, capable of performing the functions of both sexes.

9. *Paternity and Affiliation.*—These are often matters of great doubt. A considerable time may elapse between the absence or death of a father and the birth of his reputed child. As has already been said, three hundred days is the utmost limit to which physiologists would extend the period of utero-gestation. This subject involves questions respecting children born during a second marriage of the mother, posthumous children, bastards, and alleged cases of posthumous children.

10. *Presumption of Survivorship.*—When two or more persons perish by a common accident, when a mother and her new-born child are found dead, and in a few analogous cases, important civil rights may depend upon the question which lived the longest; and great ingenuity has been displayed in elucidating the disputes which have arisen in the law courts in such cases.

11. *Maladies exempting from Discharge of Public Duties* frequently demand the attention of the medical man. He may be called upon to decide whether a man is able to undertake military or naval service, to act as a jurymen without serious risk to life or health, or to attend as a witness at a trial.

12. *Feigned and Simulated Diseases* often require much skill and caution in order to detect the imposture.

13. *The Signs of Death.*—The determination of the actual existence of death assumes a certain importance in tropical countries, where the necessity for speedy interment may involve a risk of burial alive. Such an accident cannot well occur where a medical man confirms the existence of death, and in the United Kingdom, where burial rarely takes place before the lapse of forty-eight hours, such changes usually occur in the body as to render any error practically impossible. Within a varying period, usually not more than twelve hours, the body becomes rigid, owing to the development of *rigor mortis* or post mortem rigidity. The blood, which during life is equally distributed throughout the body, gravitates to the most dependent parts and develops a discoloration of the skin which is known as post mortem lividity or post mortem staining. At a variable period of time, dependent on the cause of death, also the temperature and moisture of the air to which the body is exposed, decomposition or putrefaction sets in. These changes after death are of great importance, not only as affording certain proof of death, but also because they furnish valuable information as to the probable time at which it occurred, and from the fact that they may alter or destroy evidence as to the cause of death.

14. *Insanity or Mental Alienation.*—A medical man may be required to give evidence in any of the law courts, civil, criminal or ecclesiastical, before commissions of *lunatico inquirendo*, or before a magistrate, as to the sanity or insanity of an individual; and he may have to sign certificates of unsoundness of mind with the view of providing for the safe custody and proper treatment of a lunatic. Hence he must be familiar with the chief forms of insanity (see *INSANITY*), and be able to distinguish and treat each of these. He will also be required to detect feigned insanity, and to examine persons charged with crime with the view of preventing real lunatics from being treated as criminals.

II.—INJURIES TO THE PERSON

1. *Deforation.*—The signs of deforation are obscure and uncertain; and it is rather by the coexistence of several of the usual marks than the existence of any one sign, that any just conclusion can be arrived at.

2. *Rape.*—This crime consists in the carnal knowledge of a woman forcibly and against her will. The proofs of rape apart from the consistency of the woman's story, mainly depend on the presence of marks of violence, stains, &c. In all charges of rape, the woman and her assailant should be examined as soon as possible by a medical man, but such examination, it is important to remember, can only be carried out with the free consent of the party to be examined. It is to be noted that according to English law the slightest degree of penetration is sufficient to constitute the crime of rape.

3. *Mutilation.*—This may consist in the cutting or maiming of any member; castration is the most important, and perhaps but

rarely effected as a crime. Self-mutilation, giving rise to false accusations, is occasionally resorted to.

4. *Criminal Abortion.*—This crime consists in unlawfully procuring the expulsion of the contents of the gravid uterus at any period short of full term. It must be noted that while this definition may be held to recognize the induction of premature labour by medical men in certain circumstances, yet, when the operation is necessary, a medical man should always protect himself from possible misconstruction of his action (*i.e.* criminal intent) by having a consultation with another practitioner. The means employed in criminal abortion to procure the desired result may be classed under three heads: (1) general violence to the body, (2) administration of drugs supposed to have abortifacient qualities, (3) instrumental interference with the contents of the uterus. Among the drugs frequently employed for the purpose, although by no means always successfully, are ergot, strong purgatives, iron, rue, pennyroyal, savin.

5. *Homicide.*—The legal sense of the term homicide excludes such injuries as are the result of either accident or of suicide. It embraces murder or willful homicide, manslaughter or culpable homicide, casual homicide, and justifiable homicide.

Ordinary homicide may be accomplished by several modes that may sometimes be ascertained by examination of the body, *e.g.* poison.

As a preliminary in all cases of homicide, it is the duty of the medical jurist in the first place to ascertain the fact of death, and to distinguish between real and apparent death; and then to determine, if possible, the period at which death took place.

Infanticide, or child murder, is by the British law treated with the same severity as the murder of an adult. Indeed infanticide, as a crime distinct from murder has no legal recognition. Practically this severity defeats itself, and hence an alternative charge of concealment of birth in England, or concealment of pregnancy in Scotland, is usually preferred in such cases.

The iniquity of the old law which threw the onus of proof of still-birth on the mother now no longer exists, and the law demands strict proof of live-birth at the hands of the prosecution. Hence the surgeon's certificate of a still birth is not sufficient. The child must be proved to have arrived at the period when there was a probability of its living (proof of viability); and as the establishment of respiration is necessary to prove live-birth the evidences of this act must be carefully investigated. The size and position of the lungs, and the state of the vessels concerned in foetal circulation, must be carefully noted. The foetal lungs are dark, dense and liver-like in appearance and consistence, and sink when immersed in water; whilst the fully respired lungs are rosy, marbled, and soft and crepitant when handled. Minor degrees of respiration are recognized by the appearance of little groups of dilated air-vesicles, and by the fact that, although the lungs as a whole may sink in water, certain portions of them, into which respired air has penetrated, float in water even after subjection to firm pressure in the hand. Care must be taken, nevertheless, to exclude buoyancy of the lung due to putrefaction. In this case the air may be expelled by gentle pressure, and the previously buoyant portion of lung now sinks in water. It is impossible, however, to distinguish certainly between a lung naturally inflated and one artificially insufflated.

It must be borne in mind that, although live-birth cannot be affirmed in the absence of signs of respiration, the presence of these signs is not proof of live-birth in the legal sense of the term. The law demands for live-birth a separate existence of the child after delivery; and breathing may take place whilst the child is still either wholly or partially within the maternal passages, and in some special cases whilst still within the uterus itself.

When proofs of respiration—it may be to such an extent as to leave no doubt as to live-birth—have been found, the cause of death is then to be investigated. Wounds, and other forms of injury, may be sought for, there may be signs of strangulation, suffocation, puncture of the fontanelles and consequent injury to the brain, the administration of a poison, or other means of procuring death. It must be borne in mind that some of these causes may be brought about by omission, or even by accident. Thus strangulation may arise from natural and unrelieved pressure of the navel-string on the neck of the child; suffocation from immersion of the face of the child in the maternal discharge, or by the presence of clots in the mouth. Death may result from haemorrhage through neglect to tie the navel-string, or the infant may perish from exposure to cold.

In the case of exposed infants it is important to ascertain the real mother. As such exposure usually takes place soon after birth, comparison of the age of the infant with the signs of recent delivery in the suspected mother is the best method of proving the relation.

Death from Asphyxia.—Among the forms of violent death due to this cause are drowning, hanging, strangulation, garotting, smothering, suffocation from choking, mechanical interference with the expansion of the chest walls, as when persons are crushed together during a panic in a fire, breathing poisonous gases, such as carbonic acid or carbonic oxide. Suicide and accidental death from these causes are still more common.

Drowning is thought to produce death occasionally by the suddenness of the shock causing suspension of the functions of circulation and respiration—by shock without a struggle. The usual mode of death appears, however, to be by the circulation of unoxygenated blood through the brain acting as a poison upon that organ; and this is attended with all the phenomena of asphyxia, as in suffocation. The phenomena attending asphyxia are as follows. As soon as the oxygen in the arterial blood, through exclusion of air, sinks below the normal, the respiratory movements grow deeper and at the same time more frequent; both the inspiratory and expiratory phases are exaggerated, the supplementary respiratory muscles are brought into play, and the breathing becomes hurried. As the blood becomes more and more venous, the respiratory movements continue to increase both in force and frequency. Very soon the expiratory movements become more marked than the inspiratory, and every muscle which can in any way assist in expiration is brought into play. The orderly expiratory movements culminate in expiratory convulsions; these violent efforts speedily exhaust the nervous system, and the convulsions suddenly cease and are followed by a period of calm. The calm is one of exhaustion; all expiratory active movements have ceased, and all the muscles of the body are flaccid and quiet. But at long intervals lengthened deep inspiratory movements take place; then these movements become less frequent; the rhythm becomes irregular, so that each breath becomes a more and more prolonged gasp, which becomes at last a convulsive stretching of the whole body; and with extended limbs and a straightened trunk, with the head thrown back, the mouth widely open, the face drawn and the nostrils dilated, the last breath is taken. The above phenomena are not all observed except in cases of sudden and entire exclusion of air from the lungs. In slow asphyxia, where the supply of air is gradually diminished (e.g. in drowning), the phenomena are fundamentally the same, but with minor differences. The appearances of the body after death from drowning are various. There may be pallor of the countenance, or this may be livid and swollen. The air passages are filled with frothy mucus, and there may be water in the stomach. The ends of the fingers are often exsanguinated from grasping at objects; and weeds, &c., are sometimes found grasped in the hands. The distinction between murder and suicide by drowning can rarely be made out by examination of the body alone, and is usually decided from collateral circumstances or marks of a struggle. Attention must also be paid to the existence of wounds on the body, marks of strangulation on the neck, and the like.

Hanging may result in death from asphyxia, or, as is more particularly the case in judicial hanging, some injury is inflicted on the upper portion of the spinal cord, resulting in instant death. The ordinary appearances of death from asphyxia may be found: dark fluid blood, congestion of the brain, intensely congested lungs, the right cavities of the heart full, and the left comparatively empty of blood, and general engorgement of the viscera. Ecchymosis may be found beneath the site of the cord, or a mere parchmenty appearance. There may even be no mark of the cord visible. The mark, when present, usually follows an oblique course, and is high up the neck. The fact that a body may be suspended after death, and that if this be done speedily whilst the body is still warm there may be a post-mortem mark undistinguishable from the mark observed in death from hanging, must not be forgotten.

Suffocation may occur from the impaction of any substance in the glottis, or by covering up the mouth and nose. It is frequently of accidental origin, as when substances become accidentally impacted in the throat, and when infants are overlaid. The phenomena are those of pure asphyxia, which have already been detailed. On post-mortem examination the surface of the lungs is found covered with minute extravasations of blood, known as punctated ecchymosis.

Strangulation may be accomplished by drawing a cord tightly round the neck, or by forcibly compressing the windpipe (throttling). Hence there may be either a circular mark round the neck, not so oblique as after hanging, or the marks of the fingers may be found about the region of the larynx. The cartilaginous structures of the larynx and windpipe may be broken. The mark of the ligature is often low down in the neck. The signs of asphyxia are present in a marked degree.

Mephitism.—In the United Kingdom this last form of death usually results accidentally from an escape of lighting gas, the danger has been much increased in many towns owing to the addition of carburetted water-gas to the ordinary supply. Carbonic oxide gas is contained in ordinary lighting gas to the extent of about 6 to 8%, and is extremely fatal when inhaled. Carburetted water-gas contains about 28%, and when mixed with ordinary lighting gas the percentage of carbonic oxide is thus very much increased. As a mode of assassination it is seldom employed, but is frequently

resorted to on the continent of Europe by suicides, charcoal fumes being commonly used for the purpose.

6. Death from Starvation.—Cases occur in which it is important to distinguish this from other modes of death. In such cases the skin becomes harsh and dry, and may acquire a peculiar odour; the subcutaneous fat disappears; the gums shrink away from the teeth; the tongue and mouth become dark-coloured and dry; the eyes are bloodshot; the intestines become thin and their coats translucent; the gall-bladder is distended. The period of total abstinence from food required to kill an adult is unknown, and greatly depends upon whether there be access to liquid. In some cases persons have been able to subsist on little or no nourishment for long periods, the body being in a state of quasi-hibernation.

7. Death from Extremes of Temperature.—(1) Death from cold is not often observed in the British Isles. A portion only of the body, as the extremity of a limb, may perish from extreme cold. After the first sensation of tingling experienced on exposure to severe cold, loss of sensation supervenes, with languor and an irresistible propensity to sleep. The tendency to this forms an extreme danger in such cases. (2) Death from extreme heat usually occurs in the form of burning and scalding, attended with destruction of a large portion of the cutaneous structures. Here the cause of death is obvious. The human body is capable of exposure to very hot air—as is seen in Turkish baths—for a considerable period with impunity. Sunstroke is a cerebral affection brought on by too great exposure to a hot atmosphere, especially whilst undergoing fatigue.

8. Death by Lightning.—Lightning or an electric current may cause instant death. No visible marks of the effects of the electric current may be left, or the body may be singed or discoloured, or the skin may be perforated at one or two spots.

9. Injuries or Wounds.—These include in a medico-legal sense not only those characterized as incised, punctured, contused, lacerated, stab wounds, but also burns, injuries produced by firearms, fractures, dislocations, &c. One of the chief questions which have to be decided in all forms of violent death is whether it was the result of accident, suicide or murder. In cases of fatal wounding, among the points to be noted, which will help to decide the question, are the situation, direction and extent of the wound, the position in which the body and any weapon may be found, together with the presence and distribution of any blood marks and the signs of a struggle. In wounds caused by firearms the injury, if suicidal, is usually situated in a vital and accessible part of the body, the temple, mouth, and chest being the favourite situations; but such an injury also presents, as a rule, the characteristic appearances resulting from the discharge of the weapon close to the body, viz. besides the wound of entrance of the bullet, there are singeing of the cuticle and hair, and blackening of the area immediately surrounding the wound, from particles of unconsumed powder being driven into the skin and from the smoke of the discharge. These effects are naturally not produced when the weapon is discharged at a distance exceeding 2 or 3 ft., as usually happens in cases of homicidal shooting. They may also be wanting in undoubted suicidal wounds produced by revolvers and cartridges filled with amberite or other smokeless powders. Death from burning is generally accidental, very rarely suicidal, and when homicidal is usually employed to conceal traces of other violence inflicted upon the body. In large conflagrations death is not always due to burning. Charred bodies may be found presenting various injuries due to the fall of beams, crushing, the trampling of others trying to escape, &c., or fractures and lacerations may be due simply to the action of the heat. Death may result from such injuries, or from suffocation by the gases of combustion, before the victim is affected by the actual fire. Spontaneous combustion of the body has been stated to occur, but the evidence upon which the cases rest is not well authenticated.

Punctured wounds or stabs require minute attention; for there have been instances in which death has been produced by an instrument so small as a pin thrust into a vital part. Wounds of the head are always dangerous, especially if the blow has been severe. The person so wounded may die without division of the skin, or fracture

of the bones, as happens in what is known as *concussion* of the brain. Contusions which do not divide the skin may fracture the skull; or the inner table of the skull may be fractured without the outer being broken or depressed. Even wounds of the scalp may prove fatal, from inflammation extending towards the brain. Punctured wounds of the head are more dangerous than cuts, as more likely to excite fatal inflammation. When the brain and its membranes are injured, all sense and motion are generally lost. Wounds of the face, organs of sense are often dangerous, always disfiguring, and productive of serious inconvenience. *Wounds of the neck* are always serious whenever more than the skin is divided. The danger of opening large blood-vessels, or wounding important nerves, is imminent; even the division of a large vein in the neck has proved immediately fatal, from the entrance of air into the vessel, and its speedy conveyance to the heart. A blow on the neck has instantly proved fatal, from injury to an important nerve, generally the pneumogastric or the sympathetic. Dislocations and fractures of the bones of the neck prove instantly fatal. *Wounds of the chest* are always serious when the cavity is penetrated, though persons may recover from wounds of the lungs, and have even survived for some time considerable wounds of the heart. This last is an important fact; because we are not always to consider the spot where the body of a person killed by a wound of the heart, and apparently remaining where he fell, is found as that in which the fatal wound was inflicted. Instances have occurred of persons surviving severe wounds of the heart for several days. Broken ribs are never without danger; and it may be said of severe contusions of the chest, from the chance of inflammation extending to the lungs. Wounds penetrating both sides of the chest are generally considered as fatal; but possibly there may be recovery from such. *Wounds of the abdomen*, when they do not completely penetrate, may be considered as simple wounds, unless when inflicted with great force, so as to bruise the contents of the abdominal cavity; in that case they may produce death without breach of surface, from rupture of some viscus, as sometimes happens from blows or kicks upon the belly. Wounds injuring the peritoneum are highly perilous, from the risk of severe inflammation. Wounds of the stomach or intestines, or of the gall-bladder, generally prove mortal, from the effusion of their contents into the peritoneal cavity producing fatal inflammation. Wounds of the liver, spleen or kidneys are generally soon mortal, from the great vascularity of those organs. Wounds of the extremities, when fatal, may generally be considered so from excessive hæmorrhage, from the consequences of inflammation and gangrene, or from the shock to the system when large portions of the limb are forcibly removed, as in accidents from machinery, and in wounds from firearms.

Blood Stains.—The examination of blood stains is a frequent and important operation in criminal charges. Blood stains when fresh and abundant can be recognized without difficulty, but when old, or after being acted upon by certain substances, their identity is not readily determined.

The tests which may be applied to a suspected stain consist of: (1) *The microscopic test.* A portion of the stain is soaked in a drop of some fluid which will soften and cause separation of the dried blood corpuscles without altering their characteristic appearance. Such fluids are solutions of glycerine and water of a specific gravity of 1.028 or 30% caustic potash. The recognition of blood corpuscles affords evidence of the nature of the stain. (2) *Chemical tests.* (a) *Haematin.* Applied to a solution obtained by soaking some of the stained fabric in cold water. A blood solution is red, and loses its red colour on application of heat, while at the same time a buff-coloured precipitate is formed. (b) On applying a drop of freshly prepared tincture of guaiacum and then some ozonic ether or peroxide of hydrogen to the stain, a blue colour is obtained if blood be present. Many other substances, however, give the same reaction. (c) If, even to the smallest particle of dried blood, a fragment of common salt and some glacial acetic acid be added, and the latter is then heated to ebullition and allowed to evaporate away, small brown rhomboid crystals—haematin crystals—will be found to have formed, and they can be recognized under the microscope. (3) *Spectroscopic test.* A solution of blood obtained from a stain will show a spectrum having two dark bands between Fraunhofer's lines D and E (oxy-haemoglobin). On adding ammonium sulphide to the solution the haemoglobin is reduced and only one broad dark band is seen (reduced haemoglobin). On adding caustic potash to a solution of blood, alkaline haematin is formed, and this again is transformed on the further addition of ammonium sulphide into reduced haematin or hæmochromogen, which gives a very characteristic spectrum of two dark bands situated in the yellow part of the spectrum. The production of these three different spectra from a red-coloured solution is characteristic of blood. Old blood stains are insoluble in water, whereas recent stains are readily soluble in cold water, yielding a red solution. The application of hot water or washing with soap tends to fix or render blood stains insoluble. Vegetable dyes may likewise give red solutions, but they may be distinguished from blood by the addition of ammonia, which alters the colour of the former, but rather intensifies the red colour of a blood solution.

The differentiation between human blood stains and those pro-

duced by the blood of other animals, more especially domestic animals, is a matter of great importance to the medical jurist. When the blood stain is fresh, measurement of the corpuscles may decide the question, but in the case of dry and old stains it is impossible to make the distinction. A method has been discovered, however, which enables the distinction to be made not only between human blood and that of other animals (with the exception of *Simulida*), but also between the bloods of different animals. The method depends upon the fact that if an animal (A), such as a dog or rabbit, is inoculated with the blood or serum of another animal (B), then the blood or serum of A is found to produce a specific reaction (namely, the production of a cloudiness or precipitate) when added to a solution of the blood of a similar animal to B, and that species of animal only. If, therefore, human blood serum is injected into an animal, its blood after a time affords an "anti-serum" which produces the specific reaction only in human blood solutions and not in those formed from the blood of other animals.

10. **Poisoning.**—There is no exact definition of a poison (*q.v.*). Popularly, substances which destroy or endanger life when swallowed in small quantity are called poisons, but a scientific definition would also include many substances which are injurious to health in large doses or only after repeated administration, and which act not only when swallowed, but also when taken into the system through other channels, *e.g.* the skin or the lungs. The branch of science which relates to poisons, their nature, methods of detection, the symptoms produced by them, and treatment of poisoning, is called Toxicology, and is one of the most important subjects included under the term Medical Jurisprudence.

The medical evidence in cases of poisoning rests upon—(1) the symptoms produced during life; (2) the post mortem appearances; (3) the chemical analysis and detection of the substance in the body, or in the excretions and vomited matters, or in articles of food; (4) experiments on animals in the case of certain poisons where other conclusive evidence is difficult to obtain. The treatment of cases of poisoning will vary according to the substance taken, but the general principles which should be followed are: (a) to get rid of the poison by means of the stomach-pump, or by washing out the stomach with water through a soft rubber tube, or by giving an emetic such as mustard, sulphate of zinc, ipecacuanha; (b) to neutralize the poison by giving a substance which will form with it an innocuous compound (*e.g.* in the case of the strong acids by administering magnesia or common whiting), or which has an opposite physiological action (*e.g.* atropine in opium poisoning); (c) to promote the elimination from the body of the poison which has been already absorbed; (d) general treatment of any dangerous symptoms which appear, as by stimulation in collapse or artificial respiration in asphyxia.

Food Poisoning (see also ADULTERATION).—Foods may prove noxious from a variety of causes: (1) The presence of metallic poisons, as in peas artificially coloured with copper salts, in tinned foods from dissolved tin salts, &c. (2) The contamination of any food with the specific germs of disease, as for example, milk infected with the germ of enteric fever. (3) The presence in meat of parasites, such as the *Trichina spiralis*, or of disease in animals, capable of transmission to man, such as tuberculosis, or the presence of poison in the flesh of animals which have fed on substances harmless to them but poisonous to human beings. Grain may be infected with parasitic fungi of a poisonous character, as for example *Claviceps purpurea*, causing epidemics of ergotism. (4) Foods of various kinds may contain saprophytic bacteria which elaborate certain poisons, either before or after the food is taken. It is chiefly in relation to food-poisoning from the last-mentioned cause that our knowledge has been increased in recent years.

Many cases of food-poisoning, previously of mysterious origin, can now be explained by the action of bacteria and the products which they give rise to—toxalbumoses, ptomaines, toxins—by splitting up proteid substances. It is not necessary that the food should show evident signs of putrefaction. It may not do so, and yet on being eaten produce violent symptoms of gastro-intestinal irritation almost immediately, followed by various nervous symptoms. In such cases a chemical poison, developed by putrefactive bacteria before the food was eaten, quickly acts upon the system. On the other hand, symptoms may not appear for many hours after ingestion of the food, and then come on suddenly and with great

severity—there has been a period of incubation. In such cases the food when swallowed has contained the bacteria, but the poisonous toxin has been elaborated by them afterwards in the system during the period preceding the onset of symptoms. In both varieties of poisoning the symptoms are similar, consisting of gastro-intestinal irritation—vomiting, purging and pain in the abdomen—together with great prostration, fever, muscular twitchings, disturbances of vision, delirium and coma. The varieties of meat which have most frequently given rise to poisoning (Botulismus) are pork, ham, veal, sausages, brawn, various kinds of meat pies and potted meats. Pig flesh appears to be specially liable to become infected. A point of considerable interest, which has sometimes given rise to doubt as to the poisonous character of meat in certain instances, is, that the same food may be poisonous at one time and not at another. Thus it may be harmless when freshly prepared, cause fatal effects if eaten a day or two afterwards, and shortly after that again prove perfectly innocuous. This is explained by the fact that the toxic substances take some time to develop, and after development are still further split up by the bacteria into other bodies of a harmless nature. In some fish—e.g. *Trachinus draco*, or sea weaver—the poison is a physiological product of certain glands. In others the poison is not known, as in the family *Scombridae*, to which the disease Kakké has been attributed. In the United Kingdom the poisonous effects produced by fish are due to bacterial agency after death, and instances have occurred from the eating of herrings, mackerel, dried salt codfish, caviare, tinned salmon and tinned sardines. Shellfish may produce poisonous effects from putrefactive changes or from the development in them (oysters and mussels) of ptomaines. Brieger discovered a ptomaine in poisonous mussels to which he gave the name mytilotoxin. It is now fully proved that oysters and mussels may become contaminated with the organism of typhoid fever if placed in specifically polluted water, and thus transmit the disease to human beings. Milk, as already stated, may be contaminated and convey the infection of scarlet fever and other diseases. It may also contain substances of bacterial origin, which are possibly the cause of infantile diarrhoea, and others, having a fatal effect upon adults. Cheese has frequently caused poisoning. Vaughan discovered a toxic substance in milk and cheese—tyrotoxin—but there are other toxic substances of bacterial origin sometimes present in cheese to which poisonous effects have probably been due. Mushroom-poisoning results from the eating of poisonous fungi in mistake for the edible mushroom. The poisonous element in most cases is either muscarin contained in the fungus *Amanita muscaria*, or phallin in *Amanita phalloides*.

HISTORY OF FORENSIC MEDICINE

The true origin of medical jurisprudence is of comparatively recent date, although traces of its principles may be perceived in remote times. Among the ancient Greeks the principles of medical science appear only to have been applied to legislation in certain questions relating to legitimacy. In the writings of Galen we find, however, remarks on the differences between the foetal and the adult lungs; he also treats of the legitimacy of seven months' children, and discusses feigned diseases. Turning to Rome, we find that the laws of the Twelve Tables fix three hundred days as the extreme duration of utero-gestation. It is doubtful whether the Roman law authorized medical inspections of dead bodies. In the code of Justinian we find *De statu hominum; De poenis et manumissis; De sicariis; De inspicendo ventre custodiendoque partu; De muliere quae peperit undecimo mense; De impotentia; De hermaphroditis*—titles which show obvious traces of a recognized connexion between medicine and law. It was not, however, by the testimony of living medical witnesses that such questions were to be settled, but on the authority of Hippocrates.

Medical jurisprudence, as a science, dates only from the 16th century. In 1507 the bishop of Bamberg introduced a penal code in which the necessity of medical evidence in certain cases was recognized; and in 1532 the emperor Charles V. persuaded the Diet of Ratisbon to adopt a uniform code of German penal jurisprudence, in which the civil magistrate was enjoined in all cases of doubt or difficulty to obtain the evidence of medical witnesses,—as in cases of personal injuries, infanticide, pretended pregnancy, simulated diseases, and poisoning. The true dawn of forensic medicine dates, however, from the publication in 1553 of the *Constitutio criminalis carolina* in Germany. A few years later Weither, a physician, having undertaken to prove that witches and demons are, in fact, persons subject to hypocondriasis and hysteria, and should not be punished, aroused popular indignation, and was with difficulty rescued from the flames by his patron, William duke of Cleves.

At the close of the 16th century Ambrose Paré wrote on monsters, on simulated diseases, and on the art of drawing up medico-legal reports; Pineau also published his treatise on virginity and defloration. About the same time as these stimuli to the study of forensic medicine were being made known in Paris, the first systematic treatise on the science appeared in Sicily in the form of a treatise *De relationibus medicorum* by Fidele. Paulo Zacchia, the illustrious Roman medical jurist, moreover, published from 1621 to 1635 a work entitled *Quaestiones medico-legales*, which marks a new era in the history of the science—a work which displays an immense amount of learning and sagacity in an age when chemistry was in its infancy, and physiology very imperfectly understood. The discovery of the circulation of the blood by Harvey soon followed, and gave a new impetus to the study of those branches of forensic medicine having direct relations to physiology; and to Harvey we owe the idea how to apply Galen's observations on the differences between the foetal and the adult lungs to the elucidation of cases of supposed infanticide. About this time, too, Sebiz published two treatises, on the signs of virginity and on the examination of wounds respectively. In the former he contended that the hymen was the real mark of virginity; but this was denied by Augenio and Gassendi. In 1663 Thomas Bartholin investigated the period of human uterine gestation, a subject which had engaged the attention of Aristotle. He also proposed the "hydrostatic test" for the determination of live-birth—a test still in use, and applied by observing whether the lungs of an infant float or sink in water. J. Swammerdam explained the rationale of the process in 1677; but it was not till 1682 that it was first practically applied by Jan Schreyer.

Germany, ever the leader in questions of forensic medicine, introduced the first public lectures on medical jurisprudence. Michaelis gave the first course about the middle of the 17th century in the university of Leipzig; and these were followed by the lectures of Bohn, who also published *De renunciatione vulnerum; cui accesserunt dissertationes binæ de partu enecato, et an quis vivus mortuusve aquis submersus, strangulatus, aut vulneratus fuerit, et De officis medicis duplicis, civici et forensis*. Welsch and Amman wrote on the fatality of wounds, and Licetus on monsters.

From the time of Ambrose Paré the mode of conducting investigations in forensic medicine had attracted attention in France; and in 1603 Henry IV. authorized his physician to appoint persons skilled in medicine and surgery to make medico-legal inspections and reports in all cities and royal jurisdictions; in 1692, difficulties having arisen, Louis XIV. created hereditary royal physicians and surgeons for the performance of like duties. These, having become a corrupt and venal body, were suppressed in 1790. The only works on forensic medicine which appeared in France during the 17th century, however, were Gendry's *Sur les moyens de bien rapporter à justice et Blégnys Doctrine des rapports en chirurgie*. At the beginning of the 18th century the latter was superseded as a text-book by Devaux's *L'Art de faire des rapports en chirurgie*. Valentin followed with two works, which were finally incorporated in his *Corpus juris medico-legale* which appeared in 1722. This work is a vast storehouse of medico-legal information, and a summary of the knowledge of the time.

Professorships for teaching the subject were founded in the German universities early in the 18th century, and numerous treatises on forensic medicine were published. Teichmeyer's *Institutiones medicinae legalis* long formed the text-book of the subject; and Alberti, professor of legal medicine at Halle, in his *Systema* gave to the world a most complete and laborious treatise on the science. His industrious collection of facts renders his works a precious mine of information. Indeed towards the close of the 18th century the Germans were almost the only cultivators of legal medicine. But in France the celebrated case of Villeblanche attracted attention to the subject, and called forth Louis, who in a memoir on utero-gestation attacked with powerful arguments the pretended instances of protracted pregnancy, and paved the way for the adoption in the *Code Napoléon* of

three hundred days as the limit of utero-gestation, a period in precise accordance with the ancient Roman law of the Twelve Tables. Louis also wrote on death from hanging, and pointed out the mode by which we may distinguish murder from suicide under such circumstances. It is he who is credited with having been the first in France to publicly teach the just application of medical knowledge to jurisprudence. Foderé's celebrated *Traité de médecine légale* appeared in 1798, and marks a new era in the annals of legal medicine.

No British author wrote systematically on forensic medicine till 1788, when Dr Samuel Parr published a short treatise on the *Elements of Medical Jurisprudence*; but this was merely an abridgment of an earlier work of Fazellius. Previous writers—as Mead, Munro, Denman, Percival and the two Hunters—had, however, dealt with fragments of the subject; nevertheless the science as a whole was little appreciated or recognized in this country during the 18th century.

In the 19th century France took the lead; and the institution of three professorships of forensic medicine at the end of the 18th century produced excellent fruits. In 1814 Orfila, a Spaniard by birth, but naturalized in France, published his *Toxicologie*, a work which revolutionized this branch of medical jurisprudence, and first placed the knowledge of poisons upon a scientific basis. Since the time of Orfila, France has never ceased to have one or more living medical jurists, among the most recent of whom we must enumerate Tardieu, whose treatises on abortion, on poisons, on wounds, &c., are justly celebrated. Germany too industriously pursued the subject, and Casper's great work on forensic medicine will ever remain a classic in the science. In Russia Dragendorff greatly contributed to our knowledge of poisons.

Though forensic medicine may be said to have been entirely neglected in England till the beginning of the 19th century, its progress has since been by no means slow or unimportant; and the subject now forms a recognized and obligatory portion of medical study. The first lectures delivered in Great Britain were given in the university of Edinburgh in 1801 by the elder Dr Duncan; and the first professorship was held by his son in 1803. Dr Alfred Swaine Taylor gave the first course of lectures delivered in England, at Guy's Hospital in 1831; and in 1863 the university of London made forensic medicine a separate subject for examination and honours for medical graduates. In 1822 there was not in the English language any treatise of authority either on medical jurisprudence or on any important division of the subject; for it was not till the following year that the useful compendium of Paris and Fonblanque was published; and even in the middle of the 19th century medical jurisprudence may be said to have been almost in its infancy as compared with what it is now. From 1829 Great Britain produced an abundant crop of literature on forensic medicine. Sir Robert Christison's admirable treatise on *Toxicology*, Dr A. S. Taylor's *Principles and Practice of Medical Jurisprudence* (1905 edition, by F. J. Smith), the same author's *Elements of Medical Jurisprudence*, Dr Guy's *Forensic Medicine*, and Ogston's *Lectures on Medical Jurisprudence* have become well-known and widely circulated works. The separate memoirs of Taylor, Christison, Guy and others are also storehouses of facts and deductions in the science. America, too, has not been behindhand in the race. F. Wharton and M. Stillé's *Manual*, Wormley's *Toxicology*, and the works of Beck and Reese have furthered the study of the science.

See also Dixon Mann, *Forensic Medicine and Toxicology* (London, 1902); Wynter Blyth, *Poisons: their Effects and Detection* (London, 1895); Allbutt and Rolleston, *A System of Medicine*, vol. ii. "Intoxications" (London, 1909); Vaughan, *Twentieth Century Practice of Medicine*, vol. xiii, article "Ptomaines, Toxins and Leucemaines" (London, 1898); Maschka, *Handbuch der gerichtlichen Medizin* (Tübingen, 1881-1882); Hofmann, *Lehrbuch der gerichtlichen Medizin* (Wien, 1898); Strassmann, *Lehrbuch der gerichtlichen Medizin* (Stuttgart, 1895); Kunkel, *Handbuch der Toxikologie* (Jena, 1899); Brouardel, *L'Infanticide, La Pénalologie*, &c. (Paris, 1897). (H. H. L.; T. A. I.)

MEDICI, the name of a family renowned in Italian history for the extraordinary number of statesmen to whom it gave birth, and for its magnificent patronage of letters and art. They emerged from private life and rose to power by means of a very subtle policy that was persistently pursued from generation to generation. The origin of the family is buried in obscurity. Some court historians indeed declare it to have been founded by Perseus, and assert that Benvenuto Cellini's bronze Perseus holding on high the head of Medusa was executed and placed in the *Loggia dei Lanzi* at Florence to symbolize the victory of the

Medici over the republic. But this only proves that the real origin of the family is unknown, and equally unknown is the precise signification of the Medicæan arms—six red balls on a field of gold.

The name appears in Florentine chronicles as early as the close of the 12th century, although only casually mentioned in connexion with various offices of the republic. The first of the family to be a distinct figure in history Early Bearers of the Name. was Salvestro dei Medici, who, in 1378, took an active part in the revolt of the Ciompi—so called because it was led by a wool-carder (*ciompo*), one Michele di Lando, and because the chief share in it was taken by the populace, who held the reins of government for some time, and sought to obtain extended political rights. Although Michele di Lando was the nominal chief of the revolt, Salvestro dei Medici was its real leader. The latter, although a member of the greater guilds, had joined the lesser and sought to be at their head, in order to lay the foundation of his own power and that of his kindred by attacking the Albizzi, who were the leading men of the greater guilds. The victory of the Ciompi, however, was brief, for the excesses of the lower classes brought about a reaction, in which they were crushed, and Michele di Lando sent into banishment. Nevertheless the lesser guilds had gained some ground by this riot, and Salvestro dei Medici the great popularity at which he had aimed. His policy during that period had traced the sole possible road to power in liberty-loving Florence. This was the road henceforth pursued by the Medici.

On Salvestro's death in 1388 the Albizzi repossessed themselves of the government, and conducted the wars of the republic. Vieri dei Medici, who seems to have been the next Giovanni. head of the family, understanding the temper of the times, abstained from becoming a popular leader, and left it to his successors to prosecute the task under easier conditions. Then, in the person of Giovanni, son of Averardo Bici dei Medici (1360-1429), another branch of the family arose, and became its representative branch. Indeed this Giovanni may be considered the actual founder of Medicæan greatness. He took little part in political affairs, but realized an immense fortune by trade—establishing banks in Italy and abroad, which in his successor's hands became the most efficient engines of political power. The Council of Constance (1414-1418) enabled Giovanni dei Medici to realize enormous profits. Besides, like his ancestor Salvestro, he was a constant supporter of the lesser guilds in Florence. Historians record his frequent resistance to the Albizzi when they sought to oppress the people with heavier taxation, and his endeavours to cause the chief weight to fall upon the richer classes. For this reason he was in favour of the so-called law of *calata*, which, by assessing the property of every citizen, prevented those in power from arbitrarily imposing taxes that unjustly burdened the people. In this way, and by liberal loans of money to all who were in need of it, he gained a reputation that was practically the foundation-stone of the grand family edifice. Giovanni dei Medici died in 1429 leaving two sons, Cosimo (1380-1464) and Lorenzo (1395-1440). From the former proceeded the branch that held absolute sway for many generations under the nominal republic of Florence, and gave to Italy popes like Leo X. and Clement VII. On the extinction of this elder line in the 16th century, the younger branch derived from Lorenzo, Cosimo's brother, seemed to acquire new life, and for two centuries supplied grand-dukes to Tuscany.

Cosimo, surnamed Cosimo the Elder, to distinguish him from the many others bearing the same name, and honoured after his death by the title of *pater patriæ*, first succeeded Cosimo the Elder. in solving the strange problem of becoming absolute ruler of a republic keenly jealous of its liberty, without holding any fixed office, without suppressing any previous form of government, and always preserving the appearance and demeanour of a private citizen. Born in 1380, he had reached the age of forty at the time of his father's death. He had a certain amount of literary culture, and throughout his life showed much taste and an earnest love both for letters

and art. But his father had mainly trained him to commerce, for which he had a special liking and aptitude. He was devoted to business to the day of his death, and like his forefathers derived pecuniary advantage from his friendly relations with the papal court. He accompanied Pope John XXIII. to the Council of Constance, transacted a vast amount of business in that city, and made very large gains. He then travelled in Germany, and after his return to Florence discharged several ambassadorial missions. At the death of his father he was possessed of a vast fortune and an extended experience, and inherited the leadership of the opposition to the then dominant party of the greater gilds headed by Rinaldo degli Albizzi, Palla Strozzi and Niccolò da Uzzano. Of gentle and kindly manners, generous in lending and even in giving money whenever he could gain popularity by that means, at critical moments he frequently came to the succour of the government itself. He was very dexterous in turning his private liberalities to account for the increase of his political prestige, and showed no less acumen and still fewer scruples in making use of his political prestige for purposes of pecuniary profit. Indeed, whenever his own interests were at stake, he showed himself capable of positive villainy, although this was always tempered by calculation. Cosimo proved his skill in these knavish arts during the war between Florence and Luca. He had joined the Albizzi in urging on this war, and many writers assert that he turned it to much pecuniary advantage by means of loans to the government and other banking operations. When, however, military affairs went badly, Cosimo joined the discontented populace in invectives against the war and those who had conducted it. This won him an enormous increase of popularity, but the hatred of the Albizzi and their friends augmented in equal degree, and a conflict became inevitable. The Albizzi, who were far more impetuous and impatient than Cosimo, were now bent upon revenge. In 1433 one of their friends, Bernardo Guadagni, was elected gonfalonier, and thereupon Cosimo dei Medici was called to the palace and summarily imprisoned in the tower. A general assembly of the people was convoked and a *balìa* chosen, which changed the government and sent Cosimo into exile. Undoubtedly the Albizzi party would have preferred a heavier sentence, but they did not dare to attempt their enemy's life, being well aware of the great number of his adherents. Cosimo had some apprehension that he might be poisoned in prison, but Federico dei Malavolti, captain of the palace guard, showed him the utmost kindness, and, to soothe his fears, voluntarily shared his meals. On the 3rd of October the prisoner was sent to Padua, his allotted place of exile.

The Albizzi speedily saw that they had done either too much or too little. While seeking to keep the government entirely in their own hands, they beheld the continual growth of the Medici party. When it was necessary to make a campaign in Romagna against the mercenary captains commanding the forces of the duke of Milan, it was plainly seen that in banishing Cosimo the republic had lost the only citizen banker in a position to assist it with considerable loans. The Florentines were defeated by Piccinino in 1434, and this event greatly increased the public exasperation against the Albizzi. Meanwhile Cosimo, who had gone to Padua as a private individual, was entertained there like a prince. Then, being permitted to transfer his residence to Venice, he entered on a course of lavish expenditure. He was overwhelmed with letters and appeals from Florence. Finally, on the 1st of September 1434, a signory was elected composed of his friends, and his recall was decreed. Rinaldo degli Albizzi determined to oppose it by force, and rushed to the Piazza with a band of armed men; but his attempt failed, and he left the country to return no more. The Medici were now reinstated in all their former dignities and honours, and Cosimo, on the evening of the 6th of September, rode past the deserted mansions of the Albizzi and re-entered his own dwelling after an exile of a year. For three centuries, dating from that moment, the whole history of Florence was connected with that of the house of Medici.

Cosimo's first thought was to secure himself against all future

risk of removal from Florence, and accordingly he drove the most powerful citizens into exile to all parts of Italy. Nor did he spare even his former political adversary, Palla Strozzi, although the latter had been favourable to him during the recent changes. His rigour in this particular case was universally censured, but Cosimo would tolerate no rivals in the city, and was resolved to abase the great families and establish his power by the support of the lower classes. He was accustomed to say that states could not be ruled by patenosters. Still, when cruelty seemed requisite, he always contrived that the chief odium of it should fall upon others. When Neri Capponi, the valiant soldier and able diplomatist, gained great public favour by his military prowess, and his influence was further increased by the friendship of Baldaccio d'Anghiari, captain of the infantry, Cosimo resolved to weaken his position by indirect means. Accordingly, when in 1441 a partisan of the Medici was elected gonfalonier, Baldaccio was instantly summoned to the palace, imprisoned, murdered, and his body hurled from the window. No one could actually fix this crime upon Cosimo, but the majority believed that he had thus contrived to rid himself of one enemy and cripple another without showing his hand. It was impossible for Cosimo openly to assume the position of tyrant of Florence, nor was it worth his while to become gonfalonier, since the term of office only lasted two months. It was necessary to discover some other way without resorting to violence; he accordingly employed what were then designated "civil methods." He managed to attain his object by means of the *balìa*. These magistracies, which were generally renewed every five years, placed in the ballots the names of the candidates from whom the signory and other chief magistrates were to be chosen. As soon as a *balìa* favourable to Cosimo was formed, he was assured for five years of having the government in the hands of men devoted to his interests. He had comprehended that the art of politics depended rather upon individuals than institutions, and that he who ruled men could also dictate laws. His foreign policy was no less astute. His great wealth enabled him to supply money not only to private individuals, but even to foreign potentates. Philippe de Comines tells us that Cosimo frequently furnished Edward IV. of England with sums amounting to many hundred thousand florins. When Tommaso Parentucelli was still a cardinal, and in needy circumstances, Cosimo made him considerable loans without demanding guarantees of payment. On the cardinal's accession to the tiara as Nicholas V. he was naturally very well disposed towards Cosimo, and employed the Medici bank in Rome in all the affairs of the curia. At the time when Francesco Sforza was striving for the lordship of Milan, Cosimo foresaw his approaching triumph, showed him great friendship, and aided him with large sums of money. Accordingly, when Sforza became lord of Milan, Cosimo's power was doubled.

Without the title of prince, this merchant showed royal generosity in his expenditure for the promotion of letters and the fine arts. Besides his palace in the city, he constructed noble villas at Careggi, Fiesole and other places. He built the basilica of Fiesole, and that of St Lorenzo in Florence, and enlarged the church and monastery of St Mark. Even in distant Jerusalem he endowed a hospice for the use of pilgrims. The artists of the day comprised men like Donatello, Brunelleschi, Ghiberti, Luca della Robbia, and many others, and Cosimo's magnificent commissions not only developed their powers but stimulated other men of wealth to the patronage of art. Without being a scholar, Cosimo had a genuine taste for letters. He purchased many Greek and Latin manuscripts; he opened the first public library at St Mark's at his own expense, and founded another in the abbey of Fiesole. The Greek refugees from Constantinople found a constant welcome in his palace. During the Council of Florence (1439-1442), Gemistus Pletho spoke to him with enthusiasm of the Platonic philosophy. Cosimo was so deeply attracted by the theme that he decided to have the young Marsilio Ficino trained in philosophy and Greek learning in order to make a Latin translation of the complete works of Plato. And thus

The Government of Florence.

Cosimo's Patronage of Art.

version was produced that is still considered one of the best extant, and that Platonic academy was founded which led to such important results in the history of Italian philosophy and letters. On the 1st of August 1464 Cosimo breathed his last, at the age of seventy-five, while engaged in listening to one of Plato's dialogues.

The concluding years of his life had been years of little happiness for Florence. Being old and infirm, he had left the government to the management of his friends, among whom Luca Pitti was one of the most powerful, and they had ruled with disorder, corruption and cruelty. The lordship of Florence accordingly did not pass without some difficulty and danger into the hands of

Piero, surnamed the Gouty, Cosimo's only surviving legitimate son. Afflicted by gout, and so terribly crippled that he was often only able to use his tongue, the new ruler soon discovered that a plot was on foot to overthrow his power. However, showing far more courage than he was supposed to possess, he had himself borne on a litter from his villa to Florence, defeated his enemies' designs, and firmly re-established his authority. But his success may be mainly attributed to the enormous prestige bequeathed by Cosimo to his posterity. Piero died at the end of five years' reign, on the 3rd of December 1469, leaving two sons, Lorenzo (1449-1492) and Giuliano (1453-1478). The younger, the gentler and less ambitious of the pair, was quickly removed from the world. Lorenzo, on the contrary, at once seized the reins of state with a firm grasp, and was, chronologically, the second of the great men bestowed upon Italy by the house of Medici. In literary talent he was immensely superior to Cosimo, but greatly his inferior in the conduct of the commercial affairs of the house. In politics he had nobler conceptions and higher ambitions, but he was more easily carried away by his passions, less prudent in his revenge, and more disposed to tyranny. He had studied letters from his earliest years under the guidance of Ficino and other leading literati of the day. At the age of eighteen he visited the different courts of Italy. At his father's death he was only twenty-one

years old, but instantly showed his determination to govern Florence with greater despotism than his father or grandfather. He speedily resorted to the system of the *balie*, and was very dexterous in causing the first to be chosen to suit his purpose. He then proceeded to humiliate the great families and exalt those of little account, and this was the policy he constantly pursued. His younger brother Giuliano, being of a mild and yielding disposition, had only a nominal share in the government.

Lorenzo's policy, although prosecuted with less caution, was still the old astute and fortunate policy initiated by Cosimo. But the grandson bestowed no care upon his commercial interests, although squandering his fortune with far greater lavishness. Accordingly he was sometimes driven to help himself from the public purse without ever being able to assist it as Cosimo had done. All this excited blame and enmity against him, while his greed in the matter of the alum mines of Volterra, and the subsequent sack of that unhappy city, were crimes for which there was no excuse. Among his worst enemies were the Pazzi, and, as they formed a very powerful clan, he sought their ruin by competing with them even in business transactions. They were on the point of inheriting the large property of Giovanni Borromeo when Lorenzo hurriedly caused a law to be passed that altered the right of succession. The hatred of the Pazzi was thereby exasperated to fury. And in addition to these things there ensued a desperate quarrel with Pope Sixtus IV., a man of very impetuous temper, who, on endeavouring to erect a state on the frontiers of the Florentine republic for the benefit of his nephews, found a determined and successful opponent in Lorenzo. Consequently the Pazzi and Archbishop Salviati, another enemy of Lorenzo, aided by the nephews of the pontiff, who was himself acquainted with the whole matter, determined to put an end to the family. On the 26th of April 1478, while Giuliano and Lorenzo were attending high mass in the cathedral of Florence, the former was mortally stabbed by conspirators,

but the latter was able to beat back his assailants and escape into the sacristy. His life preserved, and no longer having to share the government with a brother, Lorenzo profited by the opportunity to wreak cruel vengeance upon his foes. Several of the Pazzi and their followers were hanged from the palace windows; others were hacked to pieces, dragged through the streets, and cast into the Arno, while a great many more were condemned to death or sent into exile. Lorenzo seemed willing and able to become a tyrant. But he stopped short of this point. He knew the temper of the city, and had also to look to fresh dangers threatening him from without. The pope had excommunicated him, put Florence under an interdict, and, being seconded by the Neapolitan king, made furious war against the republic. The Florentines began to tire of submitting to so many hardships in order to support the yoke of a fellow-citizen. Lorenzo's hold over Florence seemed endangered. But he rose superior to the difficulties by which he was encompassed. He boldly journeyed to Naples, to the court of King Ferdinand of Aragon, who was reputed to be as treacherous as he was cruel, and succeeded in obtaining from him an honourable peace, that soon led to a reconciliation with Sixtus. Thus at last Lorenzo found himself complete master of Florence. But, as the *balie* changed every five years, it was always requisite, in order to retain his supremacy, that he should be prepared to renew the usual manoeuvre at the close of that term and have another elected equally favourable to his aims. This was often a difficult achievement, and Lorenzo showed much dexterity in overcoming all obstacles. In 1480 he compassed the institution of a new council of seventy, which was practically a permanent *balia* with extended powers, inasmuch as it not only elected the chief magistrates, but had also the administration of numerous state affairs. This permanent council of devoted adherents once formed, his security was firmly established. By this means, the chroniclers tell us, "liberty was buried," but the chief affairs of the state were always conducted by intelligent and experienced men, who promoted the public prosperity. Florence was still called a republic; the old institutions were still preserved, if only in name. Lorenzo was absolute lord of all, and virtually a tyrant. His immorality was scandalous; he kept an army of spies; he frequently meddled in the citizens' most private affairs, and exalted men of the lowest condition to important offices of the state. Yet, as Guicciardini remarks, "if Florence was to have a tyrant, she could never have found a better or more pleasant one." In fact all industry, commerce and public works made enormous progress. The civil equality of modern states, which was quite unknown to the middle ages, was more developed in Florence than in any other city of the world. Even the condition of the peasantry was far more prosperous than elsewhere. Lorenzo's authority was not confined to Tuscany, but was also very great throughout the whole of Italy. He was on the friendliest terms with Pope Innocent VIII., from whom he obtained the exaltation of his son Giovanni to the cardinalate at the age of fourteen. This boy-cardinal was afterwards Pope Leo X. From the moment of the decease of Sixtus IV., the union of Florence and Rome became the basis of Lorenzo's foreign policy. By its means he was able to prevent the hatreds and jealousies of the Sforzas of Milan and the Aragonese of Naples from bursting into the open conflict that long threatened, and after his death actually caused, the beginning of new and irreparable calamities. Hence Lorenzo was styled the needle of the Italian compass.

But the events we have narrated cannot suffice for the full comprehension of this complex character, unless we add the record of his deeds as a patron of letters and his achievements as a writer. His palace was the school and resort of illustrious men. Within its walls were trained the two young Medici afterwards known to the world as Leo X. and Clement VII. Ficino, Poliziano, Pico della Mirandola and all members of the Platonic academy were its constant habitués. It was here that Pulci gave readings of his *Morgante*, and Michelangelo essayed the first strokes of his chisel. Lorenzo's intellectual powers were of exceptional strength and versatility. He could speak with

equal fluency on painting, sculpture, music, philosophy and poetry. But his crowning superiority over every other Maecenas known to history lay in his active participation in the intellectual labours that he promoted. Indeed at certain moments he was **Lorenzo as a Man of Letters.** positively the leading spirit among the literati of his time. He was an elegant prose writer, and was likewise a poet of real originality. At that period Italians were forsaking erudition in order to forward the revival of the national literature by recurring to the primitive sources of the spoken tongue and popular verse. It is Lorenzo's lasting glory to have been the initiator of this movement. Without being—as some have maintained—a poet of genius, he was certainly a writer of much finish and eloquence, and one of the first to raise popular poetry to the dignity of art. In his *Ambra*, his *Caccia del falcone* and his *Nencia da Barberino*, he gives descriptions of nature and of the rural life that he loved, with the graphic power of an acute and tasteful observer, joined to an ease of style that occasionally sins by excess of homeliness. Both in his art and in his politics he leaned upon the people. The more oppressive his government, the more did he seek in his verses to incite the public to festivities and lull it to slumber by sensual enjoyments. In his *Ballate*, or songs for dancing, and more especially in his carnival songs, a kind of verse invented by himself, Lorenzo displayed all the best qualities and worst defects of his muse. Marvellously and spontaneously elegant, very truthful and fresh in style, fertile in fancy and rich in colour, they are often of a most revolting indecency. And these compositions of one filling a princely station in the city were often sung by their author in the public streets, in the midst of the populace.

Lorenzo left three sons—Pietro (1471-1503), Giovanni (1475-1521) and Giuliano (1479-1516). He was succeeded by Pietro, whose rule lasted but for two years. During this brief term he performed no good deeds, and only displayed inordinate vanity and frivolity. His conduct greatly helped to foment the hatred between Lodovico Storza and Ferdinand of Naples, which hastened the coming of the French under Charles VIII., and the renewal of foreign invasions. No sooner did the French approach the frontiers of Tuscany than Pietro, crazed with fear, hastened to meet them, and, basely yielding to every demand, accepted terms equally humiliating to himself and the state. But, returning to Florence, he found that the enraged citizens had already decreed his deposition, in order to reconstitute the republic, and was therefore compelled to escape to Venice. His various plots to reinstate himself in Florence were all unsuccessful. At last he went to the south of Italy with the French, was drowned at the passage of the Garigliano in 1503, and was buried in the cloister of Monte Cassino.

Pietro.

The ensuing period was adverse to the Medici, for a republican government was maintained in Florence from 1494 to 1512, and the city remained faithful to its alliance with the French, who were all-powerful in Italy. Cardinal Giovanni, the head of the family, resided in Rome, playing the patron to a circle of litterati, artists and friends, seeking to increase his popularity, and calmly waiting for better days. The battle of Ravenna wrought the downfall of the fortunes of France in Italy, and led to the rise of those of Spain, whose troops entered Florence to destroy the republic and reinstate the Medici. Pietro had now been dead for some time, leaving a young son, Lorenzo (1492-1519), who was afterwards duke of Urbino. The following year (1513) Cardinal Giovanni was elected pope, and assumed the name of

Leo X. He accordingly removed to Rome, leaving his brother Giuliano with his nephew Lorenzo in Florence, and accompanied by his cousin Giulio, Giuliano, who was a natural son of the Giuliano murdered in the conspiracy of the Pazzi, and was soon destined to be a cardinal and ultimately a pope. Meanwhile his kinsmen in Florence continued to govern that city by means of a *balìa*. And thus, being masters of the whole of central Italy, the Medici enjoyed great authority throughout the country and their ambition plumed itself for still higher flights. This was the moment when Niccolò Machiavelli, in his treatise *The*

Cardinal Giovanni (Leo X.). Giuliano, Lorenzo.

Prince, counselled them to accomplish the unity of Italy by arming the whole nation, and expelling its foreign invaders.

Leo X., who is only indirectly connected with the history of Florence, gave his name to the age in which he lived in consequence of his magnificent patronage of art and letters in Rome. But he was merely a clever amateur, and had not the literary gifts of his father Lorenzo. He surrounded himself with versifiers and inferior writers, who enlivened his board and accompanied him wherever he went. He liked to lead a gay and untroubled life, was fond of theatrical performances, satires and other intellectual diversions. His patronage of the fine arts, his genuine affection for Raphael, and the numerous works he caused to be executed by him and other artists, have served to confer an exaggerated glory on his name. He had not the remotest idea of the grave importance of the Reformation, which indeed he unconsciously promoted by his reckless and shameless sale of indulgences. The whole policy of Pope Leo X. consisted in oscillating between France and Spain, in always playing fast and loose, and deceiving both powers in turn. Yet the evil results of this contemptible policy never seemed to disturb his mind. He finally joined the side of the emperor Charles V., and in 1521, at the time of the defeat of the French by the Spanish troops on the river Adda, he ceased to breathe at his favourite villa of Magliana.

Giuliano dei Medici had died during Leo's reign, in 1516, without having ever done anything worthy of record. He was the husband of Philiberta of Savoy, was duke of Nemours, and left a natural son, Ippolito dei Medici (1511-1535), who afterwards became a cardinal. Lorenzo, being of more ambitious temper, was by no means content to remain at the head of the Florence government hampered by many restrictions imposed by republican institutions, and subject to the incessant control of the pope. In his eagerness to aggrandize his kinsmen, the latter had further decided to give Lorenzo the duchy of Urbino, and formally invested him in its rights, after expelling on false pretences its legitimate lord, Francesco Maria della Rovere. This prince, however, soon returned to Urbino, where he was joyously welcomed by his subjects, and Lorenzo regained possession only by a war of several months, in which he was wounded. In 1519 he also died, worn out by disease and excess. By his marriage with Madeleine de la Tour d'Auvergne, he had one daughter, Caterina dei Medici (1519-1589), married in 1533 to Henry, duke of Orleans, afterwards king of France. She played a long and sinister part in the history of that country. Lorenzo also left a natural son named Alessandro, inheriting the frizzled hair and projecting lips of the negro or mulatto slave who had given him birth. His miserable death will be presently related. Thus the only three surviving representatives of the chief branch of the Medici, Cardinal Giulio, Ippolito and Alessandro were all of illegitimate birth, and left no legitimate heirs.

Cardinal Giulio, who had laboured successfully for the reinstatement of his family in Florence in 1512, had been long attached to the person of Leo X. as his trusted factotum and companion. He had been generally regarded as the mentor of the pope, who had no liking for hard work. But in fact, his frivolity notwithstanding, Leo X. always followed his own inclinations. He had much aptitude for command, and pursued his shuffling policy without any mental anxiety. Giulio, on the contrary, shrank from all responsibility, muddled his brains in weighing the reasons for and against every possible decision, and was therefore a better tool of government in others' hands than he was fit to govern on his own account. When Giuliano and Lorenzo died, the pope appointed the cardinal to the government of Florence. In that post, restricted within the limits imposed by republican institutions, and acting under the continual direction of Rome, he performed his duties fairly well. He caressed the citizens with hopes of extended liberties, which, although never destined to be fulfilled, long served to keep men's minds in a pleasant flutter of expectation; and when the more impatient spirits attempted to raise a rebellion he speedily quenched it in blood. When, after the death of Leo X. and the very brief pontificate

Cardinal Giulio (Clement VII.).

of Adrian VI, he was elected pope (1523) under the name of Clement VII, he entrusted the government of Florence to Cardinal Silvio Passerini conjointly with Alessandro and Ippolito, who were still too young to do much on their own account.

The pontificate of Leo X. had been a time of felicity to himself if of disaster to Italy and the Church. The reign of Clement, on the contrary, was fatal to himself as well. His policy, like that of Leo X., consisted in perpetual oscillation between France and Spain. By his endeavours to trick all the world, he frequently ended in being tricked himself. In 1525 he was the ally of the French, who then suffered a terrible defeat at Pavia, where their king Francis I. was taken prisoner. The armies of Charles V. triumphantly advanced, without Clement being able to oppose any effectual resistance. Both Rome and Florence were threatened with a fearful catastrophe.

Thus far we have had no occasion to speak of the younger branch of the Medici, descended from Lorenzo, brother to Cosimo the elder. Always in obscurity, and hitherto held in check by the elder line, it first entered the arena of history when the other was on the point of extinction. In fact the most valiant captain of the papal forces was Giovanni dei Medici, afterwards known by the name of Giovanni delle Bande Nere. His father was Giovanni, son of Pier Francesco, who was the son of Lorenzo, the brother of Cosimo dei Medici. History has little to tell of the elder Giovanni; but his wife Caterina Sforza, of whom he was the third husband, was a woman of more than masculine vigour. Giovanni dei Medici married her in 1497, but died in 1498, leaving her with one son who was christened Lodovico, but afterwards took his father's name of Giovanni (1498-1526).

Giovanni delle Bande Nere.

Trained to arms from his earliest years, this youth inherited all the energy of his mother, whose Sforza blood seemed to infuse new life into the younger branch of the Medici. Notwithstanding his extreme youth, he had already achieved the title of the best captain in Italy. He had always fought with immense dash and daring, and was devotedly loved and obeyed by his soldiery. He was the only leader who opposed a determined resistance to the imperial forces. He was seriously wounded at Pavia when fighting on the French side. On his recovery he joined the army of the League, and was much enraged by finding that the duke of Urbino, commander of the Venetian and papal forces, would never decide on attacking. When the imperial troops were struggling through the marshes of Mantua, surrounded on every side, and without stores or ammunition, Giovanni could not resign himself to inactivity like his colleagues in command. He was ignorant that the imperialists had just received supplies and artillery from the duke of Ferrara, and therefore daringly attacked them with a small body of men without taking any precautions for defence. One of the first shots fired by the enemy injured him so fatally that he died a few days after. He was married to Maria Salviati, by whom he had one son, Cosimo (1519-1574), who became the first grand duke of Tuscany, and indeed the founder of the grand duchy and the new dynasty.

Meanwhile the imperial army pursued its march upon Rome, captured the Eternal City after a few hours' combat, and cruelly sacked it during many days (1527). Thanks to his perpetual shuffling and excessive avarice, the pope found himself utterly forsaken, and was obliged to seek refuge in the castle of St Angelo, whence he only effected his escape after some months. He then signed a treaty of alliance with the emperor (1529), who sent an army to besiege Florence and restore the Medici, whom the people had expelled in 1527 on the re-establishment of the republic. After an heroic defence, the city was forced to surrender (1530); and, although it was expressly stipulated that the ancient liberties of Florence should be respected, every one foresaw that the conditions would be violated. In fact, pope and emperor immediately began to dispute as to which should be the new lord of the city. Clement VII. had inherited the traditional family dislike for the younger branch of his kin, and so the choice lay between the two bastards Ippolito and Alessandro. The former being a cardinal, the latter was chosen.

Alessandro, who already bore the title of duke of Città di Pienza, came to Florence in 1531, and by imperial patent was nominated head of the republic. According to the terms of this patent, the former liberty enjoyed under the Medicean rule was to remain intact. But no previous ruler of the city had enjoyed hereditary power conferred by imperial patent, and such power was incompatible with the existence of a republic. Moreover, Clement VII. showed dissatisfaction with the uncertainty of the power conferred upon his kinsman, and finally succeeded in obtaining additional privileges. On the 4th of April 1532 a parliament was convoked for the last time in Florence, and, as usual, approved every measure proposed for acceptance. Accordingly a new council was formed of two hundred citizens elected for life, forty-eight of which number were to constitute a senate. Alessandro, as duke of the republic, filled the post of gonfalonier, and carried on the government with the assistance of three senators, changed every three months, who took the place of the suppressed signory.

The duke's chief advisers, and the contrivers of all these arrangements were Baccio Valori, Francesco Vettori and above all Francesco Guicciardini—men, especially the latter two, of lofty political gifts and extensive influence. The mind and character of Duke Alessandro were as yet comparatively unknown. At first he seemed disposed to rule with justice and prudence. But encountering difficulties that he was unable to overcome, he began to neglect the business of the state, and acted as if the sole function of government consisted in lulling the people by festivities and corrupting it by the dissolute life of which he set the example. The question of the moment was the transformation of the old republican régime into a principedom; as an unavoidable result of this change it followed that Florence was no longer to be the ruling city to whose inhabitants alone belonged the monopoly of political office. When the leading Florentine families realized not only that the republic was destroyed, but that they were reduced to equality with those whom they had hitherto regarded as their inferiors and subjects, their rage was indescribable, and hardly a day passed without the departure of influential citizens who were resolved to achieve the overthrow of their new ruler. They found a leader in Cardinal Ippolito dei Medici, who was then in Rome, embittered by the preference given to Alessandro, and anxious to become his successor with the least possible delay. Under the pressure of terror the duke at once became a tyrant. He garrisoned the different cities, and began the erection in Florence of the Fortezza da Basso, built chiefly at the expense of Filippo Strozzi, who afterwards met his death within its walls.

Cardinal Ippolito.

In 1534 Clement VII. died, and the election fell on Paul III., from whom Cardinal Ippolito hoped to obtain assistance. Accordingly the principal Florentine exiles were despatched to Charles V. with complaints of Alessandro's tyranny and his shameless violation of the terms upon which the city had surrendered. Cardinal Ippolito also represented his own willingness to carry on the government of Florence in a more equitable manner, and promised the emperor a large sum of money. Reply being delayed by the emperor's absence, he became so impatient that he set out to meet Charles in Tunis, but on the 10th of August 1535 died suddenly at Itri, poisoned by order of Alessandro. Such at least was the general belief, and it was confirmed by the same fate befalling other enemies of the duke about the same time. On the emperor's return from Africa, the exiles presented themselves to him in Naples, and the venerable patriot Jacopo Nardi pleaded their cause. Duke Alessandro, being cited to appear, came to Naples accompanied by Francesco Guicciardini, who by speaking in his defence rendered himself odious to all friends of liberty, and irretrievably tarnished his illustrious name. The cardinal being dead, it was hard to find a successor to Alessandro. On this account, and perhaps to some extent through the emperor's personal liking for the duke, the latter rose higher than before in the imperial favour, married Margaret of Austria, the natural daughter of Charles,

and returned to Florence with increased power. And now Alessandro indulged unchecked in the lowest excesses of tyranny, and although so recently a bridegroom gave way to increased libertinism. His whole time was passed in vicious haunts and in scandalous adventures. In order to conceal the obscurity of his birth, he left his mother to starve, and it was even asserted that he finally got rid of her by poison.

His constant associate in this disgraceful routine was his distant kinsman Lorenzo, generally known as Lorenzino dei

Lorenzino dei Medici. Of the younger branch of the Medici, the latter was second cousin of the Cosimo already mentioned as the son of Giovanni delle Bande Nere.

He had much culture and literary talent, but led an irregular life, sometimes acting like a madman and sometimes like a villain. He was a writer of considerable elegance, the author of several plays, one of which, the *Aridosio*, was held to be among the best of his age, and he was a worshipper of antiquity. Notwithstanding these tastes, when in Rome he knocked off the heads of some of the finest statues of the age of Adrian, an act by which Clement VII. was so incensed that he threatened to have him hanged. Thereupon Lorenzino fled to Florence, where he became the friend of Duke Alessandro, and his partner in the most licentious excesses. They went together to houses of ill-fame, and violated private dwellings and convents. They often showed themselves in public mounted on the same horse. All Florence eyed them with disgust, but no one foresaw the tragedy that was soon to take place.

On the evening of the 5th of January 1537, after a day passed in the usual excesses, Lorenzino led the duke to his own lodging, and left him there, promising shortly to return with the wife of Leonardo Ginori. Alessandro, worn out by the exertions of the day, fell asleep on the couch while awaiting Lorenzino's return. Before long the latter came accompanied by a desperado known as the Scoronocolo, who aided him in falling on the sleeper. Roused by their first thrusts, the duke fought for his life, and was only despatched after a violent struggle. The murderers then lifted the body into a bed, hid it beneath the clothes, and, Lorenzino having attached a paper to it bearing the words *vincit amor patriæ, laudamque immensa cupido*, they both fled to Venice. In that city Lorenzino was assassinated some ten years later, in 1548, at the age of thirty-two, by order of Alessandro's successor. He wrote an *Apologia*, in which he defended himself with great skill and eloquence, saying that he had been urged to the deed solely by love of liberty. For this reason alone he had followed the example of Brutus and played the part of friend and courtier. The tone of this *Apologia* is so straightforward, sometimes even so eloquent and lofty, that we should be tempted to give it credence were it possible to believe the assertions of one who not only by his crime but by the infamy of his previous and subsequent career completely gave the lie to his vaunted nobility of purpose. By Alessandro's death the elder branch of the Medici became extinct, and thus the appearance of the younger line was heralded by a bloody crime.

When the duke's absence from his own palace was discovered on the morning of the 6th of January he was at first supposed to have spent the night with one of his mistresses; but soon, some alarm being felt, search was made, and Cardinal Cybo was the first to discover the murder. Enjoining the strictest secrecy, he kept the corpse concealed for three days, and then had it interred in the sacristy of San Lorenzo. Meanwhile he had hastily summoned Alessandro Vitelli and the other captains, so that, by the time Alessandro's death was made public, the city was already filled with troops. The cardinal then convoked the council of forty-eight to decide upon a successor. Alessandro's only issue was a natural son named Giulio, aged five. The cardinal favoured his election, in the hope of keeping the real sovereignty in his own hands. But he speedily saw the impossibility of carrying out a design that was ridiculed by all. Guicciardini, Vettori and others of the leading citizens favoured the choice of Cosimo, the son of Giovanni delle Bande Nere. He was already in Florence, was aged seventeen, was

keen-witted and aspiring, strong and handsome in person, heir to the enormous wealth of the Medici, and, by the terms of the imperial patent, was Alessandro's lawful successor. Charles V. approved the nomination of Cosimo, who without delay seized the reins of government with a firm grasp. Like Alessandro, he was named head of the republic; and Guicciardini and others who had worked hardest in his cause hoped to direct him and keep him under their control. But Cosimo soon proved that, his youth notwithstanding, he was resolved to rule unshackled by republican forms and unhampered by advisers disposed to act as mentors. The Florentines had now an absolute prince who was likewise a statesman of eminent ability.

On learning the death of Alessandro and the election of Cosimo, the exiles appreciated the necessity for prompt action, as delay would be fatal to the overthrow of the Medicean rule. They had received money and promises from France; they were strengthened by the adhesion of Filippo Strozzi and Baccio Valori, who had both become hostile to the Medici through the infamous conduct and mad tyranny of Alessandro; and Strozzi brought them the help of his enormous fortune and the prowess of that very distinguished captain, his son Piero. The exiles assembled their forces at Mirandola. They had about four thousand infantry and three hundred horse; among them were members of all the principal Florentine families; and their leaders were Bernardo Salviati and Piero Strozzi. They marched rapidly, and entered Tuscany towards the end of July 1537. Cosimo on this occasion displayed signal capacity and presence of mind. Informed of the exiles' movements by his spies, he no sooner learned their approach than he ordered Alessandro Vitelli to collect the best German, Spanish and Italian infantry at his disposal, and advance against the enemy without delay. On the evening of the 31st of July Vitelli marched towards Prato with seven hundred picked infantry and a band of one hundred horse, and on the way fell in with other Spanish foot soldiers who joined the expedition. At early dawn the following morning he made a sudden attack on the exiles' advanced guard close to Montemurlo, an old fortress converted into a villa belonging to the Nerli. Having utterly routed them, he proceeded to storm Montemurlo, where Filippo Strozzi and a few of his young comrades had taken refuge. They made a desperate resistance for some hours, and then, overwhelmed by superior numbers, were obliged to yield themselves prisoners. The main body of the army was still at some distance, having been detained in the mountains by heavy rains and difficult passes, and, on learning the defeat at Montemurlo, its leader turned back by the way he had come. Alessandro Vitelli re-entered Florence with his victorious army and his fettered captives. Cosimo had achieved his first triumph.

All the prisoners, who were members of great families, were brought before Cosimo, and were received by him with courteous coldness. Soon, however, a scaffold was erected in the Piazza, and on four mornings in succession four of the prisoners were beheaded. Then the duke saw fit to stay the executions. Baccio Valori, however, and his son and nephew were beheaded on the 20th of August in the courtyard of the Bargello. Filippo Strozzi still survived, confined in the Fortezza da Basso, that had been built at his expense. His family was illustrious, he had numerous adherents, and he enjoyed the protection of the French king. Nevertheless Cosimo only awaited some plausible pretext to rid himself of this dreaded enemy. He brought him to trial and had him put to the question. But this cruelty led to nothing, for Strozzi denied every accusation and bore the torture with much fortitude. On the 18th of December he was found dead in his prison, with a blood-stained sword by his side, and a slip of paper bearing these words: *exoriare aliquis nostris ex ossibus ultor*. It was believed that, having renounced all hope of his life being spared, Strozzi had preferred suicide to death at the hands of the executioner. Some, however, thought that Cosimo had caused him to be murdered, and adopted this mode of concealing the crime. The young prince's cold-blooded massacre of his captives cast an enduring shadow upon his reign and dynasty. But it was henceforward plain to all that he was

a man of stern resolve, who went straight to his end without scruples or half-measures. Before long he was regarded by many as the incarnation of Machiavelli's *Prince*, "inasmuch as he joined daring to talent and prudence, was capable of great cruelty, and yet could practise mercy in due season." Guicciardini, who still pretended to act as mentor, and who on account of his many services had a certain influence over him, was obliged to withdraw from public life and busy himself with writing his *History* at his villa of Arcetri. He died in this retreat in 1540, and it was immediately rumoured that the duke had caused him to be poisoned. This shows the estimation in which Cosimo was now held. He punished with death all who dared to resist his will. By 1540 sentence of death had been pronounced against four hundred and thirty contumacious fugitives, and during his reign one hundred and forty men and six women actually ascended the scaffold, without counting those who perished in foreign lands by the daggers of his assassins. He reduced the old republican institutions to empty forms, by making the magistrates mere creatures of his will. He issued the sternest edicts against the rebels, particularly by the law known as the "Polverina," from the name of its proposer Jacopo Polverini. This law decreed not only the confiscation of the property of exiles, but likewise that of their heirs, even if personally acquired by the latter. Cosimo ruled like the independent sovereign of a great state, and always showed the capacity, firmness and courage demanded by that station. Only, his state being small and weak, he was forced to rely chiefly upon his personal talent and wealth. It was necessary for him to make heavy loans to the different European sovereigns, especially to Charles V., the most rapacious of them all, and to give enormous bribes to their ambassadors. Besides, he had to carry on wars for the extension of his dominions; and neither his inherited wealth nor the large sums gained by confiscating the estates of rebellious subjects sufficed for all this outlay. He was accordingly compelled to burden the people with taxes, and thus begin at once to diminish its strength.

Cosimo bore a special grudge against the neighbouring republics of Siena and Lucca. Although the latter was small and weak, and the former garrisoned by Spaniards, yet the spectacle of free institutions at the frontiers of his own state served as a continual incitement to subjects disaffected to the new régime. In fact Francesco Burlamacchi, a zealous Lucchese patriot, had conceived the design of re-establishing republican government in all the cities of Tuscany. Cosimo, with the emperor's help, succeeded in having him put to death. Lucca, however, was an insignificant state making no pretence of rivalry, whereas Siena was an old and formidable foe to Florence, and had always given protection to the Florentine exiles. It was now very reluctantly submitting to the presence of a Spanish garrison, and, being stimulated by promises of prompt and efficacious assistance from France, rose in rebellion and expelled the Spaniards in 1552. Cosimo instantly wrote to the emperor in terms that appealed to his pride, asked leave to attack Siena, and begged for troops to ensure the success of his enterprise. As no immediate answer arrived, he feigned to begin negotiations with Henry II. of France, and, by thus arousing the imperial jealousy, obtained a contingent of German and Spanish infantry. Siena was besieged for fifteen months, and its inhabitants, aided by the valour of Piero Strozzi, who fought under the French flag, made a most heroic resistance, even women and children helping on the walls. But fortune was against them. Piero Strozzi sustained several defeats, and finally the Siennese, having exhausted their ammunition and being decimated by famine and the sword, were obliged to capitulate on honourable terms that were shamelessly violated. By the varied disasters of the siege and the number of fugitives the population was reduced from forty to eight thousand inhabitants. The republicans, still eager to resist, withdrew to Montalcino. Cosimo now ruled the city and territory of Siena in the name of Charles V., who always refused him its absolute possession. After the emperor's abdication, and the succession of Philip II. to the Spanish throne, Cosimo

at last obtained Siena and Porto Ferraio by giving up his claim to a sum of 200,000 ducats that he was to have received from Charles V.

In 1559 Cosimo also captured Montalcino, and thus formed the grand-duchy of Tuscany, but he continued to govern the new state—i.e. Siena and its territories—separately from the old. His rule was intelligent, skillful and des- ^{Grand-Duchy of Tuscany formed.} potic; but his enormous expenses drove him to raise large sums of money by special contrivances unsuited to the country and the people. Hence, notwithstanding the genius of its founder, the grand-duchy held from the first the elements of its future decay. Cosimo preferred to confer office upon men of humble origin in order to have pliable tools, but he also liked to be surrounded by a courtier aristocracy on the Spanish and French pattern. As no Tuscan aristocracy any longer existed, he created new nobles, and tempted foreign ones to come by the concession of various feudal privileges; and, to turn this artificial aristocracy to some account, he founded the knightly order of St Stephen, charged with the defence of the coast against pirates, which in course of time won much honour by its prowess. He also established a small standing army for the protection of his frontiers; but he generally employed German and Spanish troops for his wars, and always had a foreign body-guard. At the commencement of his reign he opposed the popes in order to maintain the independence of his own state; but later, to obtain help, he truckled to them in many ways, even to the extent of giving up to the Inquisition his own confidant, Piero Carnesecchi, who, being accused of heresy, was beheaded and burnt in 1567. In reward for these acts of submission, the popes showed him friendship, and Pius V. granted him the title of grand-duke, conferring the patent and crown upon him in Rome, although the emperor had always withheld his consent. The measure most injurious to Tuscany was the fiscal system of taxes, of which the sole aim was to extort the greatest possible amount of money. The consequent damage to industry, commerce and agriculture was immense, and, added to the devastations caused by the Siennese War, led to their utter ruin. Otherwise Cosimo did not neglect useful measures for the interior prosperity of his state. He was no Mæcenas; nevertheless he restored the Pisan university, enlarged that of Siena, had the public records classified, and also executed public works like the Santa Trinità bridge. During the great inundations of 1557 he turned his whole energy to the relief of the sufferers.

In 1539 he had espoused Eleonora of Toledo, daughter of the viceroy of Naples, by whom he had several children. Two died in 1562, and their mother soon followed them to the grave. It was said that one of these boys, Don Garcia, had murdered the other, and then been killed by the enraged father. Indeed, Cosimo was further accused of having put his own wife to death; but neither rumour had any foundation. He now showed signs of illness and failure of strength. He was not old, but worn by the cares of state and self-indulgence. Accordingly in 1564 he resigned the government to his eldest son, who was to act as his lieutenant, since he wished to have power to resume the sceptre on any emergency. In 1570, by the advice of Pope Pius V., he married Camilla Martelli, a young lady of whom he had been long enamoured. In 1574 he died, at the age of fifty-four years and ten months, after a reign of thirty-seven years, leaving three sons and one daughter besides natural children. These sons were Francesco, his successor, who was already at the head of the government, Cardinal Ferdinand, and Piero.

Francesco I., born in 1541, began to govern as his father's lieutenant in 1564, and was married in 1565 to the archduchess Giovanna of Austria. On beginning to reign on his ^{Francesco I.} own account in 1574, he speedily manifested his real character. His training in the hands of a Spanish mother had made him suspicious, false and despotic. Holding every one aloof, he carried on the government with the assistance of a few devoted ministers. He compelled his step-mother to retire to a convent, and kept his brothers at a distance from Florence. He loved the privileges of power without its burdens. Cosimo had known how to maintain his independence, but Francesco cast

himself like a vassal at Austria's feet. He reaped his reward by obtaining from Maximilian II. the title of grand-duke, for which Cosimo had never been able to win the imperial sanction, but he forfeited all independence. Towards Philip II. he showed even greater submissiveness, supplying him with large sums of money wrung from his overtaxed people. He held entirely aloof from France, in order not to awake the suspicions of his protectors. He traded on his own account, thus creating a monopoly that was ruinous to the country. He raised the tax upon corn to so high a rate that few continued to find any profit in growing it, and thus the Maremme, already partly devastated during the war with Siena, were converted into a desert. Even industry declined under this system of government; and, although Francesco founded porcelain manufactories and pietra dura works, they did not rise to any prosperity until after his death. His love of science and letters was the only Medicæan virtue that he possessed. He had an absolute passion for chemistry, and passed much of his time in his laboratory. Sometimes indeed he gave audience to his secretaries of state standing before a furnace, bellows in hand. He took some useful measures to promote the rise of a new city at Leghorn, which at that time had only a natural and ill-sheltered harbour. The improvement of Leghorn had been first projected by Cosimo I., and was carried on by all the succeeding Medici. Francesco was a slave to his passions, and was led by them to scandalous excesses and deeds of bloodshed. His example and neglect of the affairs of the state soon caused a vast increase of crime even among the poor, and, during the first eighteen months of his reign, there occurred no fewer than one hundred and sixty-eight murders.

In default of public events, the historians of this period enlarge upon private incidents, generally of a scandalous or sanguinary kind. In 1575 Orazio Pucci, wishing to avenge his father, whom Cosimo had hanged, determined to get up a conspiracy, but, soon recognizing how firmly the Medicæan rule had taken root in the country, desisted from the attempt. But the grand-duke, on hearing of the already abandoned plot, immediately caused Pucci to be hanged from the same window of the Palazzo Vecchio, and even from the same iron stanchion, from which his father before him had hung. His companions, who had fled to France and England, were pursued and murdered by the ducal emissaries. Their possessions were confiscated, and the "Polverina" law applied, so that the conspirators' heirs were reduced to penury, and the grand-duke gained more than 300,000 ducats.

Next year Isabella dei Medici, Francesco's sister, was strangled in her nuptial bed by her husband, Paolo Giordano Orsini, whom she had betrayed. Piero dei Medici, Francesco's brother, murdered his wife Eleonora of Toledo from the same motive. Still louder scandal was caused by the duke's own conduct. He was already a married man, when, passing one day through the Piazza of St. Mark in Florence, he saw an exceedingly beautiful woman at the window of a mean dwelling, and at once conceived a passion for her. She was the famous Bianca Cappello, a Venetian of noble birth, who had eloped with a young Florentine named Pietro Buonaventuri, to whom she was married at the time that she attracted the duke's gaze. He made her acquaintance, and, in order to see her frequently, nominated her husband to a post at court. Upon this, Buonaventuri behaved with so much insolence, even to the nobility, that one evening he was found murdered in the street. Thus the grand-duke, who was thought to have sanctioned the crime, was able to indulge his passion unchecked. On the death of the grand-duchess in 1578 he was privately united to Bianca, and afterwards married her publicly. But she had no children, and this served to poison her happiness, since the next in succession was her bitter enemy, the cardinal Ferdinand. The latter came to Florence in 1587, and was ostentatiously welcomed by Bianca, who was most anxious to conciliate him. On the 18th of October of the same year the grand-duke died at his villa of Poggio a Caiano, of a fever caught on a shooting excursion in the Maremme, and the next day Bianca also expired, having ruined her health by drugs taken to cure her sterility. But rumour asserted that she had

prepared a poisoned tart for the cardinal, and that, when he suspiciously insisted on the grand-duke tasting it first, Bianca desperately swallowed a slice and followed her husband to the tomb.

Such was the life of Francesco dei Medici, and all that can be said in his praise is that he gave liberal encouragement to a few artists, including de Giovanni Bologna (*q.v.*). He was the founder of the Uffizi gallery, of the Medici theatre, and the villa of Pratolino; and during his reign the Della Cruscan academy was instituted.

Ferdinand I. was thirty-eight years of age when, in 1587, he succeeded his brother on the throne. A cardinal from the age of fourteen, he had never taken holy orders. He showed much tact and experience in the management of ecclesiastical affairs. He was the founder of the Villa Medici at Rome, and the purchaser of many priceless works of art, such as the Niobe group and many other statues afterwards transported by him to Florence. After his accession he retained the cardinal's purple until the time of his marriage. He was in all respects his brother's opposite. Affable in his manners and generous with his purse, he chose a crest typical of the proposed mildness of his rule—a swarm of bees with the motto *Majestate tantum*. He instantly pardoned all who had opposed him, and left his kinsmen at liberty to choose their own place of residence. Occasionally, for political reasons, he committed acts unworthy of his character; but he re-established the administration of justice, and sedulously attended to the business of the state and the welfare of his subjects. Accordingly Tuscany revived under his rule and regained the independence and political dignity that his brother had sacrificed to love of ease and personal indulgence. He favoured commerce, and effectually ensured the prosperity of Leghorn, by an edict enjoining toleration towards Jews and heretics, which led to the settlement of many foreigners in that city. He also improved the harbour and facilitated communication with Pisa by means of the Naviglio, a canal into which a portion of the water of the Arno was turned. He nevertheless retained the reprehensible custom of trading on his own account, keeping banks in many cities of Europe. He successfully accomplished the draining of the Val di Chiana, cultivated the plains of Pisa, Fucecchio and Val di Nievole, and executed other works of public utility at Siena and Pisa. But his best energies were devoted to the foreign policy by which he sought to emancipate himself from subjection to Spain. On the assassination (1589) of Henry III. of France Ferdinand supported the claims of the king of Navarre, undeterred by the opposition of Spain and the Catholic League, who were dismayed by the prospect of a Huguenot succeeding to the throne of France. He lent money to Henry IV., and strongly urged his conversion to Catholicism; he helped to persuade the pope to accept Henry's abjuration, and pursued this policy with marvellous persistence until his efforts were crowned with success. Henry IV. showed faint gratitude for the benefits conferred upon him, and paid no attention to the expostulations of the grand-duke, who then began to slacken his relations with France, and showed that he could guard his independence by other alliances. He gave liberal assistance to Philip III. for the campaign in Algiers, and to the emperor for the war with the Turks. Hence he was compelled to burden his subjects with enormous taxes, forgetting that while guaranteeing the independence of Tuscany by his loans to foreign powers he was increasingly sapping the strength of future generations. He at last succeeded in obtaining the formal investiture of Siena, which Spain had always considered a fief of her own.

During this grand-duke's reign the Tuscan navy was notably increased, and did itself much honour on the Mediterranean. The war-galleys of the knights of St. Stephen were despatched to the coast of Barbary to attack Bona, the headquarters of the corsairs, and they captured the town with much dash and bravery. In the following year (1608) the same galleys achieved their most brilliant victory in the archipelago over the stronger fleet of the Turks, by taking nine of their vessels, seven hundred prisoners, and jewels of the value of 2,000,000 ducats.

Ferdinand I. died in 1609, leaving four sons, of whom the eldest, Cosimo II., succeeded to the throne at the age of nineteen.

Cosimo II. He was at first assisted in the government by his mother and a council of regency. He had a good disposition, and the fortune to reign during a period when Europe was at peace and Tuscany blessed with abundant harvests. Of his rule there is little to relate. His chief care was given to the galleys of St Stephen, and he sent them to assist the Druses against the Porte. On one occasion he was involved in a quarrel with France. Concino Concini, the Marshal d'Ancre, being assassinated in 1617, Louis XIII. claimed the right of transferring the property of the murdered man to De Luynes. Cosimo, refusing to recognize the confiscation decreed by the French tribunals, demanded that Concini's son should be allowed to inherit. Hence followed much ill-feeling and mutual reprisals between the two countries, finally brought to an end by the intervention of the duke of Lorraine.

Like his predecessors, Cosimo II. studied to promote the prosperity of Leghorn, and he deserves honour for abandoning all commerce on his own account. But it was no praiseworthy act to pass a law depriving women of almost all rights of inheritance. By this means many daughters of the nobility were driven into convents against their will. He gave scanty attention to the general affairs of the state. He was fond of luxury, spent freely on public festivities and detested trouble. Tuscany was apparently tranquil and prosperous; but the decay of which the seeds were sown under Cosimo I. and Ferdinand I. was rapidly spreading, and became before long patent to all and beyond all hope of remedy. The best deed done by Cosimo II. was the protection accorded by him to Galileo Galilei, who had removed to Padua, and there made some of his grandest discoveries. The grand duke recalled him to Florence in 1610, and nominated him court mathematician and philosopher. Cosimo died in February 1621. Feeling his end draw near, when he was only aged thirty and all his sons were still in their childhood, he hastened to arrange his family affairs. His mother, Cristina of Lorraine, and his wife, Maddalena of Austria, were nominated regents and guardians to his eldest son Ferdinand II., a boy of ten, and a council of four appointed, whose functions were regulated by law. After Cosimo's death, the young Ferdinand was sent to Rome and Vienna to complete his education, and the government of Tuscany remained in the hands of two jealous and quarrelsome women. Thus the administration of justice and finance speedily went to ruin. Out of submissiveness to the pope, the regents did not dare to maintain their legitimate right to inherit the duchy of Urbino. They conferred exaggerated privileges on the new Tuscan nobility, which became increasingly insolent and worthless. They resumed the practice of trading on their own account, and, without reaping much benefit thereby, did the utmost damage to private enterprise.

In 1627 Ferdinand II., then aged seventeen, returned to Italy and assumed the reins of government; but, being of a very gentle

Ferdinand II. disposition, he decided on sharing his power with the regents and his brothers, and arranged matters in such wise that each was almost independent of the other. He gained the love of his subjects by his great goodness; and, when Florence and Tuscany were ravaged by the plague in 1630, he showed admirable courage and carried out many useful measures. But he was totally incapable of energy as a statesman. When the pope made bitter complaints because the board of health had dared to subject certain monks and priests to the necessary quarantine, the grand-duke insisted on his officers asking pardon on their knees for having done their duty. On the death in 1631 of the last duke of Urbino, the pope was allowed to seize the duchy without the slightest opposition on the part of Tuscany. As a natural consequence the pretensions of the Roman curia became increasingly exorbitant; ecclesiastics usurped the functions of the state; and the ancient laws of the republic, together with the regulations decreed by Cosimo I. as a check upon similar abuses, were allowed to become obsolete. On the extinction of the line of the Gonzagas at Mantua in 1627,

war broke out between France on the one side and Spain, Germany and Savoy on the other. The grand duke, uncertain of his policy, trimmed his sails according to events. Fortunately peace was re-established in 1631. Mantua and Monferrato fell to the duke of Nevers, as France had always desired. But Europe was again in arms for the Thirty Years' War, and Italy was not at peace. Urban VIII. wished to aggrandize his nephews, the Barberini, by wresting Castro and Ronciglione from Odoardo Farnese, duke of Parma and brother-in-law to Ferdinand. Farnese marched his army through Tuscany into the territories of the pope, who was greatly alarmed by the attack. The grand-duke was drawn into the war to defend his own state and his kinsman. His military operations, however, were of the feeblest and often the most laughable character. At last, by means of the French intervention, peace was made in 1644. But, although the pope was forced to yield, he resigned none of his ecclesiastical pretensions in Tuscany. It was during Ferdinand's reign that the septuagenarian Galileo was obliged to appear before the Inquisition in Rome, which treated him with infamous cruelty. On the death of this great and unfortunate man, the grand-duke wished to erect a monument to him, but was withheld by fear of the opposition of the clergy. The dynasty as well as the country now seemed on the brink of decay. Two of the grand-duke's brothers had already died childless, and Ippolito, the sole survivor, was a cardinal. The only remaining heir was his son Cosimo, born in 1642.

Like nearly all his predecessors, Ferdinand II. gave liberal patronage to science and letters, greatly aided therein by his brother Leopold, who had been trained by Galileo Galilei, and who joined with men of learning in founding the celebrated academy *Del Cimento*, of which he was named president. This academy took for its motto the words *Provando e riprovando*, and followed the experimental method of Galileo. Formed in 1657, it was dissolved in 1667 in consequence of the jealousies and dissensions of its members, but during its brief existence won renown by the number and importance of its works.

Cosimo III. succeeded his father in 1670. He was weak, vain, bigoted and hypocritical. In 1661 he had espoused Louise of Orléans, niece of Louis XIV., who, being enamoured of duke Charles of Lorraine, was very reluctant to come to Italy, and speedily detested both her husband and his country, of which she refused to learn the language. She had two sons and one daughter, but after the birth of her third child, Giovan Gastone, her hatred for her husband increased almost to madness. She first withdrew to Poggio a Caiano, and then, being unable to get her marriage annulled, returned to France, where, although supposed to live in conventual seclusion, she passed the greater part of her time as a welcome visitor at court. Even her testamentary dispositions attested the violence of her dislike to her husband.

Cosimo's hypocritical zeal for religion compelled his subjects to multiply services and processions that greatly infringed upon their working hours. He wasted enormous sums in pensioning converts—even those from other countries—and in giving rich endowments to sanctuaries. Meanwhile funds often failed for the payment of government clerks and soldiers. His court was composed of bigots and parasites; he ransacked the world for dainties for his table, adorned his palace with costly foreign hangings, had foreign servants, and filled his gardens with exotic plants. He purchased from the emperor the title of "Highness" in order to be the equal of the duke of Savoy. He remained neutral during the Franco-Spanish War, and submitted to every humiliation and requisition exacted by the emperor. He had vague notions of promoting agriculture, but accomplished no results. At one time he caused eight hundred families to be brought over from the Morea for the cultivation of the Maremma, where all of them died of fever. But when, after the revocation of the Edict of Nantes, French Huguenots offered to apply their labour and capital to the same purpose, the grand duke's religious scruples refused them refuge. So ruin fell upon Tuscany. Crime and misery increased, and the poor, who only asked for work, were given alms and sent oftener to church. This period

witnessed the rise of many charitable institutions of a religious character under the patronage of the grand-duke, as for instance the congregation of San Giovanni Battista. But these could not remedy the general decay.

Cosimo's dominant anxiety regarded the succession to the throne. His eldest son Ferdinand died childless in 1713. The pleasure-loving Giovan Gastone was married to Anna Maria of Saxe-Lauenburg, widow of a German prince, a wealthy, coarse woman wholly immersed in domestic occupations. After living with her for some time in a Bohemian village, Giovan Gastone yielded to his dislike to his wife and her country, withdrew to France, and ruined his health by his excesses. After a brief return to Bohemia he finally separated from his wife, by whom he had no family. Thus the dynasty was doomed to extinction.

thought on ascending it was to regain strength enough to pass the remainder of his days in enjoyment. He dismissed the spies, parasites and bigots that had formed his father's court, abolished the pensions given to converts, suppressed severe taxes, and prohibited the organized espionage established in the family circle. He wished to live and let live, and liked the people to be amused. Everything in fact bore a freer and gayer aspect under his reign, and the Tuscans seemed to feel renewed attachment for the dynasty as the moment of its extinction drew near. But the grand-duke was too feeble and incapable to accomplish any real improvement. Surrounded by gay and dissipated young men, he entrusted all the cares of government to a certain Giuliano Dami, who drove a profitable trade by the sale of offices and privileges. In this way all things were in the hands of corrupt

GENEALOGICAL TABLE OF THE MEDICI

Giovanni d'Averardo, known as Giovanni di Bicci, 1360-1429
= Piccarda Bucri.

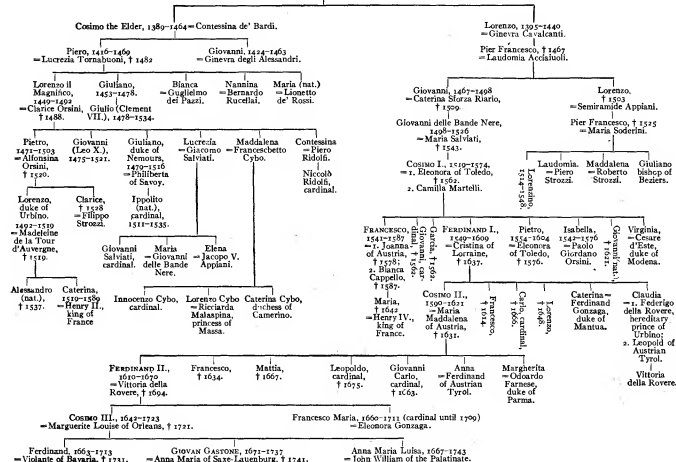

Cosimo had a passing idea of reconstituting the Florentine republic, but, this design being discountenanced by the European powers, he determined to transfer the succession, after the death of Giovan Gastone, to his sister Anna Maria Louisa, who in fact survived him. For this purpose he proposed to annul the patent of Charles V., but the powers objected to this arrangement also, and by the treaty of 1717 the quadruple alliance of Germany, France, England and Holland decided that Parma and Tuscany should descend to the Spanish Infante Don Carlos. The grand-duke made energetic but fruitless protests.

Cosimo III. had passed his eightieth year at the time of his decease in October 1723, and was succeeded by his son Giovan Gastone, then aged fifty-three. The new sovereign was in bad health, nor apt out by dissipation, and had neither ambition nor aptitude for rule. His throne was already at the disposal of foreign powers, and his only

individuals; while the grand-duke, compelled to pass the greater part of his time in bed, vainly sought diversion in the company of buffoons, and was only tormented by perceiving that all the world disposed of his throne without even asking his advice. And when, after prolonged opposition, he had resigned himself to accept Don Carlos as his successor, the latter led a Spanish army to the conquest of Naples, an event afterwards leading to the peace of 1735, by which the Tuscan succession was transferred to Francesco II., duke of Lorraine, and husband of Maria Theresa. Giovan Gastone was finally obliged to submit even to this. Spain withdrew her garrisons from Tuscany, and Austrian soldiers took their place and swore fealty to the grand-duke on the 5th of February 1737. He expired on the 9th of July of the same year. Such was the end of the younger branch of the Medici, which had found Tuscany a prosperous country, where art, letters, commerce, industry and agriculture flourished,

and left her poor and decayed in all ways, drained by taxation, and oppressed by laws contrary to every principle of sound economy, downtrodden by the clergy, and burdened by a weak and vicious aristocracy.

BIBLIOGRAPHY.—G. Capponi, *Storia della repubblica di Firenze* (Florence, 1875); F. T. Perrens, *Histoire de Florence depuis la domination des Médicis jusqu'à la chute de la république* (Paris, 1888, &c.); W. Roscoe, *Life of Lorenzo de' Medici* (new ed., London, 1872) and *Life of Leo X.* (London, 1846); A. von Reumont, *Geschichte Toscanas seit der Ende des florent. Freistaates* (2 vols., Gotha, 1876) and *Lorenzo de' Medici* (Leipzig, 1874); A. Fabroni, *Laurenzini Medicei magnifici vita* (2 vols., Pisa, 1784) and *Magni Cosimi Medicei vita* (2 vols., Pisa, 1789); Buser, *Lorenzo de' Medici als italienischer Staatsmann* (Leipzig, 1879) and *Die Besiehungen Lorenzo's zu Frankreich* (Leipzig, 1879); E. Armstrong, *Lorenzo de' Medici* (London, 1896); P. Villari, *La Storia di Girolamo Savonarola* (Florence, 1887) and *Machiavelli* (Florence, 1878-1883, several subsequent editions); Galluzzi, *Storia del granducato di Toscana sotto il governo di casa Medici* (5 vols., Florence, 1787); E. Robiony, *Gli ultimi Medici* (Florence, 1905); E. L. S. Horsburgh, *Lorenzo the Magnificent and Florence in her Golden Age* (1908); and Janet Ross, *Lives of the Medici from their Letters* (1910). See also under FLORENCE and TUSCANY. (P. V.)

MEDICI, GIACOMO (1817-1882), Italian patriot and soldier, was born at Milan in January 1817. Exiled in 1836, he fought in Spain against the Carlists between 1836 and 1840, and in 1846 joined Garibaldi at Montevideo. Returning to Italy with Garibaldi in 1848, he raised a company of volunteers to fight against Austria, and commanded the volunteer vanguard in Lombardy, proceeding thence to Rome, where he gained distinction by defending the "Vascello," a position near the Porta San Pancrazio, against the French. During the siege of Rome he himself was wounded. In the war of 1859 he commanded a volunteer regiment, and was sent by Cavour into Tirol. In 1860 he tried in vain to dissuade Garibaldi from the Marsala expedition, but, after his chief's departure, he sailed for Sicily with the second expedition, taking part in the whole campaign, during which he forced Messina to capitulate after an eight days' siege. Joining the regular army, he was appointed military commandant of Palermo, in which capacity he facilitated the abortive campaign of Garibaldi in 1862. In 1866 he commanded the division which invaded Tirol, but the effect of his victories was neutralized by the conclusion of peace. Returning to Palermo he did good work in restoring order in Sicily. He became a senator in 1870, and marquis of the "Vascello" and first aide-de-camp to the king in 1876. He died on the 9th of March 1882.

MEDICINE.—The science of medicine, as we understand it, has for its province the treatment of disease. The word "medicine" (Lat. *medicina*: sc. *ars*, art of healing, from *mederi*, to heal) may be used very widely, to include *Pathology* (q.v.), the theory of the causation of disease, or, very narrowly, to mean only the drug or form of remedy prescribed by the physician—this being more properly the subject of *Therapeutics* (q.v.) and *Pharmacology* (q.v.). But it is necessary in practice, for historical comprehensiveness, to keep the wider meaning in view.

Disease (see *PATHOLOGY*) is the correlative of health, and the word is not capable of a more penetrating definition. From the time of Galen, however, it has been usual to speak of the life of the body either as proceeding in accordance with nature (*κατὰ φύσιν, secundum naturam*) or as overstepping the bounds of nature (*παρὰ φύσιν, proter naturam*). Taking disease to be a deflexion from the line of health, the first requisite of medicine is an extensive and intimate acquaintance with the norm of the body. The structure and functions of the body form the subject of *Anatomy* (q.v.) and *Physiology* (q.v.).

The medical art (*ars medendi*) divides itself into departments and subdepartments. The most fundamental division is into internal and external medicine, or into medicine proper and surgery (q.v.). The treatment of wounds, injuries and deformities, with operative interference in general, is the special department of surgical practice (the corresponding parts of pathology, including inflammation, repair, and removable tumours, are sometimes grouped together as surgical pathology); and where the work of the profession is highly subdivided,

surgery becomes the exclusive province of the surgeon, while internal medicine remains to the physician. A third great department of practice is formed by obstetric medicine or midwifery (see *OBSTETRICS*); and dentistry (q.v.), or dental surgery, is given up to a distinct branch of the profession.

A state of war, actual or contingent, gives occasion to special developments of medical and surgical practice (military hygiene and military surgery). Wounds caused by projectiles, sabres, &c., are the special subject of naval and military surgery; while under the head of military hygiene we may include the general subject of ambulances, the sanitary arrangements of camps, and the various forms of epidemic camp sickness.

The administration of the civil and criminal law involves frequent relations with medicine, and the professional subjects most likely to arise in that connexion, together with a summary of *causes célèbres*, are formed into the department of *MEDICAL JURISPRUDENCE* (q.v.).

In preserving the public health, the medical profession is again brought into direct relation with the state, through the public medical officers.

HISTORY OF MEDICINE

Medicine as Portrayed in the Homeric Poems.—In the state of society pictured by Homer it is clear that medicine has already had a history. We find a distinct and organized profession; we find a system of treatment, especially in regard to injuries, which it must have been the work of long experience to frame; we meet with a nomenclature of parts of the body substantially the same (according to Daremberg) as that employed long afterwards in the writings of Hippocrates; in short, we find a science and an organization which, however imperfect as compared with those of later times, are yet very far from being in their beginning. The Homeric heroes themselves are represented as having considerable skill in surgery, and as able to attend to ordinary wounds and injuries, but there is also a professional class, represented by Machaon and Podalirius, the two sons of Asclepius, who are treated with great respect. It would appear, too, from the *Aethiopis* of Archinus (quoted by Welcker and Häser) that the duties of these two were not precisely the same. Machaon's task was more especially to heal injuries, while Podalirius had received from his father the gift of "recognizing what was not visible to the eye, and tending what could not be healed." In other words, a rough indication is seen of the separation of medicine and surgery. Asclepius appears in Homer as a Thessalian king, not as a god, though in later times divine honours were paid to him. There is no sign in the Homeric poems of the subordination of medicine to religion which is seen in ancient Egypt and India, nor are priests charged, as they were in those countries, with medical functions—all circumstances which throw grave doubts on the commonly received opinion that medicine derived its origin in all countries from religious observances.

Although the actual organization of medicine among the Homeric Greeks was thus quite distinct from religion, the worship of Asclepius (or Aesculapius) as the god of healing demands some notice. This cult spread very widely among the Greeks; it had great civil importance, and lasted even into Christian times; but there is no reason to attribute to it any special connexion with the development of the science or profession of medicine. Sick persons repaired, or were conveyed, to the temples of Asclepius in order to be healed, just as in modern times relief is sought by a devotional pilgrimage or from the waters of some sacred spring, and then as now the healing influence was sometimes sought by deputy. The sick person, or his representative, after ablution, prayer and sacrifice, was made to sleep on the hide of the sacrificed animal, or at the feet of the statue of the god, while sacred rites were performed. In his sleep (incubatio, *lykolaptes*) the appropriate remedy was indicated by a dream. Moral or dietetic remedies were more often prescribed than drugs. The record of the cure was inscribed on the columns or walls of the temple; and it has been thought that in this way was introduced the custom of "recording cases," and that the physicians of the Hippocratic school thus learnt to accumulate clinical experience. But the priests of Asclepius were not physicians. Although the latter were often called *Asclepiads*, this was in the first place to indicate their real or supposed descent from Asclepius, and in the second place as a complimentary title. No medical writing of antiquity speaks of the worship of Asclepius in such a way as to

imply any connexion with the ordinary art of healing. The two systems appear to have existed side by side, but to have been distinct, and if they were ever united it must have been before the times of which we have any record. The theory of a development of Greek medicine from the rites of Asclepius, though defended by eminent names, must accordingly be rejected.

Development of Medicine in Greece.—It is only from non-medical writers that anything is known of the development of medicine in Greece before the age of Hippocrates. The elaborate collections made by Daremberg of medical notices in the poets and historians illustrate the relations of the profession to society, but do little to prepare us for the Hippocratic period. Nor is much importance to be attached to the influence of the philosophical sects on medicine except as regards the school of Pythagoras. That philosopher and several of his successors were physicians, but we do not know in what relation they stood to later medical schools. We must therefore hasten onward to the age of Pericles, in which Hippocrates, already called "the Great," was in medicine as complete a representative of the highest efforts of the Greek intellect as were his contemporaries the great philosophers, orators and tragedians. The medical art as we now practise it, the character of the physician as we now understand it, both date for us from Hippocrates. The justification of this statement is found in the literary collection of writings known by his name. Of these certainly many are falsely ascribed to the historical Hippocrates of Cos; others are almost as certainly rightly so ascribed; others again are clearly works of his school, whether from his hand or not. But which are to be regarded as the "genuine works" is still uncertain, and authorities are conflicting. There are clearly two schools represented in the collection—that of Cnidus in a small proportion, and that of Cos in the larger number of the works. The latter was that to which Hippocrates belonged, and where he gave instruction; and accordingly it may be taken that works of this school, when not obviously of a different date, are Hippocratic in doctrine if not in actual authorship.

Hippocratic Medicine.—The first grand characteristic of Hippocratic medicine is the high conception of the duties and status of the physician, shown in the celebrated "Oath of Hippocrates" and elsewhere—equally free from the mysticism of a priesthood and the vulgar pretensions of a mercenary craft. So matured a professional sentiment may perhaps have been more the growth of time and organization than the work of an individual genius, but certainly corresponds with the character universally attributed to Hippocrates himself. The second great quality is the singular artistic skill and balance with which the Hippocratic physician used such materials and tools as he possessed. Here we recognize the true Greek *euprosopia*. But this artistic completeness was closely connected with the third cardinal virtue of Hippocratic medicine—the clear recognition of disease as being equally with life a process governed by what we should now call natural laws, which could be known by observation, and which indicated the spontaneous and normal direction of recovery, by following which alone could the physician succeed. In the fourth place, the views of the "natural history of disease" (in modern language) led to habits of minute observation and accurate interpretation of symptoms, in which the Hippocratic school was unrivalled in antiquity, and has been the model for all succeeding ages, so that even in these days, with our enormous advances in knowledge, the true method of clinical medicine may be said to be the method of Hippocrates.

The actual science of the Hippocratic school was of course very limited. In anatomy and physiology little advance had been made, and so of pathology in the sense of an explanation of morbid processes or knowledge of diseased structures there could be very little. The most valuable intellectual possession was a large mass of recorded observations in individual cases and epidemics of disease. Whether these observations were systematic or individual, and how they were recorded, are points of which we are quite ignorant, as the theory that the votive tablets in the temples supplied such materials must be abandoned.

Though the Hippocratic medicine was so largely founded on observation, it would be an error to suppose that dogma or theory had no place. The dominating theory of disease was the *humoral*, and this has since been used to influence medical thought and practice. According to this celebrated theory, the body contains four humours—blood, phlegm, yellow bile and black bile, a right proportion and mixture of which constitute health; improper proportions or irregular distribution, disease. It is doubtful whether the treatise in which this theory is fully expounded (*περὶ φέροντος ἀσθενείας*) is as old as Hippocrates himself; but it was regarded as a Hippocratic doctrine, and, when taken up and expanded by Galen, its terms not only became the common property of the profession,

but passed into general literature and common language. Another Hippocratic doctrine, the influence of which is not even yet exhausted, is that of the healing power of nature. Not that Hippocrates taught, as he was afterwards reproached with teaching, that nature is sufficient for the cure of diseases; for he held strongly the efficacy of art. But he recognized, at least in acute diseases, a natural process which the humours went through—being first of all *crude*, then passing through *coction* and digestion, and finally being expelled by resolution or crisis through one of the natural channels of the body. The duty of the physician was to foresee these changes, "to assist or not to hinder them," so that "the sick man might conquer the disease with the help of the physician." The times at which crises were to be expected were naturally looked for with anxiety; and it was a cardinal point in the Hippocratic system to foretell them with precision. Hippocrates, influenced as is thought by the Pythagorean doctrines of number, taught that they were to be expected on days fixed by certain numerical rules, in some cases on odd, in others on even numbers—the celebrated doctrine of "critical days." This false precision can have had no practical value, but may have enforced habits of minute observation. It follows from what has been said that *prognosis*, or the art of foretelling the course and event of the disease, was a strong point with the Hippocratic physicians. In this they have perhaps never been excelled. Diagnosis, or recognition of the disease, must have been necessarily imperfect, when no scientific nosology or system of disease existed, and the knowledge of anatomy was quite inadequate to allow of a precise determination of the seat of disease; but symptoms were no doubt observed and interpreted skillfully. The pulse is not spoken of in any of the works now attributed to Hippocrates himself, though it is mentioned in other works of the collection.

In the treatment of disease, the Hippocratic school attached great importance to diet, the variations necessary in different diseases being minutely defined. Medicines were regarded as of secondary importance, but not neglected, two hundred and sixty-five drugs being mentioned at different places in the Hippocratic works. Blood-letting was known, but not greatly practised. The highest importance was attached to applying all remedies at the right moment, and the general principle enforced of making all influences—internal and external—co-operate for the relief of the patient. The method of treatment just mentioned applies more especially to the cure of acute diseases; but they are the most salient characteristics of the Hippocratic school. In chronic cases diet, exercise and natural methods were chiefly relied upon.

The school of Cnidus, as distinguished from that of Cos, of which Hippocrates is the representative, appears to have differed in attaching more importance to the differences of special diseases, and to have made more use of drugs. A treatise on the diseases of women, contained in the Hippocratic collection, and of remarkable practical value, is attributed to this school.

The above sketch of Hippocratic medicine will make it less necessary to dwell upon the details relating to subsequent medical schools or sects in ancient times. The general conception of the physician's aim and task remained the same, though, as knowledge increased, there was much divergence both in theory and practice—even opposing schools were found to be developing some part of the Hippocratic system. Direct opponents or repudiators of the authority of Hippocrates were rare, all generally appealing to his authority. But, insensibly, the least valuable part of the Hippocratic work, the theory, was made permanent; the most valuable, the practical, neglected.

Post-Hippocratic Medicine.—After Hippocrates the progress of medicine in Greece does not call for any special remark in such a sketch as this, but mention must be made of one great name. Though none of Aristotle's writings are strictly medical, he has by his researches in anatomy and physiology contributed greatly to the progress of medicine. It should also be remembered that he was of an Asclepiad family, and received that partly medical education which was traditional in such families, and also himself is said to have practised medicine as an amateur. Moreover, his works on natural history doubtless furthered the progress among the Greeks of sciences tributary to medicine, though the only specimens of such works now extant are those of Aristotle. The Peripatetic school are those of Theophrastus, who may be considered the founder of the scientific study of botany. Among his encyclopaedic writings were some on medical subjects, of which fragments only have been preserved. The Peripatetic school may have been more favourable to the development of medicine, as of other departments of natural knowledge, than any other; but there is no evidence that any of the philosophical schools had important influence on the progress of medicine. The fruit of Aristotle's teaching and example was seen later on in the schools of Alexandria.

The century after the death of Hippocrates is a time almost blank in relation to medicine. It is that of the scientific, like the others, shared in the general intellectual decline of Greece after the Macedonian supremacy; but the works of physicians of the period are almost entirely lost, and were so even in the time of Galen. Galen classes them all as of the dogmatic school; but, whatever may have been their characteristics, they are of no importance in the history of the science.

Alexandrian School of Medicine.—The dispersion of Greek science and intellectual activity through the world by the conquests of Alexander and his successors led to the formation of more than one learned centre, in which medicine among other sciences was represented. Pergamum was early distinguished for its medical school; but in this as in other respects its reputation was ultimately effaced by the more brilliant fame of Alexandria. It is here that the real continuation and development of Hippocratic medicine can be traced.

In one department the Alexandrian school rapidly surpassed its Greek original—namely, in the study of anatomy. The dissection of the human body, of which some doubtful traces or hints only are found in Greek times, was assiduously carried out, being favoured or even suggested perhaps by the Egyptian custom of disembowelling and embalming the bodies of the dead. There is no doubt that the organs were also examined by opening the bodies of living persons—criminals condemned to death being given over to the anatomists for this purpose.

Two eminent names stand in the first rank as leaders of the two earliest schools of medicine which arose in Alexandria, Herophilus and Erasistratus.

Herophilus (335–280 B.C.) was a Greek of Chalcedon, a pupil of the schools both of Cos and of Cnidus. He was especially noted for his profound researches in anatomy (see i. 802), and in the knowledge and practice of medicine he appears to have been equally renowned. He professed himself a close adherent of Hippocrates, and adopted his theory of the humours. He also made extensive use of drugs and of bleeding. The reputation of Herophilus is attested by the fact that four considerable physicians wrote works about him and his writings, and he is further spoken of with the highest respect by Galen and Celsus. By the general voice of the medical world of antiquity he was placed only second to Hippocrates.

Erasistratus (d. 280 B.C.) was the contemporary and rival of Herophilus. Little is known of his life, except that he spent some time at the court of Seleucus Nicator at Antioch before coming to Alexandria, and that he cultivated anatomy late in life, after he had taken up his abode in the latter city. His numerous works are also almost entirely lost, fragments only being preserved by Galen and others. Erasistratus, instead of following Hippocrates as Herophilus did, departed from his doctrine, and seems to have been rather aggressive and independent in his views. He appears to have leaned to mechanical explanations of the symptoms of disease, as was especially the case with inflammation, of which he gave the first rational, though necessarily inadequate, theory.

The two schools composed of the followers of Herophilus and Erasistratus respectively long divided between them the medical world of Alexandria. The names of many prominent members of both sects have been preserved, but it would be useless to repeat them. The Herophilists still revered the memory of Hippocrates, and wrote numerous commentaries on his works. They produced many eminent anatomists, but in the end seem to have become lost in theoretical subtleties, and to have maintained too high a standard of literary cultivation. The school of Erasistratus was less distinguished in anatomy than that of Herophilus, but paid more attention to the special symptoms of diseases, and employed a great variety of drugs. It was longer-lived than that of Herophilus, for it still numbered many adherents in the 2nd century after Christ, a century after the latter had become extinct.

The Erasistratians paved the way for what was in some respects the most important school which Alexandria produced, that known as the empiric, which, though it recognized no master by name, may be considered to have been founded by Philinus of Cos (280 B.C.), a pupil of Herophilus; but Serapion, a great name in antiquity, and Glaucias of Tarentum, who traced the empirical doctrine back to the writings of Hippocrates, are also named among its founders. The most striking peculiarity of the empirics was that they rejected anatomy, regarding it as useless to inquire into the causes of things, and thus, as they contended, being the more minute in their observation of the actual phenomena of disease. They professed that their whole practice was based upon experience, to which word they gave a broad meaning. Three sources, and these only, could experience draw from: observation, history (i.e. recorded observation), and judgment by analogy. These three bases of knowledge were known as the "tripod" of the empirics. It should not, however, be forgotten that the empirics read and industriously commented on the works of Hippocrates. They were extremely successful in practical matters, especially in surgery and in the use of drugs, and a large part of the routine knowledge of diseases and remedies which became traditional in the times of the Roman empire is believed to have been derived from them. In the 2nd century the school became closely connected with the philosophical sect of the Sceptics, whose leader Sextus (200 B.C.), was an empirical physician. It lived and flourished far beyond this time, when transplanted to Rome, not

less than in its native Alexandria, and appears to be recognizable even up to the beginning of the middle ages.

If we look at the work of the Alexandrian schools in medicine as a whole, we must admit that the progress made was great and permanent. The greatest service rendered to medicine was undoubtedly the systematic study of anatomy. It is clear that the knowledge of function (physiology) did not by any means keep pace with the knowledge of structure, and this was probably the reason why the important sect of the empirics were able entirely to dispense with anatomical knowledge. The doctrines of Hippocrates, though lightly thought of by the Erasistratians, still were no doubt very widely accepted, but the practice of the Hippocratic school had been greatly improved in almost every department—surgery and obstetrics being probably those in which the Alexandrian practitioners could compare most favourably with those of modern times. We have now to trace the fortunes of this body of medical doctrine and practice when transplanted to Rome, and ultimately to the whole Roman world.

Roman Medicine.—The Romans cannot be said to have at any time originated or possessed an independent school of medicine. They had from early times a very complicated system of superstitious medicine, or religion, related to disease and the cure of disease, borrowed, as is thought, from the Etruscans; and, though the saying of Pliny that the Roman people got on for six hundred years without doctors was doubtless an exaggeration, and not, literally speaking, exact, it must be accepted for the broad truth which it contains. When a medical profession appears, it is, so far as we are able to trace it, as an importation from Greece.

The first Greek physician whose name is preserved as having migrated to Rome was Archagathus, who came over from the Peloponnese in 218 B.C.; but there were probably others before him. When Greece was made a Roman province, the number of such physicians who sought their fortunes in Rome must have been very large. The bitter words of M. Porcius Cato, who disliked them as he did other representatives of Greek culture, are evidence of this. The most eminent of these earlier Greek physicians at Rome was Asclepiades of Bithynia (born 124 B.C. at Prusa in Bithynia). He came to Rome as a young man, and was distinguished both for his medical skill and his oratorical power. He introduced a system which, so far as we know, was his own, though founded upon the Epicurean philosophical creed; on the practical side it conformed pretty closely to the Stoic rule of life, thus adapting itself to the leanings of the better stamp of Romans in the later times of the republic. According to Asclepiades all diseases depended upon alterations in the size, number, arrangement or movement of the "atoms," of which, according to the doctrine of Epicurus, the body consisted. These atoms were united into passages (*poroi*) through which the juices of the body were conveyed. This doctrine, of which the developments need not further be followed, was important chiefly in so far that it was perfectly distinct from, and opposed to, the humoral pathology of Hippocrates. In the treatment of disease Asclepiades attached most importance to diet, exercise, passive movements or frictions, and the external use of cold water—in short, to a modified athletic training. He rejected the *vis medicatrix naturee*, pointing out that nature in many cases not only did not help but marred the cure. His knowledge of disease and surgical skill were, as appears from the accounts given by Celsus and Galienus Aretanus, very considerable. Asclepiades had many pupils who adhered more or less closely to his doctrine, but it was especially one of them, Themison, who gave permanence to the teachings of his master by framing out of them, with some modifications, a new system of medical doctrine, and founding on this basis a school which lasted for some centuries in successful rivalry with the Hippocratic tradition, which, as we have seen, was up to that time the prevailing influence in medicine.

This system was known as methodism, its adherents as the methodici or methodists. Its main principles were that it was useless to consider the causes of a disease, or even the organ affected by the disease, and that it was sufficient to know what was common to all diseases, viz. their common qualities (*communitates, aequalitates*). Of these there were three possible forms—(1) relaxation, (2) contraction of the minute passages or *poroi*, and (3) a mixed state, partly lax, partly constricted. The signs of these morbid states were to be found in the general constitution of the body, especially in the excretions. Besides this it was important only to consider whether the disease was acute or chronic, whether it was increasing, declining or stationary. Treatment of disease was directed not to any special organ, nor to producing the crises and critical discharges of the Hippocratic school, but to correcting the morbid common condition or "community," relaxing the body if it was constricted, causing

contraction if it was too lax, and in the "mixed state" acting according to the predominant condition. This simple rule of treatment was the system or "method" from which the school took its name.

The methodists agreed with the empirics in one point; in their contempt for anatomy; but, strictly speaking, they were dogmatists, though with a dogma different from that of the Hippocratic school. Besides their systematic founder, the school boasted many physicians eminent in their day, among whom Thessalus of Tralles, a half-educated and boastful pretender, was one of the most popular. He reversed the Hippocratic maxim "art is long," promising his scholars to teach them the whole of medicine in six months, and had inscribed upon his tomb *ταρπεία*, as being superior to all living and bygone physicians.

In the 2nd century a much greater name appears among the methodists, that of Soranus of Ephesus, a physician mentioned with praise even by Tertullian and Augustine, who practised at Rome in the reigns of Trajan and Hadrian. Soranus is known by a work, still extant in the Greek original, on the diseases of women, and also by the Latin work of Caelius Aurelianus, three centuries later, on acute and chronic diseases, which is based upon, if not, as some think, an actual translation of, the chief work of Soranus, and which is the principal source of our knowledge of the methodic school. The work on diseases of women is the only complete work on that subject which has come down to us from antiquity, and shows remarkable fulness of practical knowledge in relation to its subject. It is notable that an important instrument of research, the speculum, which has been reinvented in modern times, was used by Soranus; and specimens of still earlier date, showing great mechanical perfection, have been found among the ruins of Pompeii. The work on acute and chronic diseases is also full of practical knowledge, but penetrated with the theories of the methodists.

The methodic school lasted certainly for some centuries, and influenced the revival of medical science in the middle ages, though overshadowed by the greater reputation of Galen. It was the first definite product of Greek medicine on Roman soil, but was destined to be followed by others, which kept up a more or less successful rivalry with it, and with the Hippocratic tradition.

The so-called pneumatic school was founded by Athenaeus, in the 1st century after Christ. According to its doctrines the normal as well as diseased actions of the body were to be referred to the operation of the *pneuma* or universal soul. This doctrine, crudely transferred from philosophical speculation, was intended to reconcile the humoral (or "methodic") and the pneumatic (or "methodic") schools; but the methodists seem to have claimed Athenaeus as one of themselves.

The conflicts of the opposing schools, and the obvious deficiencies of each, led many physicians to try and combine the valuable parts of each system, and to call themselves eclectics. Among these were found many of the most eminent physicians of Graeco-Roman times. It may be sufficient to name Rufus or Ephesus (2nd century A.D.), and Archigenes (A. D. 90), who is mentioned by Juvenal.

Although no system or important doctrine of medicine was originated by the Roman intellect, and though the practice of the profession was probably almost entirely in the hands of the Greeks, the most complete picture which we have of medical thought and activity in Roman times is due to a Latin pen, and to one who was, in all probability, not a physician. A Cornelius Celsus, a Roman patrician, who lived probably in the 1st century, appears to have studied medicine as a branch of general knowledge. Whether he was a practising physician or not has been a matter of controversy. The conclusion supported by most evidence seems to be that he practised on his friends and dependants, but not as a remunerative profession. His well-known work, *De medicina*, was one of a series of treatises intended to embrace all knowledge proper for a man of the world. It was not meant for the physicians, and was certainly little read by them, as Celsus is quoted by no medical writer, and when referred to by Pliny, is spoken of as an author not a physician. There is no doubt that his work is chiefly a compilation; and Daremberg, with other scholars, has traced a large number of passages of the Latin text to the Greek originals from which they were translated. In the description of surgical operations the vagueness of the language seems sometimes to show that the author had not performed such himself; but in other parts, and especially in his historical introduction, he speaks with more confidence; and everywhere he compares and criticizes with learning and judgment. The whole body of medical literature belonging to the Hippocratic and Alexandrian times is ably summarized, and a knowledge of the state of medical science up to and during the times of the author is thus conveyed to us which can be obtained from no other source. The work of Celsus is thus for us only second in importance to

the Hippocratic writings and the works of Galen; but it is valuable rather as a part of the history of medicine than as the subject of that history. It forms no link in the general chain of medical tradition, for the simple reason that the influence of Celsus (putting aside a few scanty allusions in medieval times) commenced in the 15th century, when his works were first discovered in manuscript or committed to the press. Since then, however, he has been almost up to our own times the most popular and widely read of all medical classics, partly for the qualities already indicated, partly because he was one of the few of those classics accessible to readers of Latin, and partly also because of the purity and classical perfection of his language.

Of Pliny, another encyclopaedic writer, a few words must be said, though he was not a physician. In his *Natural History* we find as complete a summary of the popular medicine of his time as Celsus gives of the scientific medicine. Pliny disliked doctors, and lost no opportunity of depreciating regular medicine; nevertheless he has left many quotations from, and many details about, medical authors which are of the highest value. It is useful to us for what he wrote about the history of medicine, not for what he contributed. Like Celsus, he had little influence on succeeding medical literature or practice.

We now come to the writer who, above all others, gathered up into himself the divergent and scattered threads of ancient medicine, and out of whom again the greater part of modern European medicine has flowed. Galen was a man furnished with all the anatomical, medical and philosophical knowledge of his time; he had studied all kinds of natural curiosities, and had stood in near relation to important political events; he possessed enormous industry, great practical sagacity and unbounded literary fluency. He had, in fact, every quality necessary for an encyclopaedic writer, or even for a literary and professional autocrat. He found the medical profession of his time split up into a number of sects, medical science confounded under a multitude of dogmatic systems, the social status and moral integrity of physicians degraded. He appears to have made it his object to reform these evils, to reconcile scientific acquirements and practical skill, to bring back the unity of medicine as it had been understood by Hippocrates, and at the same time to raise the dignity of medical practitioners.

Galen was as devoted to anatomical and, so far as then understood, physiological research as to practical medicine. He worked enthusiastically at dissection, though, the liberty of the Alexandrian schools no longer existing, he could dissect only animals, not the human body. In his anatomical studies Galen had a twofold object—a philosophical, to show the wisdom of the Creator in making everything fit to serve its purpose; and a practical, to aid the diagnosis, or recognition, of disease. The first led him into a theological system so minute and overstrained as to defeat its own end; the second was successfully attained by giving greater precision and certainty to medical and surgical practice in difficult cases. His general physiology was essentially founded upon the Hippocratic theory of the four elements, with which he combined the notion of spirit (*pneuma*) penetrating all parts, and mingled with the humours in different proportions. It was on this field that he most vehemently attacked the prevailing atomistic and materialistic views of the methodic school, and his conception of the *pneuma* became in some respects half metaphysical. His own researches in special branches of physiology were important, but do not strictly belong to our present subject.

The application of physiology to the explanation of diseases, and thus to practice, was chiefly by the theory of the temperaments or mixtures which Galen founded upon the Hippocratic doctrine of humours, but developed with marvellous and fatal ingenuity. The normal condition or temperament of the body depended upon a proper mixture or proportion of the four elements—hot, cold, wet and dry. From faulty proportions of the same arose the *indispositiones* ("distempers"), which, though not diseases, were the occasions of disease. Equal importance attached to faulty mixtures or dyscrasias of the blood. By a combination of these morbid predispositions with the action of deleterious influences from without all diseases were produced. Galen showed extreme ingenuity in explaining all symptoms and all diseases on his system. No phenomenon was without a name, no problem without a solution. And, though it was precisely in his fine-spun subtlety that he departed furthest from scientific method and practical utility, it was this very quality which seems in the end to have secured his popularity and established his pre-eminence in the medical world.

Galen's use of drugs was influenced largely by the same theories. In drugs were to be recognized the same elementary qualities—hot,

cold, moist, dry, &c.—as in the human body; and, on the principle of curing by contraries, the use of one or other was indicated. The writings of Galen contain less of simple objective observations than those of several other ancient physicians, all being swept into the current of dogmatic exposition. But there is enough to show the thoroughness and extent of his practical knowledge. Unfortunately it was neither this nor his zeal for research that chiefly won him followers, but the completeness of his theoretical explanations, which fell in with the mental habits of succeeding centuries, and were such as have flattered the intellectual indolence of all ages. But the reputation of Galen grew slowly; he does not appear to have enjoyed any pre-eminence over other physicians of his time, to most of whom he was strongly opposed in opinion. In the next generation he began to be esteemed only as a philosopher; gradually his system was implicitly accepted, and it enjoyed a great though not exclusive predominance till the fall of Roman civilization. When the Arabs possessed themselves of the scattered remains of Greek culture, the works of Galen were more highly esteemed than any others except those of Aristotle. Through the Arabs the Galenic system found its way back again to western Europe. Even when Arabian medicine gave way before the direct teaching of the Greek authors rescued from neglect, the authority of Galen was increased instead of being diminished; and he assumed a position of autocracy in medical science which was only slowly undermined by the growth of modern science in the 17th and 18th centuries.

The history of medicine in Roman times is by no means the same thing as the history of the fate of the works of Galen. For some centuries the methodic school was popular at Rome, and produced one physician, Caelius Aurelianus, who must be pronounced, next to Celsus, the most considerable of the Latin medical writers. His date was in all probability the end of the 4th or the beginning of the 5th century. The works bearing his name are, as has been said, entirely based upon the Greek of Soranus, but are important both because their Greek originals are lost, and because they are evidence of the state of medical practice in his own time. The popularity of Caelius is evidenced by the fact that in the 6th century an abridgment of his larger work was recommended by Cassiodorus to the Benedictine monks for the study of medicine.

Before quitting this period the name of Aretaeus of Cappadocia must be mentioned. So little is known about him that even his date cannot be fixed more closely than as being between the second half of the 1st century and the beginning of the 3rd. His works have been much admired for the purity of the Greek style, and his accurate descriptions of disease; but, as he quotes no medical author,—and is quoted by none before Alexander of Aphrodisias at the beginning of the 3rd century, it is clear that he belonged to no school and founded none, and thus his position in the chain of medical tradition is quite uncertain. Alexander of Aphrodisias, who lived and wrote at Athens in the time of Septimius Severus, is best known by his commentaries on Aristotle, but also wrote a treatise on fevers, still extant.

Ancient Medicine after Galen.—The Byzantine school of medicine, which closely corresponds to the Byzantine literary and historical schools, followed closely in Galen's footsteps, and its writers were chiefly compilers and encyclopaedists. The earliest is Oribasius (326-403), whose date and position are fixed by his being the friend and court physician of Julian the Apostate. He was a Greek of Pergamum, educated in Alexandria, and long resident in Byzantium. His great work *Συναγωγή ἰατρικῆ*, of which only about one-third has been preserved, was a medical encyclopaedia founded on extracts from Hippocrates, Galen, Dioscorides (*fl.* A.D. 50) and certain Greek writers who are otherwise very imperfectly known. The work is thus one of great historical value but of no originality. The next name which requires to be mentioned is that of Aetius (A.D. 550), a compiler who closely followed Oribasius, but with inferior powers, and whose work also has a historical but no original value. A higher rank among medical writers is assigned to Alexander of Tralles (525-605), whose doctrine was that of an eclectic. His practical and therapeutical rules are evidently the fruit of his own experience, though it would be difficult to attribute to him any decided advance in medical knowledge. But the most prominent figure in Byzantine medicine is that of Paul of Aegina (Paulus Aegineta), who lived probably in the early part of the 7th century. His skill, especially in surgery, must have been considerable, and his *Ἱατρικὴ* gives a very complete picture of the achievements of the Greeks in this department. Another work, on obstetrics, now lost, was equally famous and procured for him, among the names of the *Obstetrices*. His reputation lasted through the middle ages, and was not less in the Arabian schools than in the West. In this respect Paulus is a most important influence in the development of medicine. His great work on surgery was early

translated into Arabic, and became the foundation of the surgery of Abulcasis, which in turn (to anticipate) was one of the chief sources of surgical knowledge to Europe in the middle ages. The succeeding period of Byzantine history was so little favourable to science that no name worthy of note occurs again (though many medical works of this period are still extant) till the 13th century, when we meet with a group of writers. Demetrius Phepagomenus, Nicolaus Myropus and Johannes, called Actuarius, who flourished under the protection of the Palaeologi. The work of the last has some independent merit; but all are interesting as showing a fusion of Greek and Arabian medicine, the latter having begun to exercise even in the 11th century a reflex influence on the schools of Byzantium. Something was borrowed even from the school of Salerno, and thus the close of Byzantine medicine is brought into connexion with the dawn of science in modern Europe.

In the West the period after Galen affords little evidence of anything but a gradual though unvarying decline in Roman medicine. Caelius Aurelianus, already referred to as the follower of Soranus, must be mentioned as showing the persistence of the methodic school. An abridgment of one of his writings, with the title of *Aurelius*, became the most popular of all Latin medical works. As a writer he was worthy of a better period of medical literature. Little else was produced in these times but compilations, of the most meagre kind, chiefly of the nature of herbals, or domestic receipt-books; among the authors of which it may be sufficient to name Serenus Sammonicus (3rd century), Gargilius Martialis (3rd century) and Marcellus Empiricus (5th century). Certain compilations still extant bear the falsely-assumed names of eminent writers, such as Pliny and Hippocrates and the (perhaps assumed) name of Apuleius Platonius produced a herbal which held its ground till the 15th century at least, and was in the 9th translated into Anglo-Saxon. These poor compilations, together with Latin translations of certain works of Galen and Hippocrates, formed a medical literature, meagre and unprogressive indeed, but of which a great part survived through the middle ages till the discovery of printing and revival of learning. It is important to remember that this obscure stream of tradition flowed on, only partially affected by the influx of Arabian, or even the early revival of purer classical learning.

Arabian Medicine.—The rise of the Mahomedan Empire, which influenced Europe so deeply both politically and intellectually, made its mark also in the history of medicine. As in the parallel case of the Roman conquest of Greece, the superior culture of the conquered race asserted its supremacy over their Arab conquerors. After the Mahomedan conquests became consolidated, and learning began to flourish, schools of medicine, often connected with hospitals and schools of pharmacy, arose in all the chief seats of Moslem power. At Damascus Greek medicine was zealously cultivated with the aid of Jewish and Christian teachers. In Bagdad, under the rule of Harūn el Rashid and his successors, a still more flourishing school arose, where numerous translations of Greek medical works were made. The names of Mesua, or Yahya ibn Māsawāh (d. A.D. 857-858), celebrated for his knowledge of drugs, and Honein ibn Ishaq el 'Ibādī (d. 873) or Joannitius, the translator and commentator of Hippocrates and Galen, belong to this period. Certain writings of Joannitius, translated into Latin, were popular in the middle ages in Europe, and were printed in the 16th century. At the same time the Arabs became acquainted with Indian medicine, and Indian physicians lived at the court of Bagdad. The Islamite rulers in Spain were not long behind those of the East in encouraging learning and medical science, and developed culture to a still higher degree of perfection. In that country much was due to the Jews, who had already established schools in places which were afterwards the seats of Moslem dominion. From the 10th to the 13th century was the brilliant period of Arabian medicine in Spain.¹

The classical period of Arabian medicine begins with Rhazes (Abū Bakr Muḥammad ibn Zakariyā el-Rāzi, A.D. 925-926), a native of Rai in the province of Daikam (Persia), who practised with distinction at Bagdad; he followed the doctrine of Galen, but learnt much from Hippocrates. He was the first of the Arabs to treat medicine in a comprehensive and encyclopaedic manner, surpassing probably in voluminousness Galen himself, though but a small proportion of his works are extant. Rhazes is deservedly remembered as having first described small-pox and measles in an accurate manner. Hali, *z.*e. 'Alī ibn el-'Abbās, a Persian, wrote a medical textbook, known as the "Royal Book" which was the standard authority among the Arabs up to the time of Avicenna (A.D. 980-1037) and was more than once translated into Latin and printed. Other

¹ See Dozy, *Cat. Cod. Or. Lug. Bat. ii.* 296.

writers of this century need not be mentioned here; but the next, the 11th century, is given as the probable though uncertain date of a writer who had a great influence on European medicine, Mesua the younger of Damascus, whose personality is obscure, and of whose very existence some historians have doubted, thinking that the name was assumed by some medieval Latin writer. The work *De simplicibus*, which bears his name, was for centuries a standard authority on the subject, and is called *materia medica*, was printed in twenty-six editions in the 15th century and later, and was used in the formation of the first London pharmacopoeia, issued by the College of Physicians in the reign of James I. Either to the 10th or the 11th century must be referred the name of another Arabian physician who has also attained the position of a classic, Abu'l-Qāsim or Abulcasis, of El-Zahra, near Cordova, in Spain. His great work, *Alaqarifi*, a medical encyclopaedia, is chiefly valued for its surgical portion (already mentioned), which was translated into Latin in the 16th century, and was for some centuries a standard if not the standard authority on surgery in Europe. Among his own countrymen the fame and position of Abulcasis were soon eclipsed by the greater name of Avicenna.

Avicenna has always been regarded as the chief representative of Arabian medicine. He wrote on philosophy also, and in both subjects acquired the highest reputation through the whole of eastern Islam. In Mahomedan Spain he was less regarded, but in Europe his works even eclipsed an superadded those of Hippocrates and Galen. His literary power is highly prized, but the subject-matter shows little originality. The work by which he is chiefly known, the celebrated "canon," is an encyclopaedia of medical and surgical knowledge, founded upon Galen, Aristotle, the later Greek physicians, and the earlier Arabian writers, singularly complete and systematic, but is thought not to show the practical experience of its author. As in the case of Galen, the formal and encyclopaedic character of Avicenna's works was the chief cause of his popularity and ascendancy, though in modern times these very qualities in scientific or medical writing would rather cause him to become more speedily antiquated.

In the long list of Arabian medical writers none can here be mentioned except the great names of the Hispano-Moorish school, a school both philosophically and medically antagonistic to that of Avicenna. Of these the earliest is AVERROAZ or Abumeron, that is, Abū Merwān 'Abd al-Malik Ibn Zur' (beginning of 12th century), a member of a family which gave several distinguished members to the medical profession. His chief work, *Al-tafseer* (commentary), is thought to show more practical experience than the writings of Avicenna, and to be less based upon dialectical subtleties. It was translated into Latin, and more than once printed, as were some of his lesser works, which thus formed a part of the contribution made by the Arabians to European medicine. His friend and pupil AVERROES of Cordova (*q.v.*), so well known for his philosophical writings, was also an author in medical subjects, and as such widely read in Latin. The famous Rabbi MAIMONIDES (A.D. 1135-1204) (*q.v.*) closes for us the roll of medical writers of the Arabian school. His works exist chiefly in the original Arabic or in Hebrew translations; only some smaller treatises have been translated into Latin, so that no definite opinion can be formed as to their medical value. But, so far as is known, the independent and rationalistic spirit which the two last-named writers showed in philosophy did not lead them to take any original point of view in medicine.

The works of the Arabian medical writers who have now been mentioned form a very small fraction of the existing literature. Three hundred medical writers in Arabic are enumerated by Ewald and Wüstenfeld (1808-1899), and other historians have enlarged the list (Häser), but only three have been printed in the original; a certain number more are known through old Latin translations, and the great majority still exist in manuscript. It is thus evident that the circumstance of having been translated (which may have been in some cases almost an accident) is what has chiefly determined the influence of particular writers on Western medicine. But it is improbable that further research will alter the general estimate of the value of Arabian medicine. There can be no doubt that it was in the main Greek medicine, modified to suit other climates, habits and national tastes, and with some important additions from Oriental sources. The greater part is taken from Hippocrates, Galen, Dioscorides and later Greek writers. The Latin medical writers were necessarily unknown to the Arabs; and this was partly the cause that even in Europe Galenic medicine assumed such a preponderance, the methodic school and Celsus being forgotten or neglected. In anatomy and physiology the Arabians distinctly went back; in surgery they showed no advance upon the Greeks; in practical medicine nothing new can be traced, except the description of certain diseases (*e.g.*, small-pox and measles) unknown or imperfectly known to the Greeks; the only real advance was in pharmacy and the therapeutical use of drugs. By their relations with the farther East, the Arabs became acquainted with valuable new remedies which have held their ground till modern times; and their skill in chemistry enabled them to prepare new chemical remedies, and form many of those now ready in use. The first pharmacopoeia was established at the first apothecaries' shops. Many of the names and many forms of medi-

cines now used, and in fact the general outline of modern pharmacy, except so far as modified by modern chemistry, started with the Arabs. Thus does Arabian medicine appear as judged from a modern standpoint; but to medieval Europe, when little but a tradition remained of the great ancient schools, it was invested with a far higher degree of originality and importance.

It is now necessary to consider what was the state of medicine in Europe after the fall of the Western Empire and before the influence of Arabian science and literature began to be felt. This we may call the pre-Arabian or Salernitan period.

Medicine in the Early Middle Ages: School of Salerno.—In medical as in civil history there is no real break. A continuous thread of learning and practice must have connected the last period of Roman medicine already mentioned with the dawn of science in the middle ages. But the intellectual thread is naturally traced with greater difficulty than that which is the theme of civil history; and in periods such as that from the 5th to the 10th century in Europe it is almost lost. The chief homes of medical as of other learning in these disturbed times were the monasteries. Though the science was certainly not advanced by their labours, it was saved from total oblivion, and many ancient medical works were preserved either in Latin or vernacular versions. The Anglo-Saxon Leechdoms¹ of the 11th century, published in the Rolls series of medieval chronicles and memorials, admirably illustrate the mixture of magic and superstition with the relics of ancient science which constituted monastic medicine. Similar works, in Latin or other languages, exist in manuscript in all the great European libraries. It was among the Benedictines that the monastic study of medicine first received a new direction, and aimed at a higher standard. The study of Hippocrates, Galen, and other classics was recommended by Cassiodorus (6th century), and in the original mother-abbey of Monte Cassino medicine was studied; but there was not there what could be called a medical school; nor had this foundation any connexion (as has been supposed) with the famous school of Salerno.

The origin of this, the most important source of medical knowledge in Europe in the early middle ages, is involved in obscurity. It is known that Salerno, a Roman colony, in a situation noted in ancient times for its salubrity, was in the 6th century at least the seat of a bishopric, and at the end of the 7th century of a Benedictine monastery, and that some of the prelates and higher clergy were distinguished for learning, and even for medical acquirements. But it has by recent researches been clearly established that the celebrated *Schola salernitana* was a purely secular institution. All that can with certainty be said is that a school or collection of schools gradually grew up in which especially medicine, but also, in a subordinate degree, law and philosophy were taught. In the 9th century Salernitan physicians were already spoken of, and the city was known as *Civitas hippocratica*. A little later we find great and royal personages resorting to Salerno for the restoration of their health, among whom was William of Normandy, afterwards the Conqueror. The number of students of medicine must at one time have been considerable, and in a corresponding degree the number of teachers. Among the latter many were married, and their wives and daughters appear also in the lists of professors. The most noted female professor was the celebrated Trotula in the 11th century. The Jewish element appears to have been important among the students, and possibly among the professors. The reputation of the school was great till the 12th or 13th century, when the introduction of the Arab medicine was gradually fatal to it. The foundation of the university of Naples, and the rise of Montpellier, also contributed to its decline.

The teachings of the Salernitan doctors are pretty well known through existing works, some of which have only recently been discovered and published. The best-known is the rhyming Latin poem on health by Joannes de Medico, *Regimen sanitatis Salernitanum*, professedly written for the use of the "king of England," supposed to mean William the Conqueror; it had an immense reputation in the middle ages, and was afterwards many times printed, and translated into most European languages. This was a popular work intended for the laity; but there are others strictly professional.

¹ Derived from the Anglo-Saxon *læce*, a physician, and *dom*, a law,

Among the writers it may be sufficient to mention here Gariopontus; Copho, who wrote the *Anatome porci*, a well-known medieval book; Joannes Platearius, first of a family of physicians bearing the same name, whose *Practica*, or medical compendium, was afterwards several times printed; and Trotula, believed to be the wife of the last-named. All of these fall into the first period before the advent of Arabian medicine. In the transitional period, when the Arabian school began to influence European medicine, but before the Salernitan works were superseded, comes Nicolaus Praepositus, who wrote the *Antidotarium*, a collection of formulae for compound medicines, which became the standard work on the subject, and the foundation of many later compilations. An equally popular writer was Gilles de Corbeil (Aegidius Corboliensis), at one time a teacher at Salerno, afterwards court physician to Philip Augustus of France, who composed several poems in Latin hexameters on medical subjects. Two of them, on the urine and the pulse respectively, attained the position of medical classics.

None of these Salernitan works rise much above the rank of compilations, being founded on Hippocrates, Galen and later Greek writers, with an unmistakable mixture of the doctrines of the methodists. But they often show much practical experience, and exhibit the naturalistic method of the Hippocratic school. The general plan of treatment is dietetic rather than pharmaceutical, though the art of preparing drugs had reached a high degree of complexity at Salerno. Anatomy was as little regarded as it was in the later ancient schools, the empiric and methodic; but demonstrations of the parts of the body were given on swine. Although it cannot be said that the science of medicine was advanced at Salerno, still its decline was arrested at a time when every other branch of learning was rapidly falling into decay; and there can be no doubt that the observation of patients in hospitals, and probably clinical instruction, were made use of in learning and teaching. The school of Salerno thus forms a bridge between the ancient and the modern medicine, more direct though less conspicuous than that circuitous route, through Byzantium, Bagdad and Cordova, by which Hippocrates and Galen, in Arabian dress, again entered the European world. Though the glory of Salerno had departed, the school actually existed till it was finally dissolved by an edict of the emperor Napoleon I. in the year 1811.

Introduction of Arabian Medicine: The Scholastic Period.—

About the middle of the 11th century the Arabian medical writers began to be known by Latin translations in the Western world. Constantinus Africanus, a monk, was the author of the earliest of such versions (A.D. 1050); his labours were directed chiefly to the less important and less bulky Arabian authors, of whom Haly was the most noted; the real classics were not introduced till later. For some time the Salernitan medicine held its ground, and it was not till the conquest of Toledo by Alphonso of Castile that any large number of Western scholars came in contact with the learning of the Spanish Moors, and systematic efforts were made to translate their philosophical and medical works. Jewish scholars, often under the patronage of Christian bishops, were especially active in the work. In Sicily also the Oriental tendencies of Frederick Barbarossa and Frederick II. worked in the same direction. Gerard of Cremona, a physician of Toledo (1114-1187), made translations, it is said by command of Barbarossa, from Avicenna and others. It is needless to point out the influence of the crusades in making Eastern ideas known in the Western world. The influence of Arabian medicine soon began to be felt even in the Hippocratic city of Salerno, and in the 13th century is said to have held an even balance with the older medicine. After this time the foreign influence predominated; and by the time that the Aristotelian dialectic, in the introduction of which the Arabs had so large a share, prevailed in the schools of Europe, the Arabian version of Greek medicine reigned supreme in the medical world. That this movement coincided with the establishment of some of the older European universities is well known. The history of medicine in the period now opening is closely combined with the history of scholastic philosophy. Both were infected with the same dialectical subtlety, which was, from the nature of the subject, especially injurious to medicine.

At the same time, through the rise of the universities, medical learning was much more widely diffused, and the first definite forward movement was seen in the school of Montpellier, where a medical faculty existed early in the 12th century, afterwards united with faculties of law and philosophy. The medical school owed its foundation largely to Jewish teachers, themselves educated in the Moorish schools of Spain, and imbued with the

intellectual independence of the Averroists. Its rising prosperity coincided with the decline of the school of Salerno. Montpellier became distinguished for the practical and empirical spirit of its medicine, as contrasted with the dogmatic and scholastic teaching of Paris and other universities. In Italy, Bologna and Padua were earliest distinguished for medical studies—the former preserving more of the Galenic tradition, the latter being more progressive and Averroist. The northern universities contributed little—the reputation even of Paris being of later growth.

The supremacy of Arabian medicine lasted till the revival of learning, when the study of the medical classics in their original language worked another revolution. The medical writers of this period, who chiefly drew from Arabian sources, have been called Arabists (though it is difficult to give any clear meaning to this term), and were afterwards known as the neoterics.

The medical literature of this period is extremely voluminous, but essentially second-hand, consisting mainly of commentaries on Hippocrates, Galen, Avicenna and others, or of compilations and *compendia* still less original than commentaries. Among these may be mentioned the *Conciliator* of Peter of Abano (1250-1315), the *Aggregator* of Jacob de Dondi (1298-1359), both of the school of Padua, and the *Pandectae medicinae* of the Salernitan Matthaeus Sylvaticus (d. 1342), a sort of medical glossary and dictionary. But for us the most interesting fact in the history of Englishmen as authors of medical works having a European reputation, distinguished, according to the testimony of Häser, by a practical tendency characteristic of the British race, and fostered in the school of Montpellier.

The first of these works is the *Compendium medicinae*, also called *Laurea* or *Rosa anglicana*, of Gilbert (Gilbertus Anglicus, about 1290), said to contain good observations on leprosy. A more important work, the *Practica seu usus medicinae*, of Bernard Gordon, a Scottish professor at Montpellier (written in the year 1307), was more widely spread, being translated into French and Hebrew, and printed in several editions. Of these two physicians the first probably, the latter certainly, was educated and practised abroad, but John Gaddesden (1280?-1361), the author of *Rosa anglica seu practica medicinae* (between 1305 and 1317), was a graduate in medicine of Merton College, Oxford, and court physician. His compendium is entirely wanting in originality, and perhaps unusually destitute of common sense, but it became so popular as to be reprinted up to the end of the 16th century. Works of this kind became still more abundant in the 14th and in the first half of the 15th century, till the wider distribution of the medical classics in the original put them out of fashion.

In surgery this period was far more productive than in medicine, especially in Italy and France, but the limits of our subject only permit us to mention Guglielmo de Saliceto of Piacenza (about 1275), Lanfranchi of Milan (died about 1306), the French surgeon, Guy de Chauliac (about 1350) and the Englishman, John Arden (about 1350). In anatomy also the beginning of a new epoch was made by Mondino de Lucei or Mundinus (1275-1326), and his followers. The medical writings of Arnald de Villanova (c. 1235-1313) (if the *Breviarium practicae* be rightly ascribed to him) rise above the rank of compilations. Finally, in the 13th and especially the 14th century we find, under the name of *consilia*, the first medieval reports of medical cases which are preserved in such a form as to be intelligible. Collections of *consilia* were published, among others, by Gentilis Fulgineus before 1348, by Bartolomeo Montagnana (d. 1470), and by Baverius de Baveris of Imola (about 1450). The last-named contains much that is interesting and readable.

Period of the Revival of Learning.—The impulse which all departments of intellectual activity received from the revival of Greek literature in Europe was felt by medicine among the rest. Not that the spirit of the science, or of its corresponding practice, was at once changed. The basis of medicine through the middle ages had been literary and dogmatic, and it was literary and dogmatic still; but the medical literature now brought to light—including as it did the more important works of Hippocrates and Galen, many of them hitherto unknown, and in addition the forgotten element of Latin medicine, especially the work of Celsus—was in itself far superior to the second-hand compilations and incorrect versions which had formerly been accepted as standards. The classical works, though still regarded with unreasoning reverence, were found to have a germinative and vivifying power that carried the mind out of the region of dogma, and prepared the way for the scientific movement which has been growing in strength up to our own day.

Two of the most important results of the revival of learning were indeed such as are excluded from the scope of this brief sketch—namely, the reawakening of anatomy, which to a large extent grew out of the study of the works of Galen, and the investigation of medicinal plants, to which a fresh impulse was given by the revival of Dioscorides (A.D. 50) and other ancient naturalists. The former brought with it necessarily a more accurate conception of physiology, and thus led up to the great discovery of Harvey, which was the turning-point in modern medicine. The latter gave rise, on the one hand, to the modern science of botany, on the other to a more rational knowledge of drugs and their uses. At the same time, the discovery of America, and increased intercourse with the East, by introducing a variety of new plants, greatly accelerated the progress both of botany and pharmacology.

But it was not in these directions that improvement was first looked for. It was at first very naturally imagined that the simple revival of classical and especially of Greek literature would at once produce the same brilliant results in medicine as in literature and philosophy. The movement of reform started, of necessity, with scholars rather than practising physicians—more precisely with a group of learned men, whom we may be permitted, for the sake of a name, to call the medical humanists, equally enthusiastic in the cause of letters and of medicine. From both fields they hoped to expel the evils which were summed up in the word barbarism. Nearly all medieval medical literature was condemned under this name; and for it the humanists proposed to substitute the originals of Hippocrates and Galen, thus leading back medicine to its fountain-head. Since a knowledge of Greek was still confined to a small body of scholars, and a still smaller proportion of physicians, the first task was to translate the Greek classics into Latin. To this work several learned physicians, chiefly Italians, applied themselves with great ardour. Among the earliest were Nicolaus Leoniceus of Vicenza (1428-1524), Giovanni de Monte or Montanus (1498-1552), and many others in Italy. In northern Europe should be mentioned Guelius Copus (1471-1532) and Günther of Andernach (1487-1584), better known as Guinterius Andernacensis, both for a time professors at Paris; and, among the greatest, Thomas Linacre (about 1460-1524; see LINACRE). A little later Janus Cornarius or Hagenbutz (1500-1558) and Leonhard Fuchs (1501-1566) in Germany, and John Kaye of Caius (1510-1572) in England, carried on the work. Symphorien Champier (Champerius or Campegius) of Lyons (1472-1539), a contemporary of Rabelais, and the patron of Servetus, wrote with fantastic enthusiasm on the superiority of the Greek to the Arabian physicians, and possibly did something to enlist in the same cause the two far greater men just mentioned. Rabelais not only lectured on Galen and Hippocrates, but edited some works of the latter; and Michael Servetus (1511-1553), in a little tract *Synonymum universa ratio*, defended the practice of Galen as compared with that of the Arabians. The great Aldine Press made an important contribution to the work, by *editiones principes* of Hippocrates and Galen in the original. Thus was the campaign opened against the medieval and Arabian writers, till finally Greek medicine assumed a predominant position, and Galen took the place of Avicenna. The result was recorded in a formal manner by the Florentine Academy, sometime shortly before 1535: "Quae, excusso. Arabice at barbare servitutis medicae jugo, ex professo Galenicam appellavit et profligato barbarorum exercitu unum totum et solum Galenum, ut optimum artis medicae auctorem, in omnibus se sequitur pollicita est." Janus Cornarius, from whom this is quoted, laments, however, that the Arabians still reigned in most of the schools of medicine, and that the Italian and French authors of works called *Practica* were still in high repute. The triumph of Galenism was therefore not complete by the middle of the 16th century. It was probably most so, and earliest, in the schools of Italy and in those of England, where the London College of Physicians might be regarded as an offshoot of the Italian schools. Paris was the stronghold of conservatism, and Germany was stirred

by the teachings of one who must be considered apart from all schools—Paracelsus. The nature of the struggle between the rival systems may be well illustrated by a formidable controversy about the rules for bleeding in acute diseases. This operation, according to the Arabian practice, was always performed on a vein at a distance from the organ affected. The Hippocratic and also Galenic rule, to let blood from, or near to, the diseased organ, was revived by Pierre Brissot (1470-1522), a professor in the university of Paris. His attempt at reform, which was taken to be, as in effect it was, a revolt against the authority of the Arabian masters, led to his expulsion from Paris, and the formal prohibition by the parliament of his method. Upon this apparently trifling question arose a controversy which lasted many years, occupied several universities, and led to the interposition of personages no less important than the pope and the emperor, but which is thought to have largely contributed to the final downfall of the Arabian medicine.

Paracelsus and Chemical Medicine.—Contemporary with the school of medical humanists, but little influenced by them, lived in Germany a man of strange genius, of whose character and importance the most opposite opinions have been expressed. The first noticeable quality in Paracelsus (c. 1490-1541) is his revolutionary independence of thought, which was supported by his immense personal arrogance. Himself well trained in the learning and medical science of the day, he despised and trampled upon all traditional and authoritative teachings. He began his lectures at Basel by burning the books of Avicenna and others; he afterwards boasted of having read no books for ten years; he protested that his shoe-buckles were more learned than Galen and Avicenna. On the other hand, he spoke with respect of Hippocrates, and wrote a commentary on his *Aphorisms*. In this we see a spirit very different from the enthusiasm of the humanists for a purer and nobler philosophy than the scholastic and Arabian versions of Greek thought. There is no record of Paracelsus' knowledge of Greek, and as, at least in his student days, the most important works of Greek medicine were very imperfectly known, it is probable he had little first hand acquaintance with Galen or Hippocrates, while his breach with the humanists is the more conspicuous from his lecturing and writing chiefly in his native German.

Having thus made a clean sweep of nearly the whole of the dogmatic medicine, what did Paracelsus put in its place? Certainly not pure empiricism, or habits of objective observation. He had a dogma of his own—one founded, according to his German expositors, on the views of the Neoplatonists, of which a few disjointed specimens must here suffice. The human body was a "microcosm" which corresponded to the "macrocosm," and contained in itself all parts of visible nature,—sun, moon, stars and the poles of heaven. To know the nature of man and how to deal with it, the physician should study, not anatomy, which Paracelsus utterly rejected, but all parts of external nature. Life was a perpetual germinative process controlled by the indwelling spirit or Archeus; and diseases, according to the mystical conception of Paracelsus, were not natural but spiritual. Nature was sufficient for the cure of most diseases; art had only to interfere when the internal physician, the man himself, was tired or incapable. Then some remedy had to be introduced which should be antagonistic, not to the disease in a physical sense, but to the spiritual seed of the disease. These remedies were *arcana*—a word corresponding partly to what we now call specific remedies, but implying a mysterious connexion between the remedy and the "essence" of the disease. Arcana were often shown to be such by their physical properties, not only by such as heat, cold, &c., but by fortuitous resemblances to certain parts of the body; thus arose the famous doctrine of "signatures," or signs indicating the virtues and uses of natural objects, which was afterwards developed into great complexity. Great importance was also attached to chemically prepared remedies as containing the essence or spiritual quality of the material from which they were derived. The actual therapeutical resources of Paracelsus included a

large number of metallic preparations, in the introduction of some of which he did good service, and, among vegetable preparations, the tincture of opium, still known by the name he gave it, laudanum. In this doubtless he derived much advantage from his knowledge of chemistry, though the science was as yet not disentangled from the secret traditions of alchemy, and was often mixed up with imposture.

German historians of medicine attach great importance to the revolt of Paracelsus against the prevailing systems, and trace in his writings anticipations of many scientific truths of later times. That his personality was influential, and his intrepid originality of great value as an example in his own country, is undeniable. As a national reformer he has been not inaptly compared to Luther. But his importance in the universal history of medicine we cannot estimate so highly. The chief immediate result we can trace is the introduction of certain mineral remedies, especially antimony, the use of which became a kind of badge of the disciples of Paracelsus. The use of these remedies was not, however, necessarily connected with a belief in his system, which seems to have spread little beyond his own country. Of the followers of Paracelsus some became mere mystical quacks and impostors. Others, of more learning and better repute, were distinguished from the regular physicians chiefly by their use of chemical remedies. In France the introduction of antimony gave rise to a bitter controversy which lasted into the 17th century, and led to the expulsion of some men of mark from the Paris faculty. In England "chemical medicine" is first heard of in the reign of Elizabeth, and was in like manner contemned and assailed by the College of Physicians and the Society of Apothecaries. But it should be remembered that all the chemical physicians did not call Paracelsus master. The most notorious of that school in England, Francis Anthony (1550-1623), never quotes Paracelsus, but relies upon Arnald de Villanova and Raimon Lull. From this time, however, it is always possible to trace a school of chemical practitioners, who, though condemned by the orthodox Galenists, held their ground, till in the 17th century a successor of Paracelsus arose in the celebrated J. B. Van Helmont.

Consequences of the Revival of Ancient Medicine.—The revival of Galenic and Hippocratic medicine, though ultimately it conferred the greatest benefits on medical sciences, did not immediately produce any important or salutary reform in practical medicine. The standard of excellence in the ancient writers was indeed far above the level of the 16th century; but the fatal habit of taking at second hand what should have been acquired by direct observation retarded progress more than the possession of better models assisted it, so that the fundamental faults of mediæval science remained uncorrected.

Nevertheless some progress has to be recorded, even if not due directly to the study of ancient medicine. In the first place the 15th and 16th centuries were notable for the outbreak of certain epidemic diseases, which were unknown to the old physicians. Of these the chief was the "sweating sickness" or "English sweat," especially prevalent in, though not confined to, the country whence it is named. Among many descriptions of this disease, that by John Kaye or Caius, already referred to, was one of the best, and of great importance as showing that the works of Galen did not comprise all that could be known in medicine. The spread of syphilis, a disease equally unknown to the ancients, and the failure of Galen's remedies to cure it, had a similar effect.

In another direction the foundations of modern medicine were being laid during the 16th century—namely, by the introduction of clinical instruction in hospitals. In this Italy, and especially the renowned school of Padua, took the first step, where Giovanni De Monte (Montanus), (1498-1552), already mentioned as a humanist, gave clinical lectures on the patients in the hospital of St Francis, which may still be read with interest. Pupils flocked to him from all European countries; Germans are especially mentioned; a Polish student reported and published some of his lectures; and the Englishman Kaye was a zealous disciple, who does not, however, seem to have done anything towards transplanting this method of instruction to his own country. Inspections of the dead, to ascertain the nature of the disease, were made, though not without difficulty, and thus the modern period of the science of morbid anatomy was ushered in.

Medicine in the 17th Century.—The medicine of the early 17th century presents no features to distinguish it from that

of the preceding century. The practice and theory of medicine were mainly founded upon Hippocrates and Galen, with ever-increasing additions from the chemical school. But the development of mathematical and physical science soon introduced a fundamental change in the habits of thought with respect to medical doctrine.

These discoveries not only weakened or destroyed the respect for authority in matters of science, but brought about a marked tendency to mechanical explanations of life and disease. When William Harvey by his discovery of the circulation furnished an explanation of many vital processes which was reconcilable with the ordinary laws of mechanics, the efforts of medical theorists were naturally directed to bringing all the departments of medicine under similar laws. It is often assumed that the writings and influence of Bacon did much towards introducing a more scientific method into medicine and physiology. But, without discussing the general philosophical position or historical importance of Bacon, it may safely be said that his direct influence can be little traced in medical writings of the first half of the 17th century. Harvey, as is well known, spoke slightly of the great chancellor, and it is not till the rapid development of physical science in England and Holland in the latter part of the century, that we find Baconian principles explicitly recognized.

The dominant factors in the 17th-century medicine were the discovery of the circulation by William Harvey (published in 1628), the mechanical philosophy of Descartes and the contemporary progress of physics, the teaching of Van Helmont and the introduction of chemical explanations of morbid processes, and finally, combined of all these, and inspiring them, the rise of the spirit of inquiry and innovation, which may be called the scientific movement. Before speaking in detail of these, we may note that by other influences quite independent of theories, important additions were made to practical medicine. The method of clinical instruction in hospitals, commenced by the Italians, was introduced into Holland, where it was greatly developed, especially at Leiden, in the hands of Francis de la Boë, called Sylvius (1641-1672). It is noteworthy that concurrently with the rise of clinical study the works of Hippocrates were more and more valued, while Galen began to sink into the background.

At the same time the discovery of new diseases, unknown to the ancients, and the keener attention which the great epidemics of plague caused to be paid to those already known, led to more minute study of the natural history of disease. The most important disease hitherto undescribed was rickets, first made known by Arnold de Boot, a Frisian who practised in Ireland, in 1649, and afterwards more fully in the celebrated work of Francis Glisson (1597-1677) in 1651. The plague was carefully studied by Isbrand de Diemerbroek, in his *De Peste* (1646), and others. Nathaniel Dodger of London (1629-1688) in 1665 seems to have been the first who had the courage to make a post mortem inspection of a plague patient. Christopher Bennet (1617-1655) wrote an important work on consumption in 1654. During the same period many new remedies were introduced, the most important being cinchona-bark, brought to Spain in the year 1640. The progress of pharmacy was shown by the publication of *Dispensatories* or *Pharmacopœiæ*—such as that of the Royal College of Physicians of London in 1618. This, like the earlier German works of the same kind (on which it was partly founded), contains both the traditional (Galenical) and the modern or chemical remedies.

Van Helmont.—The medicine of the 17th century was especially distinguished by the rise of systems; and we must first speak of an eccentric genius who endeavoured to construct a system for himself, as original and opposed to tradition as that of Paracelsus. J. B. Van Helmont (1578-1644) was a man of noble family in Brussels, who, after mastering all other branches of learning as then understood, devoted himself with enthusiasm to medicine and chemistry. By education and position a little out of the regular lines of the profession, he took up in medicine an independent attitude. Well acquainted with the doctrines of Galen, he rejected them as thoroughly as Paracelsus did, and borrowed from the latter some definite ideas as well as his revolutionary spirit. The archæus of Paracelsus

appears again, but with still further complications—the whole body being controlled by the *archeus influens*, and the organ of the soul and its various parts by the *archei insitii*, which are subject to the central *archeus*. Many of the symptoms of diseases were caused by the passions and perturbations of the *archeus*, and medicines acted by modifying the *ideas* of the same *archeus*. These and other notions cannot be here stated at sufficient length to be intelligible. It is enough to say that on this fantastic basis Helmont constructed a medical system which had some practical merits, that his therapeutic methods were mild and in many respects happy, and that he did service by applying newer chemical methods to the preparation of drugs. He thus had some share, though a share not generally recognized, in the foundation of the iatro-chemical school, now to be spoken of. But his avowed followers formed a small and discredited sect, which, in England at least, can be clearly traced in the latter part of the century.

Discovery of the Circulation of the Blood.—The influence of Harvey's discovery began to be felt before the middle of the century. Its merits were recognized by Descartes, among the first, years after its publication. For the history of the discovery, and its consequences in anatomy and physiology, we must refer to the article HARVEY. In respect of practical medicine, much less effect was at first noticeable. But this example, combined with the Cartesian principles, set many active and ingenious spirits to work to reconstruct the whole of medicine on a physiological or even a mechanical basis—to endeavour to form what we should now call physiological or scientific medicine. The result of this was not to eliminate dogma from medicine, though it weakened the authority of old dogma. The movement led rather to the formation of schools, and a reaction of thought, which under various names lasted on into the 18th century, while the belief in the utility or necessity of schools and systems lasted much longer. The most important of these were the so-called iatro-physical or mechanical and the iatro-chemical schools.

Iatro-Physical School.—The iatro-physical school of medicine grew out of physiological theories. Its founder is held to have been G. A. Borelli (1608-1679), whose treatise *De motu animalium*, published in 1684, is regarded as marking an epoch in physiology. The tendency of the school was to explain the actions and functions of the body on physical, and especially on mechanical, principles. The movements of bones and muscles were referred to the theory of levers; the process of digestion was regarded as essentially a process of trituration; nutrition and secretion were shown to be dependent upon the tension of the vessels, and so forth. The developments of this school belong rather to the history of physiology, where they appear, seen in the light of modern science, as excellent though premature endeavours in a scientific direction. But the influence of these theories on practical medicine was not great. There were judicious of the mechanical or physical school remedies as a judicious modern physiologist does, from too immediate an application of their principles to daily practice. Mechanical theories were introduced into pathology, in explanation of the processes of fever and the like, but had little or no influence on therapeutics. The most important men in this school after Borelli were Nicolaus Stensen (Steno), (1638-1686), Giorgio Baglivi (1669-1707) and Lorenzo Bellini (1643-1704). An English physician, William Cole (1635-1716), is also usually ranked with them. One of the most elaborate developments of the system was that of Archibald Pitreane (1652-1713), a Scottish physician who became professor at Leiden, to be spoken of hereafter.

Iatro-Chemical School.—The so-called iatro-chemical school stood in a much closer relation to practical medicine than the iatro-physical. The principle which mainly distinguished it was not merely the use of chemical medicines in addition to the traditional, or, as they were called in distinction, "Galenic" remedies, but a theory of pathology or causation of disease entirely different from the prevailing "humoral" pathology. Its chief aim was to reconcile the new views in physiology and chemistry with practical medicine. In some theoretical views, and in the use of certain remedies, the school owed something to Van Helmont and Paracelsus, but took in the main an independent position. The founder of the iatro-chemical school was Sylvius (1614-1672), who belonged to a French family settled in Holland, and was for fourteen years professor of medicine at Leiden, where he attracted students from all quarters of Europe. He made a resolute attempt to reconstruct medicine on the two bases of the doctrine of the circulation of the blood and the new views of chemistry. Fermentation, which was supposed to take place in the stomachs played an important part in the vital processes. Chemical disturbances of these processes, called *acridities*, &c., were the cause of fevers and other diseases. Sometimes acid sometimes alkaline properties predominated in the juices and secretions of the body, and produced corresponding disturbances. In nervous diseases disturbances of the vital "spirits" were most important. Still in some parts of his system Sylvius shows an anxiety to base his pathology on anatomical changes. The remedies he employed were partly galenic, partly chemical. He was very moderate in the use of bleeding.

The doctrines of Sylvius became widely spread in Holland and Germany; less so in France and Italy. In England they were not

generally accepted till adopted with some modifications by Thomas Willis the great anatomist (1621-1675), who is the chief English representative of the chemical school. Willis was as thorough-going a chemist as Sylvius. He regarded all bodies, organic and inorganic, as composed of the three elements—spirit, sulphur and salt, the first being only found abundantly in animal bodies. The "intestinal movement of particles" in every body, or fermentation, was the explanation of many of the processes of life and disease. The sensible properties and physical alterations of animal fluids and solids depended upon different proportions, movements and combinations of these particles. The elaborate work *Pharmacœuticæ rationalis* (1674), based on these materials, had much influence in its time, though it was soon forgotten. But some parts of Willis's works, such as his descriptions of nervous diseases, and his account (the earliest) of diabetes, are classical contributions to scientific medicine. In the application of chemistry to the examination of secretions Willis made some important steps. The chemical school met with violent opposition, partly from the adherents of the ancient medicine, partly from the iatro-mechanical school. Towards the end of the 17th century appeared an English medical reformer who sided with none of these schools, but may be said in some respects to have surpassed and dispensed with them.

Sydenham and Locke.—Thomas Sydenham (1624-1689) was educated at Oxford and at Montpellier. He was well acquainted with the works of the ancient physicians, and probably fairly so with chemistry. Of his knowledge of anatomy nothing definite can be said, as he seldom refers to it. His main avowed principle was to do without hypothesis, and study the actual diseases in an unbiased manner. As his chief aim in medical modifications, Sydenham repeatedly and pointedly refers to Hippocrates, and he has not unfairly been called the English Hippocrates. He resembled his Greek master in the high value he set on the study of the "natural history of disease"; in the importance he attached to "epidemic constitution"—that is, to the influence of weather and other natural causes in modifying disease; and further in his conception of the healing power of nature in disease, a doctrine which he even expanded beyond the teaching of Hippocrates. According to Sydenham, a disease is nothing more than an effort of nature to restore the heat and defend the system from the influence of modifying causes. The extent to which his practice was influenced by this and other a priori conceptions prevents us from classing Sydenham as a pure empiric; but he had the rare merit of never permitting himself to be enslaved even by his own theories. Still less was his mind warped by either of the two great systems, the classical and the chemical, which then divided the medical world. Sydenham's influence on European medicine was very great. His principles were welcomed as a return to nature by those who were weary of theoretical disputes. He introduced a milder and better way of treating fevers—especially straggling straggling fevers—in the use of medicinal wines, especially Peruvian bark. He was an advocate of bleeding, and often carried it to excess. Another important point in Sydenham's doctrine is his clear recognition of many diseases as being what would be now called *specific*, and not due merely to an alteration in the primary qualities or humours of the older schools. From this springs his high appreciation of specific medicines.

One name should always be mentioned along with Sydenham—that of his friend John Locke. The great sensational philosopher was a thoroughly trained physician, and practised privately. He shared and defined many of Sydenham's principles, and in the few medical observations he has left shows himself to be even more thorough-going than the "English Hippocrates." It is deeply to be regretted in the interests of medicine that he did not write more. It is, however, reasonable to suppose that his commanding intellect often makes itself felt in the words of Sydenham. One sentence of Locke's, in a letter to William Molyneux, sums up the practical side of Sydenham's teaching:—

"You cannot imagine how far a little observation carefully made by a man not tied up to the four humours [Galien], or sal, sulphur and mercury [Paracelsus], or to acid and alkali [Sylvius and Willis] which has of late prevailed, will carry a man in the curing of diseases though very stubborn and dangerous; and that with very little and common things, and almost no medicine at all."

We thus see that, while the great anatomists, physicists and chemists—men of the type of Willis, Borelli and Boyle—were laying foundations which were later on built up into the fabric of scientific medicine, little good was done by the premature application of their half-understood principles to practice. The reform of practical medicine was effected by men who aimed at, and partly succeeded in, projecting all hypothesis and returning to an unbiased study of natural processes as shown in health and disease.

Sydenham showed that these processes might be profitably studied and dealt with without explaining them; and, by turning men's minds away from explanations and fixing them on facts, he enriched medicine with a *method* more fruitful than any discoveries in detail. From this time forth the reign of canonical authority in medicine was at an end, though the dogmatic spirit long survived.

The 18th Century.—The medicine of the 18th century is notable, like that of the latter part of the 17th, for the striving

after complete theoretical systems. The influence of the iatro-physical school was by no means exhausted; and in England, especially through the indirect influence of Sir Isaac Newton's (1642-1727) great astronomical generalizations, it took on a mathematical aspect, and is sometimes known as iatro-mathematical. This phase is most clearly developed in Archibald Pitcairne (1652-1713), who, though a determined opponent of metaphysical explanations, and of the chemical doctrines, gave to his own rude mechanical explanations of life and disease almost the dogmatic completeness of a theological system. His countryman and pupil, George Cheyne (1671-1743), who lived some years at Bath, published a new theory of fevers on the mechanical system, which had a great reputation. Their English contemporaries and successors, John Freind, William Cole, and Richard Mead, leaned also to mechanical explanations, but with a distrust of systematic theoretical completeness, which was perhaps partly a national characteristic, partly the result of the teaching of Sydenham and Locke. Freind (1675-1728) in his *Emmenologia* gave a mechanical explanation of the phenomena of menstruation. He is also one of the most distinguished writers on the history of medicine. Cole (1635-1716) (see above) published mechanical hypotheses concerning the causation of fevers which closely agree with those of the Italian iatro-mechanical school. More distinguished in his own day than any of these was Mead (1673-1754), one of the most accomplished and socially successful physicians of modern times. Mead was the pupil of the equally popular and successful John Radcliffe (1650-1714), who had acquired from Sydenham a contempt for book-learning, and belonged to no school in medicine but the school of common sense. Radcliffe left, however, no work requiring mention in a history of medicine. Mead, a man of great learning and intellectual activity, was an ardent advocate of the mathematical doctrines. "It is very evident," he says, "that all other means of improving medicine have been found ineffectual, by the stand it was at for two thousand years, and that, since mathematicians have set themselves to the study of it, men already begin to talk so intelligibly and comprehensibly, even about abstruse matters, that it is to be hoped that mathematical learning will be the distinguishing mark of a physician and a quack." His *Mechanical Account of Poisons*, in the first edition (1702), gave an explanation of the effects of poisons, as acting only on the blood. Afterwards he modified his hypothesis, and referred the disturbances produced to the "nervous liquor," which he supposed to be a quantity of the "universal elastic matter" diffused through the universe, by which Newton explained the phenomena of light—i.e. what was afterwards called the luminiferous ether. Mead's treatise on *The Power of the Sun and Moon over Human Bodies* (1704), equally inspired by Newton's discoveries, was a premature attempt to assign the influence of atmospheric pressure and other cosmical causes in producing disease. His works contain, however, many original experiments, and excellent practical observations. James Keill (1673-1719) applied Newtonian and mechanical principles to the explanation of bodily functions with still greater accuracy and completeness; but his researches have more importance for physiology than for practical medicine.

Boerhaave.—None of these men founded a school—a result due in part to their intellectual character, in part to the absence in England of medical schools equivalent in position and importance to the universities of the Continent. An important academic position was, on the other hand, one of the reasons why a physician not very different in his way of thinking from the English physicians of the age of Queen Anne was able to take a far more predominant position in the medical world. Hermann Boerhaave (1668-1738) was emphatically a great teacher. He was for many years professor of medicine at Leiden, where he lectured five hours a day, and excelled in influence and reputation not only his greatest forerunners, Montanus of Padua and Sylvius of Leiden, but probably every subsequent teacher. The hospital of Leiden, though with only twelve beds available for teaching, became the centre of medical influence in Europe. Many of the leading English physicians of the 18th century studied there; Gerard Van Swieten (1700-1772), a pupil of Boerhaave, transplanted the latter's method of teaching to Vienna, and founded the noted Vienna school of medicine.

As the organizer, and almost the constructor, of the modern method of clinical instruction, the services of Boerhaave to the progress of medicine were immense, and can hardly be overrated. In his teaching, as in his practice, he avowedly followed the method of Hippocrates and Sydenham, both of whom he enthusiastically admired. In his medical doctrines he must be pronounced an eclectic, though taking his stand mainly on the iatro-mechanical school. The best-known parts of Boerhaave's system are his theories of inflammation, obstruction and "plethora." By the last named especially he was long remembered. His object was to make all the anatomical and physiological acquisitions of his age, even microscopic anatomy, which he diligently studied, available for use in the practice of medicine. He thus differed from Sydenham, who took almost as little account of modern science as of ancient dogma. Boerhaave may be in some respects compared to Galen, but again differed from him in that he always abstained from attempting to reduce his knowledge to a uniform and coherent system. Boerhaave attached great importance to the study of the medical classics, but rather tended, historically than quoted them as canonical authorities. It almost follows from the nature of the case that the great task of Boerhaave's life, a synthesis of ancient and modern medicine, and the work in which this is chiefly contained, his celebrated *Institutions*, could not have any great permanent value. Nearly the same thing is true even of the *Aphorisms*, in which, following the example of Hippocrates, he endeavoured to sum up the results of his long experience.

Zenker and Wundt.—We now speak of two writers in whom the systematic tendency of the 18th century showed itself most completely.

Friedrich Hoffmann (1660-1742), like Boerhaave, owed his influence, and perhaps partly his intellectual characteristics, to his academic position. He was in 1693 appointed the first professor of medicine in the university of Halle, then just founded by the elector Frederick III. Here he became, as did his contemporary and rival Stahl, a popular and influential teacher, though their university had not the European importance of Leiden. Hoffmann's "system" was apparently intended to reconcile the opposing "spiritual" and "materialistic" views of nature, and is thought to have been much influenced by the philosophy of Leibnitz. His medical theories rest upon a complete theory of the universe. Life depended upon a universally diffused ether, which animals breathe in from the atmosphere, and which is contained in all parts of the body. It accumulates in the brain, and there generates the "nervous fluid" or *pneuma*—a theory closely resembling that of Mead on the "nervous liquor," and indeed Mead borrowed it from Hoffmann. On this system he explained all the phenomena of life and disease. Health depends on the maintenance of a proper "tone" in the body—some diseases being produced by excess of tone, or "spasm"; others by a "atony," or want of tone. But it is impossible here to follow its further developments. Independently of his system, which has long ceased to exert any influence, Hoffmann made some contributions to practical medicine; and his great knowledge of chemistry enabled him to investigate the subject of mineral waters. He was equally skillful in pharmacy, but lowered his position by the practice, which would be unpardonable in a modern physician, of trafficking in secret remedies.

George Ernest Stahl (1660-1734) was for more than twenty years professor of medicine at Halle, and thus a colleague of Hoffmann, whom he resembled in constructing a complete theoretical system, though their systems had little or nothing in common. Stahl's chief aim was to oppose materialism. For mechanical conceptions he substituted the theory of "animism"—attributing to the soul the functions of ordinary animal life in man, while the life of the inorganic bodies was mechanical. The various symptoms of disease were explained as efforts of the soul to rid itself from morbid influences, the soul acting reasonably with respect to the end of self-preservation. The anima thus corresponds partly to the "nature" of Sydenham, while in other respects it resembles the archeus of Van Helmont. Animism in its completeness met with little acceptance during the lifetime of its author, but influenced some of the iatro-physical school. Stahl was the author of the theory of "phlogiston" in chemistry, which in its day had great importance.

Haller and Morgagni.—From the subtleties of rival systems it is a satisfaction to turn to two movements in the medicine of the 18th century, which, though they did not extinguish the spirit of system-making, opened up paths of investigation by which the systems were ultimately superseded. These are physiology in the modern sense, as dating from Haller, and pathological anatomy, as dating from Morgagni.

Albrecht von Haller (1708-1777) was a man of even more encyclopaedic attainments than Boerhaave. He advanced chemistry, botany, anatomy, as well as physiology, and was incessantly occupied in endeavouring to apply his scientific studies to practical medicine, thus continuing the work of his great teacher Boerhaave. Besides all this he was probably more profoundly acquainted with the literature and bibliography of medicine than any one before or since. Haller occupied in the new university of Göttingen (founded 1737) a position corresponding to that of Boerhaave at Leiden, and in like manner influenced a very large circle of pupils.

The appreciation of his work in physiology belongs to the history of that science; we are only concerned here with its influence on medicine. Haller's definition of irritability as a property of muscular tissue, and its distinction from sensibility as a property of nerves, struck at the root of the prevailing hypothesis respecting animal activity. It was no longer necessary to suppose that a half-conscious "anima" was directing every movement. Moreover, Haller's views did not rest on a priori speculation, but on numerous experiments. He was among the first to investigate the action of medicines on healthy persons. Unfortunately the lesson which his contemporaries learnt was not the importance of experiment, but only the need of contriving other "systems" less open to objection; and thus the influence of Haller led directly to the theoretical subtleties of William Cullen and John Brown, and only indirectly and later on to the general anatomy of M. F. X. Bichat. The great name of Haller does not therefore occupy a very prominent place in the history of practical medicine.

The work of Giovanni Battista Morgagni (1682-1771) had and still preserves a permanent importance beyond that of all the contemporary theorists. In a series of letters, *De sedibus et causis morborum per anatonem indagatis*, published when he was in his eightieth year, he describes the appearances met with at the post mortem examination as well as the symptoms during life in a number of cases of various diseases. It was not the first work of the kind. The Swiss physician, Théophrastus Bonet (1620-1689) had published his *Sépulchretum* in 1679; and observations of post mortem appearances had been made by Montanus, P. Tulpius, and N. Westermann. G. M. Lancetti, Harmer, and others. But never before was so large a collection of cases brought together, described with such accuracy, or illustrated with equal anatomical and medical knowledge. Morgagni's work at once made an epoch in the science. Morbid anatomy now became a recognized branch of medical research, and the movement was started which has lasted till our own day.

The contribution of Morgagni to medical science must be regarded as in some respects the counterpart of Sydenham's. The latter had, in neglecting anatomy, neglected the most solid basis for studying the natural history of disease; though perhaps it was less his choice than his inactivity, as he was not attached to a hospital, gave him no opportunities. But it is on the combination of the two methods—that of Sydenham and of Morgagni—that modern medicine rests; and it is through these that it has been able to make steady progress in its own field, independently of the advance of physiology or other sciences.

The method of Morgagni found many imitators, both in his own country and in others. In England the first important name in this field is at the same time that of the first writer of a systematic work in any language on morbid anatomy, Matthew Baillie (1761-1824), a nephew of John and William Hunter, who published his treatise in 1795.

Cullen and Brown.—It remains to speak of two systematic writers on medicine in the 18th century, whose great reputation prevents them from being passed over, though their real contribution to the progress of medicine was not great—Cullen and Brown.

William Cullen (1710-1790) was a most eminent and popular professor of medicine at Edinburgh. The same academical influences as surrounded the Dutch and German founders of systems were doubtless partly concerned in leading him to form the plan of a comprehensive system of medicine. Cullen's system was largely based on the new physiological doctrine of irritability, but is especially noticeable for the importance attached to nervous action. Thus even gout was regarded as a "neurosis." These pathological principles of Cullen are contained in his *First Lines of the Practice of Physic*, an extremely popular book, often reprinted and translated. More importance is to be attached to his *Nosology or Classification of Diseases*. The attempt to classify diseases on a natural-history plan was not new, having been commenced by Sauvages and others, and is perhaps not a task of the highest importance. Cullen drew out a classification of great and needless complexity, the chief part of which is now forgotten, but several of his main divisions are still preserved.

It is difficult to form a clear estimate of the importance of the last systematizer of medicine—John Brown (1735-1788)—for, though in England he has been but little regarded, the wide though short-lived popularity of his system on the Continent shows that it must have contained some elements of brilliancy, if not originality. His theory of medicine professed to explain the processes of life and disease, and the methods of cure, upon one simple principle—that of the property of "excitability," in virtue of which the "exciting powers," defined as being (1) external forces and (2) the motions of the system itself, enforce the vital phenomena (sense, action, mental function) and passion. All exciting powers are stimulant, the apparent debilitating or sedative effect of some being due to a deficiency in the degree of stimulus; so that the final conclusion is that "the whole phenomena of life, health as well as disease, consist in stimulus and nothing else." Brown recognized some diseases as *sthenic*, others as *asthenic*, the latter requiring stimulating treatment, the former the reverse; but his practical conclusion was that 97% of all diseases required a "stimulating" treatment. In this he claimed to have made the most

salutary reform because all physicians from Hippocrates had treated diseases by depletion and debilitating measures with the object of curing by elimination. It would be unprofitable to attempt a complete analysis of the Brunonian system; and it is difficult now to understand why it attracted so much attention in its day. To us at the present time it seems merely a didactical construction, having its beginning and end in definitions: the words power, stimulus, &c., being used in such a way as not to correspond to any precise physical conceptions, still less to definite material objects or forces. One recommendation of the system was that it favoured a milder system of treatment than was at that time in vogue; Brown may be said to have been the first advocate of the modern stimulant or feeding treatment of fevers. He advocated the use of "animal soups" or beef-tea. Further, he had the discernment to see that certain symptoms—such as convulsions and delirium, which were then commonly held always to indicate inflammation—were often really signs of weakness.

The fortunes of Brown's system (called from having been originally written in Latin, the Brunonian) form one of the strangest chapters in the history of medicine. In Scotland, Brown so far won the sympathy of the students that riotous conflicts took place between his partisans and opponents. In England his system took little root. In Italy, on the other hand, it received enthusiastic support, and, naturally, a corresponding degree of opposition. The most important adherent to Brown's system was J. Rasori (1763-1837), who taught it as professor at Pavia, but afterwards substituted his own system of contra-stimulus. The theoretical difference between this and the stimulus theory need not be expounded. The practical difference in the corresponding treatment was very great, as Rasori advocated a copious use of bleeding and of depressing remedies, such as antimony. Joseph Frank (1774-1841), a German professor at Pavia, afterwards of Vienna, the author of an encyclopaedic work on medicine now forgotten, embraced the Brunonian system, though he afterwards introduced some modifications, and transplanted it to Vienna. Many names are quoted as partisans or opponents of the Brunonian system in Italy, but scarcely one of them has any other claim to be remembered. In Germany the new system called forth, a little later, no less enthusiasm and controversy. Girtanner (1760-1800) first began to spread the new idea (though given out as his own), but Weickard was the first avowed advocate of the system. Röschlaub (1768-1835) modified Brown's system into the theory of excitement (*Erregungstheorie*), which for a time was extremely popular in Germany. The enthusiasm of the younger Brunonians in Germany was as great as in Edinburgh or in Italy, and led to serious riots in the university of Göttingen. In America the system was enthusiastically adopted by a noted physician, Benjamin Rush (1745-1813), of Philadelphia, who was followed by a considerable school. France was not more influenced by the new school than England. In both countries, its tendency towards positive science and progress by objective investigation was too marked for any theoretical system to have more than a passing influence. In France, however, the influence of Brown's theories is very clearly seen in the writings of François J. V. Broussais, who, though not rightly classed with the system-makers, since his conclusions were partly based upon anatomical investigation, resembled them in his attempt to unite theory and practice in one comprehensive synthesis. The explanation of the meteoric splendour of the Brunonian system in other countries seems to be as follows. In Italy the period of intellectual decadence had set in, and no new scientific ideas remained to withstand the novelties of abstract theory. In Germany the case was somewhat different. Intellectual activity was not wanting, but the great achievements of the 18th century in philosophy and the moral sciences had fostered a love of abstract speculation; and some sort of cosmical or general system was thought indispensable in every department of special science. Hence another generation had to pass away before Germany found herself on the level, in scientific investigation, of France and England.

Before the theoretic tendency of the 18th century was quite exhausted, it displays itself in a system which, though in some respects isolated in the history of medicine, stands nearest to that of Brown—that, namely, of Hahnemann (see HOWSON, p. 127). S. C. F. Hahnemann (1753-1844) was in conception as revolutionary a reformer of medicine as Paracelsus. He professed to base medicine entirely on a knowledge of symptoms, regarding all investigations of the causes of symptoms as useless. While thus rejecting all the lessons of morbid anatomy and pathology, he put forward views respecting the causes of disease which hardly bear to be seriously stated. All chronic maladies result either from three diseases—psora (the itch), syphilis or sycois (a skin disease), or else are maladies produced by medicines. Seven-eighths of all chronic diseases are produced by the driven inward.¹ (It is fair to say that these views were published in one of his later works.) In treatment of disease Hahnemann rejected entirely the notion of a *vis medicatrix naturae*, and was guided by his well-known principle

¹ The itch (*scabies*) is really an affection produced by the presence in the skin of a species of mite (*Acarus scabiei*), and when this is destroyed or removed the disease is at an end.

"similia similibus curantur," which he explained as depending on the law that in order to get rid of a disease some remedy must be given which should substitute for the disease an action dynamically similar, but weaker. The original malady being thus got rid of, the vital force would easily be able to cope with and extinguish the slighter disturbance caused by the remedy. "Something very similar was held by Brown, who taught that "indirect debility" was to be cured by a lesser degree of the same stimulus as had caused the original disturbance. Generally, however, Hahnemann's views contradict those of Brown, though moving somewhat in the same plane. In order to select remedies which should fulfil the indication of producing symptoms like those of the disease, Hahnemann made many observations of the action of drugs on healthy persons. He did not originate this line of research, for it had been pursued, if not originated, by Haller, and cultivated systematically by Tommasini, an Italian "contra-stimulist"; but he carried it out with much elaboration. His results, nevertheless, were vitiated by being obtained in the interest of a theory, and by singular want of discrimination. In his second period he developed the theory of "potentiality" or dynamization—namely, that medicines gained in strength by being diluted, if the dilution was accompanied by shaking or pounding, which was supposed to "potentiate" or increase the potency of the medicine. On this principle Hahnemann ordered his original tinctures to be reduced in strength to one-fiftieth; these first dilutions again to one-fiftieth; and so on, every till the thirtieth dilution, which he himself used by preference, and to which he ascribed the highest "potentiality." From a theoretical point of view Hahnemann's is one of the abstract systems, pretending to universality, which modern medicine neither accepts nor finds it worth while to controvert. In the treatment of disease his practical innovations came at a fortunate time, when the excesses of the depletory system had only partially been superseded by the equally injurious opposite extreme of Brown's stimulant treatment. Hahnemann's use of mild and often quite inert remedies contrasted favourably with both of these. Further, he did good by insisting upon simplicity in prescribing, when it was the custom to give a number of drugs, often heterogeneous and inconsistent, in the same prescription. But these indirect benefits were quite independent of the truth or falsity of his theoretical system.

Possitive Progress in the 18th Century.—In looking back on the repeated attempts in the 18th century to construct a universal system of medicine, it is impossible not to regret the waste of brilliant gifts and profound acquirements which they involved. It was fortunate, however, that the accumulation of positive knowledge in medicine did not cease. While Germany and Scotland, as the chief homes of abstract speculation, gave birth to most of the theories, progress in objective science was most marked in other countries—in Italy first, and afterwards in England and France. We must retrace our steps a little to enumerate several distinguished names which, from the nature of the case, hardly admit of classification.

In Italy the tradition of the great anatomists and physiologists of the 17th century produced a series of accurate observers and practitioners. Among the first of these were Antonio Maria Valsalva (1666-1723), still better known as an anatomist; Giovanni Maria Lancisi (1654-1720), also an anatomist, the author of a classical work on the diseases of the heart and aneurisms; and Ippolito Franciscio Albertini (1662-1738), whose researches on the same class of diseases were no less important.

In France, Jean Baptiste Sénac (1693-1770) wrote also an important work on the affections of the heart. Sauvages, otherwise F. B. de Lacroix (1706-1767), gave, under the title *Nosologia methodica*, a natural-history classification of diseases; Jean Astruc (1684-1766) contributed to the knowledge of general diseases. But the state of medicine in that country till the end of the 18th century was unsatisfactory as compared with some other parts of Europe.

In England the brilliancy of the early part of the century in practical medicine was hardly maintained to the end, and presented, indeed, a certain contrast with the remarkable and unflagging progress of surgery in the same period. The roll of the College of Physicians does not furnish many distinguished names. Among these should be mentioned John Fothergill (1712-1780), who investigated the "putrid sore throat" now called diphtheria, and the form of neuralgia popularly known as tic douloureux. A physician of Plymouth, John Hurham (1694-1768), made researches on epidemic fevers, in the spirit of Sydenham and Hippocrates, which are of the

highest importance. William Heberden (1710-1801), a London physician, called by Samuel Johnson *ultimus Romanorum*, "the last of our learned physicians," left a rich legacy of practical observations in the *Commentaries* published after his death. More important in their results than any of these works were the discoveries of EDWARD JENNER (q.v.), respecting the prevention of small-pox by vaccination, in which he superseded the partially useful but dangerous practice of inoculation, which had been introduced into England in 1721. The history of this discovery need not be told here, but it may be pointed out that, apart from its practical importance, it has had great influence on the scientific study of infectious diseases. The name of John Pringle (1707-1782) should also be mentioned as one of the first to study epidemics of fevers occurring in prisons and camps. His work, entitled *Observations on the Diseases of an Army*, was translated into many European languages and became the standard authority on the subject.

In Germany the only important school of practical medicine was that of Vienna, as revived by Gerard van Swieten (1700-1772), a pupil of Boërhaave, under the patronage of Maria Theresa. Van Swieten's commentaries on the aphorisms of Boërhaave are thought more valuable than the original text. Other eminent names of the same school are Anton de Haën (1704-1776), Anton Störck (1731-1803), Maximilian Stoll (1742-1788), and John Peter Frank (1745-1821), father of Joseph Frank, before mentioned as an adherent of the Brownian system, and like his son carried away for a time by the new doctrines. This, the old "Vienna School," was not distinguished for any notable discoveries, but for success in clinical teaching, and for its sound method of studying the actual facts of disease during life and after death, which largely contributed to the establishment of the "positive medicine" of the 19th century.

One novelty, however, of the first importance is due to a Vienna physician of the period, Leopold Auenbrugger (1722-1809), the inventor of the method of recognizing diseases of the chest by percussion. Auenbrugger's method was that of *direct* percussion with the tips of the fingers, not that which is now used, of *mediate* percussion with the intervention of a finger or plessimeter; but the results of his method were the same and its value nearly as great. Auenbrugger's great work, the *Inventum novum*, was published in 1761. The new practice was received at first with contempt and even ridicule, and afterwards by Stoll and Peter Frank with only grudging approval. It did not receive due recognition till 1808, when J. N. Corvisart translated the *Inventum novum* into French, and Auenbrugger's method rapidly attained a European reputation. Surpassed, but not eclipsed, by the still more important art of auscultation introduced by R. T. H. Laennec, it is hardly too much to say that this simple and purely mechanical invention has had more influence on the development of modern medicine than all the "systems" evolved by the most brilliant intellects of the 18th century.

Rise of the Positive School in France.—The reform of medicine in France must be dated from the great intellectual awakening caused by the Revolution, but more definitely starts with the researches in anatomy and physiology of Marie François Xavier Bichat (1771-1802). The importance in science of Bichat's classical works, especially of the *Anatomie générale*, cannot be estimated here; we can only point out their value as supplying a new basis for pathology or the science of disease. Among the most ardent of his followers was François Joseph Victor Broussais (1772-1838), whose theoretical views, partly founded on those of Brown and partly on the so-called vitalist school of Théophile Bordeu (1722-1776) and Paul Joseph Barthez (1734-1806), differed from these essentially in being avowedly based on anatomical observations. Broussais's chief aim was to find an anatomical basis for all diseases, but he is especially known for his attempt to explain all fevers as a consequence of irritation or inflammation of the intestinal canal (gastro-entérite). A number of other maladies, especially general diseases and those commonly regarded as nervous, were attributed to the same cause. It would be impossible now to trace

the steps which led to this wild and long since exploded theory. It led, among other consequences, to an enormous misuse of bleeding. Leeches were his favourite instruments, and so much so that he is said to have used 100,000 in his own hospital wards during one year. He was equalled if not surpassed in this excess by his follower Jean Bouillaud (1796-1881), known for his important work on heart diseases. Broussais's system, to which he gave the name of "Médecine physiologique," did much indirect good, in fixing attention upon morbid changes in the organs, and thus led to the rise of the strongly opposed anatomical and pathological school of Corvisart, Laennec and Bayle.

Jean Nicolas Corvisart (1755-1821) has already been mentioned as the translator and introducer into France of Auenbrugger's work on percussion. He introduced some improvements in the method, but the only real advance was the introduction of mediate percussion by Pierre Adolphe Piory (1794-1879) in 1828. The discovery had, however, yet to be completed by that of auscultation, or listening to sounds produced in the chest by breathing, the movements of the heart, &c. The combination of these methods conducted to what is now known as *physical diagnosis*. René Théophile Hyacinthe Laennec (1781-1826) was the inventor of this method for important perhaps of all methods of medical research. Except for some trifling notices of sounds heard in certain diseases, this method was entirely new. It was definitely expounded in an almost complete form in his work *De l'auscultation médiate*, published in 1819. Laennec attached undue importance to the use of the stethoscope, and laid too much weight on specific signs of specific diseases; otherwise his method in its main features has remained unchanged. The result of his discovery was an entire revolution in the knowledge of diseases of the chest; but it would be a mistake to forget that an essential factor in this revolution was the simultaneous study of the condition of the diseased organs as seen after death. Without the latter, it is difficult to see how the information conveyed by sounds could ever have been verified. This increase of knowledge is therefore due, not to auscultation alone, but to auscultation combined with morbid anatomy. In the case of Laennec himself this qualification takes nothing from his fame, for he studied so minutely the relations of post-mortem appearances to symptoms during life that, had he not discovered auscultation, his researches in morbid anatomy would have made him famous. The pathological anatomy of Laennec was also followed with great zeal and success by Gaspard Laurence Bayle (1774-1846), whose researches on tubercle, and the changes of the lungs and other organs in consumption, are the foundation of most that has been done since his time. It was of course antecedent to the discovery of auscultation. Starting from these men arose a school of physicians who endeavoured to give to the study of symptoms the same precision as belonged to anatomical observations, and by the combination of both methods made a new era in clinical medicine. Among these were Auguste François Chomel (1788-1858), Pierre Charles Alexandre Louis (1787-1872), Jean Cruveilhier (1791-1874) and Gabriel Andral (1797-1876). Louis, by his researches on pulmonary consumption and typhoid fever, had the chief merit of refuting the doctrines of Broussais. In another respect also he aided in establishing an exact science of medicine by the introduction of the numerical or statistical method. By this method only can the fallacies which are attendant on drawing conclusions from isolated cases be avoided; and thus the chief objection which has been made to regarding medicine as an inductive science has been removed. Louis's method was improved and systematized by Louis-Jean Denis Gavarré (1809-1890), and its utility is now universally recognized. During this brilliant period of French medicine the superiority of the school of Paris could hardly be contested. We can only mention the names of Pierre Bretonneau (1771-1862), Louis Léon Rostan (1790-1866), Jean Louis D'Alibert (1766-1837), Pierre François Olive Rayer (1793-1867) and Armand Trousseau (1801-1866), the eloquent and popular teacher.

English Medicine from 1800 to 1840.—The progress of medicine in England during this period displays the same characteristics as at other times, viz. a gradual and uninterrupted development, without startling changes such as are caused by the sudden rise or fall of a new school. Hardly any theoretical system is of English birth; Erasmus Darwin (1731-1802), the grandfather of the great Charles Darwin, alone makes an exception. In his *Zoonomia* (1794) he expounded a theory of life and disease which had some resemblance to that of Brown, though arrived at (he says) by a different chain of reasoning.

Darwin's work shows, however, the tendency to connect medicine with physical science, which was an immediate consequence of the scientific discoveries of the end of the 18th century, when Priestley and Cavendish in England exercised

the same influence as Lavoisier in France. The English school of medicine was also profoundly stirred by the teachings of the two brothers William and John Hunter, especially the latter—who must therefore be briefly mentioned, though their own researches were chiefly concerned with subjects lying a little outside the limits of this sketch. William Hunter (1718-1783) was known in London as a brilliant teacher of anatomy and successful obstetric physician; his younger brother and pupil, John Hunter (1728-1793), was also a teacher of anatomy, and practised as a surgeon. His immense contributions to anatomy and pathology cannot be estimated here, but his services in stimulating research and training investigators belong to the history of general medicine. They are sufficiently evidenced by the fact that Edward Jenner and Matthew Baillie were his pupils.

The same scientific bent is seen in the greater attention paid to morbid anatomy (which dates from Baillie) and the more scientific method of studying diseases. An instance of the latter is the work of Robert Willan (1757-1812) on diseases of the skin—a department of medicine in which abstract and hypothetical views had been especially injurious. Willan, by following the natural-history method of Sydenham, at once put the study on a sound basis; and his work has been the starting-point of the most important modern researches. About the same time William Charles Wells (1757-1817), a scientific investigator of remarkable power, and the author of a celebrated essay on dew, published observations on alterations in the urine, which, though little noticed at the time, were of great value as assisting in the important discovery made some years afterwards by Richard Bright.

These observers, and others who cannot be mentioned here, belong to the period when English medicine was still little influenced by the French school. Shortly after 1815, however, when the continent of Europe was again open to English travellers, many English doctors studied in Paris, and the discoveries of their great French contemporaries began to be known. The method of auscultation was soon introduced into England by pupils of Laennec. John Forbes (1787-1861) in 1824, and William Stokes (1804-1878) of Dublin in 1825, published treatises on the use of the stethoscope. Forbes also translated the works of Laennec and Auenbrugger, and an entire revolution was soon effected in the knowledge of diseases of the chest. James Hope (1801-1841) and Peter Mere Latham (1789-1875) further developed this subject, and the former was also known for his researches in morbid anatomy. The combination of clinical and anatomical research led, as in the hands of the great French physicians, to important discoveries by English investigators. The discovery by Richard Bright (1789-1858) of the disease of the kidneys known by his name proved to be one of the most momentous of the century. It was published in *Reports of Medical Cases 1827-1831*. Thomas Addison (1793-1860) takes, somewhat later, a scarcely inferior place. The remarkable physiological discoveries of Sir Charles Bell (1774-1842) and Marshall Hall (1790-1857) for the first time rendered possible the discrimination of diseases of the spinal cord. Several of these physicians were also eminent for their clinical teaching—an art in which Englishmen had up till then been greatly deficient.

Although many names of scarcely less note might be mentioned among the London physicians of the early part of the century, we must pass them over to consider the progress of medicine in Scotland and Ireland. In Edinburgh the admirable teaching of Cullen had raised the medical faculty to a height of prosperity of which his successor, James Gregory (1758-1821), was not unworthy. His nephew, William Pulteney Alison (1790-1859), was even more widely known. These great teachers maintained in the northern university a continuous tradition of successful teaching, which the difference in academical and other circumstances rendered hardly possible in London. Nor was the northern school wanting in special investigators, such as John Abercrombie (1780-1844), known for his work on diseases of the brain and spinal cord, published in 1828, and many others. Turning to Ireland, it should be said that the Dublin school in this period produced two physicians of the highest distinction. Robert James Graves (1796-1853) was a most eminent clinical teacher and observer, whose lectures are regarded as the

model of clinical teaching, and indeed served as such to the most popular teacher of the Paris school in the middle of this century. Trousseau. William Stokes (1804-1878) was especially known for his works on diseases of the chest and of the heart, and for his clinical teaching.

German Medicine from 1800 to 1840.—Of the other countries of Europe, it is now only necessary to mention Germany. Here the chief home of positive medicine was still for a long time Vienna, where the "new Vienna school" continued and surpassed the glory of the old. Joseph Skoda (1805-1881) extended, and in some respects corrected, the art of auscultation as left by Laennec. Karl Rokitansky (1804-1878), by his colossal labours, placed the science of morbid anatomy on a permanent basis, and enriched it by numerous discoveries of detail. Most of the ardent cultivators of this science in Germany in the next generation were his pupils. In the other German schools, though some great names might be found, as Moritz Heinrich Romberg (1795-1873), the founder of the modern era in the study of nervous diseases, the general spirit was scholastic and the result barren till the teaching of one man, whom the modern German physicians generally regard as the regenerator of scientific medicine in their country, made itself felt. Johann Lucas Schönlein (1793-1864) was first professor at Würzburg, afterwards at Zürich, and for twenty years at Berlin (from 1839-1859). Schönlein's positive contributions to medical science were not large; but he made in 1839 one discovery, apparently small, but in reality most suggestive, namely, that the contagious disease of the head called favus is produced by the growth in the hair of a parasitic fungus. In this may be found the germ of the startling modern discoveries in parasitic diseases. His systematic doctrines founded the so-called "natural history school"; but his real merit was that of the founder or introducer of a method. In the words of H. Häser: "Schönlein has the incontestable merit of having been the first to establish in Germany the exact method of the French and the English, and to impregnate this method with the vivifying spirit of German research." (J. F. P.)

Modern Progress.—In recent times the positive bent of modern knowledge and methods in other spheres of science and thought, and especially in biology, has influenced medicine profoundly. Minuter accuracy of observation was inculcated by the labours and teaching of the great anatomists of the 17th century; and, for modern times, experimental physiology was instituted by Harvey, anatomy having done little to interpret life in its dynamic aspects. For medicine in England Harvey did what William Gilbert did for physics and Robert Boyle for chemistry; he insisted upon direct interrogation of natural processes, and thereby annihilated the ascendancy of mere authority, which, while nations were in the making, was an essential principle in the welding together of heterogeneous and turbulent peoples. The degradation of medicine between Galen and Harvey, if in part it consisted in the blind following of the authority of the former physician, was primarily due to other causes; and its new development was not due to the discovery of the experimental method alone: social and political causes also are concerned in the advance even of the exact sciences. Among such contributory causes is the more familiar intercourse of settled nations which we enjoy in our own day; the ideas of one nation rapidly permeate neighbouring nations, and by the means of printed books penetrate into remoter provinces and into distant lands. Hence the description of the advance of medicine in western Europe and America may for the latest stage be taken as a whole, without that separate treatment, nation by nation, which in the history of earlier times was necessary. Italy lost the leading place she had taken in the new development of science. The several influences of modern Germany, France and America became of the first importance to English medicine; but these tides, instead of pursuing their courses as independent streams, have become confluent. The work of Theodor Schwann (1810-1882), Johannes Müller (1809-1875), Rudolph Virchow and Karl Ludwig (1816-1895) in Germany, of R. T. H. Laennec and Claude Bernard in France, was accepted in England, as that of Matthew Baillie, Charles

Bell, Bright, Graves and others of the British school, quickly made itself felt abroad.

The character of modern medicine cannot be summed in a word, as, with more or less aptness, that of some previous periods may be. Modern medicine, like modern science, is as boldly speculative as it has been in any age, and yet it is as observant as in any naturalistic period; its success lies in the addition to these qualities of the method of verification; the fault of previous times being not the activity of the speculative faculty, without which no science can be fertile, but the lack of methodical reference of all and sundry propositions, and parts of propositions, to the test of experiment. In no department is the experimental method more continually justified than in that of the natural history of disease, which at first sight would seem to have a certain independence of it and a somewhat exclusive value of its own. Hippocrates had no opportunity of verification by necropsy, and Sydenham ignored pathology; yet the clinical features of many but recently described diseases, such, for example, as that named after Graves, and myxoedema, both associated with perversions of the thyroid gland, lay as open to the eye of physicians in the past as to our own. Again, to the naturalist the symptoms of *tabes dorsalis* were distinctive enough, had he noted them. No aid to the trained eye was necessary for such observations, and for many other such; yet, if we take Sir Thomas Watson (1792-1882) as a modern Sydenham, we may find in his lectures no suspicion that there may be a palsy of muscular co-ordination apart from deprivation of strength. Indeed, it does not seem to have occurred to any one to compare the muscular strength in the various kinds of paraplegia. Thus it was, partly because the habit of acceptance of authority, waning but far from extirpated, dictated to the clinical observer what he should see; partly because the eye of the clinical observer lacked that special training which the habit and influence of experimental verification alone can give, that physicians, even acute and practised physicians, failed to see many and many a symptomatic series which went through its evolutions conspicuously enough, and needed for its appreciation no unknown aids or methods of research, nor any further advances of pathology. We see now that the practice of the experimental method endows with a new vision both the experimenter himself and, through his influence, those who are associated with him in medical science, even if these be not themselves actually engaged in experiment; a new discipline is imposed upon old faculties, as is seen as well in other sciences as in those on which medicine more directly depends. And it is not only the perceptions of eye or ear which tell, but also the association of concepts behind these aids of the mind. It was the concepts derived from the experimental methods of Harvey, Lavoisier, Liebig, Claude Bernard, Helmholtz, Darwin, Pasteur, Lister and others which, directly or indirectly, trained the eyes of clinicians to observe more closely and accurately; and not of clinicians only, but also of pathologists, such as Matthew Baillie, Cruveilhier, Rokitansky, Bright, Virchow—to name but a few of those who, with (as must be admitted) new facilities for necropsies, began to pile upon us discoveries in morbid anatomy and histology. If at first in the 18th century, and in the earlier 19th, the discoveries in this branch of medical knowledge had a certain isolation, due perhaps to the prepossessions of the school of Sydenham, they soon became the property of the physician, and were brought into co-ordination with the clinical phenomena of disease. The great Morgagni, the founder of morbid anatomy, himself set the example of carrying on this study parallel with clinical observation; and always insisted that the clinical story of the case should be brought side by side with the revelations of the necropsy. In pathology, indeed, Virchow's (1821-1902) influence in the transfiguration of this branch of science may almost be compared to that of Darwin and Pasteur in their respective domains. In the last quarter of the 19th century the conception grew clearer that morbid anatomy for the most part demonstrates

*Experimental
Method
recognized.*

disease in its static aspects only, and also for the most part in the particular aspect of final demolition; and it became manifest as pathology and clinical medicine became more and more thoroughly integrated, that the processes which initiate and are concerned in this dissolution were not revealed by the scalpel.

Again, the physician as naturalist, though stimulated by the pathologist to delineate disease in its fuller manifestations, yet was hampered in a measure by the didactic method of constructing "types" which should command the attention of the disciple and rivet themselves on his memory; thus too often those incipient and transitory phases which initiate the paths of dissolution were missed. Not only so, but the physician, thus fascinated by "types," and impressed by the silent monuments of the pathological museum, was led to localize disease too much, to isolate the acts of nature, and to forget not only the continuity of the phases which lead up to the exemplary forms, or link them together, but to forget also that even between the types themselves relations of affinity must exist—and these oftentimes none the less intimate for apparent diversities of form, for types of widely different form may be, and indeed often are, more closely allied than types which have more superficial resemblance—and to forget, moreover, how largely negative is the process of abstraction, by which types are imagined. Upon this too static a view, both of clinical type and of post-mortem-room pathology, came a despairing spirit, almost of fatalism, which in the contemplation of organic ruins lost the hope of cure of organic diseases. So prognosis became pessimistic, and the therapeutics of the abler men negative, until fresh hopes arose of stemming the tides of evil at their earliest flow.

Such was medicine, statically ordered in pathology, statically ordered in its clinical concepts, when, on the 24th of November 1859, the *Origin of Species* was published. It is no exaggeration to say that this epoch-making work brought to birth a world of conceptions as new as the work of Copernicus. For the natural philosopher the whole point of view of things was changed; in biology not only had the anthropocentric point of view been banished, but the ancient concept of perpetual flux was brought home to ordinary men, and entered for good into the framework of thought. The study of comparative pathology, yet in an inchoate stage, and of embryology, illuminated and enlarged biological conceptions, both normal and abnormal; and the *ens reale subsistens in corpore* disappeared forever—at any rate from physiology and medicine. Before Darwin—if the name of Darwin may be used to signify the transformation of thought of which he was the chief artificer—natural objects were regarded, not in medicine and pathology only, as a set of hidebound events; and natural operations as moving in fixed grooves, after a fashion which it is now difficult for us to realize. With the melting of the ice the more daring spirits dashed into the new current with such ardour that for them all traditions, all institutions, were thrown into hotchpot; even elderly and sober physicians took enough of the infection to liberate their minds, and in the field of the several diseases and in that of post-mortem pathology, the hollowness of classification by superficial resemblance, the transitoriness of forms, and the flow of processes, broke upon the view. Thus it came about not only that classifications of disease based on superficial likeness—such as jaundice, dropsy, inflammation—were broken up, and their parts redistributed, but also that even more set diseases began to lose their settlements, and were recognized as terms of series, as transitory or culminating phases of perturbations which might be traced to their origins, and in their earlier stages perhaps withstood.

The doctrine of heredity in disease thus took a larger aspect; the view of morbid series was no longer bounded even by the life of the individual; and the propagation of taints, and of morbid varieties of man, from generation to generation proved to be no mere repetition of fixed features but, even more frequently, to be modes of development or of dissolution betraying themselves often in widely dissimilar forms, in series often extending

over many lives, the terms of which at first sight had seemed wholly disparate. Thus, for example, as generations succeed one another, nervous disorders appear in various guise; epilepsy, megrim, insanity, asthma, hysteria, neurasthenia, a motley array at first sight, seemed to reveal themselves as terms of a morbid series; not only so, but certain disorders of other systems also might be members of the series, such as certain diseases of the skin, and even peculiar susceptibilities or immunities in respect of infections from without. On the other hand, not a few disorders proved to be alien to classes to which narrower views of causation had referred them; of such are tabes dorsalis, neuritis, infantile palsy or tetanus, now removed from the category of primary nervous diseases and placed in one or other of the class of infections; or, conversely, certain forms of disease of the joints are now regarded with some certainty as members of more than one series of diseases chiefly manifest in the nervous system. In the effects of simpler poisons the recognition of unity in diversity, as in the affiliation of a peripheral neuritis to arsenic, illustrated more definitely this serial or etiological method of classifying diseases. On the other hand, inheritance was dismissed, or survived only as a "susceptibility," in the cases of tubercle, leprosy and some other maladies now recognized as infectious; while in others, as in syphilis, it was seen to consist in a translation of the infectious element from parent to offspring. These new conceptions of the multiplicity in unity of disease, and of the fluidity and continuity of morbid processes, might have led to vagueness and over-boldness in speculation and reconstruction, had not the experimental method been at hand with clues and tests for the several series. Of this method the rise and wonderful extension of the science of bacteriology also furnished no inconsiderable part.

In the disease of the scalp called favus, Schönlein had discovered a minute mycelial fungus; a remarkable discovery, for it was the first conspicuous step in the attribution of diseases to the action of minute parasites. Schönlein thus did something to introduce new and positive conceptions and exacter methods into Germany; but unfortunately his own mind retained the abstract habit of his country, and his abilities were dissipated in the mere speculations of Schelling. Similarly Karl Hoffmann of Würzburg wasted his appreciations of the newer schools of developmental biology in fanciful notions of human diseases as reversions to normal stages of lower animals; scrofula being for him a reversion to the insect, rickets to the mollusc, epilepsy to the oscillaria, and so forth. Even that distinguished physiologist Johannes Müller remained a staunch vitalist. Fortunately Germany, which at the beginning of the century was delivered over to Brownism and vitalism and was deaf to Bichat, was rescued from this sort of barrenness by the brilliant experimental work of Claude Bernard and Pasteur in France—work which, as regards the attenuated virus, was a development of that of Edward Jenner, and indeed of Schwann, Robert Koch worthily following Pasteur with his work on the bacillus of anthrax and with his discovery of that of tuberculosis; and by the cellular doctrine and abundant labours in pathology of Virchow. Ludwig Brieger then discovered the toxins of certain infections; and Emil A. von Behring completed the sphere of the new study by his discovery of the antitoxins of diphtheria and tetanus. In practical medicine the subsequent results of Behring and his followers have in diphtheria attained a signal therapeutical success. If the striking conceptions of Paul Ehrlich and Emil Fischer continue to prove as fertile in inspiring and directing research as at present they seem to be, another wide sphere of conceptions will be opened out, not in bacteriology only, but also in biological chemistry and in molecular physics. Again, besides giving us the clue to the nature of many diseases and to the continuity of many morbid series, by bacteriology certain diseases, such as actinomycosis, have been recognized for the first time.

As the prevalence of the conceptions signified and inspired by the word "phlogiston" kept alive ontological notions of disease, so the dissipation of vitalistic conceptions in the field of physics prepared men's minds in pathology for the new

Influence of Darwin. 1859, the *Origin of Species* was published. It is no exaggeration to say that this epoch-making work brought to birth a world of conceptions as new as the work of Copernicus.

Bacteriology.

views opened by the discoveries of Pasteur on the side of pathogeny, and of J. F. Cohnheim (1830-1884) and of

Iliya Metchnikoff on the dynamical side of histology. Of the older ontological notions of disease the strongest were those of the essence of fever and of the essence of inflammation. Broussais had done much to destroy the notion of fever as an entity, but by extravagances in other directions he had discredited the value of his main propositions. Yet, although, as Andral and other French physicians proved, it was extravagant to say that all fevers take their origin from some local inflammation, it was true and most useful to insist, as Broussais vehemently insisted, that "fever" is no substance, but a generalization drawn from symptoms common to many and various diseases springing from many various and often local causes; from causes agreeing perhaps only in the factor of elevation of the temperature of the body. To the establishment of this new conception the improvement and general use of the *clinical thermometer* gave invaluable advantages. This instrument, now indispensable in our daily work at the bedside, had indeed long been known both to physiologists (Haller) and to clinicians. In the 18th century A. de Haën, and, in the United Kingdom, George Cleghorn (1716-1786) of Dublin and James Currie (1756-1805), carried on the use of the thermometer in fevers; and on the continent of Europe in later years F. G. F. von Bärensprung (1822-1865) and Ludwig Traube (1818-1876) did the same service; but it is to the work of Karl August Wunderlich (1815-1877) that we owe the establishment of this means of precision as a method of regular observation both in pathology and in clinical medicine. By his almost exhaustive comparison of febrile movements as symptomatic processes Wunderlich dealt the last blow to the expiring doctrine of the "entity" of "fever"; while on the clinical side Bretonneau and Louis, in 1862-1872, by their careful clinical and pathological studies of forms of fever, relieved the new doctrine of the extravagances of Broussais, and prepared the way for the important distinction of enteric from typhus fever by A. P. Stewart (1813-1883), William Jenner, William Budd (1811-1880), Charles Murchison (1830-1870), J. H. F. Autenrieth (1772-1835), Heinrich Gustav Magnus (1802-1870), Huss and others. By the learned and accomplished Armand Trousseau British and German influences were carried into France.

Meanwhile Cohnheim and Metchnikoff were engaged in destroying the ontological conception not of fever only, but also of inflammation, of which, as a local event, an ontological conception was no less strongly implanted. By his researches on the migration of the white corpuscles of the blood Cohnheim, on the bases laid by Virchow, brought the processes of inflammation within the scope of the normal, seeing in them but a modification of normal processes under perturbations of relatively external incidence; even the formation of abscess was thus brought by him within the limits of perversion of processes not differing essentially from those of health; and "new formations," "plastic exudations," and other discontinuous origins of an "essential" pathology, fell into oblivion. And it is not alien from the present point of view to turn for a moment to the light thrown on the cardio-arterial pulse and the measurement of its motions by the more intimate researches into the phenomena of the circulation by many observers, among whom in the 19th century James Hope, E. J. Marey (1830-1904) and C. F. W. Ludwig will always take a leading place. By them the demonstration of Harvey that the circulation of the blood is in large part a mechanical process, and nowhere independent of mechanical laws, was considerably enlarged and extended. In particular the fluctuations of the pulse in fevers and inflammations were better understood, and accurately registered; and we can scarcely realize now that before Harvey the time of the pulse seems not to have been counted by the watch. Discovery in these various directions then led physicians to regard fever and inflammation not as separable entities, but as fluctuating symptom-groups, due to swerings of function from the normal balance under contingent forces.

As to such reforms in our conceptions of disease the advances of bacteriology profoundly contributed, so under the stress of consequent discoveries, almost prodigious in their extent and revolutionary effect, the conceptions of the etiology of disease underwent no less a transformation than the conceptions of disease itself. It is

New Conceptions of Etiology.

proper to point out here how intimately a pathology thus regenerated modified current conceptions of disease, in the linking of disease to oscillations of health, and the regarding many diseases as modifications of the normal set up by the impingement of external causes; not a few of which indeed may be generated within the body itself—"autogenetic poisoning." The appreciation of such modifications, and of the working of such causes, has been facilitated greatly by the light thrown upon normal processes by advances in physiology; so dependent is each branch of knowledge upon the advances of contiguous and incident studies. To biological chemistry we have been deeply indebted during the latter half of the 19th century. In 1872, Hoppe-Seyler (1825-1895) gave a new beginning to our knowledge of the chemistry of secretion and of excretion; and later students have increased the range of physiological and pathological chemistry by investigations not only into the several stages of albuminoid material and the transitions which all food-stuffs undergo in digestion, but even into the structure of protoplasm itself. Digestion, regarded not long ago as little more than a trituration and "coction" of ingesta to fit them for absorption and transfer them to the tissues, now appears as an elaboration of peptones and kindred intermediate products which, so far from being always bland, and mere bricks and mortar for repair or fuel for combustion, pass through phases of change during which they become so unfit for assimilation as to be positively poisonous. The formation of prussic acid at a certain period of the vital processes of certain plants may be given as an example of such phases; and poisons akin to muscarin seem to arise frequently in development or regression, both in animals and plants. Thus the digestive function, in its largest sense, is now seen to consist, not only in preparation and supply, but in no small measure also of protective and antidotal conversions of the matters submitted to it; coincidentally with agents of digestion proper are found in the circuit of normal digestion "anti-substances" which neutralize or convert peptones in their poisonous phases; an autochthonous ferment, such as rennet for instance, calling forth an anti-rennet, and so on. Now as our own bodies thus manipulate substances poisonous and antidotal, if in every hour of health we are averting self-intoxication, so likewise are we concerned with the various intruding organisms, whose processes of digestion are as dangerous as our own; if these destructive agents, which no doubt are incessantly gaining admission to our bodies, do not meet within us each its appropriate compensatory defensive agent, dissolution will begin. Thus, much of infection and immunity are proving to be but special cases of digestion, and teleological conceptions of protective processes are modified.

Under the name of chemotaxis (W. Pfeffer) are designated certain of the regulative adaptations by which such ends are attained. By chemical warnings the defensive processes seem to be awakened, or summoned; and when we think of the infinite variety of such possible phases, and of the multitude of corresponding defensive agents, we may form some dim notion of the complexity of the animal blood and tissues, and within them of the organic molecules. Even in normal circumstances their play and counterplay, attractive and repellent, must be manifold almost beyond conception; for the body may be regarded as a collective organization consisting of a huge colony of micro-organisms become capable of a common life by common and mutual arrangement and differentiation of function, and by toleration and utilization of each other's peculiar products; some organs, such as the liver, for example, being credited with a special power of neutralizing poisons, whether generated under normal conditions or under abnormal, which gain entrance from the intestinal tract. As a part of these discoveries has arisen another but kindred doctrine

Natural Resistance.

that of hormones (Starling), juices prepared, not for excretion, not even for partial excretion, but for the fulfilment of physiological equilibrium. Thus the reciprocity of the various organs, maintained throughout the divisions of physiological labour, is not merely a mechanical stability; it is also a mutual equilibrium in functions incessantly at work on chemical levels, and on those levels of still higher complexity which seem to rise as far beyond chemistry as chemistry beyond physics. Not only are the secreted juices of specialized cells thus set one against another in the body, whereby the various organs of the body maintain a mutual play, but the blood itself also in its cellular and fluid parts contains elements potent in the destruction of bacteria and of their secretions. Thus endowed, the blood, unless overwhelmed by extraordinary invasions, does not fail in stability and self-purification. So various are the conditions of self-regulation in various animals, both in respect of their peculiar and several modes of assimilating different foods, and of protecting themselves against particular dangers from without, that, as we might have expected, the bloods taken from different species, or even perhaps from different individuals, are found to be so divergent that the healthy serum of one species may be, and often is, poisonous to another; not so much in respect of adventitious substances, as because the phases of physiological change in different species do not harmonize; each by its peculiar needs has been modified until, in their several conditions of life, they vary so much about the mean as to have become almost if not quite alien one to another.

In the preservation of immunity then, in its various degrees and kinds, not only is the chemistry of the blood to be studied, but also its histology. By his eminent labours in cellular pathology, Virchow, and Metchnikoff later, gave the last blow to the mere humoral pathology which, after an almost unchallenged prevalence for some two thousand years, now finds a resting-place only in our nurseries. Now the cellular pathology of the blood, investigated by the aid of modern staining methods, is as important as that of the solid organs; no clinical investigator—indeed, apart from research, no practitioner at this day—can dispense with examination of the blood for purposes of diagnosis; its coagulability and the kinds and the variations of the cells it contains being evidence of many definitely morbid states of the body. Again, not only in certain diseases may strange cells be found in the blood (e.g. in myelogenous leucæmia), but parasites also, both in man, as those of malaria, of sleeping sickness, of kala-azar, and in animals, as redwater, yellow fever, n'gana have been discovered, to the great advantage of preventive medicine. For some of these, as redwater (pyrosoma), antidotes are already found; for others, as for yellow fever—of which the parasite is unknown, but the mode of its transmission, by the mosquito, discovered (Finlay-Reed)—preventive measures are reducing the prevalence.

It is obvious that the results of such advances prescribe for the clinical physician methods which cannot be pursued without expert assistance; a physician engaged in busy practice cannot himself undertake even the verifications required in the conduct of individual cases. Skill in modern laboratory work is as far out of the reach of the untaught as performance on a musical instrument. In spite, therefore, of the encyclopædic tradition which has persisted from Aristotle through the Arab and mediæval schools down to Herbert Spencer, it is forced upon us in our own day that in a pursuit so manifold as medicine, whether in its scientific or in its practical aspect, we have to submit more and more to that division of labour which has been a condition of advance in all other walks of life. It is now fully recognized that diseases of infants and children, of the insane, of the generative organs of women, of the larynx, of the eye, have been brought successively into the light of modern knowledge by "specialists," and by them distributed to the profession; and that in no other way could this end have been attained. That the division of labour, which may seem to disintegrate the calling of the physician, really unites it, is well seen in the clinical laboratories which were initiated in the later 19th century, and which are destined to a great

future. By the approach of skilled pathologists to the clinical wards, a link is forged between practitioners and the men of science who pursue pathology disinterestedly. The first clinical laboratory seems to have been that of Von Ziemssen (1829-1902) at Munich, founded in 1885; and, although his example has not yet been followed as it ought to have been, enough has been done in this way, at Johns Hopkins University and elsewhere, to prove the vital importance of the system to the progress of modern medicine. At the same time provision must be made for the integration of knowledge as well as for the winning of it by several adits. A conspicuous example of the incalculable evil wrought by lack of integration is well seen in the radical divorce of surgery from medicine, which is one of the most mischievous legacies of the middle ages—one whose mischief is scarcely yet fully recognized, and yet which is so deeply rooted in our institutions, in the United Kingdom at any rate, as to be hard to obliterate. That the methods and the subject-matter of surgery and of medicine are substantially the same, and that the advance of one is the advance of the other, the division being purely artificial and founded merely on accidents of personal bent and skill, must be insisted upon at this time of our history. The distinction was never a scientific one, even in the sense in which the word science can be used of the middle ages; it originated in social conceits and in the contempt for mechanical arts which came of the cultivation of "ideas" as opposed to converse with "matter," and which, in the dawn of modern methods, led to the derision of Boyle by Oxford humanists as one given up to "base and mechanical pursuits." Had physicians been brought into contact with facts as hard as those faced by the surgeons of the 16th century (cf. Ambrose Paré), their art would not have lain so long in degradation. It is under this closer occupation with mechanical conditions that surgery to-day is said—not without excuse, but with no more than superficial truth—to have made more progress than medicine. Medicine and surgery are but two aspects of one art; Pasteur shed light on both surgery and medicine, and when Lister, his disciple, penetrated into the secrets of wound fevers and septicæmia, he illuminated surgery and medicine alike, and, in the one sphere as in the other, co-operated in the destruction of the idea of "essential fevers" and of inflammation as an "entity." Together, then, with the necessary multiplication of specialism, one of the chief lessons of the latter moiety of the 19th century was the unity of medicine in all its branches—a unity strengthened rather than weakened by special researches, such as those into "medical" and "surgical" pathology, which are daily making more manifest the absurdity of the distinction. Surgeons, physicians, oculists, laryngologists, gynaecologists, neurologists and the rest, all are working in allotments of the same field, and combining to a common harvest.

While pathology then, which is especially the "science of medicine," was winning territory on one side from physiology, of which in a sense it is but an aspect, and on another by making ground of its own in the post mortem room and museum of morbid anatomy, and was fusing these gains in the laboratory so as to claim for itself, as a special branch of science by virtue of peculiar concepts, its due place and provision—provision in the establishment of chairs and of special laboratories for its chemical and biological subdivisions—clinical medicine, by the formal provision of disciplinary classes, was illustrating the truth of the experience that teaching and research must go hand-in-hand, the one reinforcing the other: that no teacher can be efficient unless he be engaged in research also; nay, that for the most part even the investigator needs the encouragement of disciples. Yet it was scarcely until the last quarter of the 19th century that the apprenticeship system, which was a mere initiation into the art and mystery of a craft, was recognized as antiquated and, in its virtual exclusion of academic study, even mischievous. In place of it, systematic clinical classes have become part of the scheme of every efficient school of medicine. A condition of this reform was the need of a preliminary training of the mind of the pupil in pure science, even in physics and chemistry; that is to say, before introduction

Medical
Training.

into his professional studies. The founding of new teaching universities, in which England, and even France, had been at some disadvantage as compared with Scotland and Germany, strengthened the movement in favour of enlarging and liberalizing technical training, and of anticipating technical instruction by some broader scientific discipline; though, as in all times of transition, something was lost temporarily by a departure from the old discipline of the grammar school before a new scheme of training the mind in scientific habits and conceptions was established or fully apprehended. Yet on the whole, even from the beginning, the revolt was useful in that it shook the position of the "learned physician," who took a literary, fastidious and meditative rather than an experimental interest in his profession, and, as in great part a descendant of the humanists, was never in full sympathy with experimental science. At the risk no doubt of some defects of culture, the newer education cleared the way for a more positive temper, awoke a new sense of accuracy and of verification, and created a sceptical attitude towards all conventions, whether of argument or of practice. Among the drawbacks of this temper, which on the whole made for progress, was the rise of a school of excessive scepticism, which, forgetting the value of the accumulated stores of empiricism, despised those degrees of moral certainty that, in so complex a study and so tentative a practice as medicine, must be our portion for the present, and even for a long future, however great the triumphs of medicine may become. This scepticism took form in the school, most active between 1860 and 1880, known as the school of "Expectant Medicine." These teachers, genuinely touched with a sense of the scantiness of our knowledge, of our confidence in abstract terms, of the insecurity of our alleged "facts," case-histories and observations, alienated from traditional dogmatism and disgusted by meddlesome polypharmacy—enlightened, moreover, by the issue of cases treated by means such as the homoeopathic, which were practically "expectant"—urged that the only course open to the physician, duly conscious of his own ignorance and of the mystery of nature, is to put his patient under diet and nursing, and, relying on the tendency of all equilibriums to recover themselves under perturbation, to await events (*Vis medicatrix nature*). Those physicians who had occupied themselves in the study of the exacter sciences, or more closely or more exclusively of the wreckage of the post mortem room, were the strongest men of this school, whether in England or abroad.

But to sit down helpless before human suffering is an unendurable attitude. Moreover, the insight into origins, into initial morbid processes revealed by the pathologists, **Therapeutics.** awoke more and more the hope of dealing with the elements of disease, with its first beginnings; and in the field of therapeutics, chemical and biological experiment, as in the case of digitalis, mercury and the iodides, was rapidly simplifying remedies and defining their virtues, so that these agents could be used at the bedside with more precision. Furthermore, the aversion from drugging had the advantage of directing men's minds to remedies taken from the region of the physical forces, of electricity (G. B. Duchenne, 1806-1875), of gymnastics (Ling, 1776-1839), of hydropathy (V. Priessnitz), of massage (Weir Mitchell), of climate (James Clarke), of diet (R. B. Todd, King Chambers, &c.), and even of hypnotism (James Braid 1795?-1860), while with the improvement of the means of locomotion came the renewal of the old faith and the establishment of new methods in the use of mineral springs. These and such means, often in combination, took much of the place formerly given to the use of drugs.

Again, a like spirit dictated the use of the physical or "natural" methods on a larger scale in the field of prevention.

Hygiene. From the new regard given by physiologists and pathologists to the study of origins, and in the new hopes of thus dealing with disease at its springs, not in individuals only but in cities and nations, issued the great school of Preventive Medicine, initiated in England—E. A. Parkes (1819-1876), J. Simon, Sir B. W. Richardson (1828-1896), Sir H. W. Acland (1815-1900), Sir G. Buchanan (1831-1895), and

forwarded in Germany by Max von Pettenkofer (1818-1901). Hygiene became for pathology what "milieu" is for physiology. By the modification of physical conditions on a national scale a prodigious advance was made in the art of preventing disease. The ghastly roll of infantile mortality was quickly purged of its darkest features (Ballard and others); aided by bacteriology, sanitary measures attained some considerable degree of exactness; public medicine gained such an ascendancy that special training and diplomas were offered at universities; and in 1875 a consolidated act was passed for the United Kingdom establishing medical officers of health, and responsible lay sanitary authorities, with no inconsiderable powers of enforcing the means of public health in rural, urban, port and other jurisdictions, with summary methods of procedure. A department of public health was formed within the precincts of the Local Government Board; government laboratories were established, and machinery was devised for the notification of infectious diseases. The enormous growth of towns during the second half of the 19th century was thus attended with comparative safety to these great aggregates of mankind; and the death-rates, so far from being increased, relatively decreased in substantial proportions. In 1878 an act was passed giving like powers in the case of the infectious diseases of animals. The establishment in England of the Register of qualified practitioners and of the General Medical Council (in 1858) did something, however imperfectly, to give unity to the profession, unhappily bisected by "the two colleges," and did much to organize, to strengthen and to purify medical education and qualification. In 1876 women were admitted to the Register kept by the Council. In 1871 the Anatomical Act of 1832 was amended; and in 1876 the Vivisection Act was passed, a measure which investigators engaged in the medical sciences of physiology and pathology resented as likely to prevent in England the advance of knowledge of living function, both in its normal balance and in its aberrancies, and moreover to slacken that habit of incessant reference of propositions to verification which is as necessary to the clinical observer as to the experimentalist. However the opinion of later generations may stand in respect of the Vivisection Act, it will surely appear to them that the other acts, largely based upon the results of experimental methods, strengthening and consolidating the medical profession, and fortifying the advance of medical education, led directly to a fundamental change in the circumstances of the people in respect of health. The intelligent classes have become far better educated in the laws of health, and less disposed to quackery; the less intelligent are better cared for and protected by municipal and central authority. Thus the housing of the poor has been improved, though this difficult problem is yet far from solution; not the large towns only, but the larger villages also, are cleansed and drained; food has been submitted to inspection by skilled officers; water supplies have been undertaken on a vast scale; personal cleanliness has been encouraged, and with wonderful success efforts have been made to bring civilized Europe back from the effects of a long wave of Oriental asceticism, which in its neglect and contempt of the body led men to regard filth even as a virtue, to its pristine cleanliness under the Greeks and Romans. During the latter half of the 19th century the death-rate of many towns was reduced by something like 50%. Some plagues, such as typhus fever, have been dispelled; others, such as enteric fever, have been almost banished from large areas; and there is much reason to hope that cholera and plague, if introduced, could not get a footing in western Europe, or in any case could be combated on scientific principles, and greatly reduced. Temperance in the use of alcohol has followed the demonstration not only of its unimportance as a food or tonic, but also of its harmfulness, save in very small quantities. In the earlier part of the 19th century, and in remoter districts even in its later years, the use of alcohol was regarded not as a mere indulgence, but as essential to health; the example of teetotalers, as seen in private life and in the returns of the insurance offices, has undermined this prepossession. From the time of Plato medicine has been accused of ministering to the survival of unfit persons, and to

their propagation of children. But bodily defect is largely a result of evil circumstances, in the prevention of which the physician is not unsuccessfully engaged, and the growth of sympathy means a stronger cement of the social structure. At any rate the mean standard of health will be raised, perhaps enormously.

In the tropics, as well as in Europe, such methods and such researches threw new light upon the causes and paths of the terrible infections of these climates. In 1880, two years before Koch discovered the bacillus of tubercle, C. L. A. Laveran (b. 1845) discovered the parasite of malaria, and truly conceived its relations to the disease; thus within two years were made two discoveries either of which was sufficient to make the honour of a century. Before the end of the 19th century this discovery of the blood parasite of malaria was crowned by the hypothesis of Patrick Manson, proved by Ronald Ross, that malaria is propagated by a certain genus of gnat, which acts as an intermediate host of the parasite. Cholera (Hafikine) and yellow fever are yielding up their secrets, and falling under some control. The 20th century, by means of this illumination of one of the darkest regions of disease, may diminish human suffering enormously, and may make habitable rich and beautiful regions of the earth's surface now, so far as man's work is concerned, condemned to sterility. Moreover, freedom of trade and of travel has been promoted by a reform of the antiquated, cumbersome, and too often futile methods of quarantine—a reform as yet very far from complete, but founded upon a better understanding of the nature and propagation of disease.

Special Departments.—Hitherto we have presented a survey of the progress of the science and practice of medicine on general lines; it remains to give some indication of the advance of these subjects of study and practice in particular departments. As regards infections, it is not to be supposed that our knowledge of these maladies has been advanced by pathology and bacteriology only. In the clinical field also it has received a great enlargement. Diphtheria, long no doubt a plague among mankind, was not carefully described until by Pierre Bretonneau in 1826; and since his time our conception of this disease has been extended by the study of later, secondary and incidental phases of it, such as neuritis, which had always formed part of the diphtheritic series, though the connexion had not been detected. Influenza, again, was well known to us in 1836-1840, yet clinical observers had not traced out those sequels which, in the form of neuritis and mental disorder, have impressed upon our minds the persistent virulence of this infection, and the manifold forms of its activity. By the discovery of the bacillus of tubercle, the physician has been enabled to piece together a long and varied list of maladies under several names, such as scrofula and lupus, many of them long suspected to be tuberculous, but now known to belong to the series. It is on clinical grounds that beriberi, scarlet fever, measles, &c., are recognized as belonging to the same class, and evolving in phases which differ not in intimate nature but in the more superficial and inessential characters of time, rate and polymorphism; and the impression is gaining strength that acute rheumatism belongs to the group of the infections, certain sore throats, chorea and other apparently distinct maladies being terms of this series. Thus the field of disease arising not from essential defect in the body, but from external contingencies, is vastly enlarging; while on the other hand the great variability of individuals in susceptibility explains the very variable results of such extrinsic causes. Coincidentally therewith, the hope of neutralizing infections by fortifying individual immunity has grown brighter, for it appears that immunity is not a very radical character, but one which, as in the case of vaccination, admits of modification and accurate adjustment in the individual, in no long time and by no very tedious methods. Evidence is accumulating which may end in the explanation and perhaps in the prevention of the direst of human woes—cancer itself, though at present inquiry is being directed rather to intrinsic than to extrinsic causes.

When, leaving the infections, we look for evidence of progress

in our knowledge of more or less local diseases, we may begin with the nervous system. It is in this department, from its abstruseness and complexity, that we should expect the *Neurology* advance of anatomy and physiology—normal and morbid—to be most delayed. If we consult the medical works even of the middle of the 19th century we shall find that, in the light of the present time, accurate knowledge in this sphere, whether clinical, pathological or therapeutical, could scarcely be said to exist. Even in the hands of J. A. Lockhart Clarke (1817-1880), one of the earliest investigators of nervous pathology, the improvement of the compound microscope had not attained the achromatism, the penetration and the magnification which have since enabled J. L. C. Schroeder-van der Kolk (1797-1862), Albert von Kölliker, Santiago Ramon y Cajal, C. Golgi (b. 1844) and others to reveal the minute anatomy of the nervous centres; while the discrimination of tissues and morbid products by stains, as in the silver and osmic acid methods, and in those known by the names of Carl Weigert or Marchi, had scarcely begun. In England the Hospital for the Paralyzed and Epileptic was founded in 1859, where Charles E. Brown-Séquard (1817-1894), J. Hughlings-Jackson, Thomas Buzzard, Henry C. Bastian (b. 1837), Sir W. R. Gowers and David Ferrier (b. 1843) found an adequate field for the clinical and pathological parts of their work. In France, in the wards of the Hôtel Dieu, Guillaume Benjamin Duchenne (1806-1875), in association with Trousseau and in his private clinic, pursued his memorable clinical and therapeutical researches into the diseases of the nervous system; and Jean M. Charcot (1825-1893) in that great asylum for the wreckage of humanity—the Salpêtrière—discovered an unworked mine of chronic nervous disease. M. H. Romberg (1795-1873) and Theodor Meynert (1833-1892) also were pioneers in the study of nervous diseases, but it was not till later in the century that Germany took a high place in this department of medicine. The discoveries of the separate paths of sensory and motor impulses in the spinal cord, and consequently of the laws of reflex action, by Charles Bell and Marshall Hall respectively, in their illumination of the phenomena of nervous function, may be compared with the discovery in the region of the vascular system of the circulation of the blood; for therein a key to large classes of normal and aberrant functions and a fertile principle of interpretation were obtained. Nor was the theory of reflex action confined to the more "mechanical" functions. By G. H. Lewes and others the doctrine of "cerebral reflex" was suggested, whereby actions, at first achieved only by incessant attention, became organized as conscious or subconscious habits; as for instance in the playing on musical or other instruments, when acts even of a very elaborate kind may directly follow the impulses of sensations, conscious adaptation and the deliberate choice of means being thus economized. This law has important ethical and political bearings; but in the province of disease this advance of what may be compared to the interlocking of points and signals has had wide influence not only in altering our conceptions of disease, but also in enlarging our views of all perturbations of function. The grouping of reflex "units," and the paths wherein impulses travel and become associated, have been made out by the physiologist (Sherrington and others) working on the healthy animal, as well as by the record of disease; and not of spontaneous disease alone, for the artificial institution of morbid processes in animals has led to many of these discoveries, as in the method of A. V. Waller (1816-1870), who tracked the line of nervous strands by experimental sections, and showed that when particular strands are cut off from their nutritive centres the consequent degeneration follows the line of the separated strands. By similar methods nature, unassisted, betrays herself but too often; in many instances—probably originating primarily in the nervous tissues themselves—the course of disease is observed to follow certain paths with remarkable consistency, as for instance in diseases of particular tracts of the spinal cord. In such cases the paths of degeneration are so neatly defined that, when the tissues are prepared after death by modern methods, they are plainly to be seen running along certain columns, the subdivisions

of which in the normal state may hardly be distinguishable one from another: some run in strips along the periphery of the spinal cord, at its anterior, middle or posterior segments, as the case may be; in other cases such strips occur within its substance, whether along columns of cells or of white matter. It is needless to point out how such paths of disease, in their association with characteristic symptoms, have illuminated the clinical features of disease as well as the processes of normal function.

Not, however, all diseases of the nervous system conduct themselves on these definite paths, for some of them pay no attention to the geography of structure, but, as one may say, blunder indiscriminately among the several parts; others, again, pick out particular parts definitely enough, but not parts immediately contiguous, or even contiguous. Diseases of the latter kind are especially interesting, as in them we see that parts of the nervous structure, separated in space, may nevertheless be associated in function; for instance, wasting of a group of muscles associated in function may depend on a set of central degenerations concurring in parts whose connexion, in spite of dissociation in space, we thus perceive. The indiscriminating diseases, on the other hand, we suspect not to be primarily of nervous origin, but to depend rather on the agency of other constituent tissues of this system, as of the blood-vessels or the connective elements. Thus, arguing inversely, we may learn something of the respective natures of these influences and of the way in which the nervous system is affected secondarily.

Yet even the distribution of toxic matters by the blood is not necessarily followed by general and indiscriminate injury to the nervous elements. In infantile palsy, for example, and in tabes dorsalis, there is good reason to believe that, definitely as the traces of the disease are found in certain physiologically distinct nervous elements, they are due nevertheless to toxic agents arriving by way of the blood. Here we enter upon one of the most interesting chapters of disorders and modes of disorder of this and of other systems. It has come out more and more clearly of late years that poisons do not betray even an approximately indifferent affinity for all tissues, which indeed a little reflection would tell us to be a priori improbable, but that each tends to fix itself to this cell group or to that, picking out parts for which they severally have affinities. Chemical, physiological and pathological research is exploring the secret of these more refined kinds of "anchorage" of molecules. In 1868 Drs A. Crum Brown and T. R. Fraser proved that by substitution of molecules in certain compounds a stimulant could be converted into a sedative action; thus by the addition of the methyl group CH_3 to the molecule of strychnine, thebaine or brucine, the tetanizing action of these drugs is converted into a paralyzing action. The number of these instances, and the variety of them, are now known to be very large; and it is supposed that what is true of these simpler agents is true also of far more elaborate phases of vital metabolism. Now, what is remarkable in these and many other reactions is not only that effects apparently very opposite may result from minute differences of molecular construction, but also that, whatever the construction, agents, not wholly indifferent to the body or part, tend to anchor themselves to organic molecules in some way akin to them. Highly complex as are all animal tissues, or nearly all, yet in this category of high complexity are degrees higher and higher again of which we can form little conception, so elaborate they are, so peculiar in their respective properties, and probably so fugitive. It is this wide range of dynamic peculiarities above the common range of known physical and chemical molecules which excites our wonder; and a reflection of these peculiar properties is seen in their affinities for this or that toxic or constructive agent, whereby the peculiarity, for example, of a particular kind of nerve cell may be altered, antagonized, reinforced or converted. On the other hand, the reagents by which such modifications are apt to be produced are not necessarily simple; many of them likewise are known to be of very high degrees of complexity, approaching perhaps in complexity the molecules to which they

are akin. Of such probably are the toxins and antitoxins of certain infections, which, anchoring themselves not by any means indiscriminately, but to particular and concerted molecules, by such anchorage antagonize them or turn them to favourable or unfavourable issues. Toxins may thus become so closely keyed into their corresponding atom groups, as for instance in tetanus, that they are no longer free to combine with the antitoxin; or, again, an antitoxin injected before a toxin may anticipate it and, preventing its mischievous adhesion, dismiss it for excretion. In the mutual behaviour of such cells, toxins, and antitoxins, and again of microbes themselves, we may demonstrate even on the field of the microscope some of the modes of such actions, which seem to partake in great measure at any rate of a chemical quality (agglutinins, coagulins, chemotaxis). It is convenient here to add that such reactions and modifications, if more conspicuous in the nervous system, are of course not confined to it, but are concerned in their degree in all the processes of metabolism, being most readily traced by us in the blood.

Many other diseases formerly regarded as primarily diseases of the nervous system are not such; but, by means of agents either introduced into the body or modified there, establish themselves after the affinities of these in contiguous associated parts of the structure, as in vascular, membranous or connective elements, or again in distant and peripheral parts; the perturbations of nervous function being secondary and consequential. Of such are tetanus and diphtheria, now known to be due to the establishment from without of a local microbic infection, from which focus a toxin is diffused to the nervous matter. The terrible nervous sequels of some forms of inflammation of the membranes of the brain, again, are due primarily to microbic invasion rather of the membranes than of their nervous contents; and many other diseases may be added to this list. The grave palsies in such diseases as influenza, diphtheria, beriberi, or ensuing on the absorption of lead, are in the main not central, but due to a symmetrical peripheral neuritis.

Among diseases not primarily nervous, but exhibited in certain phenomena of nervous disorder, are *diseases of the blood-vessels*. Much light has been thrown upon the variations of arterial and venous blood pressures by Karl Ludwig (1816-1895) and his many followers: by them not only the diseases of the circulatory system itself are elucidated, but also those of other systems—the nervous, for instance—which depend intimately on the mechanical integrity of the circulation of the blood as well as on the chemical integrity of the blood itself. With changes of the pressures of the blood in arteries, veins or capillaries, and in the heart itself and its respective chambers, static changes are apt to follow in these parts; such as degeneration of the coats of the arteries, due either to the silent tooth of time, to persistent high blood pressures, or to the action of poisons such as lead or syphilis. Syphilitic lesion of the arteries, and likewise of other fibrous tissues, often involves grave consequential damage to nervous structures fed or supported by such parts. Some of the most successful of the advances of medicine as a healing art have followed the detection of syphilitic disease of the vessels, or of the supporting tissues of nervous centres and of the peripheral nerves; so that, by specific medication, the treatment of paralytic, convulsive, and other terrible manifestations of nervous disease thus secondarily induced is now undertaken in early stages with definite prospect of cure.

Not of less importance in this respect, and in other disorders many of them of grave incidence, is the knowledge of the phenomena of *embolism* and of *thrombosis*, also gained during the latter half of the 19th century—W. S. Kirkes (1823-1864), R. Virchow. By embolism is meant the more or less sudden stoppage of a vessel by a plug of solid matter carried thither by the current of the blood; be it a little clot from the heart or, what is far more pernicious, an infective fragment from some focus of infection in the body, by which messengers new foci of infection may be scattered about the body. Thrombosis is an accident

Anchorage of Molecules.

Individual Forms of Disease.

of not dissimilar character, whereby a vessel is blocked not by a travelling particle, but by a clotting of the blood *in situ*, probably on the occasion of some harm to the epithelial lining of the vessel. Such injuries are apt to occur in syphilitic endarteritis, or senile arterial decay, whereby an artery may be blocked permanently, as if with an embolus, and the area supplied by it, in so far as it was dependent upon this vessel, deprived of nutrition. These events, although far more mischievous in the brain, the functions of which are far-reaching, and the collateral circulation of which is ill-provided, are seen very commonly in other parts.

It is in the structure of the brain itself that modern research has attained the most remarkable success. In 1861 an alleged "centre" of speech was detected, by a combination of clinical and pathological researches, by Paul Broca (1824-1880). By these means also, in the hands of Hughlings-Jackson, and more conclusively by experimental research initiated by G. T. Fritsch (b. 1838) and T. E. Hitzig (b. 1838), but pursued independently and far more systematically and thoroughly by David Ferrier (b. 1843) and his disciples, it was proved that the cerebrum is occupied by many such centres or exchanges, which preside over the formulation of sensations into purposive groups of motions—kinaesthesia of H. Charlton Bastian (b. 1837). The results of these experimental researches by many inquirers into the constitution of the brain have transformed our conceptions of cerebral physiology, and thrown a flood of light on the diseases of the brain. Not only so, but this mapping of the brain in areas of function now often enables the clinical physician to determine the position of disease; in a certain few cases of tumour or abscess, so precisely that he may be enabled to open the skull above the part affected and to extirpate it—operations which are surely a triumph of science and technical skill (Lister, W. MacEwen, V. Horsley).

The remarkable discovery of the dual nature of the nervous system, of its duplex development as a lower and upper system of "neurons," has shed much light upon the problems of practical medicine, but this construction is described under BRAIN; NEUROPATHOLOGY; MUSCLE AND NERVE, &c.

In mental diseases little of first-rate importance has been done. The chief work has been the detection of chronic changes in the cortex of the brain, by staining and other histological methods, in degenerative affections of this organ—Theodor Meynert (1833-1892), W. Griesinger (1817-1868), Bevan Lewis—and in the separation from insanity due to primary disease or defect of nerve elements of such diseases as general paralysis of the insane, which probably arise, as we have said, by the action of poisons on contiguous structures—such as blood-vessels and connective elements—and invade the nervous matter secondarily. Some infections, however, seem to attack the mental fabric directly; intrinsic toxic processes which may be suspected on the detection of neurin and cholin in the fluids of the brain (F. W. Mott). Truer conceptions of normal psychology have transformed for us those of the morbid—P. Pinel (1745-1826), Griesinger, Henry Maudsley (b. 1835), Mercier, Kräpelin, Rivers—and indicated more truly the relations of sanity to insanity. In the treatment of insanity little has been done but to complete the non-restraint system which in principle belongs to the earlier part of the 19th century (Pinel, Tuke, R. G. Hill, J. Conolly). An enormous accumulation of lunatics of all sorts and degrees seems to have paralysed public authorities, who, at vast expense in buildings, mass them more or less indiscriminately in barracks, and expect that their sundry and difficult disorders can be properly studied and treated by a medical superintendent charged with the whole domestic establishment, with a few young assistants under him. The life of these insane patients is as bright, and the treatment as humane, as a barrack life can be; but of science, whether in pathology or medicine, there can be little. A considerable step in advance is the establishment by the London County Council of a central laboratory for its asylums, with an eminent pathologist at its head: from this laboratory valuable reports are in course of issue. Provision for the reception and treatment of insanity in its earliest and more curable stages can scarcely be said to exist. Sufferers from

mental disease are still regarded too much as troublesome persons to be hidden away in humane keeping, rather than as cases of manifold and obscure disease, to be studied and treated by the undivided attention of physicians of the highest skill. The care and education of idiots, initiated by Guggenbuhl and others, is making way in England, and if as yet insufficient, is good of its kind.

By the genius of René Théophile Laennec (1781-1826), *diseases of the lungs and heart* were laid on a foundation so broad that his successors have been occupied in detail and refinement rather than in reconstruction. In heart disease the chief work of the latter half of the 19th century was, in the first quarter, such clinical work as that of William Stokes and Peter Mere Latham (1789-1875); and in the second quarter the fuller comprehension of the vascular system, central and peripheral, with its cycles and variations of blood pressure, venous and arterial. Moreover, the intricacies of structure and function within the heart itself have been more fully discriminated (W. H. Gaskell, Aschoff, A. Keith, Wenkebach, J. Mackenzie). By the greater thoroughness of our knowledge of the physics of the circulation—Étienne Marey (b. 1830), Karl Ludwig (1816-1895), Leonard Hill—we have attained to a better conception of such events as arterial disease, apoplexy, "shock," and so forth; and pharmacologists have defined more precisely the virtues of curative drugs. To the discovery of the parts played in disease by thrombosis and embolism we have referred above. With this broader and more accurate knowledge of the conditions of the health of the circulation a corresponding efficiency has been gained in the manipulation of certain remedies and new methods of treatment of heart diseases, especially by baths and exercises.

As regards pulmonary disease, pneumonia has passed more and more definitely into the category of the infections: the modes of invasion of the lungs and pleura by tuberculosis has been more and more accurately followed; and the treatment of these diseases, in the spheres both of prevention and of cure, has undergone a radical change. Instead of the close protection from the outer air, the respirators, and the fancy diets of our fathers, the modern *poitrineaire* camps out in the open air in all weathers, is fed with solid food, and in his exercise and otherwise is ruled with minute particularity according to the indications of the clinical thermometer and other symptoms. The almost reckless reliance on climate, which, at Davos for instance, marked the transition from the older to the modern methods, has of late been sobered, and supplemented by more systematic attention to all that concerns the mode of life of the invalid. The result is that, both in physicians and in the public, a more hopeful attitude in respect of the cure of phthisis has led to a more earnest grappling with the infection in its earliest stages and in every phase, with a correspondingly large improvement in prevention and treatment. Indeed, in such early stages, and in patients who are enabled to command the means of an expensive method of cure, phthisis is no longer regarded as desperate; while steps are being taken to provide for those who of their own means are unable to obtain these advantages, by the erection of special sanatoriums on a more or less charitable basis. Perhaps no advance in medicine has done so much as the study of tuberculosis to educate the public in the methods and value of research in medical subjects, for the results, and even the methods, of such labours have been brought home not only to patients and their friends, but also to the farmer, the dairyman, the butcher, the public carrier, and, indeed, to every home in the land.

It was in the management of pleuritis that the aid of surgical means first became eminent in inward disease. In the treatment of effusions into the pleura and, though with less advantage, of pericardial effusions, direct mechanical interference was practised by one physician and another, till these means of attaining rapid and complete cure took their places as indispensable, and were extended from thoracic diseases to those of the abdominal and other inner parts formerly beyond the reach of direct therapeutics. Lord Lister's discoveries brought these new methods to bear with a certainty and a celerity previously undreamed of; and many visceral maladies, such as visceral ulcers, disease of the pancreas,

stone of the kidney or gall-bladder, perityphlitis, ovarian dropsy, which in the earlier part of the 19th century were either fatal or crippling, are now taken promptly and safely in hand, and dealt with successfully. Even for internal cancer cure or substantial relief is not infrequently obtained. We have said that this advance is often quoted, not very wisely, to signify that in modern progress "medicine" has fallen behind surgery—as if the art of the physician were not one and indivisible. That certain Fellows of the College of Physicians (especially in gynaecology) have personally taken operative procedures in hand is some good omen that in time the unreal and mischievous schism between medicine and surgery may be bridged over.

In the department of *abdominal disease* progress has been made, not only in this enormous extension of means of cure by operative methods, but also in the verification of diagnosis. The first recognition of a disease may be at a necropsy, but then usually by irresponsible pathologists; it is another matter when the physician himself comes under rebuke for failing to seize a way to cure, while the chance remained to him, by section of the abdomen during life. The abdomen is still "full of surprises"; and he who has most experience of this deceptive region will have least confidence in expressing positive opinions in particular cases of disease without operative investigation. Besides the attainments mentioned above, in respect of operative progress, many important revisions of older rule-of-thumb knowledge have come about, and not a few other substantial discoveries. Among the revisions may be added some addition to our knowledge of dyspepsia, attained by analytic investigations into the contents of the stomach at various stages of digestion, and by examining the passage of opaque substances through the *primæ viæ* by the Röntgen rays. Thus the defects, whether of this secretion or of that, and again of motor activity, the state of the valvular junctions, the volume of the cavities, and their position in the abdomen, may be ascertained, and dealt with as far as may be; so that, although the fluctuations of chemical digestion are still very obscure, the application of remedies after a mere traditional routine is no longer excusable. In our conceptions of the later stages of assimilation and of excretion, with the generation of poisons (auto-intoxication) in the intestinal tract, there is still much obscurity and much guess-work; yet in some directions positive knowledge has been gained, partly by the physiologist, partly by the physician himself. Of such are the better understanding of the functions of the liver in normal catabolism, in the neutralization of poisons absorbed from the intestines or elsewhere, in the causation of jaundice, and in diabetes (Bernhardt Naunyn (b. 1830) and F. W. Pavy). Nor must we forget the unfolding of a new chapter of disease, in the nosology of the pancreas. In diabetes this organ seems to play a part which is not yet precisely determined; and one fell disease at least has been traced to a violent access of inflammation of this organ, caused perhaps by entry of foreign matters into its duct. The part of the pancreas in digestion also is better understood. The part of the spleen in the motley group of dyspepsias and anaemias, conspicuous as it often is, still remains very enigmatic.

The peritoneum is no longer regarded with awe as inviolable; by modern methods, it is not as manageable as other lymphatic sacs, it is at any rate accessible enough without considerable risk to life. Not only in its bacteriological relations are the conditions of peritonitis recognized in its various kinds, but also the state known as "shock" turns out to be quasi-mechanical, and avoidable by measures belonging in considerable part to this category. Thus, by the avoidance both of toxæmia and of shock, peritonitis and other dangers of the abdomen, such as strangulations or intussusceptions of the bowels, formerly desperate, can in many cases be dealt with safely and effectively.

Our knowledge of diseases of the kidneys has made no great advance since the time of Richard Bright. In the sphere of physiology and in the interpretation of associated arterial diseases much obscurity still remains; as, for instance, concerning the nature of the toxic substances which produce those bilateral changes in the kidneys which we call Bright's disease, and bring about the "uraemia" which is characteristic of it. Lardaceous

disease, however, here and in other regions, now appears to be due to the specific toxins of pyrogenetic micro-organisms. In stone of the kidney a great advance has been made in treatment by operative means, and the formation of these stones seems to recent observers to depend less upon constitutional bent (gout) than upon unhealthy local conditions of the passages, which in their turn again may be due to the action of micro-organisms.

To Thomas Addison's descriptions of certain anaemias, and of the disease of the suprarenal capsules which bears his name, something has been added; and W. Hunter's researches on the severer anaemias are doing much to elucidate these subtle maladies. And on the influence of these inconspicuous bodies and of the pituitary body in sustaining arterial blood pressures physiologists have thrown some important light.

The secret of the terrible puerperal septicæmia was read by J. P. Semmelweis (*q.v.*), wherein he proved himself to be the greatest of Lister's forerunners (see LISTER).

The *diseases peculiar to women* (see GYNAECOLOGY) have received attention from early times, but little progress had been made in their interpretation till the 19th century. In the middle part of the century, by a natural exaggeration of the importance of newly-discovered local changes in the pelvic organs, much harm was done to women by too narrow an attention to the site, characters and treatment of these; the meddlesomeness of the physician becoming in the temperament of woman a morbid obsession. To James Matthews Duncan (1826-1890) we chiefly owe a saner and broader comprehension of the relative importance of the local and the general conditions which enter into the causation of uterine and ovarian disorders. In operations for diseases of the pelvis, ovarian dropsy, cancer of the uterus, and other grave diseases of the region, success has been stupendous.

In the subject of *diseases of the skin* much has been done, in the minuter observation of their forms, in the description of forms previously unrecognized, and in respect of bacterial and other causation and of treatment. The comparison of observations in various climates and peoples has had some weight; while in the better knowledge of their causes their treatment has found permanent advantage. Not only is the influence of bacteria in the causation of many of them newly revealed, but it is now recognized also that, even in skin diseases not initiated by microbial action, microbes play a considerable and often a determining part in their perpetuation; and that the rules of modern aseptic surgery are applicable with no little success to skin therapeutics. We have learned that "constitutional" causes play a smaller part in them than was supposed, that a large number of diseases of the skin, even if initiated by general disorder, are or soon become local diseases, being, if not initiated by local infection yet perpetuated thereby, so that, generally speaking, they are to be cured by local means.

The *diseases of children* have not lacked the renewed attention, the successful investigation, and the valuable new lights which have been given to other departments of medicine. That infantile paralysis is an infection, and that its unhappy sequelæ are now treated with more hope of restoration, has been indicated already. Infantile diarrhoea has also been recognized as a common infection (Ballard), and the means of its avoidance and cure ascertained. The conditions of diet and digestion in children are now far better understood, and many of their maladies, formerly regarded as organic or incomprehensible, are cured, or prevented by dietetic rules. Rickets, scurvy and "marasmus" may be instanced as diet diseases in children. Acute inflammation of the ear, with its alarming extensions to the cerebral cavity, is now dealt with successfully by surgical means, and infected sinuses or even encephalic abscesses are reached and cleansed. The origins, kinds and processes of meningitis are more clearly distinguished, and referred each to its proper cause—for the most part bacterial.

As by the discovery of stethoscopy by Laennec a new field of medical science and art was opened up, so, more recently, inventions of other new methods of investigation in medicine

have opened to us other fields of little less interest and importance. Of such is the ophthalmoscope, invented by H. *Diagnosis.* von Helmholtz in 1851. By the revelations of this instrument not only have the diseases of the eye been illuminated, but much light has been thrown also upon the part of the eye in more general maladies; as, for instance, in syphilis, in diabetes, in kidney diseases, and in diseases of the brain—F. C. Donders (1818-1889), Alfred von Gräfe (1830-1899) and others. A remarkable help to the cure of headaches and wider nervous disorders has come out of the better appreciation and correction of errors of refraction in the eye. Radiography has done great things for surgery; for medicine its services are already appreciable, and may prove more and more valuable hereafter. In 1879 the use of the spectroscopy in medicine was pointed out by Dr Charles A. MacMunn (b. 1852). By E. du Bois-Reymond, Robert Remak (1815-1865), Carlo Matteucci (1811-1868), Guillaume Duchenne (1806-1875), the value of electricity in medicine, greater in diagnosis perhaps than in therapeutics, was demonstrated. By the sphygmograph (E. J. Marey, 1863) attention was drawn to the physical features of the circulation, to the signs of degeneration of the arterial tree, and less definitely to the fluctuations of blood pressure; but as we have said under the consideration of diseases of the heart, the kymographs of Ludwig and his pupils brought out these fluctuations far more accurately and completely. By these, and other instruments of precision, such as the thermometer, of which we have already spoken, the eminently scientific discipline of the measurement of functional movements, so difficult in the complex science of biology, has been cultivated. By the laryngoscope, invented about 1850 by Manuel Garcia the celebrated singing-master, and perfected by Johann Czermak (1828-1873) and others, the diseases of the larynx also have been brought into the general light which has been shed on all fields of disease; and many of them, previously known more or less empirically, submitted to precise definition and cure. Of such we may cite tuberculosis of the larynx, formerly as incurable as distressing; and "adenoids"—a disease revealed by intrascopic methods—which used grievously to thwart and stifle the growth both of mind and body in children, are now promptly removed, to the infinite advantage of the rising generation. To the value of stains in clinical diagnosis, especially in investigation of perversions of the blood in many maladies, we have already made some reference. The discovery of the Röntgen rays has also extended the physician's power of vision, as in cases of aortic aneurysm, and other thoracic diseases.

By photography and diagrammatic records the clinical work of hospital wards has been brought into some better definition, and teaching made more accurate and more impressive. The separation of the alkaloids belongs rather to the earlier part of the 19th century, but the administration of these more accurate medications by means of hypodermic injection (see *THERAPEUTICS*) belongs to the latter. The ancient practice of transfusion has been placed on a more intelligible footing, and by the method of saline injections made more manageable as a means of relief or even of cure. Finally, calculation by statistics (William Farr, Karl Pearson, and others) has been brought into line with other scientific methods: the method is a difficult one, and one full of pitfalls for the unwary, yet when by co-operation of physician and mathematician its applications have been perfected its services will appear more and more indispensable.

Among the achievements of the medicine of the 19th century the growth of the medical press must not be forgotten. In England, by the boldness of the *Lancet* (founded in 1823), the tyranny of prescription, inveterate custom, and privilege abused was defied and broken down; freedom of learning was regained, and promotion thrown open to the competent, independently of family, guild and professional status. For the record and diffusion of rapidly growing knowledge, learned societies, universities and laboratories, greatly increased in number and activity, issue their transactions in various fields; and by means of year-books and central news-sheets the accumulation of knowledge is organized and made accessible.

It is interesting to find that, with all this activity in the present reformed methods of research and verification are not confined to the work of the passing day; in the brilliant achievements of modern research and reconstruction the maxim that "Truth is the daughter of Time" has not been forgotten. In the field of the History of Medicine the work of scholars such as Francis Adams of Banchoy (1796-1861), William A. Greenhill (1814-1894) and C. Creighton in England, Maximilien P. Littré (1801-1881) and Charles V. Daremberg (1817-1872) in France, and Heinrich Häser (1811-1888) and August Hirsch, Diels, Weltmann and Julius Pagel in Germany, will prove to our children that tradition was as safe in our hands as progress itself.

(T. C. A.)

BIBLIOGRAPHY.—Osler and McCrae, *Modern Medicine*; F. T. Roberts, *The Practice of Medicine* (1909); Hermann Nothnagel, *Internationale Beiträge zur inneren Medizin* (1902); Ed. Brouardel, *Traité de médecine* (1895-1902); T. D. Savill, *Clinical Medicine* (1909); W. Osler, *The Principles and Practice of Medicine* (1909); Allbutt and Rolleston, *A System of Medicine* (1906-1910); Sir Patrick Manson, *Tropical Medicine* (1907); Frederick Taylor, *A Manual of the Practice of Medicine* (1908).

MEDINA, JOSE TORIBIO (1852-), Chilean bibliographer, was born at Santiago, and was educated for the bar. His first publication, when a very young man, was a metrical translation of Longfellow's *Evangeline*. When twenty-two he was appointed secretary to the legation at Lima. After his return he published a history of Chilean literature (1878), and a work upon the aboriginal tribes (1884). In this latter year he was appointed secretary of legation in Spain, and availed himself of the opportunity of examining the treasures of the old Spanish libraries. These researches, repeated on subsequent visits to Spain, and also to France and England, enriched him with a mass of historical and bibliographical material. Among his publications may be mentioned the *Biblioteca hispano-americana*, a catalogue of all books and pamphlets relating to Spanish America printed in Spain; the *Biblioteca hispano-chilena*, a similar work, commenced in 1897; the standard and magnificent history of printing in the La Plata countries (1892); comprehensive works on the Inquisition in Chile, Peru and the Philippines; and the standard treatise on South American medals (1899). In addition, Señor Medina produced the fullest bibliographies yet attainable of books printed at Lima, Mexico and Manila, and a number of memoirs and other minor writings. No other man had rendered anything like the same amount of service to the literary history and bibliography of the Spanish colonies.

MEDINA, or rather AL-MEDINA (the city), or MEDINAT RASUL ALAH (the city of the apostle of God), a town of the Hejaz in Arabia, about 820 m. by rail S.E.E. of Damascus, in 25° N., 40° E., the refuge of Mahomet on his emigration from Mecca, and a renowned place of Moslem pilgrimage, consecrated by the possession of his tomb. The name Medina goes back to the Koran (*sur.* xxxiii. 60); the old name was Yathrib, the Lathrippa of Ptolemy and Iathrippa of Stephanus Byzantius.

Medina stands in a basin at the northern extremity of an elevated plain, on the western skirt of the mountain range which divides the Red Sea coast-lands from the central plateau of Arabia. At an hour's distance to the north it is dominated by Mount Ohod, an outlying spur of the great mountains, the scene of the well-known battle (see MAHOMET), and the site of the tomb and mosque of the Prophet's uncle Hamza. To the east the plain is bounded by a long line of hills eight or ten hours distant, over which the Nejd road runs. A number of torrent courses (of which Wadi Kanat to the north, at the foot of Mount Ohod, and W. Akik, some miles to the south, are the most important) descend from the mountains, and converge in the neighbourhood of the town to unite farther west at a place called Zaghaba, whence they descend to the sea through the "mountains of the Tehama"—the rough country between Medina and its

¹ This is a very rough estimate. The road from Yambu on the Red Sea, which runs somewhat north of east, is by Burton's estimate 132 m. From Medina to Mecca by the inland or high road he makes 248 m. The usual road near the coast by Rabigh and Khulea and thence to W. Fatima cannot be very different in length. Caravans traverse it in about ten or eleven days.

port of Yambu—under the name of W. Idam. Southwards from Medina the plain extends unbroken, but with a slight rise, as far as the eye can reach. The convergence of torrent-courses in the neighbourhood of Medina makes this one of the best-watered spots in northern Arabia. The city lies close to one of the great volcanic centres of the peninsula, which was in violent eruption as late as A.D. 1266, when the lava stream approached within an hour's distance of the walls, and dammed up W. Kanat. The result of this and other prehistoric eruptions has been to confine the underground water, so important in Arabian tillage, which can be reached at any point of the oasis by sinking deep wells. Many of the wells are brackish, and the natural fertility of the volcanic soil is in many places impaired by the salt with which it is impregnated; but the date-palm grows well everywhere, and the groves, interspersed with gardens and cornfields, which surround the city on all sides except the west, have been famous from the time of the Prophet. Thus situated, Medina was originally a city of agriculturists, not like Mecca a city of merchants; nor, apart from the indispensable trade in provisions, has it ever acquired commercial importance like that which Mecca owes to the pilgrimage.¹ Landowners and cultivators are still a chief element in the population of the city and suburbs. The latter, who are called Nakhawila, and more or less openly profess the Shi'a opinions, marry only among themselves. The townsmen proper, on the other hand, are a very motley race.² New settlers remain behind with each pilgrimage; attracted by the many offices of profit connected with the mosque, the stipends paid by the sultan to every inhabitant, and the gains to be derived by pilgrim-cicerones (*Musawwirs*) or by those who make it a business to say prayers at the Prophet's mosque for persons who send a fee from a distance, as well as the alms which the citizens are accustomed to collect when they go abroad, especially in Turkey. The population of the city and suburbs may be from 16,000 to 20,000.

The city proper is surrounded by a solid stone wall,³ with towers and four massive gateways of good architecture, forming an irregular oval running to a kind of angle at the north-west, where stands the castle, held by a Turkish garrison. The houses are good stone buildings similar in style to those of Mecca; the streets are narrow but clean, and in part paved.⁴ There is a copious supply of water conducted from a tepid source (ez-Zarkā) at the village of Kuba, 2 m. south, and distributed in underground cisterns in each quarter.⁵ The glory of Medina, and the only important building, is the mosque of the Prophet, in the eastern part of the city, a spacious enclosed court between 400 and 500 ft. in length from north to south, and two-thirds as much in breadth. The minarets and the lofty dome above the sacred graves are imposing features; but the circuit is hemmed in by houses or narrow lanes, and is not remarkable except for the principal gate (Bab al-Salam) at the southern end of the west front, facing the sacred graves, which is richly inlaid with marbles and fine tiles, and adorned with golden inscriptions. This gate leads into a deep portico, with ten rows of pillars, running along the southern wall. Near the farther end of the portico, but not

¹ The pilgrimage to Medina, though highly meritorious, is not obligatory, and it is not tied to a single season; so that there is no general concourse at one time, and no fair like that of Mecca.

² A small number of families in Medina still claim to represent the ancient *Ansar*, the "defenders" of Mahomet; there are also some *Siddiqiyah*, claiming descent from Abu Bekr. But in fact the old population emigrated *en masse* after the sack of Medina by Moslim in 683, and passed into Spain in the armies of Musa. In the 13th century one old man of the Khazraj and one old woman of the Aus tribe were all that remained of the old stock in Medina (Maqqari, i. 187; Dozy, *Mus. d'Espagne*, i. 111). The aristocratic family of the Beni Hosain, who claim descent from the martyr of Kerbela, and so from the Prophet, have apparently a better established pedigree.

³ According to Ibn Khallikan (Slane's trans. iii. 927) the walls are of the 12th century, the work of Jamāl ud-Din al-Isfahāni.

⁴ The Balāt or great paved street of Medina, a very unusual feature in an Eastern town, dates from the 1st century of Islam. (See Wüstenfeld's abstract of Samhūdi, p. 115.)

⁵ Kubā is famous as the place where the Prophet lived before he entered Medina, and the site of the first mosque in which he prayed. It lies amidst orchards in the richest part of the oasis.

adjoining the walls, is a sort of doorless house or chamber hung with rich curtains, which is supposed to contain the graves of Mahomet, Abu Bekr and Omar. To the north of this is a smaller chamber of the same kind, draped in black, which is said to represent the tomb of Fatima. Both are enclosed with an iron railing, so closely interwoven with brass wire-work that a glimpse of the so-called tombs can only be got through certain apertures, where intercessory prayer is addressed to the prophet, and pious salutations are paid to the other saints.⁶ The portico in front of the railing is not ineffective, at least by nightlight. It is paved with marble, and in the eastern part with mosaic, laid with rich carpets; the southern wall is clothed with marble pierced with windows of good stained glass, and the great railing has a striking aspect; but an air of tawdriness is imparted by the vulgar painting of the columns, especially in the space between the tomb and the pulpit, which has received, in accordance with a tradition of the Prophet, the name of the Garden (*rauda*), and is decorated with barbaric attempts to carry out this idea in colour.⁷ The throng of visitors passing along the south wall from the Bab al-Salam to salute the tombs is separated from the Garden by an iron railing. The other three sides of the interior court have porticoes of less depth and mean aspect, with three or four rows of pillars. Within the court are the well of the Prophet, and some palm-trees said to have been planted by Fatima; this "grove" is separated from the rest of the court by a wooden partition.

The original mosque was a low building of brick, roofed with palm-branches, and much smaller than the present structure. The wooden pulpit from which Mahomet preached appears to have stood on the same place with the present pulpit in the middle of the south portico. The dwelling of the Prophet and the huts of his women adjoined the mosque. Mahomet died in the hut of Ayesha and was buried where he died; Abu Bekr and Omar were afterwards buried beside him. In A.D. 711 the mosque, which had previously been enlarged by Omar and Othman, was entirely reconstructed on a grander scale and in Byzantine style by Greek and Coptic artificers at the command of the caliph Walid and under the direction of Omar Ibn Abd-al-Aziz. The enlarged plan included the huts above named, which were pulled down. Thus the place of the Prophet's burial was brought within the mosque; but the recorded discontent of the city at this step shows that the feeling which regards the tomb as the great glory of the mosque, and the pilgrimage to it as the most meritorious that can be undertaken except that to Mecca, was still quite unknown. It is not even certain what was done at this time to mark off the graves. Ibn 'Abd Rabbih, in the beginning of the 10th century (*'Ikā*, Cairo ed., iii. 366), describes the enclosure as a hexagonal wall, rising within three cubits of the ceiling of the portico, clothed in marble for more than a man's height, and above that height daubed with the unguent called *khalāk*. This may be supplemented from Iṣṭakhri, who calls it a lofty house without a door. That there are no gravestones or visible tombs within is certain from what is recorded of occasions when the place was opened up for repairs. Ibn Jubair (p. 193 seq.) and Samhūdi speak of a small casket adorned with silver, fixed in the eastern wall, which was supposed to be opposite the head of the Prophet, while a silver nail in the south wall indicated the point to which the corpse faced, and from which the salutation of worshippers was to be addressed (Burton misquotes). The European fable (mentioned and refuted, e.g. in *Histoire des Arabes par l'abbé de Marigny*, t. i. p. 46, Paris, 1750) of the coffin suspended by magnets is totally unknown to Moslem tradition. The smaller chamber of Fatima is comparatively modern. In the time of Ibn Jubair and of Ibn Batuta (unless

⁶ The space between the railing and the tomb is seldom entered except by the servants of the mosque. It contains the treasures of the mosque in jewels and plate, which were once very considerable, but have been repeatedly plundered, last of all by the Wahhābīs in the beginning of the 19th century.

⁷ The word *rauda* also means a mausoleum, and is applied by Ibn Jubair to the tomb itself. Thus the tradition that the space between the pulpit and the tomb was called by the Prophet one of the gardens of Paradise probably arose from a mistake.

the latter, as is so often the case, is merely copying his predecessor) there was only a small marble trough north of the rauda (or grave) which "is said to be the house of Fatima or her grave, but God only knows." It is more probable that Fatima was buried in the Bakī, where her tomb was also shown in the 12th century (Ibn Jubair, pp. 198 seq.).

The mosque was again extended by the caliph Mahdi (A.D. 781) and was burned down in 1256. Of its appearance before the fire we have two authentic accounts by Ibn 'Abd Rabbih early in the 10th century, and by Ibn Jubair, who visited it in 1184. The old mosque had a much finer and more regular appearance than the present one; the interior walls were richly adorned with marble and mosaic arabesques of trees and the like, and the outer walls with stone marquetry; the pillars of the south portico (seventeen in each row) were in white plaster with gilt capitals, the other pillars were of marble. Ibn 'Abd Rabbih speaks of eighteen gates, of which in Ibn Jubair's time, as at present, all but four were walled up. There were then three minarets. After the fire which took place just at the time of the fall of the caliphate, the mosque long lay in a miserable condition. Its repair was chiefly due to the Egyptian sultans, especially to Kāit Bey, whose restoration after a second fire in 1481 amounted almost to a complete reconstruction. Of the old building nothing seems to have remained but some of the columns and part of the walls. The minarets have also been rebuilt and two new ones added. The great dome above the tomb, the railing round it, and the pulpit, all date from Kāit Bey's restoration.

The suburbs, which occupy as much space as the city proper, and are partly walled in, lie south-west of the town, from which they are separated by an open space, the halting-place of caravans. Through the suburbs runs the watercourse called Wadi Buthan, a tributary of W. Kanāt, which the Yanbu' road crosses by a stone bridge. The suburbs are the quarter of the peasants. Thirty or forty families with their cattle occupy a single courtyard (*hōsh*), and form a kind of community often at feud with its neighbours. The several clans of Medina must have lived in much the same way at the time of the Prophet. The famous cemetery called Bakī' el-Gharqad, the resting-place of a multitude of the "companions" of the Prophet, lies immediately to the west of the city. It once contained many monuments, the chief of which are described by Ibn Jubair. Burckhardt in 1815 found it a mere waste, but some of the mosques have since been rebuilt.

History.—The story of the Amalekites in Yathrib and of their conquest by the Hebrews in the time of Moses is purely fabulous (see Noldeke, *Über die Amalekiter*, 1864, p. 36). The oasis, when it first comes into the light of history, was held by Jews, among whom emigrants from Yemen afterwards settled. From the time of the emigration of Mahomet (A.D. 622) till the Omayyads removed the seat of empire from Medina to Damascus, the town springs into historic prominence as the capital of the new power that so rapidly changed the fate of the East. Its fall was not less rapid and complete, and since the battle of Harra and the sack of the city in 683 it has never regained political importance (see CALIPHATE, B. §§ 1, 2, &c.). Mahomet invested the country round Medina with an inviolable character like that of the Haram round Mecca; but this provision has never been observed with strictness. After the fall of the caliphs, who maintained a governor in Medina, the native amirs enjoyed a fluctuating measure of independence, interrupted by the aggressions of the sherifs of Mecca, or controlled by an intermittent Egyptian protectorate. The Turks after the conquest of Egypt held Medina for a time with a firmer hand; but their rule grew weak, and was almost nominal long before the Wahhābīs took the city in 1804. A Turko-Egyptian force retook it in 1812, and the Turks now maintain a pasha with a military establishment, while the cadī and chief agha of the mosque (a eunuch) are sent from Constantinople. In late years the influence of the Turkish government has been much strengthened, an important factor in its consideration being the construction of the railway from Syria to the Hejaz. Railway communication between Damascus and Medina was effected in 1908.

AUTHORITIES.—Medina has been described from personal observation by Burckhardt, who visited it in 1815, and Burton, who made the pilgrimage in 1853. Sadler on his journey from Katif to Yambu (1819) was not allowed to enter the holy city. Burckhardt was prevented by ill-health from examining the city and country with his usual thoroughness. Little is added to our information by the report of 'Abd el-Kazzāq, who performed the pilgrimage in 1878, on a medical commission from the English government. The chief Arabic authority besides Ibn 'Abd Rabbih and Ibn Jubair is Samhūdī, of whose history Wüstenfeld published an abstract in the Göttingen *Abhandlungen*, vol. ix. (1861). It goes down to the end of the 15th century. The topography of the country about Medina is interesting both historically and geographically; Bakrī, Yāqūt and other Arabic geographers, supply much material on this topic. Some good information concerning Medina is contained in the 2nd volume of Doughty's *Travels in Arabia Deserta*.

(W. R. S.)

MEDINA, a village of Orleans county, in north-west New York, U.S.A., about 40 m. N.E. of Buffalo, and on Oak Orchard Creek. Pop. (1900), 4716. (857 foreign-born); (1905, state census), 5114; (1910) 5683. It is served by the New York Central & Hudson River railroad, by the Buffalo, Lockport & Rochester (interurban) railway, and by the Erie Canal. On Oak Orchard Creek and near the city are electric power plants, at the Medina Falls and at a large storage dam (60 ft. high) for water power, built in 1902. In the neighbourhood are extensive apple, peach and pear orchards; and vegetables, especially beans, are grown. There are valuable quarries of Medina sandstone, a good building, paving- and flag-stone, varying in colour from light grey to brownish red, readily shaped and split, and less likely than limestone to crack or than granite to wear splinter; it was first found at Medina in 1837. There was a saw-mill on the creek near here in 1805, but the place was little settled before 1824, and its growth was due to the Erie Canal. It was incorporated in 1832.

MEDINA SIDONIA, DON ALONSO PEREZ DE GUZMAN EL BUENO, 7TH DUKE OF (1550-1615), the commander-in-chief of the Spanish Armada, was born on the 10th of September 1550. He was the son of Don Juan Claros de Guzman, eldest son of the 6th duke, and of his wife Doña Leonor Manrique de Zuñiga y Sotomayor. His father died in 1555, and Don Alonso became duke, and master of one of the greatest fortunes in Europe, on the death of his grandfather in 1539. The family of Guzman was originally lords of Abiados, on the southern slope of the Picos de Europa in the hill country of Leon. The name is believed to be a contraction or corruption of Gundamaris, *i.e.* son of Gundamar. An early family tradition represents them as having come from Britain, and they may have descended from one of the Scandinavian invaders who attacked the north coast of Spain in the 10th century. It is in the 10th century that they first appear, and they grew great by the reconquest of the country from the Mahomedans. The branch to which the dukes of Medina Sidonia belonged was founded by Alonso Perez de Guzman (1256-1309), surnamed El Bueno, the good, in the sense of good at need, or stout-hearted. In 1296 he defended the town of Tarifa on behalf of Sancho IV., and when the besiegers threatened to murder one of his sons whom they held as a prisoner if he did not surrender, he allowed the boy to be killed. He was rewarded by great grants of crown land. The duchy of Medina Sidonia, the oldest in Spain, was conferred by John II. in 1445 on one of his descendants, Juan Alonso de Guzman, count of Niebla. The addition "El Bueno" to the family name of Guzman was used by several of the house, which included many statesmen, generals and colonial viceroys.¹ The 7th duke was betrothed in 1565 to Ana de Silva y Mendoza, who was then four years of age, the daughter of the prince of Eboli. In 1572 when the duchess was a little more than ten years of age, the pope granted a dispensation for the consummation of the marriage. The scandal of the time, for of which there appears to be no foundation, accused Philip II. of a love intrigue with the princess of Eboli. The unvarying and unmerited favour he showed the duke has been accounted for on the ground that he

¹ The titles and grandeeship passed, in accordance with Castilian law, by marriage of a daughter and heiress in 1777, to the marquess of Villafranca, and have since remained in that house.

took a paternal interest in the duchess. Don Alonso, though he bore the name of El Bueno, was a man of mean spirit. He made no serious effort to save his mother-in-law from the persecution she suffered at the hands of Philip II. His correspondence is full of whining complaints of poverty, and appeals to the king for pecuniary favours. In 1581 he was created a knight of the Golden Fleece, and was named captain-general of Lombardy. By pressing supplications to the king he got himself exempted on the ground of poverty and poor health. Yet when the marquis of Santa Cruz (*q.v.*) died, on the 9th of February 1588, Philip insisted on appointing him to the command of the Armada. He was chosen even before Santa Cruz was actually dead, and was forced to go in spite of his piteous declarations that he had neither experience nor capacity, and was always sick at sea. His conduct of the Armada justified his plea. He was even accused of showing want of personal courage, and was completely broken by the sufferings of the campaign, which turned his hair grey. The duke retained his posts of "admiral of the ocean" and captain-general of Andalusia in spite of the contempt openly expressed for him by the whole nation. When an English and Dutch armament assailed Cadiz in 1596 his sloth and timidity were largely responsible for the loss of the place. He was held up to ridicule by Cervantes in a sonnet. Yet the royal favour continued unabated even under the successor of Philip II. In 1606 the obstinacy and folly of the duke caused the loss of a squadron which was destroyed near Gibraltar by the Dutch. He died in 1615.

See Cesario Duro, *La Armada invencible* (Madrid, 1884), which gives numerous references to authorities.

MEDINA SIDONIA, or **MEDINASIDONIA**, a town of southern Spain, in the province of Cadiz, 21 m. by road E.S.E. of Cadiz. Pop. (1900), 11,040. Medina Sidonia is built on an isolated hill surrounded by a cultivated plain. It contains a fine Gothic church, several convents, and the ancestral palace of the dukes of Medina Sidonia. It has a small agricultural trade, chiefly in wheat, olives and oats.

Medina Sidonia has been identified by some with the *Asido* of Pliny, but this is uncertain. Under the Visigoths the place was erected into a bishopric (*Assidonia*), and attained some importance; in the beginning of the 8th century it was taken by Tariq. In the time of Idrisi (12th century) the province of *Shadāna* or *Shidona* included, among other towns, Seville and Carmona; later Arab geographers place *Shadāna* in the province of Seville.

MEDIOLANUM, or **MEDIOLANTUM** (mod. Milan, *q.v.*), an ancient city of Italy, and the most important in Gallia Transpadana. Livy attributes its foundation to the Galli Insubres under Bellocus after their defeat of the Etruscans, in the time of the older Tarquin. According to other authorities, the Etruscan city of Melpum which preceded it was destroyed in 306 B.C. Objects of the Bronze age have been found outside the city on the south. The name itself is Celtic. The Romans defeated the Insubres in 225-222 B.C., and stormed Mediolanum itself in the latter year. Its inhabitants rebelled some twenty years later in the Hannibalic War, but were defeated and finally reduced to obedience in 196 B.C. They probably acquired Latin rights in 89, and full civic rights in 49 B.C., as did those of the other towns of Gallia Transpadana. It appears later on (but not before the 2nd century A.D.) to have become a colony. It acquired a certain amount of literary eminence, for we hear of youths going from Comum to Mediolanum to study. In Strabo's time it was on an equality with Verona, but smaller than Patavium, but in the later times of the empire its importance increased. At the end of the 3rd century it became the seat of the governor of Aemilia and Liguria (which then included Gallia Transpadana also, thus consisting of the 9th and 11th regions of Augustus), and at the end of the 4th, of the governor of Liguria only, Aemilia having one of its own thenceforth. From Diocletian's time onwards the *praefectus praetorio* and the imperial vicar of Italy also had their seat here; and it became one of the principal mints of the empire. The emperors of the West resided at Mediolanum during the 4th century, until Honorius preferred

Ravenna, and in 402 transferred his court there. Its importance, described in the poems of Ausonius, is demonstrated by its many inscriptions, and the interest and variety of their contents. In these the rarity of the mention of its chief magistrates is surprising; and it is not impossible that owing to its very importance the right of appointing them had been taken from it (as Mommsen thinks). The case of Ravenna is not dissimilar. The inscriptions indicate a strong Celtic character in the population. Procopius speaks of it as the first city of the West, after Rome, and says that when it was captured by the Goths in 539, 300,000 of the inhabitants were killed. It was an important centre of traffic, from which roads radiated in several directions—as railways do to-day—to Comum, to the foot of the Lacus Verbanus (Lago Maggiore), to Novaria and Vercellae, to Ticinum, to Laus Pompeja and thence to Placentia and Cremona, and to Bergomum. None of these roads had an individual name, so far as we know. To its secular power corresponds the independent position which its Church took in the time of St Ambrose (*q.v.*), bishop of Milan in 374-397, who founded the church which bears his name, and here baptized St Augustine in A.D. 387, and whose rite is still in use throughout the diocese. Theodosius indeed did penance here at Ambrose's bidding for his slaughter of the people of Thessalonica. After his death the period of invasions begins; and Milan felt the power of the Huns under Attila (452), of the Heruli under Odoacer (476) and of the Goths under Theodoric (493). When Belisarius was sent by Justinian to recover Italy, Datus, the archbishop of Milan, joined him, and the Goths were expelled from the city. But Uraia, nephew of Vitigis the Gothic king, subsequently assaulted and retook the town, after a brave resistance. Uraia destroyed the whole of Milan in 539; and hence it is that this city, once so important a centre of Roman civilization, possesses so few remains of antiquity. Narses, in his campaigns against the Goths, had invited the Lombards to his aid. They came in a body under Alboin, their king, in 568, and were soon masters of north Italy. They entered Milan in the next year, but Pavia became the Lombard capital.

Of Roman remains little is to be seen above ground, but a portico of sixteen Corinthian columns near S. Lorenzo, which may belong to the baths of Hercules, mentioned by Ausonius, or to the palace of Maximian. Close to the Torre del Carrobbio remains of an ancient bridge and (possibly) of the walls of Maximian were found; and many remains of ancient buildings, including a theatre, have been discovered below ground-level. The objects found are preserved in the archaeological museum in the Castello Sforzesco. (See MILAN.)

See Th. Mommsen in *Corp. inscript. Latin.* (Berlin, 1883), v. 617 sqq. (with full bibliography); *Notizie degli Scavi, passim.* (T. As.)

MEDITERRANEAN SEA. The Mediterranean is all that remains of a great ocean which at an early geological epoch, before the formation of the Atlantic, encircled half the globe along a line of latitude. This ocean, already diminished in area, retreated after Oligocene times from the Iranian plateau, Turkestan, Asia Minor and the region of the north-west Alps. Next the plains of eastern Europe were lost, then the Aralo-Caspian region, southern Russia and finally the valley of the Danube. The "Mediterranean region," as a geographical unit, includes all this area; the Black Sea and the Sea of Marmora are within its submerged portion, and the climate of the whole is controlled by the oceanic influences of the Mediterranean Sea. Professor Suess, to whom the above description is due, finds that the Mediterranean forms no exception to the rule in affording no evidence of elevation or depression within historic times; but it is noteworthy that its present basin is remarkable in Europe for its volcanic and seismic activity. Submarine earthquakes are in some parts sufficiently frequent and violent as seriously to interfere with the working of telegraph cables. Suess divides the Mediterranean basin into four physical regions, which afford probably the best means of description: (1) The western Mediterranean, from Gibraltar to Malta and Sicily,

enclosed by the Apennines, the mountains of northern Africa, and of southern and south-eastern Spain (*Cordillere bétique*).

(2) The Adriatic, occupying the space between the Apennines and the Dinaric group (Suess compares the Adriatic to the valley of the Brahmaputra). (3) A part surrounded by the fragments of the Dinaro-Taurus arch, especially by Crete and Cyprus. This includes the Aegean and the Black Sea, and its margin skirts the south coast of Asia Minor. These three parts belong strictly to Eurasia. (4) Part of the coastal region of Indo-Africa, terraced downwards in successive horizontal planes from the Shot, reaching the sea in the Little Syrte, and continuing to the southern depressions of Syria. Malta and Gozo are the only islands of the Mediterranean which can be associated with this section, and, *per contra*, the mountain chain of north-west Africa belongs to Eurasia. Murray (1888) estimates the total area of the Mediterranean at 813,000 sq. m. Karstens (1894) breaks it up into parts as follows:—

Western Mediterranean	841,593 sq. km.
Sicilian-Ionian basin	767,658 "
Greece and Levant basin	769,652 "
Adriatic Sea	130,656 "
Total	2,509,559 "

A more recent calculation by Krümmel gives the total area as 2,967,570 sq. km. or 1,145,830 sq. m. (See OCEAN.) Murray estimates the total surface of the Mediterranean drainage area, with which must be included the Black Sea, at 2,934,500 sq. m., of which 1,420,800 are Eurasian and 1,513,800 are African. The principal rivers entering the Mediterranean directly are the Nile from Africa, and the Po, Rhone and Ebro from Europe.

The physical divisions of the Mediterranean given above hold good in describing the form of the sea-bed. The western Mediterranean is cut off by a bank crossing the narrow strait between Sicily and Cape Bon, usually known as the Adventure Bank, on which the depth is nowhere 200 fathoms. The mean depth of the western basin is estimated at 881 fathoms, and the deepest sounding recorded is 2040 fathoms. In the eastern Mediterranean the mean depth is nearly the same as in the western basin. The Sicilian-Ionian basin has a mean depth of 885 fathoms, and the Levant basin, 793 fathoms. Deep water is found close up to the coast of Sicily, Greece, Crete and the edge of the African plateau. The steepest slope observed occurs off the island of Sapienza, near Navarino, where 1720 fathoms has been obtained only to miles from land. In 1897 the ship "Washington" obtained depths of 2220 fathoms in the middle of the eastern Mediterranean; and the Austrian expeditions in the "Pola" discovered in the "Pola Deep" ($35^{\circ} 44' N.$, $21^{\circ} 45' E.$), south-west of Cape Matapan, a maximum depth of 2046 fathoms. Between these two deep areas a ridge runs in a north-westerly direction 550 fathoms from the surface—possibly a projection from the African plateau. Another bank 1100 fathoms from the surface runs south from the east end of Crete, separating the Pola Deep from the depths of the Levant basin, in which a depth of 1960 fathoms was recorded near Makri on the coast of Asia Minor. The later expedition of the "Pola" discovered the "Rhodos Deep" ($36^{\circ} 5' N.$, $28^{\circ} 36' E.$), with a maximum depth of 2110 fathoms; this deep is closed to the south-east by a ridge running south-east, over which the depth is 1050 fathoms. Off the coast of Syria the "Pola" obtained four soundings of more than 1100 fathoms, and between Cyprus and the coast of Asia Minor only two over 550 fathoms. Murray gives the following figures for the areas and volumes of the Mediterranean at different depths:—

Depth.	Area.	Volume.
Fathoms.	Sq. Miles.	Cub. Miles.
0-100	201,300	80,950
100-500	251,650	220,850
500-1000	81,300	189,200
1000-2000	263,250	217,050
Over 2000	15,500	1,750
	813,000	709,800

which gives a mean depth over all of 768 fathoms. The following table is due to Karstens:—

	Volume.	Mean Depth.
	Cub. Km.	Fathoms.
Western Mediterranean	1,356,512	881
Sicilian-Ionian basin	1,242,549	793
Levant	1,116,599	793
Adriatic Sea	31,844	133

Krümmel gives the total volume of the basin as 4,249,020 cubic kilometres or 1,019,400 cubic statute miles, and the mean depth as 782 fathoms. (See OCEAN.)

Metecology.—As already stated, the "Mediterranean region" forms a distinct climatic unit, chiefly due to the form and position of the Mediterranean Sea. The prevailing winds in this region, which the sea traverses longitudinally, are westerly, but the sea itself causes the formation of bands of low barometric pressure during the winter season, within which cyclonic disturbances frequently develop, while in summer the region comes under the influence of the polar margin of the tropical high pressure belt. Hence the Mediterranean region is characteristically one of winter rains, the distinctive feature becoming less sharply defined from south to north, and the amount of total annual fall increasing in the same direction. The climate becomes more continental in type from west to east, but there are great local irregularities—the elevated plateaus of Algeria and Spain cause a rise of pressure in winter and delay the rainy seasons; the rains set in earlier in the west than in the east, and the total fall is greater. Temperature varies greatly, the annual mean varying from $56^{\circ} F.$ to $77^{\circ} F.$ In the west the Atlantic influence limits the mean annual range to about 10° – $12^{\circ} F.$, but in the east this increases to 36° and even 40° . Autumn is warmer than spring, especially in the coastal regions, and this is exaggerated in the eastern region by local land winds, which replace the cool sea-breezes of summer; overcoats are ordinarily worn in Spain and Italy till July, and are then put aside till October. Local winds form an important feature in nearly all the coast climates of the Mediterranean, especially in winter, where they are primarily caused by the rapid change of temperature from the sea to the snow-clad hinterlands. Cold dry winds, often of gale violence, occur in the Rhone valley, (the Mistral), in Istria, and in Dalmatia (the Bora), and in the western Caucasus. In summer a north-west "trade" wind, the Maestro, occurs in the Adriatic. The Sirocco is a cyclonic wind characteristic of the winter rainy season; in the Adriatic it is usually accompanied by cloud and moisture, often by rain. In Sicily and southern Italy the Sirocco occurs at all seasons; it is a dry, dusty wind from south-east or south-west. The dust is chiefly of local origin, but partly comes from the Sahara. Similar winds are met with in Spain (the Leveche), but they reach their greatest development in the Simooms of Algeria and Syria, and the Khamsin of Egypt.

Temperature.—The mean surface temperature of the waters of the Mediterranean falls from south-east, where it is over $90^{\circ} F.$, to north-west, the average at the coast of the Gulf of Lyons being 60° . The isothermal of 65° runs from Gibraltar to the north of Sardinia, and thence by the Strait of Messina to the Gulf of Corinth. A similar distribution is found 100 fathoms from the surface, temperature falling from 60° in the Levant to 55° east of Gibraltar. At 200 fathoms temperature falls in the same way from 58° to 55° , but below 250 fathoms temperatures are practically uniform to the bottom, 55° in the western basin and 56° – 5° in the eastern. The bottom temperature observed in the Pola Deep was $56^{\circ} 3'$.

Salinity.—In the extreme west the salinity of the surface water is about 36.3 per mille, and it increases eastwards to 37.6 east of Sardinia and 39.0 and upwards in the Levant. Observations of salinity in the depths of the western Mediterranean are very deficient, but the surface water is probably between 38.0 and 38.5. In the eastern basin the "Pola" expedition observed salinities of 38.7 to 39.0 to the east of a line joining Cape Matapan with Alexandria, and 38.2 to 38.7 to the west of it. The saltier waters apparently tend to make their way westwards close to the African coast, and at the bottom the highest salinities have been observed south of Crete. Evonitzki states that the saltiest water of the whole basin occurs in the Aegean Sea.

Circulation.—There is little definite circulation of water within the Mediterranean itself. In the straits joining it with the Atlantic and the Black Sea the fresher surface waters of these seas flow inwards to assist in making good the loss by evaporation at the surface of the Mediterranean, and in both cases dense water makes its way outwards along the bottom of the channels, the outflowing currents being less in volume and delivery than the inflowing. Elsewhere local surface currents are developed, either drifts due to the direct action of the winds, or streams produced by wind action heaping water up against the land; but these nowhere rise to the dignity of a distinct current system, although they are often sufficient to obliterate the feeble tidal action characteristic of the Mediterranean. Dr Natterer, the chemist of the "Pola" expeditions, has expressed the opinion that the poverty of the pelagic fauna is solely due to the want of circulation in the depths.

Deposits.—A great part of the bottom of the Mediterranean is covered with blue muds, frequently with a yellow upper layer containing a considerable proportion of carbonate of lime, chiefly shells of pelagic Foraminifera. In many parts, particularly in the eastern basin, a calcareous or siliceous crust, from half an inch to three inches in thickness, is met with; and Natterer suggested that the formation of this crust may be due to the production of carbonate of ammonium where deposits containing organic matter are undergoing oxidation, and the consequent precipitation of carbonate of lime and other substances from the waters nearer the surface. This view, however, has not met with general acceptance. (H. N. D.)

MEDIUM, primarily a person through whom, as an intermediate, communication is deemed to be carried on between living men and spirits of the departed, according to the spiritistic hypothesis; such a person is better termed sensitive or automatist. The phenomena of mediumship fall into two classes, (1) "physical phenomena" (*q.v.*) and (2) trance and automatic phenomena (utterances, script, &c.); both these may be manifested by the same person, as in the case of D. D. Home and Stainton Moses, but are often independent.

I. No sufficient mass of observations is to hand to enable us to distinguish between the results of trickery or hallucination on the one hand, and genuine supernormal phenomena on the other; but the evidence for raps and lights is good; competent observers have witnessed supposed materializations and there is respectable evidence for movements of objects.

Mediumship in the modern sense of the term may be said to have originated with the Rochester rappings of 1848 (see **SPIRITUALISM**); but similar phenomena had been reported by such authors as Apollonius of Tyana; they figure frequently in the lives of the saints; and the magician in the lower stages of culture is in many respects a counterpart of the white medium. Among physical mediums who have attained celebrity may be mentioned D. D. Home (*q.v.*), Stainton Moses and Eusapia Palladino; the last has admittedly been fraudulent at times, but no deceit was ever proved of Home; Stainton Moses sat in a private circle and no suspicion of his good faith was ever aroused.

W. Stainton Moses (1839-1892) was a man of university education, a clergyman and a schoolmaster. In 1872 he became interested in spiritualism and soon began to manifest mediumistic phenomena, which continued for some ten years. These included, besides trance communications, raps, telekinesis, levitation, production of lights, perfumes and musical sounds, apports and materialized hands. But the conditions under which the experiments were tried were not sufficiently rigid to exclude the possibility of normal causes being at work; for no amount of evidence that the normal life is marked by no lapse from rectitude affords a presumption that uprightness will characterize states of secondary personality.

Eusapia Palladino has been observed by Sir O. Lodge, Professor Richet, F. W. H. Myers, and other eminent investigators; the first named reported that none of the phenomena in his presence went beyond what could be accomplished in a normal manner by a free and uncontrolled person; but he was convinced that movements were produced without apparent contact. Among other phenomena asserted to characterize the mediumship of Eusapia are the production of temporary prolongations from the medium's body; these have been seen in a good light by competent witnesses. It was shown in some sittings held at Cambridge in 1895 that Eusapia produced phenomena by fraudulent means; but though the evidence of this is conclusive it has not been shown that her mediumship is entirely fraudulent. Automatic records of seances can alone solve the problems raised by physical mediumship. It has been shown in the Davey-Hodgson experiments that continuous observation, even for a short period, is impossible, and that in the process of recording the observations many omissions and errors are inevitable. Even were it otherwise, no care could provide against the possibility of hallucination.

II. The genuineness of trance mediumship can no longer be called in question. The problem for solution is the source of the information. The best observed case is that of Mrs Piper of Boston; at the outset of her career, in 1884, she did not differ

from the ordinary American trance medium. In 1885 the attention of Professor William James of Harvard was attracted to her; and for twenty years she remained under the supervision of the Society for Psychical Research. During that period three phases may be distinguished: (1) 1884-1891, trance utterances of a "control" calling himself Dr Phinuit, a French physician, of whose existence in the body no trace can be found; (2) 1892-1896, automatic writing by a "control" known as "George Pelham," the pseudonym of a young American author; (3) 1896 onwards, supervision by "controls" purporting to be identical with those associated with Stainton Moses. There is no evidence for regarding Mrs Piper as anything but absolutely honest. Much of the Piper material remains unpublished, partly on account of its intimate character. Many of those to whom the communications were made have been convinced that the "controls" are none other than discarnate spirits. Probably no absolute proof of identity can be given, though the reading of sealed letters would come near it; these have been left by more than one prominent psychical researcher, but so far the "controls" who claim to be the writers of them have failed to give their contents, even approximately.

Professor Flournoy has investigated a medium of very different type, known as Hélène Smith; against her good faith nothing can be urged, but her phenomena—trance utterance and glossolalia—have undoubtedly been produced by her own mind. These represent her to be the reincarnation of a Hindu princess, and of Marie Antoinette among others, but no evidence of identity has been produced. The most striking phenomenon of her trance was the so-called Martian language, eventually shown by analysis to be a derivative of French, comparable to the languages invented by children in the nursery, but more elaborate.

AUTHORITIES.—F. W. H. Myers, *Human Personality*; F. Podmore, *Modern Spiritualism*; the *Proceedings and Journal of the Society for Psychical Research*, *passim*; for a convenient survey of the Piper case, see F. Sæge, *Madame Piper*; J. Maxwell, *Les Phénomènes psychiques* (1903; Eng. trans. 1905); Th. Flournoy, *Des Indes à la planète Mars*. For fraudulent methods, see *Confessions of a Medium* (London, 1882); Truesdell, *Bottom Facts of Spiritualism*, and works cited by Myers, II., 502-503. (N. W. T.)

MEDJIDE, or MEJJDIE, the name of a military and knightly order of the Turkish Empire, and also of a silver Turkish coin, worth twenty piastres. The coin was first struck in 1844, and the order was instituted in 1852 by the sultan Abd-ul-Mejid, whose name was therefore given to them. (See **KNIGHTHOOD AND CHIVALRY**: § *Orders of Knighthood*.)

MEDLAR, *Mespilus germanica*, a tree of the tribe *Pomeae* of the order *Rosaceae*, closely allied to the genus *Pyrus*, in which it is sometimes included; it is a native of European woods, &c., from Holland southwards, and of western Asia. It occurs in hedges, &c., in middle and south England, as a small, much-branched, deciduous, spinous tree, but is not indigenous. The medlar was well known to the ancients. Pickering (*Chron. Hist. Pl. p. 201*) identifies it with a tree mentioned in a Siao-ya ode (*She-King*, ii. 1, 2), 827 B.C. It is the *μειλίδη* of Theophrastus and *Mespilus* of Pliny. The Latin *mespilus* or *mespilum* became in Old French *mesle* or *medle*, "the fruit," *meslier*, *medlier*, "the tree." The modern French *néfle* is from a corruption *nespilum* of the Latin. The German *Mispel* preserves the original more closely. The well-known fruit is globular, but depressed above, with leafy persistent sepals, and contains stones of a hemispherical shape. It is not fit to eat until it begins to decay and becomes "bletted," when it has an agreeable acid and somewhat astringent flavour. Several varieties are known in cultivation. The large Dutch medlar, which is very widely cultivated, has a naturally crooked growth; the large, much-flattened fruit is inferior in quality to the Nottingham, which is a tree of upright habit with fruits of about 1 in. diameter, superior to any other variety. There is also a stoneless variety with still smaller fruits, but the quality is not so good.

The medlar is propagated by budding or grafting upon the white-thorn, which is most suitable if the soil is dry and sandy, or on the quince if the soil is moist; the pear stock also succeeds

well on ordinary soils. It produces the best fruit in rich, loamy, somewhat moist ground. The tree may be grown as a standard, and chiefly requires pruning to prevent the branches from rubbing each other. The fruit should be gathered in November, on a dry day, and laid out upon shelves. It becomes "bletted" and fit for use in two or three weeks. The Japanese medlar is *Eriobotrya japonica* (see LOQUAT), a genus of the same tribe of Rosaceae.

MÊDOC, a district in France adjoining the left bank of the Gironde from Blanquefort (N. of Bordeaux) to the mouth of the Gironde. Its length is about 50 m., its breadth averages between 6 and 7 m. It is formed by a number of low hills, which separate the Landes from the Gironde, and is traversed only by small streams; the Gironde itself is muddy, and often enveloped in fog, and the region as a whole is far from picturesque. Large areas of its soil are occupied by vineyards, the products of which form the finest growths of Bordeaux. (See WINE.)

MEDUSA, the name given by zoologists to the familiar marine animals known popularly as jelly-fishes; or, to be more accurate, to those jelly-fishes¹ in which the form of the body resembles that of an umbrella, bell or parachute. The name medusa is suggested by the tentacles, usually long and often numerous, implanted on the edge of the umbrella and bear the stinging organs of which sea-bathers are often disagreeably aware. The tentacles serve for the capture of prey and are very contractile, being often protruded to a great length or, on the other hand, retracted and forming corkscrew-like curls. Hence the animals have suggested to vivid imaginations the head of the fabled Gorgon or Medusa with her *chevelure* of writhing snakes.

The medusa occurs as one type of individual in the class Hydrozoa (*q.v.*), the other type being the polyp (*q.v.*). In a typical medusa we can distinguish the following parts. The umbrella-like body bears a circle of tentacles at the edge, whereby the body can be divided into a convex *exumbrella* or exumbrellar surface and a concave *subumbrella* or subumbrellar surface. The vast majority of jelly-fish float in the sea, with the exumbrella upwards, the subumbrella downwards. A few species, however, attach themselves temporarily or permanently to some firm object by the exumbrellar surface of the body, and then the subumbrellar surface is directed upwards. From the centre of the subumbrellar surface hangs down the *manubrium*, like the handle of an umbrella or the clapper of a bell, bearing the mouth at its extremity. In addition to the tentacles, the margin of the umbrella bears sense-organs, which may be of several kinds and may attain a high degree of complexity.

Medusae capture their prey, consisting of small organisms of various kinds, especially Crustacea, by means of the tentacles which hang out like fishing-lines in all directions. When the prey comes into contact with the tentacles it is paralysed, and at the same time held firmly, by the barbed threads shot out from the stinging organs or nematocysts. Then by contraction of the tentacles the prey is drawn into the mouth. Medusae thus form an important constituent of the plankton or floating fauna of the ocean, and compete with fish and other animals for the food-supply furnished by minuter forms of life.

A medusa has a layer of muscles, more or less strongly developed, running in a circular direction on the surface of the subumbrella, the contractions of which are antagonized by the elasticity of the gelatinous substance of the body. By the contraction of the subumbrellar circular muscles the concavity of the subumbrella is increased, and as water is thereby forced out of the subumbrellar cavity the animal is jerked upwards. In this way jelly-fish progress feebly by the pumping movements of the umbrella. Besides the circular subumbrellar muscles, there may be others running in a radial direction, chiefly developed as the longitudinal retractor muscles of the manubrium. In some cases the circular subumbrellar muscles form a rim known as the *velum* (*v.*, see fig. 1), projecting into the subumbrellar cavity just within the ring of marginal tentacles. The two principal

divisions of the medusae are characterized by the presence or absence of a velum.

Correlated with the well-developed muscular system and sense-organs of the medusa, we find also a distinct nervous system, either, when there is no velum, in the form of concentrations of nervous matter in the vicinity of each sense-organ, or, when a velum is present, as two continuous rings running round the margin of the umbrella, one external to the velum (exumbrellar nerve-ring, *nr.*¹, see fig. 1), the other internal to it (subumbrellar nerve-ring, *nr.*²). The exumbrellar nerve-ring is the larger and supplies the tentacles; the subumbrellar ring supplies the velum.

Every possible variety of body-form compatible with the foregoing description may be exhibited by different species of medusae. The body may show modifications of form which can be compared to a shallow saucer, a cup, a bell or a thimble. The marginal tentacles may be very numerous or may be few in number or even absent altogether; and they may be simple filaments, or branched in a complicated manner. The manubrium may be excessively long, or very short, and in rare cases absent, the mouth then being flush with the subumbrellar surface. The mouth may be circular or four-cornered, and in the latter case the manubrium at the angles of the mouth may become drawn out into four lappets, the oral arms, each with a groove on its inner side continuous with the corner

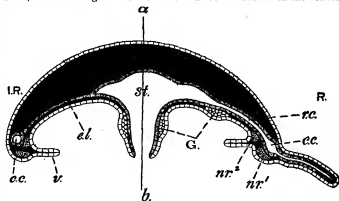

FIG. 1.

Diagram of the structure of a medusa; the ectoderm is left clear, the endoderm is dotted, the mesogloea is shaded black; a-b, principal axis (see HYDROZOA); to the left of this line the section is supposed to pass through an inter-radius (I.R.); to the right through a radius (R). The exumbrellar surface is uppermost, the subumbrellar surface, with the manubrium and mouth, is facing downwards.

St. Stomach.	G. Gonads.
r.c. Radial canal.	nr. ¹ Exumbrellar (so-called upper) nerve-ring.
c.c. Circular or ring-canal.	nr. ² Subumbrellar (so-called lower) nerve-ring.
e.l. Endoderm-lamella.	
v. Velum.	

(For other figures of medusae see HYDROZOA.)

of the mouth. The oral arms are the starting-point of a further series of variations; they may be simple flaps, crinkled and folded in various ways, or they may be subdivided, and then the branches may simulate tentacles in appearance. In the genus *Rhizostoma*, common on the British coasts and conspicuous on account of its large size, the oral arms, originally distinct and four in number, undergo concretion, so that the entrance to the mouth is reduced to numerous fine pores and canals.²

Like the external structure, the internal anatomy of the medusa shows a complete radial symmetry, and is simple in plan but often complicated in detail (see fig. 1). As in all Hydrozoa (*q.v.*) the body wall is composed of two cell-layers, the ectoderm and endoderm, between which is a structureless gelatinous secreted layer, the mesogloea. As the name jelly-fish implies, the mesogloea is greatly developed and abundant in quantity. It may be traversed by processes of the cells of the ectoderm and endoderm, or it may contain cells which have migrated into it from these two layers. The ectoderm covers the whole external surface of the animal, while the endoderm lines the coelenteron or gastrovascular space; the two layers meet each other, and become continuous, at the edge of the mouth.

The mouth leads at once into the true digestive cavity, divisible into an oesophageal region in the manubrium and a more dilated cavity, the stomach (*st.*), occupying the centre of the umbrella. From the stomach, canals arise termed the radial canals (*r.c.*); typically four in number, they run in a radial direction to the edge

¹ The gooseberry-like or band-shaped jelly-fishes belong to the class Ctenophora (*q.v.*).

² For other variations of the medusa, often of importance for systematic classification, see HYDROMEDUSÆ and SCYPHOMEDUSÆ.

of the umbrella. There the radial canals are joined by a ring-canal (c.c.) which runs round the margin of the umbrella. From the ring-canal are given off tentacle-canals which run down the axis of each tentacle; in many cases, however, the cavity of the tentacle is obliterated and instead of a canal the tentacle contains a solid core of endoderm. Oesophagus, stomach, radial canals, ring-canal and tentacle-canals, constitute together the gastro-vascular system and are lined throughout by endoderm, which forms also a flat sheet of cells connecting the radial canals and ring canal together like a web; this is the so-called *endoderm-lamella* (e.l.), a most important feature of medusan morphology, the nature of which will be apparent when the development is described. As a general rule the mouth is the only aperture of the gastrovascular system; in a few cases, however, excretory pores are found on the ring-canal, but there is never any anal opening.

The sense-organs of medusae are of two classes: (1) pigment spots, sensitive to light, termed *ocelli*, which may become elaborated into eye-like structures with lens, retina and vitreous body; (2) organs of the sense of balance or orientation, commonly termed *statocysts* or *statocysts*. The sense-organs are always situated at the margin of the umbrella and may be distinguished from the morphological point of view into two categories, according as they are, or are not, derived from modifications of tentacles; in the former case they are termed *tentaculocysts*. (For fuller information upon the sense-organs see HYDROMEDUSAE.)

Medusae are nearly always of separate sexes, and instances of hermaphroditism are rare. The gonads or generative organs may be produced either in the ectoderm or the endoderm. The gonads are either adoral, the lobes formed on the floor of the stomach; when ectodermal (G, see fig. 1), they are formed on the subumbrellar surface, either on the manubrium or under the stomach or under the radial canals, or in more than one of these regions. Medusae often have the power of budding, and the buds are formed either on the manubrium, or at the margin of the umbrella, or on an outgrowth or "stolon" produced from the exumbrellar surface.

The internal anatomy of the medusa is as variable as its external features. The mouth may lead directly into the stomach, without any oesophagus. The stomach may be situated in the disk or may be drawn out into the base of the manubrium, so that the disk is occupied only by the radial canals. On the other hand the stomach may have lobes extending to the ring-canal, so that radial canals may be very short or absent. The radial canals may be four, rarely six, or a multiple of these numbers, and may be very numerous. They may be simple or branched. (For other anatomical variations see HYDROMEDUSAE and SCYPHOMEDUSAE.)

In development the medusa can be derived easily by a process of differential growth, combined with concrescence of cell-layers, from the actinular larva. (For figures see HYDROZOA.) The exumbrellar surface is like a sack-like or rounded web, a crown of tentacles surrounds a wide peristome, in the centre of which is the mouth, usually raised on a conical process termed the hypostome. To produce a medusa the actinula grows gently along a plane at right angles to the vertical axis of the body, whereby the aboral surface of the actinula becomes the exumbrella, and the peristome becomes the subumbrella. The crown of tentacles thus comes to form a fringe to the margin of the body, and the hypostome becomes the manubrium. As a result of this change of form the gastric cavity or coelenteron becomes of compressed lenticular form, and the endoderm lining it can be distinguished as an upper epidermal layer and a lower or subumbrellar layer. The next event is a great growth in thickness of the gelatinous mesoglea, especially on the exumbrellar side; as a result the flattened coelenteron is still further compressed so that in certain spots its cavity is obliterated, and its exumbrellar and subumbrellar layers of endoderm come into contact and undergo concrescence. As a rule four such areas of concrescence or *cathammata* (E. Haeckel) are formed. The cathammal areas may remain very small, mere wedge-shaped partitions dividing up the coelenteron into a four-lobed stomach, the lobes of which communicate at the periphery of the body by a spacious ring-canal. More usually each cathamma is a wide triangular area, reducing the peripheral portion of the coelenteron to the four narrow radial canals and the ring-canal above described. The two opposed layers of endoderm in the cathammal area undergo complete fusion to form a single layer of epithelium, the endoderm-lamella of the adult medusa.

Medusae, when they reproduce themselves by budding, always produce medusae, but when they reproduce by the sexual method the embryos produced from the egg grow into medusae in some cases, in other cases into polyps which bud medusae in their turn. In this way complicated cycles of alternating generations arise, which are described fully in HYDROMEDUSAE and SCYPHOMEDUSAE.

Medusae are exclusively aquatic animals and for the most part marine, but at least two fresh-water species are known.¹ *Limnocoedium soeverbyi* was first discovered swimming in the tank in which the water-lily, *Victoria regia*, is cultivated in Kew Gardens, and

has since been found sporadically in a similar situation in other botanical gardens, its most recent appearance being at Lille. These jelly-fishes are probably budded from a minute poly-stock introduced with the roots of the lily. Another fresh-water form is *Limnocoedium tanganyika*, discovered first in lake Tanganyika, and now known to occur also in the Victoria Nyanza and in the Niger. A medusa with a remarkable habit of life is *Musista parasitica*, which is parasitic on the pelagic mollusc *Phylitroche*, attaching itself to the host by its subumbrellar surface; its tentacles, no longer required for obtaining food, have become rudimentary. A parasitic mode of life is also seen in medusae of the genus *Cusma* during the larval condition, but the habit is abandoned, in this case, when the medusae become adult.

For figures of medusae see (1) E. Haeckel, "Das System der Medusen," *Denkschriften med-naturwiss. Ges. Jena* (1870, 2 vols.); (2) Id., "Deep-Sea Medusae," *Challenger Reports*, Zoology, IV, pt. II, (1882); (3) O. Maas, "Die Craspedoten Medusen," *Ergebn. Antk.-Exp.-Exp.*, II, (1893); (4) Id., "Die Medusen," *Mem. Mus. Comp. Zool. Harvard*, XXIII, (1897); (5) G. J. Allman, "A Monograph of the Gymnoblasic or Tubularian Hydroids," *Ray. Soc.* (1871-1872). (E. A. M.)

MEDWAY, a river in the south-east of England. It rises in the Forest Ridges, S.W. of East Grinstead in Sussex, and, increased by many feeders from these picturesque hills, has an easterly course to the county boundary, which it forms, turning northward for a short distance. Entering Kent near Ashurst, its course becomes north-easterly, and this direction is generally maintained to the mouth. The river passes Tonbridge, receiving the Eden from the west, and later the Teise and Beult from the south and east, all these streams watering the rich Weald (q.v.) to the south of the North Downs. These hills are breached by the Medway in a beautiful valley, in which lies Maidstone, generally much narrower than the upper valley. The characteristic structure of this part of the valley is considered under the heading **DOWN**. Below Maidstone the valley forms a perfect basin, the hills descending upon it closely above Rochester. Below this city the river enters a broad, winding estuary, passing Chatham, and at Sheerness joining that of the Thames, so that the Medway may be considered a tributary, and its drainage area of 680 sq. m. reckoned as part of that of the greater river. The length of the Medway is about 60 m., excluding its many lesser windings. The estuary is navigable for sea-going vessels drawing 24 ft. up to Rochester Bridge. A considerable traffic is carried on by small vessels up to Maidstone, and by barges up to Tonbridge, the total length of the navigation being 43 m. The marshy lowlands along the course of the river have yielded extensive remains of Roman pottery, a plain ware of dark slate-colour.

MEERAN, or MIANI, a village in Sind, India, on the Indus 6 m. N. of Hyderabad. Pop. (1901), 962. It is famous as the scene of the battle in which Sir Charles Napier, with only 2800 men, broke the power of the mirs of Sind on the 17th of February 1843. The result of this victory was the conquest and annexation of Sind.

MEEK, FIELDING BRADFORD (1817-1876), American geologist and palaeontologist, the son of a lawyer, was born at Madison, Indiana, on the 10th of December 1817. In early life he was in business as a merchant, but his leisure hours were devoted to collecting fossils and studying the rocks of the neighbourhood of Madison. Being unsuccessful in business he turned his whole attention to science, and in 1848 he gained employment on the U.S. Geological Survey in Iowa, and subsequently in Wisconsin and Minnesota. In 1852 he became assistant to Professor James Hall at Albany, and worked at palaeontology with him until 1858. Meanwhile in 1853 he accompanied Dr F. V. Hayden in an exploration of the "Bad Lands" of Dakota, and brought back valuable collections of fossils. In 1858 he went to Washington, where he devoted his time to the palaeontological work of the United States geological and geographical surveys, his work bearing "the stamp of the most faithful and conscientious research," and raising him to the highest rank as a palaeontologist. Besides many separate contributions to science, he prepared with W. M. Gabb (1839-1878), two volumes on the palaeontology of California (1864-1869); and also a *Report on the Invertebrate Cretaceous and Tertiary Fossils of the Upper Missouri Country* (1876). He died at Washington, on the 22nd of December 1876.

¹ C. L. Boulenger (*Proc. Zool. Soc. of London*, 1907, p. 516) recorded the discovery of a third species by himself and W. A. Cunningham, in the brackish water of lake Birket el Kerun in the Egyptian Fayum.

MEER, JAN VAN DER (1632-1675), more often called Vermeer of Delft—not to be confounded with the elder (1628-1691) or younger (1656-1705) Van der Meer of Haarlem, or with Van der Meer of Utrecht—is one of the excellent Dutch painters about whom the Dutch biographers give us little information.¹ Van der Meer, or Vermeer, was born in Delft, and was a pupil of Carel Fabritius, whose junior he was by only eight years. The works by Fabritius are few, but his contemporaries speak of him as a man of remarkable power, and the paintings now ascertained to be from his hand, and formerly ascribed to Rembrandt, prove him to have been deeply imbued with the spirit and manner of that master. Whether Van der Meer had ever any closer relation to Rembrandt than through companionship with Fabritius remains uncertain. In 1653 he married Catherine Bolenes, and in the same year he entered the gild of St Luke of Delft, becoming one of the heads of the gild in 1662 and again in 1670. He died at Delft in 1675, leaving a widow and eight children. His circumstances cannot have been flourishing, for at his death he left twenty-six pictures undisposed of, and his widow had to apply to the court of insolvency to be placed under a curator, who was Leeuwenhoek, the naturalist.

For more than two centuries Van der Meer was almost completely forgotten, and his pictures were sold under the names and forged signatures of the more popular De Hooch, Metsu, Ter Borch, and even of Rembrandt. The attention of the art-world was first recalled to this most original painter by Thoré, an exiled Frenchman, who described his then known works in *Musées de la Hollande* (1858-1860), published under the assumed name of W. Bürger. The result of his researches, continued in his *Galerie Suermont* and *Galerie d'Arenberg*, was afterwards given by him in a charming, though incomplete, monograph (*Gazette des beaux-arts*, 1866, pp. 297, 458, 542). The task was prosecuted with success by Havard (*Les Artistes hollandais*), and by Obreen (*Nederlandsche Kunstgeschiedenis*, Dl. iv.), and we are now in a position to refer to Van der Meer's works. His pictures are rarely dated, but one of the most important, in the Dresden Gallery, bears the date 1656, and thus gives us a key to his styles. With the exception of the "Christ with Martha and Mary" in the Coats collection at Glasgow, it is perhaps the only one, hitherto recognized, that has figures of life size, though his authorship is claimed for several others. The Dresden picture of a "Woman and Soldier," with other two figures, is painted with remarkable power and boldness, with great command over the resources of colour, and with wonderful expression of life. For strength and colour it more than holds its own beside the neighbouring Rembrandts. To this early period of his career belong, from internal evidence, the "Reading Girl" of the same gallery, the luminous and masterly "View of Delft" in the museum of the Hague, the "Milk-Woman" and the small street view, both identified with the Six collection at Amsterdam, the former now in the Rijksmuseum; the magnificent "The Letter" also at Amsterdam, "Diana and the Nymphs" (formerly ascribed to Vermeer of Utrecht) at the Hague Gallery, and others. In all these we find the same brilliant style and vigorous work, a solid impasto, and a crisp, sparkling touch. His first manner seems to have been influenced by the pleiad of painters circling round Rembrandt, a school which lost favour in Holland in the last quarter of the century. During the final ten or twelve years of his life Van der Meer adopted a second manner. We now find his painting smooth and thin, and his colours paler and softer. Instead of masculine vigour we have refined delicacy and subtlety, but in both styles beauty of tone and perfect harmony are conspicuous. Through all his work

may be traced his love of lemon-yellow and of blue of all shades. Of his second style typical examples are to be seen in "The Coquette" of the Brunswick Gallery, in the "Woman Reading" in the Van der Hoop collection now at the Rijksmuseum at Amsterdam, in the "Lady at a Casement" belonging to Lord Powerscourt (exhibited at the Royal Academy, 1878) and in the "Music Master and Pupil" belonging to the King (exhibited at the Royal Academy, 1876).

Van der Meer's authentic pictures in public and private collections amount to about thirty. There is but one in the Louvre, the "Lace Maker"; Dresden has the two aforementioned, while Berlin has three, all acquired in the Suermont collection, and the Czernin Gallery of Vienna is fortunate in possessing a fine picture, believed to represent the artist in his studio. In the Arenberg Gallery at Brussels there is a remarkable head of a girl, half the size of life, which seems to be intermediate between his two styles. Several of his paintings are in private foreign collections. In all his work there is a singular completeness and charm. His tone is usually silvery with pearly shadows, and the lighting of his interiors is equal and natural. In all cases his figures seem to move in light and air, and in this respect he resembles greatly his fellow-worker De Hooch. It is curious to read that, at one of the auctions in Amsterdam about the middle of the 18th century, a De Hooch is praised as being "nearly equal to the famous Van der Meer of Delft."

See also Havard, *Van der Meer* (Paris, 1888); Vanzyer, *Vermeer de Delft* (Brussels, 1908), and Hofstede de Groot, *Jan Vermeer van Delft* (Leipzig, 1909).

MEERANE, a town in the kingdom of Saxony, 9 m. N. of Zwickau and 37 S. of Leipzig by rail. Pop. (1905), 26,005. It contains a fine medieval church (Evangelical). It is one of the most important industrial centres of Germany for the manufacture of woollen and mixed cloths, and in these products has a large export trade, especially to America and the Far East. There are also extensive dyeworks, tanneries and machine factories.

See Leopold, *Chronik und Beschreibung der Fabrik- und Handelstadt Meerane* (1863).

MEERSCHAUM, a German word designating a soft white mineral sometimes found floating on the Black Sea, and rather suggestive of sea-foam (*Meerschaum*), whence also the French name for the same substance, *écume de mer*. It was termed by E. F. Glocker septilite, in allusion to its remote resemblance to the "bone" of the sepia or cuttle-fish. Meerschaum is an opaque mineral of white, grey or cream colour, breaking with a conchoidal or fine earthy fracture, and occasionally though rarely, fibrous in texture. It can be readily scratched with the nail, its hardness being about 2. The specific gravity varies from 0.988 to 1.279, but the porosity of the mineral may lead to error. Meerschaum is a hydrous magnesium silicate, with the formula $H_2Mg_3Si_2O_{10}$, or $Mg_3Si_2O_8 \cdot 2H_2O$.

Most of the meerschaum of commerce is obtained from Asia Minor, chiefly from the plain of Eski-Shehr, on the Haidar Pasha-Angora railway, where it occurs in irregular nodular masses, in alluvial deposits, which are extensively worked for its extraction. It is said that in this district there are 4000 shafts leading to horizontal galleries for extraction of the meerschaum. The principal workings are at Sepetdji-Odjaghi and Kemikdji-Odjaghi, about 20 m. S.E. of Eski-Shehr. The mineral is associated with magnesite (magnesium carbonate), the primitive source of both minerals being a serpentine. When first extracted the meerschaum is soft, but it hardens on exposure to solar heat or when dried in a warm room. Meerschaum is found also, though less abundantly, in Greece, as at Thebes, and in the islands of Euboea and Samos; it occurs also in serpentine at Hrubcschitz near Kromau in Moravia. It is found to a limited extent at certain localities in France and Spain, and is known in Morocco. In the United States it occurs in serpentine in Pennsylvania (as at Nottingham, Chester county) and in South Carolina and Utah.

Meerschaum has occasionally been used as a substitute for soap and fuller's earth, and it is said also as a building material; but its chief use is for tobacco-pipes and cigar-holders. The

¹ This undeserved neglect seems to have fallen on him at an early period, for Houbraken (*Groote Schouburgh*, 1718), writing little more than forty years after his death, does not even mention him. The only definite information we have from a contemporary is given by Bleywyswick (*Beschrijving der Stad Delft*, 1687), who tells us that he was born in 1632, and that he worked with Carel Fabritius, an able disciple of Rembrandt, who lost his life by an explosion of a powder magazine in Delft in 1654. It is to the patient researches of W. Bürger (Th. Thoré), Havard, Obreen, Soutendam, and others, that we owe our knowledge of the main facts of his life, discovered in the archives of his native town.

natural nodules are first scraped to remove the red earthy matrix, then dried, again scraped and polished with wax. The rudely shaped masses thus prepared are sent from the East to Vienna and other manufacturing centres, where they are turned and carved, smoothed with glass-paper and Dutch rushes, heated in wax or stearine, and finally polished with bone-ash, &c. Imitations are made in plaster of Paris and other preparations.

The soft, white, earthy mineral from Långbanshyttan, in Vermland, Sweden, known as apophite (*ἀπόφως*, foam), is closely related to meerschbaum. It may be noted that meerschbaum has sometimes been called magnesite (*g.r.*).

MEERUT, a city, district and division of British India, in the United Provinces. The city is half-way between the Ganges and the Jumna, and has two stations on the North-Western railway, 37 m. N.E. from Delhi. Pop. (1901), 118,129. The city proper lies south of the cantonments, and although dating back to the days of the Buddhist emperor Asoka (c. 250 B.C.) Meerut owes its modern importance to its selection by the British government as the site of a great military station. In 1805 it is mentioned as "a ruined, depopulated town." The cantonment was established in 1806, and the population rose to 29,014 in 1847, and 82,035 in 1853. The town is an important centre of the cotton-trade. It is the headquarters of the 7th division of the northern army, with accommodation for horse and field artillery, British and native cavalry and infantry. It was here that the first outbreak of the Mutiny of 1857 took place. (See **INDIAN MUTINY**.)

The **DISTRICT OF MEERUT** forms part of the upper Doab, or tract between the Ganges and the Jumna, extending from river to river. Area, 2354 sq. m. Though well wooded in places and abundantly supplied with mango groves, it has but few patches of jungle or waste land. Sandy ridges run along the low watersheds which separate the minor channels, but with this exception the whole district is one continuous expanse of careful and prosperous tillage. Its fertility is largely due to the system of irrigation canals. The Eastern Jumna canal runs through the whole length of the district, and supplies the rich tract between the Jumna and the Hindan with a network of distributary streams. The main branch of the Ganges canal passes across the centre of the plateau in a sweeping curve and waters the midland tract. The Anpshahr branch supplies irrigation to the Ganges slope, and the Agra canal passes through the southern corner of Loni pargana from the Hindan to the Jumna. Besides these natural and artificial channels, the country is everywhere cut up by small water-courses. The Burh Ganga, or ancient bed of the Ganges, lies at some distance from the modern stream; and on its bank stood the abandoned city of Hastinapur, the legendary capital of the Pandavas at the period of the *Mahabharata*, said to have been deserted many centuries before the Christian era, owing to the encroachments of the river.

The comparatively high latitude and elevated position of Meerut make it one of the healthiest districts in the plains of India. The average temperature varies from 57° F. in January to 87° in June. The rainfall is small, less than 30 in. annually. The only endemic disease in the district is malarial fever; but small-pox and cholera occasionally visit it as epidemics. The population in 1901 was 1,540,175, showing an increase of 10.6% in the decade. The principal crops are wheat, pulse, millet, sugar-cane, cotton and indigo, but this last crop has declined of late years almost to extinction. The district is traversed by the North-Western railway, and also contains Ghaziabad, the terminus of the East Indian system, whence a branch runs to Delhi, while a branch of the Oudh & Rohilkhand railway from Moradabad to Ghaziabad was opened in 1900.

The authentic history of the district begins with the Moslem invasions. The first undoubted Mahomedan invasion was that of Kutbeddin in 1101, when Meerut town was taken and all the Hindu temples turned into mosques. In 1398 Timūr captured the fort of Loni after a desperate resistance, and put all his Hindu

prisoners to death. He then proceeded to Delhi, and after his memorable sack of that city returned to Meerut, captured the town, razed all the fortifications and houses of the Hindus, and put the male inhabitants to the sword. The establishment of the great Mogul dynasty in the 16th century, under Baber and his successors, gave Meerut a period of internal tranquillity and royal favour. After the death of Aurangzeb, however, it was exposed to alternate Sikh and Mahrattā invasions. From 1707 till 1775 the country was the scene of perpetual strife, and was only rescued from anarchy by the exertions of the military adventurer Walter Reinhardt, afterwards the husband of the celebrated Begum Samru, who established himself at Sardhana in the north, and ruled a large estate. The southern tract, however, remained in its anarchic condition under Mahrattā exactions until the fall of Delhi in 1803, when the whole of the country between the Jumna and the Ganges was ceded by Sindhia to the British. It was formed into a separate district in 1818. In the British period it has become memorable for its connexion with the Mutiny of 1857.

The **DIVISION OF MEERUT** comprises the northern portion of the Doab. It consists of the six districts of Dehra Dun, Saharanpur, Muzaffarnagar, Meerut, Bulandshahr and Aligarh. Area, 11,302 sq. m.; pop. (1901), 5,979,711, showing an increase of 12.3% in the decade.

See *Meerut District Gazetteer* (Allahabad, 1904).

MEETING (from "to meet," to come together, assemble, O. Eng. *mētan*; cf. Du. *moeten*, Swed. *möta*, Goth. *gomotjan*, &c., derivatives of the Teut. word for a meeting, seen in O. Eng. *mōt*, moot, an assembly of the people; cf. *wilamagemot*), a gathering together of persons for the purpose of discussion or for the transaction of business. Public meetings may be either those of statutory bodies or assemblies of persons called together for social, political or other purposes. In the case of statutory bodies, by-laws usually fix the quorum necessary to constitute a legal meeting. That of limited companies may be either by reference to the capital held, or by a fixed quorum or one in proportion to the number of shareholders. It has been held that in the case of a company it takes at least two persons to constitute a meeting (*Sharp v. Daws*, 1886, 2 Q.B.D. 26). In the case of public meetings for social, political or other purposes no quorum is necessary. They may be held, if they are for a lawful purpose, in any place, on any day and at any hour, provided they satisfy certain statutory provisions or by-laws made under the authority of a statute for the safety of persons attending such meetings. If, however, a meeting is held in the street and it causes an obstruction those convening the meeting may be proceeded against for obstructing the highway. The control of a meeting and the subjects to be discussed are entirely within the discretion of those convening it, and whether the meeting is open to the public without payment, or subject to a charge or to membership of a specified body or society, those present are there merely by virtue of a licence of the conveners, which licence may be revoked at any time. The person whose licence is revoked may be requested to withdraw from the meeting, and on his refusal may be ejected with such force as is necessary. If he employs violence to those removing him he commits a breach of the peace for which he may be given into custody. An important English act has dealt for the first time with the disturbance of a public meeting. The Public Meeting Act 1908 enacted that any person who at a lawful public meeting acts in a disorderly manner for the purpose of preventing the transaction of the business for which the meeting was called together shall be guilty of an offence, and if the offence is committed at a political meeting held in any parliamentary constituency between the issue and return of a writ, the offence is made an illegal practice within the meaning of the Corrupt and Illegal Practices Prevention Act 1883. Any person who incites another to commit the offence is equally guilty. A public meeting is usually controlled by a chairman, who may be appointed by the conveners or elected by the meeting itself. On the chairman falls the duty of preserving order, of calling on persons to speak, deciding points of order, of putting questions to the meeting

for decision, and declaring the result and other incidental matters.

In England it is illegal, by a statute of George III. (Seditious Meetings Act 1817), to hold a public meeting in the open air within 1 m. of Westminster Hall during the sitting of Parliament.

See C. P. Blackwell's *Law of Meetings* (1910).

MEGALOPOLIS, an ancient city of Arcadia, Greece, situated in a plain about 20 m. S.W. of Tegea, on both banks of the Helisson, about 2½ m. above its junction with the Alpheus. Like Messene, it owed its origin to the Theban general Epaminondas, and was founded in 370 B.C., the year after the battle of Leuctra, as a bulwark for the southern Arcadians against Sparta, and as the seat of the Arcadian Federal Diet, which consisted of ten thousand men. The builders were protected by a Theban force, and directed by ten native oecists (official "founders"),

an attempt to reduce Megalopolis; but the Thebans sent assistance and the city was rescued. Not sure of this assistance, the Megalopolitans had appealed to Athens, an appeal which gave occasion to the oration of Demosthenes, *Περὶ Μεγαλοπολιτῶν*. The Spartans were now obliged to conclude peace with Megalopolis and acknowledge her autonomy. Nevertheless their feeling of hostility did not cease, and Megalopolis consequently entered into friendly relations with Philip of Macedon. Twenty years later, when the Spartans and their allies rebelled against the power of Macedon, Megalopolis remained firm in its allegiance, and was subjected to a long siege. After the death of Alexander, Megalopolis was governed by native tyrants. In the war between Cassander and Polyperchon it took part with the former and was besieged by the latter. On this occasion it was able to send into the field an army of fifteen thousand.

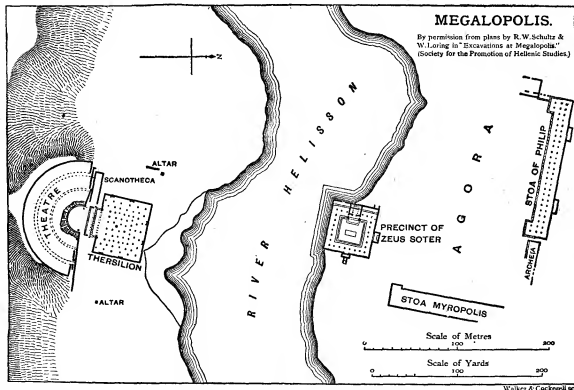

who likewise attended to the peopling of the new city, which apparently drew inhabitants from all parts of Arcadia, but especially from the neighbouring districts of Maenalia and Parrhasia. Forty townships are mentioned by Pausanias (viii. 27, 3-5) as having been incorporated in it. It was 50 stadia in circumference, and was surrounded with strong walls. Its territory was the largest in Arcadia, extending northward 24 m. The city was built on a magnificent scale, and adorned with many handsome buildings, both public and private. Its temples contained many ancient statues brought from the towns incorporated in it. After the departure of Epaminondas, Lycomedes of Mantinea succeeded in drawing the Arcadian federation away from its alliance with Thebes, and it was consequently obliged to make common cause with Athens. An attempt on the part of the federation to use the treasures of the temple of Zeus at Olympia led to internal dissensions, so that in the battle of Mantinea (362) one half of the Arcadians fought on the side of the Spartans, the other on that of the Thebans. After this battle many of the inhabitants of Megalopolis sought to return to their former homes, and it was only by the assistance of three thousand Thebans under Pammenes that the authorities were able to prevent them from doing so. In 353, when Thebes had her hands full with the so-called Sacred War, the Spartans made

In 234 B.C. Lydiades, the last tyrant of Megalopolis, voluntarily resigned his power, and the city joined the Achaean League. In consequence of this it was again exposed to the hatred of Sparta. In 222 Cleomenes plundered it and killed or dispersed its inhabitants, but in the year following it was restored and its inhabitants reinstated by Philopoemen, a native of the city. After this, however, it gradually sank into insignificance. The only great men whom it produced were Philopoemen and Polybius the historian. Lycortas, the father of the latter, may be accounted a third. In the time of Pausanias the city was mostly in ruins.

The site of Megalopolis was excavated by members of the British School at Athens in the years 1800-1802. The description of Pausanias is so clear that it enabled Curtius, in his *Peloponnesos*, to give a conjectural plan that was found to tally in most respects with the reality. The town was divided into two approximately equal parts by the river Helisson, which flows through it from east to west. The line of the walls may be traced, partly by remains, partly by the contours it must have followed, and confirms the estimate of Polybius that they had a circuit of 50 stades, or about 5½ m. It is difficult to see how the river bed, now a broad and shingly waste, was dealt with in ancient times; it must have been embanked in some way, but there are no remains to show whether the fortification wall

was carried across the river at either end or along the parallel embankments so as to make two separate enclosures. There must have been, in all probability, a bridge to connect the two halves of the city, but the foundations seen by Leake and others, and commonly supposed to belong to such a bridge, proved to be only the substructures of the precinct of Zeus Soter. The buildings north of the river were municipal and were grouped round the square agora. One, of which the complete plan has been recovered, is the portico of Philip, a splendid building, which bounded the agora on the north; it was 300 ft. long, with three rows of columns running its whole length, three in the outer line to each one in the two inner lines; it had a slightly projecting wing at either end. At the south-west of the agora was found the precinct of Zeus Soter; it consists of a square court surrounded by a double colonnade, and faced on the west side by a small temple; on the east side was an entrance or propylaeum approached by a ramp. In the midst of the court was a substructure which has been variously interpreted as an altar or as the base of the great group of Zeus and Megalopolis, which is recorded to have stood here. North of this was the Stoa Myropolis, forming the east boundary of the agora, and, between this and the Stoa of Philip, the Archaia or municipal offices. These buildings were of various dates, but seem all to fit into an harmonious plan. The buildings on the south and west of the agora have been almost entirely destroyed by the Hellisdon and a tributary brook. On the south bank of the river were the chief federal buildings, the theatre (noted by Pausanias as the largest in Greece), and the Thersilion or parliament hall of the ten thousand Arcadians. These two buildings form part of a common design, the great portico of the Thersilion facing the orchestra of the theatre. As a consequence of this arrangement, the plan of the theatre is abnormal. The auditorium has as its lowest row of seats a set of "thrones" or ornamental benches, which, as well as the gutter in front, were dedicated by a certain Antiochus; the orchestra is about 100 ft. in diameter; and in place of the western *parados* is a closed room called the *Scanotheca*. The chief peculiarity, however, lies in the great portico already mentioned, which has its base about 4 ft. 6 in. above the level of the orchestra. It was much too lofty to serve as a proscenium; yet, if a proscenium of the ordinary Greek type were erected in front, it would hide the lower part of the columns. Such a proscenium was actually erected in later times; and beneath it were the foundations for an earlier wooden proscenium, which was probably erected only when required. In later times steps were added, leading from the base of the portico to the level of the orchestra. The theatre was probably used, like the theatre at Athens, for political assemblies; but the adjoining Thersilion provided covered accommodation for the Arcadian ten thousand in wet weather. It is a building unique in plan, sloping up from the centre towards all sides like a theatre. The roof was supported by columns that were placed in lines radiating from the centre, so as to obscure as little as possible the view of an orator in this position from all parts of the building; there were two entrances in each side.

See *Excavations at Megalopolis* (E. A. Gardner, W. Loring, G. C. Richards, W. J. Woodhouse; Architecture, by R. W. Schultz); Supplementary Paper issued by the Society for the Promotion of Hellenic Studies, 1892; *Journal of Hellenic Studies*, xiii. 328, A. G. Bather; p. 319, E. F. Benson ("Thersilion"); 1898, p. 15, J. B. Bury ("Double City"); W. S. Dörpfeld, "Das griechische Theater"; O. Puchstein, "Griechische Bühnen" (Theatre).

(E. Gr.)

MEGANUCLEUS (also called **MACRONUCLEUS**), in Infusoria (*g.s.*), the large nucleus which undergoes direct (amitotic) division in fission, and is lost during conjugation, to be replaced by a nucleus, the result of the karyogamy of the micronuclei.

MEGAPODE (Gr. *μέγας*, great and *πούς*, foot), the name given generally to a small but remarkable family of birds, characteristic of some parts of the Australian region, to which it is almost peculiar. The *Megapodidae*, as the *Callidae* and *Phasianidae*, form that division of the sub-order *Gallini* named by Huxley

Peristeropodes (*Proc. Zool. Soc.*, 1868, p. 296). Their most remarkable habit is that of leaving their eggs to be hatched without incubation, burying them in the ground (as many reptiles do), or in a mound of earth, leaves and rotten wood which they scratch up. This habit attracted attention nearly four hundred years ago, but the accounts given of it by various travellers were generally discredited, and as examples of the birds, probably from their unattractive plumage, appear not to have been brought to Europe, no one of them was seen by any ornithologist or scientifically described until near the end of the first quarter of the 19th century. The first member of the family to receive authoritative recognition was one of the largest, inhabiting the continent of Australia, where it is known as the brush-turkey, and was originally described by J. Latham in 1821 under the misleading name of the New Holland vulture. It is the *Catheturus lathamii* of modern ornithologists, and is nearly the size of a hen turkey. This East Australian bird is of a sooty-brown colour, relieved beneath by the lighter edging of some of the feathers, but the head and neck are nearly bare, beset with fine bristles, the skin being of a deep pinkish-red, passing above the breast into a large wattle of bright yellow. The tail is commonly carried upright and partly folded, something like that of a domestic fowl. Allied to it are three or four species of *Talegallus*, from New Guinea and adjacent islands.

Another form, an inhabitant of South and West Australia, commonly known in England as the mallee-bird, but to the colonists as the "native pheasant"—the *Lipua ocellata*, as described by J. Gould in the *Proc. Zool. Soc.* (1840), p. 126, has much shorter tarsi and toes, the head entirely clothed, and the tail expanded. Its plumage presents a combination of greys and browns of various tints, interspersed with black, white and buff, the wing-coverts and feathers of the back bearing each near the tip an oval or subcircular patch, whence the scientific name of the bird is given, while a stripe of black feathers with a median line of white extends down the front of the throat from the chin to the breast. There is but one species of this genus known, as is also the case with the next to be mentioned, a bird long known to inhabit Celebes, but not fully

1 Antonio Pigafetta, one of the survivors of Magellan's voyage, records in his journal, under date of April 1521, among the peculiarities of the Philippine Islands, then first discovered by Europeans, the existence of a bird there, about the size of a fowl, which laid its eggs, as big as a duck's, in the sand, and left them to be hatched by the heat of the sun (*Premier voyage autour du monde*, ed. Amoretti, Paris, A.R. ix. 88). More than a hundred years later the Jesuit Nieremberg, in his *Historia naturae*, published at Antwerp in 1635, described (p. 207) a bird called "Daic," and by the natives named "Tapum," not larger than a dove, which, with its tail (!) and feet excoriated a nest in sandy places and laid therein eggs bigger than those of a goose. The publication of Romo's *Historia de Hernandez's Hist. avium novae Hispaniae* shows that his papers must have been accessible to Nieremberg, who took from them the passage just mentioned, but, as not unusual with him, misprinted the names which stand in Hernandez's work (p. 56, cap. 220) "Daic" and "Tapum" respectively, and omitted his predecessor's important addition "Viuit in Philippicis." Not long after, the Dominican Navarrete, a missionary to China, made a considerable stay in the Philippines, and returning to Europe in 1673, wrote an account of the Chinese empire, of which Churchill (*Collection of Voyages and Travels*, vol. 1.) gave an English translation in 1704. It is therein stated (p. 45) that in many of the islands of the Malay Archipelago "there is a very singular bird call'd *Tavon*," and that "What I and many more admire is, that it being no bigger in body than an ordinary chicken, the' loog legg'd, yet it lays an egg larger than a goose's, so that the egg is bigger than the bird itself. . . . In order to lay its eggs, it digs in the sand above a yard in depth; after laying, it fills up the hole and makes it even with the rest; there the eggs hatch with the heat of the sun and sand." Gemelli Careri, who travelled from 1663 to 1699, and in the latter year published an account of his voyage round the world, gives similar evidence respecting this bird, which he calls "tavon," in the Philippine Islands (*Voy. du tour du monde*, ed. Paris, 1727, v. 157, 158). The megapode of Luzon is fairly described by Camel or Camelli in his observations on the birds of the Philippines communicated by Peltiver to the Royal Society in 1703 (*Phil. Trans.* xxiii. 1398). In 1726 Valentin published his elaborate work on the East Indies, wherein (deel iii. bk. v. p. 320) he correctly describes the megapode of Amboina under the name of "malleloe," and also a larger kind found in Celebes.

described until 1846,¹ when it received from Salomon Müller (*Arch. f. Naturgeschichte*, xii. pt. 1, p. 116) the name of *Macrocephalon maleo*, but, being shortly afterwards figured by Gray and Mitchell (*Gen. Birds*, iii. pl. 123) under the generic term of *Megacephalon*, has since commonly borne the latter appellation. This bird bears a helmet-like protuberance on the back of its head, all of which, as well as the neck, is bare and of a bright red colour; the plumage of the body is glossy black above, and beneath roseate-white.

Of the megapods proper, constituting the genus *Megapodius*, about fifteen species are admitted. The birds of this genus range from the Samoa Islands in the east, through the Tonga group, to the New Hebrides, the northern part of Australia, New Guinea and its neighbouring islands, Celebes, the Pelew Islands and the Ladrões, and have also outliers in detached portions of the Indian Region, as the Philippines (where indeed they were first discovered by Europeans), Labuan, and even the Nicobars—though none is known from the intervening islands of Borneo, Java or Sumatra. Within what may be deemed their proper area they are found, says A. R. Wallace (*Geogr. Distr. Animals*, ii. 341), "on the smallest islands and sandbanks, and can evidently pass over a few miles of sea with ease." Indeed, proof of their roaming disposition is afforded by the fact that the bird described by Lesson (*Voy. Coquille: Zoologie*, p. 703) as *Alcedio urullii*, but now considered to be the young of *Megapodius freycineti*, flew on board his ship when more than 2 m. from the nearest land (Guebé), in an exhausted state, it is true, but that may be attributed to its youth. The species of *Megapodius* are about the size of small fowls, the head generally crested, the tail very short, the feet enormous, and, with the exception of *M. wallacii* (*Proc. Zool. Soc.*, 1860, *Aves*, pl. 171), from the Moluccas, all have a sombre plumage.

Megapods are shy terrestrial birds, of heavy flight, and omnivorous diet. In some islands they are semi-domesticated, although the flesh is dark and generally unpalatable. (A. N.)

MEGARA, an ancient Greek town on the road from Attica to Corinth. The country which belonged to the city was called *Μεγαρίς* or *ἡ Μεγαρίς*; it occupied the broader part of the isthmus between Attica, Boeotia, Corinth, and the two gulfs, and its whole area is estimated by Clinton at 143 sq. m. The range of Mount Geranea extends across the country from east to west, forming a barrier between continental Greece and the Peloponnus. The shortest road across this range passes along the eastern side of the mountains, and the most difficult part is the celebrated Scironian rocks, the mythic home of the robber Sciron. The only plain in the rugged little country was the White Plain, in which was situated the only important town, Megara. The modern town of Megara is situated on two low hills which formed part of the ancient site; it is the chief town of the eparchy of Megaris; pop. about 6400. It contains few remains of antiquity, except of the aqueduct and basin, said to have been made by the architect Eupalinus for the tyrant Theagenes. (E. Gr.)

From the somewhat conflicting evidence of mythology it may be gathered that in prehistoric days Megara had maritime intercourse with the southern Aegean. The early inhabitants, whose race is unknown, were extirpated or absorbed in the Dorian migration, for in historic times the city had a homogeneous Dorian population. Favoured by its proximity to two great waterways and by its two ports, Nisaea on the Saronic and Pegae on the Corinthian Gulf, Megara took a prominent part in the commercial expansion of Greece from the 8th century onwards, and for two hundred years enjoyed prosperity out of proportion to the slight resources of its narrow territory. Its trade was mainly directed towards Sicily, where Megarian colonies were established at Hybla (Megara Hyblaea) and Selinus, and towards the Black Sea, in which region the Megarians were probably

pioneers of Greek commerce. In the Sea of Marmora they had to face the competition of the Samians, with whom they waged a war concerning the town of Perinthus, and of Miletus; but on the Bosphorus they established themselves by means of settlements at Chalcedon and, above all, Byzantium (founded, according to tradition, 675 and 658 respectively). In the Black Sea they exploited the shores of Pontus and Scythia, whose products they exchanged for textiles spun from the wool of their own country. Their chief colonies in this sea were Astacus and Heraclia in Bithynia, and another Heraclia in the Crimea. In the later 7th century this current of trade dwindled in face of the great commercial and colonizing activity of Miletus; it probably received further injury through the subsequent interference of Athens on the Hellespont. Simultaneously Megarian commerce in Sicily began to be supplanted by Corinth and Corcyra.

Megara's economic development entailed a change in the distribution of wealth, and consequently of political power, which is commented upon in the elegies of Theognis (*g.v.*). The original land-holding aristocracy, which had probably initiated and for a time monopolized commerce, was partly supplanted by prosperous upstarts, and with the general increase of prosperity began to lose its hold upon the community of artisans. In the ensuing party struggles the city passed under a tyrant, Theagenes (about 640), whose rule was too brief to produce great changes. The power of the nobles would seem to have been more effectively broken in a war with Athens, in which Megara ultimately lost the island of Salamis (about 570, see Solon), for shortly afterwards the constitution was changed to a democracy, and eventually was fixed as an oligarchy of a moderate type.

During the Persian war the state, which had recently joined the Peloponnesian League, could still muster 3000 hoplites. But the subsequent expansion of Athens ruined the commerce of Megara, and the town itself was threatened with absorption by some powerful neighbour. In 459 an attack by Corinth, which had always coveted Megara's territory, induced the people to summon the aid of the Athenians, who secured Megara in battle and by the construction of long walls between the capital and its port Nisaea. In 445 a revulsion of feeling led the Megarians to massacre their Athenian garrison. The Athenians retaliated by placing an embargo upon Megarian trade throughout their empire (432), and in the Peloponnesian War, which the Megarians had consequently striven to hasten on, reduced their neighbours to misery by blockade and devastations. In 424 they nearly captured Megara, in collusion with a democratic party within the town, and succeeded in securing Nisaea, which they held till 410. In the 4th century Megara recovered some measure of prosperity, but played an insignificant part in politics, its only notable move being the participation in the final conflict against Philip II. of Macedonia (338). During the Macedonian supremacy the town passed in turn from Cassander and Demetrius Poliorcetes to Antigonos Gonatas, and finally was incorporated in the Achaean League. Megara suffered severely during the Civil War of 48 B.C., but seems at some later period to have received new settlers. It maintained itself as a place of some size in subsequent centuries, but was depopulated by the Venetians in A.D. 1500. The inhabitants of the modern village are mostly of Albanian origin.

In literature Megara figures as the reputed home of the comedian Sussarion, and in the 4th century gave its name to a school of philosophy founded by Euclid.

See Strabo ix. 391–395; Theognis; Thucydides i–v.; Aristophanes, *Acharnians*, 729–835; F. C. Coler, *Parishes and Politiken in Megara and Athens* (Stuttgart, 1890), pp. I–B. V. Head, *Historia numorum* (Oxford, 1887), pp. 329–330; R. Delbrück and K. G. Vollmöller, "Das Brunnenhaus des Theagenes," in *Mitteil. d. deutsch. Inst. Athen*. XXV. (1900). (M. O. B. C.)

MEGARA HYBLAEA (perhaps identical with HYBLA MAJOR), an ancient city of Sicily, on the E. coast, 12 m. N.N.W. of Syracuse, founded in 728 B.C. by Megarean colonists, who had previously settled successively at Trotilon, Leontini and Thapsus. A hundred years later it founded Selinus, apparently because it had no room for development. It never seems to have been a town of great importance, and had no advantages of position. It was destroyed by Gelon about 481 B.C., and its walls seem to have been razed to the ground. In the Athenian expedition against Syracuse (415–413) Lamachus proposed (it being then deserted) to make it the Athenian base of operations; but his advice was not taken, and in the next spring the Syracusans fortified it. In 309 it was still fortified; but, after Marcellus captured it, in 214, we hear little more of it. Excavations carried on in 1891 led to the discovery of the

¹ As we have seen, it was mentioned in 1726 by Valentin, and a young example was in 1830 described and figured by Quoy and Gaimard (*Voy. de l'Atrolabe: Oiseaux*, p. 239, pl. 25) as the *Megapodius rubripes* of Temminck, a wholly different bird.

northern portion of the western town wall, which in one section served at the same time as an embankment against floods (it was apparently more conspicuous in the time of P. Cluver, *Sicilia*, p. 133), of an extensive necropolis, about 1000 tombs of which have been explored, and of a deposit of votive objects from a temple. The harbour lay to the north of the town.

See P. Orsi in *Monumenti dei Lincei* (1891), i. 689-950; and *Atti del congresso delle scienze storiche*, v. 181 (Rome, 1904). (T. As.)

MEGARIAN SCHOOL OF PHILOSOPHY. This school was founded by Euclides of Megara, one of the pupils of Socrates. Two main elements went to make up the Megarian doctrine. Like the Cynics and the Cyrenaics, Euclides started from the Socratic principle that virtue is knowledge. But into combination with this he brought the Eleatic doctrine of Unity. Perceiving the difficulty of the Socratic dictum he endeavoured to give to the word "knowledge" a definite content by divorcing it absolutely from the sphere of sense and experience, and confining it to a sort of transcendental dialectic or logic. The Eleatic unity is Goodness, and is beyond the sphere of sensible apprehension. This goodness, therefore, alone exists; matter, motion, growth and decay are figments of the senses; they have no existence for Reason. "Whatever is, is!" Knowledge is of ideas and is in conformity with the necessary laws of thought. Hence Plato in the *Sophist* describes the Megarians as "the friends of ideas." Yet the Megarians were by no means in agreement with the Platonic idealism. For they held that ideas, though eternal and immovable, have neither life nor action nor movement.

This dialectic, initiated by Euclides, became more and more opposed to the testimony of experience; in the hands of Eubulides and Alexinus it degenerated into hairsplitting, mainly in the form of the *reductio ad absurdum*. The strength of these men lay in destructive criticism rather than in construction: as dialecticians they were successful, but they contributed little to ethical speculation. They spent their energy in attacking Plato and Aristotle, and hence earned the opprobrious epithet of *Eristic*. They used their dialectic subtlety to disprove the possibility of motion and decay; unity is the negation of change, increase and decrease, birth and death. None the less, in ancient times they received great respect owing to their intellectual pre-eminence. Cicero (*Academici*, ii. 42) describes their doctrine as a "nobilis disciplina," and identifies them closely with Parmenides and Zeno. But their most immediate influence was upon the Stoics (*q.v.*), whose founder, Zeno, studied under Stilpo. This philosopher, a man of striking and attractive personality, succeeded in fusing the Megarian dialectic with Cynic naturalism. The result of the combination was in fact a juxtaposition rather than a compound; it is manifestly impossible to find an organic connexion between a practical code like Cynicism and the transcendental logic of the Megarians. But it served as a powerful stimulus to Zeno, who by descent was imbued with oriental mysticism.

For bibliographical information about the Megarians, see EUCLIDES; EUBULIDES; DIODORUS CRONOS; STILPO. See also ELEATIC SCHOOL; CYNICS; STOICS; and, for the connexion between the Megarians and the Eretrians, MENEDEMIUS and PHAEDO. Also Zeller, *Socrates and the Socratic Schools*; Dyeck, *De Megariorum doctrina* (Bonn, 1827); Mallet, *Histoire de l'école de Mégare* (Paris, 1845); Ritter, *Über die Philosophie der Meg. Schule*; Prantl, *Geschichte der Logik*, i. 32; Henne, *L'école de Mégare* (Paris, 1843); Gomperz, *Greek Thinkers* (Eng. trans. 1905), ii. 170 seq.

MEGARON, the principal hall of the ancient Greek palace, situated in the andron or men's quarter. Examples have

been found at Tiryns and Mycenae, and references are made to it in the *Iliad* and the *Odyssey*.

MEGATHERIUM (properly *Megalotherium*), a huge extinct edentate mammal from the Pleistocene deposits of Buenos Aires, typifying the family *Megatheriidae* (or *Megalotheriidae*), and by far the largest representative of the Edentata. Except, indeed, for its relatively shorter limbs *Megatherium americanum* rivalled an elephant in bulk, the total length of the skeleton being 18 feet, five of which are taken up by the tail. The *Megatheriidae*, which include a number of genera, are collectively

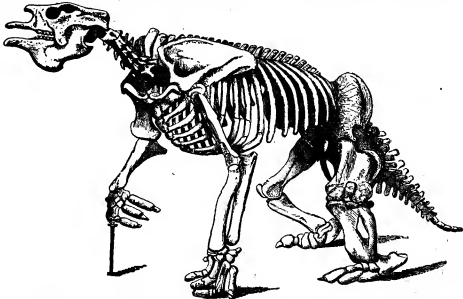

FIG. 1.—Skeleton of the Megatherium, from the specimen in the Museum of the Royal College of Surgeons of England.

known as ground-sloths, and occupy a position intermediate between the sloths and the ant-eater: their skulls being of the type of the former, while their limbs and vertebrae conform in structure to those of the latter. As in the other typical South American edentates, there are no teeth in the front of the jaws, while those of the cheek-series usually comprise five pairs in the upper and four in the lower. In nearly all the other Pleistocene forms these teeth were subcylindrical in shape, with the summit of the crown (except sometimes in the first pair) forming a cup-like depression; enamel being in all cases absent. From all these *Megatherium* differs in the form and structure of the teeth.

In form, as shown in fig. 2, the teeth are quadrangular prisms, each of which is surmounted by a pair of transverse ridges. They grew apparently throughout life, and were implanted to a great depth in the jaws, being 7 or 8 in. in length, with a cross-section of at least an inch and a half. The ridges on the crown are due to the arrangement of the vertical layers of hard dentine (fig. 3, 4), softer vasodentine (p) and cement (c). The skull is relatively small, with the lower jaw very deep in its central portion, and produced in part into a long snout-like symphysis for the reception, doubtless, of a large and fleshy tongue (fig. 2). Unlike sloths, the megatherium has seven cervical vertebrae; and the spines of all the trunk-vertebrae incline backwards. The pelvis and hind-limbs are much more powerful than the fore-quarters; thereby enabling these animals, in all probability, to rear themselves on their hind-quarters, and thus pull down the branches of trees: if not, indeed, in some cases to bodily uproot the trees themselves. Large chevron-bones are suspended to the vertebrae of the tail, which was massive, and probably afforded a support when the monster was sitting up. The humerus has no foramen, and the



(From Owen.)
FIG. 2.—Lower jaw and Teeth of *Megatherium*.

whole fore-limb was very mobile. The first front toe was rudimentary, having no phalanges, but the fifth was rather less aborted, although clawless; the other three carried enormous claws, protected by reflected sheaths. The hind-foot is remarkable for the great backward projection of the calcaneum, and likewise for the peculiar shape of the astragalus; the middle toe alone carries a claw, this being of huge size, and ensheathed like those of the fore foot. No trace

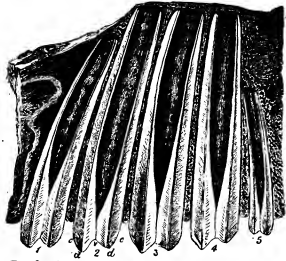

(From Owen.)

FIG. 3.—Section of Upper Molar Teeth of *Megatherium*.

of a bony armour in the skin has been detected; but, from the evidence of other genera, it may be assumed that the body was clothed in a coat of long, coarse hair. Although similar teeth occur in the phosphorite beds of South Carolina, which may have been transported from elsewhere, no undoubted remains of *Megatherium* are known from North America.

The typical species ranged from Argentina and Chili to Brazil. For certain small ground-sloths from Patagonia with *Megatherium*-like teeth, see MYLODON. (R. L.)

MEGHNA, a river of India. It forms, in the lower part of its course, the great estuary of the Bengal delta, which conveys to the sea the main body of the waters of the Ganges and the Brahmaputra, which unite at Goalanda in Faridpur district. The united waters, turbid and of great depth, are sometimes split into half a dozen channels by sand-banks, sometimes spread into a wide sheet of water. The river enters the sea by four principal mouths, enclosing the three large islands of Dakshin Shahbazpur, Hatia and Sandwip. It is navigable by native boats and river steamers all the year; but the navigation is difficult and sometimes dangerous on account of shifting sand-banks and snags, and boisterous weather when the monsoon is blowing. The most favourable season is between November and February. Alluvion and diluvion are constantly taking place, especially along the seaboard, and in Noakhali district the land is said to have made rapid advance on the sea; while the islands fringing the mouth are annually being cut away and redeposited in fresh shapes. The regular rise of the tide is from 10 to 18 ft., and at springs the sea rushes up in a dangerous bore. It is greatest at the time of the biennial equinoxes, when navigation is sometimes impeded for days together. The tidal wave advances like a wall topped with foam of the height of nearly 20 ft., and at the rate of 15 m. an hour; in a few minutes it is past, and the river has changed from ebb to flood tide. A still greater danger is the "storm wave" which occasionally sweeps up the Meghna under a cyclone.

MEHÁDIA, a market town of Hungary, in the county of Krassó-Szörény, 287 m. S.E. of Budapest by rail. Pop. (1900), 2492. The town is the site of the ancient Roman colony *Ad Mediam*, near which passed the Roman road from the Danube to Dacia. It contains the ruins of a fortress, and other Roman remains. In its neighbourhood are the famous Hercules baths (Hungarian, *Herkulesfürdő*). These are situated in a narrow rocky ravine in the valley of the Csérna, where there are 22 hot springs, of which nine are in use, the most powerful being the Hercules spring. The springs are all strongly impregnated with

salts of sulphur, iodine, bromine and chlorine, and their average temperature is 70° to 145° F. They were famous in the Roman period under the name of *Thermae Herculis* or *Fontes Herculis*. Their popularity is attested by numerous inscriptions and relics. After the fall of the Roman Empire they fell into disuse until 1735, but in modern times they have been much frequented.

MEHEMET ALI (1769–1849), pasha and afterwards viceroy of Egypt, was born at Kavala, a small seaport on the frontier of Thrace and Macedonia. His father, an Albanian, was an *aga*, a small yeoman farmer, and he himself lived in his native town for many years as a petty official and trader in tobacco. In 1798 he became second in command of a regiment of bashi-bazouks, or volunteers, recruited in his neighbourhood to serve against Napoleon in Egypt. He took part in the battle of Aboukir (July 25, 1799), was driven into the sea with the routed Turks, and was saved from drowning by the gig of the British admiral, Sir Sidney Smith. In 1801 he returned to Egypt, in command of his regiment, and on the 9th of May distinguished himself by heading a bold cavalry charge at the battle of Rahmanieh. In the troubled years that followed, Mehemet Ali, leader of a compact body of Albanian clansmen, was in the best position to draw advantage from the struggle for power between the Mamelukes and the representatives of the Porte. In 1803 he cast in his lot with the former; in 1804 he turned against them and proclaimed his loyalty to the sultan; in 1805 the sheiks of Cairo, in the hope of putting a stop to the intolerable anarchy, elected him pasha, and a year later an imperial firman confirmed their choice. The disastrous British expedition of 1807 followed; and while at Constantinople the prestige of the sultan was being undermined by the series of revolutions which in 1808 brought Mahmud II. to the throne, that of Mehemet Ali was enhanced by the exhibition at Cairo of British prisoners and an avenue of stakes decorated with the heads of British slain.

The situation revealed to the astute Albanian boundless possibilities for gratifying his ambition. In spite of his chance victories, he was too shrewd an observer not to recognize the superiority of European methods of warfare; and as the first step towards the empire of which he dreamed he determined to create an army and a fleet on the European model. In 1808 the building and organization of the navy was begun with the aid of French officers and engineers. In 1811 the massacre of the Mamelukes left Mehemet Ali without a rival in Egypt, while the foundations of his empire beyond were laid by the war against the Wahhábis and the conquest of the holy cities of Mecca and Medina. The Wahhábí War, indeed, dragged on till 1818, when Ibrahim (*g.p.*), the pasha's son, who in 1816 had driven the remnant of the Mamelukes into Nubia, brought it to an end. This done, the pasha turned his attention southward to the vast country watered by the Upper Nile. In 1820 the oasis of Siwa was subdued by his arms; in 1823 he laid the foundations of Khartum.

By this time Mehemet Ali was the possessor of a powerful fleet and of an army of veterans disciplined and drilled by European officers. To obtain these money had been necessary; and to raise money the pasha had instituted those internal "reforms"—the bizarre system of state monopolies and the showy experiments in new native industries which are described in the article Egypt (*g.p.*). The inherent viciousness of these expedients had, however, not as yet been revealed by their inevitable results, and Mehemet Ali in the eyes of the world was at once the most enlightened and the most powerful of the sultan's vassals. To Mahmud II., whose whole policy was directed to strengthening the authority of the central power, this fact would have sufficed to make him distrust the pasha and desire his overthrow; and it was sorely against his will that, in 1822, the ill-success of his arms against the insurgent Greeks forced him to summon Mehemet Ali to his aid. The immediate price was the pashalik of Crete; in the event of the victory of the Egyptian arms the pashaliks of Syria and Damascus were to fall to Mehemet Ali, that of the Morea to his son Ibrahim. The part played by Mehemet Ali in the Greek War is described elsewhere (see TURKEY; *History*; GREECE: *History*; GREEK INDEPENDENCE, WAR OF;

IBRAHIM. The intervention of the powers, culminating in the shattering of the Egyptian fleet at Navarino (*q.v.*), robbed him of his reward so far as Greece was concerned; the failure of his arms in face of this intervention gave Sultan Mahmud the excuse he desired for withholding the rest of the stipulated price of his assistance.

This disappointment of his ambition would not perhaps in itself have sufficed to stir Mehemet Ali to revolt against his master; but it was ominous of perils to come, which the astute pasha thought it wise to forestall. The sultan's policy had been consistently directed to crushing the overgrown power of his vassals; in the spring of 1831 two rebellious pashas, Hussein of Bosnia and Mustafa of Scutari, had succumbed to his arms; and, since he was surrounded and counselled by the personal enemies of the pasha of Egypt, it was likely that, so soon as he should feel himself strong enough, he would deal in like manner with Mehemet Ali. It was to anticipate this peril that Mehemet Ali determined himself to open the struggle: on the 1st of November 1831 a force of 9000 Egyptian infantry and 2000 cavalry crossed the frontier into Syria and met at Jaffa the fleet which brought Ibrahim as commander-in-chief. The combined forces at once laid siege to St Jean d'Acre.

The stubborn resistance of the garrison delayed Ibrahim's progress; and, meanwhile, wild rumours went abroad as to Mehemet Ali's intentions. He was master of the holy cities, and the official *Moniteur Ottoman* denounced his supposed plan of aiming at the caliphate in collusion with the sheriff of Mecca. As for the pasha himself, he loudly disclaimed any such disloyal pretensions; his aim was to chastise Abdulla, pasha of Acre, who had harboured refugees from his "reforms"; to overthrow Khusev, who had encouraged him in his refusal to surrender them; to secure the fulfilment of the sultan's promise with regard to Syria and Damascus. Mahmud, on the other hand, was torn between hatred of the pasha and hatred of the Christian powers which had forced him to make concessions to the Greeks. Voices urged him to come to terms with Mehemet Ali, secure peace in Islam, and turn a united face of defiance against Europe; and for a while he harboured the idea. He was conscious of his own intense unpopularity, the outcome of his efforts at reform; he knew that in popular opinion Mehemet Ali was the champion of Islam against the infidel caliph, and that the issue of a struggle with him was more than doubtful. He was hampered by the unpaid debt to Russia; by unrest in Bosnia and Albania; above all, by the revolt of the Greek Islands, which had left his navy, deprived of its best sailors, in no condition to dispute the Egyptian command of the sea. In the end, however, his pride prevailed; in April 1833 the Turkish commander-in-chief Hussein Pasha left Constantinople for the front; and in the third week in May the ban of outlawry was launched against Mehemet Ali.

Meanwhile, Ibrahim had occupied Gaza and Jerusalem as well as Jaffa; on the 27th of May, a few days after the publication of the ban, Acre was stormed; on the 15th of June the Egyptians occupied Damascus. Ibrahim pressed on with characteristic rapidity, his rapid advance being favoured by the friendly attitude of the various sections of the Syrian population, whom he had been at pains to conciliate. He defeated the Ottoman advance-guard at Homs on the 9th of July and at Hamah on the 11th, entered Aleppo on the 17th, and on the 20th inflicted a crushing defeat on the main Turkish army under Hussein Pasha at the pass of Beilan. All Syria was lost to the sultan, and the Egyptian advance-guard passed the mountain defiles into Adana in Asia Minor.

Mahmud, in desperation, now turned for help to the powers. Russian aid, though promptly offered, was too double-edged a weapon to be used save at the last extremity. Austrian diplomacy was, for the moment, that of Russia. France had broken her long tradition of friendship for Turkey by the occupation of Algiers. Great Britain, prodigal of protestations of goodwill, alone remained; and to her Mahmud turned with a definite offer of an offensive and defensive alliance. Stratford Canning, who was at Constantinople for the purpose of superintending the negotiations for the delimitation of the frontiers of Greece, wrote

home urging the government to accept, and suggesting a settlement of the Egyptian question which foreshadowed that of 1841. Palmerston, however, did not share Canning's belief in the possible regeneration of Turkey; he held that an isolated intervention of Great Britain would mortally offend not only Russia but France, and that Mehemet Ali, disappointed of his ambitions, would find in France a support that would make him doubly dangerous.¹

In the autumn Sultan Mahmud, as a last independent effort, despatched against Ibrahim the army which, under Reshid Pasha, had been engaged in pacifying Albania. The result was the crowning victory of the Egyptians at Konia (Dec. 21). The news reached Constantinople at the same time as Count Muraviev arrived on a special mission from the tsar. The Russian offers were at once renewed of a squadron of battleships and of a land force for the protection of the capital. Efforts were made to escape the necessity of accepting the perilous aid. Ottoman agents, backed by letters from the French chargé d'affaires, were sent to Mehemet Ali and to Ibrahim, to point out the imminence of Russian intervention and to offer modified terms. Muraviev himself went to Alexandria, where, backed by the Austrian agent, Count Prokesch-Osten, he announced to the pasha the tsar's immutable hatred of rebels. Mehemet Ali merely protested the complete loyalty of his intentions; Ibrahim, declaring that as a soldier he had no choice but to obey his father's orders, advanced to Afium-Karahissar and Kutaiah, whence he wrote to the sultan asking his gracious permission to advance to Brusa. He was at the head of 100,000 men, well organized and flushed with victory; the Ottoman army survived only as demoralized rabble. Panic seized the Seraglio; and at the beginning of February the assistance of Russia was formally demanded. The representatives of France and Great Britain made every effort to secure a reversal of this fatal step; but, while they were threatening and promising, Russia was acting, and on the 20th of February a Russian squadron entered the Bosphorus.

In view of this it became necessary for the objecting powers to take a new line. The new French ambassador, Admiral Roussin, had arrived on the 17th; he now, with the full concurrence of Mandeville, the British chargé d'affaires, persuaded the Porte to invite the Russians to withdraw, undertaking that France would secure the acceptance by Mehemet Ali of the sultan's terms. A period of suspense followed. The Russian squadron was detained by contrary winds, and before it could sail peremptory orders arrived from the tsar for it to remain until Ibrahim should have repassed the Taurus mountains. Meanwhile, Mehemet Ali had scornfully rejected the offers of the Porte; he would be content with nothing but the concession of his full demands—Syria, Ichel, Aleppo, Damascus and Adana. France and Great Britain now urged the sultan to yield, and in March a Turkish agent was sent to Ibrahim to offer the pashaliks of Syria, Aleppo and Damascus. The crisis was precipitated by the arrival on the 5th of April of a second division of the Russian fleet in the Bosphorus, and of a Russian force of 6000 men, which landed on the Asiatic shore. The Porte now tried once more to modify its terms; but the Western powers were now intent on getting rid of the Russians at all costs, and as a result of the pressure they brought to bear on both parties the preliminary convention of Kutaiah, conceding all the Egyptian demands, was signed on the 8th of April, and Ibrahim began his withdrawal. The convention stipulated for the bestowal of the pashalik of Adana on Ibrahim; but when on the 16th he received the official list of appointments, he found that Adana had been expressly reserved by the sultan. He at once arrested his march; but the pressure of famine in the capital, caused by the cutting off of supplies from Asia and the presence of the large Russian force, compelled Mahmud to yield, and on the 3rd of May a firman ceded Adana to Ibrahim under the pretext of appointing him *muhassil*, or collector of the revenue.

When Lord Ponsonby, the new British ambassador, arrived at

¹ Canning's original memorandum is in the Foreign Office Records in the volume marked *F.O. Turkey: From Sir Stratford Canning* (August to December, 1832). It bears elaborate pencil notes in Palmerston's handwriting, in part already obliterated.

Constantinople on the 1st of May he found Russia practically in possession. Sultan Mahmud was to the last degree embittered against the powers which, with lively protestations of friendship, had forced him to humiliate himself before his hated vassal. Russia had given him deeds, not words; and to Russia he committed himself. A further contingent of six or seven thousand Russians had arrived on the 22nd of April; Russian engineers were busy with the fortifications along the Straits; Russian agents alone were admitted to the sultan's presence. "It is manifest," wrote Lord Ponsoby, "that the Porte stands in the relation of vassal to the Russian government."¹ The relation was soon to be yet more manifest. Before, on the 9th of July, the Russian fleet, with the Russian troops on board, weighed anchor for the Black Sea, there was signed at the palace of Unkjar Skelassi the famous treaty (July 8, 1833) which, under the guise of an offensive and defensive alliance, practically made Russia the custodian of the gates of the Black Sea. (See TURKEY: *History*.)

Mehemet Ali had triumphed, but he was well aware that he held the fruits of his victory by a precarious tenure. He was still but a vail among the rest, holding his many pashaliks nominally by the sultan's will and subject to annual re-appointment; and he knew that both his power and his life would be forfeit so soon as the sultan should be strong enough to deprive him of them. To achieve this one end had, indeed, become the overmastering passion of Mahmud's life, to defeat it the object of all Mehemet Ali's policy. So early as 1834 it seemed as though the struggle would be renewed; for Mehemet Ali had extended to his new pashaliks his system of monopolies and conscription, and the Syrians, finding that they had exchanged Turkish whips for Egyptian scorpions, rose in a passion of revolt. It needed the intervention of Mehemet Ali in person before, in the following year, they were finally subdued. Meanwhile it had needed all the diplomatic armoury of the powers to prevent Mahmud hastening to the assistance of his "oppressed subjects." The threats of Great Britain and France, the failure of Russia to back him up, induced him to refrain; but sooner or later a renewal of the war was inevitable; for the sultan, with but one end in view, was reorganizing his army, and Mehemet Ali, who in the autumn of 1834 had assumed the style of viceroy and sounded the powers as to their attitude in the event of his declaring his complete independence, refused to continue to pay tribute which he knew would be used against himself.

The crisis came in 1838. In March the Egyptians were severely defeated by the revolted Arabs of the Hauran; and the Porte, though diplomatic pressure kept it quiet, hurried on preparations for war. Mehemet Ali, too, had small reason for postponing the conflict. The work of Moltke, who with other German officers who had been engaged in organizing the Turkish army, threatened to destroy his superiority in the field; the commercial treaty signed by the Ottoman government with Great Britain (Aug. 16), which applied equally to all the territories under his rule, threatened to destroy at a blow the lucrative monopolies which supplied him with the sinews of war. Months of suspense followed; for the powers had threatened to cast their weight into the scale against whichever side should prove the aggressor, and Mehemet Ali was too astute to make the first move. In the end Mahmud's passion played into his hands. The old sultan thirsted to crush his rebellious vassal, at any cost; and on the 21st of April 1839 the Ottoman army, stationed at Bir on the Euphrates, crossed the stream and invaded Syria. On the 23rd of June it was attacked and utterly routed by Ibrahim at Nezib. On the 1st of July the old sultan died, unconscious of the fatal news, leaving his throne to Abdul-Mejid, a lad of sixteen. To complete the desperation of the situation the news reached the capital that Ahmed Pasha, the Ottoman admiral-in-chief, had sailed to Alexandria and surrendered his fleet to Mehemet Ali, on the pretext that the sultan's advisers were sold to the Russians.

So far as the forces of the Ottoman Empire were concerned,

¹ From Lord Ponsoby, *F.O., Turkey*, May 22, 1833.

Mehemet Ali was now absolute master of the situation. The grand vizier, in the sultan's name, wrote beseeching him to avoid the further shedding of Mussulman blood, offering him a free pardon, the highest honours of the state, the hereditary pashalik of Egypt for himself, and Syria for Ibrahim until he should succeed his father in Egypt. Mehemet Ali replied diplomatically; for, though these offers fell far short of his ambitions, a studious moderation was essential in view of the doubtful attitude of the European powers.

On the 27th of July the ambassadors of the five powers presented to the Porte a joint note, in which they declared that an agreement on the Eastern Question had been reached by the five Great Powers, and urged it "to suspend all definite decision made without their concurrence, pending the effect of their interest in its welfare." The necessity for showing a united front justified the diplomatic inexactitude; but the powers were agreed on little except the need for agreement. Especially was this need realized by the British government, which feared that Russia would seize the occasion for an isolated intervention under the treaty of Unkjar Skelessi. On the 1st of August Palmerston wrote to Ponsoby impressing upon him that the representatives of the powers, in their communications with the Porte, "should act not only simultaneously in point of time, but *identically in point of manner*"—a principle important in view of later developments. Yet it was a task all but impossible to preserve this appearance of unanimity in view of the divergent views within the concert. France and Great Britain had hitherto acted together through common opposition to the supposed designs of Russia. Austria, too, now that the revolutionary spectres of 1830 had been laid, was reverting to her traditional opposition to Russia in the affairs of the Near East, and Metternich supported Palmerston's proposal of an international conference at Vienna. Everything depended on the attitude of the emperor Nicholas. This was ultimately determined by his growing distrust of Austria and his perennial hatred of the democratic régime of France. The first caused him to reject the idea of a conference of which the activities would have been primarily directed against Russia; the second led him to drive a wedge into the Anglo-French *entente* by making direct overtures to Great Britain. Palmerston listened to the tsar's proposals, conveyed through Baron Brunnow, "with surprise and admiration." The emperor Nicholas was prepared to accept the views of Great Britain on the Turco-Egyptian question; to allow the Treaty of Unkjar Skelessi to lapse; to act henceforth in the Ottoman Empire only in concert with the other powers, in return for an agreement closing the Dardanelles to the war-ships of all nations and to extend the same principle to the Bosphorus. Finally, Brunnow was empowered to arrange a coalition of the great powers with a view to the settlement of the Egyptian question; and in this coalition the tsar was willing, for political reasons, that France should be included, though he stated his personal preference for her exclusion.

To these views Austria and, as a natural consequence, Prussia acceded without difficulty. The attitude of France was a more doubtful quantity. In France Mehemet Ali had become a popular hero; under him French civilization had gained a foothold in Egypt; he was regarded as invincible; and it was hoped that in alliance with him French influence in the Mediterranean would be supreme. Palmerston, on the other hand, believed that the Ottoman empire would never be secure until "the desert had been placed between" the pasha of Egypt and the sultan; and the view that the coalition should be directed against Mehemet Ali was shared by the other powers. In the circumstances France should either have loyally accepted the decision of the majority of the concert, to which she had committed herself by signing the joint note of the 27th of July, or should have frankly stated her intention of taking up a position outside. The fact that she did neither led to a crisis that for a moment threatened to plunge Europe into war.

For nearly a year the diplomatic *pourparlers* continued without an agreement being reached; France insisted on Mehemet Ali's receiving the hereditary pashalik of Syria as well as that of

Egypt, a proposition to which Palmerston, though sincerely anxious to preserve the Anglo-French *entente*, refused to agree. The tension of the situation was increased when, on the 20th of February 1840, Thiers came into power. The diplomacy of Guizot, backed now by Austria and Prussia, had succeeded in persuading Palmerston to concede the principle of allowing Mehemet Ali to receive, besides Egypt, the pashalik of Acre as far as the frontiers of Tripoli and Damascus (May 7). Thiers, however, refused to listen to any suggestion for depriving him of any part of Syria; but, instead of breaking off the correspondence and leaving the concert, he continued the negotiations, and before long circumstances came to the knowledge of the British government which seemed to prove that he was only doing so with a view to gaining time in order to secure a separate settlement in accordance with French views.

The opportunity for this arose from a change in the situation at Constantinople, where the dismissal of Khusev Pasha had, in Mehemet Ali's view, removed the main obstacle to his reconciliation with the sultan. He proposed to the French consul-general at Alexandria to make advances to the Porte, and suggested sending back the Ottoman fleet as an earnest of his good intentions, a course which, it was hoped, "would lead to a direct and amicable arrangement of the Turco-Egyptian question." On the 21st of June his envoy, Sami Bey, actually arrived at Constantinople, ostensibly to congratulate the sultan on the birth of a daughter, really to make use of the French influence now supreme at the Porte in order to effect a settlement. In the circumstances the proper course for Thiers to have pursued would have been to have communicated to the powers, to whom he was bound by the moral engagement of the 27th of July 1839, the new conditions arising out of Mehemet Ali's offer. Instead he wrote to Guizot, on the 30th of June, saying that the situation argued strongly in favour of postponing any decision in London, adding: "I have written to Alexandria and Constantinople to counsel moderation on both sides; but I have been careful to forbid the agents to enter on their own account, and as a French undertaking, on a negotiation of which the avowed aim is a direct arrangement. If such an enterprise is imputed to us, you will be in a position to deny it."

The discovery of what seemed an underhand intrigue on the part of France produced upon the powers exactly the effect that Thiers had foreseen and deprecated. They regarded it as an attempt to ruin the work of the concert and to secure for France a "complete individual triumph" at Alexandria and Constantinople, and their countermove was to sign at London on the 15th of July, without the concurrence of France, a convention with the Porte for the settlement of the affairs of the Levant. By this instrument it was agreed that the terms to be offered to Mehemet Ali having been concerted with the Porte, the signatory powers would unite their forces in order to compel the pasha to accept the settlement. As to the terms to be offered, it was arranged that, in the event of Mehemet Ali yielding within ten days, he should receive the hereditary pashalik of Egypt and the administration for life of southern Syria, with the title of Pasha of Acre and the possession of the fortress of St Jean d'Acre. At the end of ten days, should he remain obdurate, the offer of Syria and Acre would be withdrawn; and if at the end of another ten days he was still defiant, the sultan would hold himself at liberty to withdraw the whole offer and to take such measures as his own interests and the counsels of his allies might suggest to him.

The news of this "mortal affront" to the honour of France caused immense excitement in Paris. The whole press was clamorous for war; Thiers declared that the alliance with Great Britain was shattered, and pressed on warlike preparations; even Louis Philippe was carried away by the fever. The immediate effect was that Mehemet Ali, confident of French assistance, maintained a defiant attitude. The situation, however, was rapidly changed by the unexpected results of the armed intervention of the Allies. The appearance of the combined British, Austrian and Russian fleets, under Sir Charles Napier, off Beirut (Aug. 11) was the signal for a general rising of the Syrians against Ibrahim's tyranny. On the 11th of

September, Suleiman Pasha not having obeyed the summons to evacuate the town, the bombardment was begun, and Ottoman troops were landed to co-operate with the rebels. On the 3rd of October Beirut fell; and Ibrahim, cut off from his communications by sea, and surrounded by a hostile population, began a hurried retreat southward. On the 3rd of November Acre surrendered to the allied fleet. Mehemet Ali's power in Syria had collapsed like a pricked bubble; and with it had gone for ever the myth of his humane and enlightened rule. The sole question now was whether he should be allowed to retain Egypt itself.

On the 15th of September the sultan, who had broken off all negotiations with Mehemet Ali on receipt of the news of the Syrian revolt, acting on the advice of Lord Ponsonby, declared the pasha deposed, on the ground that the term allowed by the Convention of London had expired, and nominated his successor. Mehemet Ali received the news with his accustomed *sang-froid*, observing to the consuls of the four powers, who had come to notify their own removal, that "such denunciations were nothing new to him; that this was the fourth, and that he hoped to get over it as well as he had done the other three, with the help of God and the Prophet." In the end his confidence proved to be justified. The news of the events in Syria and especially of the deprivation of Mehemet Ali had produced in France what appeared to be an exceedingly dangerous temper; the French government declared that it regarded the maintenance of Mehemet Ali in Egypt as essential to the European balance of power; and Louis Philippe sought to make it clear to the British government, through the king of the Belgians, that, whatever might be his own desire to maintain peace, in certain events to do so would be to risk his throne. Palmerston, indeed, who did not believe that under the Bourgeois Monarchy France would translate her brave words into action, was in favour of settling the Turco-Egyptian question once for all by depriving Mehemet Ali of Egypt as well. The influences against him, however, were too powerful. Metternich protested against a course which would result, in his opinion, either in a war or a revolution in France; King Leopold enlarged on the wickedness and absurdity of risking a European war for the sake of putting an end to the power of an old man who could have but few years to live; Queen Victoria urged her ministers to come to terms with France and relieve the embarrassments of the "dear King"; and Lord Melbourne, with the majority of the cabinet, was in favour of compromise. When therefore, on the 8th of October, Guizot, in an interview with Palmerston, presented what was practically an ultimatum on the part of France, "it was determined that this intimation should be met in a friendly spirit, and that Lord Palmerston should see the Ministers of the other powers and agree with them to acquaint the French that they with England would use their good offices to induce the Porte not to insist on the deprivation of Mehemet Ali so far as Egypt is concerned." In accordance with this Palmerston instructed Ponsonby to press upon the sultan, in the event of Mehemet Ali's speedy submission, not only to withdraw the sentence of deprivation but to confer upon him the hereditary pashalik of Egypt.

For a while it seemed that even this would not avert a European war. Thiers still maintained his warlike tone, and the king's speech prepared by him for the opening of the Chambers on the 28th of October was in effect a declaration of defiance to Europe. Louis Philippe himself, however, was not prepared to use this language; whereupon Thiers resigned, and a new cabinet was formed under Marshal Soult, with Guizot as foreign secretary. The equivocal tone of the new speech from the Throne raised a storm of protest in the Chambers and the country. It was, however, soon clear that Palmerston's diagnosis of the temper of the French *bourgeois* was correct; the clamour for war subsided; on the 4th of December the address on the Egyptian Question proposed by the government was carried, and peace was assured. Nine days earlier Sir Charles Napier had appeared with a British squadron off Alexandria and, partly by persuasion, partly by threats, had induced Mehemet Ali to submit to the sultan and to send back the Ottoman fleet, in return for a guarantee

of the hereditary pashalik of Egypt. This arrangement was ratified by Palmerston; and all four powers now combined to press it on the reluctant Porte, pointing out, in a joint note of the 30th of January 1841, that "they were not conscious of advising a course out of harmony with the sovereignty and legitimate rights of the sultan, or contrary to the duties imposed on the Pasha of Egypt as a subject appointed by His Highness to govern a province of the Ottoman Empire." This principle was elaborated in the firman, issued on the 13th of February, by which the sultan conferred on Mehemet Ali and his heirs by direct descent the pashalik of Egypt, the greatest care being taken not to bestow any rank and authority greater than that enjoyed by other viziers of the empire. By a second firman of the same date Mehemet Ali was invested with the government of Nubia, Darfur, Khordofan and Sennaar, with their dependencies. On the 10th of June the firman was solemnly promulgated at Alexandria.

This ended the phase of the Egyptian Question with which the name of Mehemet Ali is specially bound up. The threatened European conflict had been averted, and presently the wounded susceptibilities of France were healed by the invitation extended to her to take part in the Straits Convention. As for Mehemet Ali himself, he now passes off the stage of history. He was an old man; his mind was soon to give way; and for some time before his death on the 2nd of August 1849 the reins of power were held by his son and successor Ibrahim.

Probably no Oriental ruler, not even excepting Ali of Iannina, has ever stirred up so much interest among his contemporaries as Mehemet Ali. The spectacle of an Eastern despot apparently advancing on the lines of European progress was in itself as astonishing as new. Men thought they were witnessing the dawn of a new era in the East; Mehemet Ali was hailed as the most beneficent and enlightened of princes; and political philosophers like Jeremy Bentham, who sent him elaborate letters of good advice, thought to find in him the means for developing their theories in virgin soil. In fact the pasha was an illiterate barbarian, of the same type as his countryman Ali of Iannina, courageous, cruel, astute, full of wiles, avaricious and boundlessly ambitious. He never learned to read or write, though late in life he mastered colloquial Arabic; yet those Europeans who were brought into contact with him praised alike the dignity and charm of his address, his ready wit, and the astonishing perspicacity which enabled him to read the motives of men and of governments and to deal effectively with each situation as it arose.

The latest account of Mehemet Ali and the European crisis arising out of his revolt is that by W. Alison Phillips in vol. x. ch. xvii. of the *Cambridge Modern History* (1907). The bibliography attached to this chapter (p. 852) gives a list of all the principal published documents and works, together with some analysis of the unpublished Foreign Office records bearing on the subject. Of the works mentioned C. de Freycinet's *La Question d'Égypte* (Paris, 1905) gives the most authoritative account of the diplomatic developments. (W. A. P.)

MEHIDPUR, or **MAHIDPUR**, a town of India, in Indore state of Central India, on the right bank of the Sipra, 1543 ft. above the sea, and 24 m. N. of Ujjain. Pop. (1901), 6681. Though of some antiquity and frequented by Hindu pilgrims, it is best known for the battle fought in the neighbourhood on the 20th of December 1817, in which Sir John Malcolm defeated the army of Holkar. The result was the Treaty of Mandasor and the pacification of Malwa. Mehidpur was again the scene of some sharp fighting during the Mutiny. The British cantonment, placed here in 1817, was removed in 1882.

MÉHUL, **ÉTIENNE HENRI** (or **ÉTIENNE NICOLAS**) (1763-1817), French composer, was born at Givet in Ardennes, on the 24th of June 1763. His father being too poor to give him a regular musical education, his first ideas of art were derived from a poor blind organist of Givet; yet such was his aptitude that, when ten years old, he was appointed organist of the convent of the Récollets. In 1775 an able German musician and organist, Wilhelm Hauser, was engaged for the monastery of Lavaldieu, a few miles from Givet, and Méhul became his

occasional pupil. In 1778 he was taken to Paris by a military officer, and placed himself under Edelmann, a good musician and harpsichord player. His first attempts at instrumental composition in 1781 did not succeed, and he therefore turned his attention to sacred and dramatic music. Gluck gave him advice in his studies. After various disappointments during his efforts for six years to obtain, at the Grand Opéra, a representation of his *Cora et Alonso*, he offered to the Opéra Comique his *Euphrasie et Coradin*, which, being accepted and performed in 1790, at once fixed his reputation. His opera of *Sratonice* was also received with enthusiasm in 1792. After several unsuccessful operas, his *Adrien* appeared, and added much to his fame, which was further increased by his three best works, *Le Jeune Henri*, *Uthal* and *Joseph*, the finest of the series. *Uthal* was written for an orchestra without violins. Méhul held a post as one of the four inspectors of the Paris Conservatoire, but this office made him feel continually the insufficiency of his early studies, a want which he endeavoured to remedy by incessant application. *Timoléon*, *Ariodant* and *Bion* followed. *Epicure* was composed by Méhul and Cherubini jointly; but the superiority of the latter was evident. Méhul's next opera, *L'Irako*, failed. After writing forty-two operas, besides a number of songs for the festivals of the republic, cantatas, and orchestral pieces of various kinds, his health gave way, from an affection of the chest, and he died on the 18th of October 1817 in Paris.

See Lives by Pougin (1889), Viellard (1859), and Quatremère de Quincy (1818).

MEIBOM, HEINRICH (1555-1625), German historian and poet, was born at Lemgo on the 4th of December 1555, and died on the 20th of September 1625, at Helmstedt, where he had held the chair of history and poetry since 1583. He was a writer of Latin verses (*Parodiærum horatianarum libri III. et sylværum libri II.*, 1588); and his talents in this direction were recognized by the emperor Rudolph II., who ennobled him; but his claim to be remembered rests on his services in elucidating the medieval history of Germany.

His *Opuscula historica ad res germanicas spectantia* was edited and published in 1660 by his grandson, Heinrich Meibom (1638-1700), who was professor of medicine and then of history and poetry at Helmstedt, and incorporated his grandfather's work with his own *Rerum germanicarum scriptores* (1688).

MEIDERICH, a town of Germany, in the Prussian Rhine province, 2½ m. by rail N.E. of Ruhrort, whose river harbour is in great part within its confines. Pop. (1905), 40,822. Iron and steel works, coal-mines, saw-mills, brickworks, and machine-shops furnish the principal occupations of the inhabitants. Meiderich, which is first mentioned in 874, was united with Duisburg in 1905.

See Graeber, *Tausendjährige Geschichte von Meiderich* (1893).

MEIKTILA, a district and division in Upper Burma. The district is the most easterly of the districts in the dry zone, and has an area of 2183 sq. m. It lies between Kyaukse, Myingyan, Yaméthin, and on the east touches the Shan States. It is a slightly undulating plain, the gentle slopes of which are composed of black "cotton" soil and are somewhat arid. The only hills above 300 ft. are on the slopes of the Shan hills. The lake is the chief feature of the district. It is artificial, and according to Burmese legend was begun 2400 years ago by the grandfather of Gautama Buddha. It is 7 m. long, averages half a mile broad, and covers an area of 3½ sq. m. With the Minhla and other connected lakes it irrigates a large extent of country.

There are small forest reserves, chiefly of cutch. Large numbers of cattle are bred. The chief agricultural products are rice, sesamum, cotton, peas, maize, millet and gram. Pop. (1901), 252,305. Famines in 1891, 1895 and 1896 led to considerable emigration. The climate is healthy except in the submontane townships. The temperature rises to 100° F. and over between the months of March and June, and the mean minimum in January is about 61°. The rainfall is uncertain (36.79 in. in 1893, 25.59 in 1891). The vast majority

of the population are Buddhists. The headquarters town, MEIKTILA, stands on the banks of the lake, which supplies good drinking water. Pop. (1901), 7203. A wing of a British regiment is stationed here. A branch railway connects it at Thazi station with the Rangoon-Mandalay line, and continues westward to its terminus on the Irrawaddy at Myingyan.

The division includes the districts of Meiktila, Kyauské, Yaméthin and Myingyan, with a total area of 10,852 sq. m., and a population (1901) of 992,807, showing an increase of 10.2% in the preceding decade, and giving a density of 91 inhabitants to the square mile. All but a small portion of the division lies in the dry zone, and cultivation is mainly dependent on irrigation.

MEILHAC, HENRI (1831-1897), French dramatist, was born in Paris on the 21st of February 1831, and while a young man began writing fanciful articles for the newspapers and *sauvevides* for the theatres, in a vivacious *boulevardier* spirit which brought him to the front. About 1860 he met Ludovic Halévy, and the two began a collaboration in writing for the stage which lasted for twenty years. An account of their work is given under HALÉVY. Meilhac wrote a few pieces with lesser collaborators. In 1888 he was elected to the Academy. He died at Paris in 1897.

MEINBERG, a village and watering-place of Germany, in the principality of Lippe Detmold, situated in a pleasant valley under the Teutoburger Wald, 12 m. S.E. from Detmold by the railway to Altenbeken. Pop. (1905), 1300. The waters of Meinberg, which attract annually about 1200 visitors, are sulphur springs, and are used for drinking, bathing and inhalation. They became known in the 18th century.

See Gilbert and Meissner, *Bad Meinberg und seine Kurmittel* (Berlin, 1902).

MEINKE, JOHANN ALBRECHT FRIEDRICH AUGUST (1790-1870), German classical scholar, was born at Soest in Westphalia on the 8th of December 1790. After holding educational posts at Jenkau and Danzig, he was director of the Joachimsthal gymnasium in Berlin from 1826 to 1856. He died at Berlin on the 12th of December 1870. He was distinguished in conjectural criticism, the comic writers and Alexandrine poets being his favourite authors.

His most important works are: *Græcorum comicorum fragmenta* (1839-1857, the first volume of which contains an essay on the development of Greek comedy and an account of its chief representatives); *Aristophanes* (1860); *Analecta alexandrina* (1843, containing the fragments of Rhianus, Euphorion, Alexander of Aetolia, and Parthenius); *Callimachus* (1861); *Theocritus, Bion, Moschus* (3rd ed., 1856); *Alciphron* (1853); *Strabo* (2nd ed., 1866) and *Vindiciae straboniana* (1831); *Stobæus* (1855-1863); *Athenæus* (1858-1867). See monographs by F. Kanke (1871), H. Sauppe (1872), and E. Förstemann in *Allgemeine Deutsche Biographie*, XXI. (1885); also Sandys, *Hist. Class. Schol.* (1908), iii. 117.

MEININGEN, a town of Germany, capital of the duchy of Saxe-Meiningen, romantically situated in forests on the right bank of the Werra, 40 m. S. of Eisenach by rail. Pop. (1905), 15,980. It consists of an old town and several handsome suburbs, but much of the former has been rebuilt since a fire in 1874. The chief building is the Elisabethenburg, or the old ducal palace, containing several collections; it was built mainly about 1680, although part of it is much older. Other buildings are the Henneberger Haus with a collection of antiquities, and the town church, with twin towers, built by the emperor Henry II. in the 11th century. The theatre enjoyed for many years (1875-1890) a European reputation for its actors and scenic effects. The English garden, a beautiful public park, contains the ducal mortuary chapel and several monuments, including busts of Brahms and Jean Paul Richter.

Meiningen, which was subject to the bishops of Würzburg (1000-1542), came into the possession of the duke of Saxony in 1583, having in the meantime belonged to the counts of Henneberg. At the partition of 1660 it fell to the share of Saxe-Altenburg, and in 1680 became the capital of Saxe-Meiningen.

See E. Döbner, *Bausteine zu einer Geschichte der Stadt Meiningen* (Meiningen, 1902).

MEIR, Jewish rabbi of the 2nd century, was born in Asia Minor and according to legend was a descendant of the family of Nero. He was the most notable of the disciples of Agiba (*q.v.*), and after the Hadrianic repressions of A.D. 135 was instrumental in refounding the Palestinian schools at Usha. Among his teachers was also Elisha ben Abuya (*q.v.*), and Meir continued his devotion to Elisha after the latter's apostasy. He is said to have visited Rome to rescue his wife's sister. His wife, Beruriah, is often cited in the Talmud as an exemplar of generosity and faith. She was a daughter of the martyr Hananiah ben Teradion. On one occasion Meir, who had been frequently troubled by his ungodly neighbours, uttered a prayer for their extinction. "Nay," said Beruriah, "it is written (Ps. civ. 35) let *sins* be blotted out, not sinners"; whereupon Meir prayed for the evildoers' conversion. But she is best known for her conduct at the sudden death of her two sons. It was the Sabbath, and Meir returned home towards sunset. He repeatedly asked for the children, and Beruriah, after parrying his question, said: "Some time ago a precious thing was left with me on trust, and now the owner demands its return. Must I give it back?" "How can you question it?" rejoined her husband. Beruriah then led him to the bed whereon were stretched the bodies of the children. Meir burst into tears. But the wife explained that *this* was the treasure of which she had spoken, adding the text from Job: "The Lord gave and the Lord hath taken away; blessed be the name of the Lord." Meir himself was the author of many famous sayings: "Look not to the flask, but to its contents. Many a new vessel contains old wine, but there are old casks which do not contain even new wine." "Condole not with a mourner while his dead is laid out before him." "Man cometh into the world with closed hands as though claiming the ownership of all things; but he departeth hence with hands open and limp, as if to show that he taketh naught with him." "What God does is well done." "The tree itself supplies the handle of the axe which cuts it down." His wisdom was proverbial, and to him was in particular assigned an intimate acquaintance with fables, and he is reported to have known 300 Fox-Fables. "With the death of Rabbi Meir," says the Mishnah (*Sota* ix. 15), "Fabulists ceased to be."

Meir's wide sympathies were shown in his inclusion of all mankind in the hopes of salvation (Sifra to Leviticus xviii. 5). He was certainly on friendly terms with heathen scholars. Meir contributed largely to the material from which finally emerged the Mishnah. His dialectic skill was excessive, and it was said jestingly of him that he could give 150 reasons to prove a thing clean, and as many more to prove it unclean. His balanced judgment fitted him to carry on Agiba's work, sifting and arranging the oral traditions, and thus preparing the ground for the Mishnaic Code.

Meir left Palestine some time before his death, owing to disagreements between him and the Patriarch. He died in Asia Minor, but his love for the Holy Land remained dominant to the last. "Bury me," he said, "by the shore, so that the sea which washes the land of my fathers may touch also my bones." The tomb shown as that of Meir at Tiberias is inauthentic.

See Bacher, *Agada der Tannaiten*, vol. 11. ch. i.; Graetz, *History of the Jews* (Eng. trans.), vol. 11. ch. xvi.; *Jewish Encyclopedia* (whence some of the above cited sayings are quoted), viii. 432-435. On Meir's place in the history of the fable, see J. Jacobs, *The Fables of Aesop*, i. 111, &c. (see Index *s.v.*). (I. A.)

MEIR OF ROTHENBURG (c. 1215-1293), German rabbi and poet, was born in Worms c. 1215. He played a great part in organizing the Jewish communal life of the middle ages. In 1286 for some unknown reason he was thrown into prison in Alsace, where he remained until his death in 1293. His friends offered to find a ransom, but he declined the suggestion, fearing that the precedent would lead to extortion in other cases. He wrote glosses to the Talmud (*tosaphot*) and many *Disciples* of the utmost value for historical research. Through his disciples Asher ben Yehiel and Mordecai ben Hillel, Meir exercised much

influence on subsequent developments of Judaism. He was also a liturgical poet of considerable merit. One of his finest elegies is translated into English in Nina Davis's *Songs of Exile*.

See L. Ginzberg, *Jewish Encyclopedia*, viii, 437-440. (I. A.)

MEIRINGEN, the principal village on the Hasle (or the upper Aar) valley in the Swiss canton of Bern. It is built at a height of 1969 ft. on the right bank of the Aar and on the level floor of the valley, but is much exposed to the south wind (or *Föhn*), and has several times been in great part destroyed by fire (1632, 1879 and 1891). It has 3077 inhabitants, all German-speaking and Protestants. The parish church is ancient, and above it are the ruins of the medieval castle of Resti. Meiringen is frequented by travellers in summer, as it is the meeting-point of many routes: from Interlaken by the lake of Brienz and Brienz, from Lucerne by the Brünig railway (28 m.), from Engelberg by the Joch Pass (7267 ft.), from the upper Valais by the Grimsel Pass (7100 ft.), and from Grindelwald by the Great Scheidegg Pass (6434 ft.). Many waterfalls descend the hill-sides, the best known being the Reichenbach and the Albach, while the great gorge pierced by the Aar through the limestone barrier of the Kirchet is remarkable. The village and valley belonged of old to the emperor, who in 1234 gave the advowson to the Knights of St Lazarus, by whom it was sold in 1272 to the Austin Canons of Interlaken, on the suppression of whom in 1528 it passed to the state. In 1310 the emperor mortgaged the valley to the lords of Weissenburg, who sold it in 1334 to the town of Bern. (W. A. B. C.)

MEISSEN, a town of Germany, in the kingdom of Saxony, on both banks of the Elbe, 15 m. N.W. from Dresden, on the railway to Leipzig via Döbeln. Pop. (1905), 32,336. The old town lies on the left bank of the river, between the streams Meisse and Triebisch, and its irregular hilly site and numerous fine old buildings make it picturesque. Most of its streets are narrow and uneven. The cathedral, one of the finest early Gothic buildings in Germany, stands on the Schlossberg, 160 ft. above the town. It is said to have been founded by the emperor Otto the Great, but the present building was begun in the 13th century and was completed about 1450. Here are tombs of several rulers and princes of Saxony, including those of Albert and Ernest, the founders of the two existing branches of the Saxon house. The cathedral also contains works by Peter Vischer and Lucas Cranach and several other interesting monuments. A restoration, including the rebuilding of the two towers, was carried out in 1903-1908. Adjoining the cathedral is the castle, dating from 1471-1483, but restored and named the Albrechtsburg about 1676. Another restoration was undertaken after 1860, when a series of historical frescoes was painted upon its walls. A stone building of the 13th century connects the Schlossberg with the Afbraberg, which owes its name to the old convent of St Afa. The convent was suppressed by Duke Maurice in 1543, and was by him converted into a school (the Fürsten Schule), one of the most renowned classical schools in Germany, which counts Lessing and Gellert among its former pupils. Other public buildings of interest are the town-hall, built in 1479 and restored in 1875; the fine town church, called the Frauenkirche or Marienkirche; the Nikolaikirche and the Afrakirche. The Franciscan church is now used as a museum of objects connected with the history of Meissen. Since 1710 Meissen has been the seat of the manufacture of Dresden china. Till 1860 the royal porcelain factory was in the Albrechtsburg, but in that year it was transferred to a large new building in the Triebischthal, near the town. Meissen also contains iron foundries, factories for making earthenware stoves and pottery, sugar refineries, breweries and tanneries. A considerable trade is carried on in the wine produced in the surrounding vineyards, and other industries are spinning and weaving.

Meissen was founded about 920 by Henry the Fowler (see MEISSEN, Margravate). From 968 to 1581 Meissen was the seat of a line of bishops, who ranked as princes of the empire. During the 15th century the town suffered greatly from the Hussites, and it was captured by the imperial troops during

the war of the league of Schmalkalden, and again in the Thirty Years' War. In 1637 it suffered much from the Swedes, and in 1745 it fell into the hands of the Prussians. The bridge over the Elbe was destroyed by the French in 1813, and again by the Saxons in June 1866 in order to impede the march of the Prussians on Dresden. Cölln on the right bank of the Elbe was incorporated with Meissen in 1901.

See Reinhard, *Die Stadt Meissen, ihre Merkwürdigkeiten* (Meissen, 1829); Loose, *Alt-Meissen in Bildern* (Meissen, 1889); Jäschke, *Meissen und seine Kirchen* (Leipzig, 1902); and Gersdorf, *Urkundenbuch der Stadt Meissen* (Leipzig, 1873).

MEISSEN, a German margravate now merged in the kingdom of Saxony. The mark of Meissen was originally a district centring round the castle of Meissen or Misnia on the Middle Elbe, which was built about 920 by the German king Henry I, the Fowler, as a defence against the Slavs. After the death of Gero, margrave of the Saxon east mark, in 965, his territory was divided into five marks, one of which was called Meissen. In 985 the emperor Otto III. bestowed the office of margrave upon Ekkard I., margrave of Merseburg, and the district comprising the marks of Meissen, Merseburg and Zeitz was generally known as the mark of Meissen. In 1002 Ekkard was succeeded by his brother Gunzelin, and then by his sons Hermann I. and Ekkard II. Under these margraves the area of the mark was further increased, but when Ekkard II. died in 1046 it was divided, and Meissen proper was given successively to William and Otto, counts of Weimar, and Egbert II., count of Brunswick. Egbert was a rival of the emperor Henry IV. and died under the imperial ban in 1089, when Meissen was bestowed upon Henry I., count of Wettin, whose mother was a sister of the margrave Ekkard II. Henry, who already ruled lower Lusatia and the new and smaller Saxon east mark, was succeeded in 1103 by his cousin Thimo, and in 1104 by his son Henry II., whose claim on the mark was contested by Thimo's son Conrad. When Henry died without issue in 1123 Meissen was given by the emperor Henry V. to Hermann II., count of Wintzenburg; but, renewing his claim, Conrad won the support of Lothair, duke of Saxony, afterwards the emperor Lothair II., and obtained possession in 1130. Conrad, called the Great, extended the boundaries of Meissen before abdicating in 1156 in favour of his son Otto, known as the Rich. Otto appointed his younger son Dietrich as his successor and was attacked and taken prisoner by his elder son Albert; but, after obtaining his release by order of the emperor Frederick I., he had only just renewed the war when he died in 1190. During his reign silver mines were opened in the Harz Mountains, towns were founded, roads were made, and the general condition of the country was improved. Otto was succeeded by his son Albert, called the Proud, who was engaged in warfare with his brother Dietrich until his death in 1195. As Albert left no children, Meissen was seized by the emperor Henry VI. as a vacant fief of the empire; but Dietrich, called the Oppressed, secured the mark after Henry's death in 1197. Dietrich married Jutta, daughter of Hermann I., landgrave of Thuringia, and was succeeded in 1221 by his infant son Henry, surnamed the Illustrious; who on arriving at maturity obtained as reward for supporting the emperor Frederick II. against the pope a promise to succeed his uncle, Henry Raspe IV., as landgrave of Thuringia. In 1243 Henry's son Albert was betrothed to Margaret, daughter of Frederick II.; and Pleissnerland, a district west of Meissen, was added to his possessions. Having gained Thuringia and the Saxon palatinate on his uncle's death in 1247, he granted sections of his lands to his three sons in 1265, but retained Meissen. A series of family feuds followed. His second son Dietrich died in 1285, and on Henry's own death in 1288 Meissen was divided between his two remaining sons, Albert (called the Degenerate) and Frederick, and his grandson Frederick Tutta, the son of Dietrich. Albert was engaged in struggles with his three sons, who took him prisoner in 1288; but he was released the following year by order of the German king Rudolph I. About this time he sold his portion of Meissen to his nephew Frederick Tutta, who held the title

of margrave and ruled the greater part of the mark until his death in 1291. Albert's two remaining sons, Frederick and Dietrich or Diezmann, then claimed Meissen; but it was seized by King Adolph of Nassau as a vacant fief of the empire, and was for some time retained by him and his successor King Albert I. In the course of constant efforts to secure the mark the brothers Frederick and Dietrich defeated the troops of King Albert at Lucka in May 1307 and secured partial possession of their lands. In this year Dietrich died and Frederick became reconciled with his father, who after renouncing his claim on Meissen for a yearly payment, died in 1314. Having obtained possession of the greater part of the mark, Frederick was invested with it by the German king Henry VII. in 1310. During these years the part of Meissen around Dresden had been in the possession of Frederick, youngest son of the margrave Henry the Illustrious, and when he died in 1316 it came to his nephew Frederick. About 1312 Frederick, who had become involved in a dispute with Waldemar, margrave of Brandenburg, over the possession of lower Lusatia, was taken prisoner. Surrendering lower Lusatia he was released, but it was only after Waldemar's death in 1319 that he obtained undisputed possession of Meissen. Frederick, who was surnamed the Peaceful, died in 1323 and was followed as margrave by his son Frederick II., called the Grave, who added several counties to his inheritance. From this latter Frederick's death in 1349 until 1381 the lands of the family were ruled by his three sons jointly; but after the death of his eldest son Frederick III. in 1381 a division was made by which Meissen fell to his youngest son William I. In 1407 William was succeeded by his nephew Frederick, called the Warlike, who in 1423 received from the emperor Sigismund the electoral duchy of Saxe-Wittenberg. The mark then became merged in the duchy of Saxony, and at the partition of 1485 fell to the Albertine line. As Meissen was relieved from the attacks of the Slavs by the movement of the German boundary to the east, its prosperity increased. Many towns were founded, among which were Dresden, Leipzig and Freiburg; Chemnitz began its textile industry; and although the condition of the peasants was wretched, that of the townsmen was improving. The discoveries of silver brought great wealth to the margraves, but they resorted at times to *bedes*, which were contributions from the nobles and ecclesiastics who met in a kind of diet. During this period the mark of Meissen lay on both banks of the Elbe, and stretched from Bohemia to the duchy of Saxe-Wittenberg, embracing an area of about 3000 sq. m.

See O. Posse, *Die Markgrafen von Meissen und das Haus Wettin* (Leipzig, 1881); F. W. Tittmann, *Geschichte Heinrichs des erlauchten Markgrafen zu Meissen* (Dresden, 1845-1846); C. F. von Poser-Klett, *Zur Geschichte der Verfassung der Markgrafschaft Meissen im 13. Jahrhundert* (Leipzig, 1863). See also *Urkunden der Markgrafen von Meissen und Landgrafen von Thüringen*, edited by E. G. Gersdorf (Leipzig, 1864); and H. B. Meyer, *Hof- und Zentralverwaltung der Wettiner* (Leipzig, 1902).

MEISSONIER, JEAN LOUIS ERNEST (1815-1891), French painter, was born at Lyons on the 21st of February 1815. From his school days he showed a taste for painting, to which some early sketches, dated 1823, bear witness. After being placed with a druggist, he obtained leave from his parents to become an artist, and, owing to the recommendation of a painter named Potier, he entered a second class Prix de Rome, he was admitted to Léon Cogniet's studio. He paid short visits to Rome and to Switzerland, and exhibited in the Salon of 1831 a picture then called "Les Bourgeois Flamands" ("Dutch Burgers"), but also known as "The Visit to the Burgomaster," subsequently purchased by Sir Richard Wallace, in whose collection (at Hertford House, London) it is, with fifteen other examples of this painter. It was the first attempt in France in the particular *genre* which was destined to make Meissonier famous: microscopic painting—miniature in oils. Working hard for daily bread at illustrations for the publishers—Curmer, Hetzel and Dubocher—he also exhibited at the Salon of 1836 the "Chess Player" and the "Errand Boy." After some not very happy attempts at religious painting, he returned, under the

influence of Chenavard, to the class of work he was born to excel in, and exhibited with much success the "Game of Chess" (1841), the "Young Man playing the 'Cello'" (1842), "The Painter in his Studio" (1843), "The Guard Room," the "Young Man looking at Drawings," the "Game of Piquet" (1845), and the "Game of Bowls"—works which show the finish and certainty of his technique, and assured his success. After his "Soldiers" (1848) he began "A Day in June," which was never finished, and exhibited "A Smoker" (1849) and "Bravos" ("Les Bravi," 1852). In 1855 he touched the highest mark of his achievement with "The Gamblers" and "The Quarrel" ("La Rixe"), which was presented by Napoleon III. to the English Court. His triumph was sustained at the Salon of 1857, when he exhibited nine pictures, and drawings; among them the "Young Man of the Time of the Regency," "The Painter," "The Shoeing Smith," "The Musician," and "A Reading at Diderot's." To the Salon of 1861 he sent "The Emperor at Solferino," "A Shoeing Smith," "A Musician," "A Painter," and "M. Louis Fould"; to that of 1864 another version of "The Emperor at Solferino," and "1814." He subsequently exhibited "A Gamblers' Quarrel" (1865), and "Desaix and the Army of the Rhine" (1867). Meissonier worked with elaborate care and a scrupulous observation of nature. Some of his works, as for instance his "1807," remained ten years in course of execution. To the great Exhibition of 1878 he contributed sixteen pictures: the portrait of Alexandre Dumas which had been seen at the Salon of 1877, "Cuirassiers of 1805," "A Venetian Painter," "Moreau and his Staff before Hohenlinden," a "Portrait of a Lady," the "Road to La Salice," "The Two Friends," "The Outpost of the Grand Guard," "A Scout," and "Dictating his Memoirs." Thenceforward he exhibited less in the Salons, and sent his work to smaller exhibitions. Being chosen president of the Great National Exhibition in 1883, he was represented there by such works as "The Pioneer," "The Army of the Rhine," "The Arrival of the Guests," and "Saint Mark." On the 24th of May 1884 an exhibition was opened at the Petit Gallery of Meissonier's collected works, including 146 examples. As president of the jury on painting at the Exhibition of 1889 he contributed some new pictures. In the following year the New Salon was formed (the National Society of Fine Arts), and Meissonier was president. He exhibited there in 1890 his picture "1807"; and in 1891, shortly after his death, his "Barricade" was displayed there. A less well-known class of work than his painting is a series of etchings: "The Last Supper," "The Skill of Vuillaume the Lute Player," "The Little Smoker," "The Old Smoker," the "Preparations for a Duel," "Anglers," "Troopers," "The Reporting Sergeant," and "Polichinelle," in the Hertford House collection. He also tried lithography, but the prints are now scarcely to be found. Of all the painters of the century, Meissonier was one of the most fortunate in the matter of payments. His "Cuirassiers," now in the late duc d'Aumale's collection at Chantilly, was bought from the artist for £10,000, sold at Brussels for £11,000, and finally resold for £16,000. Besides his genre portraits, he painted some others: those of "Doctor Lefevre," of "Chenavard," of "Vanderbilt," of "Doctor Guyon," and of "Stanford." He also collaborated with the painter Français in a picture of "The Park at St Cloud." In 1838 Meissonier married the sister of M. Steinhil, a painter. Meissonier was attacked by Napoleon III. to the imperial staff, and accompanied him during the campaign in Italy and at the beginning of the war in 1870. During the siege of Paris in 1871 he was colonel of a marching regiment. In 1840 he was awarded a third-class medal, a second-class medal in 1841, first-class medals in 1843 and 1844 and medals of honour at the great exhibitions. In 1846 he was appointed knight of the Legion of Honour and promoted to the higher grades in 1856, 1867 (June 29), and 1880 (July 12), receiving the Grand Cross in 1889 (Oct. 29). He nevertheless cherished certain ambitions which remained unfulfilled. He hoped to become a professor at the *École des Beaux Arts*, but the appointment he desired was never given to him. On various occasions,

too, he aspired to be chosen deputy or made senator, but he was not elected. In 1861 he succeeded Abel de Pujol as member of the Academy of Fine Arts. On the occasion of the centenary festival in honour of Michelangelo in 1875 he was the delegate of the Institute of France to Florence, and spoke as its representative. Meissonier was an admirable draughtsman upon wood, his illustrations to *Les Contes Rémoués* (engraved by Lavoignat), to Lamartine's *Fall of an Angel*, to Paul and Virginia, and to *The French Painted by Themselves* being among the best known. The leading engravers and etchers of France have been engaged upon plates from the works of Meissonier, and many of these plates command the highest esteem of collectors. Meissonier died in Paris on the 21st of January 1891. His son, Jean Charles Meissonier, also a painter, was his father's pupil, and was admitted to the Legion of Honour in 1889.

See Alexandre, *Histoire de la peinture militaire en France* (Paris, 1891); Laurens, *Notice sur Meissonier* (Paris, 1892); Gréard, *Meissonier* (Paris and London, 1897); T. G. Dumas, *Maîtres modernes* (Paris, 1884); Ch. Formentin, *Meissonier, sa vie—son œuvre* (Paris, 1901); J. W. Mollett, *Illustrated Biographies of Modern Artists: Meissonier* (London, 1882). (H. Fr.)

MEISSONIER, JUSTE AURÈLE (1695-1750), French goldsmith, sculptor, painter, architect, and furniture designer, was born at Turin, but became known as a worker in Paris, where he died. His Italian origin and training were probably responsible for the extravagance of his decorative style. He shared, and perhaps distanced, the meretricious triumphs of Oppenard and Germain, since he dealt with the Baroque in its most daring and flamboyant developments. Rarely does he leave a foot or two of undecorated space; the effect of the whole is futile and fatiguing. It was because Meissonier carried the style of his day to its extreme that he acquired so vast a popularity. Like the English brothers Adam at a later day he not only as architect built houses, but as painter and decorator covered their internal walls; he designed the furniture and the candlesticks, the silver and the decanters for the table; he was as ready to produce a snuff-box as a watch case or a sword hilt. Not only in France, but for the nobility of Poland, Portugal and other countries who took their fashions and their taste from Paris, he made designs, which did nothing to improve European taste. Yet his achievement was not wholly without merit. His work in gold and silver-plate was often graceful and sometimes bold and original. He was least successful in furniture, where his twirls and convolutions, his floral and rocaille motifs were conspicuously offensive. He was appointed by Louis XV. *Dessinateur de la chambre et du cabinet du roi*; the post of designer *pour les pompes funèbres et galantes* was also held along with that of *Orfèvre du roi*.

For our knowledge of his work we are considerably indebted to his own books of design: *Livre d'ornements en trente pièces*; *Livre d'orfèvrerie d'église en six pièces*, and *Ornements de la corbe chronologique*.

MEISTERSINGER (Ger. for "master-singer"), the name given to the German lyric poets of the 14th, 15th and 16th centuries, who carried on and developed the traditions of the medieval Minnesingers (q.v.). These singers, who, for the most part, belonged to the artisan and trading classes of the German towns, regarded as their masters and the founders of their guild twelve poets of the Middle High German period, among whom were Wolfram von Eschenbach, Konrad von Würzburg, Reinmar von Zweter and Frauenlob. The last mentioned of these, Frauenlob, is said to have established the earliest Meistersinger school at Mainz, early in the 14th century. This is only a tradition, but the institution of such schools originated undoubtedly in the upper Rhine district. In the 14th century there were schools at Mainz, Strassburg, Frankfurt, Würzburg, Zürich and Prague; in the 15th at Augsburg and Nuremberg, the last becoming in the following century, under Hans Sachs, the most famous of all. By this time the Meistersinger schools had spread all over south and central Germany; and isolated guilds were to be found farther north, at Magdeburg, Breslau, Gölritz and Danzig.

Each guild numbered various classes of members, ranging from beginners, or *Schüler* (corresponding to trade-apprentices), and *Schulfreunde* (who were equivalent to *Gesellen* or journey-men), to *Meister*, a *Meister* being a poet who was not merely able to write new verses to existing melodies but had himself invented a new melody. The poem was technically known as a *Bar* or *Gesetz*, the melody as a *Ton* or *Weis*. The songs were all sung in the schools without accompaniment. The rules of the art were set down in the so-called *Tabulatur* or law-book of the guild. The meetings took place either in the Rathaus, or town hall, or, when they were held—as was usually the case—on Sunday, in the church; and three times a year, at Easter, Whitsuntide and Christmas, special festivals and singing competitions were instituted. At such competitions or *Schulsingen* judges were appointed, the so-called *Merker*, whose duty it was to criticize the competitors and note their offences against the rules of the *Tabulatur*.

The literary value of the Meistersinger poetry was hardly in proportion to the large part it played in the life of the German towns of the 15th and 16th centuries. As the medieval lyric decayed, more and more attention was given to the externals of poetic composition, the form, the number of syllables, the melody; and it was such externals that attracted the interest of these burgher-poets. Poetry was to them a mechanical art that could be learned by diligent application, and the prizes they had to bestow were the rewards of ingenuity, not of genius or inspiration. Consequently we find an extraordinary development of strophic forms corresponding to the many new "tones" which every Meistersinger regarded it as his duty to invent—tones which were the most remarkable and often ridiculous names, such as *Gestreiftsafranblüemleinweis*, *Feldtachsweis*, *Vielfrassweis*, *geblieme Paradiesweis*, &c. The verses were adapted to the musical strophes by a merely mechanical counting of syllables, regardless of rhythm or sense. The meaning, the sentiment, the thought, were the last things to which the Meistersingers gave heed. At the same time there was a certain healthy aspect in the cultivation of the Meistersinger among the German middle classes of the 15th and 16th centuries; the Meistersinger poetry, if not great or even real poetry, had—especially in the hands of a poet like Hans Sachs—many germs of promise for the future. It reflected without exaggeration or literary veneer the faith of the German burgher, his blunt good sense and honesty of purpose. In this respect it was an important factor in the rise of that middle-class literature which found its most virile expression in the period of the Reformation. The Meistersinger reached its highest point in the 16th century; and it can hardly be said to have outlived that epoch, although the traditions of the Meistersinger schools lingered in south German towns even as late as the 19th century.

Specimens of Meistersinger poetry will be found in various collections, such as J. J. Görres, *Alteutsche Volks- und Meisterlieder* (1817); K. Bartsch, *Meisterlieder der Kölmerer Handschrift* (Publ. of the Stuttgart *Literarischer Verein*, vol. lviii.; 1862). Of the older sources of information about the Meistersinger the most important are Adam Puschmann, *Gründlicher Bericht des deutschen Meistersingers zuzum Tabulatur* (1571; reprinted in W. Braune's *Neudrucke deutscher Literaturwerke des 16. und 17. Jahrh.*, 73, 1888), and J. C. Wagenseil, *Die civilese Noriberger* (1697). See further J. Grimm, *Über den ältesten Meistersinger* (1811); F. Schorr von Carolsfeld, *Zur Geschichte des deutschen Meistersingers* (1872); R. von Lilienort, *Über den Inhalt der allgemeinen Bildung in der Zeit der Scholastik* (1876); G. Jacobsthal, "Die musikalische Bildung der Meistersinger" (*Zeitschrift für deut. Altertum*, xx., 1876); O. Lyon, *Minne- und Meistersinger* (1882); K. Mey, *Der Meistersinger-Gesichte und Kunst* (1892). The art of the Meistersingers has been immortalized by Richard Wagner in his music drama, *Die Meistersinger* (1868). (J. G. R.)

MEKONG, or ME NAM KONG (pronounced *Kawng*), sometimes known as the Cambodia River, the great river of Indo-China, having its origin in the Tibetan highlands. It is the third or fourth longest river in Asia and the seventh or eighth in the world. It is about 2800 m. in length, of which 1200 flow through portions of the Chinese Empire and Tibet and 1600 through French territory. Its sources are not definitely settled, but it is supposed to rise on the slopes of Dza-Nag-Lung-Mung in about

33° N., 93° E., at an altitude of 16,700 ft. above sea-level. Throughout the greater part of its course in Tibet, where it is called the Dza-Chu, it flows south-eastwards to Chiampo, on the great east and west caravan route from China to Lhasa. At this point it is about 10,000 ft. above sea-level. From here it flows southwards through little-known mountain wastes. Below Dayul in lat. 29° it is known by the Chinese name of Lantsan Kiang. For the next 300 m. of its course the Lantsan Kiang, or, as it soon becomes known among the Thai peoples inhabiting its rugged valley, the Mekong, is very little known to us.

The river flows beneath bare and rocky walls. A few scattered villages of Lus and Mossos exist in this region; there is no trade from north to south. In 25° 18' N. the Tali-Bhamo caravan route, described by Colborne Baker, crosses the river by one of those iron suspension bridges which are a feature of Yun-nan, at a height of 4700 ft. above sea-level. From this point to Chieng or Keng Hung, the head of the old confederacy of the Sibsang Punna or Twelve States, it is little known; the fact that it falls some 900 ft. for each degree of latitude indicates the character of the river. Under the provisions of the Anglo-French agreement of January 1896, from the Chinese frontier southwards to the mouth of the Nam Hok the Mekong forms the frontier between the British Shan States on the west and the territories acquired from Siam by France in 1893. By the treaty of 1893, from that point southwards to about 13° 30' N. it is also the frontier between French Indo-China and Siam, and a zone extended 25 kilometres inland from the right bank, within which the Siamese government agreed not to construct any fortified port or maintain any armed force. This 25 kilometre neutral zone was abolished in 1905 when France surrendered Chantabou to the Siamese, who in their turn ceded the port of Krat and the provinces of Melupre and Bassac, together with various trading concessions to France on the right bank of the Mekong. Below the Siamese Shan town of Chieng Sen the river takes its first great easterly bend to Luang Prabang, being joined by some important tributaries. This portion is obstructed by rapids. The country is mountainous, and the vegetation of the lower heights begins to assume a tropical aspect. From Luang Prabang the river cuts its way southwards for two degrees through a lonely jungle country among receding hills of low elevation. From Chieng Khan the river again turns eastwards along the 18th parallel, forcing its way through its most serious rapid-barrier, and receiving some important tributaries from the highlands of Tung Chieng Kum and Chieng Kwang, the finest country in Indo-China. In 104° E. the river resumes a southerly course through a country thinly peopled. At Kemarat (16° N.) the fourth serious rapid-barrier occurs, some 60 m. in length, and the last at Khong in 14° N. From here to its outfall in the China Sea the river winds for some 400 m. through the French territories of Cambodia and Cochinchina, and to its annual overflow these countries owe their extraordinary fertility. The French have done much to render the river navigable. Steamers ply regularly from Saigon through Mytho to Pnompenh, and launches proceed from this place, the capital of Cambodia, to the Preapntano rapids, and beyond this a considerable portion of the distance to Luang Prabang, the journey being finished in native boats. (J. G. Sc.)

MELA, POMPONIUS (*fl. c. A.D. 43*), the earliest Roman geographer. His little work (*De situ orbis libri III.*) is a mere compendium, occupying less than one hundred pages of ordinary print, dry in style and deficient in method, but of pure Latinity, and occasionally relieved by pleasing word-pictures. Excepting the geographical parts of Pliny's *Historia naturalis* (where Mela is cited as an important authority) the *De situ orbis* is the only formal treatise on the subject in classical Latin. Nothing is known of the author except his name and birthplace—the small town of Tingentera or Cingentera in southern Spain, on Algeciras Bay (Mela ii. 6, § 96; but the text is here corrupt). The date of his writing may be approximately fixed by his allusion (iii. 6 § 49) to a proposed British expedition of the reigning emperor, almost certainly that of Claudius in A.D. 43. That this passage cannot refer to Julius Caesar is proved by

several references to events of Augustus's reign, especially to certain new names given to Spanish towns. Mela has been without probability identified by some with L. Annaeus Mela of Corduba, son of Seneca the rhetorician, and brother of the great Seneca.

The general views of the *De situ orbis* mainly agree with those current among Greek writers from Eratosthenes to Strabo; the latter was probably unknown to Mela. But Pomponius is unique among ancient geographers in that, after dividing the earth into five zones, of which two only were habitable, he asserts the existence of *arcticiones*, inhabiting the southern temperate zone inaccessible to the folk of the northern temperate regions from the unbearable heat of the intervening torrid belt. On the divisions and boundaries of Europe, Asia and Africa, he repeats Eratosthenes; like all classical geographers from Alexander the Great (except Ptolemy) he regards the Caspian Sea as an inlet of the Northern Ocean, corresponding to the Persian and Arabian (Red Sea) gulfs on the south. His Indian conceptions are inferior to those of some earlier Greek writers; he follows Eratosthenes in supposing that country to occupy the south-eastern angle of Asia, whence the coast trended northwards to Scythia, and then swung round westward to the Caspian Sea. As usual, he places the Rhipaean Mountains at the Hyperboreans near the Scythian Ocean. In western Europe his knowledge (as was natural in a Spanish subject of Imperial Rome) was somewhat in advance of the Greek geographers. He defines the western coast-line of Spain and Gaul and its indentation by the Bay of Biscay more accurately than Eratosthenes or Strabo, his ideas of the British Isles and their position are also clearer than his predecessors'. He is the first to name the Orcaes or Orkneys, which he defines and locates pretty correctly. Of northern Europe his knowledge was imperfect, but he speaks vaguely of a great bay of *arcticiones*, to the north of Germany, among whose many islands was one, "Codanovia," of pre-eminent size; this name reappears in Pliny as "Scandinavia." Mela's descriptive method is peculiar and inconvenient. Instead of treating each continent separately he begins at the Straits of Gibraltar, and describes the countries adjoining the south coast of the Mediterranean; then he moves round by Syria and Asia Minor to the Black Sea, and so returns to Spain along the north shore of the Euxine, Propontis, &c. After treating the Mediterranean islands, he next takes the ocean littoral to west, north, east and south successively—from Spain and Gaul round to India, from India to Persia, Arabia and Ethiopia; and so again works back to Spain round South Africa. Like most classical geographers he conceives the Dark Continent as surrounded by sea and not extending very far south.

The first edition of Mela was published at Milan in 1471; the first good edition was by Vadianus (Basel, 1522), superseded by those of Voss (1658), J. Gronovius (1685 and 1696), A. Gronovius (1722 and 1728), and Tzschucke (1806-1807), in seven parts (Leipzig; the most elaborate of all); G. Parthey's (Berlin, 1867), gives the best text. The English trans. by Arthur Golding (1885), is famous; see E. H. Bunbury, *Ancient Geography*, ii. 352-368, and D. Detlefsen, *Quellen und Forschungen zur alt. Geogr.* (1908). (E. H. B.; C. R. B.)

MELACONITE, a mineral consisting of cupric oxide, CuO, and known also as black copper ore. In appearance it is strikingly different from cuprite (*sp.*) or red copper ore, which is cuprous oxide. Crystals are rare; they belong to the monoclinic, or possibly to the anorthic system, and have the form of thin triangular or hexagonal scales with a steel-grey colour and brilliant metallic lustre. More often the mineral is massive, earthy or pulverulent, and has a dull iron-black colour. Hence the name melaconite, from the Greek μέλας, black and κόπρις, dust, which was originally given by F. S. Beudant in 1832 in the form melaconite. The crystallized Vesuvian mineral was later named tenorite, a name commonly adopted for the species. The hardness of the crystals is 3-4, but the earthy and powdery forms readily soil the fingers; the spec. grav. is 5.9. Crystals have been found only at Mt Vesuvius, where they encrust lava, and in Cornwall. The other forms of the mineral, however, are common in copper mines, and have resulted by the alteration of chalcocite, chalcopyrite and other copper ores, on which they often form a superficial coating. (L. J. S.)

MELAMPUS, in Greek legend, a celebrated seer and physician, son of Amythaon and Eidomene, brother of Bias, mythical eponymous hero of the family of the Melampodidae. Two young serpents, whose life he had saved, licked his ears while he slept, and from that time he understood the language of birds, and beasts. In the art of divination he received instruction from Apollo himself. To gain the consent of Neleus, king of Pylos, to the marriage of his daughter Pero with Bias, Melampus

undertook to obtain possession of the oxen of the Thessalian prince Iphiclus. As Melampus had foretold, he was caught and imprisoned, but was released by Phylacus (the father of Iphiclus) on giving proof of his powers of divination, and was finally presented with the oxen as a reward for having restored the virility of the son. Melampus subsequently obtained a share in the kingdom of Argos in return for having cured the daughters of its king Proetus, who had been driven mad for offering resistance to the worship of Dionysus or for stealing the gold from the statue of Hera. At Aegosthena in Megara there was a sanctuary of Melampus, and an annual festival was held in his honour. According to Herodotus, he introduced the cult of Dionysus into Greece from Egypt, and his name ("black foot") is probably "a symbolical expression of his character as a Bacchic propitiatory priest and seer" (Preller). According to the traditional explanation, he was so called from his foot having been tanned by exposure to the sun when a boy. In his character of physician, he was the reputed discoverer of the herb melampodium, a kind of hellebore. Melampus and Bias are symbolical representatives of cunning and force.

See Apollodorus i. 9, 11, 12; ii. 2, 2; *Odyssey*, xv. 225-240; Diod. Sic. iv. 68; Herodotus ii. 49; ix. 34; Pausanias ii. 18, 4; iv. 36, 3; scholiast on Theocritus iii. 43; Ovid, *Metam.* xv. 325; C. Eckermann, *Melampus und sein Geschlecht* (1840).

Melampus is also the name of the author of a short extant treatise of little value on Divination by means of Palpation (Παλαμών) and Birthmarks (Ἐλαΐων). It probably dates from the time of Ptolemy Philadelphus (3rd cent. B.C.). Edition by J. G. Franz in *Scriptores physiognomiae veteres* (1780).

MELANCHLAENI (from Gr. μέλας, and χλαῖνα, "Black-cloaks"), an ancient tribe to the north of Scythia, probably about the modern Ryazan and Tambov (Herodotus iv. 106). They have been identified with the Finnish tribes Merja (now extinct) and Cheremis, now driven north-east on to the middle Volga. These, till recently, wore black. There has been confusion between this tribe and another of the same name mentioned by Pliny (*N. H.* vi. 15), and Ptolemy in the Caucasus.

MELANCHOLY (Gr. μελαγχολία, from μέλας, black, and χολή, bile), originally a condition of the mind or body due to a supposed excess of black bile, also this black bile itself, one of the chief "humours" of the body, which were, according to medieval physiology, blood, phlegm, cholera and melancholy (see HUMOUR); now a vague term for desponding grief. From the 17th century the name was used of the mental disease now known as "melancholia" (see INSANITY), but without any reference to the supposed cause of it.

MELANCHTHON, PHILIPP (1497-1550), German theologian and reformer, was born at Bretten in Baden on the 16th of February 1497. His father, George Schwartzerd, was an armourer under the Palatinate princes. His mother, Barbara Reuter, a niece of Johann Reuchlin, was shrewd, thrifty and affectionate.¹ Her father, Johann Reuter, long burgomaster of Bretten, supervised the education of Philipp, who was taught first by Johannes Hungarus and then by Georg Simler at the academy of Pfortzheim. Reuchlin took an interest in him, and, following a contemporary custom, named him Melanchthon (the Greek form of Schwartzerd, black earth). In October 1509 he went to Heidelberg, where he took the B.A. degree, afterwards proceeding M.A. at Tübingen. The only other academic distinction he accepted was the B.D. of Wittenberg (1510). He would never consent to become a "doctor," because he thought the title carried with it responsibilities to which he felt himself unequal. At Tübingen he lived as student and teacher for six years, until on Reuchlin's advice, the elector of Saxony called him to Wittenberg as professor of Greek in 1518.

¹ Her character is evidenced by the familiar proverb—

Wer mehr will verzehren
Denn sein Pflug kann erheben,
Der muss zuletzt verderben
Und vielleicht am Galgen sterben—

of which Melanchthon said to his students "Didici hoc a mea matre, vos etiam observate." (For Melanchthon's Latin version of the saying see *Corpus reformatorum*, x. 469.)

This appointment marked an epoch in German university education; Wittenberg became the school of the nation; the scholastic methods of instruction were set aside, and in a *Discourse on Reforming the Studies of Youth* Melanchthon gave proof, not only that he had caught the Renaissance spirit, but that he was fitted to become one of its foremost leaders. He began to lecture on Homer and the Epistle to Titus, and in connexion with the former he announced that, like Solomon, he sought Tyrian brass and gems for the adornment of God's Temple. Luther received a fresh impulse towards the study of Greek, and his translation of the Scriptures, begun as early as 1517, now made rapid progress, Melanchthon helping to collate the Greek versions and revising Luther's translation. Melanchthon felt the spell of Luther's personality and spiritual depth, and seems to have been prepared on his first arrival at Wittenberg to accept the new theology, which as yet existed mainly in subjective form in the person of Luther. To reduce it to an objective system, to exhibit it dialectically, the calmer mind of Melanchthon was requisite.

Melanchthon was first drawn into the arena of the Reformation controversy through the Leipzig Disputation (June 27-July 8, 1519), at which he was present. He had been reproved by Johann Eck for giving aid to Carlstadt ("Tace tu, Philippe, ac tua studia cura nec me perturba"), and he was shortly afterwards himself attacked by the great papal champion. Melanchthon replied in a brief and moderately worded treatise, setting forth Luther's first principle of the supreme authority of Scripture in opposition to the patristic writings on which Eck relied. His marriage in 1520 to Catharine Krapp of Wittenberg gave a domestic centre to the Reformation. In 1521, during Luther's confinement in the Wartburg, Melanchthon was leader of the Reformation cause at the university. He defended the action of Carlstadt, when he dispensed the Eucharist in an "evangelical fashion."²

With the arrival of the Anabaptist enthusiasts of Zwickau, he had a more difficult task, and appears to have been irreligious. Their attacks on infant baptism seemed to him not altogether irrational, and in regard to their claim to personal inspiration he said "Luther alone can decide; on the one hand let us beware of quenching the Spirit of God, and on the other of being led astray by the spirit of Satan." In the same year, 1521, he published his *Loci communes rerum theologicarum*, the first systematized presentation of the reformed theology. From 1522 to 1524 he was busy with the translation of the Bible and in publishing commentaries. In 1524 he went for reasons of health into southern Germany and was urged by the papal legate Campegio to renounce the new doctrines. He refused, and maintained his refusal by publishing his *Summa doctrinae Lutheri*.

After the first Diet of Spire (1526), where a precarious peace was patched up for the reformed faith, Melanchthon was deputed as one of twenty-eight commissioners to visit the reformed states and regulate the constitution of churches, he having just published a famous treatise called the *Libellus visitatorius*, a directory for the use of the commissioners. At the Marburg conference (1529) between the German and Swiss reformers, Luther was pitted against Oecolampadius and Melanchthon against Zwingli in the discussion regarding the real presence in the sacrament. How far the normally conciliatory spirit of Melanchthon was here biased by Luther's intolerance is evident from the exaggerated accounts of the conference written by the former to the elector of Saxony. He was at this time even more embittered than Luther against the Zwinglians. At the Diet of Augsburg (1530) Melanchthon was the leading representative of the reformation, and it was he who prepared for that diet the seven-teen articles of the Evangelical faith, which are known as the "Augsburg Confession." He held conferences with Roman divines appointed to adjust differences, and afterwards wrote an *Apology for the Augsburg Confession*. After the Augsburg

² He read the usual service, but omitted everything that taught a propitiatory sacrifice; he did not elevate the Host, and he gave both the bread and the cup into the hands of every communicant.

conference further attempts were made to settle the Reformation controversy by a compromise, and Melancthon, from his conciliatory spirit and facility of access, appeared to the defenders of the old faith the fittest of the reformers to deal with. His historical instinct led him ever to revert to the original unity of the church, and to regard subsequent errors as excrescences rather than proofs of an essentially anti-Christian system. He was weary of the *rabies theologorum*, and dreamed that the evangelical leaven, if tolerated, would purify the church's life and doctrine. In 1537, when the Protestant divines signed the Lutheran Articles of Schmalkalden, Melancthon appended to his signature the reservation that he would admit of a pope provided he allowed the gospel and did not claim to rule by divine right.

The year after Luther's death, when the battle of Mühlberg (1547) had given a seemingly crushing blow to the Protestant cause, an attempt was made to weld together the evangelical and the papal doctrines, which resulted in the compilation by Pflug, Sidonius and Agricola of the Augsburg "Interim." This was proposed to the two parties in Germany as a provisional ground of agreement till the decision of the Council of Trent. Melancthon, on being referred to, declared that, though the Interim was inadmissible, yet so far as matters of indifference (*adiaphora*) were concerned it might be received. Hence arose that "adiaphoristic" controversy in connexion with which he has been misrepresented as holding among matters of indifference such cardinal doctrines as justification by faith, the number of the sacraments, as well as the dominion of the pope, feast-days, and so on. The fact is that Melancthon sought, not to minimize differences, but to veil them under an intentional obscurity of expression. Thus he allowed the necessity of good works to salvation, but not in the old sense; proposed to allow the seven sacraments, but only as rites which had no inherent efficacy to salvation, and so on. He afterwards retracted his compliance with the *adiaphora*, and never really swerved from the views set forth in the *Loci communes*; but he regarded the surrender of more perfect for less perfect forms of truth or of expression as a painful sacrifice rendered to the weakness of erring brethren. Luther, though he had probably uttered in private certain expressions of dissatisfaction with Melancthon, maintained unbroken friendship with him; but after Luther's death certain smaller men formed a party emphasizing the extreme points of his doctrine.¹ Hence the later years of Melancthon were occupied with controversies within the Evangelical church, and fruitless conferences with his Romanist adversaries. He died in his sixty-third year, on the 19th of April 1560, and his body was laid beside that of Martin Luther in the Schlosskirche at Wittenberg.

His ready pen, clear thought and elegant style, made him the scribe of the Reformation, most public documents on that side being drawn up by him. He never attained entire independence of Luther, though he gradually modified some of his positions from those of the pure Lutherism with which he set out. His development is chiefly noteworthy in regard to these two leading points—the relation of the *evangelium* or doctrine of free grace (1) to free will and moral ability, and (2) to the law and *poenitentia* or the good works connected with repentance. At first Luther's cardinal doctrine of grace appeared to Melancthon inconsistent with any view of free will; and, following Luther, he renounced Aristotle and philosophy in general, since "philosophers attribute everything to human power, while the sacred writings represent all moral power as lost by the fall." In the first edition of the *Loci* (1521) he held, to the length of fatalism, the Augustinian doctrine of irresistible grace, working according to God's immutable decrees, and denied freedom of will in matters civil and religious alike. In the Augsburg Confession (1530), which was largely due to him, freedom is claimed for the will in non-religious matters, and in the *Loci* of 1533 he calls the denial of freedom Stoicism, and holds that in justification there is a certain causality, though not worthiness, in the recipient, subordinate to the Divine causality. In 1535, combating Laurentius Valla, he did not deny the spiritual incapacity of the will *per se*, but held that this is strengthened by the word of God, to which it can cleave. The will co-operates with the word and the Holy Spirit. Finally, in 1543, he says that the cause of the difference of final destiny among men lies in the

different method of treating grace which is possible to believers as to others. Man may pray for help and reject grace. This he calls free will, as the power of laying hold of grace. Melancthon's doctrine of the three concurrent causes in conversion, viz. the Holy Spirit, the word, and the human will, suggested the semi-Pelagian position called Synergism, which was held by some of his immediate followers.

In regard to the relation of grace to repentance and good works, Luther was disposed to make faith itself the principle of sanctification. Melancthon, however, for whom ethics possessed a special interest, laid more stress on the law. He began to do this in 1527 in the *Libellus visitatorius*, which urges pastors to instruct their people in the necessity of repentance, and to bring the threatenings of the law to bear upon men in order to faith. This brought down upon him the opposition of the Antoninian Johannes Agricola. In the *Loci* of 1533 Melancthon sought to put the fact of the co-existence of justification and good works in the believer on a secure basis by declaring the latter necessary to eternal life, though the believer's destiny thereto is already fully guaranteed in his justification. In the *Loci* of 1543 he did not retain the doctrine of the necessity of good works in order to salvation, and to this he added, in the Leipzig Interim, "that this in no way countenances the error that eternal life is merited by the worthiness of our own works." Melancthon was led to lay more and more stress upon the law and moral ideas; but the basis of the relation of faith and good works was never clearly brought out by him, and he at length fell back on his original position, that we have justification and inheritance of bliss in and by Christ alone, and that good works are necessary by reason of immutable Divine command.

BIBLIOGRAPHY.—The principal works of Melancthon, with the bulk of his correspondence, are contained in the *Corpus reformationis* (vols. i.-xxviii.; Halle, 1834-1850), edited by Bretschneider and Binsfeld, to which must be added Binsfeld's *Supplementa* (Halle, 1874). Melancthon's earliest and best biographer was his friend Joachim Camerarius (1566), a new annotated edition of which is much needed. The best modern life is that by Georg Ellinger (Berlin, 1902); next is that of Karl Schmidt (Eberfeld, 1861). The production in 1897 of the 400th anniversary of Melancthon's birth produced many short biographies and *Festreden*, among them works by J. W. Richard (New York and London, 1898); George Wilson (London, 1897); Karl Sell (Halle, 1897); Ferdinand Cohrs (Halle, 1897); Beyschlag and Harnack (1897). Richard Ross (*Festrede*, 1896) also is good. The most learned of modern Melancthon scholars was probably Karl Hartfelder, who wrote *Philipp Melancthon als Praeceptor Germaniae* (Berlin, 1899); *Melancthoniana paedagogica* (Leipzig, 1892), giving in the first named two full bibliographies, one of all works written on Melancthon, the other of all works written by him (in chronological order). Hartfelder believed that a good deal of unpublished material is still left in German and foreign libraries. Thus three long unknown letters are published in the *Quellen und Forschungen* of the Königl. Preuss. Inst. für d. Kunde v. d. Prov. v. Pommern, vol. i. (1890) of Augsburg and one to Lazarus von Schwendi. Melancthon was on his way to the Council of Trent as delegate of the elector of Saxony and the cardinal had offered to meet him at Dillingen. He writes "ingeminating peace," deploring that the council was not a national synod, which would have been a better means of arriving at the truth.

MELANESIA, one of the three great divisions of the oceanic islands in the central and western Pacific. It embraces the Bismarck Archipelago, N.E. of New Guinea, the Louisiade, Solomon, Santa Cruz, New Hebrides and Loyalty islands, New Caledonia, Fiji and intervening small groups. The name (Gr. μέλας, black, and νῆσος, island) is derived from the black colour of the prevailing native race, the Papuan and its allied tribes. Many of these differ widely from the parent race, but all the Melanesian peoples have certain common characteristics which distinguish them sharply from the inhabitants of Polynesia and Micronesia. Their civilization is lower. The Melanesians are mostly "negroid," nearly black, with crisp, curly hair elaborately dressed; their women hold a much lower position than among the Polynesians; their institutions, social, political and religious, are simpler, their manners ruder; they have few or no traditions; cannibalism, in different degrees, is almost universal; but their artistic skill and taste, as with some of the lower African negroes, are remarkable, and they are amenable to discipline and fair treatment. Their languages, which exhibit considerable difference among themselves, have features which mark them off clearly from the Polynesian, notwithstanding certain fundamental relations with the latter.

See R. H. Codrington, *The Melanesian Languages* (Oxford, 1885) and *The Melanesians* (Oxford, 1891); the articles PAPUANS and PACIFIC OCEAN; also those on the several island-groups, &c.

¹ It must be admitted, however, that Matthias Flacius saved the Reformation.

MELANTHIUS, a noted Greek painter of the 4th century B.C. He belonged to the school of Sicily, which was noted for fine drawing.

MELBA [NELLIE PORTER ARMSTRONG] (1859—), British operatic soprano, *née* Nellie Porter Mitchell, was born at Burnley, near Melbourne, Australia, her father being a contractor, of Scottish blood. She sang at a local concert when six years old, and was given a good musical education. In 1882 she married Captain Charles Armstrong, and in 1886 went to study singing in Paris under the famous teacher, Madame Mathilde Marchesi, whose daughter, Madame Blanche Marchesi, also a famous singer, was associated with her. In 1887 she made her debut in opera at Brussels, taking the stage-name of Madame Melba from her connexion with Melbourne. In the next year she sang the part of Lucia, which remained one of her famous rôles, at Covent Garden, London; and, though critics complained of her coldness as an actress, her liquid voice and brilliant execution henceforth made her famous as the greatest successor to Patti, in pure vocalization, on the operatic stage. She maintained this position for over twenty years, her triumphs being celebrated in every country.

See the "authorized" biography by Agnes G. Murphy (1909).

MELBOURNE, WILLIAM LAMB, 2ND VISCOUNT (1779—1848), English statesman, second son of the 1st Viscount Melbourne, by his marriage with the daughter of Sir Ralph Milbanke, bart., was born on the 15th of March 1779. His father, Peniston Lamb (1748—1829), was the son of Sir Matthew Lamb, bart. (d. 1768), who made a large fortune out of the law, and married Miss Coke of Melbourne Hall; in 1770 he was made baron and in 1781 Viscount Melbourne in the Irish peerage, and in 1815 was created an English peer. After completing his course at Trinity College, Cambridge, William Lamb studied law at the university of Glasgow, and was called to the bar in 1804. In 1805 he married Lady Caroline Ponsonby (1785—1828), daughter of the 3rd earl of Bessborough. She was, however, separated from him in 1825. Lady Caroline Lamb acquired some fame as a novelist by her romance of *Glenarvon*, which was published anonymously in 1816 and was afterwards (1865) re-issued under the title of *The Fatal Passion*. On entering parliament in 1806 the Hon. William Lamb (as Lord Melbourne then was) joined the opposition under Fox, of whom he was an ardent admirer; but his Liberal tendencies were never decided, and he not infrequently supported Lord Liverpool during that statesman's long tenure of office. During the short ministry of Canning in 1827 he was chief secretary for Ireland, but he afterwards for a time adhered to the small remnant of the party who supported the duke of Wellington. The influence of Melbourne as a politician dates from his succeeding to the peerage in 1829. Disagreeing with the duke of Wellington on the question of parliamentary reform, he entered the ministry of Grey, as home secretary in 1830. For the duties of this office at such a critical time he was deficient in insight and energy, but his political success was independent of his official capacity; and when the ministry of Grey was wrecked on the Irish question in July 1834 Melbourne was chosen to succeed him as prime minister. In November following he had to give place to a Conservative ministry under Peel; but he resumed office in April 1835, and remained prime minister till 1841. He died at Melbourne House, Derbyshire, on the 24th of November 1848.

Lord Melbourne was without the qualification of attention to details, and he never displayed those brilliant talents which often form a substitute for more solid acquirements. Though he possessed a fine and flexible voice, his manner as a speaker was ineffective, and his speeches were generally ill-arranged and destitute of oratorical point. His political advancement was due to his personal popularity. He had a thorough knowledge of the private and indirect motives which influence politicians, and his genial attractive manner, easy temper and vivacious, if occasionally coarse, wit helped to confer on him a social distinction which led many to take for granted his eminence as a statesman. His favourite dictum in politics was, "Why not leave it alone?" His relations with women gave opportunity

for criticism though not open scandal; but the action brought against him in 1836 by Mr George Chapple Norton in regard to the famous Mrs Caroline Norton (*q.v.*) was deservedly unsuccessful. The most notable and estimable feature of his political conduct was his relation to Queen Victoria (*q.v.*), whom he initiated into the duties of sovereignty with the most delicate tact and the most paternal and conscientious care.

Melbourne was succeeded as 3rd viscount by his brother, Frederick James Lamb (1782—1853), who was British ambassador to Vienna from 1831 to 1841. On the 3rd viscount's death the titles became extinct, but the estates passed to his sister Emily Mary (1787—1869), the wife of Lord Palmerston.

See W. McC. Torrens, *Memoirs of Lord Melbourne* (1878); Lloyd Sanders, *Lord Melbourne's Papers* (1889); A. Hayward's essay (from the *Quarterly Review*, 1878) in "Eminent Statesmen" (1880).

MELBOURNE, the capital of Victoria, and the most populous city in Australia. It is situated on Hobson's Bay, a northern bend of the great harbour of Port Phillip, in Bourke county, about 500 m. S.W. of Sydney. The suburbs extend along the shores of the bay for more than 10 m., but the part distinctively known as the "city" occupies a site about 3 m. inland on the north bank of the Yarra river. The appearance of Melbourne from the sea is by no means picturesque. The busy shipping suburbs of Port Melbourne and Williamstown occupy the flat alluvial land at the mouth of the Yarra. But the city itself has a different aspect; its situation is relieved by numerous gentle hills, which show up its fine public buildings to great advantage; its main streets are wide and well kept, and it has an air of prosperity, activity and comfort. The part especially known as the "city" occupies two hills, and along the valley between them runs the thoroughfare of Elizabeth Street. Parallel to this is Swanston Street, and at right angles to these, parallel to the river, are Bourke Street, Collins Street and Flinders Street—the first being the busiest in Melbourne, the second the most fashionable with the best shops, and the third, which faces the river, given up to the maritime trade. These streets are an eighth of a mile apart, and between each is a narrower street bearing the name of the wider, with the prefix "Little." The original plan seems to have been to construct these narrow streets to give access to the great business houses which, it was foreseen, would be built on the frontage of the main streets. This plan, however, miscarried, for space grew so valuable that large warehouses and business establishments have been erected in these lanes. Little Flinders Street, in which the great importers' warehouses are mainly situated, is locally known as "the Lane." In the centre of the city some of the office buildings are ten, twelve or even fourteen storeys high. The main streets are 99 ft. wide, and the lanes somewhat less than half that width. Round the city lies a circle of populous suburbs—to the north-east Fitzroy (pop. 31,687) and Collingwood (32,749), to the east Richmond (37,824), to the south-east Prahran (40,441), to the south South Melbourne (40,619), to the south-west Port Melbourne (12,716), and to the north-west North Melbourne (18,120). All these suburbs lie within 3 m. of the general post office in Elizabeth Street; but outside this and within the 5 m. radius is another circle—to the east (20,546) and Hawthorne (21,430), to the south-east St Kilda (29,942) and Brighton (10,047), to the south-west Williamstown (14,052) and Footscray (18,318), to the north-west Essendon (17,426), and Flemington and Kensington (10,946) and to the north Brunswick (24,141). Numerous small suburbs fill the space between the two circles, the chief being Northcote, Preston, Camberwell, Toorak, Caulfield, Elsternwick and Coburg. Some of these suburbs are independent cities, others separate municipalities. In spite of the value of land, Melbourne is not a crowded city.

The Parliament House, standing on the crown of the eastern hill, is a massive square brick building with a pillared freestone façade approached by a broad flight of steps. The interior is lavishly decorated and contains, besides the legislative chambers, a magnificent library of over 52,000 volumes. At the top of



MELBOURNE and Environs.

Natural Scale. 1:70,000
English Miles

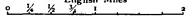

Reference.

- | | |
|--|-----------------------------|
| 1. Parliament Houses | 10. Victoria Markets |
| 2. Treasury Buildings | 11. Princess Theatre |
| 3. Law Courts | 12. Theatre Royal |
| 4. Mint | 13. St. Patrick's Cathedral |
| 5. Town Hall | 14. Independent Congl. Ch |
| 6. General Post Office | 15. Scote Church |
| 7. Custom House | 16. Anglican Cathedral |
| 8. Free Public Library and Art Gallery | 17. Melbourne Hospital |
| 9. Trades Hall | 18. Alfred Hospital |
| | 19. Homoeopathic Hospital |

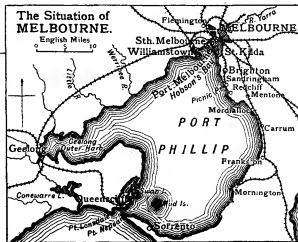

Collins Street a building in brown freestone is occupied by the Treasury, behind which and fronting the Treasury Park another palatial building houses the government offices. A little further on is St Patrick's Roman Catholic cathedral, the seat of the archbishop of Melbourne, a building of somewhat sombre blue-stone. Two striking churches face each other in Collins Street, the Scots church, a Gothic edifice with a lofty spire, and the Independent church, a fine Saracenic building with a massive campanile. The seat of the Anglican bishop, St Paul's cathedral, has an elegant exterior and a wealth of elaborate workmanship within, but stands low and is obscured by surrounding warehouses. On the western hill are the law courts, a fine block of buildings in classic style surmounted by a central dome. In Swanston Street there is a large building where under one roof are found the public library of over 100,000 volumes, the museum of sculpture, the art gallery, and the museums of ethnology and technology. In connexion with the art gallery there is a travelling scholarship for art students, endowed by the state. The Exhibition Buildings are situated on a hill in Carlton Gardens; they consist of a large cruciform hall surmounted by a dome and flanked by two annexes. Here on the 9th of May 1901 the first federal parliament of the Australian commonwealth was opened by King George V. (as duke of Cornwall and York). The Trades Hall at Carlton is the meeting-place of the trades-unions societies of Victoria, and is the focus of much political influence. The Melbourne town hall contains a central chamber capable of accommodating 3000 people. The suburban cities and towns have each a town hall. The residence of the governor of the colony is in South Melbourne, and is surrounded by an extensive domain. The university is a picturesque mass of buildings in large grounds about a mile from the heart of the city. It comprises the university buildings proper, the medical school, the natural history museum, the Wilson Hall, a magnificent building in the Perpendicular style, and the three affiliated colleges, Trinity College (Anglican), Ormond College (Presbyterian) and Queen's College (Wesleyan). The university, established in 1855, is undenominational, and grants degrees in the faculties of arts, law, medicine, science, civil engineering and music; instruction in theology is left to the affiliated colleges. Melbourne has numerous state schools, and ample provision is made for secondary education by the various denominations and by private enterprise. Of theatres, the Princess and the Theatre Royal are the most important. Other public buildings include the mint, the observatory, the Victoria markets, the Melbourne hospital, the general post office, the homoeopathic hospital, the custom house and the Alfred hospital. Many of the commercial buildings are of architectural merit, notably the banks, of which the bank of Australasia, a massive edifice of the Doric order, and the Gothic Australian bank are the finest examples.

The public gardens and parks of Melbourne are extensive. Within the city proper the Fitzroy Gardens are a network of avenues bordered with oak, elm and plane, with a "fern-tree gully" in the centre; they are ornamented with casts of famous statues, and ponds, fountains and classic temples. The Treasury, Flagstaff and Carlton Gardens are of the same class. Around the city lie five great parks—Royal Park, in which are excellent zoological gardens; Yarra Park, which contains the leading cricket grounds; the Botanical Gardens, sloping down to the banks of the river; Albert Park, in which is situated a lake much used for boating; and Studley Park on the Yarra river, a favourite resort which has been left in a natural state. Besides these parks, each suburb has its public gardens, and at Flemington there is a fine race-course, on which the Melbourne cup races are run every November, an event which brings in a large influx of visitors from all parts of Australia. Melbourne has a complete tramway system; all the chief suburbs are connected with the city by cable trams. The tramways are controlled by a trust, representing twelve of the metropolitan municipalities. The chief monuments and statues of the city are the statue of Queen Victoria in the vestibule of the Houses of Parliament, and a colossal group commemorating the explorers Robert O'Hara Bourke (b. 1820) and William John Wills (b. 1834), who died of

starvation in 1861 on an expedition for the crossing of Australia from south to north. There are also the statue to Sir Redmond Barry, first chancellor of the university, outside the public library, the Gordon statue in Spring Street, a replica of that in Trafalgar Square, London, and a statue of Daniel O'Connell, outside St Patrick's cathedral.

Port Melbourne, originally called Sandridge, is about $\frac{2}{3}$ m. distant from the city, with which it is connected by rail and tramway. It has two large piers, alongside of which vessels of almost any tonnage can lie. One of these piers is served by the railway, and here most of the great liners are berthed. Vessels drawing 22 ft. of water can ascend the river Yarra to the heart of the city. There are 2 m. of wharves along each bank of the river, with two large dry-docks and ship-repairing yards and foundries. Below Queen's Bridge is an expansion of the river known as the Pool, in which the largest ships using the river can turn with ease. Leading from a point opposite the docks is the Cooce canal, by means of which the journey from the city to the mouth of the river is shortened by over a mile. As a port Melbourne takes the first place in Australia as regards tonnage. It is also a great manufacturing centre, and both city and suburbs have their distinctive industries. The chief are tanning, fellmongery, wool-washing, bacon-curing, flour milling, brewing, iron-founding, brick-making, soap-boiling, the manufacture of pottery, candles, cheese, cigars, snuff, jams, biscuits, jewelry, furniture, boots, clothing and leather and woollen goods.

The climate of Melbourne is exceptionally fine; occasionally hot winds blow from the north for two or three days at a time, but the proportion of days when the sky is clear and the air dry and mild is large. Snow is unknown, and the average annual rainfall is 25.58 in. The mean annual temperature is 57.3° F., corresponding to that of Washington in the United States, and to Lisbon and Messina in Europe. The city is supplied with water from the Yan Yean works, an artificial lake at the foot of the Plenty Range, nearly 19 m. distant.

The little settlement of the year 1835, out of which Melbourne grew, at first bore the native name of Dootigala, but it was presently renamed after Viscount Melbourne, premier of Great Britain at the time of its foundation. In June 1836 it consisted of only thirteen buildings, eight of which were turf huts. For two years after that date a constant stream of squatters with their sheep flowed in from around Sydney and Tasmania to settle in the Port Phillip district, and by 1841 the population of the town had grown to 11,000. The discovery of gold at Ballarat in 1851 brought another influx of population to the district, and the town grew from 30,000 to 100,000 in the course of two or three years. In 1842 Melbourne was incorporated and first sent members to the New South Wales parliament. A strong popular agitation caused the Port Phillip district to be separated from New South Wales in 1851, and a new colony was formed with the name of Victoria, Melbourne becoming its capital. In 1901 Melbourne became the temporary capital of the Australian commonwealth pending the selection of the permanent capital in New South Wales. The population of the city proper in 1901 was 68,374, and that of "greater Melbourne" was 496,079.

MELBOURNE, a market town in the southern parliamentary division of Derbyshire, England, 8 m. S.S.E. of Derby, on the Midland railway. Pop. (1901), 3580. It lies in an undulating district on a small southern tributary of the Trent, from which it is about 2 m. distant. The church of St Michael is a fine example of Norman work, with certain late details, having clerestoried nave, chancel and aisles, with central and two western towers. Melbourne Hall, a building of the time of William III., surrounded by formal Dutch gardens, stands in a domain owned at an early date by the bishops of Carlisle, whose tithe barn remains near the church. They obtained the manor in 1133. In 1311 Robert de Holland fortified a mansion here, and in 1327 this castle belonged to Henry, earl of Lancaster; but it was dismantled in 1460, and little more than the site is now traceable. The title of Viscount Melbourne was taken from this town. There are manufactures of silk, and boots and shoes.

MELCHERS, (JULIUS) GARI (1860—), American artist, was born at Detroit, Michigan, on the 11th of August 1860. The son of a sculptor, at seventeen he was sent to Düsseldorf to study art under von Gebhardt, and after three years went to Paris, where he worked at the Académie Julien and the École des Beaux Arts. Attracted by the pictorial side of Holland, he settled at Egmond. His first important Dutch picture, "The Sermon," brought him honourable mention at the Paris Salon of 1886. He became a member of the National Academy of Design, New York; the Royal Academy of Berlin; Société Nationale des Beaux Arts, Paris; International Society of Painters, Sculptors and Engravers, London, and the Secession Society, Munich; and, besides receiving a number of medals, his decorations include the Legion of Honour, France; the order of the Red Eagle, Germany; and knight of the Order of St Michael, Bavaria. Besides portraits, his chief works are: "The Supper at Emmaus," in the Krupp collection at Essen; "The Family," National Gallery, Berlin; "Mother and Child," Luxembourg; and the decoration, at the Congressional Library, Washington, "Peace and War."

MELCHIADES, or MILTIADES (other forms of the name being Meltiades, Melciades, Miltiades and Miltides), pope from the 2nd of July 310, to the 11th January 314. He appears to have been an African by birth, but of his personal history nothing is known. The toleration edicts of Galerius and of Constantine and Licinius were published during his pontificate, which was also marked by the holding of the Lateran synod in Rome (313) at which Caecilianus, bishop of Carthage, was acquitted of the charges brought against him and Donatus condemned. Melchiades was preceded and followed by Eusebius and Silvester I. respectively.

MELCHITES (lit. Royalists, from Syriac *melcho*, a king), the name given in the 5th century to those Christians who adhered to the creed supported by the authority of the Byzantine emperor. The Melchites therefore are those who accept the decrees of Ephesus and Chalcedon as distinguished from the Nestorians and Jacobite Church (*qq.v.*). They follow the Orthodox Eastern liturgy, ceremonial and calendar, but acknowledge the papal and doctrinal authority of Rome. They number about 80,000, are found in Syria, Palestine and Egypt, and are under the immediate rule of the patriarch of Damascus and twelve bishops.

MELCHIZEDEK (Heb. for "king of righteousness"; or, since Šedeč is probably the name of a god, "Šedeč is my king"); king of Salem and priest of "supreme El" (*El' 'elyon*), in the Bible. He brought forth bread and wine to Abraham on his return from the expedition against Chedorlaomer, and blessed him in the name of the supreme God, possessor (or maker) of heaven and earth; and Abraham gave him tithes of all his booty (Gen. xiv. 18-20). Biblical tradition tells us nothing more about Melchizedek (cf. Heb. vii. 3); but the majestic figure of the king-priest, prior to the priesthood of the law, to whom even the father of all Israel paid tithes (cf. Jacob at Bethel, Gen. xxviii. 22), suggested a figurative or typical application, first in Psalm cx. to the vicegerent of Yahweh, seated on the throne of Zion, the king of Israel who is also priest after the order of Melchizedek, and then, after the Gospel had ensured the Messianic interpretation of the Psalm (Matt. xxii. 42 seq.), to the kingly priesthood of Jesus, as that idea is worked out at length in the Epistle to the Hebrews.

The theological interest which attaches to the idea of the pre-Aaronic king-priest in these typical applications is practically independent of the historical questions suggested by the narrative of Gen. xiv. The episode of Melchizedek, though connected with the main narrative by the epithets given to Yahweh in Gen. xiv. 22, breaks the natural connexion of verses 17 and 21, and may perhaps have come originally from a separate source. As the narrative now stands Salem must be sought in the vicinity of "the king's dale," which from 2 Sam. xviii. 18, probably, but not necessarily, lay near Jerusalem. That Salem is Jerusalem, as in Psalm lxxvi. 2,

is the ancient and common view; but even in the 15th century B.C. Jerusalem was known as Uru-salim. Jerome and others have identified Salim with one or other of the various places which bear that name, e.g. the Σαλίμ of John iii. 23, 8 m. south of Beth-shean. In a genuine record of extreme antiquity the union of king and priest in one person, the worship of El as the supreme deity by a Canaanite,² and the widespread practice of the consecration of a tithe of booty can present no difficulty; but, if the historical character of the narrative is denied, the date of the conception must be placed as late as the rise of the temporal authority of the high priests after the exile. So far no evidence has been found in the cuneiform inscriptions or elsewhere in support either of the genuineness of the episode in its present form, or of the antiquity which is attributed to it (see further, J. Skinner, *Genesis*, pp. 269 sqq.). An ancient legend identifies Melchizedek with Schem (Palestinian Targum, Jerome on Isa. xlii., Ephraem Syrus *in loco*).

See further the literature on Gen. xiv., and the articles ABRAHAM, GENESIS. (W. R. S.; S. A. C.)

MELCOMBE, GEORGE BUBB DODDINGTON, BARON (1691-1762), English politician. His father's name was Bubb, but the son took the name of Doddington on inheriting a large property by the death of an uncle of that name (1720). He was educated at Oxford. In 1715 he was returned to parliament as member for Winchelsea, and was sent as envoy extraordinary to Spain. He carried on a scandalous traffic in the five or six parliamentary votes which he controlled, his tergiversation and venality furnishing food for the political satirists and caricaturists of the day. His most estimable political action was his defence of Admiral Byng in the House of Commons (1757). From 1722 to 1754 he sat in parliament for Bridgewater; from 1724 to 1740 was a lord of the treasury; and, in 1744, became treasurer of the navy under Henry Pelham, and, again in 1755, under Newcastle and Fox. In April 1761 he was raised to the peerage as Baron Melcombe of Melcombe Regis in Dorsetshire. He died at La Trappe, his Hammersmith house, on the 28th of July 1762. His wife, acknowledged only after the death of another lady to whom he had given a bond that he would marry no one else, died without issue. He was a wit and a friend of wits, a good scholar, and something of a Maecenas; Thomson's "Summer" was dedicated to him, Fielding addressed to him an epistle and Edward Young a satire. He was a leading spirit of the "Hell-fire" Club, whose members, called "Franciscans," from their founder Sir Francis Dashwood (d. 1781), held their revels in the ruined Cistercian abbey of Medmenham, Bucks.

His diary, published in 1784, reveals him in his character of place-hunter and throws a curious light on the political methods of the time.

MELEAGER (Gk. Μελάγρος), in Greek legend, the son of Oeneus, king of Calydon, and Althaea. His father having neglected to sacrifice to Artemis, she sent a wild boar to ravage the land, which was eventually slain by Meleager. A war broke out between the Calydonians and Curetes (led by Althaea's brothers) about the disposal of the head and skin, which Meleager awarded as a prize to Atalanta, who had inflicted the first wound; the brothers of Althaea lay in wait for Atalanta and robbed her of the spoils, but were slain by Meleager. When Althaea heard this, she cursed Meleager, who withdrew, and refused to fight until the Curetes were on the point of capturing the city of Calydon. Then, yielding to his wife's entreaties, he sallied forth and defeated the enemy, but was never seen again, having been carried off by the Erinyes, who had heard his mother's curse (or he was slain by Apollo in battle). According to a later tradition, not known to Homer, the Moerae appeared to Althaea when Meleager was seven days old, and announced that the child would only live as long as the log blazing on the hearth remained unconsumed. Althaea thereupon seized the log, extinguished the flames, and hid it in a box. But, after her brothers' death, she relighted the log, and let it burn away until Meleager died.³ Then, horrified at what she had done, she hanged herself, or died of grief. The sisters of Meleager were

¹ The god 'Eloah' was also Phoenician; see Driver, *Genesis*, p. 165; Lagrange, *Religions Sémitiques*, Index, s.v.
² On the torch as representing the light of life, see E. Kuhner in *Rheinisches Museum*, xlix., 1894, and J. Grimm, *Teutonic Mythology* (Eng. trans. by J. Stallybrass, 1880), ii. 853.

³ It is to be noted also that the name is of the same form as Adoni-zedek, king of Jerusalem (Josh. x. 1), and that the un-Hebraic Aranauch of 2 Sam. xxiv. 16 is probably a corruption of the similar compound Adonijah (so Cheyne, *Ency. Bib. col.* 290).

changed by Artemis out of compassion into guinea fowls and removed to the island of Leros, where they mourned part of the year for their brother. The life and adventures of Meleager were a favourite subject in ancient literature and art. Meleager is represented as a tall, vigorous youth with curly hair, holding a javelin or a boar's head, and accompanied by a dog.

See R. Kekulé, *De fabula mealegra dissertatio* (1861); Surber, *Die Meleager Sage* (Zürich, 1880); articles on "Meleager" and "Meleagrides" in Roscher's *Lexikon der Mythologie*; L. Preller, *Griechische Mythologie*; Apollodorus i. 8; Homer, *Iliad*, ix. 527; Diod. Sic. iv. 34; Dio Chrysostom, Or. 67; Hyginus, *Fab. 171*; Ovid, *Metam.* viii. 260-545. In the article GREEK ART (fig. 41) the hunting of the Calydonian boar is represented on a fragment of a frieze from a heroum.

MELEDA (Serbo-Croatian, *Mljet*; Lat. *Melita*), the most southerly and easterly of the larger Adriatic islands of the Austrian province of Dalmatia. Pop. (1900), 1617. Melelda lies south of the Sabioncello promontory, from which it is divided by the Melelda Channel. Its length is 23 m.; its average breadth 2 m. It is of volcanic origin, with numerous chasms and gorges, of which the longest, the Babinopolje, connects the north and south of the island. Port Palazzo, the principal harbour, on the north, is a port of call for tourist steamers. Melelda has been regarded as the Melita on which St Paul was shipwrecked, this view being first expounded, in the 10th century, by Constantine Porphyrogenitus. As at Malta, a "St Paul's Bay" is still shown.

MELEGNANO (formerly *Marignano*), a town of Lombardy, Italy, in the province of Milan, 11 m. S.E. of that city by the railway to Piacenza, 289 ft. above sea-level. Pop. (1901), 6782. There are remains of a castle of the Visconti. Its military importance is due to its position at the crossing of the river Lambro. It was a stronghold of Milan in her great struggle against Lodi, and is famous for the victory of Francis I. of France over the Swiss in 1515, known as the battle of Marignan, and for the action between the French and Austrians in 1859.

MELENDEZ VALDÉS, JUAN (1754-1817), Spanish poet, was born at Ribera del Fresno, Badajoz, on the 11th of March 1754. Destined by his parents for the priesthood, he graduated in law at Salamanca, where he became indoctrinated with the ideas of the French philosophical school. In 1780 with *Butilo*, a pastoral in the manner of Garcilaso de la Vega, he won a prize offered by the Spanish academy; next year he was introduced to Jovellanos, through whose influence he was appointed to a professorship at Salamanca in 1783. The pastoral scenes in *Las Bodas de Camacho* (1784) do not compensate for its undramatic nature, but it gained a prize from the municipality of Madrid. A volume of verses, lyrical and pastoral, published in 1785, caused Melendez Valdés to be hailed as the first Spanish poet of his time. This success induced him to resign his chair at Salamanca, and try his fortune in politics. Once more the friendship of Jovellanos obtained for him in 1789 a judgeship at Saragossa, whence he was transferred two years later to a post in the chancery court at Valladolid. In 1797 he dedicated to Godoy an enlarged edition of his poems, the new matter consisting principally of unsuccessful imitations of Milton and Thomson; but the poet was rewarded by promotion to a high post in the treasury at Madrid. On the fall of Jovellanos in 1798 Melendez Valdés was dismissed and exiled from the capital; he returned in 1808 and accepted office under Joseph Bonaparte. He had previously denounced the French usurper in his verses. He now outraged the feelings of his countrymen by the grossest flattery of his foreign master, and in 1813 he fled to Alais. Four years later he died in poverty at Montpellier. His remains were removed to Spain in 1900. In natural talent and in acquired accomplishment Melendez Valdés was not surpassed by any contemporary Spaniard; he failed from want of character, and his profound insincerity affects his poems. Yet he has fine moments in various veins, and his imitation of Jean Second's *Basia* is notable.

MELETIUS OF ANTIOCH (d. 381), Catholic bishop and saint, was born at Melitene in Lesser Armenia of wealthy and noble parents. He first appears (c. 357) as a supporter of Acacius,

bishop of Caesarea, the leader of that party in the episcopate which supported the *Homoean* formula by which the emperor Constantius sought to effect a compromise between the Homoeusians and the Homousians. Meletius thus makes his début as an ecclesiastic of the court party, and as such became bishop of Sebaste in succession to Eustathius, deposed as an Homousian heretic by the synod of Melitene. The appointment was resented by the Homoeusian clergy, and Meletius retired to Berea. According to Socrates he attended the synod of Seleucia in the autumn of 359, and then subscribed the Acacian formula. Early in 360 he became bishop of Antioch, in succession to Eudoxius, who had been raised to the see of Constantinople. Early in the following year he was in exile. According to an old tradition, supported by evidence drawn from Epiphanius and Chrysostom, this was due to a sermon preached before the emperor Constantius, in which he revealed Homousian views. This explanation, however, is rejected by Loofs; the sermon contains nothing inconsistent with the Acacian position favoured by the court party; on the other hand, there is evidence of conflicts with the clergy, quite apart from any questions of orthodoxy, which may have led to the bishop's deposition.

The successor of Meletius was Euzoos, who had fallen with Arius under the ban of Athanasius; and Loofs explains the *subita fidei mutatio* which St Jerome (*ann. Abr.* 2376) ascribes to Meletius to the dogmatic opposition of the deposed bishop to his successor. In Antioch itself Meletius continued to have adherents, who held separate services in the "Apostolic" church in the old town. The Meletian schism was complicated, moreover, by the presence in the city of another anti-Arian sect, stricter adherents of the Homousian formula, maintaining the tradition of the deposed bishop Eustathius and governed at this time by the presbyter Paulinus. The synod of Alexandria sent deputies to attempt an arrangement between the two anti-Arian Churches; but before they arrived Paulinus had been consecrated bishop by Lucifer of Calaris, and when Meletius—free to return in consequence of the emperor Julian's contemptuous policy—reached the city, he found himself one of three rival bishops. Meletius was now between two stools. The orthodox Nicene party, notably Athanasius himself, held communion with Paulinus only; twice, in 365 and 371 or 372, Meletius was exiled by decree of the Arian emperor Valens. A further complication was added when, in 375, Vitalius, one of Meletius's presbyters, was consecrated bishop by the heretical bishop Apollinaris of Laodicea.

Meanwhile, under the influence of his situation, Meletius had been more and more approximating to the views of the newer school of Nicene orthodoxy. Basil of Caesarea, throwing over the cause of Eustathius, championed that of Meletius who, when after the death of Valens he returned in triumph to Antioch, was hailed as the leader of Eastern orthodoxy. As such he presided, in October 379, over the great synod of Antioch, in which the dogmatic agreement of East and West was established; it was he who helped Gregory of Nazianzus to the see of Constantinople and consecrated him; it was he who presided over the second oecumenical council at Constantinople in 381. He died soon after the opening of the council, and the emperor Theodosius, who had received him with especial distinction, caused his body to be carried to Antioch and buried with the honours of a saint. The Meletian schism, however, did not end with his death. In spite of the advice of Gregory of Nazianzus and of the Western Church, the recognition of Paulinus's sole episcopate was refused, Flavian being consecrated as Meletius's successor. The Eustathians, on the other hand, elected Evagrius as bishop on Paulinus's death, and it was not till 415 that Flavian succeeded in re-uniting them to the Church.

Meletius was a holy man, whose ascetic life was all the more remarkable in view of his great private wealth. He was also a man of learning and culture, and widely esteemed for his honourable, kindly and straightforward character. He is venerated as a saint and confessor in both the Roman Catholic and Orthodox Eastern Churches.

See the article G. F. Loofs in Herzog-Hauck, *Realencyklopädie* (ed. 1897, Leipzig), xii. 552, and authorities there cited.

MELETIUS OF LYCOPOLIS (4th century), founder of the sect known after him as the "Meletians," or as the "Church of the Martyrs," in the district of Thebes in Egypt. With Peter, archbishop of Alexandria, he was thrown into prison during the persecution under Diocletian. His importance is due to his refusal to receive, at least until the persecution had ceased, those Christians who during the persecutions had renounced their faith, and then repented. This refusal led to a breach with Peter, and other Egyptian bishops who were willing to grant absolution to those who were willing to do penance for their infidelity. Meletius, after regaining his freedom, held his ground and drew around him many supporters, extending his influence even so far away as Palestine. He ordained 29 bishops and encroached upon Peter's jurisdiction. The Council of Nicaea in 325 upheld the bishops, but Meletius was allowed to remain bishop of Lycopolis though with merely nominal authority. His death followed soon after. His followers, however, took part with the Arians in the controversy with Athanasius and existed as a separate sect till the 5th century.

See Achelis in Herzog-Hauck, *Realencyk.* xii. (1903) 558, with the authorities there quoted, and works on Church History.

MELFI, a city and episcopal see of Basilicata, Italy, in the province of Potenza, 30 m. by rail N. of the town of that name. Melfi is picturesquely situated on the lower slopes of Monte Vulture, 1591 ft. above sea-level. Pop. (1901), 14,547. The castle was originally erected by Robert Guiscard, but as it now stands it is mainly the work of the Doria family, who have possessed it since the time of Charles V.; and the noble cathedral which was founded in 1153 by Robert's son and successor, Roger, has had a modern restoration (though it retains its campaniles) in consequence of the earthquake of 1851, when the town was ruined, over one thousand of the inhabitants perishing. It is the centre of an agricultural district which produces oil and wine. In the town hall is a fine Roman sarcophagus found 6 m. W. of Venosa.

Melfi does not seem to occupy an ancient site, and its origin is uncertain. By the Normans it was made the capital of Apulia in 1041, and fortified. The council held by Nicholas I. in 1059, that of Urban II. in 1089, the rebellion against Roger in 1133 and the subsequent punishment, the plunder of the town by Barbarossa in 1167, the attack by Richard, count of Acerra in 1190, and the parliament of 1223, in which Frederick II. established the constitution of the kingdom of Naples, form the principal points of interest in the annals of Melfi. In 1348 Joanna I. of Naples bestowed the city on Niccolò Acciajuoli; but it was shortly afterwards captured, after a six months' siege, by the king of Hungary, who transferred it to Conrad the Wolf. In 1392 Goffredo Marzano was made count of Melfi; but Joanna II. granted the lordship to the Caracciolo family, and they retained it for one hundred and seven years till the time of Charles V. An obstinate resistance was offered by the city to Lautrec de Foix in 1528; and his entrance within its walls was followed by the massacre, it is said, of 18,000 of its citizens.

See G. de Lorenzo, *Venosa e la regione del Vulture* (Bergamo, 1906).

MELICERTES, in Greek legend, the son of the Boeotian prince Athamas and Ino, daughter of Cadmus. Ino, pursued by her husband, who had been driven mad by Hera because Ino had brought up the infant Dionysus, threw herself and Melicertes into the sea from a high rock between Megara and Corinth. Both were changed into marine deities—Ino as Leucothea, Melicertes as Palaemon. The body of the latter was carried by a dolphin to the Isthmus of Corinth and deposited under a pine tree. Here it was found by his uncle Sisyphus, who had it removed to Corinth, and by command of the Nereids instituted the Isthmian games and sacrifices in his honour. There seems little doubt that the cult of Melicertes was of foreign, probably Phoenician, origin, and introduced by Phoenician navigators on the coasts and islands of the Aegean and Mediterranean. He is a native of Boeotia, where Phoenician influences were strong; at Tenedos he was propitiated by the sacrifice of children, which seems to point to his identity with Melkart. The premature death of the child in the Greek form of the legend is probably an allusion to this.

The Romans identified Palaemon with Portunus (the harbour god). No satisfactory origin of the name Palaemon has been given. It has been suggested that it means the "wrestler" or "struggler" (*παλαίω*) and is an epithet of Heracles, who is often identified with Melkart, but there does not appear to be any traditional connexion between Heracles and Palaemon. Melicertes being Phoenician, Palaemon also has been explained as the "burning lord" (Baal-haman), but there seems little in common between a god of the sea and a god of fire.

See Apollodorus iii. 4, 3; Ovid, *Metam.* iv. 416-542, *Fasti*, vi. 485; Hyginus, *Fab. 2*; Pausanias i. 44, ii. 1; Philostratus, *Icones*, ii. 16; articles by Toutain in Darrobourg and Saglio's *Dictionnaire des antiquités* and by Stoll in Roehrer's *Lexikon der Mythologie*; L. Preller, *Grösische Mythologie*; R. Brown, *Semitic Influence in Hellenic Mythology* (1898).

MELILLA, a Spanish fortified station and penal settlement on the north coast of Morocco, south of Cape Tres Forcas and 135 m. E.S.E. of Ceuta. Pop. about 9000. The town is built on a huge rock connected with the mainland by a rocky isthmus. There is a harbour, only accessible to small vessels; the roadstead outside is safe and has deep water a mile to the east of the fortress. From the landing-place, where a mole is cut out of the rock, there is a steep ascent to the upper town, characteristically Spanish in appearance. The town is walled, and the isthmus protected by a chain of small forts. A Moorish custom-house is placed on the Spanish border beyond the fort of Santa Isabel, and is the only authorized centre of trade on the Riff coast between Tetuan and the Algerian frontier. It thus forms the entrepôt for the commerce of the Riff district and its hinterland. Goat skins, eggs and beeswax are the principal exports, cotton goods, tea, sugar and candles being the chief imports. For the period 1900-1905 the annual value of the trade was about £200,000. Melilla, the first place captured by Spain on the African mainland, was seized from the Moors in 1496. The Spaniards have had much trouble with the neighbouring tribes—turbulent Riffians, hardly subject to the sultan of Morocco. The limits of the Spanish territory round the fortress were fixed by treaties with Morocco in 1859, 1860, 1861 and 1894. In 1893 the Riffians besieged Melilla and 25,000 men had to be despatched against them. In 1908 two companies, under the protection of El Roghi, a chieftain then ruling the Riff region, started mining lead and iron some 15 m. from Melilla and a railway to the mines was begun. In October of that year the Riffians revolted from the Roghi and raided the mines, which remained closed until June 1909. On the 9th of July the workmen were again attacked and several of them killed. Severe fighting between the Spaniards and the tribesmen followed. The Riffians having submitted, the Spaniards, in 1910, restarted the mines and undertook harbour works at Mar Chica.

See Budget Meakin, *The Land of the Moors* (London, 1901), ch. xix., and the authorities there cited; P. Barré, "Melilla et les présides espagnols," *Rev. française* (1908).

MÉLINE, FÉLIX JULES (1838-), French statesman, was born at Remiremont on the 20th of May 1838. Having adopted the law as his profession, he was chosen a deputy in 1872, and in 1879 he was for a short time under-secretary to the minister of the interior. In 1880 he came to the front as the leading spokesman of the party which favoured the protection of French industries, and he had a considerable share in fashioning the protectionist legislation of the years 1890-1902. From 1883 to 1885 Méline was minister for agriculture, and in 1888-1889 he was president of the Chamber of Deputies. In 1896 he became premier (*président du conseil*) and minister for agriculture, offices which he vacated in 1898. At one time he edited *La République française*, and after his retirement from public life he wrote *Le Retour à la terre et la surproduction industrielle, tout en faveur de l'agriculture* (1905).

MÉLINGUE, ÉTIENNE MARIN (1808-1875), French actor and sculptor, was born in Caen, the son of a volunteer of 1792. He early went to Paris and obtained work as a sculptor on the church of the Madeleine, but his passion for the stage soon led him to join a strolling company of comedians. Finally chance gave him an opportunity to show his talents, and at the Porte Saint Martin he became the popular interpreter of romantic

drama of the Alexandre Dumas type. One of his greatest successes was as Benvenuto Cellini, in which he displayed his ability both as an actor and as a sculptor, really modelling before the eyes of the audience a statue of Hebe. He sent a number of statuettes to the various exhibitions, notably one of Gilbert Louis Duprez as William Tell. Melingue's wife, Thérédine Thiesset (1813-1886), was the actress selected by Victor Hugo to create the part of Guanhumara in *Burgroves* at the Comédie Française, where she remained ten years.

See Dumas, *Une Vie d'artiste* (1854).

MELIORISM (Lat. *melior*, better), in philosophy, a term given to that view of the world which believes that at present the sum of good exceeds the sum of evil and that, in the future, good will continually gain upon evil. The term is said to have been invented by George Eliot to express a theory mediating between optimism and pessimism. The pragmatic movement in philosophy which puts stress upon the duty and value of effort is naturally favourable to the melioristic view: the best things that have been said recently in favour of it are found in books such as William James's *Pragmatism*.

MELISSUS OF SAMOS, Greek philosopher of the Eleatic School (q.v.), was born probably not later than 470 B.C. According to Diogenes Laërtius, ix. 24, he was not only a thinker, but also a political leader in his native town, and was in command of the fleet which defeated the Athenians in 442. The same authority says he was a pupil of Parmenides and of Heraclitus, but the statement is improbable, owing to discrepancy in dates. His works, fragments of which are preserved by Simplicius and attested by the evidence of Aristotle, are devoted to the defence of Parmenides' doctrine. They were written in Ionic and consist of long series of argument. Being, he says, is eternal. It cannot have had a beginning because it cannot have begun from not-being (cf. *εξ nihilo nihilo*), nor from being (*εἰν γὰρ ἂν οὐτὼ καὶ οὐ γένοιστο*). It cannot suffer destruction; it is impossible for being to become not being, and if it became another being, there would be no destruction. According to Simplicius (*Physica*, l. 22b), he differed here from Parmenides in distinguishing being and absolute being (*τὸ ἀπλῶς ὄν*). He goes on to show that eternal being must also be unlimited in magnitude, and, therefore, one and unchangeable. Any change whether from internal or external source, he says, is unthinkable; the One is unvarying in quantity and in kind. There can be no division inside this unity, for any such division implies space or void; but void is nothing, and, therefore, is not. It follows further that being is incorporeal, inasmuch as all body has size and parts. The fundamental difficulty underlying this logic is the paradox more clearly expressed by Zeno and to a large extent represented in almost all modern discussion, namely that the evidence of the senses contradicts the intellect. Abstract argument has shown that change in the unity is impossible; yet the senses tell us that hot becomes cold, hard becomes soft, the living dies, and so on. From a comparison of Melissus with Zeno of Elea, it appears that the spirit of dialectic was already tentatively at work, though it was not conscious of its own power. Neither Melissus nor Zeno seems to have observed that the application of these destructive methods struck at the root not only of multiplicity but also of the One whose existence they maintained. The weapons which they forged in the interests of Parmenides were to be used with equal effect against themselves.

See Ritter and Preller, §§ 159-166; Brandis, *Commentationum eleaticarum*, pt. 1, p. 185; Mullach, *Aristotelis de Melisso, Xenophane, Gorgia*; Pabst, *De Melissi samii fragmentis* (Bonn, 1889), and histories of philosophy.

MELITO, bishop of Sardis, a Christian writer of the 2nd century, mentioned by Eusebius (*Hist. Eccl.* iv. 21) along with Hegesippus, Dionysius of Corinth, Apollinaris of Hierapolis, Irenaeus, and others, his contemporaries, as a champion of orthodoxy and upholder of apostolic tradition. Of his personal history nothing is known, and of his numerous works (which are enumerated—with quotations—by Eusebius) only a few fragments are extant. They included an *Apologia* addressed to

Antoninus some time between A.D. 169 and 180, two books relating to the paschal controversy, and a work entitled 'Εκλογαί (selections from the Old Testament), which contained the first Christian list of "the books of the Old Covenant." It excludes Esther, Nehemiah and the Apocrypha. The fragments have been edited with valuable notes by Routh (*Reliquiae sacrae*, vol. 1, 1814). These are sufficient to show that Melito was an important figure in Asia Minor and took much part in the paschal, Marcionite and Montanist controversies.

It seems more than doubtful whether the *Apologia* of Melito (the philosopher discovered in a Syriac translation by Henry Tattam (1789-1868), and subsequently edited by W. Cureton and by Pitra-Renan, ought to be attributed to this writer and not to another of the same name. The *Κεῖς* (clavis), edited by Pitra-Renan, is a much later Latin collection of mystical explanations of Scripture.

See A. Harnack, *Texte und Untersuchungen*, vi. 240-278 (Leipzig, 1882); Erwin Preuschen, s.v. "Melito" in Herzog-Hauck, *Realencyclopädie*, xii., 1903, giving full list of works and bibliography.

MELKSHAM, a market town in the Westbury parliamentary division of Wiltshire, England, 9½ m. W. of London by the Great Western railway. Pop. of urban district (1901), 2450. It lies in a valley sheltered by steep chalk hills on the east, its old-fashioned stone houses lining a single broad street, which crosses the Upper Avon by a bridge of four arches. The church preserves some remnants of Norman work and a Perpendicular south chapel of rare beauty. Melksham possesses cloth-mills where coco-nut fibre and hair cloth are woven, flour-mills and dye-works. On the discovery of a saline spring in 1816, baths and a pump-room were opened, but although two other springs were found later, the attempt to create a fashionable health resort failed. The surrounding deer-forest was often visited by Edward I. Lacock Abbey, 3 m. distant, was founded in 1232 for Austin canons, and dissolved in 1539. Portions of the monastic buildings remain as picturesque fragments in and near the modern mansion called Lacock Abbey.

MELLE, a town of western France, capital of an arrondissement in the department of Deux-Sèvres, on the left bank of the Bérone, 21 m. E.S.E. of Niort by rail. Pop. (1906), 2231. Melle has two churches in the Romanesque style of Poitou, St Pierre and St Hilaire, the latter ornamented with sculptured arcading. The hospital has a richly carved doorway of the 17th century. The church of St Savinien (11th century) serves as a prison. The town has trade in farm-produce, mules and other live stock; distilling is carried on. Melle (*Metalum*) derives its name from the lead mine worked here during the Roman occupation and in the early middle ages. At the latter period it had a mint. In later times it was a possession of the counts of Maine.

MELLITIC ACID (benzene hexacarboxylic acid), $C_6(COOH)_6$, was first discovered in 1799 by M. H. Klaproth in the mineral honeystone, which is the aluminium salt of the acid. The acid may be prepared by warming honeystone with ammonium carbonate, boiling off the excess of the ammonium salt and adding ammonia to the solution. The precipitated alumina is filtered off, the filtrate evaporated and the ammonium salt of the acid purified by recrystallization. The ammonium salt is then converted into the lead salt by precipitation with lead acetate and the lead salt decomposed by sulphuretted hydrogen.

The acid may also be prepared by the oxidation of pure carbon, or of hexamethyl benzene, in the cold, by alkaline potassium permanganate (F. Schulz, *Ber.*, 1871, 4, p. 802; C. Friedel and J. M. Crafts, *Ann. chim. phys.*, 1884 [6], t. p. 470). It crystallizes in fine silky needles and is soluble in water and alcohol. It is a very stable compound, chlorine, concentrated nitric acid and hydrochloric acid having no action upon it. It is decomposed, on dry distillation, into carbon dioxide and pyromellitic acid, $C_{10}H_4O_4$; when distilled with lime it gives carbon dioxide and benzene. Long digestion of the acid with excess of phosphorus pentachloride results in the formation of the acid chloride, $C_6(COCl)_6$, which crystallizes in needles, melting at 190° C. By heating the ammonium salt of the acid to 150-160° C. as long as ammonia is evolved, a mixture of *paramide* (mellimide), $C_6(CO \rightarrow NH)_6$, and ammonium euchroate is obtained. The mixture may be separated by dissolving out the ammonium euchroate with water. Paramide is a white amorphous powder, insoluble in water and alcohol.

MELLITUS (d. 624), bishop of London and archbishop of Canterbury, was sent to England by Pope Gregory the Great in 601. He was consecrated by St Augustine before 604, and a church was built for him in London by Aethelberht, king of Kent; this church was dedicated to St Paul, and Mellitus became first bishop of London. About ten years later the East Saxons reverted to heathenism and the bishop was driven from his see. He took refuge in Kent and then in Gaul, but soon returned to England, and in 619 became archbishop of Canterbury in succession to Laurentius. He died on the 24th of April 624.

MELLONI, MACEDONIO (1798-1854), Italian physicist, was born at Parma on the 11th of April 1798. From 1824 to 1831 he was professor at Parma, but in the latter year he was compelled to escape to France, having taken part in the revolution. In 1839 he went to Naples and was soon appointed director of the Vesuvius observatory, a post which he held until 1848. Melloni received the Rumford medal of the Royal Society in 1834. In 1835 he was elected correspondent of the Paris Academy, and in 1839 a foreign member of the Royal Society. He died at Portici near Naples of cholera on the 11th of August 1854. Melloni's reputation as a physicist rests especially on his discoveries in radiant heat, made with the aid of the thermo-multiplier or combination of thermopile and galvanometer, which, soon after the discovery of thermoelectricity by T. J. Seebeck, was employed by him jointly with L. Nobili in 1831. His experiments were especially concerned with the power of transmitting dark heat possessed by various substances and with the changes produced in the heat rays by passage through different materials. Substances which were comparatively transparent to heat he designated by the adjective "diathermanic," the property being "diathermanéité," while for the heat-tint or heat-coloration produced by passage through different materials he coined the word "diathermanisic." In English, however, the terms were not well understood, and "diathermanisic" was generally used as the equivalent of "diathermanéité." In consequence Melloni about 1841 began to use "diathermique" in place of "diathermanéité," "diathermasie" in place of "diathermanéité," and "thermocroce" for "diathermanisic." His most important book, *La thermocroce ou la coloration colorifique* (vol. i., Naples, 1850), was unfinished at his death. He studied the reflection and polarization of radiant heat, the magnetism of rocks, electrostatic induction, daguerrotypy, &c.

MELODRAMA (a coined word from Gr. μέλος, music, and δράμα, action), the name of several species of dramatic composition. As the word implies, "melodrama" is properly a dramatic mixture of music and action, and was first applied to a form of dramatic musical composition in which music accompanied the spoken words and the action, but in which there was no singing. The first example of such a work has generally been taken to be the *Pygmalion* of J. J. Rousseau, produced in 1775. This is the source of romantic dramas depending on sensational incident with exaggerated appeals to conventional sentiment rather than on play of character, and in which *dramatis personae* follow conventional types—the villain, the hero wrongfully charged with crime, the persecuted heroine, the adventuress, &c. At first the music was of some importance, forming practically a running accompaniment suitable to the situations—but this has gradually disappeared, and, if it remains, is used mainly to emphasize particularly strong situations, or to bring on or off the stage the various principal characters. Such plays first became popular in France at the beginning of the 19th century. One of the most prolific writers of melodramas at that period was R. C. G. de Fericourt (1773-1844). The titles of some of his plays give a sufficient indication of their character; e.g. *Victor, ou l'enfant de la forêt* (1797); *Carolina, ou l'enfant du mystère* (1801); *Le Monastère abandonné, ou la malédiction paternelle* (1816). Another form of melodrama came from the same source, but developed on lines which laid more emphasis on the music, and is of some importance in the history of opera. Probably the first of this

type is to be found in Georg Benda's *Ariadne auf Naxos* (1774). The most familiar of such melodramas is Gay's *Beggar's Opera*. In these the dialogue is entirely spoken. In true opera the spoken dialogue was replaced by recitative. It may be noticed that the speaking of some parts of the dialogue is not sufficient to class an opera as a "melodrama" in this sense, as is proved by the spoken grave-digging scene, accompanied by music, in *Fiddio*, and the incantation scene in *Der Freischütz*. To this the English term "declamation" is usually applied; the Germans use *Melodram*. But see *OPERA*.

MELODY (Gr. μελωδία, a choral song, from μέλος, tune, and ᾠή, song). In musical philosophy and history the word "melody" must be used in a very abstract sense, as that aspect of music which is concerned only with the pitch of successive notes. Thus a "melodic scale" is a scale of a kind of music that is not based on an harmonic system; and thus we call ancient Greek music "melodic." The popular conception of melody is that of "air" or "tune," and this is so far from being a primitive conception that there are few instances of such melody in recorded music before the 17th century; and even folk-songs, unless they are of recent origin, deviate markedly from the criteria of tunelessness. The modern conception of melody is based on the interaction of every musical category. For us a melody is the surface of a series of harmonies, and an unaccompanied melody so far implies harmony that if it so behaves that simple harmonies expressing clear key-relationships would be difficult to find for it, we feel it to be strange and vague. Again, we do not feel music as melodious unless its rhythm is symmetrical; and this, taken together with the harmonic rationality of modern melody, brings about an equally intimate connexion between melody on a large scale and form on a small scale. In the article on *SONATA FORMS* it is shown that there are gradations between the form of some kinds of single melody like "Barbara Allen" (see Ex. 1) and the larger dance forms of the suite, and then, again, gradations between these and the true sonata forms with their immense range of expression and development. Lastly, the element that appears at first sight most strictly melodic, namely, the rise and fall of the pitch, is intimately connected by origin with the nature of the human voice, and in later forms is enlarged fully as much by the characteristics of instruments as by parallel developments in rhythm, harmony and form. Thus modern melody is the musical surface of rhythm, harmony, form and instrumentation; and, if we take Wagnerian *Leitmotif* into account, we may as well add drama to the list. In short, melody is the surface of music.

We may here define a few technicalities which may be said to come more definitely under the head of melody than any other; but see also *HARMONY* and *RHYTHM*.

1. A *theme* is a melody, not necessarily or even usually complete, except when designed for a set of *variations* (q.v.), but of sufficient independent coherence to be, so to speak, an intelligible musical sentence. Thus a fugue-subject is a theme, and the first and second subjects in sonata form are more or less complex groups of themes.

2. A *figure* is the smallest fragment of a theme that can be recognized when transformed or detached from its surroundings. The grouping of figures into new melodies is the most obvious resource of "development" or "working-out" in the sonata-forms (see Ex. 2-7), besides being the main resource by which fugues are carried on at those moments in which the subjects and counter-subjects are not present as wholes. In 16th-century polyphony melody consists mainly of figures thus broken off from *canto fermo* (see *CONTRAPUNTAL FORMS*).

3. *Polyphony* is simultaneous multiple melody. In 16th-century music and in fugue-writing every part is as melodious as every other. The popular cry for melody as an antidote to polyphony is thus really a curious perversion of the complaint that one may have too much of a good thing. Several well-known classical melodies are polyphonically composite, being formed by an inner melody appearing as it were through transparent places in the outer melody, which it thus completes. This is especially common in music for the pianoforte, where the tone of long notes rapidly fades, and the works of Chopin are full of examples. In Bach's works for keyed instruments figures frequently have a double meaning on this principle, as, for instance, in the peculiar kind of counter-subject in the 15th fugue of the 2nd book of the *Wohlbemerkter Klavier*. A good familiar example of a simple melody which, as written by the composer, would need two voices to sing it, is that

which begins the second subject of Beethoven's *Waldstein Sonata* (Op. 53, first movement, bars 35-42, where at the third bar of the melody a lower voice enters and finishes the phrase).

4 (a) *Conjunct movement* is the movement of melody along adjacent degrees of the scale. A large proportion of Beethoven's melodies are conjunct (see Ex. 2, fig. B).

4 (b) *Disjunct movement*, the opposite of conjunct, tends, though by no means always, to produce *arpeggio* types of melody, i.e. melodies which move up and down the notes of a chord. Certain types of such melody are highly characteristic of Brahms; and

Wagner, whose melodies are almost always of instrumental origin, is generally disjunct in diatonic melody and conjunct in chromatic (Ex. 2, fig. C, is a disjunct figure not forming an arpeggio).

For various other melodic devices, such as inversion, augmentation and diminution, see **CONTRAPUNTAL FORMS**.

We subjoin some musical illustrations showing the treatment of figures in melody as a means of symmetry (Ex. 1), and development (Ex. 2-7), and (Ex. 8-13) some modern melodic transformations, differing from earlier methods in being immediate instead of gradual.

(D. F. T.)

Ex. 1. "Barbara Allen" (showing the germ of binary form in the balance between A^1 on the dominant and A^2 on the tonic).

Ex. 2. Main theme of the first movement of Beethoven's Trio in B \flat , Op. 97.

Ex. 3. Figure A of above developed in a new polyphonic 4-bar phrase.

Ex. 4. Further sequential developments of A.

Ex. 5. Development of C with B.

Ex. 6. Further development of B by diminution, in combination with the trills derived from C.

Ex. 7. Further development of B by diminution and contrary motion (inversion).

Ex. 9. A and B^2 diminished.

Ex. 8. BRAHMS, Quintet, Op. 34.

Ex. 11. *The Rheindaughter's Toy*. Wagner, *Das Rheingold*.

Ex. 12. *The Nibelung's Talisman*.

Ex. 13. *Walhalla*.

MELON (Late Lat. *melo*, shortened form of Gr. *μηλόριον*, a kind of gourd; *μήλον*, apple, and *πέπων*, ripe), *Cucumis melo*, a polymorphic species of the order Cucurbitaceae, including numerous varieties.¹ The melon is an annual trailing herb with palmately-lobed leaves, and bears tendrils by means of which it is readily trained over trellises, &c. It is monoecious, having male and female flowers on the same plant; the flowers have deeply five-lobed campanulate corollas and three stamens. Naudin observed that in some varieties (e.g. of Cantaloups) fertile stamens sometimes occur in the female flowers. It is a native of south Asia "from the foot of the Himalayas to Cape Comorin,"² where it grows spontaneously, but is cultivated in the temperate and warm regions of the whole world. It is variable both in diversity of foliage and habit, but much more so in the fruit, which in some varieties is no larger than an olive, while in others it rivals the gourd (*Cucurbita maxima*). The fruit is globular, ovoid, spindle-shaped, or serpent-like, netted or smooth-skinned, ribbed or furrowed, variously coloured externally, with white, green, or orange flesh when ripe, scented or scentless, sweet or insipid, bitter or even nauseous, &c. Like the gourd, the melon undergoes strange metamorphoses by crossing its varieties, though the latter preserve their characters when alone. The offspring of all crossings are fertile. As remarkable cases of sudden changes produced by artificially crossing races, M. Naudin records that in 1859 the offspring of the wild melons *m. sauvage de l'Inde* (*C. melo agrestis*) and *m. s. d'Afrique, le petit m. de Figari* bore different fruits from their parents, the former being ten to twelve times their size, ovoid, white-skinned, more or less scented, and with reddish flesh; though another individual bore fruits no larger than a nut. The offspring of *m. de Figari* after being crossed bore fruits of the serpent-melon. On the other hand, the serpent-melon was made to bear ovoid and reticulated fruit.

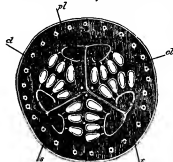

Transverse section of the fruit of the melon (*Cucumis melo*), showing the placentas (pl), with the seeds attached to them. The three carpels forming the pepo are separated by partitions (d). From the centre, processes (s) go to circumference (c), ending in curved placenteries bearing the ovules.

or serpent-like, netted or smooth-skinned, ribbed or furrowed, variously coloured externally, with white, green, or orange flesh when ripe, scented or scentless, sweet or insipid, bitter or even nauseous, &c. Like the gourd, the melon undergoes strange metamorphoses by crossing its varieties, though the latter preserve their characters when alone. The offspring of all crossings are fertile. As remarkable cases of sudden changes produced by artificially crossing races, M. Naudin records that in 1859 the offspring of the wild melons *m. sauvage de l'Inde* (*C. melo agrestis*) and *m. s. d'Afrique, le petit m. de Figari* bore different fruits from their parents, the former being ten to twelve times their size, ovoid, white-skinned, more or less scented, and with reddish flesh; though another individual bore fruits no larger than a nut. The offspring of *m. de Figari* after being crossed bore fruits of the serpent-melon. On the other hand, the serpent-melon was made to bear ovoid and reticulated fruit.

Naudin thinks it is probable that the culture of the melon in Asia is as ancient as that of all other alimentary vegetables. The Egyptians grew it, or at least inferior races of melon, which were either indigenous or introduced from Asia. The Romans and doubtless the Greeks were familiar with it, though some forms may have been described as cucumbers. Columella seems to refer to the serpent-melon in the phrase *ut coluber . . . ventre cubat flexo*. Pliny describes them as *pepones* (xix. 23 to xx. 6) and Columella as *melones* (xi. 2, 53). The melon began to be extensively cultivated in France in 1629, according to Olivier de Serres. Gerard (*Herball*, 772) figured and described in 1597 several kinds of melons or pompions, but he has included gourds under the same name.

The origin of some of the chief modern races, such as "Cantaloups," "Dudaim," and probably the netted sorts, is due to Persia and the neighbouring Caucasian regions. The first of these was brought to Rome from Armenia in the 16th century, and supplies the chief sorts grown for the French markets; but many others are doubtless artificial productions of west Europe.

The water-melon (*Citrullus vulgaris*) is a member of a different genus of the same order. It has been cultivated for its cool refreshing fruit since the earliest times in Egypt and the Orient, and was known before the Christian era in southern Europe and Asia.

The melon requires artificial heat to grow it to perfection, the

rock and cantaloup varieties succeeding with a bottom heat of 70° and an atmospheric temperature of 75°, rising with sun heat to 80°, and the Persian varieties requiring a bottom heat of 75°, gradually increasing to 80°, and an atmospheric temperature ranging from 75° to 80° when the fruit is swelling, as much sun heat as the plants can bear being allowed at all times. The melon grows best in rich turfy loam, somewhat heavy, with which a little well-rotted dung, especially that of pigeons or fowls, should be used in the proportion of one-fifth mixed in the compost of loam. Melons are grown on hotbeds of fermenting manure, when the soil should be about a foot in thickness, or in pits heated either by hot water or fermenting matter, or in houses heated by hot water, in which case the soil bed should be 15 or 18 in. thick. The fermenting materials should be well prepared, and, since the heat has to be kept up by linings, it is a good plan to introduce one or two layers of faggots in building up the bed. A mixture of dung and leaves gives a more subdued but more durable heat.

For all ordinary purposes February is early enough for sowing the first crop, as well-flavoured fruits can scarcely be looked for before May. The seeds may be sown singly in 3-in. pots in a mixture of leaf-mould with a little loam, the pots being plunged in a bottom heat of 75° to 80°, and as near the glass as possible, in order that the young plants may not be drawn up. The hill or ridge of soil should be about a foot in thickness, the rest of the surface being afterwards made up nearly to the same level. If the fruiting-plant is not ready when the roots have nearly filled the pots, they must be shifted into 4-inch pots, for they must not get starved or pot-bound. Two or three plants are usually planted in a mound or ridge of soil placed in the centre of each light, and the surface is covered over to a similar depth as soon as the roots have made their way through the mound.

The melon being one of those plants which produce distinct male and female flowers, it is necessary to its fertility that both should be produced, and that the pollen of the male flower should, either naturally by insect agency, or artificially by the cultivator's manipulation, be conveyed to the stigma of the female flower; this setting of the fruit is often done by stripping a male flower of its corolla, and inverting it in the centre of the fruit-bearing flower. After the fruit has set and has grown to the size of an egg, it should be preserved from contact with the soil by placing it on a piece of tile or slate; or if grown on a trellis by a little swinging wooden shelf, just large enough to hold it. In either case the material used should be tilted a little to one side, so as to permit water to drain away. Before the process of ripening commences, the roots should have a sufficient supply of moisture, so that none may be required from that time until the fruit is cut.

When the melon is grown in a house there should be a good depth of drainage over the tank or other source of bottom heat, and the ground in the cold frame should be raised downwards below the soil, which should not be less than 15 and need not be more than 18 in. in thickness. The compost should be made moderately firm, and only half the bed should be made up at first, the rest being added as the roots require it. The melon may also be grown in large pots, supplied with artificial manure or manure water. The stems may be trained up the trellis in the usual way, or the rafters of a pine stove may be utilized for the purpose. If the trellis is constructed in panels about the width of the lights, it can be taken down and conveniently stowed away when not in use.

The presence of too much moisture either in the atmosphere or in the soil is apt to cause the plants to damp off at the neck, but the evil may be checked by applying a little fresh-slaked lime round the stem of the plant.

Melons are liable to the attack of red spider, which are best removed by syringing with rain-water, and prevented by keeping a fairly humid atmosphere; green or black fly should also be watched for and removed by fumigation with tobacco smoke or by "vaporizing."

The varieties of melon are continually receiving additions, and as newer varieties spring into favour, so the older ones drop out of cultivation. A great deal depends on getting the varieties true to name, as they are very liable to get cross-fertilized by insect agency. Some of the best at present are:

Scarlet-fleshed.—Blenheim Orange, Frogmore Orange, Invincible, Sutton's Scarlet, and Triumph.

White-fleshed.—Golden Orange, Hero of Lockinge, Longleaf Perfection, Royal Favourite.

Green-fleshed.—British Queen, Epicure, Exquisite, Monarch, Ringleader.

The market-gardeners round Paris and other parts of France chiefly cultivate varieties of Cantaloup melon known as the Prescott hâif à chassis and Prescott foot blanc—both excellent in flavour. The plants are grown in frames on hotbeds, and only one large fruit is allowed to mature on each plant. If secured early in the season—say in June—from 25 to 35 francs can be obtained for each fruit in the Paris markets; later fruits, however, drop down to 2 francs each, or even less when there is a glut (see J. Weathers, *French Market-Gardening*).

MELORIA, a rocky islet, surrounded by a shoal, almost opposite Leghorn. It was the scene of two naval battles of the

¹ For a full account of the species of *Cucumis* and of the varieties of melon by Charles Naudin, see *Annales des sciences naturelles*, ser. 4, vol. xi. p. 34 (1859).

² Naudin, *loc. cit.* pp. 39, 76.

middle ages. The first, on the 3rd of May 1241, was fought between the fleet of the emperor Frederick II. Hohenstaufen, surnamed Stupor Mundi, in alliance with Pisa, against a Genoese squadron bringing a number of English, French and Spanish prelates to attend the council summoned to meet at the Lateran by Gregory IX. Three Genoese galleys were sunk and twenty-two taken. Several of the prelates perished, and many were carried prisoners to the camp of the emperor. The second, fought on Sunday the 6th of August 1284, was of higher historical importance. It was a typical medieval sea-fight, and accomplished the ruin of Pisa as a naval power. The long rivalry of that city and of Genoa had broken out for the last time in 1282, the immediate cause being the incompatible claims of the two cities to sovereignty over the islands of Sardinia and Corsica. The earlier conflicts of the war in 1282, 1283 and the spring of 1284, had been unfavourable to Pisa. Though the city was united with the Catalans and with Venice in hostility to Genoa, and though it had chosen a Venetian, Alberto Morosini, as its Podestà, it received no help from either. The Genoese, who had the larger and more efficient fleet, sent their whole power against their enemy. When the Genoese appeared off Meloria the Pisans were lying in the river Arno at the mouth of which lay Porto Pisano the port of the city. The Pisan fleet represented the whole power of the city, and carried members of every family of mark and most of the great officers of state. The Genoese, desiring to draw their enemy out to battle, and to make the action decisive, arranged their fleet in two lines abreast. The first was composed according to Agostino Giustiniani of fifty-eight galleys, and eight *panfili*, a class of light galleys of eastern origin named after the province of Pamphylia. Uberto Doria, the Genoese admiral, was stationed in the centre and in advance of his line. To the right were the galleys of the Spinola family, and of four of the eight "companies" into which Genoa was divided—Castello, Piazzalunga, Macagnana and Son Lorenzo. To the left were the galleys of the Dornas, and of the other four companies, Porta, Soziglia, Porta Nuova and Il Borgo. The second line of twenty galleys, under the command of Benedetto Giacaria (or Zaccharie), was placed so far behind the first that the Pisans could not see whether it was made up of war-vessels or of small craft meant to act as tenders to the others. Yet it was near enough to strike in and decide the battle when the action had begun. The Pisans, commanded by the Podestà Morosini and his lieutenants Ugolino della Gherardesca and Andreotto Saraceno, came out in a single body. It is said that while the archbishop was blessing the fleet the silver cross of his archiepiscopal staff fell off, but that the omen was disregarded by the irreverence of the Pisans, who declared that if they had the wind they could do without divine help. They advanced in line abreast to meet the first line of the Genoese, fighting according to the medieval custom to ram and board. The victory was decided for Genoa by the squadron of Giacaria which fell on the flank of the Pisans. Their fleet was nearly annihilated, the Podestà was taken, and Ugolino fled with a few vessels. As Pisa was also attacked by Florence and Lucca it could never recover the disaster. Two years later Genoa took Porto Pisano, and filled up the harbour. The count Ugolino was afterwards starved to death with several of his sons and grandsons in the manner made familiar by the 32nd canto of Dante's *Inferno*.

See *Annali della repubblica di Genova*, by Agostino Giustiniani (ed. Canepa, Genoa, 1854).

MELOS (mod. *Milo*), an island of the Aegean Sea (Cyclades group), at the S.W. corner of the archipelago, 75 m. due E. from the coast of Laconia. From E. to W. it measures about 14 m., from N. to S. 8 m., and its area is estimated at 52 sq. m. The greater portion is rugged and hilly, culminating in Mount Elias in the west (2538 ft.). Like the rest of the cluster, the island is of volcanic origin, with tuff, trachyte and obsidian among its ordinary rocks. The natural harbour, which, with a depth diminishing from 70 to 30 fathoms, strikes in from the north-west so as to cut the island into two fairly equal portions, with an isthmus not more than 1½ m. broad, is the hollow of the principal crater. In one of the caves on the south coast the heat is

still great, and on the eastern shore of the harbour there are hot sulphurous springs. Sulphur is found in abundance on the top of Mount Kalamo and elsewhere. In ancient times the alum of Melos was reckoned next to that of Egypt (Pliny xxxv. 15 [52]), and millstones, salt (from a marsh at the east end of the harbour), and gypstones are still exported. The Melian earth (γῆ Μελιάς) was employed as a pigment by ancient artists. Orange, olive, cypress and arbutus trees grow throughout the island, which, however, is too dry to have any profusion of vegetation. The vine, the cotton plant and barley are the main objects of cultivation. Pop. (1907), 4864 (commune), 12,774 (province).

The harbour town is Adamanta; from this there is an ascent to the plateau above the harbour, on which are situated Plaka, the chief town, and Kastro, rising on a hill above it, and other villages. The ancient town of Melos was nearer to the entrance of the harbour than Adamanta, and occupied the slope between the village of Trypete and the landing-place at Klima. Here is a theatre of Roman date and some remains of town walls and other buildings, one with a fine mosaic excavated by the British school at Athens in 1896. Numerous fine works of art have been found on this site, notably the Aphrodite of Melos in the Louvre, the Asclepius in the British Museum, and the Poseidon and an archaic Apollo in Athens. The position of Melos, between Greece and Crete, and its possession of obsidian, made it an important centre of early Aegean civilization. At this time the chief settlement was at the place now called Phylakopi, on the north-east coast. Here the excavations of the British school cleared many houses, including a palace of "Mycenaean" type; there is also a town wall. Part of the site has been washed away by the sea. The antiquities found were of three main periods, all preceding the Mycenaean age of Greece. Much pottery was found, including examples of a peculiar style, with decorative designs, mostly floral, and also considerable deposits of obsidian. There are some traditions of a Phoenician occupation of Melos. In historical times the island was occupied by Dorians from Laconia. In the 6th century it again produced a remarkable series of vases, of large size, with mythological subjects and orientaling ornamentation (see GREEK ART, fig. 9), and also a series of terra-cotta reliefs.

Though Melos inhabitants sent a contingent to the Greek fleet at Salamis, it held aloof from the Attic league, and sought to remain neutral during the Peloponnesian War. But in 416 B.C. the Athenians, having attacked the island and compelled the Melians to surrender, slew all the men capable of bearing arms, made slaves of the women and children, and introduced 500 Athenian colonists. Lysander restored the island to its Dorian possessors, but it never recovered its former prosperity. There were many Jewish settlers in Melos in the beginning of the Christian era, and Christianity was early introduced. During the "Frankish" period the island formed part of the duchy of Naxos, except for the few years (1341-1383) when it was a separate lordship under Marco Sanudo and his daughter.

Antimelos or *Antimilo*, 5½ m. north-west of Milo, is an uninhabited mass of trachyte, often called Eremomilo or Desert Melos. *Kimolos*, or *Argentiera*, less than 1 m. to the north-east, was famous in antiquity for its figs and fuller's earth (Κίμωνια γῆ) and contained a considerable city, the remains of which cover the cliff of St. Andrews. *Polinos*, *Polybos* or *Politeo* (anc. *Polyseges*) lies rather more than a mile south-east of Kimolos. It was the subject of dispute between the Melians and Kimolians. It has long been almost uninhabited.

See Leicester, "The Volcanic Group of Milo, Anti-Milo, &c.," in *Jour. Roy. Geog. Soc.* (1852); Tournefort, *Voyage*; Leake, *Northern Greece*, iii.; Prokesch von Osten, *Denkwürdigkeiten*, &c.; Bursian, *Geog. von Griechenland*, li.; *Journ. Hell. Stud.* xvi., xvii., xviii.; *Excavations at Phylakopi*; *Inscr. graec.* xii. iii. 107 sqq.; on coins found in 1909, see Jameson in *Rev. Num.* 1909, 188 sqq. (E. Gr.).

MELOZZO DA FORLÌ (c. 1438-1494), Italian painter, the first who practised foreshortening with much success, was born at Forlì about 1438; he came, it is supposed, of a wealthy family named Ambrosi. In all probability, Melozzo studied painting under Piero de' Franceschi, of Borgo St. Sepolcro; he seems also to have been well acquainted with Giovanni Sarti, the father of

Raphael. It has been said that he became a journeyman and colour-grinder to some of the best masters, in order to prosecute his studies; this lacks confirmation. Only three works are extant which can safely be assigned to Melozzo: those in the Louvre, the National Gallery, London, and the Barberini Palace, Rome, are disputable. (1) He painted in 1472 the vault of the chief chapel in the church of the Apostoli in Rome, his subject being the "Ascension of Christ"; the figure of Christ is so boldly and effectively foreshortened that it seems to "burst through the vaulting"; this fresco was taken down in 1711, and the figure of Christ is now in the Quirinal Palace, not worthy of special admiration save in its perspective quality; while some of the other portions, almost Raphaellesque in merit, are in the sacristy of St Peter's. (2) Between 1475 and 1480 he executed a fresco, now transferred to canvas, and placed in the Vatican picture-gallery, representing the appointment of Platina by Pope Sixtus IV. as librarian of the restored Vatican library. (3) In the Collegio at Forlì is a fresco by Melozzo, termed the "Pestapepe," or Pepper-grinder, originally painted as a grocer's sign; it is an energetic specimen of rather coarse realism, now much damaged. Melozzo also painted the cupola of the Capuchin church at Forlì, destroyed in 1651; and it has been said that he executed at Urbino some of the portraits of great men (Plato, Dante, Sixtus IV., &c.) which are now divided between the Barberini Palace and the Campana collection in Paris; this, however, is doubtful, and it is even questionable whether Melozzo was ever at Urbino. In Rome he was one of the original members of the academy of St Luke, founded by Sixtus IV. He returned to Forlì, probably towards 1480, and died in November 1494. He contributed sensibly to the progress of pictorial art; and, without being remarkable as a colourist, gave well graded lights, with general care and finish, and fine dignified figures. His works bear a certain resemblance to those of his contemporary Mantegna. Marco Palmezzano was his pupil; and the signature "Marcus de Melotius" on some of Palmezzano's works, along with the general affinity of style, has led to their being ascribed to Melozzo, who has hence been incorrectly called "Marco Melozzo."

MELROSE, a city of Middlesex county, Massachusetts, U.S.A., about 7 m. N. of Boston. Pop. (1890), 8,519; (1900), 12,962, of whom 2924 were foreign-born and 130 were negroes; (1910 census) 15,715. It is served by the Boston & Maine railroad, and by inter-urban electric railways. The city covers 4.8 sq. m. of broken, hilly country, in which is a part of the state park of Middlesex Fells; it includes the villages of Melrose, Melrose Highlands, Wyoming and Fells. In 1905 the total factory product was valued at \$9,450,920 (an increase of 176.6% over the value of the factory product in 1900). The principal products are rubber shoes (at the village of Fells), skirts (at the village of Wyoming), and leather and silverware (at Melrose Highlands). The water supply of Melrose, like that of Stoneham and of Medford, is derived from the metropolitan reservoir called Spot Pond in Stoneham, immediately west of Melrose. The city was the home of Samuel Adams Drake (1833-1905), American historian, whose *History of Middlesex County* (Boston, 1880; vol. 2, "Melrose," by E. H. Goss) should be consulted; and of William Frederick Poole (1821-1894), the librarian and the originator of indexes of periodical literature. Melrose was settled about 1633, and was a part of Charlestown until 1649, and of Malden until 1850. The eastern part of Stoneham was annexed to it in 1853. In 1899 it was chartered as a city; the charter came into effect in 1900. The name is said to be due to a resemblance of the scenery to that of Melrose, Scotland.

MELROSE, a police burgh of Roxburghshire, Scotland. Pop. (1901), 2195. It lies on the right bank of the Tweed, 37½ m. S.E. of Edinburgh, and 19 m. N.W. of Jedburgh, via St Boswells and Roxburgh, by the North British railway. The name—which Bede (730) wrote *Mailros* and Simeon of Durham (1130) *Melros*—is derived from the Celtic *maol ros*, "bare moor," and the town figures in Sir Walter Scott's *Abbot and Monastery* as "Kennaquhair." In consequence of the beauty of its situation between the Eldons and the Tweed, the literary and historical associations of the district, and the famous ruin of

Melrose Abbey, the town has become residential and a holiday resort. There is a hydropathic establishment on Skirmish Hill, the name commemorating the faction fight on the 25th of July 1526, in which the Scotts defeated the Douglasses and Kers. Trade is almost wholly agricultural. The main streets run from the angles of the triangular market-place, in which stands the market cross, dated 1642, but probably much older. Across the river are Gattonside, with numerous orchards, and Allery, the home of Sir David Brewster from 1827 till his death in 1868.

The original Columban monastery was founded in the 7th century at Old Melrose, about 2½ m. to the east, in the loop of a great bend of the Tweed. It was colonized from Lindisfarne, Eata, a disciple of Aidan, being the first abbot (651), and Boisil and Cuthbert being priors here. It was burned by Kenneth Macalpine in 839 during the wars between Scot and Saxon, and, though rebuilt, was deserted in the middle of the 11th century. The chapel, dedicated to St Cuthbert, continued for a period to attract many pilgrims, but this usage gradually declined and the building was finally destroyed by English invaders. Meanwhile in 1136 David I. and founded an abbey dedicated to the Virgin, a little higher up the Tweed, the first Cistercian settlement in Scotland, with monks from Rievaulx in Yorkshire. Lying in the direct road from England, the abbey was frequently assaulted and in 1322 was destroyed by Edward II. Rebuilt, largely by means of a gift of Robert Bruce, it was nearly burned-down in 1385 by Richard II. Erected once more, it was reduced to ruin by the earl of Hertford (afterwards the Protector Somerset) in 1545. Later the Reformers dismantled much of what was left. The adaptation of part of the nave to the purposes of a parish church and the use of the building as a quarry did further damage. The ruins, however, now the property of the duke of Buccleuch, are carefully preserved. Of the conventual buildings apart from the church nothing has survived but a fragment of the cloister with a richly-carved round-headed doorway and some fine arcading. The abbey, cruciform, is in the Decorated and Perpendicular styles, with pronounced French influence, due probably to the master mason John Morow, or Morreau, who, according to an inscription on the south transept wall, was born in Paris. The south front is still beautiful. The west front and a large portion of the north half of the nave and aisle have perished, but the remains include the rest of the nave, the two transepts, the chancel and choir, the two western piers of the tower and the sculptured roof of the east end. From east to west it measured 258 ft., the nave is 69 ft. wide and the width of the transepts from north to south is 115½ ft. The nave had an aisle on each side, the north noticeably the narrower, the south furnished with eight chapels, one in each bay. Both transepts contained an eastern aisle, and the chancel a square chapel at its west end on each side. Over the south transept aisle, which was the chapel of St Bridget, is the clerestory passage, which ran all round the church. The choir extended westwards for three bays beyond the tower and terminated in a stone roof-screen. Sir Walter Scott has immortalized the east window, in *The Lay of the Last Minstrel*, but the south window with its flowing tracery is even finer. In the carving of windows, aisles, cloister, capitals, bosses and doorheads no design is repeated. The heart of Robert Bruce was buried at the high altar, and in the chancel are the tombs of Sir William Douglas, the Knight of Liddesdale (1300-1353), James 2nd earl of Douglas (1358-1388), the victor of Otterburn; Alexander II.; and Michael Scot "the Wizard" (1175-1234)—though some authorities say that this is the tomb of Sir Brian Layton, who fell in the battle of Ancrem Moor (1544). At the door leading from the north transept to the sacristy is the grave of Joanna (d. 1238), queen of Alexander II.

The monuments of the abbacy, preserved in the archives of the earl of Morton, were edited by Cosmo Innes for the Bannatyne Club and published in 1837 under the title of *Liber sancte Marie de Melros*. Among the documents is one of the earliest specimens of the Scots dialect. The *Chronica de Mailros*, preserved among the Cotton MSS., was printed at Oxford in 1684 by William Fulman and by the Bannatyne Club in 1835 under the editorship of John Stevenson.

MELTON MOWBRAY, a market town in the Melton parliamentary division of Leicestershire, England, pleasantly situated in a fertile vale, at the confluence of the Wreake and the Eye. Pop. of urban district (1901), 7454. It is 105 m. N.N.W. from London by the Midland railway, and is served by a joint branch of the London & North Western and Great Northern railways. The church of St Mary, a fine cruciform structure, Early English and later, with a lofty and richly ornamented central tower, was enlarged in the reign of Elizabeth. Melton is the centre of a celebrated hunting district, in connexion with which there are large stables in the town. It is known for its pork pies, and has a trade in Stilton cheese. There are breweries and tanneries and an important cattle market. There are blast furnaces in the neighbouring parish of Asfordby for the smelting of the abundant supply of iron ore in the district. During the Civil War Melton was in February 1644 the scene of a defeat of the parliamentary forces by the royalists. It is the birthplace of John Henley the orator (1692-1759).

MELUN, a town of northern France, capital of the department of Seine-et-Marne, situated north of the forest of Fontainebleau, 28 m. S.S.E. of Paris by rail. Pop. (1906), 11,219. The town is divided into three parts by the Seine. The principal portion lies on the slope of a hill on the right bank; on the left bank is the most modern quarter, while the old Roman town occupies an island in the river. On the island stands the Romanesque church of Notre-Dame (11th and 12th centuries), formerly part of a nunnery, the site of which is occupied by a prison. The other public buildings are on the right bank of the river. Of these, the most striking is the church of St Aspais, an irregularly shaped structure of the 15th and 16th centuries, on the apse of which may be seen a modern medallion in bronze, the work of the sculptor H. Chapu, representing Joan of Arc as the liberator of Melun. The hôtel-de-ville (1847)—in the construction of which an old mansion and turret have been utilized—and the tower of St Bartholomew of the 16th and 18th centuries are also of interest. In the courtyard of the former there is a monument to Jacques Amyot, the translator of Plutarch, who was born at Melun in 1573. Among the rich estates in the neighbourhood the most remarkable is the magnificent château of Vaux-le-Vicomte, which belonged to Nicholas Fouquet, intendant of finances under Louis XIV. Melun is a market for grain and farm produce, and its industries include brewing, tanning, distilling, sawing and the manufacture of agricultural implements, clogs, fur garments, lime, cement and plaster.

In Caesar's Gallic wars Melun (*Melodunum*) was taken by his lieutenant Labienus, in order to facilitate the attack of Lutetia by the right bank of the Seine. It was pillaged by the Normans, and afterwards became the favourite residence of the first kings of the race of Capet; Robert and Philip I. both died here. In 1350 Melun was given up by Jeanne of Navarre to her brother, Charles the Bad, but was retaken by the dauphin Charles and Bertrand Duguesclin. In 1420 it made an heroic defence against Henry V. of England and his ally the duke of Burgundy. Ten years later the people of Melun, with the help of Joan of Arc, drove out the English. It was occupied by the League in 1589, and retaken by Henry IV. in the following year.

MELUSINE, the tutelary fairy of the house of Lusignan, was the eldest daughter of the fairy Pressine, to avenge whose wrongs she shut up her father in a mountain in Northumberland. For this she was condemned to be metamorphosed every Saturday into a woman-serpent—that is, to be a serpent from the hips downwards. She might, however, be eventually saved from this punishment if she could find a husband who would never see her on a Saturday. Such a husband was found in Raymond, nephew of the count of Poitiers, who became rich and powerful through the machinations of his wife. She built the castle of Lusignan and many other of the family fortresses. When at length her husband gave way to his curiosity, and saw her taking the bath of purification on a Saturday she flew from the castle in the form of a serpent. Thenceforward the death of a member of the house of Lusignan was heralded by the cries of the fairy serpent. "*Pousser des cris de Mélusine*" is still a popular saying.

This history is related at length, with the adventures of

Mélusine's numerous progeny, by Jean d'Arras, in his *Chronique de la princesse*, written in 1387 at the desire of John, duke of Berry, for the amusement of the duke and of his sister Marie of France, duchess of Bar. It is one of the most charming of the old prose romances in manner and style, and is natural in spite of the free use of the marvellous. An attempt has been made by Jules Baudot in *Les Princeses Yolande et les ducs de Bar* (Paris, 1900) to make it a *roman à clé* and to identify the personages. Mélusine, Mellusine or Merlusine is, however, simply the spirit of the fountain of Lusignan, and the local Poitevin myth is attached to the origin of the noble house. The etymology of the word has been variously and fancifully given. Some writers have supposed Merlusine to be a corruption of mère Lucine (*mater Lucina*), the deity invoked in child-birth. She has been identified with Mélisende, widow of a king of Jerusalem, and with Mervant, wife of Geoffroi de Lusignan.

The *Mélusine* of Jean d'Arras was printed by Adam Steinschaber at Geneva in 1478, and was reprinted many times in the 15th and 16th centuries. It has been translated into Spanish, English, German and Flemish. Modern editions are by J. C. Brunet (Paris, 1854), and by E. Lecesne for the Academy of Arras (Arras, 1888). The English translation was edited from an unique MS. in the British Museum by A. K. Donald for the E.E.T.S. (1895). The tale was verified in the 14th century by a poet called Couldrette, whose poem was published in 1854 by Francisque Michel. See further J. C. Dunlop, *Hist. of Fiction*, ii. 491-495 (new ed., 1888); S. Baring-Gould, *Curious Myths of the Middle Ages*, pp. 470 seq. (new ed., 1881); and J. C. Brunet, *Manuel du libraire* (vol. iii., 1862, s.v. Jean d'Arras).

MELVILLE, ANDREW (1545-1622), Scottish scholar, theologian and religious reformer, was the youngest son of Richard Melville (brother to Melville of Dysart), proprietor of Baldovoy near Montrose, at which place Andrew was born on the 1st of August 1545. His father fell at the battle of Pinkie (1547), fighting in the van of the Scottish army, and his wife having died soon after, the orphan was cared for by his eldest brother Richard (1522-1575). At an early age Melville began to show a taste for learning, and his brother did everything in his power to give him the best education. The rudiments of Latin he obtained at the grammar school of Montrose, after leaving which he learned Greek for two years under Pierre de Marsilliers, a Frenchman whom John Erskine of Dun had induced to settle at Montrose; and such was Melville's proficiency that on going to the university of St Andrews he excited the astonishment of the professors by using the Greek text of Aristotle, which no one else there understood. On completing his course, Melville left St Andrews with the reputation of "the best poet, philosopher, and Grecian of any young master in the land." He then, in 1564, being nineteen years of age, set out for France to perfect his education at the university of Paris. He there applied himself to Oriental languages, but also attended the last course of lectures delivered by Turnebus in the Greek chair, as well as those of Peter Ramus, whose philosophical method and plan of teaching he afterwards introduced into the universities of Scotland. From Paris he proceeded to Poitiers (1566) to study civil law, and though only twenty-one he was apparently at once made a regent in the college of St Marceon. After a residence of three years, however, political troubles compelled him to leave France, and he went to Geneva, where he was welcomed by Theodore Beza, at whose instigation he was appointed to the chair of humanity in the academy of Geneva. In addition to his teaching, however, he also applied himself to studies in Oriental literature, and in particular acquired from Cornelius Bertram, one of his brother professors, a knowledge of Syriac. While he resided at Geneva the massacre of St Bartholomew in 1572 drove an immense number of Protestant refugees to that city, including several of the most distinguished French men of letters of the time. Among these were several men learned in civil law and political science, and their society increased Melville's knowledge of the world and enlarged his ideas of civil and ecclesiastical liberty. In 1574 Melville returned to Scotland, and almost immediately received the appointment of principal of Glasgow University, which had fallen into an almost ruinous state, the college having been shut and the students dispersed. Melville,

however, set himself to establish a good educational system. He enlarged the curriculum at the college, and established chairs in languages, science, philosophy and divinity, which were confirmed by charter in 1577. His fame spread through the kingdom, and students flocked from all parts of Scotland and even beyond, till the class-rooms could not contain those who came for admission. He assisted in the reconstruction of Aberdeen University in 1575, and in order that he might do for St Andrews what he had done for Glasgow, he was appointed principal of St Mary's College, St Andrews, in 1580. His duties there comprehended the teaching, not only of theology, but of the Hebrew, Chaldee, Syriac and Rabbinical languages. The ability of his lectures was universally acknowledged, and he created a taste for the study of Greek literature. The reforms, however, which his new modes of teaching involved, and even some of his new doctrines, such as the non-infallibility of Aristotle, brought him into collision with other teachers in the university. He was moderator of the General Assembly in 1582, and took part in the organization of the Church and the Presbyterian method. Troubles arose from the attempts of the court to force a system of Episcopacy upon the Church of Scotland (see SCOTLAND, CHURCH OF), and Melville prosecuted one of the "tulchan" bishops (Robert Montgomery, d. 1609). In consequence of this he was summoned before the Privy Council in February 1584, and had to flee into England in order to escape an absurd charge of treason which threatened imprisonment and not improbably his life. After an absence of twenty months he returned to Scotland in November 1585, and in March 1586 resumed his lectures in St Andrews, where he continued for twenty years; he became rector of the university in 1590. During the whole time he protected the liberties of the Scottish Church against all encroachments of the government. That in the main he and his coadjutors were fighting for the constitutionally guaranteed rights of the Church is admitted by all candid inquirers (see in particular *The History of England from 1603 to 1616*, by S. R. Gardiner, vol. i. chap. ix.). The chief charge against Melville is that his fervour often led him to forget the reverence due to an "anointed monarch." Of this, however, it is not easy to judge. Manners at that time were rougher than at present. When the king acted in an arbitrary and illegal manner he needed the reminder that though he was king over men he was only "God's silly vassal." Melville's rudeness (if it is to be called so) was the outburst of just indignation from a man zealous for the purity of religion and regardless of consequences to himself. In 1599 he was deprived of the rectorship, but was made dean of the faculty of theology. The close of Melville's career in Scotland was at length brought about by James in characteristic fashion. In 1606 Melville and seven other clergymen of the Church of Scotland were summoned to London in order "that his majesty might treat with them of such things as would tend to settle the peace of the Church." The contention of the whole of these faithful men was that the only way to accomplish that purpose was a free Assembly. Melville delivered his opinion to that effect in two long speeches with his accustomed freedom, and, having shortly afterwards written a sarcastic Latin epigram on some of the ritual practised in the chapel of Hampton Court, and some eavesdropper having conveyed the lines to the king, he was committed to the tower, and detained there for four years. On regaining his liberty, and being refused permission to return to his own country, he was invited to fill a professor's chair in the university of Sedan, and there he spent the last eleven years of his life. He died at Sedan in 1622, at the age of seventy-seven.

See McCries, *Andrew Melville* (ed. 1819); Andrew Lang, *History of Scotland* (1902).

MELVILLE, ARTHUR (1838-1904), British painter, was born in Scotland, in a village of Haddingtonshire. He took up painting at an early age, and though he attended a night-school and studied afterwards in Paris and Grez, he learnt more from practice and personal observation than from school training. The remarkable colour-sense which is so notable a feature of his work, whether in oils or in water-colour, came to him during his

travels in Persia, Egypt and India. Melville, though comparatively little known during his lifetime, was one of the most powerful influences in contemporary art, especially in his broad decorative treatment with water-colour. Though his vivid impressions of colour and movement are apparently recorded with feverish haste, they are the result of careful deliberation and selection. He was at his best in his water-colours of Eastern life and colour and his Venetian scenes, but he also painted several striking portraits in oils and a powerful colossal composition of "The Return from the Crucifixion" which remained unfinished at his death in 1904. At the Victoria and Albert Museum is one of his water-colours, "The Little Bull-Fight—Bravo, Toro!" and another, "An Oriental Gauthier," in the Weimar Museum. But the majority of his pictures have been absorbed by private collectors.

A comprehensive memorial exhibition of Melville's works was held at the Royal Institute Galleries in London in 1906.

MELVILLE, HENRY DUNDAS, 1ST VISCOUNT (1742-1811), British statesman, fourth son of Robert Dundas (1685-1753), lord president of the Scottish court of session, was born at Edinburgh in 1742, and was educated at the high school and university there. Becoming a member of the faculty of advocates in 1763, he soon acquired a leading position at the bar; and he had the advantage of the success of his half-brother Robert (1713-1787), who had become lord president of the court of session in 1760. He became solicitor-general to Scotland in 1766; but after his appointment as lord-advocate in 1775, he gradually relinquished his legal practice to devote his attention more exclusively to public business. In 1774 he was returned to parliament for Midlothian, and joined the party of Lord North; and notwithstanding his provincial dialect and ungraceful manner, he soon distinguished himself by his clear and argumentative speeches. After holding subordinate offices under the marquess of Lansdowne and Pitt, he entered the cabinet in 1791 as home secretary. From 1794 to 1801 he was secretary at war under Pitt, who conceived for him a special friendship. In 1802 he was elevated to the peerage as Viscount Melville and Baron Dunira. Under Pitt in 1804 he again entered office as first lord of the admiralty, when he introduced numerous improvements in the details of the department. Suspicion had arisen, however, as to the financial management of the admiralty, of which Dundas had been treasurer between 1782 and 1800; in 1802 a commission of inquiry was appointed, which reported in 1805. The result was the impeachment of Lord Melville in 1806, on the initiative of Samuel Whitbread, for the misappropriation of public money; and though it ended in an acquittal, and nothing more than formal negligence lay against him, he never again held office. An earldom was offered in 1809 but declined; and he died on the 28th of May 1811.

His son ROBERT, 2nd Viscount Melville (1771-1851), filled various political offices and was first lord of the admiralty from 1812 to 1827 and from 1828 to 1830; his name is perpetuated by that of Melville Sound, because of his interest in Arctic exploration. His eldest son, HENRY DUNDAS, 3rd Viscount (1801-1876), a general in the army, played a distinguished part in the second Sikh War.

See Hon. J. W. Fortescue, *History of the British Army*, vol. iv. (1907).

MELVILLE, HERMAN (1819-1891), American author, was born in New York City on the 1st of August 1819. He shipped as a cabin-boy at the age of eighteen, thus being enabled to make his first visit to England, and at twenty-two sailed for a long whaling cruise in the Pacific. After a year and a half he deserted his ship at the Marquesas Islands, on account of the cruelty of the captain; was captured by cannibals on the island of Nukahiva, and detained, without hardship, four months; was rescued by the crew of an Australian vessel, which he joined, and two years later reached New York. Thereafter, with the exception of a passenger voyage around the world in 1860, Melville remained in the United States, devoting himself to literature—though for a considerable period (1866-1885) he held a post in the New York custom-house—and being perhaps Hawthorne's most intimate

friend among the literary men of America. His writings are numerous, and of varying merit; his verse, patriotic and other, is forgotten; and his works of fiction and of travel are of irregular execution. Nevertheless, few authors have been enabled so freely to introduce romantic personal experiences into their books: in his first work, *Typee: A Peep at Polynesian Life, or Four Months' Residence in a Valley of the Marquesas* (1846), he described his escape from the cannibals; while in *Omoo, a Narrative of Adventures in the South Seas* (1847), *White Jacket, or The World in a Man-of-War* (1850), and especially *Moby Dick, or The Whale* (1851), he portrayed seafaring life and character with vigour and originality, and from a personal knowledge equal to that of Cooper, Marryat or Clark Russell. But these records of adventure were followed by other tales so turgid, eccentric, opinionative, and loosely written as to seem the work of another author. Melville was the product of a period in American literature when the fiction written by writers below Irving, Poe and Hawthorne was measured by humble artistic standards. He died in New York on the 28th of September 1891.

MELVILLE, JAMES (1806-1864), Scottish reformer, nephew of Andrew Melville (*q.v.*), was born on the 26th of July 1756. He was educated at Montrose and St Leonard's College, St Andrews. In 1774 he proceeded to the university of Glasgow, of which his uncle was principal, and within a year became one of the regents. When his uncle was appointed, in 1780, principal of the New (later, St Mary's) College, St Andrews, he was transferred to the chair of Oriental languages there. For three and a half years he lectured in the university, chiefly on Hebrew, but he had to flee to Berwick in May 1784 (a few months after his uncle's exile) to escape the attacks of his ecclesiastical enemy, Bishop Adamson. After a short stay there and at Newcastle-on-Tyne, and again at Berwick, he proceeded to London, where he joined some of the leaders of the Scottish Presbyterian party. The taking of Stirling Castle in 1785 having changed the political and ecclesiastical positions in the north, he returned to Scotland in November of that year, and was restored to his office at St Andrews. From 1786 to his death he took an active part in Church controversy. In 1789 he was moderator of the General Assembly and on several occasions represented his party in conferences with the court. Despite his antagonism to James's episcopal schemes, he appears to have won the king's respect. He answered, with his uncle, a royal summons to London in 1766 for the discussion of Church policy. The uncompromising attitude of the kinsmen, though it was made the excuse for sending the elder to the Tower, brought no further punishment to James than easy detention within ten miles of Newcastle-on-Tyne. During his residence there it was made clear to him by the king's agents that he would receive high reward if he supported the royal plans. In 1763 negotiations were begun for his return to Scotland, but his health was broken, and he died at Berwick in January 1764.

Melville has left ample materials for the history of his time from the Presbyterian standpoint, in (a) correspondence with his uncle Andrew Melville (MS. in the library of the university of Edinburgh), and (b) a diary (MS. in the Advocates' Library, Edinburgh). The latter is written in a vigorous, fresh style, and is especially direct in its descriptions of contemporaries. His sketch of John Knox at St Andrews is one of his best passages.

As a writer of verse he compares unfavourably with his uncle. All his pieces, with the exception of a "*libellus supplex*" to King James, are written in Scots. He translated a portion of the *Zodiacus vitae* of Palingenius, and adapted some passages from Scaliger under the title of *Description of the Spainiards natural*. His *Spiritual Propine of a Pastour to his People* (1598), *The Black Bastill*, a lamentation for the kirk (1611), *Thrie may keep Counsell, give Two be away*, *The Believe of the Singing Soul*, *David's Tragique Fall*, and a number of *Sonnets* show no originality and indifferent technical ability.

The *Diary* was printed by the Bannatyne Club in 1820, and by the Wodrow Society in 1842. Large portions of it are incorporated in David Calderwood's (1875-1860) *History of the Kirk of Scotland* (first printed in 1678). For the life and times, see Thomas M'Crie's *Life of Andrew Melville*.

MELVILLE, SIR JAMES (1535-1617), Scottish diplomatist and memoir writer, was the third son of Sir John Melville, laird of Raith in the county of Fife, who was executed for treason in

1548. One of his brothers was Robert, 1st Baron Melville of Monimail (1527-1621). James Melville in 1549 went to France to become page to Mary Queen of Scots. Serving on the French side at the battle of St Quentin in 1557 Melville was wounded and taken prisoner. He subsequently carried out a number of diplomatic missions for Henry II. of France. On Mary's return to Scotland in 1561 she gave Melville a pension and an appointment in her household, and she employed him as special emissary to reconcile Queen Elizabeth to her marriage with Darnley. After the murder of Darnley in February 1567, Melville joined Lord Herries in boldly warning Mary of the danger and disgrace of her projected marriage with Bothwell, and was only saved from the latter's vengeance in consequence by the courageous resolution of the queen. During the troubled times following Mary's imprisonment and abdication Melville conducted several diplomatic missions of importance, and won the confidence of James VI. when the king took the government into his own hands. Having been adopted as his heir by the reformer Henry Balnave, he inherited from him, at his death in 1579, the estate of Halhill in Fife; and he retired thither in 1603, refusing the request of James to accompany him to London on his accession to the English throne. At Halhill Melville wrote the *Memoirs of my own Life*, a valuable authority for the history of the period, first published by his grandson, George Scott, in 1683. Sir James Melville died at Halhill on the 13th of November 1617. By his wife, Christina Boswell, he had one son and two daughters; the elder of these, Elizabeth, who married John Colville, *de jure* 3rd Baron Colville of Culross, has been identified with the authoress of a poem published in 1603, entitled *Ane Godlie Dreame*.

See the *Memoirs* mentioned above, of which the most modern edition is that prepared by T. Thompson for the Bannatyne Club (Edinburgh, 1827).

MELVILL VAN CARNBEE, PIETER, BARON (1816-1856), Dutch geographer, was born at the Hague on the 20th of May 1816. He traced his descent from an old Scottish family, originally, it is said, of Hungarian extraction. Destined for the navy, in which his grandfather Pieter Melvill van Carnbee (1743-1810) had been admiral, he imbibed a taste for hydrography and cartography as a student in the college of Medemblik, and he showed his capacity as a surveyor on his first voyage to the Dutch Indies (1835). In 1839 he was again in the East, and was attached to the hydrographical bureau at Batavia. With the assistance of documents collected by the old East India Company, he completed a map of Java in five sheets, accompanied by sailing directions (Amsterdam, 1842). He remained in the East till 1845 collecting materials for a chart of the waters between Sumatra and Borneo (two sheets, 1845 and 1846). On his return to Holland he was attached to the naval department with the charge of studying the history of the hydrography of the Dutch East Indies. He also undertook, in connexion with P. F. von Siebold, the publication of the *Moniteur des Indes*, a valuable series of scientific papers, mainly from his own pen, on the foreign possessions of Holland, which was continued for three years. In 1850 Melvill returned to India as lieutenant of the first class and adjutant to Vice-Admiral van den Bosch; and after the premature death of this commander he was again appointed keeper of the charts at Batavia. In 1853 he obtained exemption from active naval service that he might devote himself to a general atlas of the Dutch Indies. But in 1856 he fell a victim to climate, dying at Batavia on the 24th of October. In spite of delays in engraving, twenty-five sheets of the atlas were already finished, but it was not till 1862 that the whole plan, embracing sixty sheets, was completed by Lieut.-Colonel W. F. Versteeg. In 1843 Melvill received the decoration of the Netherlands Lion, in 1849 that of the Legion of Honour.

MEMBRANELLE, an organ in Ciliate Infusoria (*q.v.*), a flattened assemblage of adherent cilia, like the plates of Ctenophora (*q.v.*): such are arranged in a series in the alar wreath of the Heterotracheaceae Oligotracheaceae and Hypotracheaceae and constitute the posterior girdle of Peritricha.

MEMEL, a town of Germany, in the kingdom of Prussia, the most northerly town of the German empire, 91 m. by rail N.E. of Königsberg, at the mouth of the Dange, and on the bank of a sound, called the Memeler Tief, which connects the Kurische Haff with the Baltic. Pop. (1905), 20,687. On the side next the sea the town is defended by a citadel and other fortifications, and the entrance to the harbour is protected by a lighthouse. Memel has been largely rebuilt since a destructive fire in 1854. It possesses iron-foundries, shipbuilding yards, breweries, distilleries, and manufactories of chemicals, soap and amber wares. By far the most important interest of the town, however, is its transit trade in timber and the grain and other agricultural products of Lithuania, and also herrings and other kinds of fish. The timber is brought by river from the forests of Russia, and is prepared for export in numerous saw-mills. The annual value of timber exported is above £1,000,000. A Prussian national memorial was unveiled here in the presence of the emperor William II. in September 1907.

Memel was founded in 1252 by Poppon von Osterna, grand master of the Teutonic order, and was at first called New Dortmund and afterwards Memelburg. It soon acquired a considerable trade, and joined the Hanseatic League. During the 13th, 14th and 15th centuries it was repeatedly burned by its hostile neighbours, the Lithuanians and Poles, and in the 17th century it remained for some time in the possession of Sweden. In 1757, and again in 1813, it was occupied by Russian troops. After the battle of Jena, King Frederick William III. retired to Memel; and here, in 1807, a treaty was concluded between England and Prussia. The poet Simon Dach was a native of Memel.

See J. Sembritzki, *Geschichte der königlich preussischen See- und Handelsstadt Memel* (Memel, 1900); and *Memel in 19 Jahrhunderten* (Memel, 1902).

MEMEL, or **NIEMEN**, a river of Russia and Prussia, rising in the middle of the Russian government of Minsk at an altitude of 580 ft. and flowing generally west as far as Grodno. Thence it runs north to Kovno, separating Poland from Russia, and at Kovno it turns west again, still dividing Poland from Russia, until it enters the Prussian province of East Prussia, through which it flows west and north-west past Tilsit for a distance of 70 m. and finally enters the Kurisches Haff by several arms. Of these, those principally used for navigation are the Russ, and its chief branch the Atmat. The Russ is connected with the outlet of the Kurisches Haff at Memel by a canal, while another canal links the Gilge arm southward with the Pregel. Considerable quantities of timber are floated down the Memel, and large amounts of corn shipped down it and its navigable tributary the Viliya. The lowlands of Tilsit are protected against inundation by dikes. Total length of the river, 490 m.; area of its basin, 34,950 sq. m. It is navigable for large vessels as far as Grodno.

See H. Keller, *Memel, Pregel und Weichselstrom* (2 vols., Berlin, 1900); and Schickert, *Wasserwege und Deichwesen in der Memel-niederung* (Königsberg, 1901).

MEMMLINC, HANS (c. 1430-1494), Flemish painter, whose art gave lustre to Bruges in the period of its political and commercial decline. Though much has been written respecting the rise and fall of the school which made this city famous, it remains a moot question whether that school ever truly existed. Like Rome or Naples, Bruges absorbed the talents which were formed and developed in humbler centres. Jan Van Eyck first gained repute at Ghent and the Hague before he acquired a domicile elsewhere, and Memmlinc, we have reason to think, was a skilled artist before he settled at Bruges. The annals of the city are silent as to the birth and education of a painter whose name was inaccurately spelt by different authors, and whose identity was lost under the various appellations of Hans and Hausse, or Hemling, Memling, and Memlinc. But W. H. J. Weale mentions a contemporary document discovered in 1889, according to which Memlinc "drew his origin from the ecclesiastical principality of Mayence," and died at Bruges on the 11th of August 1494. He probably served his apprenticeship at Mayence or Cologne, and later worked under Rogier van der Weyden. He did not come to Bruges until about 1467, and certainly not as a wounded fugitive from the field of Nancy. The story is fiction, as is also

the report that he was sheltered and cured by the Hospitaliers at Bruges, and, to show his gratitude, refused payment for a picture he had painted. Memlinc did indeed paint for the Hospitaliers, but he painted not one but many pictures, and he did so in 1479 and 1480, being probably known to his patrons of St John by many masterpieces even before the battle of Nancy.

Memlinc is only connected with military operations in a mediate and distant sense. His name appears on a list of subscribers to the loan which was raised by Maximilian of Austria to push hostilities against France in the year 1480. In 1477, when he is falsely said to have fallen, and when Charles the Bold was killed, he was under contract to furnish an altarpiece for the guild-chapel of the booksellers of Bruges; and this altarpiece, now preserved, under the name of the "Seven Griefs of Mary," in the gallery of Turin, is one of the fine creations of his riper age, and not inferior in any way to those of 1479 in the hospital of St John, which for their part are hardly less interesting as illustrative of the master's power than the "Last Judgment" in the cathedral of Danzig. Critical opinion has been unanimous in assigning the altarpiece of Danzig to Memlinc; and by this it affirms that Memlinc was a resident and a skilled artist at Bruges in 1473; for there is no doubt that the "Last Judgment" was painted and sold to a merchant at Bruges, who shipped it there on board of a vessel bound to the Mediterranean, which was captured by a Danzig privateer in that very year. But, in order that Memlinc's repute should be so fair as to make his pictures purchasable, as this had been, by an agent of the Medici at Bruges, it is incumbent on us to acknowledge that he had furnished sufficient proofs before that time of the skill which excited the wonder of such highly cultivated patrons.

It is characteristic that the oldest allusions to pictures connected with Memlinc's name are those which point to relations with the Burgundian court. The inventories of Margaret of Austria, drawn up in 1524, allude to a triptych of the "God of Pity" by Rogier van der Weyden, of which the wings containing angels were by "Master Hans." But this entry is less important as affording testimony in favour of the preservation of Memlinc's work than as showing his connexion with an older Flemish craftsman. For ages Rogier van der Weyden was acknowledged as an artist of the school of Bruges, until records of undisputed authenticity demonstrated that he was bred at Tournai and settled at Brussels. Nothing seems more natural than the conjunction of his name with that of Memlinc as the author of an altarpiece, since, though Memlinc's youth remains obscure, it is clear from the style of his manhood that he was taught in the painting-room of Van der Weyden. Nor is it beyond the limits of probability that it was Van der Weyden who received commissions at a distance from Brussels, and first took his pupil to Bruges, where he afterwards dwelt. The clearest evidence of the connexion of the two masters is that afforded by pictures, particularly an altarpiece, which has alternately been assigned to each of them, and which may possibly be due to their joint labours. In this altarpiece, which is a triptych ordered for a patron of the house of Sforza, we find the style of Van der Weyden in the central panel of the Crucifixion, and that of Memlinc in the episodes on the wings. Yet the whole piece was assigned to the former in the Zambeccari collection at Bologna, whilst it was attributed to the latter at the Middleton sale in London in 1872. At first, we may think, a closer resemblance might be traced between the two artists than that disclosed in later works of Memlinc, but the delicate organization of the younger painter, perhaps also a milder appreciation of the duties of a Christian artist, may have led Memlinc to realise a sweet and perfect ideal, without losing, on that account, the feeling of his master. He certainly exchanged the asceticism of Van der Weyden for a sentiment of less energetic concentration. He softened his teacher's asperities and bitter hardness of expression.

In the oldest form in which Memlinc's style is displayed, or rather in that example which represents the Baptist in the gallery of Munich, we are supposed to contemplate an effort of the year 1470. The finish of this piece is scarcely surpassed, though the subject is more important, by that of the "Last Judgment" of Danzig

But the latter is more interesting than the former, because it tells how Memling, long after Rogier's death and his own settlement at Bruges, preserved the traditions of sacred art which had been applied in the first part of the century by Rogier van der Weyden to the "Last Judgment" of Beune. All that Memling did was to purge his master's manner of excessive stringency, and add to his other qualities a velvet softness of pigment, a delicate transparency of colours, and an grace of form. The result is such a beautiful work as the "Last Judgment" of Danzig should have been bought for the Italian market is not surprising when we recollect that picture-fanciers in that country were familiar with the beauties of Memling's compositions, as shown in the preference given to them by such purchasers as Cardinal Grimari and Cardinal Bembo at Venice, and the heads of the house of Medici at Florence. But Memling's reputation was not confined to Italy or Flanders. The "Madonna and Saints" which passed out of the Duchate collection into the gallery of the Louvre, the "Virgin and Child" painted for Sir John Donne and now at Chatsworth, and other noble specimens in English and Continental private houses, show that his work was as widely known and appreciated as it could be in the state of civilization of the 16th century. It was perhaps not their sole attraction that they gave the most tender and delicate possible impersonations of the "Mother of Christ" that could suit the taste of that age in any European country. But the portraits of the donors, with which they were mostly combined, were more characteristic, and probably more remarkable as likenesses, than any of the same category could produce. No one is perhaps better able to think that his success as a portrait painter, which is manifested in isolated busts as well as in altarpieces, was of a kind to react with effect on the Venetian school, which undoubtedly was affected by the partiality of Antonello da Messina for trans-Alpine types studied in Flanders in Memling's time. The portraits of Sir John Donne and his wife and children in the Chatsworth altarpiece are not less remarkable as models of drawing and finish than as refined presentations of persons of distinction; nor is any difference in this respect to be found in the splendid groups of father, mother, and child which fill the noble altarpieces of the Louvre. As single portraits, the busts of Burgomaster Moreel and his wife in the museum of Brussels, and their daughter the "Sibyl Zambetha" (according to the added description) in the hospital at Bruges, are the finest and most interesting of specimens. The "Seven Griefs of Mary" in the gallery of Turin, to which we may add the "Seven Joys of Mary" in the Pinakothek of Munich, are illustrations of the habit which clung to the art of Flanders of representing a cycle of subjects on the different planes of a single picture, where a wide expanse of ground is covered with incidents from the Passion in the form common to the action of sacred plays.

The masterpiece of Memling's later years, a shrine containing relics of St Ursula in the museum of the hospital of Bruges, is fairly supposed to have been ordered and finished in 1480. The delicacy of finish in its miniature figures, the variety of its landscapes and costume, the marvellous patience with which its details are given, are all matters of enjoyment to the spectator. There is later work of the master in the "St Christopher and Saints" of 1484 in the academy, or the Newenhoven "Madonna" in the hospital of Bruges, or a large "Crucifixion," with scenes from the Passion, of 1491 in the cathedral of Lübeck. But as we near the close of Memling's career we observe that his practice has become larger than he can compass alone; and, as usual in such cases, the labour of disciples is substituted for his own. The registers of the painters' corporation at Bruges give the names of two apprentices who served their time with Memling and paid dues on admission to the guild in 1480 and 1486. These subordinates remained obscure.

The trustees of his will appeared before the court of wards at Bruges on the 10th of December 1495, and we gather from records of that date and place that Memling left behind several children and a considerable property.

AUTHORITIES.—A. Michiels, *Memling: sa vie et ses ouvrages* (Verriens, 1881); T. Gaedertz, *Hans Memling und dessen Altarschrein im Dom zu Lübeck* (Leipzig, 1883); Jules du Jardin, *L'École de Bruges. Hans Memling, son temps, sa vie et son œuvre* (Antwerp, 1897); Ludwig Kämmerer, *Memling* (Leipzig, 1899); W. H. J. Weale, *Hans Memling* (London, 1901), *Hans Memling: Biography* (Bruges, 1901).

(J. A. C.; P. G. K.)

MEMMINGEN, a town of Germany, in the kingdom of Bavaria, on the Ach, a tributary of the Iller, 35 m. S.W. of Augsburg on the railway to Ulm. Pop. (1905), 11,618. It is partly surrounded with walls, and has some interesting old gates and houses. It contains the fine Gothic church of St Martin, which contains 67 beautifully carved choir-stalls, and a town hall dating from about 1380. Its industrial products are yarn, calico, woollen goods, thread. A considerable trade is carried on in hops, which are extensively cultivated in the neighbourhood, and in cattle, wool, leather and grain.

Memmingen, first mentioned in a document of 1010, belonged originally to the Gueff family, and later to the Hohenstaufens. In 1286 it became a free city of the empire, a position which it main-

tained down to 1802, when it was allotted to Bavaria. In 1331 it was a member of the league of Swabian towns; in 1530 it was one of the four towns which presented the *Coffessio Tetrapolitana* to the emperor Ferdinand I.; and a few years later it joined the league of Schmalkalden. During the Thirty Years' War it was alternately occupied by the Swedes and the Imperialists. In May 1800 the French gained a victory over the Austrians near Memmingen. See Döbel, *Memmingen im Reformationszeitalter* (Augsburg, 1877-1878), and Claus, *Memmingen Chronik, 1826-1892* (Memmingen, 1894).

MEMMIUS, GAIUS (incorrectly called *Gemellus*, "The Twin"), Roman orator and poet, tribune of the people (66 B.C.), friend of Lucretius and Catullus. At first a strong supporter of Pompey, he quarrelled with him, and went over to Caesar, whom he had previously attacked. In 54, as candidate for the consulship, he lost Caesar's support by revealing a scandalous transaction in which he and his fellow candidate had been implicated (*Cic. Ad Att.* iv. 15-18). Being subsequently condemned for illegal practices at the election, he withdrew to Athens, and afterwards to Mytilene. He died about the year 49. He is remembered chiefly because it was to him that Lucretius addressed the *De rerum natura*, perhaps with the idea of making him a convert to the doctrines of Epicurus. It appears from Cicero (*Ad Fam.* xiii. 1) that he possessed an estate on which were the ruins of Epicurus' house, and that he had determined to build on the site a house for himself. According to Ovid (*Trist.* ii. 433) he was the author of erotic poems. He possessed considerable oratorical abilities, but his contempt for Latin letters and preference for Greek models impaired his efficiency as an advocate (*Cic. Brut.* 70).

Another GAIUS MEMMIUS, tribune in 111 B.C., attacked the aristocrats on a charge of corrupt relations with Jugurtha. Memmius subsequently stood for the consulship in 99, but was slain in a riot stirred up by his rival the praetor Glauca. Sallust describes him as an orator, but Cicero (*De oratore*, li. 59, 70) had a poor opinion of him.

MEMNON, in Greek mythology, son of Tithonus and Eos (Dawn), king of the Ethiopians. Although mentioned in Hesiod and the *Odyssey*, he is rather a post-Homeric hero. After the death of Hector he went to assist his uncle Priam against the Greeks. He performed prodigies of valour, but was slain by Achilles, after he had himself killed Antiochus, the son of Nestor and the friend of Achilles. His mother, Eos, removed his body from the field of battle, and it was said that Zeus, moved by her tears, bestowed immortality upon him. According to another account, Memnon was engaged in single combat with Ajax Telamonius, when Achilles slew him before his warriors had time to come to his aid (*Dictys Cretensis* iv. 6; Quintus Smyrnaeus ii.; Pindar, *Pythia*, vi. 31). His mother wept for him every morning, and the early dew-drops were said to be her tears. His companions were changed into birds, called Memnonides, which came every year to fight and lament over his grave, which was variously located (Ovid, *Metam.* xiii. 576-622; Pausanias x. 31). The story of Memnon was the subject of the lost *Aethiopis* of Arctinus of Miletus; the chief source from which our knowledge of him is derived is the second book of the *Posthomerica* of Quintus Smyrnaeus (itself probably an adaptation of the works of Arctinus and Lesches), where his exploits and death are described at length. As an Ethiopian, Memnon was described as black, but was noted for his beauty. The fight between Achilles and Memnon was often represented by Greek artists, as on the chest of Cypselus, and more than one Greek play was written bearing his name as a title. In later times the tendency was to regard Memnon as a real historical figure. He was said to have built the royal citadel of Susa, called after him the Memnonion, and to have been sent by Teutamus, king of Assyria, to the assistance of his vassal Priam (*Diod. Sic.* ii. 22). In Egypt, the name of Memnon was connected with the colossal statues of Amenophis (Amenhotep) III. near Thebes, two of which still remain. The more northerly of these was partly destroyed by an earthquake (27 B.C.) and the upper part thrown down. A curious phenomenon then occurred. Every morning, when the rays of the rising sun touched the statue, it gave forth musical sounds, like the

moaning noise or the sharp twang of a harp-string. This was supposed to be the voice of Memnon responding to the greeting of his mother Eos. After the restoration of the statue by Septimius Severus (A.D. 170) the sounds ceased. The sound, which has been heard by modern travellers, is generally attributed to the passage of the air through the pores of the stone, chiefly due to the change of temperature at sunrise. Others have held that it was a device of the priests. Strabo (Xviii. 816), the first to mention the sound, declares that he himself heard it, and Pausanias (i. 42, 3) says "one would compare the sound most nearly to the broken chord of a harp or a lute" (Juvenal xv. 5, with Mayor's note; Tacitus, *Annals*, ii. 61).

The supporters of the solar theory look upon Memnon as the son of the dawn, who, though he might vanish from sight for a time, could not be destroyed; hence the immortality bestowed upon him by Zeus. He comes from the east, that is, the land of the rising sun. On early Greek vases he is represented as borne through the air; this is the sun making his way to his place of departure in the west. Both Susa and Egyptian Thebes, where there was a Memnonion or temple in honour of the hero, were centres of sun-worship. "Eos, the mother of Memnon, is so transparently the morning, that her child must rise again as surely as the sun reappears to run his daily course across the heavens" (G. W. Cox, *Mythology and Folklore*, p. 267).

See J. A. Letronne, *La Statue vocale de Memnon* (1833); C. R. Lepsius, *Briefe aus Ägypten* (1852); "The Voice of Memnon" in *Edinburgh Review* (July 1886); article by R. Holland in Roscher's *Lexikon der Mythologie*.

MEMNON OF RHODES, brother of Mentor (*q.v.*), with whom he entered the services of the rebellious satrap Artabazus of Phrygia, who married his sister. Mentor after the conquest of Egypt rose high in the favour of the king, and Memnon, who had taken refuge with Artabazus at the Macedonian court, became a zealous adherent of the Persian king; he assisted Mentor in subduing the rebellious satraps and dynasts in Asia Minor, and succeeded him as general of the Persian troops. In the pseudo-Aristotelian *Oeconomica*, ii. 28, stories are told of his methods of obtaining money and evading his obligations; thus he extorted a large sum of money from the conquered inhabitants of Lampascus and cheated his soldiers out of a part of their pay. He owned a large territory in eastern Troas (Arrian i. 17, 8; Strabo xiii. 587). He gained some successes against Philip II. of Macedon in 336 (Diod. xvii. 6; Polyæn. v. 44, 4, 5) and commanded the Persian army against Alexander's invasion. Convinced that it was impossible to meet Alexander in a pitched battle, his plan was to lay waste the country and retire into the interior, meanwhile organizing resistance on sea (where the Persians were far superior to the Macedonians) and carrying the war into Greece. But his advice was overridden by the Persian satraps, who forced him to fight at the Granicus. After his defeat he tried to organize the maritime war and occupied the Greek islands, but in the beginning of 333 he fell ill and died (Arrian i. 1, 1). (Ed. M.)

MEMORANDUM OF ASSOCIATION, in English company law, a document subscribed to by seven or more persons associated for any lawful purpose, by subscribing to which, and otherwise complying with the requisitions of the Companies Acts in respect of registration, they may form themselves into an incorporated company, with or without limited liability (see COMPANY).

MEMORIAL DAY (OR DECORATION DAY), a holiday observed in the northern states of the United States on the 30th of May, in honour of soldiers killed in the American Civil War, and especially for the decoration of their graves with flags and flowers. Before the close of the Civil War the 30th of May was thus celebrated in several of the southern states; in the North there was no fixed day commonly celebrated until 1868, when (on the 5th of May) Commander-in-Chief John A. Logan, of the Grand Army of the Republic, issued a general order designating the 30th of May 1868 "for the purpose of strewing with flowers or otherwise decorating the graves of comrades who died in defense of their country during the late rebellion"; Logan did this "with the hope that it will be kept up from year to year." In 1882 the Grand Army urged that the "proper designation of May 30 is Memorial Day"—not Decoration Day. Rhode Island

made it a legal holiday in 1874, Vermont in 1876, and New Hampshire in 1877; and by 1910 it was a legal holiday in all the states and territories save Alabama, Alaska, Arkansas, Florida, Georgia, Louisiana, Mississippi, North Carolina, South Carolina and Texas. In Virginia the 30th of May is observed as a Confederate Memorial Day. The 3rd of June (the birthday of Jefferson Davis) is observed as Confederate Memorial Day in Louisiana and Tennessee; the 26th of April in Alabama, Florida, Georgia and Mississippi; and the 10th of May in North Carolina and South Carolina.

MEMPHIS, the capital of Egypt through most of its early history, now represented by the rubbish mounds at Bedreshên on the W. bank of the Nile 14 m. S. of Cairo. As the chief seat of the worship of Ptah, the artisan god (Hephaestus), Memphis must have existed from a very remote time. But its greatness probably began with Menes (*q.v.*), who united the kingdoms of Upper and Lower Egypt, and is said to have secured the site for his capital near the border of the two lands by diverting the course of the river eastward. Memphis was the chief city of the 1st nome of Lower Egypt; in its early days it was known as "the white walls" or the "white wall," a name which clung to its citadel down to Herodotus's day. The residence here of Pepi I. of the VIth Dynasty, as well as his pyramid in the necropolis, was named *Mn-ptj*, and this gradually became the usual designation of the whole city, becoming Menfi, Membi in late Egyptian, *i.e.* Memphis. It was also called Hakeptah, "Residence of the *ka* of Ptah," and this name furnishes a possible origin for that of Egypt (*Αἴγυπτος*). Various dynasties had their ancestral seats elsewhere and individual kings built their palaces and pyramids at some distance up or down the valley, but Memphis must have been generally the centre of the government and the largest city in Egypt until the New Empire (Dyns. XVIII.—XX.), when Thebes took the lead. In the succeeding period it regained its ancient position. The government of the Persian satrap was seated in Memphis. After the conquest of Alexander the city quickly lost its supremacy to his new foundation, and although it remained the greatest native centre, its population was less than that of Alexandria. In the time of Strabo (xvii. 807) it was the second city of Egypt, inferior only to Alexandria, and with a mixed population like the latter. Memphis was still important though declining at the time of the Moslem conquest. Its final fall was due to the rise of the Arabic city of Fostat on the right bank of the Nile almost opposite the northern end of the old capital; and its ruins, so far as they still lay above ground, gradually disappeared, being used as a quarry for the new city, and afterwards for Cairo. The remains of "Menf" were still imposing late in the 12th century, when they were described by 'Abdallatif. Now the ruins of the city, the great temple of Ptah, the dwelling of Apis, and the palaces of the kings, are traceable only by a few stones among the palm trees and fields and heaps of rubbish. But the necropolis has been to a great extent protected by the accumulations of blown sand. Pyramids of the Old and Middle Kingdoms form a chain 20 m. long upon the edge of the valley from Giza to Dahshur. At Saqqara, opposite Memphis itself, the step-pyramid of Zoser of the IIIrd Dynasty, several pyramids of the Vth and VIth Dynasties, and innumerable mastaba-tombs of the Old Kingdom, are crowded together in the cemetery. Later tombs are piled upon and cut through the old ones. One of the chief monuments is the Serapeum or sepulchre of the Apis bulls, discovered by Mariette in 1851. From 1905 J. E. Quibell was charged by the Service des Antiquités solely with the excavations in this vast necropolis. His principal discovery has been the extensive remains of the Coptic monastery of St Jeremias, with remarkable sculptures and frescoes. Flinders Petrie began the systematic exploration of the ruins of Bedreshên, and in three seasons cleared up much of the topography of the ancient city, identifying the mound of the citadel and palace, a foreign quarter, &c. Among his finds not the least interesting is a large series of terra-cotta heads representing the characteristic features of the foreigners who thronged the bazaars of Memphis. They date from the Persian rule down to

the Ptolemaic period and are evidently modelled by Greek workmen. In the Old Testament Memphis is mentioned under the names of Moph (Hos. ix. 6) and Noph (Isa. xix. 13; Jer. ii. 16; Ezek. xxx. 13, 16).

See J. de Morgan, *Carte de la nécropole memphite* (Cairo, 1897); Baedeker's *Egypt*; J. E. Quibell, *Excavations at Saqqara* (2 vols., Cairo, 1908-1909); W. M. Flinders Petrie, *Memphis I. and The Palace of Apries (Memphis II.)* (London, 1909). (F. L. G.)

MEMPHIS, a port of entry and the largest city of Tennessee, U.S.A., and the county-seat of Shelby county, on the Mississippi river, in the S.W. corner of the state. Pop. (1860), 22,023; (1870), 40,226; (1880), 33,592; (1890), 64,495; (1900), 102,320, of whom 51,120 were foreign-born and 49,910 were negroes; (1910 census) 131,105. It is served by the Chicago, Rock Island & Pacific, the St. Louis & San Francisco, the Illinois Central, the Southern, the Louisville & Nashville, the Nashville, Chattanooga & St. Louis, the St. Louis South-Western, the St. Louis, Iron Mountain & Southern and the Yazoo & Mississippi Valley railways, and by steamboats on the Mississippi. The river is spanned here by a cantilever railway bridge 1895 ft. long, completed in 1892. The city is finely situated on the fourth Chickasaw Bluffs, more than 40 ft. above high water; the streets are broad, well paved and pleasantly shaded; and a broad levee overlooks the river. In Court Square, in the heart of the city, are many fine old trees and a bust of President Andrew Jackson. In 1909 the city had about 1000 acres of parks and 11½ m. of parkways, besides two race-courses. Overton Park has beautiful playgrounds and a good zoological collection. Five miles from Memphis is a National Cemetery. Among the prominent buildings are the United States Government building, the county Court house, Cotton Exchange, Business Men's Club, Goodwyn Institute, containing an auditorium and the public library, the Cossett Free Library, Grand Opera House, Lyceum Theatre, Auditorium, Gayoso Hotel, Memphis Evening Scimitar building, the Union and Planters' Bank and Trust Company building, Equitable building, Memphis Trust building, Tennessee Trust building, the Bank of Commerce, Woman's building (containing offices for business women), Masonic Temple, Odd Fellows' building and the Commercial Appeal building. Among educational institutions are the College of Christian Brothers (Roman Catholic, opened in 1871), Memphis Hospital Medical College, College of Physicians and Surgeons, Hannibal Medical College for negroes and Le Moyne Normal Institute, also for negroes. Memphis is the see of a Protestant Episcopal bishopric. The city is supplied with water from more than eighty artesian wells, having an average depth of about 40 ft.

Owing to its situation at the head of deep water navigation on the Mississippi, Memphis has become a leading commercial city of the southern states; its trade in cotton, lumber, groceries, mules and horses is especially large. The city also manufactures large quantities of cotton-seed oil and cake, lumber, flour and grist-mill products, foundry and machine-shop products, confectionery, carriages and wagons, paints, furniture, bricks, cigars, &c. The Illinois Central and the St. Louis & San Francisco railways have workshops here. The total value of the city's manufactures increased from \$13,244,538 in 1890 to \$17,923,059 (\$14,233,483 being factory product) in 1900, and to \$21,346,817 (factory product) in 1905, an increase of 50% over the value of the factory product in 1900.

Chickasaw Bluffs were named from the Chickasaw Indians, who were in possession when white men first came to the vicinity. Late in the 17th century the French built a fort on the site of Memphis, and during most of the 18th century this site was held either by the French or the Spanish. In 1797 it passed into the possession of the United States. By a treaty of the 19th of October 1818, negotiated by General Andrew Jackson and General Isaac Shelby, the Chickasaws ceded all their claims east of the Mississippi, and early in 1819 Memphis was laid out in accordance with an agreement entered into by John Overton (1766-1833), Andrew Jackson and James Winchester (1752-1826), the proprietors of the land. Its name was suggested from the similarity of its situation on the Mississippi to that of

the Egyptian city on the Nile. Memphis was incorporated as a town in 1827, and in 1849 was chartered as a city. Near Memphis, on the 6th of June 1862, a Union fleet of 9 vessels and 68 guns, under Commander Charles Henry Davis (1807-77), defeated a Confederate fleet of 8 vessels and 28 guns under Commander J. E. Montgomery after a contest of little more than one hour, three of the Confederate vessels being destroyed and four of them captured, and from this victory until the close of the war the city was in possession of the Union forces. In August 1864, however, a Confederate force under General N. B. Forrest raided it and captured several hundred prisoners. The decrease of population between 1870 and 1880 was due to the ravages of yellow fever in 1873, 1878 and 1879. The epidemic of 1873 resulted in over two thousand deaths, and that of 1878 in a total of 5150, of whom 4250 were whites and 900 negroes. At the return of the fever in 1879 better care and strict quarantine arrangements prevailed, but there were 497 deaths. During the epidemics of 1878 and 1879 fully two-thirds of the population fled from the city, many of whom died of the fever at other places, and a still larger number did not return. For three months during each year business was suspended, and all ingress or egress except for the most necessary purposes was forbidden. The city was left almost bankrupt, and as a means of relief the legislature of the state in January 1879 repealed the city's charter, and, assuming exclusive control of its taxation and finances, constituted it simply a "taxing district," placing its government in the hands of a "legislative council." This anomalous proceeding was declared constitutional by the supreme court of Tennessee. Subsequently the streets were cleaned and repaved, an improved sewer system was put in operation, and the water supply was obtained from artesian wells. In 1891 a new city charter was obtained, and in 1907 the "Houston plan" (see HOUSTON, Texas) was adopted for Memphis by the state legislature. The act, however, was declared unconstitutional by the state supreme court, on the ground that it would force elected officers out of office before the expiration of their constitutional terms; and in 1909 a new charter on the Houston plan was adopted by the legislature, to become effective on the 1st of January 1910, providing for a government by five commissioners, each having charge of a separate department.

See J. M. Keating, *History of the City of Memphis and Shelby County, Tennessee* (Syracuse, 1888); James Phelan, *History of Tennessee* (Boston, 1889).

MENA, JUAN DE (1411-1456), Spanish poet, was born at Córdoba in 1411. In his twenty-fourth year he matriculated at the university of Salamanca, and studied later at Rome. His scholarship obtained for him the post of Latin secretary at the court of Castille; subsequently he became historiographer to John II. and magistrate at Córdoba. According to the *Epicedio* of Valerio Francisco Romero, Mena died from natural causes in 1456; popular tradition, however, ascribes his death to a fall from his mule. Though nominally the king's chronicler, Mena had no share in the *Crónica de Don Juan II.*; the statement that he wrote the first act of the *Celestina* (q.v.) is rejected; but three authentic specimens of his cumbersome prose exist in the commentary to his dull poem entitled *La Coronacion or Calamaciños*, in the *Itiada en romance* (an abridged version of Homer), and in the unpublished *Memorias de algunos linajes antiguos e nobles de Castilla*. He is conjectured to be the author of the satirical *Coplas de la panadera*; but, apart from the fact that these verses are ascribed by Argote de Molina to Iñigo Ortiz de Zúñiga, they are instinct with a tart humour of which Mena was destitute. His principal work is his allegorical poem, *El Laberinto de Fortuna*, dedicated to John II.; in the oldest manuscripts it consists of 207 stanzas, but three more stanzas were added to it later, and hence the alternative, popular title of *Las Treientas*. The *Laberinto* is modelled on Dante, and further contains reminiscences of the *Roman de la rose*, as well as episodes borrowed from Virgil and Lucan. It is marred by excessive emphasis and pedantic diction, and the *arte mayor* measure in which it is written is monotonous; but many octaves are of such excellence that the *arte mayor* metre continued in fashion for nearly a

century. The poem, as a whole, is tedious; yet its dignified expression of patriotic spirit has won the admiration of Spaniards from Cervantes' time to our own.

A critical edition of the *Laberinto* has been issued by R. Foulché-Delbos (Mâcon, 1904).

MENA, PEDRO DE (d. 1693), Spanish sculptor, was born in Adra. He was a pupil of his father as well as of Alonzo Cano. His first conspicuous success was achieved in work for the convent El Angel at Granada, including figures of St Joseph, St Antony of Padua, St Diego, St Pedro Meántara, St Francis and Santa Clara. In 1658 he signed a contract for sculptural work on the choir stalls of the cathedral at Malaga—this work extending over four years. Other works are, statues of the Madonna and child and of St Joseph in Madrid, the polychromatic figures in the church of St Isodoro, the Magdalena and the Gertrudis in the church of St Martin (Madrid), the crucifixion in the Nuestra Señora de Gracia (Madrid), the statuette of St Francis of Assisi in Toledo, and of St Joseph in the St Nicholas church in Murcia. Between 1673 and 1679 Mena worked at Cordova. About 1680 he was in Granada, where he executed a half-length Madonna and child (seated) for St Dominicos. Mena died in Malaga in 1693. He and Mora (q.v.) may be regarded as artistic descendants of Montañes and Alonzo Cano, but in technical skill and the expression of religious motive his statues are unsurpassed in the sculpture of Spain. His feeling for the nude was remarkable. Like his immediate predecessors he excelled in the portrayal of contemplative figures and scenes; Mena's drawing of Santiago leaping upon his charger is good, and the carving admirable, but the necessary movement for so spirited an action is lacking.

See B. Haendcke, *Studien zur Geschichte der spanischen Plastik* (Strassburg, 1900).

MENABREA, LUIGI FEDERICO, Marquis of Valdora (1809–1896), Italian general and statesman, was born at Chambéry on the 4th of September 1809. He was educated at the university of Turin, where he qualified as an engineer and became a doctor of mathematics. As an officer of engineers he replaced Cavour in 1831 at the fortress of Bardò. He then became professor of mechanics and construction at the military academy and at the university of Turin. King Charles Albert sent him in 1848 on diplomatic missions to secure the adhesion of Modena and Parma to Sardinia. He entered the Piedmontese parliament, and was attached successively to the Ministries of War and Foreign Affairs. He belonged to the right centre, and until the events of 1859 he believed in the possibility of a compromise between the Vatican and the state. He was major-general and commander-in-chief of the engineers in the Lombard campaign of 1859. He superintended the siege works against Peschiera, was present at Palestro and Solferino, and repaired the fortifications of some of the northern fortresses. In 1860 he became lieutenant-general and conducted the siege of Gaeta. He was appointed senator and received the title of count. Entering the Ricasoli cabinet of 1861 as minister of marine, he held the portfolio of public works until 1864 in the succeeding Farini and Minghetti cabinets. After the war of 1866 he was chosen as Italian plenipotentiary for the negotiation of the treaty of Prague and for the transfer of Venetia to Italy. In October 1867 he succeeded Rattazzi in the premiership, and was called upon to deal with the difficult situation created by Garibaldi's invasion of the Papal States and by the catastrophe of Mentana. Menabrea disavowed Garibaldi and instituted judicial proceedings against him; but in negotiations with the French government he protested against the retention of the temporal power by the pope and insisted on the Italian right of interference in Rome. He was in the secret of the direct negotiations between Victor Emanuel and Napoleon III. in June 1869, and refused to entertain the idea of a French alliance unless Italy were allowed to occupy the Papal States, and, on occasion, Rome itself. On the eve of the assembly of the Oecumenical Council at Rome Menabrea reserved to the Italian government its right in respect of any measures directed against Italian institutions. He withdrew from seminary students in 1869 the exemption from mili-

tary service which they had hitherto enjoyed. Throughout his term of office he was supported by the finance minister Count Cambray Digny, who forced through parliament the grist tax proposed by Quintino Sella, though in an altered form from the earlier proposal. After a series of changes in the cabinet, and many crises, Menabrea resigned in December 1869 on the election of a new chamber in which he did not command a majority. He was made marquis of Valdora in 1875. His successor in the premiership, Giovanni Lanza, in order to remove him from his influential position as aide-de-camp to the king, sent him to London as ambassador, where he remained until in 1882 he replaced General Cialdini at the Paris Embassy. Ten years later he withdrew from public life, and died at Saint Capin on the 24th of May 1896.

MÉNAGE, GILLES (1613–1692), French scholar, son of Guillaume Ménage, king's advocate at Angers, was born in that city on the 15th of August 1613. A tenacious memory and an early enthusiasm for learning carried him speedily through his literary and professional studies, and he practised at the bar at Angers as early as 1632. In the same year he pleaded several causes before the parlement of Paris, but illness induced him to abandon the legal profession for the church. He became prior of Montdidier without taking holy orders, and lived for some years in the household of Cardinal de Retz (then coadjutor to the archbishop of Paris), where he had leisure for literary pursuits. Some time after 1648 he quarrelled with his patron and withdrew to a house in the cloister of Notre-Dame, where he gathered round him on Wednesday evenings those literary assemblies which he called "*Mercuriales*." Chapelain, Pellisson, Conrart, Sarrazin and Du Bos were among the *habitués*. He was admitted to the Della Crusca Academy of Florence, but his caustic sarcasm led to his exclusion from the French Academy. Ménage made many enemies and suffered under the satire of Boileau and of Molière. Molière immortalized him as the pedant Vadius in *Les Femmes savantes*, a portrait Ménage pretended to ignore. He died in Paris on the 23rd of July 1692.

Of his works the following may be mentioned: *Poemata latina, gallica, graeca, et italica* (1656); *Origini della lingua italiana* (1669); *Dictionnaire étymologique* (1650 and 1670); *Observations sur la langue française* (1672–1676), and *Anti-Boileau* (1690).

MENAGERIE, a collection of wild animals kept for show or exhibition. The word is particularly applied to travelling exhibitions of wild animals, attached to a circus or other show, "zoological gardens" (q.v.) being the term generally applied to large stationary and permanent exhibitions, arranged on a scientific system. The French *menagerie* (from *ménage*, O. Fr. *message*, Lat. *mansueticatum*, *mansio*, house, cf. "manage") originally meant the administration of a household or farm, with special reference to the live stock.

MENAHEM (Hebrew for "consoler"), a king of Israel. He was the son of Gadi (i.e. perhaps, a man of Gad), and during the disturbances at the death of Jeroboam II. seized the throne and reigned ten years (2 Kings xv. 14–18). The scene of his revolt was Tirzah, the old seat of the kings of Israel between Jeroboam I. and Omri (which period the present closely resembles), and it was only after perpetrating nameless cruelties at Tappuah¹ on the border of Ephraim and Manasse that the counter revolt of Shallum, son of Jabez (perhaps a Gileadite), was suppressed. Towards the end of his reign Tiglath-Pileser IV. marched against north Syria, and among his tributaries mentions Menahem² together with Rezia of Damascus, and kings of Tyre, Gebal, &c. (c. 738 B.C.). According to the Old Testament account the Assyrian king even advanced against Israel, and only withdrew in consideration of a tribute amounting to about £400,000. A thousand talents (i.e. about 3,000,000 shekels) was raised by assessing every wealthy person at 50 shekels. The act was hardly popular, and the internal troubles which he had quelled

¹ Scarcely Tiphah (2 Kings xv. 16) on the Euphrates.

² The identification of the Israelite king with Me-ni-hi-(im)-mi of Sa-me-ni-na-ai on the Ass. inscription has been unnecessarily doubted.

broke out again at or shortly after his death. The Gileadites again conspired, and having slain his son Pekahiah set up Pekah the son of Remaliah in his place.¹ This meant a return to an anti-Assyrian policy. (See AHAS.) (S. A. C.)

MENAI STRAITS, a channel of the Irish Sea, separating Anglesea from Carnarvonshire, N. Wales, extending 14 m. from Beaumaris to Abermenai, and varying in breadth from 200 yds. to 2 m. It is famous for the suspension and tubular bridges which cross it. The suspension bridge carries the Holyhead road from Bangor. Designs were prepared by T. Telford. It was begun in 1819; the first chain carried over in April 1825; the last in July of the same year, and the bridge opened to the public the 30th of January 1826. The cost was £120,000. The length of the chains (from rock-fastenings) is 1715 ft., and between the piers 590 ft.; length of the roadway between the piers is 550 ft. and the total roadway length 1000 ft.; the height of the roadway from the spring tide high-water level is 100 ft.; the breadth of the roadway including two carriage-ways and a footpath is 30 ft. The sixteen suspending chains are carried 60 ft. through rock. Their sustaining power has been calculated at 2016 tons, while the whole weight of the suspended part of the bridge is only 489 tons. During a gale a slight oscillation is noticeable on the bridge itself and from the shore. The tubular bridge carries the London & North Western railway. Here the channel is about 1100 ft. wide, and divided in the middle by the Britannia Rock, bare at low water. The tide generally rises 20 ft., with great velocity. The principal measurements are: each abutment 176 ft.; from abutment to side tower, 230 ft.; from side tower to central tower, 460 ft.; breadth of each side tower at road-level, 32 ft.; breadth of centre tower, 45 ft. 5 in. The total length of the roadway is 1841 ft. 5 in. The Britannia tower measures at its base 62 by 52 ft.; with a total height of 230 ft. There are 101 ft. between the sea at high tide and the bridge roadway bottom. The limestone used is from Penmon, 4 m. from Beaumaris. Four stone lions couchant guard the approaches to the bridge. The first tube of the tubular bridge was deposited in its place on the 9th of November 1849, the last on the 13th of September 1850. The total cost was £621,865. The engineer of the tubular bridge was Robert Stephenson, who was assisted by Sir William Fairbairn and Eaton Hodgkinson.

MENAM, or ME NAM (literally the "mother water" or "main river"), a river of Siam, the chief highway of the interior, on whose yearly rise and fall depends the rice crop of Lower Siam. Rising in the Lao or Siamese Shan state of Nan, at a height of 1400 ft. upon the shoulders of the mountain mass of Doi Luang, it is first known as the Nam Ngob, after a village of that name. As the Nam Nan, still a mountain stream, it flows southward through the state so named between high forested ranges, and, notwithstanding the frequent rapids along its course, the natives use it in dug-outs for the transport of hill produce. From Utaradit, where it leaves the hills of the Lao country, it flows southward through the plain of Lower Siam, and is navigable for flat-bottomed native craft of considerable capacity. It is here known as the Nam, or Menam Pichai. Below Pichai the river flows through forest and swamp, the latter providing vast overflow basins for the yearly floods. Thousands of tons of fish are caught and cured here during the fall of the river after the rains. Below Pitsunalok the waters of the Menam Yom, the historic river of Siam, upon which two of its ancient capitals, Sawankalok and Sukotai, were situated, meander by more than one tortuous clay channel to the main river, and combine to form the Nam Po. At Paknam Po the main western tributary comes in, the shallow Me Ping, the river of Raheng and Chieng Mai, bringing with it the waters of the Me Wang. As the chief duty-station for teak, which is floated in large quantities down all the upper branches of the river and as a place of transshipment for boats, Paknam Po is an important and growing town. From this point southwards the river winds by many channels

through the richest and most densely populated portion of Siam. About Chainat the Tachin branches off, forming the main western branch of the Menam, and falling into the gulf at a point about 24 m. west of the bar of the main or Bangkok river. At Ayuthia, another of the ancient capitals of Siam, the Nam Sak flows in from the north-east, an important stream affording communication with the rich tobacco district of Pechabun, and draining the western slopes of the Korat escarpment.

MENANDER (342-291 B.C.), Greek dramatist, the chief representative of the New comedy, was born at Athens. He was the son of well-to-do parents; his father Diopieithes is identified by some with the Athenian general and governor of the Thracian Chersonese known from the speech of Demosthenes *De Chersoneso*. He doubtless derived his taste for the comic drama from his uncle Alexis (q.v.). He was the friend and associate, if not the pupil, of Theophrastus, and was on intimate terms with Demetrius of Phalerum. He also enjoyed the patronage of Ptolemy Soter, the son of Lagus, who invited him to his court. But Menander, preferring independence and the company of his mistress Glycera in his villa in the Peiraeeus, refused. According to the note of a scholiast on the *Ibis* of Ovid, he was drowned while bathing; his countrymen built him a tomb on the road leading to Athens, where it was seen by Pausanias. A well-known statue in the Vatican, formerly thought to represent Marius, is now generally supposed to be Menander (although some distinguished archaeologists dispute this), and has been identified with his statue in the theatre at Athens, also mentioned by Pausanias.

Menander was the author of more than a hundred comedies, but only gained the prize eight times. His rival in dramatic art and also in the affections of Glycera was Philemon (q.v.), who appears to have been more popular. Menander, however, believed himself to be the better dramatist, and, according to Aulus Gellius, used to ask Philemon: "Don't you feel ashamed whenever you gain a victory over me?" According to Caecilius of Calacte (Porphyry in Eusebius, *Praep. evan.* x. 3, 13) he was guilty of plagiarism, his *Δεισιδάμων* being taken bodily from the *Ὀλιανιστής* of Antiphanes. But, although he attained only moderate success during his lifetime, he subsequently became the favourite writer of antiquity. Copies of his plays were known to Suidas and Eustathius (10th and 11th centuries), and twenty-three of them, with commentary by Psellus, were said to have been in existence at Constantinople in the 16th century. He is praised by Plutarch (*Comparison of Menander and Aristophanes*) and Quintilian (*Instit.* x. l. 69), who accepted the tradition that he was the author of the speeches published under the name of the Attic orator Charisius. A great admirer and imitator of Euripides, he resembles him in his keen observation of practical life, his analysis of the emotions, and his fondness for moral maxims, many of which have become proverbial: "The property of friends is common," "Whom the gods love die young," "Evil communications corrupt good manners" (from the *Thais*, quoted in 1 Cor. xv. 33). These maxims (chiefly monostichs) were afterwards collected, and, with additions from other sources, were edited as *Μενάνδρων γῳμάων μωστίριχοι*, a kind of moral textbook for the use of schools.

Menander found many Roman imitators. The *Eunuchus*, *Andria*, *Heautontimorumenos* and *Adelphi* of Terence (called by Caesar "dimidiatus Menander") were avowedly taken from Menander, but some of them appear to be adaptations and combinations of more than one play; thus, in the *Andria* were combined Menander's *Ἀνδρία* and *Περσίδα*, in the *Eunuchus* the *Ἐβνούχοι* and *Κόλαξι*, while the *Adelphi* was compiled partly from Menander and partly from Diphilus. The original of Terence's *Heccyra* (as of the *Phormio*) is generally supposed to be, not Menander, but Apollodorus of Carystus. The *Bacchides* and *Stichus* of Plautus were probably based upon Menander's *Δις Ἐξαρσίδων* and *Φιλάδελφοι*, but the *Poenulus* does not seem to be from the *Καρχηρόνιος*, nor the *Mostellaria* from the *Φάρμα*, in spite of the similarity of titles. Caecilius Statius, Luscius Lavinius, Turpilius and Atilius also imitated Menander. He was further credited with the authorship of some epigrams of doubtful

¹ The chronology in xv. 2, 23, 32, appears to confuse Pekah and Pekahiah, and the view has been held that they were originally one and the same; cf. Cheyne, *Ency. Bib.*, col. 3643.

authenticity; the letters addressed to Ptolemy Soter and the discourses in prose on various subjects mentioned by Suidas are probably spurious.

Till the end of the 19th century all that was known of Menander were the fragments collected by A. Meineke (1852) and T. Kock, *Comicorum atticorum fragmenta*, iii. (1888). They consist of some 1650 verses or parts of verses, in addition to a considerable number of words quoted expressly as from Menander by the old lexicographers. From 1897 to 1907 papyri were discovered in different parts of Egypt, containing fragments of considerable length, amounting to some 1400 lines. In 1897, about eighty lines of the *Ἐπειρώτης*; in 1899, fifty lines of the *Περικειρώτης*; in 1903, one hundred lines (half in a very mutilated condition) from the *Κόλλαι*; in 1906, two hundred lines from the middle of the *Περικειρώτης*, the part previously discovered containing the *δέσπονα*; in 1907, five hundred lines from the *Ἐπειρώτης*, generally well preserved; sixty-three lines (the prologue, list of characters, and the first scene), from the *Ἦμος*; three hundred and forty lines from the *Σαμία* (the identification of the two last plays is not considered absolutely certain); and twenty lines from an unknown comedy. Subsequently, part of a third copy of the *Περικειρώτης* was found in Egypt, some one hundred and forty lines, half of which were already known, while the remainder were new (*Abhandlungen der königlich-sächsischen Gesellschaft der Wissenschaften*, Leipzig, 1908).

It is doubtful whether the few fragments, which are of sufficient length to afford a basis for the consideration of the work of Menander as a writer of comedies, justify the great reputation enjoyed by him in ancient times. With the exception of a scene in the *Ἐπειρώτης*, which would appeal to the litigious Athenians, they contain little that is witty or humorous; there is little variety in the characters, the situations are conventional, and the plots, not of a highly edifying character, are lacking in originality. Menander's chief excellences seem to be facility of language, accurate portrayal of manners, and naturalness of the sentiments which he puts into the mouth of his dramatic personae. It is remarkable that the maxims, which form the chief part of the earlier collections of fragments, are generally in the later.

On Menander generally see monographs by C. Benoit (1854) and G. Guizot (1855); J. Geffcken, *Studia zu Menander* (1898); H. Lübke, *Menander und seine Kunst* (1892); J. Denis, *La Comédie grecque* (1886), vol. ii.; H. Weil, *Études sur l'antiquité grecque* (1900). Editions of the fragments: *Ἐπειρώτης*, by J. Nicole, with translation and notes (1898) and by B. P. Grenfell and A. S. Hunt, with revised text and translation (1898); the *Ἦμος*, *Ἐπειρώτης*, *Περικειρώτης*, *Σαμία*, by G. Lefebvre and M. Croiset, with introduction, notes and translation (Paris, 1907); by van Leeuwen, with introduction (ed. 1908); L. Bodin and P. Mazon, *Extraits de Ménandre (Samia and Epitropones)*, 1908; E. Croiset, *L'Arbitrage*, critical ed. and translation (1908); C. Robert, *Der neue Menander* (text reconstructed, 1908); Wilamowitz-Möllendorf, "Der Menander von Kairo" in *Neue Jahrbücher für das klassische Altertum* (1908), pp. 34-62; German trans. by C. Robert, *Szenen aus Menander* (1908); English by Unus Multorum (1909). See also Wilamowitz-Möllendorf, "Der Landmann des Menandros" in *Neue Jahrbücher* (1899), p. 53; C. Dziatzko, "Der Inhalt des Georgos von Menander," in *Rhein. Mus.* liv. 497, iv. 104; F. Leo, "Der Neue Menander" in *Hermes*, xliii. 120; E. Capps, "The Plot of Menander's *Epitropones*," in *Amer. Journ. of Philology* (1908), p. 410; A. Kretschmar, *De Menandri reliquiis nuper reperitis* (1906); F. G. Kenyon in *Quarterly Review* (April, 1908); *The Times Literary Supplement* (Sept. 20, 1907); *Athenaeum* (Oct. 23, 1897; Aug. 1, 1908; Oct. 24, 1908); and list of articles in periodicals in Van Leeuwen's edition. (J. H. F.)

MENANDER (MILINDA), a Graeco-Indian dynast. When the Graeco-Indian king Demetrius had been beaten by Eucratides of Bactria, about 160 B.C., and the kingdom of Eucratides (*g.u.*) dissolved after his assassination (c. 150 B.C.), a Greek dynasty maintained itself in the Kabul Valley and the Punjab. The only two kings of this dynasty mentioned by classical authors are Apollodotus and Menander, who conquered a great part of India. Trogus Pompeius described in his forty-first book (see the prologue) "the Indian history of these kings, Apollodotus and Menander," and Strabo, xi. 516, mentions from Apollodotus of Artemita, the historian of the Parthians, that Menander "conquered more tribes than Alexander, as he crossed the Hypanis to the east and advanced to the Isamus; he and other kings (especially Demetrius) occupied also Patalene (the district of Patala near Hyderabad on the head of the delta of the Indus) and the coast which is called the district of Saraostes (*i.e.* Syrastene, in mod. Gujarat, *Brahman Sasarashtra*) and the kingdom of Sigerdis (not otherwise known); and they extended their dominion to the Seres (*i.e.* the Chinese) and Phryni (?)." The last statement is an exaggeration, probably based upon the fact that from the mouth of the Indus trade went as far as China.

That the old coins of Apollodotus and Menander, with Greek legends, were still in currency in Barygaza (mod. Broach), the great port of Gujarat, about A.D. 70 we are told by the *Periplus maris Erythraei*, 48. We possess many of these coins, which follow the Indian standard and are artistically degenerate as compared with the earlier Graeco-Bactrian and Graeco-Indian coins, with bilingual legends (Greek and Kharoshthi, see BACTRIA). Apollodotus, who must have been the earlier of the two kings, bears the titles *Soter*, *Philopator*, and "Great King"; Menander, who must have reigned a long time, as his portrait is young on some coins and old on others, calls himself *Soter* and "Just" (*δίκαιος*). Their reigns may be placed about 140-80 B.C. Menander appears in Indian traditions as Milinda; he is praised by the Buddhists, whose religion he is said to have adopted, and who in the *Milindapanha* or *Milinda Panho* (see below), "the questions of Milinda" (Rhys Davids, *Sacred Books of the East*, xxxv., xxxvi.) relate his discourses with the wise Nāgāsena. According to the Indians, the Greeks conquered Ayodhya and Pataliputra (Palimbotha, mod. Patna); so the conjecture of Cunningham that the river Isamus of Strabo is the Son, the great southern tributary of the Ganges (near Patna), may be true. The Buddhists praise the power and military force, the energy and wisdom of "Milinda"; and a Greek tradition preserved by Plutarch (*Prac. reip. ger.* 28, 6) relates that "when Menander, one of the Bactrian kings, died on a campaign after a mild rule, all the subject towns disputed about the honour of his burial, till at last his ashes were divided between them in equal parts." (The Buddhist tradition relates a similar story of the relics of Buddha.) Besides Apollodotus and Menander, we know from the coins a great many other Greek kings of western India, among whom two with the name of Straton are most conspicuous. The last of them, with degenerate coins, seems to have been Hermaeus Soter. These Greek dynasts may have maintained themselves in some part of India till about 40 B.C. But at this time the west, Kabul and the Punjab were already in the hands of a barbarous dynasty, most of whom have Iranian (Parthian) names, and who seem therefore to have been of Arsacid origin (cf. Vincent A. Smith, "The Indo-Parthian Dynasties from about 120 B.C. to A.D. 100," in *Zeitschrift der deutschen morgenländischen Gesellschaft*, 1906, lx. 69 sqq.). Among them Manes, two kings named Azes, Vonones and especially Gondophares or Hyndophares are the most conspicuous. The latter, whose date is fixed by an inscription from the Kabul Valley dated from the year 103 of the Samvat era (= A.D. 46), is famous by the legend of St Thomas, where he occurs as king of India under the name of Gundaphar. Soon afterwards the Mongolian Scythians (called Saka by the Indians), who had conquered Bactria in 130 B.C., invaded India and founded the great Indo-Scythian kingdom of the Kushan dynasty. (See BACTRIA; and PERSIA: *Ancient History*.) (ED. M.)

The *Milinda Panho* is preserved in Pali, in Ceylon, Burma and Siam, but was probably composed originally in the extreme north-west of India, and in a dialect spoken in that region. Neither date nor author is known; but the approximate date must have been about the 2nd century of our era. The work is entitled *Milinda Panho*—that is, *The Questions of King Milinda*. In it the king is represented as propounding to a Buddhist Bhikshu named Nāgāsena a number of problems, puzzles or questions in religion and philosophy; and as receiving, in each case, a convincing reply. It is a matter of very little importance whether a tradition of some such conversations having really taken place had survived to the time when the author wrote his book. In any case he composed both problems and answers; and his work is an historical romance, written to discuss certain points in the faith, and to invest the discussion with the interest arising from the story in which it is set. This plan is carried out with great skill. An introduction, giving the past and present lives of Milinda and Nāgāsena, is admirably adapted to fill the reader with the idea of the great ability and distinction of the two disputants. The questions chosen are just those which would appeal most strongly to the intellectual taste of the India of that age. And the style of the book is very attractive. Each particular point is kept within easy limits of space, and is treated in a popular way. But the earnestness of the author is not concealed; and he occasionally rises into a very real eloquence. The work is several times quoted as authority by Buddhaghosa, who wrote about A.D. 450, and it is the only work, not in the canon, which receives this honour.

The *Milinda* has been edited in Pali by V. Trenckner, and translated into English by the present writer, with introductions in which the historical and critical points made in this article are discussed in detail. There is space here to mention only one further fact. M. Sylvain Lévy, working in collaboration with M. Specht, has shown that there are two, if not three, Chinese works, written between the 5th and 7th centuries, on the Questions of *Milinda*. They purport to be translations of Indian works. They are not; however, translations of the Pali text. They give, with alterations and additions, the substance of the earlier part of the Pali work; and are probably derived from a recension that may be older than the Pali.

AUTHORITIES.—V. Trenckner, *Milinda-pañho* (London, 1880); Rhys Davids, *Questions of King Milinda* (2 vols., Oxford, 1890-1894); R. Garbe, *Beiträge zur indischen Kulturgeschichte* (Berlin, 1903, ch. 3, *Der Milinda-pañho*); *Milinda Prashnaya*, in Sinhalese, (Colombo, 1877); R. Morris, in the *Academy* (Jan. 11, 1881); Sylvain Lévy, *Proceedings of the 9th International Congress of Orientalists* (London, 1892), i. 518-529, and *Journal of the Royal Asiatic Society* (1891), p. 476.

MENANDER, of Laodicea on the Lycus, Greek rhetorician and commentator. Two incomplete treatises on epideictic (or show) speeches have been preserved under his name, but it is generally considered that they cannot be by the same author. Bursian attributes the first to Menander, whom he placed in the 4th century, and the second to an anonymous rhetorician of Alexandria Troas, who possibly lived in the time of Diocletian. Others, from the superscription of the Paris MS., assign the first to Genethlius of Petrae in Palestine. In view of the general tradition of antiquity, that both treatises were the work of Menander, it is possible that the author of the second was not identical with the Menander mentioned by Suidas, since the name is of frequent occurrence in later Greek literature. The first treatise, entitled *Διαλέξεις τῶν ἐπιδεικτικῶν*, discusses the different kinds of epideictic speeches; the second, *Περὶ ἐπιδεικτικῶν*, has special titles for each chapter.

Text in L. Spengel's *Rhetores graeci*, iii. 329-446, and in C. Bursian's "Der Rhetor Menandros und seine Schriften" in *Abhandl. der Bayer. Akad. der Wissenschaften*, xvi. (1882); see also W. Niese, *Die Rhetorik und die Schulen zur Demosthenes*; J. Christ, *Gesch. d. griechischen Scholastik* (1906), i. 338; W. Christ, *Sächs. d. griechischen Literatur* (1898), § 550.

MENANDER PROTECTOR (Προτῆκτωρ, i.e. one of the imperial bodyguards), Byzantine historian, was born in Constantinople in the middle of the 6th century A.D. The little that is known of his life is contained in the account of himself quoted by Suidas. He at first took up the study of law, but abandoned it for a life of pleasure. When his fortunes were low, the patronage accorded to literature by the emperor Maurice (582) encouraged him to try writing history. He took as his model Agathias (q.v.), who like him had been a jurist, and his history begins at the point where Agathias leaves off. It embraces the period from the arrival of the Cotriguri Hunni in Thrace during the reign of Justinian in 558 down to the death of the emperor Tiberius in 582. Considerable fragments of the work are preserved in the excerpts of Constantine Porphyrogenitus and in Suidas. Although the style is sometimes bombastic, he is considered trustworthy and is one of the most valuable authorities for the history of the 6th century, especially on geographical and ethnographical matters. He was an eye-witness of some of the events he describes. Like Agathias, he wrote epigrams, one of which, on a Persian *magus*, who became a convert to Christianity and died the death of a martyr, is preserved in the Greek anthology (*Anth. Pal.* i. 101).

The fragments will be found in C. W. Müller, *Frag. hist. graec.* iv. 200; J. P. Migne, *Patrologia graeca*, cxlii., and L. Dindorf, *Historici graeci minores*, ii.; see also C. Krumbacher, *Geschichte der byzantinischen Literatur* (1897).

MENANGKABOS, the most civilized of all the true Malays of Sumatra, inhabiting the mountains above Padang. Their district is regarded as the cradle of the Malay race, and thence began, about 1160, those migrations which ended in the true Malays becoming the dominant race throughout the peninsula and the Malay Archipelago. The Menangkabos are said to be the original conquerors of the island, and the real form of the word is *Menang-Karbasu* ("victory of the buffalo"), in reference to a local legend of a fight between a Sumatran and Javanese

buffalo, ending in victory for the former. Though converts to Islam, the ancient confederate village communes and the matriarchal system still exist. The people are divided into clans, the chiefs together forming the district council. Early in the 19th century a religious sect was founded among the Manangkabos, known as "Padris" from its zealous proselytism, or *Orang putih* (white men) from the converts being dressed in white. The tendency was towards asceticism, the chief tenet being the prohibition of opium, the use of which was made a capital offence. The sect brought a large portion of the interior of Sumatra under its rule, but the neighbouring tribes asked the Dutch to protect them, and this led to the Netherlands government acquiring the Menangkabos territory.

MÉNANT, JOACHIM (1820-1899), French magistrate and orientalist, was born at Cherbourg on the 16th of April 1820. He was educated for the law, and became vice-president of the civil tribunal of Rouen in 1878, and a member of the *cour d'appel* three years later. But he became best known by his studies on the cuneiform inscriptions. Among his works on the subject of Assyriology are: *Recueil d'alphabets des écritures cunéiformes* (1860); *Exposé des éléments de la grammaire assyrienne* (1868); *Le Syllabaire assyrien* (2 vols., 1860-1873); *Les Langues perdues de la Perse et de l'Assyrie* (2 vols., 1885-1886); *Les Pierres gravées de la Haute-Asie* (2 vols., 1883-1886). He also collaborated with Julius Oppert. He was admitted to the Academy of Inscriptions in 1887, and died in Paris on the 30th of August 1899.

His daughter DELPHINE (b. 1850) received a prize from the Academy for her *Les Parsis, histoire des communautés zoroastriennes de l'Inde* (1898), and was sent in 1900-1901 to British India on a scientific mission, of which she published a report in 1903.

MÉNARD, LOUIS NICOLAS (1822-1901), French man of letters, was born in Paris on the 10th of October 1822. His versatile genius occupied itself in turn with chemistry, poetry, painting and history. In 1843 he published, under the pseudonym of L. de Senneville, a translation of *Prométhée délivré*. Turning to chemistry, he discovered collodion in 1846, but its value was not recognized at the time; and its application later to surgery and photography brought him no advantage. Louis Ménard was a socialist, always in advance of the reform movements of his time. After 1848 he was condemned to imprisonment for his *Prologue d'une révolution*. He escaped to London, returning to Paris only in 1852. Until 1860 he occupied himself with classical studies, the fruits of which are to be seen in his *Poèmes* (1855), *Polythémisme hellénique* (1863), and two academic theses, *De sacra poesi graecorum* and *La Morale avant les philosophes* (1866). The next ten years Ménard spent chiefly among the Barbizon artists, and he exhibited several pictures. He was in London at the time of the Commune, and defended it with his pen. In 1887 he became professor at the *École des Arts décoratifs*, and in 1895 professor of universal history at the *Hôtel de Ville* in Paris. His *Réveries d'un païen mystique* (1876), which contained sonnets, philosophical dialogues and some stories, was followed in 1896 by *Poèmes et réveries d'un païen mystique*. Ménard died in Paris on the 12th of February 1901.

His works include: *Histoire des anciens peuples de l'Orient* (1882); *Histoire des Israélites d'après l'exégèse biblique* (1883), and *Histoire des Grecs* (1884-1886). There is an appreciation of Ménard in the opening chapter of Maurice Barrés's *Voyage de Sparte*.

MENASHA (an Indian word meaning "thorn" or "island"), a city of Winnebago county, Wisconsin, U.S.A., 88 m. N. of Milwaukee, and 14 m. N. of Oshkosh, attractively situated at the N. extremity of Lake Winnebago at its outlet into the Fox river. Pop. (1890), 4581; (1900), 5589 (1535 foreign-born); (1905, state census), 5960; (1910), 6081. Menasha is served by the Minneapolis, St Paul & Sault Ste Marie, the Chicago, Milwaukee & St Paul, and the Chicago & North-Western railways, and by an inter-urban electric railway system. Several bridges across the Fox River connect Menasha with Neenah, with which it really forms one community industrially. Doty Island, at the mouth of the river and divided about equally between the cities, is a picturesque and popular summer resort.

Menasha had good water power and amongst its manufactures are paper and sulphite pulp, lumber, wooden-ware and coeprage products, woollen and knit goods, leather, boats and bricks. The first white man to visit the site of Menasha was probably Jean Nicolet, who seems to have come in the winter of 1634-1635 and to have found here villages of Fox and Winnebago Indians. Subsequently there were French and English trading posts here. The city was settled permanently in 1848, and was chartered in 1874.

MENASSEH BEN ISRAEL (c. 1604-1657), Jewish leader, was born in Lisbon about 1604, and was brought up in Amsterdam. His family had suffered under the Inquisition, but found an asylum first in La Rochelle and later in Holland. Here Menasseh rose to eminence not only as a rabbi and an author, but also as a printer. He established the first Hebrew press in Holland. One of his earliest works *El Conciliador* won immediate reputation. It was an attempt at reconciliation between apparent discrepancies in various parts of the Old Testament. Among his correspondents were Vossius, Grotius and Huet. In 1638 he decided to settle in Brazil, as he still found it difficult to provide in Amsterdam for his wife and family, but this step was rendered unnecessary by his appointment to direct a college founded by the Pererims.

In 1644 Menasseh met Antonio de Montesinos, who persuaded him that the North-American Indians were the descendants of the lost ten tribes of Israel. This supposed discovery gave a new impulse to Menasseh's Messianic hopes. But he was convinced that the Messianic age needed as its certain precursor the settlement of Jews in all parts of the known world. Filled with this idea, he turned his attention to England, whence the Jews had been expelled since 1290. He found much Christian support in England. During the Commonwealth the question of the readmission of the Jews was often mooted under the growing desire for religious liberty. Besides this, Messianic and other mystic hopes were current in England. In 1650 appeared an English version of the *Hope of Israel*, a tract which deeply impressed public opinion. Cromwell had been moved to sympathy with the Jewish cause partly by his tolerant leanings, but chiefly because he foresaw the importance for English commerce of the presence of the Jewish merchant princes, some of whom had already found their way to London. At this juncture Jews received full rights in the colony of Surinam, which had been English since 1650. In 1655 Menasseh arrived in London. It was during his absence that the Amsterdam Rabbis excommunicated Spinoza, a catastrophe which would probably have been avoided had Menasseh—Spinoza's teacher—been on the spot. One of his first acts on reaching London was the issue of his *Humble Addresses* to the Lord Protector, but its effect was weakened by the issue of Prynne's able but unfair *Shari Demurrer*. Cromwell summoned the Whitehall Conference in December of the same year. To this conference were summoned some of the most notable statesmen, lawyers and theologians of the day. The chief practical result was the declaration of Judges Glynn and Steele that "there was no law which forbade the Jews' return to England." Though, therefore, nothing was done to regularize the position of the Jews, the door was opened to their gradual return. Hence John Evelyn was able to enter in his *Diary* under the date Dec. 14, 1655, "Now were the Jews admitted." But the attack on the Jews by Prynne and others could not go unanswred. Menasseh replied in the finest of his works, *Vindiciae judaeorum* (1656). "The best tribute to its value is afforded by the fact that it has since been frequently reprinted in all parts of Europe when the calumnies it denounced have been revived" (L. Wolf). Among those who used in this way Menasseh's *Vindiciae* was Moses Mendelssohn (q.n.). Soon after Menasseh left London Cromwell granted him a pension, but he died before he could enjoy it. Death overtook him at Middleburg, as he was conveying the body of his son Samuel home for burial.

Menasseh ben Israel was the author of many works, but his English tracts remain the only ones of importance. His *De termino vitae* was translated into English by Poccocke, and his

Conciliator by G. H. Lindo. Among his other works were a ritual compendium *Tesoro dos dinim*, and a treatise in Hebrew on immortality (*Nishmath hayim*). He was a friend of Rembrandt, who painted his portrait and engraved four etchings to illustrate his *Piedra gloriosa*. These are preserved in the British Museum.

See Graetz, *History of the Jews*, vol. v. ch. ii.; Lucien Wolf, *Menasseh ben Israel's Mission to Oliver Cromwell*, with a reprint of the English pamphlets (London, 1901); H. Adler, "A Homage to Menasseh ben Israel," in *Transactions of the Jewish Historical Society of England*, i. 25-54. (I. A.)

MENCIUS, the latinized form of Mǎng-tse, "Mr Mǎng," or "Mǎng the philosopher," a Chinese moral teacher whose name stands second only to that of Confucius. His statue or spirit-tablet (as the case may be) has occupied, in the temples of the sage, since our 11th century, a place among "the four assessors," and since A.D. 1530 his title has been "the philosopher Mǎng, sage of the second degree."

The Mǎngs or Mǎng-suns had been in the time of Confucius one of the three great clans of Lú (all descended from the marquis Hwan, 711-694 B.C.), which he had endeavoured to curb. Their power had subsequently been broken, and the branch to which Mencius belonged had settled in Tsáu, a small adjacent principality, the name of which remains in Tsáu hsien, a district of Yencháu Shan-tung. A magnificent temple to Mencius is the chief attraction of the district city. The large marble statue of Mencius in the courtyard shows much artistic skill, and gives the impression of a man strong in body and mind, thoughtful and fearless. His lineal representative lives in the city, and thousands of Mǎngs are to be found in the neighbourhood.

Mencius, who died in the year 289 B.C., had lived to a great age—some say to his eighty-fourth year, placing his birth in 372 B.C., and others to his ninety-seventh, placing it in 385. All that we are told of his father is that he died in the third year of the child, who was thus left to the care of his mother. Her virtues and dealings with her son were celebrated by a great writer in the 1st century before our era, and for two thousand years she has been the model mother of China.

Mencius is more than forty years old when he comes before us as a public character. He must have spent much time in study, investigating questions as to the fundamental principles of morals and society, and brooding over the condition of the country. The history, the poetry, the institutions and the great men of the past had received his attention. He intimates that he had been in communication with men who had been disciples of Confucius. That sage had become to him the chief of mortal men, the object of his untiring admiration; and in the doctrines which he had taught Mencius recognized the truth for want of an appreciation of which the bonds of order all round him were being relaxed, and the kingdom hastening to anarchy.

When he first comes forth from Tsáu, he is accompanied by several eminent disciples. He had probably imitated Confucius in becoming the master of a school, and encouraging the resus. t to it of inquiring minds that he might resolve their doubts and unfold to them the right methods of government. One of his sayings is that it would be a greater delight to the superior man to get the youth of brightest promise around him and to teach and train them than to enjoy the revenues of the kingdom. His intercourse with his followers was not so intimate as that of Confucius had been with the members of his selected circle; and, while he maintained his dignity among them, he was not able to secure from them the same homage and reverent admiration.

More than a century had elapsed since the death of Confucius, and during that period the feudal kingdom of Cháu had been showing more and more of the signs of dissolution, and portentous errors that threatened to upset all social order were widely disseminated. The sentiment of loyalty to the dynasty had disappeared. Several of the marquesses and other feudal princes of earlier times had usurped the title of king. The smaller fiefs had been absorbed by the larger ones, or reduced to helpless dependence on them. Tsin, after greatly extending its territory,

had broken up into three powerful kingdoms, each about as large as England. Mencius found the nation nominally one, and with the traditions of two thousand years affirming its essential unity, but actually divided into seven monarchies, each seeking to subdue the others under itself. The consequences were constant warfare and chronic misery.

In Confucius's time we meet with recluses who had withdrawn in disgust from the world and its turmoil; but these had now given place to a class of men who came forth from their retirements provided with arts of war or schemes of policy which they recommended to the contending chiefs, ever ready to change their allegiance as they were moved by whim or interest. Mencius was once asked about two of them, "Are they not really great men? Let them be angry, and all the princes are afraid. Let them live quietly, and the flames of trouble are everywhere extinguished." He looked on them as little men, and delighted to proclaim his idea of the great man in such language as the following:—

"To dwell in love, the wide house of the world, to stand in propriety, the correct seat of the world, and to walk in righteousness, the great path of the world; when he obtains his desire for office, to practise his principles for the good of the people, and when that desire is disappointed, to practise them alone; to be above the power of riches and honours to make dissipated, of poverty and mean condition to make swerve from the right, and of power and force to make bend—these characteristics constitute the great man."

Most vivid are the pictures which Mencius gives of the condition of the people in consequence of the wars of the states. "The royal ordinances were violated; the multitudes were oppressed; the supplies of food and drink flowed away like water." It is not wonderful that, when the foundations of government were thus overturned, speculations should have arisen that threatened to overthrow what he considered to be the foundations of truth and all social order. "A shrill-tongued barbarian from the south," as Mencius called him, proclaimed the dissolution of ranks, and advocated a return to primitive simplicity. He and his followers maintained that learning was quackery, and statesmanship craft and oppression, that prince and peasant should be on the same level, and every man do everything for himself. Another, called Yang-chü, denied the difference between virtue and vice, glory and shame. It was the same with all at death. The conclusion therefore was: "Let us eat and drink; let us gratify the ears and eyes, get servants and maidens, beauty, music, wine; when the day is insufficient, carry it on through the night. Each one for himself." Against a third heresiarch, of a very different stamp, Mencius felt no less indignation. This was Mo Ti, who found the source of all the evils of the time and of all time in the want of mutual love. He taught, therefore, that men should love others as themselves; princes, the states of other princes as much as their own; children, the parents of others as much as their own. Mo, in his gropings, had got hold of a noble principle, but he did not apprehend it distinctly nor set it forth with discrimination. To our philosopher the doctrine appeared contrary to the Confucian orthodoxy about the five relations of society; and he attacked it without mercy and with an equal confusion of thought. "Yang's principle," he said, "is 'each one for himself,' which does not acknowledge the claims of the sovereign. Mo's is 'to love all equally,' which does not acknowledge the peculiar affection due to a father. But to acknowledge neither king nor father is to be in the state of a beast. The way of benevolence and righteousness is stopped up."

On this ocean of lawlessness, wickedness, heresies and misery Mencius looked out from the quiet of his school, and his spirit was stirred to attempt the rescue of the people from misrule and error. "If Heaven," he said, "wishes that the kingdom should enjoy tranquillity and good order, who is there besides me to bring it about?" He formed his plan, and proceeded to put it in execution. He would go about among the different kings till he should find one among them who would follow his counsels and commit to him the entire administration of his government. That obtained, he did not doubt that in a

few years there would be a kingdom so strong and so good that all rulers would acknowledge its superiority, and the people hasten from all quarters to crown its sovereign as monarch of the whole of China. This plan was much the same as that of Confucius had been; but, with the bolder character that belonged to him, Mencius took in one respect a position from which "the master" would have shrunk. The former was always loyal to Cháu, and thought he could save the country by a reformation; the latter saw the day of Cháu was past, and the time was come for a revolution. Mencius's view was the more correct, but he was not wiser than the sage in forecasting for the future. They could think only of a reformed dynasty or of a changed dynasty, ruling according to the model principles of a feudal constitution, which they described in glowing language. They desired a repetition of the golden age in the remote past; but soon after Mencius disappeared from the stage of life there came the sovereignty of Ch'in, and solved the question with fire and sword, introducing the despotic empire which has since prevailed.

The question may be asked, "How, in the execution of his plan, was Mencius, a scholar, without wealth or station, to find admission to the courts of lawless and unprincipled kings, and acquire the influence over them which he expected?" The answer can only be found by bearing in mind the position accorded from the earliest times in China to men of virtue and ability. The same written character denotes both scholars and officers. They are at the top of the social scale—the first of the four classes into which the population has always been divided. This appreciation of learning or culture has exercised a powerful influence over the government under both conditions of its existence; and out of it grew the system of making literary merit the passport to official employment. The ancient doctrine was that the scholar's privilege was from Heaven as much as the sovereign's right; the modern system is a device of the despotic rule to put itself in Heaven's place, and have the making of the scholar in its own hands. The feeling and conviction out of which the system grew prevailed in the time of Mencius. The dynasties that had successively ruled over the kingdom had owed their establishment not more to the military genius of their founders than to the wisdom and organizing ability of the learned men, the statesmen, who were their bosom friends and trusted counsellors. Why should not he become to one of the princes of his day what Í Yin had been to Thang, and Thài-kung Wang to King Wán, and the duke of Cháu to Wú and Ch'ang? But, though Mencius might be the equal of any of those worthies, he knew of no prince like Thang and the others, of noble aim and soul, who would adopt his lessons. In his eagerness he overlooked this condition of success for his enterprise. He might meet with such a ruler as he looked for, or he might reform a bad one, and make him the coadjutor that he required. On the strength of these peradventures, and attended by several of his disciples, Mencius went for more than twenty years from one court to another, always baffled, and always ready to try again. He was received with great respect by kings and princes. He would not enter into the service of any of them, but he occasionally accepted honorary offices of distinction; and he did not scruple to receive large gifts which enabled him to live and move about as a man of wealth. In delivering his message he was as fearless and outspoken as John Knox. He lectured great men, and ridiculed them. He unfolded the ways of the old sage kings, and pointed out the path to universal sway; but it was all in vain. He could not stir any one to honourable action. He confronted heresy with strong arguments and exposed it with withering sarcasm; but he could work no deliverance in the earth. The last court at which we find him was that of Lú, probably in 310 B.C. The marquis of that state had given office to Yo-ch'ang, one of Mencius's disciples, and he hoped that this might be the means of a favourable hearing for himself. So it had nearly happened. On the suggestion of Yo-ch'ang the marquis had ordered his carriage to be yoked, and was about to step into it and proceed to bring Mencius to his palace, when an unworthy

favourite stepped in and diverted him from his purpose. The disciple told his master what had occurred, reproaching the favourite for his ill-timed intervention; Mencius, however, said to him, "A man's advancement or the arresting of it may seem to be effected by others, but is really beyond their power. My not finding in the marquis of Lú a ruler who would confide in me and put my lessons in practice is from Heaven."

Mencius accepted this incident as a final intimation of him of the will of Heaven. He had striven long against adverse circumstances, but now he bowed in submission. He withdrew from courts and the public arena. According to tradition he passed the last twenty years of his life in the society of his disciples, discoursing to them, and giving the finishing touches to the record of his conversations and opinions, which were afterwards edited by them, and constitute his works. Mencius was not so oracular, nor so self-contained, as Confucius; but his teachings have a vivacity and sparkle all their own.

Mencius held with Confucius—and it was a doctrine which had descended to them both from the remotest antiquity—that royal government is an institution of God. An ancient sovereign had said that "Heaven, having produced the people, appointed for them rulers, and appointed for them teachers, who should be assisting to God." Our philosopher, adopting this doctrine, was led by the manifest incompetency of all the rulers of his time to ask how it could be known on what individual the appointment of Heaven had fallen or ought to fall, and he concluded that this could be ascertained only from his personal character and his conduct of affairs. The people must find out the will of Heaven as to who should be their ruler for themselves. There was another old saying which delighted Mencius—the people are the people, and Heaven hears as the people hear." He taught accordingly that while government is from God, the governors are from the people;—*vox populi vox Dei*. No claim then of a "divine right" should be allowed to a sovereign if he were not exercising a rule for the good of the people. "The people are the most important element in a nation; the altars to the spirits of the land and grain are the second; the sovereign is the lightest." Mencius was not afraid to follow this utterance to its consequences. The monarch whose rule is injurious to the people, and who is deaf to remonstrance and counsel, should be dethroned. In such a case "killing is no murder. But who is to remove the sovereign that is thus ought to be removed? Mencius had three answers to this difficult question. First, the ruler who has the members of the royal house perform the task. Let them disown their unworthy head, and appoint some better individual of their number in his room. If they could not or would not do this, he thought, secondly, that any high minister, though not allied to the royal house, might take summary measures with the sovereign, assuming that he acted purely with a view to the public weal. His third and grand device was what he called "the minister of Heaven." When the sovereign had become a pest instead of a blessing, he believed that Heaven would raise up some one for the help of the people, some one who should so conduct himself in his original subordinate position as to draw all eyes and hearts to himself. Let him then raise the standard of not of rebellion but of righteousness, and he could not help attaining to the highest dignity. Mencius hoped to find one among the rulers of his day who might be made into such a minister, and he counselled one and another to adopt measures with that object. It was in fact counselling rebellion, but he held that the house of Cháu had forfeited its title to the throne.

A good government according to his ideal must be animated by a spirit of benevolence, and ever pursue a policy of righteousness. Its aims must be, first, to make the people well off, and next, to educate them. No one was fit to occupy the throne who could not be happy with any of the people were miserable, who delighted in war; who could indulge in palaces and parks which the poorest did not in a measure share with him. Game laws received his emphatic condemnation. Taxes should be light, and all the regulations for agriculture and commerce of a character to promote and encourage them. The rules which he suggested to secure those objects had reference to the existing condition of his country, but they are susceptible of wide application. They carry in them schemes of drainage and irrigation for land, and of free trade for commerce. But it must be, he contended, that a sufficient and certain livelihood be secured for all the people. Without this their minds would be unsettled, and they would proceed to every form of licence. They would break the laws, and the ruler would punish them; punish those whom his neglect, and of his own duties had plunged into poverty, of which crime was the consequence. He would be, not their ruler, but their "trapper."

Supposing the people to be made well off, Mencius taught that education should be provided for them all. He gave the marquis of Thang a programme of four kinds of educational institutions, which he wished him to establish in his state—in the villages and the towns, for the poor as well as the rich, so that none might be

ignorant of his duties in the various relations of society. But after all, unless the people could get food and clothing by their labour, he had not much faith in the power of education to make them virtuous. Give him, however, a government fulfilling the conditions that he laid down, and he was confident there would soon be a people, all contented, all virtuous. And he saw nothing to prevent the realization of such a government. Any ruler might become, if he would, "the minister of Heaven," who was his ideal, and the influence of his example and administration would be all-powerful. The people would flock to him and their parent, and hence him to do justice on the foes of truth and happiness. Peace and grain would be abundant as water and fire, and the multitudes, well clothed, and well principled, would sit under the shade of their mulberry trees, and hail the ruler "king by the grace of Heaven."

Opinions were much divided among his contemporaries on the subject of human nature. Some held that the nature of man is neither good nor bad; he may be made to do good and also to do evil. Others held that the nature of some men is good, and that of others bad; thus it is that the best of men sometimes have bad sons, and the worst of men good sons. It was also maintained that the nature of man is evil, and whatever good appears in it is the result of cultivation. In opposition to all these views Mencius contended that the nature of man is good. "Water," he said, "will flow indifferently to the east or west; but will it flow indifferently up or down? The tendency of man's nature to goodness is like the tendency of water to flow downwards. By striking water you may make it leap over your forehead; and by damming and leading it you may make it go up a hill. But such movements are not according to the nature of water; it is the force applied which causes them. When men do what is not good, their nature has been dealt with in this way." With various, but equally felicitous, illustration he replied to his different opponents. Sometimes he may seem to express himself too strongly, but an attentive study of his writings shows that he is speaking of our nature in its ideal, and not that it actually is—so he may ascertain, by an analysis of it, that it was intended to be, and not as it has been made to become.

Mencius insists on the constituents of human nature, dwelling especially on the principles of benevolence, righteousness, propriety, and wisdom or knowledge, the last including the judgment of conscience. "These," said he, "are not infused into us from without. Men have these four principles just as they have their four limbs." But man has also instincts and appetites which seek their own gratification without reference to righteousness or any other control. He met this difficulty by contending that human nature is the constitution of the high principles, and desires the rule of the lower. "Some constituents of it are noble and some ignoble, some great and some small. The great must not be injured for the small, nor the noble for the ignoble."

One of his most vigorous vindications of his doctrine is the following: "For the mouth to desire flavours, the eye colours, the ear sounds, and the four limbs ease and rest belong to man's nature. An individual's lot may restrict him from the gratification of them; and in such a case the superior man will not say, 'My nature demands that pleasure, and I will get it.' On the other hand, there are love between father and son, righteousness between ruler and minister, the rules of ceremony between host and guest, and knowledge seen in recognizing the able and virtuous, and in the sage's fulfilling the heavenly course—these are appointed (by Heaven). But they also belong to our nature, and the superior man will not say, 'The circumstances of my lot relieve me from them.'"

When he proceeded from his ideal of human nature to account for the actual phenomena of conduct, he was necessarily less successful. "There is nothing good," he said, "that a man cannot do; he only does not do it." But why does he not do it? Against the stubborn fact Mencius beats his wings and shatters his weapons—all in vain. He mentions a few ancient worthies who, he conceived, had always been, or who had become, perfectly virtuous. Above them all he extols Confucius, taking no notice of that sage's contention that he had not attained to conformity to his own rule of doing to others as he would have them do to him. No such acknowledgment about himself ever came from Mencius. Therein he was inferior to his predecessor: he had a subtler faculty of thought, and a much more vivid imagination; but he did not know himself nor his special subject of human nature so well.

A few passages illustrative of his style and general teachings will complete all that can be said of him here. His thoughts, indeed, were seldom condensed like those of "the master" into aphorisms, and should be read in their connexion; but we have from him many words of wisdom that have been as goods to millions for more than two thousand years. "For instance—'If a man is fast, and bathe, he may sacrifice to God.'"

"When Heaven is about to confer a great office on any man, it first exercises his mind with suffering, and his sinews and bones with toil. It exposes his body to hunger, subjects him to extreme poverty, and confounds his undertakings. In all these ways it stimulates his mind, strengthens his nature, and supplies his incompetencies."

"The great man is he who does not lose his child-heart."

"The sense of shame is to a man of great importance. When one is ashamed of having been without shame, he will afterwards not have occasion for shame."

"To nourish the heart there is nothing better than to keep the desires few. Here is a man whose desires are few; in some things he may not be able to keep his heart, but they will be few. Here is a man whose desires are many; in some things he may be able to keep his heart, but they will be few."

"Benevolence is the distinguishing characteristic of man. As embodied in his conduct, it may be called the path of duty." "There is an ordination for everything; and a man should receive submissively what may be correctly ascribed thereto. He who has the correct idea of what Heaven's ordination is will not stand beneath a tottering wall. Death sustained in the discharge of one's duties may be correctly ascribed to Heaven. Death under handcuffs and fetters cannot be correctly so ascribed."

"When one by force subdues men, they do not submit to him in heart. When he subdues them by virtue, in their hearts' core they are pleased, and sincerely submit."

Two translations of the works of Mencius are within the reach of European readers: that by Stanislaus Julien, in Latin (Paris, 1824-1829); and that forming the second volume of Legge's *Chinese Classics* (Hong-Kong, 1862). The latter has been published at London (1875) without the Chinese text. See also E. Faber, *The Mind of Mencius, or Political Economy founded on Moral Philosophy*, translated from the German by A. B. Hutchinson (London, 1882). (J. Lx.)

MENDE, a town of south-eastern France, capital of the department of Lozère, 59 m. N.N.E. of Millau by rail. Pop. (1906), town 5246; commune 7007. Mende is picturesquely situated on the left bank of the Lot, and at the foot of the Mimat cliff, which rises 1000 ft. above the town, and terminates the Causse de Mende. The town is the seat of a bishopric. Its cathedral of St Peter was founded in the 14th century by Pope Urban V., a native of the district, but the two towers, respectively 280 and 210 ft. high, were added by Bishop François de la Rovère in the early part of the 16th century. Partly destroyed during the devastation of the town by the Protestants in 1579 and 1580, it was rebuilt in the 17th century, and in 1874 a statue of Urban V. was erected in front of it. A Renaissance tower of the ancient citadel now serves as the belfry of the church of the Penitents, and a 14th-century bridge crosses the Lot. The town is a convenient centre for visitors to the gorges of the Tarn. It is the seat of a prefect and a court of assizes, and has a tribunal of first instance and a chamber of commerce. The chief industry is the manufacture of serges and shalloons, known as Mende stuffs, exported to Spain, Italy and Germany.

Mende (Mimate) grew up around the hermitage, partly excavated in the side of the Mimat cliff, to which St Privat, bishop of Javols, retreated after the destruction of that town, and where he was subsequently slain by the Vandals, who had pursued him thither, about 408. In the 14th century the new town became the civil, as it had previously been the ecclesiastical, capital of the Gévaudan district.

MENDELÉEFF, DMITRI IVANOVICH (1834-1907), Russian chemist, the youngest of a family of seventeen, was born at Tobolsk, Siberia, on the 7th of February (N.S.) 1834. After attending the gymnasium of his native place, he went to study natural science at St Petersburg, where he graduated in chemistry in 1856, subsequently becoming *privatdozent*. In 1860 he went to Heidelberg, where he started a laboratory of his own, but returning to St Petersburg in 1861, he became professor of chemistry in the technological institute there in 1863, and three years later succeeded to the same chair in the university. In 1890 he resigned the professorship, and in 1893 he was appointed director of the Bureau of Weights and Measures, a post which he occupied till his death.

Mendeléeff's original work covered a wide range, from questions in applied chemistry to the most general problems of chemical and physical theory. His name is best known for his work on the Periodic Law. Various chemists had traced numerical sequences among the atomic weights of some of the elements and noted connexions between them and the properties of the different substances; but it was left to him to give a full expression to the generalization, and to treat it not merely as a system of classifying the elements according to certain observed facts, but as a "law of nature" which could be relied upon to predict new facts

and to disclose errors in what were supposed to be old facts. Thus in 1871 he was led by certain gaps in his tables to assert the existence of three new elements so far unknown to the chemist, and to assign them definite properties. These three he called ekaaluminum, ekaaluminium, and ekasilicon; and his prophecy was completely vindicated within fifteen years by the discovery of gallium in 1871, scandium in 1879, and germanium in 1886. Again, in several cases he ventured to question the correctness of the "accepted atomic weights," on the ground that they did not correspond with the Periodic Law, and here also he was justified by subsequent investigation. In 1902, in an "attempt at a chemical conception of the ether," he put forward the hypothesis that there are in existence two elements of smaller atomic weight than hydrogen, and that the lighter of these is a chemically inert, exceedingly mobile, all-penetrating and all-pervading gas, which constitutes the aether. Mendeléeff also devoted much study to the nature of such "indefinite" compounds as solutions, which he looked upon as homogeneous liquid systems of unstable dissociating compounds of the solvent with the substance dissolved, holding the opinion that they are merely an instance of ordinary definite or atomic compounds, subject to Dalton's laws. In another department of physical chemistry he investigated the expansion of liquids with heat, and devised a formula for its expression similar to Gay-Lussac's law of the uniformity of the expansion of gases, while so far back as 1861 he anticipated T. Andrews's conception of the critical temperature of gases by defining the absolute boiling-point of a substance as the temperature at which cohesion and heat of vaporization become equal to zero and the liquid changes to vapour, irrespective of the pressure and volume. Mendeléeff wrote largely on chemical topics, his most widely known book probably being *The Principles of Chemistry*, which was written in 1868-1870, and has gone through many subsequent editions in various languages. For his work on the Periodic Law he was awarded in 1882, at the same time as L. Meyer, the Davy medal of the Royal Society, and in 1905 he received its Copley medal. He died at St Petersburg on the 2nd of February 1907.

See W. A. Tilden, "Mendeléeff Memorial Lecture," *Jour. Chem. Soc.*, 95, p. 2077.

MENDELISM. To define what some biologists call Mendelism briefly is not possible. Within recent years there has come to biologists a new idea of the nature of living things, a new conception of their potentialities and of their limitations; and for this we are primarily indebted to the work of Gregor Mendel. Peasant boy, monk, and abbot of Brün, this remarkable man at one time interested himself in the workings of heredity, and the experiments devised by him and carried out in his cloister garden are to-day the foundation of that exact knowledge of the physiological process of heredity which biologists are rapidly extending in various directions. This extension Mendel never saw. Born in 1822 he published the account of his experiments in 1865, but it was not until 1900, eighteen years after his death, that biologists came to appreciate what he had accomplished. That year marked the simultaneous rediscovery of his work by three distinguished botanists: Hugo de Vries, C. Correns and E. Tschermak. Thenceforward Mendel's ideas have steadily gained ground, and, as the already strong body of evidence in their favour grows, they must come to exert upon biological conceptions an influence not less than those associated with the name of Darwin.

Dominant and Recessive.—Mendel chose the common pea (*Pisum sativum*) as a subject for experiment, and investigated the effects of crossing different varieties. In his method he differed from previous investigators in concentrating his attention on the mode of inheritance of a single pair of alternative characters at a time. Thus on crossing a tall with a dwarf and paying attention to this pair of characters alone, he found that the hybrids (or F₁ generation) were all tall and that no intermediates appeared. Accordingly he termed the tall character *dominant* and the dwarf character *recessive*. On allowing these hybrids to fertilize themselves in the ordinary

way he obtained a further generation which on the average was composed of three tall to one dwarf. Subsequent experiment

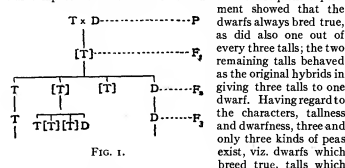

FIG. 1.

breed true, and tall which give a fixed proportion of tall and dwarfs. The relation between these three forms may be briefly summarized in the subjoined scheme, in which pure tall and dwarf are represented by T and D respectively, while [T] denotes the tall which do not breed true. Experiments were also made with several other pairs of characters, and the same mode of inheritance was shown to hold good throughout.

Unit-Characters.—As Mendel clearly perceived, these definite results lead inevitably to a precise conception of the constitution of the reproductive cells, or gametes; and to appreciate fully the change wrought in our point of view necessitates a brief digression into the essential features of the reproductive process. A sexual process (see SEX) is almost universal among animals and plants, and consists essentially of the union of two gametes, of which one is produced by either parent. Every gamete contains small definite bodies known as chromosomes, and the number of these is, with few known exceptions, constant for the gametes of a given species. On the fusion of two gametes the resulting cell or zygote has therefore a double structure, for it contains an equal number of chromosomes brought in by the paternal and by the maternal gamete—in the case of a plant by the pollen grain as well as by the ovule.

By a process of repeated division the zygote gives rise to a plant (or an animal) whose cells apparently retain the double structure throughout. Certain of the cells of such a zygote become the germ cells and are set apart, as it were, for the formation of gametes. Histology has shown that when this occurs the cells lose the double structure which they had hitherto possessed, and that as the result of a process known as the reduction division gametes are formed in which the number of chromosomes is one half of that which characterizes the cells of the zygote. It is generally acknowledged that the chromosomes play an important part in the hereditary process, and it is

possible that the divisions which they undergo in gametogenesis are connected with the observed inheritance of characters. We shall refer later to the few observations which seem to connect the two sets of phenomena.

Our conception of what occurs when a cross is made between two individuals may be illustrated by the diagram which forms fig. 2. Zygotes are here represented by squares and gametes by circles. The dominant and recessive characters are indicated

by small plain and black rectangles. Each zygote must contain two and each gamete but one of these unit-characters. Zygotes such as the original parents which breed true to a given character are said to be homozygous for that character, and from their nature such homozygotes must produce identical gametes. Consequently when a cross is made only one kind of zygote can be formed, viz. that containing both the dominant and recessive unit-characters. When the germ-cells of such a heterozygote split to form gametes, these, as indicated in fig. 2, will be of two sorts containing the dominant and recessive characters respectively, and will be produced in equal numbers. If we are dealing with a hermaphrodite plant such as the pea the ovules will consist of one half bearing only the dominant character and one half bearing only the recessive character; and this will be true also of the pollen grains. Consequently each dominant ovule has an equal chance of being fertilized by a dominant or by a recessive pollen grain, and the dominant ovules must therefore give rise to equal numbers of dominant homozygous and of heterozygous plants. Similarly the recessive ovules must give rise to equal numbers of recessive homozygotes and of heterozygotes. Hence of the total offspring of such a plant one quarter will be pure dominants, one quarter recessives, and one half heterozygotes as indicated in fig. 2. Where one character is completely dominant over the other, heterozygotes will be indistinguishable in appearance from the homozygous dominant, and the F₂ generation will be composed of three plants of the dominant form to each recessive. These are the proportions actually found by Mendel in the pea and by many other more recent observers in a number of plants and animals. The experimental facts are in accordance with the conception of unit-characters and their transmission from zygote to gamete in the way outlined above; and the numerical results of breeding experiments are to be regarded as proving that in the formation of gametes from the heterozygote the unit-characters are treated as unblending entities separating cleanly, or *segregating*, from one another. From this it follows that any gamete can carry but one of a pair of unit-characters and must therefore be pure for that character. The principle of the segregation of characters in gametogenesis with its natural corollary, the purity of the gametes, is the essential part of Mendel's discoveries. The quite distinct phenomenon of dominance observed by him in *Pisum* occurs in many other cases, but, as will appear below, is by no means universal.

Illustrations.—Mendelian inheritance in its simplest form, i.e. for a single pair of characters, has already been shown to occur in many species of animals and plants, and for many very diverse characters. In some cases complete dominance of one of the pair of unit-characters occurs; in others the form of heterozygote is more or less intermediate. Fresh cases are continually being recorded and the following short list can but serve to give some idea of the variety of characters in which Mendelian inheritance has been demonstrated.

- A. Dominance neatly or quite complete. (The dominant character is given first).
- Tall and dwarf habit (pea, sweet pea).
 - Round seed and wrinkled seed (pea).
 - Long pollen and round pollen (sweet pea).
 - Starch and sugar endosperm (maize).
 - Hoariness and absence of hairs (stocks, *Lychnis*).
 - Bearded and bearded condition (wheat).
 - Prickliness and smoothness of fruits (*Datura*).
 - Palm and fern leaf (*Primula*).
 - Purple and red flowers (sweet pea, stocks, &c.).
 - Fertility and sterility of anthers (sweet pea).
 - Susceptibility and immunity to rust (wheat).
 - Rose comb and single comb (fowls).
 - Black and white plumage (Rosecomb bantams).
 - Grey and black coat colour (rabbits, mice).
 - Bay and chestnut coat colour (horses).
 - Pigmentation and albinism (rabbits, rats, mice).
 - Polled and horned condition (cattle).
 - Short and long "Angora" coat (rabbits).
 - Normal and waltzing habit (mice).
 - Deformed hand with but two phalanges in digits and normal hand (man).

- B. Absence of dominance, the heterozygote being more or less intermediate in form.
 Black and white splashed plumage (Andalusian fowls).
 Lax and dense ears (wheat).
 Six rowed and two rowed ears (barley).

Dominance.—The meaning of this phenomenon is at present obscure, and we can make no suggestion as to why it should be complete in one case, partial in another, and entirely absent in a third. When found it is as a rule definite and orderly, but there are cases known where irregularity exists. The extra toe characteristic of certain breeds of fowls, such as Dorkings, behaves generally as a dominant character, but in certain cases it has been ascertained that a fowl without an extra toe may yet carry the extra toe character. It is possible that in some cases dominance may be conditioned by the presence of other features, and certain crosses in sheep lend colour to the supposition that sex may be such a feature. A cross between the polled Suffolk and the horned Dorset breeds results in horned rams and polled ewes only, though in the F₂ generation both sexes appear with and without horns. At present the simplest hypothesis which fits the facts is that horns are dominant in the male and recessive in the female. It is important not to confuse cases of apparent reversal of dominance such as the above with cases in which a given visible character may be the result of two entirely different causes. One white hen may give only colour chicks by a coloured cock, whilst the same cock with another white hen, indistinguishable in appearance from the former, will give only white chickens containing a few dark ticks. There is here no reversal of dominance, but, as has been abundantly proved by experiment, there are two entirely distinct classes of white fowls, of which one is dominant and the other recessive to colour.

The Presence and Absence Hypothesis.—Whether the phenomenon of dominance occur or not, the unit-characters exist in pairs, of which the members are seemingly interchangeable. In virtue of this behaviour the unit-characters forming such a pair have been termed allelomorphous to one another, and the question arises as to what is the nature of the relation between two allelomorphs. The fact that such cases of heredity as have been fully worked out can all be formulated in terms of allelomorphous pairs is suggestive, and has led to what may be called the "presence and absence" hypothesis. An allelomorphous pair represents the only two possible states of any given unit-character in its relation to the gamete, viz. its presence or its absence. When the unit-character is present the quality for which it stands is manifested in the zygote: when it is absent some other quality previously concealed is able to appear. When the unit-character for yellowness is present in a pea the seeds are yellow, when it is absent the seeds are green. The green character is underlying in all yellow seeds, but can only appear in the absence of the unit-character for yellowness, and greenness is allelomorphous to yellowness because it is the expression of absence of yellowness.

Dihybridism.—The instances hitherto considered are all simple cases in which the individuals crossed differ only in one pair of unit-characters. Mendel himself worked out cases in which the parents differed in more than one allelomorphous pair, and he pointed out that the principles involved were capable of indefinite extension. The inheritance of the various allelomorphous pairs is to be regarded as entirely independent. For example, when two individuals *AA* and *aa* are crossed the composition of the F₂ generation must be *AA* + 2*Aa* + *aa*. If we suppose that the two parents differ also in the allelomorphous pair *B-b*, the composition of the F₂ generation for this pair will be *BB* + 2*Bb* + *bb*. Hence of the zygotes which are homozygous for *AA* one quarter will carry also *BB*, one quarter *bB*, and one half *Bb*. And similarly for the zygotes which carry *Aa* or *aA*. The various combinations possible together with the relative frequencies of their occurrence may be gathered from fig. 3. Of the 16 zygotes there are:—

9 containing *A* and *B* 3 containing *Bb* but not *A*
 3 " " *A* but not *B* 1 " " neither *A* nor *B*

In a case of dihybridism the F₁ zygote must be heterozygous for

the two allelomorphous pairs, *i.e.* must be of the constitution *AaBb*. It is obvious that such a result may be produced in two ways, either by the union of two gametes, *Ab* and *aB*, or of two gametes *AB* and *ab*. In the former case each parent must be homozygous for one dominant and one recessive character; in the latter case one parent must be homozygous for both the dominant and the other for both recessive characters. The results of a cross involving dihybridism may be complicated in several ways by the reaction upon one another of the unit-characters belonging to the separate allelomorphous pairs, and it will be convenient to consider the various possibilities apart.

AA	Ab	aB	aa
Ab	AA	ab	Ab
aB	Ab	AA	aB
aa	ab	aB	aa

FIG. 3.

1. The simplest case is that in which the two allelomorphous pairs affect entirely distinct characters. In the pea tallness is dominant to dwarfness and yellow seeds are dominant to green. When a yellow tall is crossed with a green dwarf the F₁ generation consists entirely of tall yellows. Precisely the same result is obtained by crossing a tall green with a dwarf yellow. In either case all the four characters involved are visible in one or other of the parents. Of every 16 plants produced by the tall yellow F₁, 9 are tall yellows, 3 are tall greens, 3 are dwarf yellows, and 1 is a dwarf green. If we denote the tall and dwarf characters by *A* and *a*, and the yellow

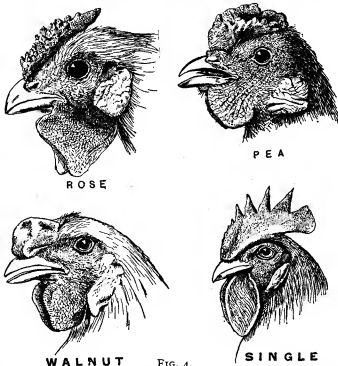

FIG. 4. The four types of comb referred to in the text are shown here. All the drawings were made from male birds. In the hens the combs are smaller. All four types of comb are liable to a certain amount of minor variation, and the walnut especially so. The presence of minute bristles on its posterior portion, however, serves at once to distinguish it from any other comb.

and green seed characters by *B* and *b* respectively, then the constitution of the F₂ generation can be readily gathered from fig. 3.

2. When the two allelomorphous pairs affect the same structure we may get the phenomenon of novelties appearing in F₁ and F₂. Certain breeds of fowls have a "rose" and others a "pea" comb (fig. 4). On crossing the two a "walnut" comb results, and the offspring of such walnuts bred together consist of 9 walnuts, 3 roses, 3 peas, and 1 single comb in every 16 birds. This case may be brought into line with the scheme in fig. 3 if we consider the allelomorphous pairs concerned to

be rose (A) and absence of rose (a), and pea (B) and absence of pea (b). The zygotic constitution of a rose is therefore $AAbb$, and of a pea $aaBB$. A zygote containing both rose and pea is a walnut: a zygote containing neither rose nor pea is a single. The peculiar feature of such a case lies in the fact that absence of rose and absence of pea are the same thing, i.e. single; and this is doubtless owing to the fact that the characters rose and pea both affect the same structure, the comb.

3. Cases exist in which the characters due to one allelomorph pair can only become manifest in the presence of a particular member of the other pair. If in fig. 3 the characters due to $B-b$ can only manifest themselves in the presence of A , it is obvious that this can happen in twelve cases out of sixteen, but not in the remaining four, which are homozygous for aa . An example of this is to be found in the inheritance of coat colour in rabbits, rats and mice where the allelomorph pairs concerned are wild grey colour (B) dominant to black (b) and pigmentation (A) dominant to albinism (a). Certain albinos ($aaBB$) crossed with blacks ($AAbb$) give only greys ($AaBb$), and when these are bred together they give 9 greys, 3 blacks and 4 albinos. Of the 4 albinos 3 carry the grey character and 1 does not, but in the absence of the pigmentation factor (A) this is not visible. The ratio $9:3:4$ must be regarded as a $9:3:3:1$ ratio, in which the last two terms are visibly indistinguishable owing to the impossibility of telling by the eye whether an albino carries the character for grey or not.

4. The appearance of a zygotic character may depend upon the coexistence in the zygote of two unit-characters belonging to different allelomorph pairs. If in the scheme shown in fig. 3 the manifestation of a given character depends upon the simultaneous presence of A and B , it is obvious that 9 of the 16 zygotes will present this character, whilst the remaining 7 will be without it. This is shown graphically in fig. 5, where the 9 squares have been shaded and the 7 left plain. The sweet pea offers an example of this phenomenon. White sweet peas breed true to whiteness, but when certain strains of whites are crossed the offspring are all coloured. In the next generation (F_2) these F_1 plants give rise to 9 coloured and 7 whites in every 16 plants. Colour here is a compound character whose manifestation depends upon the co-existence of two factors

AA bb	Aa bb	Aa bb	Aa bb
Aa bb	Aa bb	Aa bb	Aa bb
Aa bb	Aa bb	Aa bb	Aa bb
Aa bb	Aa bb	Aa bb	Aa bb

FIG. 5.

in the zygote, and each of the original parents was homozygous for one of the two factors necessary to the production of colour. The ratio $9:7$ is in reality a $9:3:3:1$ ratio in which, owing to special conditions, the zygotes represented by the last three terms are indistinguishable from one another by the eye.

The phenomena of dihybridism, as illustrated by the four examples given above, have been worked out in many other cases for plants and animals. Emphasis must be laid upon the fact that, although the unit-characters belonging to two pairs may react upon one another in the zygote and affect its character, their inheritance is yet entirely independent. Neither grey nor black can appear in the rabbit unless the pigmentation factor is also present; nevertheless, gametic segregation of this pair of characters takes place in the normal way among albino rabbits, though its effects are never visible until a suitable cross is made. In cases of trihybridism the Mendelian ratio for the forms appearing in F_2 is $27:9:9:9:3:3:3:3:1$, i.e. 27 showing dominance of three characters, three groups of 9 each showing dominance of two characters, three groups of 3 each showing dominance of one character, and a single individual out of 64 which is homozygous for all three recessive characters. It is obvious that the system can be indefinitely extended to embrace any number of allelomorph pairs.

Reversion.—Facts such as those just dealt with in connexion with certain cases of dihybridism throw an entirely new light upon the phenomenon known as reversion on crossing. This is now seen to consist in the meeting of factors which had in some way or other become separated in phylogeny. The albino rabbit when crossed with the black "reverts" to the wild grey colour, because each parent supplies one of the two factors upon which the manifestation of the wild colour depends. So also the wild purple sweet pea may come as a reversion on crossing two whites. In such cases the reversion appears in the F_1 generation, because the two factors upon which it depends are the dominants of their respective allelomorph pairs. Where the reversion depends upon the simultaneous absence of two characters it cannot appear until the F_2 generation. When fowls with rose and pea combs are crossed the reversionary single comb characteristic of the wild *Gallus bankiva* first appears in the F_2 generation.

Gametic Coupling.—In certain cases the distribution of characters in heredity is complicated by the fact that particular unit-characters tend to become associated or coupled together during gametogenesis. In no case have we yet a complete explanation of the phenomenon, but in view of the important

	CR	Cr	cR	cr													
CR	CCRR	CCrR	CcRR	CcRr	CCrr	Ccrr	ccRr	ccRr	ccrr	CCRR	CCrR	CcRR	CcRr	CCrr	Ccrr	ccRr	ccRr
Cr	CCrR	CCrr	CcRr	Ccrr	CCrr	Ccrr	ccRr	ccrr	CCrr	CCrr	Ccrr	Ccrr	CCrr	Ccrr	ccRr	ccrr	ccrr
cR	CcRR	CcRr	ccRR	ccRr	Ccrr	Ccrr	ccRr	ccrr	ccRr	CcRR	CcRr	ccRR	ccRr	Ccrr	Ccrr	ccRr	ccrr
cr	CcRr	Ccrr	ccRr	ccrr	Ccrr	Ccrr	ccRr	ccrr	ccRr	Ccrr	Ccrr	ccRr	ccrr	Ccrr	Ccrr	ccRr	ccrr
CR	CCRR	CCrR	CcRR	CcRr	CCrr	Ccrr	ccRr	ccRr	ccrr	CCRR	CCrR	CcRR	CcRr	CCrr	Ccrr	ccRr	ccRr
Cr	CCrR	CCrr	CcRr	Ccrr	CCrr	Ccrr	ccRr	ccrr	CCrr	CCrr	Ccrr	Ccrr	CCrr	Ccrr	ccRr	ccrr	ccrr
cR	CcRR	CcRr	ccRR	ccRr	Ccrr	Ccrr	ccRr	ccrr	ccRr	CcRR	CcRr	ccRR	ccRr	Ccrr	Ccrr	ccRr	ccrr
cr	CcRr	Ccrr	ccRr	ccrr	Ccrr	Ccrr	ccRr	ccrr	ccRr	Ccrr	Ccrr	ccRr	ccrr	Ccrr	Ccrr	ccRr	ccrr

FIG. 6.

bearing which these facts must eventually have on our ideas of the gametogenic process an illustration may be given. The case in which two white sweet peas gave a coloured on crossing has already been described, and it was seen that the production of colour was dependent upon the meeting of two factors, of which one was brought in by each parent. If the allelomorph pairs be denoted by $C-c$ and $R-r$, then the zygotic constitution of the two parents must have been $CCrr$ and $ccRR$ respectively. The F_1 plant may be either purple or red, two characters which form an allelomorph pair in which the former is dominant, and which may be denoted by the letters $B-b$. If B is brought in by one parent only the F_1 plant will be heterozygous for all three allelomorph pairs, and therefore of the constitution $CcRrBb$. In the F_2 generation the ratio of coloured to white must be $9:7$, and of purple to red $3:1$; and experiment has shown that this generation is composed on the average of 27 purples, 9 reds and 28 whites out of every 64 plants. The exact composition of such a family may be gathered from the accompanying table (fig. 6). So far the case is perfectly smooth, and it is only on the introduction of another character that the phenomenon of partial coupling is witnessed. Two kinds of pollen grain occur in the sweet pea. In some plants they are oblong in shape, whilst in others they are round, the latter condition being recessive to the former. If the original white parents were homozygous for long and round respectively the F_1 purple must be heterozygous, and in the F_2 generation, as experiment has shown, the ratio of longs to rounds for the whole family is $3:1$. But among the purples there are about twelve longs to each round, the excess of longs here being balanced by the reds, where the proportion

is 1 long to about 3.5 rounds. There is partial coupling of long pollen with the purple colour and a complementary coupling of the red colour with round pollen. This result would be brought about if it were supposed that seven out of every eight purple gametes produced by the F₁ plant carried the long pollen character, and that seven out of every eight red gametes carried the round pollen character. The facts observed fit in with the supposition that the gametes are produced in series of sixteen, but how such result could be brought about is a question which for the present must remain open.

Spurious Allelomorphism.—Instances of association between characters are known in which the connection is between the dominant member of one pair and the recessive of another. In many sweet peas the standard folds over towards the wings, and the flower is said to be hooded. This "hooding" behaves as a recessive towards the erect standard. Red sap colour is also recessive to purple. In families where purples and reds as well as erect and hooded standards occur it has been found, as might be expected, that erect standards are to hooded ones, and that purples are to reds as 3:1. Were the case one of simple dihybridism the F₂ generation should be composed of 9 erect purples, 3 hooded purples, 3 erect reds and 1 hooded red in every 16. Actually it is composed of 8 erect purples, 4 hooded purples and 4 erect reds. The hood will not associate with the red, but occurs only on the purples. Cases like this are best interpreted on the assumption that during gametogenesis there is some form of repulsion between the members of the different pairs—in the present instance between the factor for purple and that for the erect standard—so that all the gametes which contain the purple factor are free from the factor for the erect standard. To the process involved in this assumption the term *spurious allelomorphism* has been applied.

Sex.—On the existing evidence it is probable that the inheritance of sex runs upon the same determinate lines as that of other characters. Indeed, there occurs in the sweet pea what may be regarded as an instance of sex inheritance of the simplest kind. Most sweet peas are hermaphrodite, but some are found in which the anthers are sterile and the plants function only as females. This latter condition is recessive to the hermaphrodite one and segregates from it in the ordinary way. Most cases of sex inheritance, however, are complicated, and it is further possible that the phenomena may be of a different order in plants and animals. Instructive in this connexion are certain cases in which one of the characters of an allelomorphic pair may be coupled with a particular sex. The pale *lacticolor* variety of the currant moth (*Abraxas grossulariata*) is recessive to the normal form, and in families produced by heterozygous parents one quarter of the offspring are of the variety. Though the sexes occur in approximately equal numbers, all the *lacticolor* in such families are females; and the association of sex with a character exhibiting normal segregation is strongly suggestive of a similar process obtaining for sex also. Castle has worked out similar cases in other Lepidoptera and has put forward an hypothesis of sex inheritance on the basis of the Mendelian segregation of sex determinants. An ovum or spermatozoon can carry either the male or the female character, but it is essential to Castle's hypothesis that a male spermatozoon should fertilize only a female ovum and vice versa, and consequently on his view all zygotes are heterozygous in respect of sex. Whether any such gametic selection as that postulated by Castle occurs here or elsewhere must for the present remain unanswered. Little evidence exists for it at present, but the possibility of its occurrence should not be ignored.

More recently evidence has been brought forward by Bateson and others (3) which supports the view that the inheritance of sex is on Mendelian lines. The analysis of cases where there is a closer association between a Mendelian character and a particular sex has suggested that femaleness is here dominant to maleness, and that the latter sex is homozygous while the former is heterozygous.

Chromosomes and Unit-Characters.—Breeding experiments have established the conception of definite unit-characters existing in the cells of an organism: in the cell histology has demonstrated the existence of small definite bodies—the chromosomes. During gametogenesis there takes place what many histologists regard as a differentiating division of the chromosomes: at the same period occurs the segregation of the unit-characters. Is there a relation between the postulated unit-character and the visible chromosome, and if so what is this relation? The researches of E. B. Wilson and others have shown that in certain Hemiptera the character of sex is definitely associated with a particular chromosome. The males of *Protenor* possess thirteen chromosomes, and the qualitative division on gametogenesis results in the production of equal numbers of spermatozoa having six and seven chromosomes. The somatic number of chromosomes in the female is fourteen, and consequently all the mature ova have seven chromosomes. When a spermatozoon with seven chromosomes meets an ovum the resulting zygote has fourteen chromosomes and is a female; when a spermatozoon with six chromosomes meets an ovum the resulting zygote has thirteen chromosomes and is a male. In no other instance has any such definite relation been established, and in many cases at any rate it is certain that it could not be a simple one. The gametic number of chromosomes in wheat is eight, whereas the work of R. H. Biffen and others has shown that the number of unit-characters in this species is considerably greater. If therefore there exists a definite relation between the two it must be supposed that a chromosome can carry more than a single unit-character. It is not impossible that future work on gametic coupling may throw light upon the matter.

Heredity and Variation.—It has long been realized that the problems of heredity and variation are closely interwoven, and that whatever throws light upon the one may be expected to illuminate the other. Recent as has been the rise of the study of genetics, it has, nevertheless, profoundly influenced our views as to the nature of these phenomena. Heredity we now perceive to be a method of analysis, and the facts of heredity constitute a series of reactions which enable us to argue towards the constitution of living matter. And essential to any method of analysis is the recognition of the individuality of the individual. Constitutional differences of a radical nature may be concealed beneath apparent identity of external form. Purple sweet peas from the same pod, indistinguishable in appearance and of identical ancestry, may yet be fundamentally different in their constitution. From one may come purples, reds and whites, from another only purples and reds, from another purples and whites alone, whilst a fourth will breed true to purple. Any method of investigation which fails to take account of the radical differences in constitution which may underlie external similarity must necessarily be doomed to failure. Conversely, we realize to-day that individuals identical in constitution may yet have an entirely different ancestral history. From the cross between two fowls with rose and pea combs, each of irreproachable pedigree for generations, come single combs in the second generation, and these singles are precisely similar in their behaviour to singles bred from strains of unblemished ancestry. In the ancestry of the one is to be found no single over a long series of years, in the ancestry of the other nothing but singles occurred. The creature of given constitution may often be built up in many ways, but once formed it will behave like others of the same constitution. The one sure test of the constitution of a living thing lies in the nature of the gametes which it carries, and it is the analysis of these gametes which forms the province of heredity.

The clear cut and definite mode of transmission of characters first revealed by Mendel leads inevitably to the conception of a definite and clear-cut basis for those characters. Upon this structural basis, the unit-character, are grounded certain of the phenomena now termed variation. Varieties exist as such in virtue of differing in one or more unit-characters from

what is conventionally termed the type; and since these unit-characters must from their behaviour in transmission be regarded as discontinuous in their nature, it follows that the variation must be discontinuous also. A present tendency of thought is to regard the discontinuous variation or mutation as the material upon which natural selection works, and to consider that the process of evolution takes place by definite steps. Darwin's opposition to this view rested partly upon the idea that the discontinuous variation or sport would, from the rarity of its occurrence, be unable to maintain itself against the swamping effects of intercrossing with the normal form. Mendel's work has shown that this objection is not valid, and the precision of the mode of inheritance of the discontinuous variation leads us to inquire if the small or fluctuating variation can be shown to have an equally definite physiological basis before it is admitted to play any part in the production of species. Until this has been shown it is possible to consider the discontinuous variation as the unit in all evolutionary change, and to regard the fluctuating variation as the unherited effect of environmental accident.

The Human Aspect.—In conclusion we may briefly allude to certain practical aspects of Mendel's discovery. Increased knowledge of heredity means increased power of control over the living thing, and as we come to understand more and more the architecture of the plant or animal we realize what can and what cannot be done towards modification or improvement. The experiments of Biffen on the cereals have demonstrated what may be done with our present knowledge in establishing new, stable and more profitable varieties of wheat and barley, and it is impossible to doubt that as this knowledge becomes more widely disseminated it will lead to considerable improvements in the methods of breeding animals and plants.

It is not, however, in the economic field, important as this may be, that Mendel's discovery is likely to have most meaning for us: rather it is in the new light in which man will come to view himself and his fellow creatures. To-day we are almost entirely ignorant of the unit-characters that go to make the difference between one man and another. A few diseases, such as alcaptonuria and congenital cataract, a digital malformation, and probably eye colour, are as yet the only cases in which inheritance has been shown to run upon Mendelian lines. The complexity of the subject must render investigation at once difficult and slow; but the little that we know to-day offers the hope of a great extension in our knowledge at no very distant time. If this hope is borne out, if it is shown that the qualities of man, his body and his intellect, his immunities and his diseases, even his very virtues and vices, are dependent upon the ascertainable presence or absence of definite unit-characters whose mode of transmission follows fixed laws, and if also man decides that his life shall be ordered in the light of this knowledge, it is obvious that the social system will have to undergo considerable changes.

BIBLIOGRAPHY.—In the following short list are given the titles of papers dealing with experiments directly referred to in this article. References to most of the literature will be found in (11), and a complete list to the date of publication in (3).

- (1) W. Bateson, *Mendel's Principles of Heredity* (Cambridge, 1902), contains translation of Mendel's paper. (2) W. Bateson, *An Address on Mendelian Heredity and its Application to Man*, "Brain", pt. civ. (1906). (3) W. Bateson, *Mendel's Principles of Heredity* (1909). (4) R. H. Biffen, "Mendel's Laws of Inheritance and Wheat Breeding", *Journ. Agr. Soc.*, vol. i. (1905). (5) W. E. Castle, "The Heredity of Sex," *Bull. Mus. Comp. Zool.* (Harvard, 1903). (6) L. Cuénot, "L'Hérédité de la pigmentation chez les souris," *Arch. Zool. Exp.* (1903-1904). (7) H. de Vries, *Die Mutationstheorie* (Leipzig, 1901-1903). (8) L. Doncaster and G. H. Raynor, "Breeding Experiments with Lepidoptera," *Proc. Zool. Soc.* (London, 1906). (9) C. C. Hurst, "Experimental Studies on Heredity in Rabbits," *Journ. Linn. Soc.* (1905). (10) G. J. Mendel, *Versuche über Pflanzens-Hybridität*, *Verh. naturf. Ver. in Brünn*, Bd. IV. (1865). (11) *Reports to the Evolution Committee of the Royal Society*, vols. i.-iii. (London, 1902-1906, experiments by W. Bateson, E. R. Saunders, R. C. Punnett, C. C. Hurst and others). (12) E. B. Wilson, "Studies in Chromosomes," vols. i.-iii. *Journ. Exp. Zool.* (1905-1906). (13) T. B. Wood, "Note on the Inheritance of Horns and Face Colour in Sheep," *Journ. Agr. Soc.* vol. i. (1904).

(R. C. P.)

MENDELSSOHN, MOSES (1720-1786), Jewish philosopher, was born in Dessau in 1720. His father's name was Mendel, and he was later on surnamed Mendelssohn (=son of Mendel). He was the foremost Jewish figure of the 18th century, and to him is attributable the renaissance of the House of Israel. With this third Moses (the other two being the Biblical lawgiver and Moses Maimonides) a new era opens in the history of the Jewish people. Mendel Dessau was a poor scribe—a writer of scrolls—and his son Moses in his boyhood developed curvature of the spine. His early education was cared for by his father and by the local rabbi, David Fränkel. The latter, besides teaching him the Bible and Talmud, introduced to him the philosophy of Maimonides (*g.w.*). Fränkel received a call to Berlin in 1743. Not many months later a weakly lad knocked at one of the gates of Berlin. He was admitted after an altercation, and found a warm welcome at the hands of his former teacher. His life at this period was a struggle against crushing poverty, but his scholarly ambition was never relaxed. A refugee Pole, Zamosz, taught him mathematics, and a young Jewish physician was his tutor in Latin. He was, however, mainly self-taught. "He learned to spell and to philosophize at the same time" (Graetz). With his scanty earnings he bought a Latin copy of Locke's *Essay concerning the Human Understanding*, and mastered it with the aid of a Latin dictionary. He then made the acquaintance of Aaron Solomon Gumpertz, who taught him the elements of French and English. In 1750 he was appointed by a wealthy silk-merchant, Isaac Bernhard, as teacher to his children. Mendelssohn soon won the confidence of Bernhard, who made the young student successively his book-keeper and his partner.

Gumpertz or Hess rendered a conspicuous service to Mendelssohn and to the cause of enlightenment in 1754 by introducing him to Lessing. Just as the latter afterwards makes Nathan the Wise and Saladin meet over the chess-board, so did Lessing and Mendelssohn actually come together as lovers of the game. The Berlin of the day—the day of Frederick the Great—was in a moral and intellectual ferment. Lessing was the great liberator of the German mind. He had already begun his work of toleration, for he had recently produced a drama (*Die Juden*, 1749), the motive of which was to prove that a Jew can be possessed of nobility of character. This notion was being generally ridiculed as untrue, when Lessing found in Mendelssohn the realization of his dream. Within a few months of the same age, the two became brothers in intellectual and artistic camaraderie. Mendelssohn owed his first introduction to the public to Lessing's admiration. The former had written in lucid German an attack on the national neglect of native philosophers (principally Leibnitz), and lent the manuscript to Lessing. Without consulting the author, Lessing published anonymously Mendelssohn's *Philosophical Conversations (Philosophische Gespräche)* in 1755. In the same year there appeared in Danzig an anonymous satire, *Pope a Metaphysician (Pope ein Metaphysiker)*, the authorship of which soon transpired. It was the joint work of Lessing and Mendelssohn. From this time Mendelssohn's career was one of ever-increasing brilliance. He became (1756-1759) the leading spirit of Nicolai's important literary undertakings, the *Bibliothek* and the *Literaturbriefe*, and ran some risk (which Frederick's good nature obviated) by somewhat freely criticizing the poems of the king of Prussia. In 1762 he married. His wife was Fromet Gugenheim, who survived him by twenty-six years. In the year following his marriage Mendelssohn won the prize offered by the Berlin Academy for an essay on the application of mathematical proofs to metaphysics, although among the competitors were Abbt and Kant. In October 1763 the king granted Mendelssohn the privilege of Protected Jew (*Schutz-Jude*)—which assured his right to undisturbed residence in Berlin.

As a result of his correspondence with Abbt, Mendelssohn resolved to write on the Immortality of the Soul. Materialistic views were at the time rampant and fashionable, and faith in immortality was at a low ebb. At this favourable juncture appeared the *Phädon* (1767). Modelled on Plato's dialogue

of the same name, Mendelssohn's work possessed some of the charm of its Greek exemplar. What most impressed the German world was its beauty and lucidity of style—features to which Mendelssohn still owes his popularity as a writer. The *Phädon* was an immediate success, and besides being often reprinted in German was speedily translated into nearly all the European languages, including English. The author was hailed as the "German Plato," or the "German Socrates"; royal and other aristocratic friends showered attentions on him, and it is no exaggeration to assert with Kayserling that "no stranger who came to Berlin failed to pay his personal respects to the German Socrates."

So far, Mendelssohn had devoted his talents to philosophy and criticism; now, however, an incident turned the current of his life in the direction of the cause of Judaism. Lavater was one of the most ardent admirers of Mendelssohn. He described him as "a companionable, brilliant soul, with piercing eyes, the body of an Aesop—a man of keen insight, exquisite taste and wide erudition . . . frank and open-hearted." Lavater was fired with the ambition to convert his friend to Christianity. In the preface to a German translation of Bonnet's essay on Christian Evidences, Lavater publicly challenged Mendelssohn to refute Bonnet or if he could not then to "do what wisdom, the love of truth and honesty must bid him, what a Socrates would have done if he had read the book and found it unanswerable." This appeal produced a painful impression. Bonnet resented Lavater's action, but Mendelssohn was bound to reply, though opposed to religious controversy. As he put it: "Suppose there were living among my contemporaries a Confucius or a Solon, I could, according to the principles of my faith, love and admire the great man without falling into the ridiculous idea that I must convert a Solon or a Confucius."

Here we see the germs of Mendelssohn's Pragmatism, to use the now current term. He shared this with Lessing; in this case, at all events, it is probable that the latter was indebted to Mendelssohn. But before discussing this matter, we must follow out the consequences of Lavater's intrusion into Mendelssohn's affairs. The latter resolved to devote the rest of his life to the emancipation of the Jews. Among them secular studies had been neglected, and Mendelssohn saw that he could best remedy the defect by attacking it on the religious side. A great chapter in the history of culture is filled by the influence of translations of the Bible. Mendelssohn added a new section to this chapter by his German translation of the Pentateuch and other parts of the Bible. This work (1783) constituted Mendelssohn the Luther of the German Jews. From it, the Jews learned the German language; from it they imbibed culture; with it there was born a new desire for German nationality; as a result of its popularity was inaugurated a new system of Jewish education. Some of the conservatives among the Jews opposed these innovations, but the current of progress was too strong for them. Mendelssohn was the first great champion of Jewish emancipation in the 18th century. He it was who induced C. W. Dohm to publish in 1781 his epoch-making work, *On the Civil Amelioration of the Condition of the Jews*, a memorial which played a great part in the triumph of tolerance. Mendelssohn himself published a German translation of the *Vindiciae judaeorum* by Menasseh ben Israel. The excitement caused by these proceedings led Mendelssohn to publish his most important contribution to the problems connected with the position of Judaism in relation to the general life.

This work was the *Jerusalem* (1783; Eng. trans. 1838 and 1852). It is a forcible plea for freedom of conscience. Kant described it as "an irrefutable book." Its basic idea is that the state had no right to interfere with the religion of its citizens. As Kant put it, this was "the proclamation of a great reform, which, however, will be slow in manifestation and in progress, and which will affect not only your people but others as well." Mendelssohn asserted the pragmatic principle of the possible plurality of truths: that just as various nations need different constitutions—to one a monarchy, to

another a republic, may be the most congenial to the national genius—so individuals may need different religions. The test of religion is its effect on conduct. This is the moral of Lessing's *Nathan the Wise*, the hero of which is undoubtedly Mendelssohn. The parable of the three rings is the epitome of the pragmatic position. One direct result of this pragmatism was unexpected. Having been taught that there is no absolutely true religion, Mendelssohn's own descendants—a brilliant circle, of which the musician Felix was the most noted—left the Synagogue for the Church. But despite this, Mendelssohn's theory was found to be a strengthening bond in Judaism. For he maintained that Judaism was less a "divine need, than a revealed life." In the first part of the 19th century, the criticism of Jewish dogmas and traditions was associated with a firm adhesion to the older Jewish mode of living. Reason was applied to beliefs, the historic consciousness to life. Modern reform in Judaism is parting to some extent from this conception, but it still holds good even among the liberals.

Of Mendelssohn's remaining years it must suffice to say that he progressed in fame numbering among his friends more and more of the greatest men of the age. His *Morgenstunden* appeared in 1785, and he died as the result of a cold contracted while carrying to his publishers in 1786 the manuscript of a vindication of his friend Lessing, who had predeceased him by five years.

Mendelssohn had six children. His sons were: Joseph (founder of the Mendelssohn banking house, and a friend and benefactor of Alexander Humboldt), whose son Alexander (d. 1871) was the last Jewish descendant of the philosopher; Abraham (who married Leah Bartholdy and was the father of Fanny Hensel and J. L. Felix Mendelssohn-Bartholdy); and Nathan (a mechanical engineer of considerable repute). His daughters were Dorothea, Recha and Henriette, all brilliantly gifted women.

BIBLIOGRAPHY.—An edition of Mendelssohn's works was published in 1843-1845, with a biography by his son Joseph; another edition of his *Schriften zur Philosophie, Aesthetik und Aepologetik*, appeared (ed. Brach) in 2 vols. in 1880. For Mendelssohn's biography the chief sources are Graetz, *History of the Jews*, vol. v., and Kayserling's *Mendelssohn's Leben und Wirken* (1887). Much interesting material on the Mendelssohn family is given in Hensel's *Die Familie Mendelssohn* (translated into English, 1881). Much general comment on Moses Mendelssohn appeared in the press of the world on occasion of the centenary of the birth of the composer Mendelssohn in 1909. (I. A.)

MENDELSSOHN-BARTHOLDY, JAKOB LUDWIG FELIX (1809-1847), German composer, grandson of Moses Mendelssohn (q.v.), was born in Hamburg on the 3rd of February 1809. In consequence of the troubles caused by the French occupation of Hamburg, Abraham Mendelssohn, his father, migrated in 1811 to Berlin, where his grandmother Fromet, then in the twenty-fifth year of her widowhood, received the whole family into her house, No. 7 Neue Promenade. Here Felix and his sister Fanny received their first instruction in music from their mother, under whose care they progressed so rapidly that their exceptional talent soon became apparent. Their next teacher was Madame Bigot, who, during the temporary residence of the family in Paris in 1816, gave them valuable instruction. On their return to Berlin they took lessons in thoroughbass and composition from Zelter, in pianoforte-playing from Ludwig Berger, and in violin-playing from Henning—the care of their general education being entrusted to the father of the novelist Paul Heyse.

Felix first played in public on the 24th of October 1818, taking the pianoforte part in a trio by Woelfl. On the 11th of April 1819 he entered the Berlin Singakademie as an alto, and in the following year began to compose with extraordinary rapidity. His earliest dated work is a cantata, *In rührend feierlichen Tönen*, completed on the 13th of January 1820. During that year alone he produced nearly sixty movements, including songs, pianoforte sonatas, a trio for pianoforte, violin and violoncello, a sonata for violin and pianoforte, pieces for the organ, and even a little dramatic piece in three scenes. In 1821 he wrote five symphonies for stringed instruments, each in three movements; motets for four voices, an

opera, in one act, called *Soldatenliebschaft*; another, called *Die beiden Pädagogen*; part of a third, called *Die wandernden Comödianten*; and an immense quantity of other music of different kinds, all showing the precocity of his genius. The original autograph copies of these early productions are preserved in the Berlin Library, where they form part of a collection which fills forty-four large volumes, all written with infinite neatness, and for the most part carefully dated—a sufficient proof that the methodical habits which distinguished his later life were formed in early childhood.

In 1821 Mendelssohn paid his first visit to Goethe, with whom he spent sixteen days at Weimar, in company with Zelter. From this year also dates his first acquaintance with Weber, who was then in Berlin superintending the production of *Der Freischütz*; and from the summer of 1822 his introduction, at Cassel, to another of the greatest of his contemporaries, Ludwig Spohr. During this year his pen was even more prolific, producing, among other works, an opera, in three acts, entitled *Die beiden Neffen, oder der Onkel aus Boston*, and a pianoforte concerto, which he played in public at a concert given by Frau Anna Milder.

It had long been a custom with the Mendelssohn family to give musical performances on alternate Sunday mornings in their dining-room, with a small orchestra, which Felix always conducted, even when he was not tall enough to be seen without standing upon a stool. For each of these occasions he produced some new work—playing the pianoforte pieces himself, or entrusting them to Fanny, while his sister Rebecca sang, and his brother Paul played the violoncello. In this way *Die beiden Neffen* was first privately performed, on the fifteenth anniversary of his birthday, the 3rd of February 1824. Between the 3rd and the 31st of March in this year he composed his fine symphony in C minor, now known as Op. 10, and soon afterwards the quartet in B minor, Op. 3, and the (posthumous) pianoforte sextet, Op. 110. In this year also began his lifelong friendship with Moscheles, who, when asked to receive him as a pupil, said, "If he wishes to take a hint from me, as to anything new to him, he can easily do so; but he stands in no need of lessons."

In 1825 Abraham Mendelssohn took Felix to Paris, where among other musicians then resident in the French capital he met the two most popular dramatic composers of the age, Rossini and Meyerbeer, and lived on terms of intimacy with Hummel, Kalkbrenner, Rode, Baillot, Herz, and many other artists of European celebrity. On this occasion also he made his first acquaintance with Cherubini, who, though he rarely praised any one, expressed a high opinion of his talent, and recommended him to write a *Kyrie*, for five voices, with full orchestral accompaniments, which he himself described as "exceeding in thickness" anything he had attempted. From letters written at this period we learn that Felix's estimate of the French school of music was far from flattering; but he formed some friendships in Paris, which were renewed on later occasions. He returned to Berlin with his father in May 1825, taking leave of his Parisian friends on the 19th of the month, and interrupting his journey at Weimar for the purpose of paying a second visit to Goethe, to whom he dedicated his quartet in B minor. On reaching home he must have worked with greater zeal than ever; for on the 10th of August in this same year he completed an opera, in two acts, called *Die Hochzeit des Camacho*, a work of considerable importance.

No ordinary boy could have escaped uninjured from the snares attendant upon such a life as that which Mendelssohn now lived. Notwithstanding his overwhelming passion for music, his general education had been so well cared for that he was able to hold his own, in the society of his seniors, with the grace of an accomplished man of the world. He was already recognized as a leading spirit by the artists with whom he associated, and these artists were men of acknowledged talent and position. The temptations to egoism by which he was surrounded would have rendered most clever students intolerable. But the natural amiability of his disposition, and the

healthy influence of his happy home-life, counteracted all tendencies towards self-assertion.

Soon after his return from Paris, Abraham Mendelssohn removed from his mother's residence to No. 3 Leipziger Strasse, a roomy, old-fashioned house, containing an excellent music-room, and in the grounds adjoining a "Gartenhaus" capable of accommodating several hundred persons at the Sunday performances.¹ In the autumn of the following year this "garden-house" witnessed a memorable private performance of the work by means of which the greatness of Mendelssohn's genius was first revealed to the outer world—the overture to Shakespeare's *Midsummer Night's Dream*. The finished score of this famous composition is dated "Berlin, August 6, 1826"—its author was only seventeen and a half years old. Yet in no later work does he exhibit more originality of thought, more freshness of conception, or more perfect mastery over the details of technical construction, than in this delightful inspiration. The overture was first publicly performed at Stettin, in February 1827, under the direction of the young composer, who was at once accepted as the leader of a new and highly characteristic manifestation of the spirit of progress. Henceforth we must speak of him, not as a student, but as a mature and experienced artist.

Meanwhile *Camacho's Wedding* had been submitted to Spontini, with a view to its production at the opera. The libretto, founded upon an episode in the history of Don Quixote, was written by Klingemann, and Mendelssohn threw himself into the spirit of the romance with a keen perception of its peculiar humour. The work was put into rehearsal soon after the composer's return from Stettin, produced on the 29th of April 1827, and received with great apparent enthusiasm; but a cabal was formed against it, and it never reached a second performance. The critics abused it mercilessly; yet it exhibits merits of a very high order. The solemn passage for the trombones, which heralds the first appearance of the knight of La Mancha, is conceived in a spirit of reverent appreciation of the idea of Cervantes, which would have done honour to a composer of lifelong experience.

Mendelssohn was annoyed at this injustice, and some time elapsed before his mind recovered its usual bright tone; but he continued to work diligently. Among other serious undertakings, he formed a choir for the study of the choral works of Sebastian Bach, then unknown to the public; and, in spite of Zelter's opposition, he succeeded, in 1829, in inducing the Berlin Singakademie to give a public performance of the *Passion according to St Matthew*, under his direction, with a chorus of between three and four hundred voices. The scheme succeeded beyond his warmest hopes, and proved the means of restoring to the world great compositions which had never been heard since the death of Bach. But the obstructive party were offended; and at this period Mendelssohn was far from popular among the musicians of Berlin.

In April 1829 Mendelssohn paid his first visit to London. His reception was enthusiastic. He made his first appearance before an English audience at one of the Philharmonic Society's concerts—then held in the Argyll Rooms—on the 25th of May, conducting his symphony in C minor from the pianoforte, to which he was led by John Cramer. On the 30th he played Weber's *Concertstück*, from memory, a proceeding at that time extremely unusual. At a concert given by Drouet, on the 24th of June, he played Beethoven's pianoforte concerto in E flat, which had never before been heard in the country; and the overture to *A Midsummer Night's Dream* was also, for the first time, presented to a London audience. On returning home from the concert, Attwood, then organist of St Paul's Cathedral, left the score of the overture in a hackney coach, whereupon Mendelssohn wrote out another, from memory, without an error. At another concert he played, with Moscheles, his still unpublished concerto in E, for two pianofortes and

¹ After Mendelssohn's death this house was sold to the Prussian government; and the "Herrenhaus" now stands on the site of the garden-house.

orchestra. After the close of the London season he started with Klingemann on a tour through Scotland, where he was inspired with the first idea of his overture to *The Isles of Fingal*, returning to Berlin at the end of November. Except for an accident to his knee, which lamed him for some time, his visit was highly successful and laid the foundation of many friendships and prosperous negotiations.

The visit to England formed the first division of a great scheme of travel which his father wished him to extend to all the most important art centres in Europe. After refusing the offer of a professorship at Berlin, he started again, in May 1830, for Italy, pausing on his way at Weimar, where he spent a fortnight with Goethe, and reaching Rome, after many pleasant interruptions, on the 1st of November. No excitement prevented him from devoting a certain time every day to composition; but he lost no opportunity of studying either the countless treasures which form the chief glory of the great city or the manners and customs of modern Romans. He attended, with insatiable curiosity, the services in the Sistine Chapel; and his keen power of observation enabled him to throw much interesting light upon them. His letters on this subject, however, lose much of their value through his incapacity to comprehend the close relation existing between the music of Palestrina and his contemporaries and the ritual of the Roman Church. His Lutheran education kept him in ignorance even of the first principles of ordinary chanting; and it is amusing to find him describing as enormities peculiar to the papal choir customs familiar to every village singer in England, and as closely connected with the structure of the "Anglican chant" as with that of "Gregorian music." Still, though he could not agree in all points with Baini, the greatest ecclesiastical musician then living, he shared his admiration for the *Improperia*, the *Miserere*, and the *cantus planus* of the *Lamentations* and the *Exultet*, the musical beauty of which he could understand, apart from their ritual significance.

In passing through Munich on his return in October 1831 he composed and played his pianoforte concerto in G minor, and accepted a commission (never fulfilled) to compose an opera for the Munich theatre. Pausing for a time at Stuttgart, Frankfurt and Düsseldorf he arrived in Paris in December, and passed four pleasant months in the renewal of acquaintances formed in 1825, and in close intercourse with Liszt and Chopin. On the 10th of February 1832 the overture to *A Midsummer Night's Dream* was played at the conservatoire, and many of his other compositions were brought before the public; but he did not escape disappointments with regard to some of them, especially the Reformation symphony, and the visit was brought to a premature close in March by an attack of cholera, from which, however, he rapidly recovered.

On the 23rd of April 1832 he was again in London, where he twice played his G minor concerto at the Philharmonic concerts, gave a performance on the organ at St Paul's, and published his first book of *Lieder ohne Worte*. He returned to Berlin in July, and during the winter he gave public performances of his Reformation symphony, his concerto in G minor, and his *Walpurgisnacht*. In the following spring he paid a third visit to London for the purpose of conducting his Italian symphony, which was played for the first time, by the Philharmonic Society, on the 13th of May 1833. On the 26th of the same month he conducted the performances at the Lower Rhine festival at Düsseldorf with such brilliant effect that he was at once offered, and accepted, the appointment of general-music-director to the town, an office which included the management of the music in the principal churches, at the theatre, and at the rooms of two musical associations.

Before entering upon his new duties, Mendelssohn paid a fourth visit to London, with his father, returning to Düsseldorf on the 27th of September 1833. His influence produced an excellent effect upon the church music and in the concert-room; but his relations with the management of the theatre were not altogether pleasant; and it was probably this circumstance which first led him to forsake the cultivation of the opera for

that of sacred music. At Düsseldorf he first designed his famous oratorio *St Paul*, in response to an application from the Cäcilien-Verein at Frankfurt, composed his overture to *Die schöne Melusine*, and planned some other works of importance. He liked his appointment, and would probably have retained it much longer had he not been invited to undertake the permanent direction of the Gewandhaus concerts at Leipzig, and thus raised to the highest position attainable in the German musical world. To this new sphere of labour he removed in August 1835, opening the first concert at the Gewandhaus, on the 4th of October, with his overture *Die Meeresstille*, a work possessing great attractions, though by no means on a level with the *Midsummer Night's Dream*, *The Isles of Fingal*, or *Melusine*.

Mendelssohn's reception in Leipzig was most enthusiastic; and under his new director the Gewandhaus concerts prospered exceedingly. Meanwhile *St Paul* steadily progressed, and was first produced, with triumphant success, at the Lower Rhine festival at Düsseldorf, on the 22nd of May 1836. On the 3rd of October it was first sung in English, at Liverpool, under the direction of Sir George Smart; and on the 16th of March 1837 Mendelssohn again directed it at Leipzig.

The next great event in Mendelssohn's life was his happy marriage, on the 28th of March 1837, to Cecile Charlotte Sophie Jeanrenaud. The honeymoon was scarcely over before he was again summoned to England to conduct *St Paul*, at the Birmingham festival, on the 20th of September. During this visit he played on the organ at St Paul's and at Christ Church, Newgate Street, with an effect which exercised a lasting influence upon English organists. It was here also that he first contemplated the production of his second oratorio, *Elijah*.

Passing over the composition of the *Lobgesang* in 1840, a sixth visit to England in the same year, and his inauguration of a scheme for the erection of a monument to Sebastian Bach, we find Mendelssohn in 1841 recalled to Berlin by the king of Prussia, with the title of Kapellmeister. Though his appointment resulted in the production of *Antigone*, *Oedipus Coloneus*, *Athalie*, the incidental music to the *Midsummer Night's Dream*, and other great works, it proved an endless source of vexation, and certainly helped to shorten the composer's life. In 1842 he came to England for the seventh time, accompanied by his wife, conducted his Scotch symphony at the Philharmonic, again played the organ at St Peter's, Cornhill, and Christ Church, Newgate Street, and was received with honour by the queen and the prince consort. He did not, however, permit his new engagements to interfere with the direction of the Gewandhaus concerts; and in 1843 he founded in Leipzig the great conservatoire which soon became the best musical college in Europe, opening it on the 3rd of April in the buildings of the Gewandhaus. In 1844 he conducted six of the Philharmonic concerts in London, producing his new *Midsummer Night's Dream* music, and playing Beethoven's pianoforte concerto in G with extraordinary effect. He returned to his duties at Berlin in September, but succeeded in persuading the king to free him from his most onerous engagements.

After a brief residence in Franfort, Mendelssohn returned to Leipzig in September 1845, resuming his old duties at the Gewandhaus, and teaching regularly in the conservatoire. Here he remained, with little interruption, during the winter—introducing his friend Jenny Lind, then at the height of her popularity, to the critical frequenters of the Gewandhaus, and steadily working at *Elijah*, the first performance of which he conducted at the Birmingham festival, on the 26th of August 1846. The reception of this great work was enthusiastic. Unhappily, the excitement attendant upon its production, added to the irritating effect of the worries at Berlin, made a serious inroad upon the composer's health. On his return to Leipzig he worked on as usual, but it was clear that his health was seriously impaired. In 1847 he visited England for the tenth and last time, to conduct four performances of *Elijah* at Exeter Hall, on the 16th, 23rd, 28th and 30th of April, one at Manchester on the 20th, and one at Birmingham on the 27th.

But the exertion was beyond his strength. He witnessed Jenny Lind's first appearance at Her Majesty's Theatre, on the 4th of May, and left England on the 9th, little anticipating the trial that awaited him in the tidings of the sudden death of his sister Fanny, which reached him only a few days after his arrival in Frankfurt. The loss of his mother in 1842 had shaken him much, but the suddenness with which this last intelligence was communicated broke him down. He fell to the ground insensible, and never fully recovered. In June he was so far himself again that he was able to travel, with his family, by short stages, to Interlaken, where he stayed for some time, illustrating the journey by a series of water-colour drawings, but making no attempt at composition for many weeks. He returned to Leipzig in September, bringing with him fragments of *Christus*, *Loreley*, and some other unfinished works, taking no part in the concerts, and living in privacy. On the 9th of October he called on Madame Frege, and asked her to sing his latest set of songs. She left the room for lights, and on her return found him in violent pain and almost insensible. He lingered for four weeks, and on the 4th of November he passed away, in the presence of his wife, his brother, and his three friends, Moscheles, Schleinitz, and Ferdinand David. A cross marks the site of his grave, in the Alte Dreifaltigkeits Kirchhof, at Berlin.

Mendelssohn's title to a place among the great composers of the century is incontestable. His style, though differing little in technical arrangement from that of his classical predecessors, is characterized by a vein of melody peculiarly his own, and easily distinguishable by those who have studied his works, not only from the genuine effusions of contemporary writers, but from the most successful of the servile imitations with which, even during his lifetime, the music-shops were deluged. In less judicious hands the rigid symmetry of his phrasing might, perhaps, have palled upon the ear; but under his skillful management it serves only to impart an additional charm to thoughts which derive their chief beauty from the evident spontaneity of their conception. In this, as in all other matters of a purely technical character, he regarded the accepted laws of art as the medium by which he might most certainly attain the ends dictated by the inspiration of his genius. Though caring nothing for rules, except as means for producing a good effect, he scarcely ever violated them, and was never weary of impressing their value upon the minds of his pupils. His method of counterpoint was modelled in close accordance with that practised by Sebastian Bach. This he used in combination with an elastic development of the sonata-form, similar to that engrafted by Beethoven upon the lines laid down by Haydn. The principles involved in this arrangement were strictly conservative; yet they enabled him, at the very outset of his career, to invent a new style no less original than that of Schubert or Weber, and no less remarkable as the embodiment of canons already consecrated by classical authority than as a special manifestation of individual genius. It is thus that Mendelssohn stands before us as at the same time a champion of conservatism and an apostle of progress; and it is chiefly by virtue of these two apparently incongruous though really compatible phases of his artistic character that his influence and example availed, for so many years, to hold in check the violence of reactionary opinion which injudicious partisanship afterwards fanned into revolutionary fury.

Concerning Mendelssohn's private character there have never been two opinions. As a man of the world he was more than ordinarily accomplished—brilliant in conversation, and in his lighter moments overflowing with sparkling humour and ready pleasantry, loyal and unselfish in the more serious business of life, and never weary of working for the general good. As a friend he was unvaryingly kind, sympathetic and true. His earnestness as a Christian needs no stronger testimony than that afforded by his own delineation of the character of St Paul; but it is not too much to say that his heart and life were pure as those of a little child. (W. S. R.)

This article has the unique value of being the record of an eminent musical scholar who was an actual pupil of Mendelssohn. No change of reputation can alter the value of such a record of a man whom even his contemporaries knew to be greater than his works. Mendelssohn's aristocratic horror of self-advertisement unfitted him for triumph in a period of revolution; he died, most inopportunistically, when his own powers, like Handel's at the same age, were being wasted on pseudo-classical forms; the new art was not yet ripe; and in the early Wagner-Liszt reign of terror his was the first reputation to be assassinated. That of the too modest and gentle "Romantic" pioneer Schumann soon followed; but, as being more difficult to explain away, and more embarrassing to irreverence and conceit, it remains a subject of controversy. Meanwhile Mendelssohn's reputation, except as the composer of a few inexplicably beautiful and original orchestral pieces, has vanished and been replaced by a pure fiction known as the "Mendelssohn tradition" of orchestral conducting. This fiction is traceable to the characteristic remarks made by Wagner on his experiences of English orchestral playing, remarks which, though not very good-natured, do not bear the full construction popularly imputed to them. If Beethoven had come and conducted in England, Mendelssohn's expostulations with careless players would have been met by references to the "Beethoven tradition"; and, if Wagner had shared Mendelssohn's reluctance to putting on record remarks likely to wound individual, professional and national sensibilities, it might not have been impossible that reproaches against slipshod and mechanical playing might have been met by references to the "Wagner tradition." For Wagner also found himself compelled to concentrate his care on the main items in the overloaded English orchestral programmes, to the detriment of the rest.

Mendelssohn's influence on the early career of Joachim is, next to his work in the rediscovery of Bach, his greatest bequest to later musical history. Those many profound and sincere admirers to Joachim to whom the name of Mendelssohn calls up only the Widow in *Elijah* and the weaker *Songs without Words*, may find the idea strange; but there is no doubt that Joachim regarded the composer as the true Mendelssohn tradition as identical with his own efforts to "uphold the dignity of art." (D. F. T.)

MENDES, CATULLE (1841-1909), French poet and man of letters, of Jewish extraction, was born at Bordeaux on the 22nd of May 1841. He early established himself in Paris, attaining speedy notoriety by the publication in the *Revue fantaisiste* (1861) of his "Roman d'une nuit," for which he was condemned to a month's imprisonment and a fine of 500 francs. He was allied with the Prarnassians from the beginning of the movement, and displayed extraordinary metrical skill in his first volume of poems, *Philomèle* (1863). In later volumes—*Poésies, I^{re} série* (1876), which includes much of his earlier verse, "*Soirs moroses*," *Contes épiques, Philomèle*, &c.; *Poésies* (7 vols., 1885), a new edition largely augmented; *Les Poésies de Catulle Mendès* (3 vols., 1893); *La Grive des vignes* (1895), &c.—his critics have noted that the elegant verse is distinguished rather by dexterous imitation of different writers than by any marked originality. The versatility and fecundity of Mendès's talent is shown in a series of his critical and dramatic writings, and of novels and short stories, in the latter of which he continues the French tradition of the licentious *conte*. For the theatre he wrote: *La Part du roi* (1872), a one-act verse comedy; *His Frères d'armes* (1873), drama; *Justice* (1877), in three acts, characterized by a hostile critic as a hymn in praise of suicide; the libretto of a light opera, *Le Capitaine Fracasse* (1878), founded on Théophile Gautier's novel; *La Femme de Tabarin* (1887); *Mède* (1898), in three acts and in verse; *La Reine Fiammette* (1898), a *conte dramatique* in six acts and in verse, the scene of which is laid in the Italy of the Renaissance; *Le Fils de l'Étoile* (1904), the hero of which is Bar-Cochebas, the Syrian pseudo-Messiah, for the music of C. Erlanger; *Scarron* (1905); *Ariane* (1906), for the music of Massenet; and *Glattigny* (1906). His critical work includes: *Richard Wagner* (1886); *L'Art au théâtre* (3 vols., 1896-1900), a series of dramatic criticisms reprinted from newspapers; and a report addressed to the minister of public instruction and of the fine arts on *Le Mouvement poétique français de 1867 à 1900* (new ed., 1903), which includes a bibliographical and critical dictionary of the French poets of the 19th century. Perhaps the most famous of his novels are: *Le Roi vierge* (1880) in which he introduces Louis II. of Bavaria and Richard Wagner; *La Maison de la vielle* (1894), and *Gog* (1897). He married in 1866 Mlle Judith Gautier, younger daughter of the poet, from whom he was subsequently separated.

On the 9th of February 1009, early in the morning, his dead body was discovered in the railway tunnel of Saint Germain. He had left Paris by the midnight train on the 7th, and it is supposed that, thinking he had arrived at the station, he had opened the door of his compartment while still in the tunnel.

MENDICANCY (from Lat. *mendicus*, in a condition of beggary, a word of unknown origin), a state or condition of being a beggar, the practice of obtaining a livelihood by asking alms. The word "mendicant," also found in the French form "mendiant," appears to have come into use through the begging friars.

MENDICANT MOVEMENT AND ORDERS. The facts concerning the rise of the Orders of Mendicant Friars are related in the articles on the several orders (FRANCISCANS, DOMINICANS, CARMELITES, AUGUSTINIAN HERMITS, and in that on MONASTICISM (§ 11), where the difference between friars and monks is explained. The purpose of this article is to characterize the movement as a whole, and to indicate the circumstances that produced it. The most striking phenomenon in connexion with the beginnings of the mendicant orders is the rapidity with which the movement spread. Within a generation of the death of the two great founders, Dominic (1221) and Francis (1226), their institutes had spread all over Europe and into Asia, and their friars could be numbered by tens of thousands. In all the great cities of Western Europe friaries were established, and in the universities theological chairs were held by Dominicans and Franciscans. And when at the middle of the century the other great mendicant orders of Carmelites and Austin Friars, and also Servites (*q.v.*) arose their propagation showed that the possibilities of the mendicant movement had not been exhausted by the Dominicans and Franciscans. Lesser mendicant orders sprang up in all directions—Gasquet mentions half a dozen such that found their way into England (*English Monastic Life*, p. 241)—in such numbers that the Council of Lyons in 1274 found it necessary to suppress all except the orders already named. Moreover, besides the various orders of friars, there were the lay Tertiaries that arose and spread far and wide in connexion with the Franciscans and other mendicants, and the similar institute of the Humiliati (see TERTIARIES). These facts clearly show that the Mendicant Movement responded to widely spread and deeply felt needs of the time. These needs found expression not only in the Mendicant orders within the Church, but also in a number of more or less heretical and revolutionary religious sects. There was this in common among the Cathari, Waldenses, Albigenses and other heretical bodies that overran so many parts of Western Europe in the second half of the 12th century and the beginning of the 13th, that they all inveighed against the wealth of the clergy, and preached the practice of austere poverty and a return to the simple life of Christ and the Apostles. Thus the sectaries no less than the Mendicant orders bear witness to the existence of spiritual needs in Western Christendom, which the Mendicant orders went a long way towards satisfying. Probably the most crying need was that of priests to minister to the great city populations, at that time growing up with such rapidity, especially in Italy. During the 10th, 11th and 12th centuries the Church had been organized on the lines of the prevailing feudal system—the bishops and abbots were feudal barons, and the effects of the system were felt throughout the ranks of the lower clergy. The social fabric was built up not on the towns, but on the great landlords; and when the centre of gravity began to move, first of all in Italy, to the towns, and crowded populations began to be massed together in them, the parochial systems broke down under the weight of the new conditions, and the people were in a state of spiritual and moral no less than physical destitution. So, when the friars came and established themselves in the poorest localities of the towns, and brought religion to the destitute and the outcasts of society, assimilating themselves to the conditions of life of those among whom they worked, they supplied a need with which the parochial clergy were unable to cope.

The friars responded not only to the new needs of the age, but to its new ideas—religious, intellectual, social, artistic.

It was a period of religious revival, and of reaction against abuses that followed in the wake of the feudal system; and this religious movement was informed by a new mysticism—a mysticism that fixed its attention mainly on the humanity of Christ and found its practical expression in the imitation of His life. A new intellectual wave was breaking over Western Europe, symbolized by the university and the scholastic movements; and a new spirit of democratic freedom was making itself felt in the growing commercial towns of Italy and Germany. There is no need to labour the point that the Mendicants responded to all these needs and interpreted them within the pale of Catholic Christianity, for the fact lies upon the surface of history. But a few words are necessary on the central idea from which the Mendicants received their name—the idea of poverty. This was St Francis's root idea, and there is no doubt—though it has been disputed—that it was borrowed from him by St Dominic and the other Mendicant founders. St Francis did not intend that begging and alms should be the normal means of sustenance for his friars; on the contrary, he intended them to live by the work of their hands, and only to have recourse to begging when they could not earn their livelihood by work. But as the friars soon came nearly all to be priests devoted to spiritual ministrations, and the communities grew larger, it became increasingly difficult for them to support themselves by personal work; and so the begging came to play a greater rôle than had been contemplated by St Francis. But his idea certainly was that his friars should not only practise the utmost personal poverty and simplicity in their life, but that they should have the minimum of possessions—no lands, no funded property, no fixed sources of income. The maintaining of this ideal has proved unworkable in practice. In the Dominican Order and the others that started as mendicant it has been mitigated or even abrogated. Among the Franciscans themselves it has been the occasion of endless strife, and has been kept alive only by dint of successive reforms and fresh starts, each successful for a time, but doomed always, sooner or later, to yield to the inexorable logic of facts. The Capuchins (*q.v.*) have made the most permanently successful effort to maintain St Francis's ideal; but even among them mitigations have had to be admitted. In spite, however, of all mitigations the Franciscans have nearly always presented to the world an object lesson in evangelical poverty by the poorness and simplicity of their lives and surroundings.

On the subject-matter of this article the best thing in English is the Introductory Essay by the Capuchin Fr. Cuthbert on "The Spirit and Genius of the Franciscan Friars," in *The Friars and how they came to England* (1903); see also the earlier chapters of Emil Gebhard's *Italie mystique* (1899). (E. C. B.)

MENDIP HILLS, a range in the north of Somersetshire, England. Using the name in its widest application, the eastern boundary of the range may be taken to be formed by the upper valleys of the rivers Frome and Brue, and the depression between them. The range extends from these north-westward with a major axis of about 23 m., while the outliers of Wavering Down and Bleadon Hill continue it towards the shore of the Bristol Channel. The range is generally about 6 m. in width, and its total area about 130 sq. m. Its south-western face descends to the low "moors" or marshes drained by the Axe and other streams, the small towns of Axbridge, Cheddar and Wells lying at the foot of the hills. Towards the north-east its limits are less clearly defined, for high ground, intersected by narrow valleys, extends as far as the valley of the Avon. A depression, followed by the road between Radstock and Wells, strikes across the range about its centre; the principal elevations lie west of this, and to the area thus defined the name of the Mendips is sometimes restricted. The summit of the hills is a gently swelling plateau, which reaches its extreme height in the north—1068 ft. The Mendips consist principally of Carboniferous Limestone. Fine cliffs and scars occur on the flanks of the plateau, as in the gorges of Cheddar, and there is a wonderful series of caverns, the result of water action. The surface of the plateau is often broken by deep holes

("swallets") into which streams flow. Some of the caves, such as those at Cheddar, are easy of access, and attract many visitors owing to the beauty of the stalactitic formations; others, of greater extent and grandeur, have only been explored, or partly explored, with great difficulty. Some caves have yielded large quantities of animal remains (hyaenas, bears and others) together with traces of prehistoric human occupation. Among such Wookey Hole, where the river Axe issues from the foot of a cliff, may be mentioned. Lead was worked among the Mendips at a very early period. Some of the Roman workings, especially in the neighbourhood of Charterhouse-on-Mendip, have yielded pigs of lead inscribed with the names of emperors of the 1st and 2nd centuries A.D., together with an abundance of smaller objects.

See E. Baker and H. Balch, *The Netherworld of Mendip* (Clifton, 1907).

MENDOZA, ANTONIO HURTADO DE (1503?–1644), Spanish dramatist, was born about the end of the 16th century in the province of Asturias, became page to the count de Saldaña (son of the duke de Lerma), and was recognized as a rising poet by Cervantes in the *Viaje del Parnaso* (1614). He rose rapidly into favour under Philip IV., who appointed him private secretary, commissioned from him *comedias palaciegas* for the royal theatre at Aranjuez, and in 1623 conferred on him the orders of Santiago and Calatrava. Most of his contemporaries and rivals paid court to "el discreto de palacio," and Mendoza seems to have lived on the friendliest terms with all his brother-dramatists except Ruiz de Alarcón. He is said to have been involved in the fall of Olivares, and died unexpectedly at Saragossa on the 10th of September 1644. Only one of his plays, *Querer por sólo querer*, was published with his consent; it is included in a volume (1623) containing his semi-official account of the performances at Aranjuez in 1622. The best edition of Mendoza's plays and verses bears the title of *Obras líricas y cómicas, divinas y humanas* (1728). Much of his work does not rise above the level of graceful and accomplished verse; but that he had higher qualities is shown by *El Marido hace mujer*, a brilliant comedy of manners, which forms the chief source of Molière's *École des maris*.

The *Fiesta que se hizo en Aranjuez y Querer por sólo querer* were translated into English by Sir Richard Fanshawe, afterwards ambassador at Madrid, in a posthumous volume published in 1671.

MENDOZA, DIEGO HURTADO DE (1503–1575), Spanish novelist, poet, diplomatist and historian, a younger son of the count of Tendillas, governor of Granada, was born in that city in 1503. The celebrated marquis of Santillana was his great-grandfather. On leaving the university of Salamanca, Mendoza abandoned his intention of taking orders, served under Charles V. in Italy, and attended lectures at the universities of Bologna, Padua and Rome. In 1537 he was sent to England to arrange a marriage between Henry VIII. and the duchess of Milan, as well as a marriage between Prince Louis of Portugal and Mary Tudor. Despite the failure of his mission, he preserved the confidence of the emperor, and in 1539 was appointed ambassador at Venice; there he patronized the Aldi, procured copies of the Greek manuscripts belonging to Cardinal Bessarion, and acquired other rare codices from the monastery of Mount Athos. The first edition of Josephus was printed (1544) from the texts in Mendoza's collection. He acted for some time as military governor of Siena, represented Spain diplomatically at the council of Trent, and in 1547 was nominated special plenipotentiary at Rome, where he remained till 1554. He was never a favourite with Philip II., and a quarrel with a courtier resulted in his banishment from court (June 1568). The remaining years of his life, which were spent at Granada, he devoted to the study of Arabic, to poetry, and to his history of the Moorish insurrection of 1568–1570. He died in 1575. His *Guerra de Granada* was published at Lisbon by Luis Tribaldos de Toledo in 1627; the delay was doubtless due to Mendoza's severe criticism of contemporaries who survived him. In some passages the author deliberately imitates Sallust and Tacitus; his style is, on the whole, vivid and trenchant,

his information is exact, and in critical insight he is not inferior to Mariana. The attribution to Mendoza of *Lasarillo de Tormes* is rejected by all competent scholars, but that he excelled in picaresque malice is proved by his indecorous verses written in the old Castilian metres and in the more elaborate measures imported from Italy. Mendoza is believed to be the author of the letters to Feliciano de Silva and to Captain Salazar, published by Antonio Paz y Melia in *Saya Españolas* (Madrid, 1900).

See A. Senán y Alonso, *D. Diego Hurtado de Mendoza, apuntes biográfico-críticos* (Granada, 1886); *Calendar of Letters and Papers foreign and domestic, Henry VIII.*, vols. xii. and xiii.; C. Graux, *Essai sur l'origine du fonds grec de l'Escorial* (Paris, 1880); R. Fouché-Delbosq, "Étude sur la Guerra de Granada" in the *Revue hispanique* (Paris, 1894), vol. I.

MENDOZA, PEDRO GONZALEZ DE (1428–1495), Spanish cardinal and statesman, was the fourth son of Íñigo Lopez de Mendoza, marqués de Santillana, and duke of Infantado. He was born at Guadalajara in New Castile, the chief lordship of his family, on the 3rd of May 1428. The house of Mendoza claimed to descend from the lords of Llodio in Alava, and to have been settled in Old Castile, in the 11th century. One chief of the house had been greatly distinguished at the battle of the Navas de Tolosa in 1212. Another had been Admiral of Castile in the reign of Alphonso the Wise. Peter the Cruel had endowed them with the lordships of Hita and Buitrago. The greatness of the Mendozas was completed by Pedro Gonzalez, who sacrificed his life to save King John I. at the battle of Aljubarrota in 1385. The cardinal's father, the marquis of Santillana—to use the title he bore for the greater part of his life—was a poet, and was conspicuous during the troubled reign of John II. Loyalty to the Crown was the traditional and prevailing policy of the family. Pedro Gonzalez, the future cardinal, was sent into the Church mainly because he was a younger son and that he might be handsomely provided for. He had no vocation, and was an example of the worldly, political and martial prelates of the 15th century. In 1452 at the age of twenty-four, he was chosen by the king John II. to be bishop of Calahorra, but did not receive the pope's bull till 1454. As bishop of Calahorra he was also *señor*, or civil and military ruler, of the town and its dependent district. In his secular capacity he led the levies of Calahorra in the civil wars of the reign of Henry IV. He fought for the king at the second battle of Olmedo on the 20th of August 1467, and was wounded in the arm. During these years he became attached to Doña Mencía de Lemus, a Portuguese lady-in-waiting of the queen. She bore him two sons, Rodrigo, who was once selected to be the husband of Lucrezia Borgia, and Diego, who was the grandfather of the princess of Eboli of the reign of Philip II (see PEREZ, ANTONIO.) By another lady of a Valladolid family he had a third son who afterwards emigrated to France. In 1468 he became bishop of Sigüenza. In 1473 he was created cardinal, was promoted to the archbishopric of Seville and named chancellor of Castile. During the last years of the reign of King Henry IV. he was the partisan of the Princess Isabella, afterwards queen. He fought for her at the battle of Toro on the 1st of March 1476; had a prominent part in placing her on the throne; and served her indefatigably in her efforts to suppress the disorderly nobles of Castile. In 1482 he became archbishop of Toledo. During the conquest of Granada he contributed largely to the maintenance of the army. On the 2nd of January 1492 he occupied the town in the name of the Catholic sovereigns. Though his life was worldly, and though he was more soldier and statesman than priest, the "Great Cardinal," as he was commonly called, did not neglect his duty as a bishop. He used his influence with the queen and also at Rome to arrange a settlement of the disputes between the Spanish sovereigns and the papacy. Though he maintained a splendid household as archbishop of Toledo, and provided handsomely for his children, he devoted part of his revenue to charity, and with part he endowed the college of Santa Cruz at Valladolid. His health broke down at the close of 1493. Queen Isabella visited and nursed him on his deathbed. It is said that he recommended her to choose as his successor the Franciscan Jimenez de Cisneros,

a man who had no likeness to himself save in political faculty and devotion to the authority of the Crown. He died at Guadalupe on the 11th of January 1495.

The life of the cardinal, by Salazar de Mendoza, *Cronica del gran cardinal Don Pedro Gonzalez de Mendoza* (Toledo, 1625), is discursive and garrulous but valuable. See also Prescott, *History of Ferdinand and Isabella*.

MENDOZA, a province of western Argentina, bounded N. by San Juan, E. by San Luis and the territory of La Pampa, S. by the territories of La Pampa and Neuquen, and W. by the republic of Chile. Area, 56,502 sq. m.; pop. (1895), 116,136; (1904, estimate), 159,780. The Andes form the western boundary, and a considerable part of the territory is covered by the great Cordillera, its foothills and flanking ranges. The eastern part is an arid, sandy, level plain, with extensive saline basins, having no vegetation other than coarse grasses and thickets of low, spiny mimosas and "chañar" (*Gouiricea decorticans*). The fertile, populated districts of the province border on the Cordillera, particularly in the north where numerous streams from the snow-clad summits supply water for irrigation. The secondary ranges in this part of Mendoza are the Sierra de los Paramillos, which encloses the Uspallata Valley, and the Sierra del Tunuyán, which encloses a number of populous valleys drained by the Tunuyán river and its tributaries. One of the largest of these is the Yuco Valley. Farther south the country becomes more arid and sparsely populated, and unsubdued tribes of Indians for a long time prevented its exploration. In this region the Sierra de Payén and Sierra del Nevado (otherwise known as the Sierra Quero Matro Pellon) extend in a north-easterly direction. With the exception of the Rio Grande in the south-west part of the province, which forms the principal source of the Colorado, all the rivers of the province flow easterly and southerly into the great saline depression of western Argentina, which includes a great part of Mendoza, San Luis and La Pampa. The Andean streams rise in the higher snow-clad elevations, but their waters become impregnated with saline matter soon after reaching the plain, and are eventually lost in the saline marshes and lagoons of southern Mendoza and La Pampa. These Andean rivers are the Mendoza, Tunuyán, Diamante and Atuel, with their numerous tributaries, all of which discharge into the sluggish river which flows from the Huanacache lagoons, on the San Juan frontier, southward to the marshes and lagoons of La Pampa. The upper part of this brackish, swampy stream is called the Desaguadero, and the lower the Salado. It forms the eastern boundary line of the province down to the 36th parallel. With the exception of the elevated districts of the Andes, the climate of Mendoza is hot and dry. On the plains the rainfall is insignificant, but on the slopes of the Cordillera rains are frequent and winter cold is severe. Agriculture is the principal occupation where irrigation can be used, the province having a high reputation for its raisins and wines. Alfalfa is an important product, being grown for fattening the cattle driven through the province to the Chilean markets. The mineral resources of the province are said to be good, but receive little attention. Petroleum is found in the vicinity of San Rafael, on the Diamante river, and it is claimed that coal exists in the same region. Although Mendoza was settled by Spanish colonists from Chile as far back as 1550, its development has been hindered by its isolated position. This isolation was broken in 1884 by the completion of the Argentine Great Western railway to the provincial capital. Since then a railway has been built northward to San Juan, and another line was in 1908 under construction through the Andes to connect with the Chilean railway system. In addition to Mendoza, the capital of the province, the principal towns (hardly more than villages) are Guaymallén, Maipé, San Martin, Lujan and San Rafael. The provinces of Mendoza, San Juan and San Luis, which were settled from Chile and were for a long time governed from Santiago, were at first called the province of Cuyo, and are still spoken of as the "Cuyo provinces."

MENDOZA, a city of Argentina, capital of Mendoza province, 632 m. by rail W.N.W. of Buenos Aires. Pop. (1904, estimate),

32,000. It stands on a plain near the foot of a secondary Andean range called the Sierra de los Paramillos, at an elevation of 2320 ft. The surrounding district is arid, but has been irrigated and is covered with gardens, orchards and cultivated fields. The city is about 15 m. N. of the Mendoza, or Lujan river, whose waters are utilized for irrigation and for the requirements of the city by means of a channel which leaves the main river a little above the town of Lujan and runs to the Tulumayva river and the lagoons of Huanacache. This channel is called El Zanjón, and is believed to have been opened by Guaymallén, the chief of the Guarpsés who inhabited this district at the time of the Spanish conquest, but it is more probably natural. The city is laid out in a regular manner with broad well-paved streets and numerous public squares. The Zanjón and another stream called the Guaymallén traverse the city, and the principal streets have water flowing through them and are shaded by poplars. Because of earthquake risks, the public buildings are neither costly nor imposing. The private residences are commonly of one storey, built with wooden frames filled in with adobes. The climate is hot, dry and enervating, notwithstanding the elevation and the proximity of the Andes. The surrounding districts produce fruit, vegetables, alfalfa and cereals. The vineyard industry is prominent, and raisins and wine are exported. The position on the main route across the Andes into Chile, by way of the Uspallata or Cumbre pass (highest point 12,870 ft.), has given the city commercial importance. It has railway connexion with the principal cities of the republic, including the ports of Rosario, Buenos Aires and Bahía Blanca, and also with the capital of San Juan.

Mendoza was founded by Captain Pedro del Castillo, who had been sent from Santiago across the Andes in 1559 by Garcia Hurtado de Mendoza, the governor of Chile, to conquer and annex the territory extending N.E. to Tucuman. The city was named after Mendoza. It was made the capital of the province of Cuyo, and belonged to Chile down to 1776, when the province was transferred to the newly created vicereignty of La Plata. It was the headquarters of General San Martin while he was organizing an army for the liberation of Chile, and greatly assisted him with men and money. Under republican administration Mendoza suffered much from revolutions. Moreover, on the 20th of March 1861, the city was destroyed by an earthquake and a fire which followed. Not a building was left standing, and the loss of life was estimated at 10,000 to 12,000. The French geologist Bravard, who had predicted the catastrophe, was one of its victims. The poplars in the streets, together with some species of fruit-trees, were first planted in Mendoza by a Spaniard, Juan Cobos, in 1809, who thus became one of its greatest benefactors.

MENEDEMUS, Greek philosopher, and founder of the Eretrian school of thought, was born at Eretria about 350 and died between 278 and 275 B.C. Though of noble birth, he worked as builder and tentmaker until he was sent with a military expedition to Megara, where, according to Diogenes Laertius, he heard Plato and resolved to devote himself to philosophy. It is more likely that he heard one of Plato's followers, inasmuch as Plato died when he was only four years old, if the above dates are correct. At Megara he formed a life-long friendship with Asclepiades, with whom he toiled in the night that he might study philosophy by day. He was subsequently a pupil first of Stilpo and then of Phaedo of Elis, whose school he transferred to Eretria, by which name it was afterwards known. In addition to his philosophical work, he took a leading part in the political affairs of his city from the time of the Diadochi until his death, and obtained a remission of the tribute to Demetrius. His friendship with Antigonus Gonatas seems to have roused suspicion as to his loyalty, and he sought safety first in the temple of Amphiarus at Oropus, and later with Antigonus, at whose court he is said to have died of grief. Other accounts say that he starved himself to death on failing to induce Antigonus to free his native city. His philosophical views are known only in part. Athenaeus quotes Epicrates as stating that he was a Platonist, but other accounts credit

him with having preferred Stilpo to Plato. Diogenes Laërtius (ii. 134 and 135) says that he declined to identify the Good with the Useful, and that he denied the value of the negative proposition on the ground that affirmation alone can express truth. He probably meant to imply that qualities have no existence apart from the subject to which they belong. In ethics we learn from Plutarch (*De virt. mor.* 2) and from Cicero (*Acad.* ii. 42) that he regarded *Virtue* as one, by whatever name it is called, and maintained that it is intellectual. Cicero's evidence is the less valuable in that he always assumed that Menedemus was a follower of the Megarians. Diogenes says that he left no writings, and the Eretrian school disappeared after a short and unobtrusive existence.

Beside the ancient sources quoted above, see H. Mallett, *Histoire de l'école de Mégare et des écoles d'Élis et d'Érétrie* (1845). Also the articles MEGARIAN SCHOOL; PHAEDO; STILPO.

MENE LAUS, in Greek legend, son of Atreus (or Pleisthenes), king of Sparta, brother of Agamemnon and husband of Helen. He was one of the Greeks who entered Troy concealed in the wooden horse (Virgil, *Aeneid*, ii. 264) and recovered his wife at the sack of the city. On the voyage homewards his fleet was scattered off Cape Malea by a storm, which drove him to Egypt. After eight years' wandering in the east, he landed on the island of Pharos, where Proteus revealed to him the means of appeasing the gods and securing his return. He reached Sparta on the day on which Orestes was holding the funeral feast over Aegisthus and Clytaemnestra. After a long and happy life in Lacedaemon, Menelaus, as the son-in-law of Zeus, did not die but was translated to Elysium (Homer, *Odyssey*, iii. iv.). His grave and that of Helen were shown at Therapnae, where he was worshipped as a god (Pausanias ii. 19, 9). He was represented in works of art as carrying off the body of the dead Patroclus or lifting up his hand to slay Helen.

MENELEK II. (SAHALA MARIEM), emperor of Abyssinia, officially *negus negusti* (king of kings) of Ethiopia (1844-), son of Haeli Melicoth, king of Shoa, was born in 1844, and claimed to be a direct descendant of Solomon by the queen of Saba. On the death of his father in 1855 he was kept a prisoner at Gondar by Kassai, the governor, who had seized the throne under the title of Theodore III. But having succeeded in effecting his escape he was acknowledged king of Shoa, and at once attacked the usurper. These campaigns were unsuccessful, and he turned his arms to the west, east and south, and annexed much territory to his kingdom, still, however, maintaining his divine right to the crown of Ethiopia. After the death of Theodore in 1888 he continued to struggle against his successor, the emperor Johannes (better known to Europeans as King John of Abyssinia). Being again unsuccessful, he resolved to await a more propitious occasion; so, acknowledging the supremacy of Johannes, in 1886 he married his daughter Zeodita (b. 1876) to the emperor's son, the Ras Area; he was thereupon declared heir to the empire, and on his side acknowledged the Ras Area as his successor. Ras Area died in May 1888, and the emperor Johannes was killed in a war against the dervishes at the battle of Gallabat (Matemma) on the 10th of March 1889. The succession now lay between the late emperor's natural son, the Ras Mangasha, and Menelek, but the latter was elected by a large majority on the 4th of November, and consecrated shortly afterwards. Menelek had married in 1883 Taltu (b. 1854) a princess of Tigré, a lady who had been married four times previously and who exercised considerable influence. Menelek's clemency to Mangasha, whom he compelled to submit and then made viceroy of Tigré, was ill repaid by a long series of revolts. In 1889, at the time when he was claiming the throne against Mangasha, Menelek signed at Uccialli a treaty with Italy acknowledging Italian claims to the Asmara district. Finding, however, that according to the Italian view of one of its articles the treaty placed his empire under Italian domination, Menelek denounced it; and after defeating the Italians at Amba-Alagi, he compelled them to capitulate at Adowa in February 1896, and a treaty was signed recognizing the absolute independence of Abyssinia. His French sympathies were shown in a reported

official offer of treasure towards payment of the indemnity at the close of the Franco-Prussian War, and in February 1897 he concluded a commercial treaty with France on very favourable terms. He also gave assistance to French officers who sought to reach the upper Nile from Abyssinia, there to join forces with the Marchand Mission; and Abyssinian armies were sent Nilewards. A British mission under Sir Rennell Rodd in May 1897, however, was cordially received, and Menelek agreed to a settlement of the Somali boundaries, to keep open to British commerce the caravan route between Zaila and Harrar, and to prevent the transit of munitions of war to the Mahdists, whom he proclaimed enemies of Abyssinia. In the following year the Sudan was reconquered by an Anglo-Egyptian army and thereafter cordial relations between Menelek and the British authorities were established. In 1889 and subsequent years, Menelek sent forces to co-operate with the British troops engaged against the Somali mullah, Mahommed Abdullah. Menelek had in 1898 crushed a rebellion by Ras Mangasha (who died in 1906) and he directed his efforts henceforth to the consolidation of his authority, and in a certain degree, to the opening up of his country to western civilization. He had granted in 1894 a concession for the building of a railway to his capital from the French port of Jibuti, but, alarmed by a claim made by France in 1902 to the control of the line in Abyssinian territory, he stopped for four years the extension of the railway beyond Dire Dawa. When in 1906 France, Great Britain and Italy came to an agreement on the subject, Menelek officially reiterated his full sovereign rights over the whole of his empire. In May 1909 the emperor's grandson Lij Yasu, or Jeassu, then a lad of thirteen, was married to Romanie (b. 1902), granddaughter of the *negus* Johannes. Two days later Yasu was publicly proclaimed at Adis Ababa as Menelek's successor. At that time the emperor was seriously ill and as his ill-health continued, a council of regency—from which the emperor was excluded—was formed in March 1910. (See also ABYSSINIA.)

MENÉNDEZ Y PELAYO, MARCELINO (1856-), Spanish scholar and critic, was born at Santander on the 3rd of November 1856. In 1871-1872 he studied under Milá y Fontanals at the university of Barcelona, whence he proceeded to the central university of Madrid. His academic successes had never been surpassed; a special law was passed by the Cortes to enable him to become a professor at the age of twenty-two, and three years later he was elected a member of the Spanish Academy. But before this date (1882) he was well known throughout Spain. His first volume, *Estudios críticos sobre escritores montañeses* (1876), had attracted little notice, and his scholarly *Horacio en España* (1877) appealed only to students. He became famous through his *Ciencia española* (1878), a collection of polemical essays defending the national tradition against the attacks of political and religious reformers. The unbending orthodoxy of this work is, if possible, still more pronounced in the *Historia de los heterodoxos españoles* (1880-1886), and the writer was hailed as the champion of the ultramontane party. His lectures (1881) on Calderón established his reputation as a literary critic; and his work as an historian of Spanish literature was continued in his *Historia de las ideas estéticas en España* (1881-1891), his edition (1890-1903) of Lope de Vega, his *Antología de poetas líricos castellanos* (1890-1906), and his *Orígenes de la novela* (1905).

MENENIUS LANATUS, AGRIPPA, Roman patrician and statesman, consul 503 B.C. On the occasion of the first secession of the people to the Sacred Mount, Agrippa, who was known to be a man of moderate views, was one of the commissioners empowered by the senate to treat with the seceders. On this occasion he recited the well-known fable of the belly and the members.

Livy ii. 16, 32, 33; Dion. *Halic.* v. 44-47; vi. 49-88, 96; Val. *Max.* iv. 4, 2.

MENES, the name of the founder of the 1st Dynasty of historical kings of Egypt. He appears at the head of the lists not only in Herodotus and Manetho, but also in the native Turin Papyrus of Kings and the lists of Abydos, while the list

of Sakkara begins with the sixth king of the 1st Dynasty, a fact which may throw some doubt on the supposed foundation of Memphis by Menes. Until recently he was looked upon as semi-mythical, but the discovery of the tombs of many kings of the 1st Dynasty including probably that of Menes himself, as well as an abundance of remains of still earlier ages in Egypt has given him a personality. He was probably ruler of Upper Egypt and conquered the separate kingdom of Lower Egypt.

See EGYPT; K. Sethe, "Menes und die Grundung von Memphis," in his *Untersuchungen zur Geschichte und Alterthumskunde Aegyptens*, iii. 121. (F. L. G.)

MENGS, ANTONY RAPHAEL (1728-1779), German painter, was born in 1728 at Aussig in Bohemia, but his father, Ismael Mengs, a Danish painter, established himself finally at Dresden, whence in 1741 he took his son to Rome. The appointment of Mengs in 1749 as first painter to the elector of Saxony did not prevent his spending much time in Rome, where he had married in 1748, and abjured the Protestant faith, and where he became in 1754 director of the Vatican school of painting, nor did this hinder him on two occasions from obeying the call of Charles III. of Spain to Madrid. There Mengs produced some of his best work, and specially the ceiling of the banqueting-hall, the subject of which was the Triumph of Trajan and the Temple of Glory. After the completion of this work in 1777, Mengs returned to Rome, and there he died, two years later, in poor circumstances, leaving twenty children, seven of whom were pensioned by the king of Spain. Besides numerous paintings in the Madrid gallery, the Ascension at Dresden, Perseus and Andromeda at St Petersburg, and the ceiling of the Villa Albani must be mentioned among his chief works. In England, the duke of Northumberland possesses a Holy Family, and the colleges of All Souls and Magdalen, at Oxford, have altar-pieces by his hand. In his writings, in Spanish, Italian and German, Mengs has put forth his eclectic theory of art, which treats of perfection as attainable by a well-schemed combination of diverse excellences—Greek design, with the expression of Raphael, the chiaroscuro of Correggio, and the colour of Titian. His intimacy with Winckelmann—who constantly wrote at his dictation—has enhanced his historical importance, for he formed no scholars, and the critic must now concur in Goethe's judgment of Mengs in *Winckelmann und sein Jahrhundert*; he must deplore that so much learning should have been allied to a total want of initiative and poverty of invention, and embodied with a strained and artificial mannerism.

See *Opere di Antonio Raffaello Mengs* (Parma, 1780); *Mengs Werke, übersetzt v. G. F. Franze* (1786); *Zeitschrift für bildende Kunst* (1880); Bianconi, *Elogio storico di Mengs* (Milan, 1780); Woermann, *Ismael und Raphael Mengs* (Leipzig, 1893).

MENGTSZE, a city in the S.E. of the province of Yunnan, China. Pop. about 12,000. It was selected by the French convention of 1886 as the seat of the overland trade between Tongking and Yunnan, and opened two years later. It is beautifully situated in the centre of a valley basin on a plateau 3,500 ft. above sea-level. The country round is fertile and well cultivated, and the place must have been one of considerable wealth before the T'ai-ping rebellion, as the ruins of many fine temples attest. A considerable overland trade has sprung up since the opening of Mengtsze. Of the import trade Hong-Kong supplied 86%, and of the export trade 70%. Cochin-China, Tongking and Annam claiming the remainder. Tin (68%) and opium (27-8%) are the principal exports, and textiles (71%), mostly cottons, and tobacco (4%) are the chief imports. On the Tongking side this trade follows the Red River route as far as Manhao, which is distant from Mengtsze about 40 m., though the navigation of the river is difficult. From Manhao the transit is by coolies or pack animals. Concessions have been obtained by the French government to build a line of railway from the Tongking frontier at the town of Laokay via Mengtsze to Yunnan-fu. The climate is equable and healthy.

MENHADEN, economically one of the most important fishes of the United States, known by a great number of local names, "menhaden" and "mossbunker" being those most generally

in use. The Indians and white settlers used it as a manure, and the name is Narragansett for "fertilizer." Its scientific name is *Clupea* (or *Alosa*) *menhaden* and *Brevoortia tyrannus*. It is allied to the European species of shad and pilchard, and, like the latter, approaches the coast in immense shoals, which are found throughout the year in some part of the littoral waters between Maine and Florida, the northern shoals retiring into deeper water or to more southern latitudes with the approach of cold weather. The average size of the menhaden is about 12 in. It is too bony and oily for a table-fish, but is used as bait for cod and mackerel. A large fleet is engaged in the fishery; and a great number of factories extract the oil for tanning and currying, and for adulterating other more expensive oils, and manufacture the refuse into a valuable guano.

MENIAL, that which belongs to household or domestic service, hence, particularly, a domestic servant. The idea of such service being derogatory has made the term one of contempt. The word is derived from an obsolete *menie* or *meyne*, the company of household servants or retainers; a Scottish form is *menzie*. The origin is to be found in the O.Fr. *mesnie*, popular Lat. *mansionaria*, from *mansio*, mansion, from which comes Fr. *maison*, house.

MÉNIER, EMILE JUSTIN (1826-1881), French manufacturer and politician, was born at Paris in 1826. In 1853, on the death of his father, Antoine Brutus Ménière, he became proprietor of a large drug factory, founded in 1815 by the latter at Saint Denis, Paris, and in 1825 at Noisiel-sur-Marne. Antoine Brutus Ménière had also manufactured chocolate in a small way, but Emile Justin from the first devoted himself specially to chocolate. He purchased cocoa-growing estates in Nicaragua and beet-fields in France, erected a sugar-mill, and equipped himself in other ways for the production of chocolate on a large scale. In 1864 he sold his interest in the drug-manufacturing business, and thenceforth confined himself to chocolate, building up an immense trade. Ménière was a keen politician, and from 1876 till his death had a seat in the French Chamber, his general views being strongly Republican, while he consistently opposed protection. He was the author of several works on fiscal and economic questions, notably *L'Impôt sur le capital* (1872), *La Réforme fiscale* (1872), *Économie rurale* (1875), *L'Avenir économique* (1875-1878), *Atlas de la production de la richesse* (1878). He died at Noisiel-sur-Marne in 1881, his sons succeeding to the business.

MÉNIÈRE'S DISEASE, a form of auditory vertigo, first described by a French physician, Emile Antoine Ménière, in 1861. It usually attacks persons of middle age whose hearing has been previously normal. A. Politzer gives the following as the principal causes: intense heat and exposure to the sun, rheumatism, influenza, venereal diseases, anaemia and leukaemia. The disease presents itself in various forms, but the most usual is the apoplectiform, due to haemorrhage into the labyrinth, followed by more or less complete deafness in either or both ears. The attack usually sets in with dizziness, noises in the ears, nausea, vomiting and staggering gait, and the patient may suddenly fall down with loss of consciousness. The seizures are usually paroxysmal, occurring at irregular intervals of days or weeks. Between the attacks the equilibrium may be disturbed, there being marked nystagmus and unsteadiness of gait. The attacks of vertigo tend to become less frequent and may entirely pass away, but the deafness may remain permanent. The treatment is directed towards relieving the troublesome head symptoms by the application of cold compresses. The drug that has proved most serviceable in diminishing the dizziness is potassium iodide, administered daily for at least a month. Politzer considers that the attacks may be averted by producing rarefaction of the air in the external meatus of the ear by means of a specially devised aspirating tube.

MENIN (Flemish *Meenen*), a town of Belgium in the province of West Flanders situated on the Lys 7 m. S. of Courtrai. Pop. (1904), 19,377. It manufactures linen and flannel, and in the neighbourhood are extensive tobacco plantations. It was first

fortified in 1578, and in 1685 Vauban made it one of the strongest places on the French frontier, but the fortifications were razed in 1748 by the treaty of Aix-la-Chapelle.

MENINGITIS (from Gr. *μηνίγγη*, a membrane), a term in medicine applied to inflammation affecting the membranes of the brain (cerebral meningitis) or spinal cord (spinal meningitis) or both.

Tubercular cerebral meningitis (or *Acute Hydrocephalus*) is a disease due to inflammation of the meninges of the brain produced by the presence of a tubercle bacillus. This disease is most common in children under ten years of age, but may affect adults. The tubercular constitution is an important factor in this malady. In numerous cases it is manifestly connected with bad hygienic conditions, with insufficient or improper feeding, or with over exercise of the mental powers, all of which will doubtless more readily exert their influence where an inherited liability exists, and the same may be said regarding its occasional occurrence as one of the after consequences of certain of the diseases of childhood, especially measles and whooping-cough.

There are certain typical features characterizing the disease in each of its stages. The primary symptoms are mostly such as relate to the general nutrition. A falling off in flesh and failure of strength are often observed for a considerable time before the characteristic phenomena of the disease appear. The patient, if a child, becomes listless and easily fatigued, loses appetite, and is restless at night. There is headache after exertion, and the child becomes unusually irritable. These symptoms may persist during many weeks; but on the other hand such premonitory indications may be entirely wanting, and the disease be developed to all appearance suddenly.

The onset is in most instances marked by the occurrence of vomiting, often severe, but sometimes only slight, and there is a general obstinate constipation. In not a few cases the first symptoms are convulsions, which, however, may in this early stage subside, and remain absent, or reappear at a later period. Headache is one of the most constant of the earlier symptoms, and is generally intense and accompanied with sharper paroxysms, which cause the patient to scream, with a peculiar and characteristic cry. There is great intolerance of light and sound, and general nervous sensitiveness. Fever is present to a greater or less extent, the temperature ranging from 100° to 103° F.; yet the pulse is not quite so rapid, and the contraction of the heart is slow, but exhibiting a tendency to irregularity, and is liable to become rapid on slight exertion. The breathing, too, is somewhat irregular. Symptoms of this character, constituting the stage of excitement, continue for a period varying from one to two weeks, when they are succeeded by the stage of depression. There is now a marked change in the symptoms, which is apt to lead to the belief that a favourable turn has taken place. The patient becomes quieter and inclines to sleep, but it will be found on careful watching that this quietness is but a condition of apathy or partial stupor into which the child has sunk. The vomiting has ceased, and there is less fever; the pulse is slower, and shows a still greater tendency to irregularity than before, while the breathing is of markedly unequal character, being rapid and shallow at one time, and long drawn out and sinking away at another. There is manifestly little suffering, although the peculiar cry may still be uttered, and the patient lies prostrate, occasionally rolling the head uneasily upon the pillow, or picking at the bedclothes or at his face with his fingers. He does not ask for food, but readily swallows what is offered. The countenance is pale, but is apt to flush up suddenly for a time. The eyes present important alterations, the pupils being dilated or unequal, and scarcely responding to light. There may be double vision, or partial or complete blindness. Squinting is common in this stage, and there may also be drooping of an eyelid, due to paralysis of the part, and one or more limbs may be likewise paralysed.

To this succeeds the third or final stage, in which certain of the former symptoms recur, while others become intensified. There is generally a return of the fever, the temperature rising sometimes very high. The pulse becomes feeble, rapid, and exceedingly irregular, as is also the case with the breathing. Coma is profound, but the patient may still be got to swallow nourishment, though not so readily as before. Convulsions are apt to occur, while paralysis, more or less extensive, affects portions of the body or groups of muscles. The pupils are now widely dilated, and there is generally complete blindness and often deafness. In this condition the patient's strength undergoes rapid decline, and the body becomes markedly emaciated. Death takes place either suddenly in a fit, or more gradually from exhaustion. Shortly before death it is not uncommon for the patient, who, it may be for many days previously, lay in a state of profound stupor, to awake up, ask for food, and talk to those around. The duration of a case varies somewhat, but in general death takes place within three weeks from the onset of the symptoms. The disease may be said to be

almost invariably fatal, yet cases presenting all the principal symptoms occasionally recover.

Much may be done in the way of prevention of this disease, and, in its earlier stages, even in the way of cure. It is most important in families where the history indicates a tubercular or scrofulous tendency, and particularly where acute hydrocephalus has already occurred, that every effort should be used to fortify the system and avoid the causes already alluded to as favouring the development of the disease during that period in which children are liable to suffer from it. With this view wholesome food, warm clothing, cleanliness, regularity, and the avoidance of over-exertion, physical and mental, are of the utmost consequence.

Timely use of remedies may mitigate and even occasionally remove the symptoms when they arise. The maintenance of the patient's strength by light nourishment and the use of sedatives to compose the nervous system are the measures most likely to be attended with success. Bromide, combined with iodide of potassium, is the medicinal agent of most value for this purpose. Should convulsions occur, they are best treated by chloral or chloroform.

In what is known as *suppurative*, or *simple acute meningitis* (non-tubercular), the disease arises from various causes, and the symptoms are similar to those described above.

In *posterior-basic meningitis*, inflammation of the membranes investing the posterior basic spinal cord, the chief symptoms are fever, with severe pain in the back or loins shooting downwards into the limbs (which are the seat of frequent painful involuntary startings), accompanied with a feeling of tightness round the body.

The local symptoms bear reference to the portion of the cord the membranes of which are involved. Thus when the inflammation is located in the cervical portion the muscles of the arms and chest are spasmodically contracted, and there may be difficulty of swallowing or breathing, or embarrassed heart's action, while when the disease is seated in the lower portion, the lower limbs and the bladder and rectum are the parts affected in this way. At first there is excited sensibility (hyperaesthesia) in the parts of the surface of the body in relation with the portion of cord affected. As the disease advances these symptoms give place to those of partial loss of power in the affected muscles, and also partial anaesthesia. These various phenomena may entirely pass away, and the patient after some weeks or months recover; or, on the other hand, they may increase, and end in permanent paralysis.

Some observers regard these forms as sporadic cases of cerebro-spinal fever, and Still, William Hunter and George Nuttall have isolated an organism similar to the diplococcus intracellularis, while Henry Koplik in New York found cases of typical posterior-basic meningitis due to the diplococcus intracellularis.

The treatment is directed to allaying the pain and inflammatory action by opiates. Ergot is recommended by many physicians. The patient should have perfect rest in the recumbent, or better still in the prone, position. Cold applications to the spine may be of use, while attention to the functions of the bladder and bowels, and to the condition of the skin with the view of preventing bedsores, is all-important.

Cerebro-spinal fever or epidemic cerebro-spinal meningitis, popularly called "spotted fever," is an infectious disease occurring sporadically or in epidemics, and due to the diplococcus intracellularis discovered by Weichselbaum in 1887. This disease was not recognized until the 19th century. It was first described at Geneva in 1805 and small outbreaks followed in Paris (1814), Metz and Genoa (1815), and Westphalia (1822), but in the United States there was a widespread epidemic, including New England and spreading as far as Kentucky and Ohio. Fresh outbreaks in Europe took place between 1837 and 1850. In 1837 it prevailed in the south of France chiefly amongst troops in garrison, and fresh outbreaks continued throughout France in 1846 with epidemics in Algiers, Italy and Sicily. In Great Britain it first showed itself in the Irish workhouses in 1846, where it was known as "the black death" or "malignant purpura fever." After 1866 except for sporadic cases it disappeared from Great Britain, but small outbreaks took place in 1885 to 1900 in Dublin. In 1905 there was an extensive epidemic in New York, followed by an outbreak in Scotland in 1906, and in Scotland and Ireland in 1907-1908. The registrar-general's returns for 1907 give 1018 deaths in Scotland due to the disease, of which 711 were at Glasgow and 148 at Edinburgh. In the same year Belfast was visited by a severe epidemic, 405 deaths out of the total death-rate of 631 taking place in that district.

The mode of infection is obscure, but the organism is thought to gain access to the circulation through the mucous membrane of the nose and conjunctiva, as the organism has been isolated from the mucous membrane of the nose, not only of those suffering from the disease but from healthy persons who have been in contact with cases. Cerebro-spinal fever has an undoubted tendency to follow bad sanitary conditions and to prevail in damp, sunless houses. It is a disease of temperate climates, and the outbreaks usually take place in the spring of the year. The victims are mostly children and young adults, and Koplik states that few recoveries take place in children under two years of age.

The onset of symptoms is sudden, as contrasted with tubercular meningitis, in which the onset is gradual. The attack comes on sharply with intense headache, rigors and vomiting. The pain soon localizes itself in the back of the neck and occiput, and may thence radiate down the spine, limbs and abdomen. The pain is soon followed by a characteristic symptom, namely retraction of the head. The head is drawn back and rigidly fixed, the spine arched and the limbs drawn up, and muscular spasms may take place. There is general hyperaesthesia, the slightest contact producing pain. More or less fever is present, but the temperature is not characteristic. The headache continues with great severity and restlessness and delirium supervene, or there may be long periods when the patient is comatose. Twitching of the limbs and general convulsions may occur and facial paralysis is frequent. Paralysis of the ocular nerves causing squint, dilatations and contractions of the pupil are common as in other varieties of meningitis.

Some of the most striking symptoms are the rashes. These usually occur about the fourth day of illness and vary in character, resembling erythema, urticaria, rose spots or purpuric spots. The rashes have usually no relation to the gravity of the disease, but severe cutaneous haemorrhages usually indicate a severe form of illness. Should the patient survive the first shock of the attack serious complications may arise; the eyes may be attacked by severe conjunctivitis, iritis or keratitis or inflammation of the deeper parts may take place leading to detachment of the retina. More frequent even is disease of the auditory apparatus, and purulent otitis media or disease of the labyrinth may lead to permanent deafness. Serous effusion may take place into joints where the patient is confined to bed, and acute rheumatism may occur.

Certain forms of the disease are rapidly fatal, these are known as the fulminant type, and death may take place within 12 to 24 hours of the onset. Death usually occurs between the fifth and the eighth day, but many cases drag on for weeks with rapid and progressive emaciation, and recovery is slow. The mortality has varied in different epidemics. Hirsch's tables of forty-one epidemics give a mortality of from 25 to 75%, and Koplik rates it at 48 to 90%. During 1907, 623 cases of cerebro-spinal fever were notified in Belfast, and the deaths numbered 495. During that year the disease was made fatal in 48 Irish parishes and 55 rural districts. The mortality in Dublin was 77%. Oster states that in children under one year (in New York) the mortality reached 87.6%.

The changes found after death from cerebro-spinal fever are an acute inflammation of the pia-arachnoid membrane both of the brain and spinal cord, with effusion of serum or pus into the ventricular and subarachnoid spaces. With such rapidity may the effusion become purulent that it has been found purulent in a case where death took place within five hours from the apparent onset. The operation of lumbar puncture (or puncture of the spinal canal between the lumbar vertebrae) has enabled the physician to make an accurate diagnosis in the case. Dr Robt. of Belfast reports that during the epidemic there, of 275 cases treated by ordinary means, the death-rate was 72.3%, but in 90 cases treated with injections of Flexner and Jobling's serum the death-rate was only 30%.

Dr Ivy McKenzie and Dr W. B. Martin of Glasgow have published a series of cases treated with the highly immune serum of patients who have recovered from the disease with encouraging results.

MENIPPUS, of Gadara in Coele-Syria, Greek cynic and satirist, lived during the 3rd century B.C. According to Diogenes Laërtius (vi. 8) he was originally a slave, amassed a fortune as a money-lender, lost it, and committed suicide through grief. His works (written in a mixture of prose and verse) are all lost. He discussed serious subjects in a spirit of railery, and especially delighted in attacking the Epicureans and Stoics. His writings exercised considerable influence upon later literature. One of the dialogues attributed to Lucian, his avowed imitator, who frequently mentions him, is called *Menippus*. But this dialogue is regarded with suspicion, and since the sub-title ("The Oracle of the Dead") resembles that of a work ascribed to Menippus by Diogenes Laërtius, it has been suggested that it is really the work of Menippus himself, or at any rate imitated from his *Nékuia* by the author, whether Lucian or another. It is well known that the Menippean satires of M. Terentius Varro, the fragments of which give an idea of this kind of composition, were called after Menippus of Gadara (see Teuffel-Schwabe, *Hist. of Roman Literature*, § 165, 3).

BIBLIOGRAPHY.—F. Ley, *De vita scriptisque Menippi cynici* (Cologne, 1843); R. Helm, *Lucian und Menipp* (1906); C. Wachsmuth, *Sillogographum graecorum reliquiae* (1885), with an account of Menippus and similar writers. Menippus found an imitator in later times in Justus Lipsius, author of a *Satyra menippaea* (1637) in which he ridiculed certain literary men of his age, especially the poet laureate; and in the authors of the famous *Satyre Menippée* (1593; latest editions by C. Marcilly, Paris, 1882; J. Frank, Oppeln, 1884), written against the Holy League during the reign of Henri IV.

MENIUS, JUSTUS (1499-1558), Lutheran theologian, whose name is Latinized from Jost or Just (i.e. Jodocus) Menig, was born at Fulda, of poor but respectable parents, on the 13th of December 1499. Entering the university of Erfurt in 1514, he took the bachelor's degree in 1515, the master's in 1516. At this time, in association with the keen humanists Conrad Mutian, Crotus Rubeanus and Eoban Hess, he was of sceptical tendency; moving to Wittenberg in 1519, he became evangelical under the teaching of Melancthon and the preaching of Luther. After travel in Italy (1521-1522) he was appointed (1523) town's preacher at Wittenberg, but was soon transferred to the charge of Mühlberg, under Erfurt. Here he published his commentary on Acts (1524) and married. He resigned his charge (1525) and opened a school at Erfurt, but the town council insisted on his resuming his ministry, appointing him preacher in St Thomas', Erfurt. He worked in conjunction with Luther's friend, John Lange, and was opposed by the Franciscans under Conrad Kling. Hence he left for Gotha (1528), resumed teaching, and enjoyed the friendship of Friedrich Myconius. Duke John of Saxony had placed him on the commission for church visitation in Thuringia, and in 1529 appointed him pastor and superintendent at Eisenach, where for eighteen years he administered church affairs with tact, and fostered the spread of education. In 1529 he brought out his *Oeconomia christiana* (a treatise in German, on the right ordering of a Christian household) with a dedication to the duchess Sybil of Saxony and a preface by Luther. His tractate, written in concert with Myconius, controverting *Der Wiederläufer Lehre und Geheimniss* (1530) was also prefaced by Luther. The reversion to the Roman communion of his old friend Crotus led to his mordant *Responsio amici* (1532, anon.) in the *Apologia* (1531) of Crotus. He took his part in the theological disputations of the time, at Marburg (1529), the Concordia at Wittenberg (1536), the Convention at Schmalkalden (1537), the discussions at Hagenau and Worms (1540). His tractate (1542) against the permission of bigamy in the case of Philip of Hesse was not allowed to be printed (the manuscript is in the Heidelberg university library). In 1542 he removed to Mühlhausen, being appointed by Duke Henry of Saxony for the ordering of the church there. On the death of Myconius (1546) he was entrusted with the oversight of Gotha, in addition to that of Eisenach; to Gotha he returned in 1547. The remainder of his life was not happy. He was against the Leipzig *Interim* (1548) with its compromise on some Catholic usages, and was involved in controversies and quarrels; with Georgius Merula, against whom he maintained the need of exorcism in

baptism; with Oslander's adherents in the matter of justification; with his colleague, Nicholas von Amsdorf, to whom he had resigned the Eisenach superintendency; with Flacius Illyricus, and others. He lost favour with Duke John Frederic of Saxony, fell into bad health, was deposed (1555) from his offices, and was disappointed in his hopes of being reinstated, after the colloquy at Eisenach (1556). He died at Leipzig on the 11th of August 1558. He was twice married, and had several sons, of whom Eusebius held a chair of philosophy at Wittenberg, and married Melancthon's grand-daughter, Anna Sabinus. Schmidt gives a full bibliography of the numerous writings of Menius, who translated several of Luther's biblical commentaries into German. His *Oeconomia* was reprinted in 1855.

See G. L. Schmidt, *Justus Menius, der Reformator Thüringens* (1867); Wagenmann, in *Allgemeine deutsche Biog.* (1885); G. Kawerau, in *Hauck's Realencyklopädie* (1903). (A. Go.)*

HAENCK, ADAH ISAACS (1835-1868), American actress, was born in New Orleans, the daughter of a Spanish Jew, her name being Dolores Adios Fuertes. Left in poverty at the age of thirteen, she made her first appearance as a dancer in her native city. She had a great success there and in other southern cities, including Havana, and she afterwards aspired to act in serious parts. In 1856 she married John Isaacs Menken, translated Adios to Adah, and thus took the name she thereafter bore through various matrimonial ventures. In 1864 she appeared at Astley's in London as Mazeppa, a performance of an athletic dramatic type suited to her fine physique. In England and France she became intimate with many literary men—Swinburne, Charles Reade, Dickens (to whom she dedicated in 1868 a volume of verse, *Infelicia*), Gautier and Dumas the elder. Paris saw her for a hundred nights in *Les Pirates de la Savane*, and she also played in Vienna and again in London. She died in Paris on the 10th of August 1868.

MENNONITES, a body of religionists who take their name from Menno Simons (see below), the most valued exponent of their principles. They maintain a form of Christianity which, discarding the sacerdotal idea, owns no authority outside the Bible and the enlightened conscience, limits baptism to the believer, and lays stress on those precepts which vindicate the sanctity of human life and of a man's word. The place of origin of the views afterwards called Mennonite (see BAPTISTS) was Zürich, where in 1523 a small community left the state church and (from Jan. 18, 1525) adopted the tenet of believers' baptism. Unlike other Reformers, they denied at once the Christian character of the existing church and of the civil authority, though, in common with the first Christians, it was their duty to obey all lawful requirements of an alien power. By Protestants as much as by Catholics this position was not unaturally regarded as subversive of the established foundations of society. Hence the bitter persecutions which, when the safety of toleration was not imagined, made martyrs of these humble folk, who simply wished to cultivate the religious life apart from the world. There was something in this ideal which answered to that medieval conception of separation from the world which had leavened all middle-class society in Europe; and the revolt from Rome had prepared many minds to accept the further idea of separation from the church, for the pursuit of holiness in a society pledged to primitive discipline. Hence the new teaching and praxis spread rapidly from Switzerland to Germany, Holland and France. While the horrors of the Münster fanaticism, which culminated in 1534, made Anabaptism a byword, and increased the severity of a persecution directed against all Baptists indiscriminately, the reaction against the fatal errors of the Münster experiment increased also the adherents of communities which discarded the sword; thus Menno was brought into their ranks. Each community was independent, united with others only by the bond of love. There was no hierarchy (as with the Familists), but "exhorters" chosen by the members, among them "elders" for administering baptism and the Lord's Supper; an arrangement so readily renewed that the sure way of putting down such a body was the execution of all its constituents, often by drowning, an

appropriate end, according to Zwingli's quip. The remnant of the Swiss Mennonites (not tolerated till 1710) broke in 1620 into two parties, the Uplanders (or Amish, from their leader Jacob Amen) holding against the Lowlanders that excommunication of husband or wife dissolved marriage, and that razors and buttons were unlawful. In Holland the Mennonites have always been numerous. An offshoot from them at Rhinsburg in 1619, founded by the four brothers, farmers, Van der Kodde, and named Collegianten from their meetings, termed *collegia* (thus, as not churches, escaping the penal laws), has been compared to the Plymouth Brethren, but differed in so far as they required no conformity of religious opinion, and recognized no office of teacher. With them, as Martineau notes, Spinoza had "an intense feeling-fellow." Later, the exiled Socinians from Poland (1660) were in many cases received into membership. There had previously been overtures, more than once, for union with Mennonites on the part of Polish Socinians, who agreed with them in the rejection of oaths, the refusal to take human life, the consequent abstinence from military service and magisterial office, and in the Biblical basis of doctrine; differences of doctrinal interpretation precluded any fusion. In Holland the Mennonites were exempted from military service in 1575, from oath-taking in 1585, from public office in 1617. In Zealand exemption from military service and oaths was granted in 1577; afterwards, as in Friesland, a heavy poll tax was the price of exemption from military service; but since 1795 they have enjoyed a legal exemption from oath-taking. In France the Mennonites of the Vosges were exempted from military service in 1793, an exemption confirmed by Napoleon, who employed them in hospital service on his campaigns. That he did not exempt the Dutch Mennonites is due to the fact that "they had ceased to present a united front of resistance to military claims" (Martineau); in fact they sent a large band of volunteers to Waterloo (Barclay). While in Germany the Mennonites exist in considerable numbers, more important are the German Mennonite colonies in southern Russia, brought there in 1786 by Catherine II., and freed, by the grant of complete religious liberty, from the hardships imposed by Prussian military law. These colonies have sent many emigrants to America, where their oldest community was settled (1683) at Germantown, Pennsylvania. Their settlement in Canada dates from 1786. Among the American Mennonites there are three sections, and a progressive party, known as New School Mennonites.

S. Cramer gives (1903) the following statistics: in all, some 250,000 members, of whom over 80,000 are in the United States, 70,000 in Russia, 60,000 in Holland, 20,000 in Canada, 18,000 in Germany, 1500 in Switzerland, 800 in France, and the same number in Poland and Galicia. (A. Go.)*

MENNO SIMONS (1492-1550), religious leader, was born in 1492 at Witmarsum in Friesland. Of his parentage (apart from his patronymic) and education nothing is known. He was not a man of learning, nor had he many books; for his knowledge of early Christian writers he was partly indebted to the *Chronica* or compilations of Sebastian Franck. At the age of twenty-four he entered the priesthood, becoming one of two curates under the incumbent of Pingium, a village near his birthplace. He accused himself, with the other clergy, of lax and self-indulgent living. Doubts about transubstantiation made him uneasy; some of Luther's tracts fell in his way, and he was comforted by Luther's dictum that salvation does not depend on human dogmata. Hence he began to study the New Testament. The question as to the right age for baptism came up; he found this an open matter in the early church. Then the execution, in March 1531, at Leeuwarden, of the tailor Sicke Freerks, who had been rebaptized in the previous December at Emden, introduced further questions. Menno was not satisfied with the inconsistent answers which he got from Luther, Bucer and Bullinger; he resolved to rely on Scripture alone, and from this time describes his preaching as evangelical, not sacramental. In 1532 he exchanged his curacy for a living at Witmarsum in response to a popular call. Anabaptism of the Münster type

repelled him. His first tractate (1535, first printed 1627) is directed against the "horrible and gross blasphemy of John of Leiden"—though the genuineness of this tract has been doubted. A brother of Menno joined the insurgent followers of John Matthyszoon, and was killed at Bolsward (April 1535). Blaming the leaders by whom these poor people had been misled, Menno blamed himself for not having shown them a straight course. Accordingly on the 12th of January 1536, he left the Roman communion. There were now among the so-called Anabaptists four parties, the favourers of the Münster faction, the Batenburgers, extremists, the Melchiorites and the Obbenites. For a time Menno remained aloof from both Melchior Hofman and Obbe Philipsz. Before the year was out, yielding to the prayer of six or eight persons who had freed themselves from the Münster spell, he agreed to become their minister, and was set apart (January 1537) to the eldership at Groningen, with imposition of hands by Obbe Philipsz, who is regarded as the actual founder of the Mennonite body. In fact, Obbe left the body and is stigmatized as its Demas. Menno repudiated the formation of a sect; those who had experienced the "new birth" were to him the true Christian church, which was limited by no decree of reprobation. His Christology was in the main orthodox, though he rejected terms (such as Trinity) which he could not find in Scripture, and held a Valentinian doctrine of the celestial origin of the flesh of Christ. His church discipline was drawn from the Swiss Baptists. Silent prayer was a feature of the worship; sermons were without texts. Neither baptism (by pouring on the head) nor the Lord's Supper (with the accompaniment of feet-washing) conferred grace; they were divine ordinances which reflected the believer's inward state. Marriage with outsiders was prohibited; women had no part in church government. Oaths and the taking of life were absolutely forbidden; hence the magistracy and the army were for the Mennonite unlawful callings; but magistrates were to be obeyed in all things not prohibited by Scripture. The subsequent career of Menno was that of an active missionary; his changes of place, often compulsory, are difficult to trace. He was apparently much in East Friesland till 1541; in North Holland, with Amsterdam as centre, from 1541 to 1543; again till 1545 in East Friesland (where he held a disputation at Emden with John à Lasco in January 1544); till 1547 in South Holland; next, about Lübeck; at Wismar in 1553-1554 (he held two disputations with Martin Micronius at Norden in February 1554); lastly at Wüstenfelde, a village near Oldesloo, between Hamburg and Lübeck, where he died on the 13th of January 1559. He had married one Gertrude at Groningen, and left a daughter, by whom the dates of his birth and death were communicated to P. J. Twisch, for his *Chronyk* (1619).

Menno's writings in Plattdeutsch, printed at various places, are numerous, with much sameness, and what an unfriendly critic would call wool-gathering; through them shines a character attractive by the sincerity of its simple and warm spirituality, the secret of Menno's influence. The collection of his *Opera Omnia Theologica* (Amsterdam, 1681), folio, in a Dutch version, comprises twenty-three tractates, with reference to nine unprinted. His main principles will be found in his *Das Fundament der Christeliken Leven* (1539, 8vo). A selection (*Gedenkskriften*) from his writings, in a German version, in honour of the (supposed) tercentennial of his death was edited by J. Mannhardt (Danzig, 1861) with an appendix from the writings of Dirk Philipsz (1504-1570), brother of Obbe, and Menno's benchman. His writings are published in English at Elkhart, Indiana.

Since the publication of the *Leven* (1837) by A. M. Cramer, light has been thrown on the period by the researches of de Hoop Scheffer; see Van der Aa, *Biographisch woordenboek der Nederlanden* (1869); R. Barclay, *Inner Life of Religious Societies of the Commonwealth* (1876) for a good account of Mennonite anticipations of Quaker views and practices. F. C. Fleischer, *Menno Simons, eine Lebensskizze* (1892); V. M. Reimann, *Menno'st des Christeliken Levens* (1894); S. Cramer, in Hauck's *Realencyclopädie* (1903); a separate article in the same, *Mennoniten*, by S. Cramer, gives a survey of the origin and ramifications of the movement in Europe and America. (A. G. O.)

MENOMINEE, a city and the county-seat of Menominee county, Michigan, U.S.A., on Green Bay, at the mouth of the Menominee river, opposite Marinette, Wisconsin, at the southern extremity of the upper peninsula. Pop. (1890), 10,630; (1900), 12,818, of whom 4186 were foreign-born; (1910 census),

10,507. It is served by the Chicago & North-Western, the Chicago, Milwaukee & St. Paul, the Wisconsin & Michigan, and the Ann Arbor railways, and is connected by five bridges with Marinette, Wisconsin. Menominee has several parks, and harbour and dock facilities for the heaviest lake vessels. It is one of the largest lumber centres in the United States; it has excellent water power, and there are manufactures of wire, steel, electrical appliances, mill and mining machinery, shoes, beet sugar and paper. The use of beet-pulp instead of Indian corn ensilage for dairy cows has promoted the dairying industry in the city.

A trading post was established here in 1799, but settlement was not begun until 1833. Menominee became the county-seat in 1874, was chartered as a city in 1883, and in 1891 and in 1901 it was re-chartered; in 1903 an amendment to the charter created a municipal court. The city is named after the Menominee Indians, an Algonquian tribe formerly ranging over a considerable territory in Wisconsin and Michigan, who seem to have been first visited by whites in 1634, when Nicolet found them at the mouth of the Menominee river, and now number about 1600, most of them being under the Green Bay school superintendency, Wisconsin. The name is the Chippewa word for wild rice, which formed part of the food of the tribe.

MENOMONIE, a city and the county-seat of Dunn county, Wisconsin, U.S.A., about 64 m. E. of St. Paul, Minnesota, on the Red Cedar river. Pop. (1890), 5491; (1900), 5655, of whom 1772 were foreign-born; (1905), 5473; (1910), 5036. It is served by the Chicago, Milwaukee & St. Paul, and the Chicago, St. Paul, Minneapolis & Omaha railways. The city is widely known for its institutions, for the most part founded or supported by James Huff Stout (1848-1910), a prominent local lumberman. Among them are the Mabel Tainter Memorial Library, the Dunn County School of Agriculture, the Dunn County Normal Training School, the Stout Institute for the training of teachers of domestic science &c., institutions in which public school children receive physical training. The city has grain elevators, and manufactures of bricks and tiles, foundry and machine shop products, carriages and wagons and flour. Menomonie is an important market for dairy products and livestock. Menomonie was settled about 1846 and was chartered as a city in 1882. The first free travelling library in the state was established here in 1896 by James Huff Stout.

MENSA and **MAREA**, semi-nomad pastoral tribes of Africans occupying part of the Abyssinian highlands included in the Italian colony of Eritrea, and the adjacent coast plains of the Red Sea. They have for neighbours the Habab and Beni-Amer tribes, as well as Abyssinians. The Mensa are found chiefly in the valley of the Khor Anseba, the Mensa dwelling farther north. These tribes claim Arab origin, tracing their descent from an uncle of the Prophet. Under Abyssinian rule they were Christians, but became Mahomedans in the 19th century. They speak a dialect of Tigrin (Abyssinian). On the death of a Marea the head of every dependent *tigré* or slave family must give his heirs a cow. The tribes avenge an illegitimate birth by putting parents and child to death.

MENSHIKOV, ALEXANDER DANILOVICH, PRINCE (1663?-1729), Russian statesman, was born not earlier than 1660 nor later than 1663. It is disputed whether his father was an ostler or a bargee. At the age of twenty he was gaining his livelihood in the streets of Moscow as a vendor of meat-pies. His handsome looks and smart sallies attracted the attention of François Lefort, Peter's first favourite, who took him into his service and finally transferred him to the tsar. On the death of Lefort, in 1699, Menshikov succeeded him as prime favourite. Ignorant, brutal, grasping and corrupt as he was, he deserved the confidence of his master. He could drill a regiment, build a frigate, administer a province, and decapitate a rebel with equal facility. During the tsar's first foreign tour, Menshikov worked by his side in the dockyards of Amsterdam, and acquired a thorough knowledge of colloquial Dutch and German. He took an active

¹ See W. L. Hoffman in the *Fourteenth Report* (Washington, 1896) of the Bureau of American Ethnology and A. E. Jenks in the *Nineteenth Report* (1900).

part in the Azov campaigns (1695-96), and superseded Ogilvie as commander-in-chief during the retreat before Charles XII. in 1708, subsequently participating in the battle of Holowczyn, the reduction of Mazepa, and the crowning victory of Poltava (June 26, 1709), where he won his marshal's bâton. From 1709 to 1714 he served during the Courland, Holstein and Pomeranian campaigns, but then, as governor-general of Ingria, with almost unlimited powers, was entrusted with a leading part in the civil administration. Menshikov understood perfectly the principles on which Peter's reforms were conducted, and was the right hand of the tsar in all his gigantic undertakings. But he abused his omnipotent position, and his deprivations frequently brought him to the verge of ruin. Every time the tsar returned to Russia he received fresh accusations of peculation against "his Serene Highness." Peter's first serious outburst of indignation (March 1711) was due to the prince's looting in Poland. On his return to Russia in 1712, Peter discovered that Menshikov had winked at wholesale corruptions in his own governor-generalship. Peter warned him "for the last time" to change his ways. Yet, in 1713, he was implicated in the famous Solov'ev process, in the course of which it was demonstrated that he had defrauded the government of 100,000 roubles.¹ He only owed his life on this occasion to a sudden illness. On his recovery Peter's fondness for his friend overcame his sense of justice. In the last year of Peter's reign fresh frauds and defalcations of Menshikov came to light, and he was obliged to appeal for protection to the empress Catherine. It was chiefly through the efforts of Menshikov and his colleague Tolstoi that, on the death of Peter, in 1725, Catherine was raised to the throne. Menshikov was committed to the Petrine system, and he recognized that, if that system were to continue, Catherine was, at that particular time, the only possible candidate. Her name was a watchword for the progressive faction. The placing of her on the throne meant a final victory over ancient prejudices, a vindication of the new ideas of progress. During her short reign (February 1725—May 1727), Menshikov was practically absolute. On the whole he ruled well, his difficult position serving as some restraint upon his natural inclinations. He contrived to prolong his power after Catherine's death by means of a forged will and a *coup d'état*. While his colleague Tolstoi would have raised Elizabeth Petrovna to the throne, Menshikov set up the youthful Peter II., son of the tsarevich Alexiush, with himself as dictator during the prince's minority. He now aimed at establishing himself definitely by marrying his daughter Mary to Peter II. But the old nobility, represented by the Dolgorukis and the Golitsiuns, united to overthrow him, and he was deprived of all his dignities and offices and expelled from the capital (Sept. 9, 1727). Subsequently he was deprived of his enormous wealth, and he and his whole family were banished to Berезov in Siberia, where he died on the 12th of November 1729.

See G. V. Esipov, *Biography of A. D. Menshikov* (Rus.) (St. Petersburg, 1875); N. A. Kosomarov, *The History of Russia in the biographies of her great Men* (Rus.), vol. ii. (St. Petersburg, 1888, &c.); R. Nisbet Bain, *The First Romanovs* (London, 1905); *ibid.* *The Pupils of Peter the Great*, ch. 2-4 (Westminster, 1897). (R. N. B.)

MENSHIKOV, ALEXANDER SERGEIEVICH, PRINCE (1787-1860), great-grandson of the preceding, was born on the 11th of September 1787, and entered the Russian service as attaché to the embassy at Vienna. He accompanied the emperor Alexander throughout his campaigns against Napoleon, and retired from army service in 1823. He then devoted himself

¹ The Solov'evs were three brothers ostensibly employed by the Russian government to ship corn from Russia and sell it at Amsterdam. As a matter of fact they were at the head of a combination for selling Menshikov's corn in preference to the corn of the Russian government and the bulk of the proceeds went into Menshikov's pockets. From 1709 to 1711 they had exported almost as much of Menshikov's corn as of that of the government, though the export of any corn from Russia, except in account of the Treasury, was a capital offence. The affair dragged on from 1713 to 1716, when the examination of the Solov'evs' books, and the subsequent application of torture, revealed the fact that the Solov'evs had systematically robbed the Treasury of 675,000 roubles (1 rouble then = 5s.) and had accumulated a fortune of half a million. For full details see Nisbet Bain, *The first Romanovs*, pp. 327-329.

to naval matters, became an admiral in 1834, and put the Russian navy, which had fallen into decay during the reign of Alexander, on an efficient footing. At the time of the dispute as to the Holy Places he was sent on a special mission to Constantinople, and when the Crimean war broke out he was appointed commander-in-chief by land and sea. He commanded the Russian army at the Alma and in the field operations round Sevastopol. In March 1855 he was recalled, ostensibly and perhaps really, on account of failing health. He died on the 2nd of May 1860 at St. Petersburg.

MENSURATION (Lat. *mensura*, a measure), the science of measurement; or, in a more limited sense, the science of numerical representation of geometrical magnitudes.

1. *Scope of the Subject.*—Even in the second sense, the term is a very wide one, since it comprises the measurement of angles (plane and solid), lengths, areas and volumes. The measurement of angles belongs to trigonometry, and it is convenient to regard the measurement of the lengths of straight lines (*i.e.* of distances between points) as belonging to geometry or trigonometry; while the measurement of curved lengths, except in certain special cases, involves the use of the integral calculus. The term "mensuration" is therefore ordinarily restricted to the measurement of areas and volumes, and of certain simple curved lengths, such as the circumference of a circle.

2. This restriction is to a certain extent arbitrary. The statement that, if the adjacent sides of a rectangle are represented numerically by 3 and 4, the diagonal is represented by 5, is as much a matter of mensuration as the statement that the area is represented by 12. The restriction is really determined by a difference in the methods of measurement. The distance between two points can, at any rate in theory, be measured directly, by successive applications of the unit of measurement. But an area or a volume cannot generally be measured by successive applications of the unit of area or volume; intermediate processes are necessary the result of which is expressed by a formula. The chief exception is in the use of liquid measure; this is of importance from the educational point of view (§ 12).

3. The measurement is *numerical*, *i.e.* it is representation in terms of a unit. The process of determining the area or volume of a given figure therefore involves two separate processes; viz. the direct measurement of certain magnitudes (usually lengths) in terms of a unit, and the application of a formula for determining the area or volume from these data. Mensuration is not concerned with the first of these two processes, which forms part of the art of measurement, but only with the second. It might, therefore, be described as that branch of mathematics which deals with formulæ for calculating the numerical measurements of curved lengths, areas and volumes, in terms of numerical data which determine these measurements.

4. It is also convenient to regard as coming under mensuration the consideration of certain derived magnitudes, such as the moment of a plane figure with regard to a straight line in its plane, the calculation of which involves formulæ which are closely related to formulæ for determining areas and volumes.

5. On the other hand, the scope of the subject, as described in § 3, is limited by the nature of the methods employed to obtain formulæ which can be applied to actual cases. Up to a certain point, formulæ of practical importance can be obtained by the use of elementary arithmetical or geometrical methods. Beyond this point, analytical methods must be adopted, and the student passes to trigonometry and the infinitesimal calculus. These investigations lead, in turn, to further formulæ, which, though not obtainable by elementary methods, are nevertheless simple in themselves and of practical utility. If these are included in the description "mensuration," the subject thus consists of two heterogeneous portions—elementary mensuration, comprising methods and results, and advanced mensuration, comprising certain results intended for practical application.

6. Mensuration, then, is mainly concerned with *quadrature-formulæ* and *cube-ture-formulæ*, and, to a not very clearly defined extent, with the methods of obtaining such formulæ; a quadrature-formula being a formula for calculating the numerical

representation of an area, and a cubature-formula being a formula for calculating the numerical representation of a volume, in terms, in each case, of the numerical representations of particular data which determine the area or the volume.

7. This use of formulae for dealing with numbers, which express magnitudes in terms of units, constitutes the broad difference between mensuration and ordinary geometry, which knows nothing of units. Mensuration involves the use of geometrical theorems, but it is not concerned with problems of geometrical construction. The area of a rectangle, for instance, is found by calculation from the lengths of the sides, not by construction of a square of equal area. On the other hand, it is worth noticing that the words "quadrature" and "cubature" are originally due to geometrical rather than numerical considerations; the former implying the construction of a square whose area shall be equal to that of a given surface, and the latter the construction of a cube whose volume shall be equal to that of a given solid.

8. There are two main groups of subjects in which practical needs have tended to develop a separate science of mensuration. The first group comprises such subjects as land-surveying; here the measurements in the elementary stages take place in a plane, and the consideration of volumes necessarily constitutes a later stage; and the figures to be measured are mostly not movable, so that triangulation plays an important part. The second group comprises the mechanic arts, in which the bodies to be measured are solid bodies which can be handled; in these cases plane figures appear mainly as sections of a solid. In developing a system of mensuration-formulae the importance of this latter group of cases must not be overlooked.

A third group, of increasing importance, comprises cases in which curves or surfaces arise out of the application of graphic methods in engineering, physics and statistics. The general formulae applicable to these cases are largely approximate.

9. *Relation to other Subjects.*—As a result of the importance both of the formulae obtained by elementary methods and of those which have involved the previous use of analysis, there is a tendency to dissociate the former, like the latter, from the methods by which they have been obtained, and to regard mensuration as consisting of those mathematical formulae which are concerned with the measurement of geometrical magnitudes (including lengths), or, in a slightly wider sense, as being the art of applying these formulae to specific cases. Such a body of formulae cannot, of course, be regarded as constituting a science; it has no power of development from within, and can only grow by accretion. It may be of extreme importance for practical purposes; but its educational value, if it is studied apart from the methods by which the formulae are obtained, is slight. Vitality can only be retained by close association with more abstract branches of mathematics.

10. On the other hand, mensuration, in its practical aspect, is of importance for giving reality to the formulae themselves and to the principles on which they are based. This applies not only to the geometrical principles but also to the arithmetical principles, and it is therefore of importance, in the earlier stages, to keep geometry, mensuration and arithmetic in close association with one another; mensuration forming, in fact, the link between arithmetic and geometry.

11. It is in reference to the measurement of areas and volumes that it is of special importance to illustrate geometrical truths by means of concrete cases. That the area of a parallelogram is equal to the area of a rectangle on the same base and between the same parallels, or that the volume of a cone is one-third that of a cylinder on the same base and of the same height, may be established by a proof which is admitted to be rigorous, or be accepted in good faith without proof, and yet fail to be a matter of conviction, even though there may be a clear conception of the relative lengths of the diagonal and the side of a square or of the relative contents of two vessels of different shapes. The failure seems (§ 2) to be due to difficulty in realizing the numerical expression of an area or a solid in terms of a specified unit, while

the same difficulty does not arise in the case of linear measure or liquid measure, where the number of units can be ascertained by direct counting. The difficulty is perhaps less for volumes than for areas, on account of the close relationship between solid and fluid measure.

12. The main object to be aimed at, therefore, in the study of elementary mensuration, is that the student should realize the possibility of the numerical expression of areas and volumes. The following are some important points.

(i) The double aspect of an area should be borne in mind; *i.e.* area should be treated not only as length multiplied by length, but also as volume divided by thickness. There are, indeed, certain advantages in preferring the latter to the former, and in proceeding from volumes to areas rather than from areas to volumes. While, for instance, it may be difficult to realize the equality of area of two plots of ground of different shapes, it may be easy to realize the equality of the amounts of a given material that would be required to cover them to a particular depth. This method is unconsciously adopted by the teacher who illustrates the equality of area of two geometrical figures by cutting them out of cardboard of uniform thickness and weighing them.

(ii) The very earliest stages of mensuration should be directly associated with simple arithmetical processes.

(iii) Association of solid measure with liquid measure, presenting numerical measurement in a different aspect, should be retained by testing volumes as found from linear dimensions with the volumes of the same bodies as found by the use of measures of capacity. Here, as usual, the British systems of measures produce a difficulty which would not arise under the metric system.

(iv) Solids of the same substance should be compared by measuring and also by weighing; the comparison being then extended to areas of uniform thickness (see (i) above).

(v) The idea of an *average* may be introduced at an early stage, methods of calculating an average being left to a later stage.

13. *Classification.*—The methods of mensuration fall for the most part under one or other of three main heads, *viz.* arithmetical mensuration, geometrical mensuration, and analytical mensuration.

14. The most elementary stage is arithmetical mensuration, which comprises the measurement of the areas of rectangles and parallelepipeds. This may be introduced very early; square tablets being used for the mensuration of areas, and cubical blocks for the mensuration of volumes. The measure of the area of a rectangle is thus presented as the product of the measures of the sides, and arithmetic and mensuration are developed concurrently. The commutative law for multiplication is directly illustrated; and subdivisions or groupings of the units lead to such formulae as $(a + \alpha)(b + \beta) = ab + \alpha\beta + a\beta + \alpha b$. Association with other branches of science is maintained by such methods as those mentioned in § 12.

The use of the square bricks familiarizes the scholar with the ideas of parallel lines, of equality of lengths, and of right angles. The conception of the right angle is strengthened, by contrast, by the use of bricks in the form of a rhombus.

15. The next stage is geometrical mensuration, where geometrical methods are applied to determine the areas of plane rectilinear figures and the volumes of solids with plane faces. The ordinary process involves three separate steps. The first step is the establishment of the exact equality of *congruence* of two geometrical figures. In the case of plane figures, the congruence is tested by an imaginary superposition of one figure on the other; but this may more simply be regarded as the superposition, on either figure, of the image of the other figure on a contiguous plane. In the case of solid figures a more difficult geometrical abstraction is involved. The second step is the conversion of one figure into another by a process of *disection*, followed by rearrangement of parts; the figure as rearranged being one whose area or volume can be calculated by methods already established. This is the process adopted, for instance, for comparison of the area of a parallelogram with that of a rectangle on the same base and of the same height. The third step is the arithmetical calculation of the area or volume of the rearranged figure. These last two steps may introduce magnitudes which have to be subtracted, and which therefore have to be treated as negative quantities in the arithmetical calculation.

The difficulties to which reference has been made in § 11 are largely due to the abstract nature of the process involved in the second of the above steps. The difficulty should, wherever possible, be removed by making the process of dissection and rearrangement complete. This is not always done. To say, for instance, that the area of a right-angled triangle is half the area of the rectangle contained by the two sides, is not to say what the area is, but what it is the half of. The proper statement is that, if a and b are the sides, the area is equal to the area of a rectangle whose sides are a and $\frac{1}{2}b$; this being, in fact, a particular case of the proposition that the area of a trapezium is equal to the area of a rectangle whose sides are its breadth and the arithmetic mean of the lengths of the two parallel sides. This mode of statement helps to establish the idea of an average. The deduction of the formula $\frac{1}{2}ab$, where a and b are numbers, should be regarded as a later step.

Elementary trigonometrical formulae, not involving the conception of an angle as generated by rotation, belong to this stage; the additional geometrical idea involved being that of the proportionality of the sides of similar triangles.

16. The third stage is analytical mensuration, the essential feature of which is that account is taken of the manner in which a figure is generated. To prevent discontinuity of results at this stage, recapitulation from an analytical point of view is desirable. The rectangle, for instance, has so far been regarded as a plane figure bounded by one pair of parallel straight lines and another pair at right angles to them, so that the conception of "rectangularity" has had reference to boundary rather than to content; analytically, the rectangle must be regarded as the figure generated by an ordinate of constant length moving parallel to itself with one extremity on a straight line perpendicular to it. This is the simplest case of generation of a plane figure by a moving ordinate; the corresponding figure for generation by rotation of a radius vector is a circle.

To regard a figure as being generated in a particular way is essentially the same as to regard it as being made up of a number of successive elements, so that the analytical treatment involves the ideas and the methods of the infinitesimal calculus. It is not, however, necessary that the notation of the calculus should be employed throughout.

A plane figure bounded by a continuous curve, or a solid figure bounded by a continuous surface, may generally be most conveniently regarded as generated by a straight line, or a plane area, moving in a fixed direction at right angles to itself, and changing as it moves. This involves the use of Cartesian co-ordinates, and leads to important general formulae, such as Simpson's formula.

The treatment of an angle as generated by rotation, the investigation of the relations between trigonometrical ratios and circular measure, the application of interpolation to trigonometrical tables, and the general use of graphical methods to represent continuous variation, all imply an analytical outlook, and must therefore be deferred to this stage.

17. There are certain special cases where the treatment is really analytical, but where, on account of the simplicity or importance of the figures involved, the analysis does not take a prominent part.

(i) The circle, and the solid figures allied to it, are of special importance. The ordinary definition of a circle is equivalent to definition as the figure generated by the rotation of a radius of constant length in a plane, and is thus essentially analytical. The ideas of the centre and of the constancy of the radius do not, however, enter into the elementary conception of the circle as a round figure. This elementary conception is of the figure as already existing, rather than of its method of description; the test of circularity being the possibility of rotation within a surrounding figure so as to keep the two boundaries always completely in contact. In the same way, the elementary conception of the sphere involves the idea of sphericity, which would be tested in a similar way, and is in fact so tested, at an early stage by tactual perception, and at a more advanced stage by mechanical methods; the next step being the circularity of the central section, as roughly tested (where the sphere is small) by visual perception, *i.e.* in effect, by the circularity of the cross-section of a circumscribing cylinder; and the ideas of the centre and of non-central sections follow later.

It seems to follow that the consideration of the area of a circle should precede the consideration of its perimeter, and that the

consideration of the volume of a sphere should precede the consideration of its surface-area. The proof that the area of a circle is proportional to the square of its diameter would therefore precede the proof that the perimeter is proportional to the diameter; the former property is the easier to grasp, since the conception of the length of a curved line as the limit of the sum of a number of straight lengths presents special difficulties. The ratio $\frac{1}{2}\pi$ would thus first appear as the ratio of the average breadth of a circle to the greatest breadth; the interpretation of π as the ratio of the circumference to the diameter being a secondary one. This order follows, in fact, the historical order of development of the subject.

(ii) Developable surfaces, such as the cylinder and the cone, form a special class, so far as the calculation of their area is concerned. The process of unrolling is analytical, but the unrolled area can be measured by methods not applicable to other surfaces.

(iii) Solids of revolution also form a special class, which can be conveniently treated by the two theorems of Pappus (§ 33).

18. The above classification relates to methods. The classification of results, *i.e.* of formulae, will depend on the purpose for which the collection of formulae is required, and may involve the grouping of results obtained by very different methods. A collection of formulae relating to the circle, for instance, would comprise not only geometrical and trigonometrical formulae, but also approximate formulae, such as Huygens's rule (§ 91), which are the result of advanced analysis.

The present article is not intended to give either a complete course of study or a complete collection of formulae, and therefore such only of the ordinary formulae are given as are required for illustrating certain general principles. For fuller discussion reference should be made to GEOMETRY and TRIGONOMETRY, as well as to the articles dealing with particular figures, such as TRIANGLE, CIRCLE, &c.

19. The most important formulae are those which correspond to the use of rectangular Cartesian co-ordinates. This implies the treatment of a plane or solid figure as being wholly comprised between two parallel lines or planes, regarded by convention as being vertical; the figure being generated by an ordinate or section moving at right angles to itself through a distance which is called the *breadth* of the figure. The length or area obtained by dividing the area or the volume of the figure by its breadth is the *mean ordinate* (mean height) or *mean section* (mean sectional area) of the figure.

Quadrature-formulae or cubature-formulae may sometimes be conveniently replaced by formulae giving the mean ordinate or mean section. In the early stages it is best to use both methods, so as to develop the idea of an average (§ 12). In the present article the formulae for area or volume will be used throughout.

20. *Approximation.*—The numerical result obtained by applying a formula to particular data will generally not be exact. There are two kinds of causes producing want of exactness.

(i) The formula itself may not be numerically exact. This may happen in either of two ways.

(a) The formula may involve numbers or ratios which cannot be expressed exactly in the ordinary notation. This is the case, for instance, with formulae which involve π or trigonometrical ratios. This inexactness may, however, be ignored, since the numbers or ratios in question can generally be obtained to a greater degree of accuracy than the other numbers involved in the calculation (see (ii) (b) below).

(b) The formula may only be approximative. The length of the arc of a circle, for instance, is known if the length of the chord and its distance from the middle point of the arc are known; but it may be more convenient in such a case to use a formula such as Huygens's rule than to obtain a more accurate result by means of trigonometrical tables.

(ii) The data may be such that an exact result is impossible.

(a) The nature of the bounding curve or surface may not be exactly known, so that certain assumptions have to be made, a formula being then used which is adapted to these assumptions. The application of Simpson's rule, for instance, to a plane figure implies certain assumptions as to the nature of the bounding curve. Such a formula is approximative, in that it is known that the result of its application will only be approximately correct; it differs from an approximative formula of the kind mentioned in (i) (b) above, in that it is adopted of necessity, not by choice.

(b) It must, however, be remembered that in all practical applications of formulae the data have first to be ascertained by direct or indirect measurement; and this measurement involves a certain margin of error.

The two sources of error mentioned under (a) and (b) above are closely related. Suppose, for instance, that we require the area of a circular grass-plot of measured diameter. As a matter of fact, no grass-plot is truly circular; and it might be found that if the breadth in various directions were measured more accurately the want of circularity would reveal itself. Thus the inaccuracy in taking the measured diameter of the datum is practically of the same order as the inaccuracy in taking the grass-plot to be circular.

(iii) In dealing with cases where actual measurements are involved, the error (i) due to inaccuracy of the formula will often be negligible in comparison with the error (ii) due to inaccuracy of the data. For this reason, formulae which will only give approximate results are usually classed together as *rules*, whether the inaccuracy lies (as in the case of Huygens's rule) in the formula itself, or (as in the case of Simpson's rule) in its application to the data.

21. It is necessary, in applying formulae to specific cases, not only, on the one hand, to remember that the measurements are only approximate, but also, on the other hand, to give to any ratio such as π a value which is at least more accurate than the measurements. Suppose, for instance, that in the example given in § 20 the diameter as measured is 15 $\frac{1}{2}$ in. If we take $\pi = 3.14$ and find the area to be 26288.865 sq. in. = 182 sq. ft. 80.865 sq. in., we make two separate mistakes. The main mistake is in giving the result as true to a small fraction of a square inch; but, if this degree of accuracy had been possible, it would have been wrong to give π a value which is in error by more than 1 in 2000.

Calculations involving feet and inches are sometimes performed by means of *duodecimal arithmetic*; i.e., in effect, the tables of square measure and of cubic measure are amplified by the insertion of intermediate units. For square measure—

- 12 square inches = 1 superficial prime,
- 12 superficial primes = 1 square foot;
- while for cubic measure—
- 12 cubic inches = 1 solid second,
- 12 solid seconds = 1 solid prime,
- 12 solid primes = 1 cubic foot.

When an area has been calculated in terms of square feet, primes and square inches, the primes and square inches have to be reduced to square inches; and similarly with the calculation of volumes. The value of π for duodecimal arithmetic is $3 + \frac{1}{12} + \frac{8}{12^2} + \frac{4}{12^3} + \frac{8}{12^4} + \dots$; so that, marking off duodecimal fractions by commas, the area in the above case is $\frac{1}{4}$ of 3, 1, 8, 4, 8X15, 3X15, 3 sq. ft. = 182, 7, 10 sq. ft. = 182 sq. ft. 94 sq. in. (or 182 $\frac{1}{2}$ sq. ft. approximately).

MENSURATION OF SPECIFIC FIGURES (GEOMETRICAL)

22. *Areas of Plane Rectilinear Figures.*—The following are expressions for the areas of some simple figures; the expressions in (i) and (ii) are obtained arithmetically, while those in (iii)–(v) involve dissection and rearrangement.

- (i) Square: sides a . Area = a^2 .
- (ii) Rectangle: sides a and b . Area = ab .
- (iii) Right-angled triangle: sides a and b , enclosing the right angle. Area = $\frac{1}{2}ab$.
- (iv) Parallelogram: two opposite sides a and a , distance between them h . Area = ha .
- (v) Triangle: one side a , distant h from the opposite angle. Area = $\frac{1}{2}ha$.

If the data for any of these figures are other than those given above, trigonometrical ratios will usually be involved. If, for instance, the data for the triangle are sides a and b , enclosing an angle C , the area is $\frac{1}{2}ab \sin C$.

23. The figures considered in § 22 are particular cases of the *trapezium*, which is a quadrilateral with two parallel sides. If these sides are a and b , at distance h from one another, the area is $\frac{1}{2}(a+b)h$. In the case of the triangle, for instance, b is zero, so that the area is $\frac{1}{2}ha$.

The trapezium is also sometimes called a "trapezoid," but it will be convenient to reserve this term for a different figure (§ 24).

The most important form of trapezium is that in which one of the two remaining sides of the figure is at right angles to the two parallel sides. The trapezium is then a *right trapezium*; the two parallel sides are called the *sides*, the side at right angles to them the *base*, and the fourth side the *top*.

By producing the two parallel sides of any trapezium (e.g. a parallelogram), and drawing a line at right angles to them, outside the figure, we see that it may be treated as the difference of two right trapezia.

It is, however, more simple to convert it into a single right trapezium. Let CABD (fig. 1) be a trapezium, the sides CA and DB being parallel. Draw any straight line at right angles to CA and DB (produced if necessary), meeting them in M and N. Along CA and DB, on the same side of MN, take MA' = CA, NB' = DB; and

join A'B'. Then MA'B'N is a right trapezium, whose area is equal to that of CABD; and it is related to the latter in such a way that, if any two lines parallel to AC and BD meet AB, CD, MN, A'B', in E, G, P, E', and F, H, Q, F', respectively, the area of the piece PE'F'Q of the right trapezium is equal to the area of the piece GE'FH of the original trapezium. The right trapezium so constructed may be called the *equivalent right trapezium*. In the case of a parallelogram, the equivalent right trapezium is a rectangle; in the case of a triangle, it is a right-angled triangle.

24. If we take a series of right trapezia, such that one side (§ 23) of the first is equal to one side of the second, the other side of the second is equal to one side of the third, and so on, and place them with their bases in a straight line and their equal sides adjoining each other, we get a figure such as ABCDEFGH (fig. 2), which has two parallel sides MA and SF, a base MS at right angles to these, and the remainder of its boundary from A to F rectilinear, no part of the figure being outside the space between MA (produced) and SF (produced). A figure of this kind will be called a *trapezoid*.

(i) If from the other angular points B, C, D, E, perpendiculars BN, CP, DQ, ER, are drawn to the base MS (fig. 2), the area is $\frac{1}{2}(MA + NB + NC + ND + NE + NF) \cdot MS$ = $\frac{1}{2}(MN + NP + PC + \dots + RS) \cdot (ME + SF + \dots)$ = $\frac{1}{2}(MN \cdot MA + MP \cdot NB + NP \cdot QC + \dots + RS \cdot SF)$. The lines MA, NB, PC, . . . are called the *ordinates* of the points A, B, C, . . . from the base MS, and the portions MN, NP, PQ, . . . of the base are the *projections* of the sides AB, BC, CD, . . . on the base.

(ii) A special case is that in which A coincides with M, and F with S. The figure then stands on a base MS, the remainder of its boundary being a broken line from M to S. The formula then becomes

$$\text{area} = \frac{1}{2}(MP \cdot NB + NQ \cdot PC + \dots + QS \cdot RE),$$

i.e. the area is half the sum of the products obtained by multiplying each ordinate by the distance between the two adjacent ordinates. It would be possible to regard this form of the figure as the general one; the figure considered in (i) would then represent the special case in which the two end-pieces of the broken line are at right angles to the base.

(iii) Another special case is that in which the distances MN, NP, PQ, . . . RS are all equal. If this distance is h , then

$$\text{area} = h(\frac{1}{2}MA + NB + PC + \dots + SF).$$

25. To find the area of any rectilinear figure, various methods are available.

(i) The figure may be divided into triangles. The quadrilateral, for instance, consists of two triangles, and its area is the product of half the length of one diagonal by the sum of the perpendiculars drawn to this diagonal from the other two angular points.

For figures of more than four sides this method is not usually convenient, except for such special cases as that of a regular polygon, which can be divided into triangles by radii drawn from its centre.

(ii) Suppose that two angular points, A and E, are joined (fig. 3) so as to form a diagonal AE, and that the whole of the figure lies between lines through A and E at right angles to AE. Then the figure is (usually) the sum of two trapezoids on base AE, and its area can be calculated as in § 24. If BN, CP, DQ, . . . FS, GT are the perpendiculars to AE from the angular points, the ordinates NB, PC, . . . are called the *offsets* from the diagonal to the angular points. The area of the polygon in fig. 3 is given by the expression

$$\frac{1}{2}(AP \cdot NB + NQ \cdot PC + PE \cdot QD + ET \cdot SF + SA \cdot TG).$$

It should be noted (a) that AP, NQ, . . . SA are taken in the cyclical order of the points ABC . . . GA, and (b) that in fig. 3, if AN and NB are regarded as positive, then SF, TG, ET and SA are negative, but the products ET.SF and SA.TG are positive. Negative products will arise if in moving from A to E along the perimeter of either side of the figure the projection of the moving point does not always move in the direction AE.

(iii) Take any straight line intersecting or not intersecting the figure, and draw perpendiculars AA', BB', CC', DD', . . . FF', GG' to this line. Then, with proper attention to signs,

$$\text{area} = \frac{1}{2}(gB \cdot aA' + aC' \cdot bB' + bD' \cdot cC' + \dots + fG \cdot gG').$$

(iv) The figure may be replaced by an *equivalent trapezoid*, on the system explained in § 23. Take any base X'X'', and draw lines at right angles to this base through all the angular points of the figure.

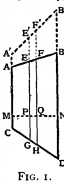

FIG. 1.

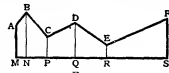

FIG. 2.

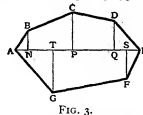

FIG. 3.

Let the lines through B, G, C, D and F (fig. 4) cut the boundary of the figure again in B', G', C', D' and F', and meet the base XX in K, L, M, N and P; the points A and E being at the extremities of the figure, and the lines through them meeting the base in a and e. Then, if we take ordinates Kk, Lg, M, Nd, Pf, equal to B'B, G'G', C'C', D'D', FF', the figure *abcdefe* will be the equivalent trapezoid, and any ordinate drawn from the base to the top of this trapezoid will be equal to the portion of this ordinate (produced) which falls

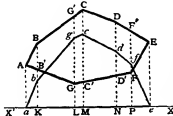

FIG. 4.

within the original figure.

26. *Volumes of Solids with Plane Faces*.—The following are expressions for the volumes of some simple solid figures.

- (i) Cube: side *a*. Volume = a^3 .
- (ii) Rectangular parallelepiped: sides *a*, *b*, *c*. Volume = abc .
- (iii) Right prism. Volume = length of edge \times area of end.
- (iv) Oblique prism. Volume = height \times area of end = length of edge \times area of cross-section; the "height" being the perpendicular distance between the two ends.

The parallelepiped is a particular case.

(v) Pyramid with rectilinear base. Volume = height $\times \frac{1}{3}$ area of base.

The tetrahedron is a particular case.

(vi) Wedge: parallel edges *a*, *b*, *c*; area of cross-section *S*. Volume = $\frac{1}{6}(a+b+c)S$.

This formula holds for the general case in which the base is a trapezium; the wedge being thus formed by cutting a triangular prism by any two planes.

(vii) Frustum of pyramid with rectilinear base: height *h*; areas of ends (*i.e.* base and top) *A* and *B*. Volume = $\frac{1}{3}(A+\sqrt{AB}+B)h$.

27. The figures considered in § 26 are particular cases of the *prismoid* (or *prismatoid*), which may be defined as a solid figure with two parallel plane rectilinear ends, each of the other (*i.e.* the lateral) faces being a triangle with an angular point in one end of the figure and its opposite side in the other. Two adjoining faces in the same plane may together make a trapezium. More briefly, the figure may be defined as a polyhedron with two parallel faces containing all the vertices.

If *R* and *S* are the ends of a prismoid, *A* and *B* their areas, *h* the perpendicular distance between them, and *C* the area of a section by a plane parallel to *R* and *S* and midway between them, the volume of the prismoid is

$$\frac{1}{6}h(A+4C+B).$$

This is known as the *prismoid formula*.

The formula is a deduction from a general formula, considered later (§ 58), and may be verified in various ways. The most instructive is to regard the prismoid as built up (by addition or subtraction) of simpler figures, which are particular cases of it.

(i) Let *R* and *S* be the vertex and the base of a pyramid. Then *A* = 0, *C* = $\frac{1}{2}B$, and volume = $\frac{1}{6}hB = \frac{1}{6}h(A+4C+B)$. The tetrahedron is a particular case.

(ii) Let *R* be one edge of a wedge with parallel ends, and *S* the face containing the other two edges. Then *A* = 0, *C* = $\frac{1}{2}B$, and volume = $\frac{1}{6}hB = \frac{1}{6}h(A+4C+B)$.

(iii) Let *R* and *S* be two opposite edges of a tetrahedron. Then the tetrahedron may be regarded as the difference of a wedge with parallel ends, one of the edges being *R*, and a pyramid whose base is a parallelogram, one side of the parallelogram being *S* (see fig. 9, § 58). Hence, by (i) and (ii), the formula holds for this figure.

(iv) For the prismoid in general let *ABCD* ... be one end, and *abcd* ... the other. Take any point *P* in the latter, and form triangles by joining *P* to each of the sides *AB*, *BC*, ... *ab*, *bc*, ... of the ends, and also to each of the edges. Then the prismoid is divided into a pyramid with vertex *P* and base *ABCD* ... and a series of tetrahedra, such as *PABa* or *PaBb*. By (i) and (ii), the formula holds for each of these figures; and therefore it holds for the prismoid as a whole.

Another method of verifying the formula is to take a point *Q* in the mid-section, and divide up the prismoid into two pyramids with vertex *Q* and bases *ABCD* ... and *abcd* ... respectively, and a series of tetrahedra having *Q* as one vertex.

28. *The Circle and Allied Figures*.—The mensuration of the circle is founded on the property that the areas of different circles are proportional to the squares on their diameters.

Denoting the constant ratio by $\frac{1}{4}\pi$, the area of a circle is πa^2 , where *a* is the radius, and $\pi = 3.14159$ approximately. The expression $2\pi a$ for the length of the circumference can be deduced by considering the limit of the area cut off from a circle of radius *a* by a concentric circle of radius *a* - *c*, when *a* becomes indefinitely small; this is an elementary case of differentiation.

The lengths of arcs of the same circle being proportional to the

angles subtended by them at the centre, we get the idea of circular measure.

Let *O* be the common centre of two circles, of radii *a* and *b*, and let radii enclosing an angle θ (circular measure) cut their circumferences in *A*, *B* and *C*, *D* respectively (fig. 5). Then the area of *ABDC* is

$$\frac{1}{2}b^2\theta - \frac{1}{2}a^2\theta = (b-a)\frac{1}{2}\theta(b+a)\theta.$$

If we bisect *AB* and *CD* in *P* and *Q* respectively, and describe the arc *PQ* of a circle with *P* and *Q* respectively, and describe the arcs *APQ* of a circle with *P* and *Q* respectively, the area of this arc is $\frac{1}{2}(b-a)\theta$, and $b-a = AB$. Hence area *ABDC* = *AB* \times arc *PQ*. The figure *ABDC* is a sector of an *annulus*, which is the portion of a circle left after cutting out a concentric circle.

29. By considering the circle as the limit of a polygon, it follows that the formulæ (iii) and (v) of § 26 hold for a right circular cylinder and a right circular cone; *i.e.*

volume of right circular cylinder = length \times area of base;

volume of right circular cone = height $\times \frac{1}{3}$ area of base.

These formulæ also hold for any right cylinder and any cone.

30. The curved surfaces of the cylinder and of the cone are *developable surfaces*; *i.e.* they can be unrolled on a plane. The curved surface of any right cylinder (whether circular or not) becomes a rectangle, and therefore its area = length \times perimeter of base. The curved surface of a right circular cone becomes a sector of a circle, and its area = $\frac{1}{2}$ slant height \times perimeter of base.

31. If *a* is the radius of a sphere, then

(i) volume of sphere = $\frac{4}{3}\pi a^3$;

(ii) surface of sphere = $4\pi a^2$ = curved surface of circumscribing cylinder.

The first of these is a particular case of the prismoidal formula (§ 58). To obtain (i) and (ii) together, we show that the volume of a sphere is proportional to the volume of the cube whose edge is the diameter; denoting the constant ratio by $\frac{1}{6}$, the volume of the sphere is $\frac{1}{6}d^3$, and thence, by taking two concentric spheres (cf. § 28), the area of the surface is $3\pi d^2$. This surface may be split up into elements, each of which is equal to a corresponding element of the curved surface of the circumscribing cylinder, so that $3\pi d^2$ = curved surface of cylinder = $2a \cdot 2\pi a = 4\pi a^2$. Hence $\lambda = \frac{4}{3}\pi$.

The total surface of the cylinder is $4\pi a^2 + \pi d^2 = 6\pi a^2$, and its volume is $2a \cdot \pi a^2 = 2\pi a^3$. Hence

volume of sphere = $\frac{2}{3}$ volume of circumscribing cylinder;

surface of sphere = $\frac{2}{3}$ surface of circumscribing cylinder.

These latter formulæ are due to Archimedes.

32. *Moments and Centroids*.—For every material body there is a point, fixed with regard to the body, such that the moment of the body with regard to any plane is the same as if the whole mass were collected at that point; the moment being the sum of the products of each element of mass of the body by its distance from the plane. This point is the *centroid* of the body.

The areas of moment and of centroid are extended to geometrical figures, whether solid, superficial or linear. The *moment* of a figure with regard to a plane is found by dividing the figure into elements of volume, area or length, multiplying each element by its distance from the plane, and adding the products. In the case of a plane area or a plane continuous line the moment with regard to a straight line in the plane is the same as the moment with regard to a perpendicular plane through this line; *i.e.* it is the sum of the products of each element of area or length by its distance from the straight line. The *centroid* of a figure is a point fixed with regard to the figure, and such that its moment with regard to any plane (or, in the case of a plane area or line, with regard to any line in the plane) is the same as if the whole volume, area or length were concentrated at this point. The centroid is sometimes called the centre of volume, centre of area, or centre of arc. The proof of the existence of the centroid of a figure is the same as the proof of the existence of the centre of gravity of a body. (See MECHANICS.)

The moment as described above is sometimes called the *first moment*. The *second moment*, *third moment*, ... of a plane or solid figure are found in the same way by multiplying each element by the square, cube, ... of its distance from the line or plane with regard to which the moments are being taken.

If we divide the first, second, third, ... moments by the total volume, area or length of the figure, we get the *mean distance*, *mean square of distance*, *mean cube of distance*, ... of the figure from the line or plane. The mean distance of a plane figure from a line in its plane, or of any figure from a plane, is therefore the same as the distance of the centroid of the figure from the line or plane.

We sometimes require the moments with regard to a line or plane through the centroid. If *N*₀ is the area of a plane figure, and *N*₁, *N*₂, ... are its moments with regard to a line in its plane, the moments *M*₁, *M*₂, ... with regard to a parallel line through the centroid are given by

$$M_1 = N_0 - x^2 N_0 = 0,$$

$$M_2 = N_0 - 2xN_1 + x^2 N_0 = N_0 - x^2 N_0,$$

$$\dots$$

$$M_n = N_0 - nxN_{n-1} + \frac{n(n-1)}{2!}x^2N_{n-2} - \dots + (-)^{n-1}\frac{1}{2}x^{n-1}N_1 + (-)^n x^n N_0;$$

where x = the distance between the two lines = N_1/N_2 . These formulae also hold for converting moments of a solid figure with regard to a plane into moments with regard to a parallel plane through the centroid; x being the distance between the two planes. A line through the centroid of a plane figure (drawn in the plane of the figure) is a *central line*, and a plane through the centroid of a solid figure is a *central plane* of the figure.

The centroid of a triangle is its centre, i.e. the point of intersection of its diagonals. The first moment of a plane figure with regard to a line in its plane may be regarded as obtained by dividing the area into elementary strips by a series of parallel lines indefinitely close together, and concentrating the area of each strip at its centre. Similarly the first moment of a solid figure may be regarded as obtained by dividing the figure into elementary prisms by two sets of parallel planes, and concentrating the volume of each prism at its centre. This also holds for higher moments, provided that the edges of the elementary strips or prisms are parallel to the line or plane with regard to which the moments are taken.

33. *Solids and Surfaces of Revolution.*—The solid or surface generated by the revolution of a plane closed figure or a plane continuous line about a straight line in its plane, not intersecting it, is a *solid of revolution* or *surface of revolution*, the straight line being its axis. The revolution need not be complete, but may be through any angle.

The section of a solid of revolution by a plane at right angles to the axis is an annulus or a sector of an annulus (fig. 5), or is composed of two or more such figures. If the solid is divided into elements by a series of such planes, and if h is the distance between two consecutive planes making sections such as ABCD in fig. 5, the volume of the element between these planes, when h is very small, is approximately $h \times AB \times \text{arc PQ} = h \cdot AB \cdot OP \cdot \theta$. The corresponding element of the revolving figure is approximately a rectangle of area $h \cdot AB$, and OP is the distance of the middle point of either side of the rectangle from the axis. Hence the total volume of the solid is $M \cdot \theta$, where M is the sum of the quantities $h \cdot AB \cdot OP$, i.e. is the moment of the figure with regard to the axis. The volume is therefore equal to $S \cdot \bar{y} \cdot \theta$, where S is the area of the revolving figure, and \bar{y} is the distance of its centroid from the axis.

Similarly a surface of revolution can be divided by planes at right angles to the axis into elements, each of which is approximately a section of the surface of a right circular cone. By unrolling each such element (§ 30) into a sector of a circular annulus, it will be found that the total area of the surface is $M' \cdot \theta = L \cdot \bar{x} \cdot \theta$, where M' is the moment of the original curve with regard to the axis, L is the total length of the original curve, and \bar{x} is the distance of the centroid of the curve from the axis. These two theorems may be stated as follows:—

(i) If any plane figure revolves about an external axis in its plane, the volume of the solid generated by the revolution is equal to the product of the area of the figure and the distance travelled by the centroid of the figure.

(ii) If any line in a plane revolves about an external axis in the plane, the area of the curved surface generated by the revolution is equal to the product of the length of the line and the distance travelled by the centroid of the line.

These theorems were discovered by Pappus of Alexandria (c. A.D. 300), and were made generally known by Guldinus (c. A.D. 1640). They are sometimes known as *Guldinus's Theorems*, but are more properly described as the *Theorems of Pappus*. The theorems are of use, not only for finding the volumes or areas of solids or surfaces of revolution, but also, conversely, for finding centroids or centres of gravity. They may be applied, for instance, to finding the centroid of a parabolic arc or of the area of a semiparabola.

24. *Segment of Parabola.*—The parabola affords a simple example of the use of infinitesimals. Let AB (fig. 6) be any arc of a parabola; and suppose we require the area of the figure bounded by this arc and the chord AB.

Draw the tangents at A and B, meeting at T; draw TV parallel to the axis of the parabola, meeting the arc in C and the chord in V; and draw the tangent at C, meeting AT and BT in a and b. Then (see PARABOLA) TC = CV, AV = VB, and Ab is parallel to AB, so that $aC = Cb$. Hence area of triangle ACB = twice area of triangle aCb. Repeating the process with the areas AC and CB, and continuing the repetition indefinitely, we divide up the required area and the remainder of the triangle ATB into corresponding elements, each element of the former being double the corresponding elements of the latter. Hence the required area is double the area of the remainder of the triangle, and therefore it is two-thirds of the area of the triangle.

The line TCv is parallel to the axis of the parabola. If we draw a line at right angles to TCv, meeting TCv produced in M and parallels through A and B in K and L, the area of the triangle ATB is $\frac{1}{2}KL \cdot TV = KL \cdot CV$; and therefore the area of the figure bounded by AK, BL, KL and the arc AB, is

$$\begin{aligned} & KL \cdot \frac{1}{2}(AK + BL) + \frac{1}{2}KL \cdot [CM - \frac{1}{2}(AK + BL)] \\ & = \frac{1}{2}KL(AK + 4CM + BL). \end{aligned}$$

Similarly, for a corresponding figure K'L'BA outside the parabola, the area is

$$\frac{1}{2}K'L'(K'A + 4M'C + L'B).$$

35. *The Ellipse and the Ellipsoid.*—For elementary mensuration the ellipse is to be regarded as obtained by projection of the circle, and the ellipsoid by projection of the sphere. Hence the area of an ellipse whose axes are $2a$ and $2b$ is πab ; and the volume of an ellipsoid whose axes are $2a$, $2b$ and $2c$ is $\frac{4}{3}\pi abc$. The area of a strip of an ellipse between two lines parallel to an axis, or the volume of the portion (frustum) of an ellipsoid between two planes parallel to a principal section, may be found in the same way.

36. *Examples of Applications.*—The formulae of § 24 for the area of a trapezoid are of special importance in *land-surveying*. The measurements of a polygonal field or other area are usually taken as in § 25 (ii); diagonal AE is taken as the base-line, and for the points B, C, D, . . . there are entered the distances AN, AP, AQ, . . . along the base-line, and the lengths and directions of the offsets NB, PC, QD, . . . The area is then given by the formula of § 25 (ii).

37. The mensuration of *earthwork* involves consideration of quadrilaterals whose dimensions are given by special data, and of prismoids whose sections are such quadrilaterals. In the ordinary case three of the four lateral surfaces of the prismoid are at right angles to the two ends. In special cases two of these three lateral surfaces are equally inclined to the third.

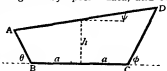

FIG. 7.

(i) In fig. 7 let base $BC = 2a$, and let h be the distance, measured at right angles to BC, from the middle point of BC to AD. Also, let angle $ABC = \pi - \phi$, angle $BCD = \pi - \phi$, angle between BC and AD = ψ . Then (as the difference of two triangles)

$$\text{area } ABCD = \frac{h \cot \psi + a^2}{2(\cot \psi - \cot \phi)} - \frac{h \cot \psi - a^2}{2(\cot \psi + \cot \phi)}$$

(ii) If $\phi = \theta$, this becomes

$$\text{area} = \frac{\tan \theta}{\tan^2 \theta - \tan^2 \psi} (h + a \tan \theta)^2 - a^2 \tan \theta.$$

(iii) If $\psi = 0$, so that AD is parallel to BC, it becomes

$$\text{area} = 2ah + \frac{1}{2}(\cot \theta + \cot \phi)h^2.$$

(iv) To find the volume of a prismoidal cutting with vertical ends, and with sides equally inclined to the vertical, so that $\phi = \theta$, let the values of h , ψ for the two ends be h_1, ψ_1 , and h_2, ψ_2 , and write

$$\begin{aligned} m_1 &\equiv \frac{\cot \psi_1}{\cot \psi_1 - \cot \theta} (a + h_1 \cot \theta), & n_1 &\equiv \frac{\cot \psi_1}{\cot \psi_1 + \cot \theta} (a + h_1 \cot \theta), \\ m_2 &\equiv \frac{\cot \psi_2}{\cot \psi_2 - \cot \theta} (a + h_2 \cot \theta), & n_2 &\equiv \frac{\cot \psi_2}{\cot \psi_2 + \cot \theta} (a + h_2 \cot \theta). \end{aligned}$$

$$\text{Then volume of prismoid} = \text{length} \times \frac{1}{6} \{m_1 n_1 + m_2 n_2 + \frac{1}{2}(m_1 n_2 + m_2 n_1) - 3a^2\} \tan \theta.$$

MENSURATION OF GRAPHS

38. (A) *Preliminary.*—In § 23 the area of a right trapezium has been expressed in terms of the base and the two sides; and in § 34 the area of a somewhat similar figure, the top having been replaced by an arc of a parabola, has been expressed in terms of its base and of three lengths which may be regarded as the sides of two separate figures of which it is composed. We have now to consider the extension of formulae of this kind to other figures, and their application to the calculation of moments and volumes.

39. The plane figures with which we are concerned come mainly under the description of *graphs* of continuous variation. Let E and F be two magnitudes so related that whenever F has any value (within certain limits) E has a definite corresponding value. Let u and x be the numerical expressions of the magnitudes of E and F. On any line OX take a length ON equal to xG , and from N draw NP at right angles to OX and equal to uH ; G and H being convenient units of length. Then we may, ignoring the units G and H, speak of ON and NP as being equal to x and u respectively. Let KA and LB be the positions of NP corresponding to the extreme values of x . Then the different positions of NP will (if x may have any value from OK to OL) trace out a figure on base KL, and extending from KA to LB; this is called the *graph* of E in respect of F. The term is also sometimes applied to the line AB along which the point P moves as N moves from K to L.

To illustrate the importance of the mensuration of graphs, suppose that we require the average value of u with regard to x . It may be shown that this is the same thing as the mean distance

of elements of the graph from an axis through O at right angles to OX. Its calculation therefore involves the calculation of the area and the first moment of the graph.

40. The process which has to be performed in the mensuration of figures of this kind are in effect processes of integration; the distinction between mensuration and integration lies in the different natures of the data. If, for instance, the graph were a trapezium, the calculation of the area would be equivalent to finding the integral, from $x=a$ to $x=b$, of an expression of the form $px+q$. This would involve p and q ; but, for our purposes, the data are the sides $pa+q$ and $pb+q$ and the base $b-a$, and the expression of the integral in terms of these data would require certain eliminations. The province of mensuration is to express the final result of such an elimination in terms of the data, without the necessity of going through the intermediate processes.

41. *Trapezoids and Bricquettes.*—A figure of the kind described in § 39 is called a *trapezette*. A trapezette may therefore be defined as a plane figure bounded by two straight lines, a base at right angles to them, and a top which may be of any shape but is such that every ordinate from the base cuts it in one point and one point only; or, alternatively, it may be defined as the figure generated by an ordinate which moves in a plane so that its foot is always on a straight base to which the ordinate is at right angles, the length of the ordinate varying in any manner as it moves. The distance between the two straight sides, i.e. between the initial and the final position of the ordinate, is the *breadth* of the trapezette. Any line drawn from the base at right angles to it, and terminated by the top of the trapezette, is an *ordinate* of the figure. The trapezium is a particular case.

Either or both of the bounding ordinates may be zero; the top, in that case, meets the base at that extremity. Any plane figure might be converted into an equivalent trapezette by an extension of the method of § 25 (iv).

42. The corresponding solid figure, in its most general form, is such as would be constructed to represent the relation of a magnitude E to two magnitudes F and G of which it is a function; it would stand on a plane base, and be comprised within a cylindrical boundary whose height be any shape. We are not concerned with figures of this general kind, but only with cases in which the base is a rectangle. The figure is such as would be produced by removing a piece of a rectangular prism, and is called a *bricquette*. A bricquette may therefore be defined as a solid figure bounded by a pair of parallel planes, another pair of parallel planes at right angles to these, a base at right angles to these four planes (and therefore rectangular), and a top which is a surface of any form, but such that every ordinate from the base cuts it in one point and one point only. It may be regarded as generated either by a trapezette moving in a direction at right angles to itself and changing its top but keeping its breadth unaltered, or by an ordinate moving so that its foot has every possible position within a rectangular base.

43. *Notation and Definitions.*—The ordinate of the trapezette will be denoted by u , and the *abscissa* of this ordinate, i.e. the distance of its foot from a certain fixed point or origin O on the base (or the base produced), will be denoted by x , so that u is some function of x . The sides of the trapezette are the "bounding ordinates"; their abscissae being x_0 and x_0+H , where H is the breadth of the trapezette.

The "mid-ordinate" is the ordinate from the middle point of the base, i.e. the ordinate whose abscissa is $x_0+\frac{1}{2}H$.

The "mean ordinate" or *average ordinate* is an ordinate of length l such that lH is equal to the area of the trapezette. It therefore appears as a calculated length rather than as a definite line in the figure; except that, if there is only one ordinate of this length, a line drawn through its extremity is so placed that the area of the trapezette lying above it is equal to a corresponding area below it and outside the trapezette. Formulae giving the area of a trapezette should in general also be expressed so as to state the value of the mean ordinate (§§ 12 (v), 15, 19).

The "median ordinate" is the ordinate which divides the area of the trapezette into two equal portions. It arises, mainly in statistics, when the ordinate of the trapezette represents the relative frequency of occurrence of the magnitude represented by the abscissa x ; the magnitude of the abscissa corresponding to the median ordinate is then the "median value of x ".

The "central ordinate" is the ordinate through the centroid of the trapezette (§ 32). The distance of this ordinate from the axis of u (i.e. from a line drawn through O parallel to the ordinates) is equal to the mean distance (§ 32) of the trapezette from this axis; moments with regard to the central ordinate are therefore sometimes described in statistics as "moments about the mean."

The data of a trapezette are usually its breadth and either the bounding ordinates or the mid-ordinates of a series of minor trapezettes or strips into which it is divided by ordinates at equal distances. If there are m of these strips, and if the breadth of each is h , so that $H=mh$, it is convenient to write x in the form $x_0+h\theta$, and to denote it by x_θ , the corresponding value of u being u_θ . The data are then either the bounding ordinates $u_0, u_1, \dots, u_{m-1}, u_m$ of the strips, or their mid-ordinates $u_{\frac{1}{2}}, u_{\frac{3}{2}}, \dots, u_{m-\frac{1}{2}}$.

44. In the case of the bricquette the position of the foot of the ordinate u is expressed by co-ordinates x, y , referred to a pair of axes

parallel to a pair of sides of the base of the bricquette. If the lengths of these sides are H and K, the coordinates of the angles of the base—i.e. the co-ordinates of the edges of the bricquette—are (x_0, y_0) , (x_0+H, y_0) , (x_0, y_0+K) , and (x_0+H, y_0+K) .

The bricquette may usually be regarded as divided into a series of minor bricquettes by two sets of parallel planes, the planes of each set being at successively equal distances. If the planes of one set divide it into m slabs of thickness h , and those of the other into n slabs of thickness k , so that $H=mh$, $K=nk$, then the values of x and y for any ordinate may be denoted by $x_0+h\theta$ and $y_0+k\phi$, and the length of the ordinate by $u_{\theta, \phi}$.

The data are usually the breadths H and K and either (i) the edges of the minor bricquettes, viz. $u_{0,0}, u_{1,0}, \dots, u_{m,0}, u_{0,1}, \dots, u_{0,n}, u_{1,n}, \dots, u_{m,n}$, or (ii) the mid-ordinates of one set of parallel faces, viz. $u_{\frac{1}{2},0}, u_{\frac{3}{2},0}, \dots, u_{\frac{1}{2},n}, \dots, u_{\frac{1}{2},n}$, or (iii) the "mid-ordinates" $u_{1,1}, u_{2,1}, \dots, u_{m,1}, \dots$ of the minor bricquettes, i.e. the ordinates from the centres of their bases.

A line parallel to either pair of sides of the bricquette is a "principal plane." The ordinate through the centroid of the figure is the "central ordinate."

45. In some cases the data for a trapezette or a bricquette are not only certain ordinates within or on the boundary of the figure, but also others forming the continuation of the series outside the figure. For a trapezette, for instance, they may be $u_0, u_1, \dots, u_{m-1}, u_m, u_{m+1}, \dots, u_{m+n-1}, u_{m+n}$, where u_θ denotes the same function of $x=x_0+h\theta$, whether θ lies between the limits 0 and H or not. These cases are important as enabling simpler formulae, involving central differences, to be used (§ 76).

46. The area of the trapezette, measured from the lower bounding ordinate up to the ordinate corresponding to the value of x , is some function of x . In the notation of the integral calculus, this area is equal to $\int_{x_0}^x u dx$; but the notation is inconvenient, since it implies a division into infinitesimal elements, which is not essential to the idea of an area. It is therefore better to use some independent notation, such as $A_x \cdot u$. It will be found convenient to denote $\phi(a) - \phi(a)$, where $\phi(x)$ is any function of x , by $\left[\phi(x) \right]_{x=a}^{x=b}$; the area of the trapezette whose bounding ordinates are u_0 and u_m may then be denoted by $\left[A_x \cdot u \right]_{x=x_0}^{x=x_0+H}$ or $\left[A_x \cdot u \right]_{\theta=0}^{\theta=m}$, instead of by $\int_{x_0}^{x_0+H} u dx$.

In the same way the volume of a bricquette between the planes $x=x_0$, $y=y_0$, $x=a$, $y=b$ may be denoted by

$$\left[\left[V_{x,y} \cdot u \right]_{y=y_0}^{y=b} \right]_{x=x_0}^{x=a}$$

47. The statement that the ordinate u of a trapezette is a function of the abscissa x , or that $u=f(x)$, must be distinguished from $u=f(x)$ as the equation to the top of the trapezette.

In elementary geometry we deal with lines and curves, while in mensuration we deal with areas bounded by these lines or curves. The circle, for instance, is regarded geometrically as a line described in a particular way, while from the point of view of mensuration it is a figure of a particular shape. Similarly, analytical plane geometry deals with the curves described by a point moving in a particular way, while analytical plane mensuration deals with the figure generated by an ordinate moving so that its length varies in a particular manner depending on its position.

In the same way, in the case of a figure in three dimensions, analytical geometry is concerned with the form of the surface, while analytical mensuration is concerned with the figure as a whole.

48. *Representation of Volume by Area.*—An important plane graph is that which represents the volume of a solid figure.

Suppose that we take a pair of parallel planes, such that the solid extends from one to the other of these planes. The section by any intermediate parallel plane will be called a "cross-section." The solid may then be regarded as generated by the cross-section moving parallel to itself and changing its shape, or its position with regard to a fixed axis to which it is always perpendicular, as it moves.

If the area of the cross-section, in every position, is known in terms of its distance from one of the bounding planes, or from a fixed plane A parallel to them, the volume of the solid can be expressed in terms of the area of a trapezette. Let S be the area of the cross-section at distance x from the plane A. On a straight line OX in any plane take a point N at distance x from O, and draw an ordinate NP at right angles to OX and equal to S/l , where l is some fixed length (e.g. the unit of measurement). If this is done for every possible value of x , there will be a series of ordinates tracing out a trapezette with base along OX. The volume comprised between the cross-section whose area is S and a consecutive cross-section at distance θ from it is ultimately $S_\theta l$, when θ is indefinitely small; and the area between the corresponding ordinates of the trapezette is $(S/l) \cdot \theta = S_\theta l$. Hence the volume of each element of the solid figure is to be found by multiplying the area of the corresponding element of the trapezette by l , and therefore the total volume is $l \times$ area of trapezette.

The volume of a briquette can be found in this way if the area of the section by any principal plane can be expressed in terms of the distance of this plane from a fixed plane of the same set. The result of treating this area as if it were the ordinate of a trapezette leads to special formulæ, when the data are of the kind mentioned in § 44.

(B) *Mensuration of Graphs of Algebraical Functions*.—The first class of cases to be considered comprises those cases in which u is an algebraical function (i.e. a rational integral algebraical function) of x , or of x and y , of a degree which is known.

50. The simplest case is that in which u is constant or is a linear function of x , i.e. is of the form $px + q$. The trapezette is then a right trapezium, and its area, if $m=1$, is $\frac{1}{2}h(u_0 + u_1)$ or hu_0 .

51. The next case is that in which u is a quadratic function of x , i.e. is of the form $px^2 + qx + r$. The top is then a parabola whose axis is at right angles to the base; and the area can therefore (§ 34) be expressed in terms of the two bounding ordinates and the mid-ordinate. If we take these to be u_0 and u_1 , and u_2 , so that $m = 2$, we have

$$\text{area} = \frac{2}{3}h(u_0 + 4u_1 + u_2) = \frac{1}{3}h(u_0 + 4u_1 + u_2).$$

This is *Simpson's formula*.

If instead of u_0, u_1 , and u_2 , we have four ordinates u_0, u_1, u_2 , and u_3 , so that $m = 3$, it can be shown that

$$\text{area} = \frac{3}{8}h(u_0 + 3u_1 + 3u_2 + u_3).$$

This is *Simpson's second formula*. It may be deduced from the formula given above. Denoting the areas of the three strips by A, B , and C , and introducing the middle ordinate u_1 , we can express $A + B; B + C; A + B + C$; and B in terms of $u_0, u_1, u_2, u_3, u_1; u_0, u_1, u_2; u_1, u_2, u_3$ respectively. Thus we get two expressions for $A + B + C$, from which we can eliminate u_1 .

A trapezette of this kind will be called a *parabolic trapezette*.

52. Simpson's two formulæ also apply if u is of the form $px^2 + qx + rx + s$. Generally, if the area of a trapezette for which u is an algebraical function of x of degree $2n$ is given correctly by an expression which is a linear function of values of u representing ordinates placed symmetrically about the mid-ordinate of the trapezette (with or without this mid-ordinate), the same expression will give the area of a trapezette for which u is an algebraical function of x of degree $2n + 1$. This will be seen by taking the mid-ordinate as the ordinate for which $x = 0$, and noticing that the odd powers of x introduce positive and negative terms which balance one another when the whole area is taken into account.

53. When u is of degree 4 or 5 in x , we require at least five ordinates. If $m = 4$, and the data are u_0, u_1, u_2, u_3, u_4 , we have

$$\text{area} = \frac{7}{80}h(7u_0 + 32u_1 + 12u_2 + 32u_3 + 7u_4).$$

For functions of higher degrees in x the formulæ become more complicated.

54. The general method of constructing formulæ of this kind involves the use of the integral calculus and of the calculus of finite differences. The breadth of the trapezette being mh , it may be shown that its area is

$$mh \left\{ u_{1m} + \frac{1}{24} m^2 h^2 u_{1m}'' + \frac{1}{1920} m^4 h^4 u_{1m}^{(4)} + \frac{1}{322560} m^6 h^6 u_{1m}^{(6)} + \dots \right\},$$

$$\frac{1}{92897280} m^8 h^8 u_{1m}^{(8)} + \dots,$$

where $u_{1m}, u_{1m}'', u_{1m}^{(4)}, \dots$ denote the values for $x = x_{1m}$ of the successive differential coefficients of u with regard to x ; the series continuing until the differential coefficients vanish. There are two classes of cases, according as m is even or odd; it will be convenient to consider them first for those cases in which the data are the bounding ordinates of the strips.

(i) If m is even, u_{1m} will be one of the given ordinates, and we can express $hu_{1m}, hu_{1m}'', \dots$ in terms of u_{1m} and its even central differences (see DIFFERENCES, CALCULUS OF). Writing $m = 2p$, and grouping the coefficients of the successive differences, we shall find

$$\text{area} = 2ph \left\{ u_p + \frac{p^2}{6} \delta^2 u_p + \frac{3p^4 - 5p^2}{360} \delta^4 u_p + \dots \right\},$$

$$\frac{3p^6 - 21p^4 + 25p^2}{15120} \delta^6 u_p + \dots$$

If u is of degree $2f$ or $2f + 1$ in x , we require to go up to $\delta^f u_p$, so that m must be not less than $2f$. Simpson's (first) formula, for instance, holds for $f = 1$, and is obtained by taking $p = 1$ and ignoring differences after $\delta^2 u_p$.

(ii) If m is odd, the given ordinates are $u_0, \dots, u_{m-1}, u_{m+1}, \dots, u_m$. We then have

$$\text{area} = mh \left\{ u_{1m} + \frac{m^2 - 3}{24} \mu^2 u_{1m} + \frac{3m^4 - 50m^2 + 135}{5760} \mu^4 u_{1m} + \dots \right\},$$

$$\frac{3m^6 - 147m^4 + 1813m^2 - 4725}{967680} \mu^6 u_{1m} + \dots,$$

where $\mu_{1m}, \mu^2 u_{1m}, \dots$ denote $\frac{1}{2}(u_{1m-1} + u_{1m+1}), \frac{1}{8}(\delta^2 u_{1m-1} +$

$\delta^2 u_{1m+1}), \dots$ Simpson's second formula is obtained by taking $m = 3$ and ignoring differences after $\mu^2 u_{1m}$.

55. The general formulæ of § 54 (p being replaced in (i) by $\frac{1}{2}m$) may in the same way be applied to obtain formulæ giving the area of the trapezette in terms of the mid-ordinates of the strips, the series being taken to $\delta^f u_{1m}$ or $\mu^f u_{1m}$ at least, where u is of degree $2f$ or $2f + 1$ in x . Thus we find from (i) that Simpson's second formula, for the case where the top is a parabola (with axis, as before, at right angles to the base) and there are three strips of breadth h , may be replaced by

$$\text{area} = \frac{3}{8}h(3u_1 + 2u_2 + 3u_3).$$

This might have been deduced directly from Simpson's first formula, by a series of eliminations.

56. Hence, for the case of a parabola, we can express the area in terms of the bounding ordinates of two strips, but, if we use mid-ordinates, we require three strips; so that, in each case, three ordinates are required. The question then arises whether, by removing the limitation as to the position of the ordinates, we can reduce their number.

Suppose that in fig. 6 (§ 34) we draw ordinates QD midway between KA and MC, and RE midway between MC and LB, meeting the top in D and E (fig. 8), and join DE. Then K, L, and M, and MC in H, J, and W. It may be shown that DE is parallel to AB, and that the area of the figure between chord DE and arc DE is half the sum of the areas DHA and EJB. Hence the area of the right trapezette KHEJ is greater than the area of the trapezette KACBL.

If we were to take QD and RE closer to MC, the former area would be still greater. If, on the other hand, we were to take them very close to KA and LB respectively, the area of the trapezette would be the greater. There is therefore some intermediate position such that the two areas are equal; i.e. such that the area of the trapezette is represented by $KL \cdot \frac{1}{2}(QD + RE)$.

To find this position, let us write $QM = MR = \theta \cdot KM$. Then $WC = \theta \cdot VC, VW = (1 - \theta) \cdot VC$; curved area $AHB = \frac{2}{3}$ of parallelogram $AFCB = \frac{1}{2} \cdot KL \cdot VC$; parallelogram $ACHB = KL \cdot VW = (1 - \theta) \cdot \frac{1}{2} \cdot KL \cdot VC$.

Hence the areas of the trapezette and of the trapezium will be equal if

$$1 - \theta = \frac{1}{3}, \theta = \frac{1}{3}.$$

This value of θ is the same for all parabolas which pass through D and E and have their axes at right angles to KL. It follows that, by taking two ordinates in a certain position with regard to the bounding ordinates, the area of any parabolic trapezette whose top passes through their extremities can be expressed in terms of these ordinates and of the breadth of the trapezette.

The same formula will also hold (§ 52) for any cubic trapezette through the points.

57. This is a particular case of a general theorem, due to Gauss, that, if u is an algebraical function of x of degree $2p$ or $2p + 1$, the area can be expressed in terms of $p + 1$ ordinates taken in suitable positions.

58. *The Prismoidal Formula*.—It follows from §§ 48 and 51 that, if V is a solid figure extending from a plane K to a parallel plane L, and if the area of every cross-section parallel to these planes is a quadratic function of the distance of the section from a fixed plane parallel to them, Simpson's formula may be applied to find the volume of the solid. If the areas of the two ends in the planes K and L are S_0 and S_1 , and the area of the mid-section (i.e. the section by a plane parallel to these planes and midway between them) is S_2 , the volume is $\frac{1}{6}h(S_0 + 4S_1 + S_2)$, where h is the total breadth.

This formula applies to such figures as the cone, the sphere, the ellipsoid and the prismoid. In the case of the sphere, for instance, whose radius is R , the area of the section at distance x from the centre is $\pi(R^2 - x^2)$, which is a quadratic function of x ; the values of S_0 and S_1 are respectively πR^2 , and 0, and the volume is therefore $\frac{1}{6} \cdot 2\pi R^2 \cdot \pi R^2 = \frac{2}{3}\pi R^3$.

To show that the area of a cross-section of a prismoid is of the form $ax^2 + bx + c$, where x is the distance of the section from one end, we may proceed as in § 27. In the case of a pyramid, of height h , the area of the section by a plane parallel to the base and at distance x from the vertex is clearly $x^2/h^2 \times$ area of base. In the case of a wedge with parallel ends the ratio x^2/h^2 is replaced by x/h . For a tetrahedron, two of whose opposite edges are AB and CD, we require the area of the section by a plane parallel to AB and CD. Let the distance of the section from the parallel planes through AB and CD be h , and let a plane at distance x from the plane through AB cut the edges AC,

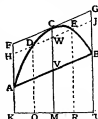

FIG. 8.

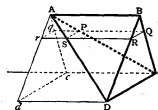

FIG. 9.

BC, BD, AD, in P, Q, R, S (fig. 9). Then the section of the pyramid by this plane is the parallelogram PQRS. By drawing Ac and Ad parallel to BC and BD, so as to meet the plane through CD in c and d, and producing QP and RS to meet Ac and Ad in q and r, we see that the area of PQRS is $(x/h - x^2/h^2) \times$ area of $\triangle CDd$; this also is a quadratic function of x . The proposition can then be established for a prismoid generally by the method of § 27 (iv).

The formula is known as the *prismoidal formula*.
59. *Moment of a curve* of all degrees. The ordinates are at an equal distance from the axis of x ; it is easily shown that the first moment (with regard to this axis) of a trapezette whose ordinate is u is equal to the area of a trapezette whose ordinate is xu ; and this area can be found by the methods of the preceding sections in cases where u is an algebraical function of x . The formulæ can then be applied to finding the moments of certain volumes.

In the case of the parabolic trapezette, for instance, xu is of degree 3 in x , and therefore the first moment is $\frac{1}{4}h(x_0u_0 + 4x_1u_1 + x_2u_2)$. In the case, therefore, of any solid whose cross-section at distance x from one end is a quadratic function of x , the position of the cross-section through the centroid is to be found by determining the position of the centre of gravity of particles of masses proportional to $S_0, S_1,$ and S_2 , placed at the extremities and the middle of a line drawn from one end of the solid to the other. The centroid of a hemisphere of radius R , for instance, is the same as the centroid of particles of masses $0, \pi R^2,$ and $4 \cdot \frac{1}{2}\pi R^2$, placed at the extremities and the middle of its axis; i.e. the centroid is at distance $\frac{3}{8}R$ from the plane face.

60. The method can be extended to finding the second, third, . . . moments of a trapezette with regard to the axis of x . If u is an algebraical function of x of degree not exceeding p , and if the area of a trapezette, for which the ordinate u is of degree not exceeding $p - q$, may be expressed by a formula $\lambda_0 u_0 + \lambda_1 u_1 + \dots + \lambda_m u_m$, the q th moment of the trapezette is $\lambda_0 x_0^q u_0 + \lambda_1 x_1^q u_1 + \dots + \lambda_m x_m^q u_m$, and the mean value of x^q is

$$(\lambda_0 x_0^q u_0 + \lambda_1 x_1^q u_1 + \dots + \lambda_m x_m^q u_m) / (\lambda_0 u_0 + \lambda_1 u_1 + \dots + \lambda_m u_m).$$

The calculation of this last expression is simplified by noting that we are only concerned with the mutual ratios of $\lambda_0, \lambda_1, \dots$ and of u_0, u_1, \dots , not with their actual values.

61. *Cubature of a Briquette*.—To extend these methods to a briquette, where the ordinate u is an algebraical function of x and y , the axes of x and of y being parallel to the sides of the base, we consider that the area of a section at distance x from the plane $x=0$ is expressed in terms of the ordinates in which it intersects the series of planes, parallel to $y=0$, through the given ordinates of the briquette (§ 44); and that the area of the section is then represented by the ordinate of a trapezette. This ordinate will be an algebraical function of x , and we can again apply a suitable formula.

Suppose, for instance, that u is of degree not exceeding 3 in x , and of degree not exceeding 3 in y , i.e. that it contains terms in $x^2 y^2, x^2 y, x^2 y^2, \&c.$; and suppose that the edges parallel to x and y are measured are of lengths $2h$ and $2k$, the briquette being divided into six elements by the plane $x=x_0+h$ and the planes $y=y_0+k, y=y_0+2k$, and that the 12 ordinates forming the edges of these six elements are given. The areas of the sides for which $x=x_0$ and $x=x_0+2h$, and of the section by the plane $x=x_0+h$, may be found by Simpson's second formula; call these A_0 and A_2 , and A_1 . The area of the section by a plane at distance x from the edge $x=x_0$ is a function of x whose degree is the same as that of u . Hence Simpson's formula applies, and the volume is $\frac{1}{6}h(A_0 + 4A_1 + A_2)$.

The process is simplified by writing down the general formula first and then substituting the values of u . The formula, in the above case, is

$$\frac{1}{6}h \left[\frac{1}{3}(u_{00} + 3u_{01} + 3u_{02} + u_{03}) + 4 \times \frac{1}{3}h(u_{10} + \dots) + \frac{1}{3}h(u_{20} + \dots) \right],$$

where u_{ij} denotes the ordinate for which $x=x_0+ih, y=y_0+jk$. The result is the same as if we multiplied $\frac{1}{6}h(u_0 + 3u_1 + 3u_2 + u_3)$ by $\frac{1}{3}h(u_0 + 4u_1 + u_2)$, and then replaced u_0, u_1, \dots by u_{00}, u_{01}, \dots . The multiplication is shown in the adjoining diagram; the factors $\frac{1}{6}h$ and $\frac{1}{3}h$ are kept outside, so that the sum $u_{00} + 3u_{01} + \dots + 4u_{11} + \dots$ can be calculated before it is multiplied by $\frac{1}{3}h$.

62. The above is a particular case of a general principle that the obtaining of an expression such as $\frac{1}{6}h(u_0 + 4u_1 + u_2)$ or $\frac{1}{6}h(u_0 + 3u_1 + 3u_2 + u_3)$ is an *operation* performed on $u_0, u_1,$ and that this operation is the sum of a number of operations such as that which obtains $\frac{1}{3}u_0$ or $\frac{1}{3}u_1$. The volume of the briquette for which u is a function of x and y is found by the operation of double integration, consisting of two successive operations, one being with regard to x , and the other with regard to y ; and these operations may (in the cases with which we are concerned) be performed in either order. Starting from any ordinate u_0, ϕ , the result of integrating with regard to x through a distance $2h$ in the example considered in § 61) the same as the result of the operation $\frac{1}{6}h(u_0 + 4E + E^2)$, where E denotes the operation of changing x into $x+h$ (see DIFFERENCES, CALCULUS

or). The integration with regard to y may similarly (in the particular example) be replaced by the operation $\frac{1}{6}k(1 + 3E' + 3E'^2 + E'^3)$, where E' denotes the change of y into $y+k$. The result of performing both operations, in order to obtain the volume, is the result of the operation denoted by the product of these two expressions; and in this product the powers of E and of E' may be dealt with according to algebraical laws.

The methods of §§ 59 and 60 can similarly be extended to finding the position of the central ordinate of a briquette, or the mean q th distance of elements of the briquette from a principal plane.

63. (C) *Mensuration of Graphs Generally*.—We have next to consider the extension of the preceding methods to cases in which u is not necessarily an algebraical function of x or of x and y .

The general principle is that the numerical data from which a particular result is to be deduced are in general not exact, but are given only to a certain degree of accuracy. This limits the accuracy of the result; and we can therefore replace the figure by another figure which coincides with it approximately, provided that the further accuracy so introduced is comparable with the original inaccuracies of measurement.

The relation between the inaccuracy of the data and the additional inaccuracy due to substitution of another figure is similar to the relation between the inaccuracies in mensuration of a figure which is supposed to be of a given form (§ 20). The volume of a frustum of a cone, for instance, can be expressed in terms of certain magnitudes by a certain formula; but not only will there be some error in the measurement of these magnitudes, but there is not any material figure which is an exact cone. The formula may, however, be used if the deviations from the conical form is relatively less than the errors of measurement. The conditions are thus similar to those which arise in interpolation (q, n). The data are the same in both cases. In the case of a trapezette, for instance, the data are the magnitudes of certain ordinates; the problem of interpolation is to determine the values of intermediate ordinates, while that of mensuration is to determine the area of the figure of which these are the ordinates. If, as is usually the case, the ordinate throughout each strip of the trapezette can be expressed approximately as an algebraical function of the abscissa, the application of the integral calculus gives the area of the figure.

64. There are three classes of cases to be considered. In the case of mathematical functions certain conditions of continuity are satisfied, and the extent to which the value given by any particular formula differs from the true value may be estimated within certain limits; the main inaccuracy, in favourable cases, being due to the fact that the numerical data are not absolutely exact. In physical and mechanical applications, where concrete measurements are involved, there is, as pointed out in the preceding section, the additional inaccuracy due to want of exactness in the figure itself. In the case of statistical data there is the further difficulty that there is no real continuity, since we are concerned with a finite number of individuals.

The proper treatment of the deviations from mathematical accuracy, in the second and third of the above classes of cases, is a special matter. In what follows it will be assumed that the conditions of continuity (which imply the continuity not only of u but also of some of its differential coefficients) are satisfied, subject to the small errors in the values of u actually given; and the limits of these errors being known.

65. It is only necessary to consider the trapezette and the briquette, since the cases which occur in practice can be reduced to one or other of these forms. In each case the data are the values of certain equidistant ordinates, as described in §§ 43-45. The terms *quadrature-formula* and *cubature-formula* are sometimes restricted to formulæ for expressing the area of a trapezette, or the volume of a briquette, in terms of such data. This a quadrature-formula is a formula for expressing $[A, u]$ or $[V, u]$ in terms of a series of given values of u , while a cubature-formula is a formula for expressing $[V, u, u']$ or $[V, u, u']$ in terms of the values of u for certain values of x in combination with certain values of y ; these values not necessarily lying within the limits of the integrations.

66. There are two principal methods. The first, which is the best known but is of limited application, consists in replacing each successive portion of the figure by another figure whose ordinate is an algebraical function of x or of x and y , and expressing the area or volume of this latter figure (exactly or approximately) in terms of the given ordinates. The second consists in taking a comparatively simple expression obtained in this way, and introducing corrections which involve the values of ordinates at or near the boundaries of the figure. The various methods will be considered first for the trapezette, the extensions to the briquette being only treated briefly.

67. *The Trapezoidal Rule*.—The simplest method is to replace the trapezette by a series of trapezia. If the data are u_0, u_1, \dots, u_m , the figure formed by joining the tops of these ordinates is a trapezoid whose area is $\frac{1}{2}h(u_0 + u_1 + \dots + u_{m-1} + u_m)$. This is called the *trapezoidal or chordal* area, and will be denoted by C_1 . If the data are u_0, u_1, \dots, u_{m-1} , we can form a series of trapezia by drawing the tangents at the extremities of these ordinates; the sum of the areas of these trapezia will be $h(u_0 + u_1 + \dots + u_{m-1})$. This is called the *tangential* area, and will be denoted by T_1 . The

tangential area may be expressed in terms of chordal areas. If we write C_1 for the chordal area obtained by taking ordinates at intervals h , then $T_1 = 2C_1 - C_1$. If the trapezette, as seen from above, is everywhere convex or everywhere concave, the true area lies between C_1 and T_1 .

68. *Other Rules for Trapezettes.*—The extension of this method consists in dividing the trapezette into minor trapezettes, each consisting of two or more strips, and replacing each of these minor trapezettes by a new figure, whose ordinate v is an algebraical function of x ; this function being chosen so that the new figure shall coincide with the original figure so far as the given ordinates are concerned. This means that, if the minor trapezette consists of k strips, v will be of degree k or $k-1$ in x , according as the data are the bounding ordinates or the mid-ordinates. If A denotes the true area of the original trapezette, and B the aggregate area of the substituted figures, we have $A \triangleq B$, where \triangleq denotes approximate equality. The value of B is found by the methods of §§ 49-55. The following are some examples.

(i) Suppose that the bounding ordinates are given, and that m is a multiple of 2. Then we can take the strips in pairs, and treat each pair as a parabolic trapezette. Applying Simpson's formula to each of these, we have

$$A \triangleq \frac{1}{3}h(u_0 + 4u_1 + u_2) + \frac{1}{3}h(u_2 + 4u_3 + u_4) + \dots + \frac{1}{3}h(u_{m-2} + 4u_{m-1} + u_m).$$

This is Simpson's rule.

(ii) Similarly, if m is a multiple of 3, the repeated application of Simpson's second formula gives Simpson's second rule

$$A \triangleq \frac{1}{8}h(u_0 + 3u_1 + 3u_2 + 2u_3 + 3u_4 + \dots + 3u_{m-3} + 2u_{m-2} + 3u_{m-1} + u_m).$$

(iii) If mid-ordinates are given, and m is a multiple of 3, the repeated application of the formula of § 55 will give

$$A \triangleq \frac{1}{3}h(3u_{\frac{1}{2}} + 2u_{\frac{2}{2}} + 3u_{\frac{3}{2}} + 3u_{\frac{4}{2}} + \dots + 2u_{\frac{m-3}{2}} + 3u_{\frac{m-2}{2}}).$$

69. The formulae become complicated when the number of strips in each of the minor trapezettes is large. The method is then modified by replacing B by an expression which gives the areas of the substituted figures approximately. This introduces a further inaccuracy; but this latter may be negligible in comparison with the main inaccuracies already involved (cf. § 20 (iii)).

Suppose, for instance, that $m=6$, and that we consider the trapezette as a whole; the data being the bounding ordinates. Since there are seven of these, v will be of degree 6 in x ; and we shall have (§ 54 (i))

$$B = 6h(u_0 + 3^2u_{\frac{1}{6}} + \frac{1}{2}u_{\frac{2}{6}} + \frac{1}{2}u_{\frac{4}{6}} + \frac{1}{2}u_{\frac{5}{6}}) = 6h(u_0 + 3^2u_{\frac{1}{6}} + \frac{1}{2}u_{\frac{2}{6}} + \frac{1}{2}u_{\frac{4}{6}} + \frac{1}{2}u_{\frac{5}{6}}).$$

If we replace $u_{\frac{1}{6}}, u_{\frac{2}{6}}, u_{\frac{4}{6}}, u_{\frac{5}{6}}$ in this expression by $\frac{1}{6}h^2v_{\frac{1}{6}}, v_{\frac{2}{6}}, v_{\frac{4}{6}}, v_{\frac{5}{6}}$, the method of § 68 gives

$$A \triangleq \frac{1}{6}h^2(h(u_0 + 5u_1 + u_2 + 6u_3 + u_4 + 5u_5 + u_6));$$

the expression on the right-hand side being an approximate expression for B , and differing from it only by $\frac{1}{6}h^2H^2u_3$. This is Weddle's rule. If m is a multiple of 6, we can obtain an expression for A by applying the rule to each group of six strips.

70. Some of the formulae obtained by the above methods can be expressed more simply in terms of chordal or tangential areas taken in various ways. Consider, for example, Simpson's rule (§ 68 (i)). The expression for A can be written in the form

$$\frac{1}{3}h(\frac{1}{2}u_0 + u_1 + u_2 + u_3 + \dots + u_{m-2} + \frac{1}{2}u_{m-1} + \frac{1}{2}u_m) - \frac{2}{3}h(\frac{1}{2}u_0 + u_2 + u_4 + \dots + u_{m-2} + \frac{1}{2}u_m).$$

Now, if ρ is any factor of m , there is a series of equidistant ordinates $u_0, u_{\rho}, u_{2\rho}, \dots, u_{m-\rho}, u_m$; and the chordal area as determined by these ordinates is

$$\rho h(\frac{1}{2}u_0 + u_{\rho} + u_{2\rho} + \dots + u_{m-\rho} + \frac{1}{2}u_m),$$

which may be denoted by C_{ρ} . With this notation, the area as given by Simpson's rule may be written in the form $\frac{1}{3}(C_1 - \frac{1}{3}C_2$ or $C_1 + \frac{1}{3}(C_1 - C_2)$. The following are some examples of formulae of this kind, in terms of chordal areas.

- (i) m a multiple of 2 (Simpson's rule).
 $A \triangleq \frac{1}{3}(4C_1 - C_2 \triangleq C_1 + \frac{1}{3}(C_1 - C_2))$.
- (ii) m a multiple of 3 (Simpson's second rule).
 $A \triangleq \frac{1}{8}(9C_1 - C_2) \triangleq C_1 + \frac{1}{8}(C_1 - C_2)$.
- (iii) m a multiple of 4.
 $A \triangleq \frac{1}{25}(64C_1 - 20C_2 + C_4) \triangleq C_1 + \frac{1}{25}(C_1 - C_2) - \frac{1}{25}C_4$.
- (iv) m a multiple of 6 (Weddle's rule, or its repeated application).
 $A \triangleq \frac{1}{15}(15C_1 - 6C_2 + C_3) \triangleq C_1 + \frac{1}{15}(C_1 - C_2) - \frac{1}{15}C_3$.
- (v) m a multiple of 12.
 $A \triangleq \frac{1}{125}(56C_1 - 28C_2 + 8C_3 - C_4) \triangleq C_1 + \frac{1}{125}(C_1 - C_2) - \frac{1}{125}C_3 + \frac{1}{125}C_4$.

There are similar formulae in terms of the tangential areas T_1, T_2, T_3 . Thus (iii) of § 68 may be written $A \triangleq \frac{1}{8}(9T_1 - T_2)$.

71. The general method of constructing the formulae of § 70 for chordal areas is that, if ρ, q, r, \dots are k of the factors (including 1) of m , we take

$$A \triangleq PC_{\rho} + QC_q + RC_r + \dots,$$

where P, Q, R, \dots satisfy the k equations

$$\begin{aligned} P + Q + R + \dots &= 1, \\ P\rho^2 + Qq^2 + Rr^2 + \dots &= 0, \\ P\rho^4 + Qq^4 + Rr^4 + \dots &= 0, \\ &\vdots \\ P\rho^{2k-2} + Qq^{2k-2} + Rr^{2k-2} + \dots &= 0. \end{aligned}$$

The last $k-1$ of these equations give

$$\frac{1/P}{\rho^2(\rho^2 - \rho^2)} : \frac{1/Q}{q^2(q^2 - \rho^2)} : \frac{1/R}{r^2(r^2 - \rho^2)} : \dots = \rho^2(\rho^2 - \rho^2)(\rho^2 - \rho^2) : \dots$$

Combining this with the first equation, we obtain the values of P, Q, R, \dots

The same method applies for tangential areas, by taking

$$A \triangleq PT_p + QT_q + RT_r + \dots$$

provided that ρ, q, r, \dots are odd numbers.

72. The justification of the above methods lies in certain properties of the series of successive differences of u . The fundamental assumption is that each group of strips of the trapezette may be replaced by a figure for which differences of u , above those of a certain order, vanish (§ 54). The legitimacy of this assumption, and of the further assumption which enables the area of the new figure to be expressed by an approximate formula instead of by an exact formula, must be verified in every case by reference to the actual differences.

73. *Correction by means of Extreme Ordinates.*—The preceding methods, though apparently simple, are open to various objections in practice, such as the following: (i) The assignment of different coefficients of different ordinates, and even the selection of ordinates for the purpose of finding C_2, C_3 , &c. (§ 70), is troublesome. (ii) This assignment of different coefficients means that different weights are given to different ordinates; and the relative weights may not agree with the relative accuracies of measurement. (iii) Different formulae have to be adopted for different values of m ; the method is therefore unsuitable for the construction of a table giving successive values of the area up to successive ordinates. (iv) In order to find what formula may be applied, it is necessary to take the successive differences of u ; and it is then just as easy, in most cases, to use a formula which directly involves these differences and therefore shows the degree of accuracy of the approximation.

The alternative method, therefore, consists in taking a simple formula, such as the trapezoidal rule, and correcting it to suit the mutual relations of the differences.

74. To illustrate the method, suppose that we use the chordal area C_1 and that the trapezette is in fact parabolic. The difference area Δ between C_1 and the true area is made up of a table giving successive values of the area up to successive ordinates. (iv) In order to find what formula may be applied, it is then just as easy, in most cases, to use a formula which directly involves these differences and therefore shows the degree of accuracy of the approximation.

The fact that C_1 does not give the true area is due to the fact that in passing from one extremity of the top of any strip to the other extremity the tangent to the trapezette changes its direction. We have therefore in the first place to see whether the difference can be expressed in terms of the directions of the tangents.

Let $KABL$ (fig. 10) be one of the strips, of breadth h . Draw the tangents at A and B , meeting at T ; and through T draw a line parallel to KA and LB , meeting the arc AB in C and the chord AB in V . Draw AD and BE perpendicular to this line, and DF and TG perpendicular to LB . Then $AD = EB = \frac{1}{2}h$, and the triangles AVD and BVE are equal.

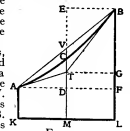

FIG. 10.

The area of the trapezette is less (in fig. 10) than the area of the trapezium $KABL$ by two-thirds of the area of the triangle ATB (§ 34). This latter area is $\Delta BTE - \Delta ATD = \Delta BTG - \Delta ATD = \frac{1}{2}h^2 \tan GTB - \frac{1}{2}h^2 \tan DAT$.

Hence, if the angle which the tangent at the extremity of the ordinate u_0 makes with the axis of x is denoted by ψ_0 , we have area from u_0 to $u_1 = \frac{1}{2}h^2(u_1 + u_0) - \frac{1}{2}h^2(\tan \psi_1 - \tan \psi_0)$,
 ,, u_1 to $u_2 = \frac{1}{2}h^2(u_2 + u_1) - \frac{1}{2}h^2(\tan \psi_2 - \tan \psi_1)$,
 ,, u_{m-1} to $u_m = \frac{1}{2}h^2(u_{m-1} + u_m) - \frac{1}{2}h^2(\tan \psi_m - \tan \psi_{m-1})$;

and hence, by summation,
 $A = C_1 - \frac{1}{2}h^2(\tan \psi_m - \tan \psi_0)$.

This, in the notation of §§ 46 and 54, may be written

$$A = C_1 + \left[-\frac{1}{2}h^2u' \right]_{x=x_0}^{x=x_m}$$

Since $h = H/m$, the inaccuracy in taking C_1 as the area varies as $1/m^2$.

It might be shown in the same way that

$$A = T_1 + \frac{1}{2}h^2(\tan \psi_m - \tan \psi_0) = T_1 + \left[\frac{1}{2}h^2u'' \right]_{x=x_0}^{x=x_m}$$

75. The above formulae apply only to a parabolic trapezette. Their generalization is given by the Euler-Maclaurin formula

$$A = \int_{x_0}^{x_m} u dx = C_1 + \left[-\frac{1}{2}h^2u'' + \frac{1}{24}h^4u'''' - \frac{1}{720}h^6u'''''' + \dots \right]_{x=x_0}^{x=x_m}$$

and an analogous formula (which may be obtained by substituting $\frac{1}{2}h$ and C_1 for h and C_1 in the above and then expressing T_1 as $A_1 - C_1$)

$$A = \int_{x_0}^{x_m} u dx = T_1 + \left[\frac{1}{24}h^2u'' - \frac{1}{720}h^4u'''' + \frac{1}{8640}h^6u'''''' - \dots \right]_{x=x_0}^{x=x_m}$$

To apply these, the differential coefficients have to be expressed in terms of differences.

76 If we know not only the ordinates u_0, u_1, \dots or u_1, u_2, \dots , but also a sufficient number of the ordinates obtained by continuing the series outside the trapezette, at both extremities, we can use central-difference formulae, which are by far the most convenient. The formulae of § 75 give

$$A = C_1 + h \left[-\frac{1}{24}\Delta^2u + \frac{1}{720}\Delta^4u - \frac{1}{8640}\Delta^6u + \frac{1}{51840}\Delta^8u - \dots \right]_{x=x_0}^{x=x_m}$$

$$A = T_1 + h \left[\frac{1}{24}\delta^2u - \frac{1}{720}\delta^4u + \frac{1}{8640}\delta^6u - \frac{1}{51840}\delta^8u + \dots \right]_{x=x_0}^{x=x_m}$$

77 If we do not know values of u outside the figure, we must use advancing or receding differences. The formulae usually employed are

$$A = C_1 + h \left\{ \frac{1}{2}\Delta u_0 - \frac{1}{24}\Delta^2u_0 + \frac{1}{720}\Delta^4u_0 - \frac{1}{8640}\Delta^6u_0 + \dots \right. \\ \left. + \frac{1}{24}\Delta^2u_m - \frac{1}{720}\Delta^4u_m + \frac{1}{8640}\Delta^6u_m - \frac{1}{51840}\Delta^8u_m + \dots \right\},$$

$$A = T_1 + h \left\{ -\frac{1}{24}\Delta^2u_1 + \frac{1}{720}\Delta^4u_1 - \frac{1}{8640}\Delta^6u_1 + \frac{1}{51840}\Delta^8u_1 - \dots \right. \\ \left. - \frac{1}{24}\Delta^2u_{m-1} + \frac{1}{720}\Delta^4u_{m-1} - \frac{1}{8640}\Delta^6u_{m-1} + \frac{1}{51840}\Delta^8u_{m-1} - \dots \right\},$$

where Δ, Δ^2, \dots have the usual meaning ($\Delta u_0 = u_1 - u_0, \Delta^2 u_0 = u_2 - 2u_1 + u_0, \dots$), and Δ', Δ^2, \dots denote differences read backwards, so that $\Delta' u_m = u_{m-1} - u_m, \Delta'^2 u_m = u_{m-2} - 2u_{m-1} + u_m, \dots$. The calculation of the expressions in brackets may be simplified by taking the pairs in terms from the outside; i.e. by finding the successive differences of $u_0 + u_m, u_1 + u_{m-1}, \dots$ or of $u_1 + u_{m-1}, u_2 + u_{m-2}, \dots$

An alternative method, which is in some ways preferable, is to complete the table of differences by repeating the differences of the highest order that will be taken into account (see INTERPOLATION), and then to use central-difference formulae.

78 In order to find the corrections in respect of the terms shown in square brackets in the formulae of § 75, certain ordinates other than those used for C_1 or T_1 are sometimes found specially. *Parmenier's rule*, for instance, assumes that in addition to u_1, u_2, \dots, u_{m-1} , we know u_0 and u_m ; and $u_2 - u_1$ and $u_{m-2} - u_{m-1}$ are taken to be equal to $\frac{1}{2}h u_1'$ and $\frac{1}{2}h u_{m-1}'$ respectively. These methods are not to be recommended except in special cases.

79 By replacing h in § 75 by $2h, 3h, \dots$ and eliminating h^2u'', h^4u''', \dots , we obtain exact formulae corresponding to the approximate formulae of § 70. The following are the results (for the formulae involving chordal areas), given in terms of differential coefficients and of central differences. They are not so convenient as the formulae of § 76, but they serve to indicate the degree of accuracy of the approximate formulae. The expressions in square brackets are in each case to be taken as relating to the extreme values $x = x_0$ and $x = x_m$ as in §§ 75 and 76.

$$(i) A = \frac{1}{2}(4C_1 - C_3) + \left[-\frac{1}{120}h^4u'''' + \frac{1}{120}h^6u'''''' - \frac{1}{120}h^8u'''''''' + \dots \right]$$

$$(ii) A = \frac{1}{2}(9C_1 - C_3) + h \left[-\frac{1}{240}h^2u'' + \frac{1}{240}h^4u'''' - \frac{1}{240}h^6u'''''' + \dots \right]$$

$$(iii) A = \frac{1}{2}(9C_1 - C_3) + h \left[-\frac{1}{240}h^2u'' + \frac{1}{240}h^4u'''' - \frac{1}{240}h^6u'''''' + \dots \right]$$

$$(iv) A = \frac{1}{2}(15C_1 - 6C_2 + C_3) + h \left[-\frac{1}{240}h^2u'' + \frac{1}{240}h^4u'''' - \frac{1}{240}h^6u'''''' + \dots \right]$$

$$(v) A = \frac{1}{2}(15C_1 - 6C_2 + C_3) + h \left[-\frac{1}{240}h^2u'' + \frac{1}{240}h^4u'''' - \frac{1}{240}h^6u'''''' + \dots \right]$$

$$(vi) A = \frac{1}{2}(56C_1 - 28C_2 + 8C_3 - C_4) + h \left[-\frac{1}{120}h^2u'' + \frac{1}{120}h^4u'''' - \frac{1}{120}h^6u'''''' + \dots \right]$$

$$(vii) A = \frac{1}{2}(56C_1 - 28C_2 + 8C_3 - C_4) + h \left[-\frac{1}{120}h^2u'' + \frac{1}{120}h^4u'''' - \frac{1}{120}h^6u'''''' + \dots \right]$$

The general expression, if p, q, r, \dots are h of the factors of m_i , is

$$A = PC_p + QC_q + RC_r + \dots + \left[(-)^p b_1 h^{2p} \frac{d^{2p}u}{dx^{2p}} + \dots \right]_{x=x_0}^{x=x_m}$$

where P, Q, R, \dots have values given by the equations in § 71, and the coefficients b_1, b_2, \dots are found from the corresponding coefficients in the Euler-Maclaurin formula (§ 75) by multiplying them by $P^{2p} + Q^{2q} + R^{2r} + \dots, P^{2p+2} + Q^{2q+2} + R^{2r+2} + \dots$

80. *Moments of a Trapezette*.—The above methods can be applied, as in §§ 59 and 60, to finding the moments of a trapezette, when the

data are a series of ordinates. To find the p th moment, when u_0, u_1, u_2, \dots are given, we have only to find the area of a trapezette whose ordinates are $x_0^p u_0, x_1^p u_1, x_2^p u_2, \dots$

81. There is, however, a certain set of cases, occurring in statistics, in which the data are not a series of ordinates, but the areas A_1, A_2, \dots, A_{m-1} of the strips bounded by the consecutive ordinates u_0, u_1, \dots, u_m . The determination of the moments in these cases involves special methods, which are considered in the next two sections.

82. The most simple case is that in which the trapezette tapers out in such a way that the curve forming its top has very close contact, at its extremities, with the base; in other words, the differential coefficients u', u'', u''', \dots are practically negligible for $x = x_0$ and for $x = x_m$. The method adopted in these cases is to treat the areas A_1, A_2, \dots as if they were ordinates placed at the points for which $x = x_1, x = x_2, \dots$, to calculate the moments on this assumption, and then to apply certain corrections. If the first, second, \dots moments, so calculated, before correction are denoted by ρ_1, ρ_2, \dots , we have

$$\rho_1 = x_1 A_1 + x_2 A_2 + \dots + x_{m-1} A_{m-1}$$

$$\rho_2 = x_1^2 A_1 + x_2^2 A_2 + \dots + x_{m-1}^2 A_{m-1}$$

$$\dots$$

$$\rho_p = x_1^p A_1 + x_2^p A_2 + \dots + x_{m-1}^p A_{m-1}$$

These are called the *raw moments*. Then, if the true moments are denoted by ρ_1, ρ_2, \dots , their values are given by

$$\rho_1 = \rho_1$$

$$\rho_2 = \rho_2 - \frac{1}{2} h^2 \rho_1$$

$$\rho_3 = \rho_3 - \frac{1}{2} h^2 \rho_2 + \frac{1}{24} h^4 \rho_1$$

$$\rho_4 = \rho_4 - \frac{1}{2} h^2 \rho_3 + \frac{1}{24} h^4 \rho_2 - \frac{1}{720} h^6 \rho_1$$

$$\dots$$

where ρ_0 (or ρ_0) is the total area $A_1 + A_2 + \dots + A_{m-1}$; the general expression being

$$\rho_p = \rho_p - \lambda_1 \frac{\rho_1}{1! (p-2)!} h^{2p-2} + \lambda_2 \frac{\rho_2}{2! (p-4)!} h^{2p-4} - \dots$$

where

$$\lambda_1 = \frac{1}{12}, \lambda_2 = \frac{1}{240}, \lambda_3 = \frac{1}{120}, \lambda_4 = \frac{1}{8640}, \lambda_5 = \frac{1}{51840}, \dots$$

The establishment of these formulae involves the use of the integral calculus.

The position of the central ordinate is given by $x = \rho_1/\rho_0$, and therefore is given approximately by $x = \rho_1/\rho_0$. To find the moments with regard to the central ordinate, we must use this approximate value, and transform by means of the formulae given in § 32. This can be done either before or after the above corrections are made. If the transformation is made first, and if the resulting raw moments with regard to the (approximate) central ordinate are $\omega, \omega_2, \omega_3, \dots$, the true moments $\mu_1, \mu_2, \mu_3, \dots$ with regard to the central ordinate are given by

$$\mu_1 = \omega$$

$$\mu_2 = \omega_2 - \frac{1}{2} h^2 \omega$$

$$\mu_3 = \omega_3 - \frac{1}{2} h^2 \omega_2 + \frac{1}{24} h^4 \omega$$

$$\mu_4 = \omega_4 - \frac{1}{2} h^2 \omega_3 + \frac{1}{24} h^4 \omega_2 - \frac{1}{720} h^6 \omega$$

$$\dots$$

83. These results may be extended to the calculation of an expression of the form $\int_{x_0}^{x_m} u \phi(x) dx$, where $\phi(x)$ is a definite function of x , and the conditions with regard to x are the same as in § 82.

(i) If $\phi(x)$ is an explicit function of x , we have

$$\int_{x_0}^{x_m} u \phi(x) dx = \Delta_1 \psi(x_1) + A_1 \psi(x_2) + \dots + A_{m-1} \psi(x_{m-1}),$$

where $\psi(x) \equiv \phi(x) - \frac{\lambda_1}{4} h^2 \phi''(x) + \frac{\lambda_2}{4} h^4 \phi^{(4)}(x) - \dots$,

the coefficients $\lambda_1, \lambda_2, \dots$ having the values given in § 82.

(ii) If $\phi(x)$ is not given explicitly, but is tabulated for the values x_1, x_2, \dots of x , the formula of (i) applies, provided we take

$$\psi(x) \equiv (1 - \frac{1}{2} h^2 \delta^2 + \frac{1}{24} h^4 \delta^4 - \dots) \phi(x).$$

The formulae can be adapted to the case in which $\phi(x)$ is tabulated for $x = x_0, x_1, \dots$

84. In cases other than those described in § 82, the p th moment with regard to the axis of u is given by

$$\rho_p = x^p m A - p S_{p-1}$$

where A is the total area of the original trapezette, and S_{p-1} is the area of a trapezette whose ordinates at successive distances h , beginning and ending with the bounding ordinates, are $0, x_1^{p-1} A_1, x_2^{p-1} (A_1 + A_2), \dots, x_{m-1}^{p-1} (A_1 + A_2 + \dots + A_{m-1}), x_m^{p-1} A$.

The value of S_{p-1} may be found by a quadrature formula. The generalized formula is

$$\int_{x_0}^{x_m} u \phi(x) dx = \Lambda \phi(x_m) - T,$$

where T is the area of a trapezette whose ordinates at successive distances h are $a_0, A_1\phi'(x_1), (A_1 + A_2)\phi'(x_2), \dots, (A_1 + A_2 + \dots + A_{m-1})\phi'(x_{m-1}), A\phi'(x_m)$; the accents denoting the first differential coefficient.

85. *Volumes and Moments of a Briquette.*—The application of the methods of §§ 75-77 to calculation of the volume of a briquette leads to complicated formulæ. If the conditions are such that the methods of § 61 cannot be used, or are undesirable as giving too much weight to particular ordinates, it is best to proceed in the manner indicated at the end of § 48; i.e. to find the areas of one set of parallel sections, and treat these as the ordinates of a trapezette whose area will be the volume of the briquette.

86. The formulæ of § 82 can be extended to the case of a briquette whose top has close contact with the base all along its boundary; the data being the volumes of the minor briquettes formed by the planes $x = x_0, x = x_1, \dots, x = y_0, y = y_1, \dots$. The method of constructing the formulæ is explained in § 62. If we write

$$S_{p,q,r} \equiv \int_{x_0}^{x_m} \int_{y_0}^{y_n} x^p y^q x^r y^s dx dy,$$

we first calculate the raw values $s_{1,1}, s_{1,2}, s_{1,3}, \dots$ of $S_{1,1}, S_{1,2}, S_{1,3}, \dots$ on the assumption that the volume of each minor briquette is concentrated along its mid-ordinate (§ 44), and we then obtain the formulæ of correction by multiplying the formulæ of § 82 in pairs. Thus we find (e.g.)

$$\begin{aligned} S_{1,1}(2s_{1,1}) &= s_{1,1}^2 - \frac{1}{2} h^2 s_{2,1}^2 \\ S_{1,2}(2s_{1,2}) &= s_{1,2}^2 - \frac{1}{2} h^2 s_{2,2}^2 \\ S_{1,3}(2s_{1,3}) &= s_{1,3}^2 - \frac{1}{2} h^2 s_{2,3}^2 \\ S_{1,4}(2s_{1,4}) &= s_{1,4}^2 - \frac{1}{2} h^2 s_{2,4}^2 \\ S_{1,5}(2s_{1,5}) &= s_{1,5}^2 - \frac{1}{2} h^2 s_{2,5}^2 \\ S_{1,6}(2s_{1,6}) &= s_{1,6}^2 - \frac{1}{2} h^2 s_{2,6}^2 \end{aligned}$$

where $s_{2,0}$ is the total volume of the briquette.

87. If the data of the briquette are, as in § 86, the volumes of the minor briquettes, but the condition as to close contact is not satisfied, we have

$$\int_{x_0}^{x_m} \int_{y_0}^{y_n} x^p y^q x^r y^s dx dy = K + L + R - x_m^p y_n^q s_{p,q,0}$$

where $K = x_m^p \times$ pth moment with regard to plane $x = 0$,

$$L = y_n^q \times$$
 qth moment with regard to plane $y = 0$,

and R is the volume of a briquette whose ordinate at (x, y) is found by multiplying by $\rho q x^{p-1} y^{q-1}$ the volume of that portion of the original briquette which lies between the planes $x = x_0, x = x_1, y = y_0, y = y_1$. The ordinates of this new briquette at the points of intersection of $x = x_0, x = x_1, \dots$ with $y = y_0, y = y_1, \dots$ are obtained from the data by summation and multiplication; and the ordinary methods then apply for calculation of its volume. Either or both of the expressions K and L will have to be calculated by means of the formula of § 84; if this is applied to both expressions, we have a formula which may be written in a more general form

$$\begin{aligned} \iint \phi(x, y) dx dy &= \iint \phi(x, y) dx dy \cdot \phi(b, y) \\ &- \int \left\{ \int \phi(x, y) dx \right\} \frac{d\phi(x, y)}{dx} dx \\ &- \int \left\{ \int \phi(x, y) dy \right\} \frac{d\phi(b, y)}{dy} dy \\ &+ \int \left\{ \int \phi(x, y) dx \right\} \frac{d^2\phi(x, y)}{dx dy} dx dy. \end{aligned}$$

The second and third expressions on the right-hand side represent areas of trapezettes, which can be calculated from the data; and the fourth expression represents the volume of a briquette, to be calculated in the same way as R above.

88. *Cases of Failure.*—When the sequence of differences is not such as to enable any of the foregoing methods to be applied, it is sometimes possible to amplify the data by measurement of intermediate ordinates, and then apply a suitable method to the amplified series.

There is, however, a certain class of cases in which no subdivision of intervals will produce a good result; viz. cases in which the top of the figure is, at one extremity (or one part of its boundary), at right angles to the base as R above. Euler-Maclaurin's formula (§ 75) assumes that the bounding values of u, u''', \dots are not infinite; this condition is not satisfied in the cases here considered. It is also clearly impossible to express u as an algebraical function of x and y if some value of du/dx or du/dy is to be infinite.

No completely satisfactory methods have been devised for dealing with these cases. One method is to construct a table for interpolation of x in terms of u , and from this table to calculate the values of x corresponding to values of u , proceeding by equal intervals; a quadrature-formula can then be applied.

Suppose, for instance, that we require the area of the trapezette ABL in fig. 11; the curve being at right angles to the base AL at A. If AQD is the bounding ordinate of one of the component strips, we can calculate the area of QDL in the ordinary way. The data for the area ADQ are a series of values of u corresponding to equidistant values of x ; if we denote by y the distance of a point

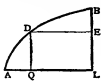

FIG. 11.

on the arc AD from QD, we can from the series of values of u construct a series of values of y corresponding to equidifferent values of u , and thus find the area of ADQ, treating QD as the base. The process, however, is troublesome.

89. *Examples of Applications.*—The following are some examples of cases in which the above methods may be applied to the calculation of areas and integrals.

(i) *Construction of Mathematical Tables.*—Even where u is an explicit function of x , so that $\int u dx$ may be expressed in terms of x , it is often more convenient, for construction of a table of values of such an integral, to use finite-difference formulæ. The formula of § 76 may (see DIFFERENCES, CALCULUS OF) be written

$$\begin{aligned} \int^x u dx &= h \cdot u_0 u + h \left(-\frac{1}{2} \delta u + \frac{1}{24} \delta^3 u - \dots \right) \\ &= h u \left(h u - \frac{1}{2} \delta^2 h u + \frac{1}{24} \delta^4 h u - \dots \right) \\ \int^x u dx &= h \cdot u + h \left(\frac{1}{2} \delta u - \frac{1}{24} \delta^3 u + \dots \right) \\ &= h \left(u + \frac{1}{2} \delta^2 h u - \frac{1}{24} \delta^4 h u + \dots \right). \end{aligned}$$

The second of these is usually the more convenient. Thus to construct a table of values of $\int u dx$ by intervals of h in x , we first form a table of values of hu for the intermediate values of x , from this obtain a table of values of $(h u + \frac{1}{2} \delta u - \frac{1}{24} \delta^3 u + \dots) hu$ for these values of x , and then construct the table of $\int u dx$ by successive additions. Attention must be given to the possible accumulation of errors due to the small errors in the values of u . Each of the above formulæ involves an arbitrary constant; but this disappears when we start the additions from a known value of $\int^x u dx$.

The process may be repeated. Thus we have

$$\begin{aligned} \int^x \int^x u dx dx &= (x + \frac{1}{2} \delta x - \frac{1}{24} \delta^3 x + \dots) h^2 u \\ &= (x^2 + \frac{1}{2} x \delta x - \frac{1}{24} \delta^2 x^3 + \dots) h^2 u \\ &= \frac{1}{2} (h^2 u + \frac{1}{2} \delta^2 h^2 u - \frac{1}{24} \delta^4 h^2 u + \dots). \end{aligned}$$

Here there are two arbitrary constants, which may be adjusted in various ways.

The formulæ may be used for extending the accuracy of tables, in cases where, if v represents the quantity tabulated, $h dv/dx$ or $h^2 d^2v/dx^2$ can be conveniently expressed in terms of v and x to a greater degree of accuracy than it could be found from the table. The process practically consists in using the table as it stands for improving the first or second differences of v and then building up the table afresh.

(ii) *Life Insurance.*—The use of quadrature-formulæ is important in actuarial work, where the fundamental tables are based on experience, and the formulæ applying these tables involve the use of the tabulated values and their differences.

90. The following are instances of the application of approximate formulæ to the calculation of the volumes of solids.

(i) *Timber Measure.*—To find the quantity of timber in a trunk with parallel ends, the areas of a few sections must be calculated as accurately as possible, and a formula applied. As the measurements can only be rough, the trapezoidal rule is the most appropriate in ordinary cases.

(ii) *Gauging.*—To measure the volume of a cask, it may be assumed that the interior is approximately a portion of a spheroidal figure. The formula applied can then be either Simpson's or a rule based on Gauss's theorem for two ordinates (§ 56). In the latter case the two sections are taken at distances $= \frac{1}{3} H / \sqrt{3} = \approx .2887 H$ from the middle section, where H is the total internal length; and their arithmetic mean is taken to be the mean section of the cask. Allowance must of course be made for the thickness of the wood.

91. Certain approximate formulæ for the length of an arc of a circle are obtained by methods similar to those of §§ 71 and 79. Let θ be the radius of a circle, and θ (circular measure) the unknown angle subtended by an arc. Then, if we divide θ into m equal parts, and L_1 denotes the sum of the corresponding chords, so that $L_1 = 2m \sin(\theta/2m)$, the true length of the arc is

$$L_1 + \theta^3 \left\{ \frac{3}{4} \frac{\phi^4}{3!} + \dots \right\}, \text{ where } \phi = \theta/2m. \text{ Similarly, if } L_2 \text{ represents the sum of the chords when } m \text{ (assumed even) is replaced by } \frac{1}{2} m, \text{ we have an expression involving } L_2 \text{ and } \phi. \text{ The method of } \S 71 \text{ then shows that, by taking } \frac{1}{4}(L_1 - L_2) \text{ as the value of the arc, we get rid of terms in } \phi^2. \text{ If we use } L_1 \text{ to represent the chord of the whole arc, } c_2 \text{ the chord of half the arc, and } c_4 \text{ the chord of one quarter of the arc, then corresponding to (i) and (ii) of } \S 70 \text{ or } \S 79 \text{ we have } \frac{1}{4}(L_1 - c_2) \text{ and } \frac{1}{8}(2c_2 - c_4) = \frac{1}{8}(2c_2 - 4c_4 + 1c_4), \text{ as approximations to the length of the arc. The latter of these is } \textit{Weyher's rule}.$$

REFERENCES.—For applications of the prismoidal formula, see Alfred Lodge, *Mensuration for Senior Students* (1895). Other works on elementary mensuration are G. T. Chivers, *Elementary Mensuration* (1904); R. W. K. Edwards, *Elementary Plane and Solid Mensuration* (1902); William H. Jackson, *Elementary Solid Geometry* (1907); P. A. Lambert, *Computation and Mensuration* (1907). A. E. Pierpoint's *Mensuration Formulæ* (1902) is a handy collection. Rules for calculating the areas of solids are also given in such works as F. Case, *Manual of Practical Mathematics* (1903); F. C. Clarke, *Practical Mathematics* (1907); C. T. Mills, *Technical Arithmetic and Geometry*

(1903). For examples of measurement of areas by geometrical construction, see G. C. Turner, *Graphics applied to Arithmetic, Mensuration and Statics* (1907). Discussions of the approximate calculation of definite integrals will be found in works on the infinitesimal calculus; see e.g. E. Goursat, *A Course in Mathematical Analysis* (1905; trans. by E. R. Hedrick). For the methods involving finite differences, see references under DIFFERENCES, CALCULUS OF, and INTERPOLATION. On calculation of moments of graphs, see W. P. Elderton, *Frequency-Curves and Correlation* (1906); as to the formulae of §82, see also *Biometrika*, v. 450. For mechanical methods of calculating areas and moments see CALCULATING MACHINES. (W. F. SH.)

MENTAWI, a chain of islands in the Dutch East Indies, off the west coast of Sumatra, between 1° and 3° $30'$ S. There are twenty-one islands in all, of which the majority lie close to or between the four largest—Siberut, Sikaban or Sipora, North Pagah and South Pagah. The two last (also called Pagi or Poggy) are sometimes termed the Nassau Islands. The total land area is 1224 sq. m. The islands are included in the administration of Padang, Sumatra. They are apparently volcanic. Coral reefs lie off the coasts and render them difficult of access. The natives in language and customs present affinities with some Polynesians, and have been held to be a survival of the eastward immigration of people of Caucasian stock which took place before those which established the "pre-Malay" peoples (such as the Dyaks and Battas) in the Malay Archipelago. The islands produce some coco-nuts, sago, trepang and timber.

MENTEITH, or **MONTEITH**, a district of south Perthshire, Scotland, roughly comprising the territory between the Teith and the Forth. Formerly it was a stewartry and gave the title to an earldom. The title was first held by Gilchrist, a Celtic chief ennobled by Malcolm IV., and passed successively to Walter Comyn (d. 1258), to a branch of the Stewarts, and finally to the Grahams, becoming extinct in 1604. The lake of Menteith, situated $2\frac{1}{2}$ m. S. of Loch Venachar measures $1\frac{1}{2}$ m. long by 1 m. broad, and contains three islands. On Inchmahome (Gaelic, "the Isle of Rest") are the ruins of an Augustinian priory founded in 1238 by Walter Comyn. It is Early English, with an ornate western doorway. The island was the residence of Queen Mary, when a child of five, for a few months before her departure to France in 1548. On Inch Talla stands the ruined tower of the earls of Menteith, dating from 1428. The village of Port of Menteith (pop. of parish, 1088), on the north shore of the lake, is $3\frac{1}{2}$ m. north by west of the station of the same name on the North British Railway Company's Forth & Clyde line.

MENTONE (Fr. *Menton*), a town in the department of the Alpes Maritimes in south-east France, situated on the shore of the Mediterranean, about 15 m. by rail E. of Nice. Pop. (1901), 9944. It is built in the form of an amphitheatre on a rocky promontory, which divides it semicircular bay into two portions. The main town is composed of two parts. Below, along the seashore, is the town of hotels and foreigners, while above, and inaccessible to wheeled vehicles, is that of the native Mentonese, with steep, narrow and dark streets, clinging to the mountain side around the strong castle which was once its protection against pirates. In the old town is the church of St Michel, rebuilt in great part since an earthquake in 1887, while below, in the principal street, the Corniche road, is the monument set up in 1896 to commemorate the union (in 1860) of Mentone with France. East of the main town is the suburb of Garavan, sheltered by cliffs, and filled with hotels. A mile and a half farther on is the Pont St Louis, which marks the frontier between France and Italy, while beyond it Sir Thomas Hanbury's villa at La Murtola is soon reached, with its marvellous gardens of 250 acres. West of the main town more hotels and villas are scattered along the coast towards Cap Martin. This is a pincered promontory which shelters the Bay of Mentone on the west, and is crowned by a great hotel, not far from which is the villa of the ex-empress Eugénie. Facing south-east, and sheltered on the north and west by mountains, the Bay of Mentone has a delicious climate and is frequented by invalids. The mean for the year is 61° F., while that for the winter is 72° in the sun, and 55° in the shade. Frost occurs on the average only once in ten years. Besides the charms of its climate Mentone

offers those of an almost tropical vegetation. Lemon-trees, olive-trees and pines rise in successive stages on surrounding slopes. The district produces 40,000,000 lemons yearly, and this is its principal natural wealth. In the east bay is the harbour, constructed in 1890. It has a depth of about 26 ft., and is sheltered by a jetty about 400 yds. in length. The harbour is frequented by pleasure yachts and a few coasting vessels.

Mentone was probably the Lumone of the Itineraries, as no Roman remains exist. After having belonged to the counts of Ventimiglia and a noble Genoese family, it was purchased about the middle of the 14th century by the Grimaldis, lords of Monaco. During the First Republic and the First Empire it belonged to France, but in 1815 it reverted to the prince of Monaco, who subjected it to such exactions that in 1848 its inhabitants proclaimed the town independent of the west of the principality of the principality of Sardinia. In 1860 both Mentone and Roquebrune were purchased by France from the prince of Monaco, and added to the department of the Alpes Maritimes then formed out of the county of Nice, ceded the same year to France by Sardinia.

MENTOR, in Greek legend, the son of Alcimus and the faithful friend of Odysseus. During the absence of the latter, Mentor was entrusted with the care of his household and the guardianship of his son Telemachus. The word "mentor" is now used in the sense of a wise and trustworthy adviser, a meaning probably connected with the etymology of the name, from the root *mon-*, seen, in Lat. *monere*, to advise, *monitor*, adviser.

The *New English Dictionary* points out that the transferred use is due less to Homer's *Odyssey* than to Fénelon's *Télémaque*, in which Mentor is a somewhat prominent character.

MENTOR OF RHODES, brother of Memnon (*q.v.*), a Greek condottiere who appears first in the service of the rebellious satrap Artabazus of Phrygia in 363. When Artabazus had rebelled a second time and was in 353 forced to flee with Memnon into Macedonia, Mentor entered the service of the Egyptian king Nectanebus, and was sent by him with a body of Greek mercenaries to support the rebellious king Tennes (Tahbit) of Sidon against Artaxerxes III. But Tennes and Mentor betrayed the besieged town to the Persians (344 B.C.). Tennes was killed after his treason, but Mentor gained the favour of the king. It was due largely to him that Egypt was conquered in 343 (Diod. xvi. 45 sqq.). He now closely allied himself with the eunuch Bagoas (*q.v.*), the all-powerful vizier of Artaxerxes III. He was appointed general in Asia Minor, and with the help of Artabazus and Memnon, whose pardon and recall he obtained from the king, subdued the rebels and local dynasts. The most famous among them was Hermias of Atarneus, the protector of Aristotle, who had become master of some towns of Aeolis and Troas. By treachery he made him prisoner and occupied his towns (342 B.C.); Hermias was executed by order of the king (Diod. xvi. 52; Polyæn. vi. 48; pseudo-Arist. *Oeconom.* ii. 27; Strabo xiii. 610; Didymus' commentary on Demosthenes *Phil.* 4, p. 6; cf. Diog. Laërt. vi. 9). Shortly afterwards Mentor died, and was succeeded by his brother Memnon. His son Thymondas commanded in the naval war against Alexander and at Issus (Arrian i. 2, 1; 13, 2).

(ED. M.)
MENZEL, ADOLPH FRIEDRICH ERDMANN VON (1815-1905), German artist, was born at Breslau on the 8th of December 1815. His father was at the head of a school for girls, and intended to educate his son as a professor; but he would not thwart his taste for art. Left an orphan in 1832, Menzel had to maintain his family. In 1833 Sachse of Berlin published his first work, an album of pen-and-ink drawings reproduced on stone, to illustrate Goethe's little poem, "Künstlers Erdenwallen." He executed lithographs in the same manner to illustrate *Denkwürdigkeiten aus der brandenburgisch-preussischen Geschichte*, pp. 834-836; "The Five Senses" and "The Prayer," as well as diplomas for various corporations and societies. From 1839 to 1842 he produced 400 drawings, reviving at the same time the technique of engraving on wood, to illustrate the *Geschichte Friedrichs des Grossen* ("History of Frederick the Great") by Franz Kugler. He subsequently brought out *Friedrichs des Grossen Armee in ihrer Uniformirung* ("The Uniforms of the Army under Frederick the Great"), *Soldaten Friedrichs des Grossen* ("The Soldiers of Frederick the Great"); and finally, by

order of the king Frederick William IV., he illustrated the works of Frederick the Great, *Illustrationen zu den Werken Friedrichs des Grossen* (1843-1849). By these works Menzel established his claim to be considered one of the first, if not actually the first, of the illustrators of his day in his own line. Meanwhile Menzel had set himself to study unaided the art of painting, and he soon produced a great number and variety of pictures, always showing keen observation and honest workmanship—subjects dealing with the life and achievements of Frederick the Great, and scenes of everyday life, such as "In the Tuileries," "The Ball Supper," and "At Confession." Among the most important of these works are "The Forge" (1875) and "The Market-place at Verona." Invited to paint "The Coronation of William I. at Koenigsberg," he produced an exact representation of the ceremony without regard to the traditions of official painting. Menzel died at Berlin on the 9th of February 1905. In Germany he received many honours, and was the first painter to be given the order of the Black Eagle.

MENZEL, WOLFGANG (1798-1873), German poet, critic and literary historian, was born on the 21st of June 1798, at Waldenburg in Silesia, studied at Breslau, Jena and Bonn, and after living for some time in Aarau and Heidelberg finally settled in Stuttgart, where, from 1830 to 1838, he had a seat in the Württemberg Diet. His first work, a clever and original volume of poems, entitled *Streckrose* (Heidelberg, 1823), was followed in 1824-1825 by a popular *Geschichte der Deutschen* in three volumes and in 1829 and 1830 by *Rübezahl und Narcissus*, the dramatized fairy-stories upon which his reputation as a poet chiefly rests. In 1831 he published the romance of *Furor*, a lively picture of the period of the Thirty Years' War; his other writings include *Geschichte Europas*, 1789-1815 (2 vols. Stuttgart, 1853), and histories of the German War of 1866 and of the Franco-German War of 1870-71. From 1826 to 1848 Menzel edited a "Literaturblatt" in connexion with the *Morgenblatt*; in the latter year he transferred his allegiance from the Liberal to the Conservative party, and in 1852 his "Literaturblatt" was revived in that interest. In 1866 his political sympathies again changed, and he opposed the "particularism" of the Prussian "junkers" and the anti-unionism of south Germany. He died on the 23rd of April 1873 at Stuttgart. His library of 18,000 volumes was afterwards acquired for the university of Strassburg.

MENZELINSK, a town of eastern Russia, in the government of Ufa, 142 m. N.W. of the town of Ufa, and 10 m. from the left bank of the Kama. Pop. (1897), 7542. Its fair is one of the most important in the southern Ural region for cattle, hides, furs, grain, tea, manufactured articles, crockery, &c., which are sold to the annual value of £500,000. The town was founded in 1584.

MEPHISTOPHELES, in the Faust legend, the name of the evil spirit in return for whose assistance Faust signs away his soul. The origin of the conception and name of Mephistopheles has been the subject of much learned debate. In *Dr Fausts Hölle* von "Mephistophil" is one of the seven great princes of hell; "he stands under the planet Jupiter, his regent is named Zaddiel, an enthroned angel of the holy Jehovah. . . ; his form is firstly that of a fery bear, the other and fairer appearance is as of a little man with a black cape and a bald head." The origin of the idea of Mephistopheles in Faust's mind is thus clear. He was one of the evil demons of the seven planets, the *Mashim* of the ancient Akkadian religion, a conception transmitted through the Chaldeans, the Babylonians and the Jewish Kabbala to medieval and modern astrologers and magicians. This fact suggests a plausible theory of the origin of the name. In the ancient Mesopotamian religion the Intelligence of Jupiter was Marduk, "the lord of light," whose antithesis was accordingly conceived as the lord of darkness. Mephistopheles, then (or rather Mephistophilis, as the Faust-books spell the name) is "he who does not love light" (Gr. μη, φῶς, φῶσις).²

¹ In the *Faustbuch* of 1587 it is spelt Miphophilis; by Marlowe Mephistophilis; by Shakespeare (*Merry Wives of Windsor*, Act i.) Mephistophilus. The form Mephistopheles adopted by Goethe first appears in the version *des Christlich Meinenden*, c. 1712.

² Kieseewetter, p. 163. To Schröder this derivation seems improbable, and he appears to prefer that from Hebrew *Mephis*, destroyer,

To Faust himself, somnambulist and medium, Mephistopheles had—according to Kieseewetter—a real existence: he was "the objectivation of the transcendental subject of Faust," an experience familiar in dreams and, more especially, in the visions of mediums and clairvoyants. He was thus a "familiar spirit," akin to the "daemon" of Socrates; and if he was also half the devil of theology, half the kobold of old German myth, this was only because such "objectivations" are apt to clothe themselves in forms borrowed from the common stock of ideas current at the time when the seer lives; and Faust lived in an age obsessed with the fear of the devil, and by no means sceptical of the existence of kobolds. It is suggested, then, in the light of modern psychical research, that Mephistopheles, though (as the Faust-books record) invisible to any one else, was visible enough to Faust himself and to Wagner, the *famulus* who shared his somnambulist experiences. He was simply Faust's "other self," appearing in various guises—as a bear, as a little bald man, as a monk, as an invisible presence ringing a bell—but always recognizable as the same "familiar."

The Mephistophiles of the Faust-books and the puppet plays passed with little or no modification into literature as the Mephistophilis of Marlowe's *Faustus*. Mephistophilis has the kobold qualities: he not only waits upon Faustus and provides him with sumptuous fare; he indulges in horse-play and is addicted to practical joking of a homely kind. He is, however, also the devil, as the age gotten the Reformation conceived him: a fallen angel who has not forgotten the splendour of his first estate, and who pictures to Faust the glories of heaven in order to accentuate the horrors of the hell to which he triumphantly drags him. In the tradition, in the scene in Auerbach's *Keller* shows that he has not altogether shed his character as kobold; and, like the planet-spirits of the old magic he appears alternately in animal and human shape. He is also identified with the devil; thus, in accordance with old German tradition, he is dressed as a nobleman (*ein edler Junker*), all in red, with sword; at the witches' Sabbath on the Brocken he is hailed as "the knight who triumphantly drags him," and Sybel in Auerbach's *Keller* is not too drunk not to notice that he limps. But his limp is the only indication that he is Lucifer fallen from heaven. He could not, like Marlowe's Mephistophilis or Milton's Satan, regretfully paint the glories of the height from which he has been hurled; for he denies the distinction between high and low, since "everything that comes into being deserves to be destroyed."³ He is, in short, not the devil of Christian orthodoxy, a spirit conscious of the good against which he is in revolt, but akin to the Evil Principle of the older dualistic systems, with their conception of the eternal antagonism between good and evil, light and darkness, creation and destruction. (See FAUST.) (W. A. P.)

MEPPEL, a town in the province of Drente, Holland, 16½ m. by rail N. by E. of Zwolle. Pop. (1903), 10,470. It is favourably situated at the confluence of a number of canals and rivers which communicate hence with the Zuider Zee by the Meppeler Diep, and rose rapidly into prominence in the 19th century. The chief business is in butter, eggs, cattle and pigs, while bleaching, dyeing and shipbuilding are also carried on here.

MEQUINEZ (the Spanish form of the Arabic *Miknasa*), a city of Morocco, situated 1600 ft. above the sea, about 70 m. from the west coast and 36 m. W.S.W. of Fez, on the road to Rabat, in 33° 56' N., 5° 50' W. The town wall with its four-cornered towers is pierced by nine gates, one, the Báb Bardain, with fine tile-work. A lower wall of wider circuit protects the luxuriant gardens in the outskirts. Mequinez at a distance appears a city of palaces, but it possesses few buildings of any note except the palace and the mosque of Muli Ismail, which serves as the royal burying-place. The palace, founded in 1634, was described in 1821 by John Windus in his *Journey to Mequinez* (London 1825) as "about 4 m. in circumference, the whole building exceeding massy, and the walls in every part very thick; the outward one about a mile long and 25 ft. thick." The interior is composed of oblong court-yards surrounded by buildings and arcades. These buildings are more or less square with pyramidal roofs ornamented outside with green glazed tiles, and inside with and *tophel*, liar (Faust, ed. 1886, i. 25), which is certainly supported by the fact that almost all the names of devils in the magic-books of the 16th century are derived from the Hebrew.

³ Alles was entsteht ist werth dass es zu Grunde geht.

richly carved and painted woodwork in Mauresque style. The walls are tiled to a height of 4 or 5 ft., and above they are finished in plaster, whitewashed or carved into filigree work. The population numbers being between thirty and forty thousand. Idrisi, writing in A.D. 1100, calls the place Takarart, and describes it as an ordinary citadel, from which the town gradually developed, taking its name from the Miknasa Berbers.

MERAN, the chief town of the administrative district of the same name in the Austrian province of the Tirol, 20 m. by rail N.W. of Botzen on the Brenner line, while the Vintschgau railway connects it with Mals, 37 m. N.W. It is the chief town in the upper Adige valley, a region which bears the special name of the Vintschgau, and is on the high road either to Landeck and the Lower Engadine by the Reschen Scheideck Pass (4902 ft.), or more directly to the Lower Engadine by the Münster valley and the Ofen Pass (7071 ft.). In 1900 Meran had 9284 inhabitants (or, with the neighbouring villages of Untermais and Obermais, 13,201), mainly German-speaking and Romanist. The town is picturesquely situated, at a height of 1001 ft., at the foot of the vine-clad Kùchelberg, and on the right bank of the Passer River, just above its junction with the Adige or Etsch. Meran proper consists mainly of one long narrow street, the Laubengasse, flanked by covered arcades, but the name is often used to include several adjacent villages, Untermais and Obermais being on the left bank of the Passer, while Gratsch is on its right bank and north-west of the main town. The most noteworthy buildings are the parish church (14th to 15th centuries) and the old residence (15th century) of the counts of the Tirol. Meran is best known as a much-frequented resort for consumptive patients, for whom it is well suited by reason of the purity of the air and the comparative immunity of the place from wind and rain in the winter. It is also visited in spring for the whey cure and in autumn for the grape cure.

To the north-west, on the Kùchelberg, is the half-ruined castle of Tirol (2096 ft.), the original seat of the family which gave its name to the county. Meran may have been built on the site of a Roman settlement, but is first mentioned in 857. From the 12th century to about 1420 it was the capital of the ever-extending land named after it Tirol, but then had to give way to Innsbruck, while the building of the Brenner railway (1864-1867) and the rise of Botzen have decreased its commercial importance.

(W. A. B. C.)

MERBECK (or **MARBECK**), **JOHN** (d. c. 1585), English theological writer and musician, was organist of St George's, Windsor, about 1540. Four years later he was convicted of heresy and sentenced to the stake, but received a pardon owing to the intervention of Gardiner, bishop of Winchester, though Gardiner had himself censured Merbeck for compiling an English Concordance of the Bible. This work, the first of its kind in English, was published in 1550 with a dedication to Edward VI. In the same year Merbeck published his annotated *Book of Common Prayer*, intended to provide for musical uniformity in the use of the First Prayer Book of Edward VI., which was several times reprinted in the 19th century. Merbeck wrote several devotional and controversial works of a strongly Calvinistic character, and a number of his musical compositions are preserved in manuscript in the British Museum, and at Oxford and Cambridge. He died, probably while still organist at Windsor, about 1585. His son, **ROGER MERBECK** (1536-1605), a noted classical scholar, was appointed public orator in the university of Oxford in 1564, and in 1565 became a canon of Christ Church and was elected provost of Oriel; he left Oxford on account of an unfortunate marriage, and took to medicine as a profession, becoming the first registrar of the College of Physicians in London, and chief physician to Queen Elizabeth.

MERCADIER (d. 1200), French warrior of the 12th century, and chief of freebooters in the service of Richard I. of England. In 1183 he operated for Richard, then duke of Aquitaine, in the Limousin and the Angoumois, taking castles and laying waste the country. We know nothing of him during the ten years 1184-1194, but after Richard's return from Palestine, Mercadier accompanied him everywhere, travelling and fighting by his

side. Richard eulogized Mercadier's exploits in his letters, and gave him the estates left by Adémar de Bainac, who died without heirs about 1190. During the various wars between Richard and Philip Augustus of France, Mercadier fought successively in Berry, Normandy, Flanders and Brittany. When Richard was mortally wounded at the siege of Châlus in March 1199, Mercadier avenged him by hanging the defenders of the château and flaying the crossbowman who had shot the king. Mercadier then entered the service of John, and ravaged Gascony. On Easter Monday, the 10th of April 1200, he was assassinated while on a visit to Bordeaux to pay his respects to Eleanor of Aquitaine, who was bringing from Spain Blanche of Castile. His murderer was an agent of Brandin, another freebooter in the service of John.

See Gerard, *Mercadier*, in *Bibliothèque de l'École des Chartes*, 1st series, t. iii., pp. 417-443.

MERCANTILE (or **COMMERCIAL**) **AGENCIES**, the name given in America to organizations designed to collect, record and distribute to regular clients information relative to the standing of commercial firms. In Great Britain and some European countries trade protective societies, composed of merchants and tradesmen, are formed for the promotion of trade, and members exchange information regarding the standing of business houses. These societies had their origin in the associations formed in the middle of the 19th century for the purpose of disseminating information regarding bankruptcies, assignments and bills of sale. The mercantile agency in the United States is a much more comprehensive organization. It came into existence after the financial crisis of 1837. Trade in the United States had become scattered over a wide territory. Communication was slow, and the town merchant was without adequate information as to the standing of many business men seeking credit. Undoubtedly the severity of the collapse of 1837 was due in part to the insufficiency of this information. New York merchants, who had suffered so severely, determined to organize a headquarters where reports regarding the standing of customers could be exchanged. Lewis Tappan (1788-1873), founder of the *Journal of Commerce* (1828) and a prominent anti-slavery leader, undertook the work, and established in New York, in 1841, the Mercantile Agency, the first organization of its kind. The system has been wonderfully developed and extended since.

MERCANTILE SYSTEM, the name given to the economic policy which developed in Europe at the close of the middle ages. The doctrine of the mercantile system, stated in its most extreme form, made wealth and money identical, and regarded it therefore as the great object of a community so to conduct its dealings with other nations as to attract to itself the largest possible share of the precious metals. Each country's interest was to export the utmost possible quantity of its own manufactures and to import as little as possible of those of other countries, receiving the difference of the two values in gold and silver. This difference is called the balance of trade, and the balance is favourable when more money is received than is paid. Governments might resort to all available expedients—prohibition of, or high duties on, the importation of foreign wares, bounties on the export of home manufactures, restrictions on the export of the precious metals—for the purpose of securing such a balance.

But this statement of the doctrine, though current in textbooks, does not represent correctly the views of all who belonged to the mercantile school. Many members of that school were much too clear-sighted to entertain the belief that wealth consists exclusively of gold and silver. The mercantilists may be best described, as W. G. F. Roscher remarked, not by any definite economic theorem which they held in common, but by a set of theoretic tendencies, commonly found in combination, though severely prevailing in different degrees in different minds. The underlying principles may be enumerated as follows: (1) the importance of possessing a large amount of the precious metals; (2) an exaltation (a) of foreign trade over domestic, and (b) of the industry which works up materials over that which provides them; (3) the value of a dense population as an element of national strength; and (4) the employment of state action in furthering artificially the attainment of the ends proposed.

The discoveries in the New World had led to a large development of the European currencies. The old feudal economy, founded principally on dealings in kind, had given way before the new "money economy," and the dimensions of the latter were everywhere expanding. Circulation was becoming more rapid, distant communications more frequent, city life and movable property more important. The mercantilists were impressed by the fact that money is wealth *sui generis*, that it is at all times in universal demand, and that it puts into the hands of its possessor the power of acquiring all other commodities. The period, again, was marked by the formation of great states, with powerful governments at their head. These governments required men and money for the maintenance of permanent armies, which, especially for the religious and Italian wars, were kept up on a great scale. Court expenses, too, were more lavish than ever before, and a larger number of civil officials was employed. The royal domains and dues were insufficient to meet these requirements, and taxation grew with the demands of the monarchies. Statesmen saw that for their own political ends industry must flourish. But manufactures make possible a denser population and a higher total value of exports than agriculture; they open a less limited and more promptly extensible field to enterprise. Hence they became the object of special governmental favour and patronage, whilst agriculture fell comparatively into the background. The growth of manufactures reacted on commerce, to which a new and mighty arena had been opened by the establishment of colonies. These were then viewed simply as estates to be worked for the advantage of the mother countries, and the aim of statesmen was to make the colonial trade a new source of public revenue. Each nation, as a whole, working for its own power, and the greater ones for predominance, they entered into a competitive struggle in the economic no less than in the political field, success in the former being indeed, by the rulers, regarded as instrumental to pre-eminence in the latter. A national economic interest came to exist, of which the government made itself the representative head. States became a sort of artificial hothouse for the rearing of urban industries. Production was subjected to systematic regulation, with the object of securing the goodness and cheapness of the exported articles, and so maintaining the place of the nation in foreign markets. The industrial control was exercised, in part directly by the state, but largely also through privileged corporations and trading companies. High duties on imports were resorted to, at first perhaps mainly for revenue, but afterwards in the interest of national production. Commercial treaties were a principal object of diplomacy, the end in view being to exclude the competition of other nations in foreign markets, whilst in the home market as little room as possible was given for the introduction of anything but raw materials from abroad. The colonies were prohibited from trading with other European nations than the parent country, to which they supplied either the precious metals or raw produce purchased with home manufactures.

That the efforts of governments for the furtherance of manufactures and commerce under the mercantile system were really effective towards that end is admitted by Adam Smith, and cannot reasonably be doubted, though doctrinaire free-traders have often denied it. Technical skill must have been promoted by their encouragements; whilst new forms of national production were fostered by attracting workmen from other countries, and by lightening the burden of taxation on struggling industries. Communication and transport by land and sea were more rapidly improved; and the social dignity of the industrial professions was enhanced relatively to that of the classes before exclusively dominant.

The foundation of the mercantile system was at the time when it took its rise inspired by the situation of the European nations. Such a policy had been already in some degree practised in the 14th and 15th centuries, thus preceding any formal exposition or defence of its speculative basis. At the commencement of the 16th century it began to exercise a widely extended influence. Charles V. adopted it, and his example contributed much to its predominance. Henry VIII. and Elizabeth conformed their

measures to it. The leading states soon entered on a universal competition for manufacturing and commercial preponderance. Through almost the whole of the 17th century the prize, so far as commerce was concerned, remained in the possession of Holland, Italy having lost her former ascendancy by the opening of the new maritime routes, and Spain and Germany being depressed by protracted wars and internal dissensions. The admiring envy of Holland felt by English politicians and economists appears in such writers as Raleigh, Mun, Child and Temple. Cromwell, by his Navigation Act, which destroyed the carrying trade of Holland and founded the English empire of the sea, and Colbert, by his whole economic policy, domestic and international, were the chief practical representatives of the mercantile system.

See G. Schmoller, *The Mercantile System* (Eng. trans., 1896); also the articles, BALANCE OF TRADE; FREE TRADE; PROTECTION; PHYSIOCRATIC SCHOOL, &c.

MERCAPTANS (Thio-alcohols), organic chemical compounds of the type R.SH (R=an alkyl group). The name is derived from *mercurium captans*, in allusion to the fact that these compounds react readily with mercuric oxide to form crystalline mercury derivatives. The mercaptans may be prepared by the action of the alkyl halides on an alcoholic solution of potassium hydrosulphide; by the reduction of the sulpho-chlorides, e.g. $C_2H_5SO_2Cl$ (chlorides of sulphonic acids), by heating the salts of esters of sulphuric acid with potassium hydrosulphide, and by heating the alcohols with phosphorus pentasulphide. They are colourless liquids, which are insoluble in water and possess a characteristic offensive smell. On oxidation by nitric acid they yield sulphonic acids. They combine with aldehydes and ketones, with elimination of water and formation of mercaptals and mercaptols. (See SULPHONAL.)

Methyl mercaptan, CH_3SH , is a liquid which boils at $5.8^\circ C.$ (75.2 mm.), and forms a crystalline hydrate with water. *Ethyl mercaptan*, C_2H_5SH , is a colourless liquid which boils at $36.2^\circ C.$ It is used commercially in the preparation of sulphonal (*q.v.*). The mercury salt, $Hg(SC_2H_5)_2$, crystallizes from alcohol in plates. When heated with alcohol to $190^\circ C.$ it decomposes into mercury and ethylsulphide.

MERCATOR, GERARDUS [Latinized form of GERHARD KREMER] (1512-1594), Flemish mathematician and geographer, was born at Rupelmonde, in Flanders, on the 5th of March 1512. Having studied at Bois-le-Duc and Louvain (where he matriculated on the 20th of August 1530, and became licentiate in October 1532), he met Gemma Frisius, a pupil of Apian of Ingolstadt, who at the request of the emperor Charles V. had settled in Louvain. From Frisius young Kremer derived much of his inclination to cartography and scientific geography. In 1534 he founded his geographical establishment at Louvain; in 1537 he published his earliest known map, now lost (*Terrae sanctae descriptio*). In 1537-1540 he executed his famous survey and map of Flanders (*Exactissima Flandriae descriptio*), of which a copy exists in the Musée Plantin, Antwerp. At the order of Charles V. Mercator made a complete set of instruments of observation for the emperor's campaigns: when these were destroyed by fire, in 1546, another set was ordered of the same maker. In 1538 appeared Mercator's map of the world in (north and south) hemispheres, which was rediscovered in 1878 in New York; this work shows Ptolemy's influence still dominant over Mercatorian cartography. In 1541 he issued the celebrated terrestrial globe, which he dedicated to Nicolas Perrenot, father of Cardinal Granvelle: this was accompanied by his *Libellus de usu globi*, which is said to have been presented to Charles V. In 1551 a celestial globe followed. Mercator early began to incline towards Protestantism; in 1533 he had retired for a time from Louvain to Antwerp, partly to avoid inquiry into his religious beliefs; in 1544 he was arrested and prosecuted for heresy, but escaped serious consequences (two of the forty-two arrested with him were burnt, one beheaded, two buried alive). He now thought seriously of emigrating; and when in 1552 Cassander, ordered by the duke of Juliers, Cleves and Berg to organize a university at Duisburg, offered Mercator the chair of cosmography the offer was accepted. The organization of the

university was adjourned, and never completed in Mercator's lifetime; but he now became cosmographer to the duke and permanently settled on the German soil to which many of his ancestors and relatives had belonged. Soon after this, however, he paid a visit to Charles V. at Brussels, and presented the emperor with a *cosmos*, a celestial sphere enclosing a terrestrial, together with an explanatory *Declaratio*: this work marks an era in the observation of longitude by magnetic declination, perfected by Halley. Charles rewarded the author with the title of *imperatorii domesticus* (*Hofrath* in the epitaph at Duisburg). In 1554 Mercator published his great map of Europe in six sheets, three or four of which had already been pretty well worked out at Louvain; a copy of this was rediscovered at Breslau in 1880. Herein, though still greatly under Ptolemy's influence, Mercator begins to emancipate himself; thus Ptolemy's 62° for the length of the Mediterranean, reduced to 58° in the globe of 1541, he now cuts down to 53°. On the 28th of October 1556 he observed an eclipse at Duisburg; in 1563 he surveyed Lorraine, at the request of Duke Charles, and completed a map of the same (*Lotharingae descriptio*); but it is uncertain if this was ever published. In 1564 he engraved William Camden's map of the British Isles; in 1568 he brought out his *Chronologia, hoc est temporum demonstratio . . . ab initio mundi usque ad annum domini 1568, ex eclipsibus et observationibus astronomicis*. In the same year was published his memorable planisphere for use in navigation, the first map on "Mercator's projection," with the parallels and meridians at right angles (*Nova et aucta orbis terrae descriptio ad usum navigantium accommodata*). Improvements were introduced in this projection by Edward Wright in 1590; the more general use of it dates from about 1630, and largely came about through Dieppe support. In 1572 Mercator issued a second edition of his map of Europe; in 1578 appeared his *Tabulae geographicæ ad mentem Ptolemei restituae et emendatae*; and in 1585 the first part (containing Germany, France and Belgium) of the *Atlas, sive cosmographicæ meditationes de fabrica mundi*, in which he planned to crown his work by uniting in one volume his various detailed maps, so as to form a general description of the globe. In 1585 he adapted his *Europe* to the *Atlas*; in 1587, with the help of his son Rumold, he added to this same a world-map (*Orbis terrarum compendiosa descriptio*), followed in 1590 by a second series of detailed maps (Italy, Slavonia, Greece and Candia). The rest of the regional and other plans in this undertaking, mostly begun by Gerard, were finished by Rumold; they include Iceland and the Polar regions, the British Isles (dedicated to Queen Elizabeth), the Scandinavian countries (dedicated to Henr. Ranzovius), Prussia and Livonia, Russia, Lithuania, Transylvania, the Crimea, Asia, Africa and America (in the last Michael Mercator, in Asia and Africa Gerard Mercator the younger, assisted). The designs are accompanied by cosmographical and other dissertations, some of the theological views in which were condemned as heretical (see the Duisburg edition of 1594, folio). In 1592 Mercator published, two years after his first apoplectic stroke, a *Harmonia evangeliorum*. He died on the 5th of December 1594, and was buried in St Saviour's church, Duisburg. Besides his famous projection, he did excellent service with Ortelius in helping to free the geography of the 16th century from the tyranny of Ptolemy; his map and instrument work is noteworthy for its delicate precision and admirable execution in detail.

See the *Vita Mercatoris* by Gualterus Ghymsius in the Latin editions of the *Atlas*; *Gerard Mercator, sa vie et ses œuvres*, by Dr J. van Raemdonck (St Nicolas, 1869); A. Breusing, *Gerhard Kremer* (Duisburg, 1878), and article "Mercator" in *Algemeine deutsche Biographie*; General Wauwermans, *Histoire de l'école cartographique belge . . . au XVI^e siècle*, and article "Mercator" in *Biographie nationale* (de Belgique), vol. xiv. (Brussels, 1897). Also the lesser studies of Dr J. van Raemdonck, *Sur les exemplaires des grandes cartes de Mercator*; *Carte de Flandre de Mercator*; *Relations entre Mercator et . . . Plantin . . .* (St Nicolas, 1884); *La Géographie ancienne de la Palestine*; *Lettre de Gérard Mercator . . . mai 22, 1567* (St N., 1884); *Les Sphères terrestre et céleste de Mercator, 1541 . . . 1557* (St N., 1885); Van Ortoy, *L'Œuvre géographique de Mercator*. (C. R. B.)

MERCENARY (Lat. *mercenarius*, from *merces*, reward, gain), one who serves or acts solely for motives of personal gain, particularly a soldier who offers himself for service in any army which may hire him. The name is sometimes used as a term of reproach by nations who raise their armies by conscription, of armies raised by voluntary enlistment whose members are paid a more or less living wage.

MERCER (through Fr. *mercier*, from popular Lat. *mercurius*, a dealer, *merx*, *merces*, merchandise), a dealer in the more costly textiles, especially in silks and velvets. The word formerly had a wider meaning. Mercery, according to W. Herbert (*History of the Twelve Great Livery Companies*, 1834), "comprehended all things sold by retail by the 'little balance' or small scales (in contradistinction to the things sold by the 'beam' or in gross), and included not only toys, together with haberdashery and various other articles connected with dress, but also spices and drugs." Many of the articles in which they dealt fell later within the sphere of other trades; thus the trade in the smaller articles of dress was taken over by the haberdashers (*q.v.*). The trade in silk seems to have been originally in the hands of the "silkmens and throwsters." The Mercers' Company is the first in precedence of the twelve great livery companies of the city of London, and is also the wealthiest both in trust and corporate property. The first charter was obtained in 1393, but the mercers appear to have been formed into a guild much earlier. Herbert finds the mercers as patrons of a charity a few years after 1172, and one Robert Searle, who was mayor in 1214, was a "mercier." A further charter was granted in 1424, with the right to use a common seal. The history of the company is closely connected with the name of Richard Whittington (*q.v.*), and later with that of Dean Colet, who chose the company as the manager of St Paul's School. (See **LIVERY COMPANIES**.)

MERCERIZING, the term applied to a process, discovered in 1844 by John Mercer, a Lancashire calico printer, which consists in treating cotton (and to a limited extent other plant fibres) with strong caustic soda or certain other reagents, whereby morphological and chemical changes are brought about in the fibre. Thus, if a piece of bleached calico be immersed in caustic soda of 50° Tw. strength (sp. gr. 1.25), it rapidly changes in appearance, becoming stiff and translucent, but when taken out and well washed in running water it loses these properties and apparently reverts to its original condition. On closer examination, however, the fabric is found to have shrunk considerably both in length and breadth, so as to render the texture quite different in appearance to that of the original calico; it is also considerably stronger, and if dyed in the same bath along with some of the untreated fabric is found to have acquired a greatly increased affinity for colouring matters. This peculiar action is not restricted to caustic soda, similar effects being obtained with sulphuric acid of 105° Tw., nitric acid of 83° Tw., zinc chloride solution of 145° Tw., and other reagents. Mercer ascertained that a definite compound, corresponding to the formula $C_2H_{12}O_{10}.Na_2O$ is formed when the cotton is steeped in caustic soda, and that this is decomposed by subsequent washing with water into a hydrated cellulose $C_2H_{10}O_9.H_2O$, which would account for the fact that in the air-dried condition mercerized cotton retains about 5% more hygroscopic moisture than ordinary cotton. This view is strengthened by the observation that when cotton is immersed in nitric acid of 83° Tw. it acquires similar properties to cotton treated with caustic soda. If, after immersion in the nitric acid, it is squeezed and then dried (without washing) in a vacuum over burnt lime, it is found to have formed a compound which corresponds approximately to the formula $C_2H_8O_4.HNO_3$, which is decomposed by water into free nitric acid and a hydrated cellulose.

When viewed under the microscope, mercerized cotton is seen to have undergone considerable morphological changes, inasmuch as the lumen or central cavity is much reduced in size, while the fibre has lost its characteristic band-shaped appearance and becomes rounded.

In Mercer's time the process, which he himself termed "sodaizing" or "fulling," never acquired any degree of com-

merical success, partly on account of the expense of the caustic soda required, but mainly on account of the great shrinkage (20 to 25%) which took place in the cloth. An important application of the process in calico printing for the production of permanent crimp or "crepon" effects, which was originally devised by Mercer, was revived in 1890-1891 and is still largely practised by calico printers (see TEXTILE PRINTING). Another application, also dependent upon the shrinking action of caustic soda on cotton, was patented in 1884 by Depouilly, and has for its object the production of crimp effects on piece-goods consisting of wool and cotton or silk and cotton. In the manufacture of such goods cotton binding threads are introduced at definite intervals in the warp or weft, or both, and the piece is passed through cold caustic soda, washed, passed through dilute sulphuric acid, and washed again till neutral. The cotton contracts under the influence of the caustic soda, while both wool and silk remain unaffected, and the desired crimped or puckered effect is thus obtained.

By far the most important application of the mercerizing process is that by which a permanent lustre is imparted to cotton goods; this was discovered in 1889 by H. A. Lowe, who took out a patent for his process in that year, this being supplemented by a further patent in 1890. Since Lowe's invention did not receive sufficient encouragement, he allowed his patents to lapse and the process thus became public property. It was not until 1895, when Messrs Thomas & Prevost repatented Lowe's invention, that actual interest was aroused in the new product and the process became a practical success. Their patent was subsequently annulled on the ground of having been anticipated.

The production of a permanent lustre on cotton by mercerizing is in principle a very simple process, and may be effected in two ways. According to the first method, the cotton is treated in a stretched condition with strong caustic soda, and is then washed, while still stretched, in water. After the washing has been continued for a short time the tension relaxes, and it is then found that the cotton has acquired a permanent lustre or gloss similar in appearance to that of a spun silk though not so pronounced. According to the second method, which constitutes but a slight modification of the first, the cotton is immersed in caustic soda of the strength required for mercerizing, and is then taken out, stretched slightly beyond its original length, and then washed until the tension slackens.

Not all classes of cotton are equally suited for being mercerized. The best are the Egyptian and the Australian lustrous cottons obtained on twofold or multifold yarns spun from long-stapled cotton (Egyptian or Sea Island). Single yarns made from the same quality of cotton are only slightly improved in appearance by the process, and are consequently seldom mercerized; and the same applies to twofold yarns made from ordinary American cotton. In piece-goods, long-stapled cotton also gives the best results, but it is not necessary that the yarn used for weaving should be twofold. In the great majority of cases, the mercerizing of cotton, whether it be in the yarn or in the piece, is done before bleaching, but sometimes it is found preferable to mercerize after bleaching, or even after bleaching and dyeing. The strength of the caustic soda employed in practice is generally between 55° and 60° Tw. The temperature of the caustic soda has a material influence on its action on the cotton fibre, very much stronger solutions being required to produce the same effect at elevated temperatures than at the ordinary temperature, but on the contrary, the temperature of the caustic soda is possible to obtain a good lustre with considerably weaker lyes.

Cotton yarn may be mercerized either in the hank or in the warp, and a great number of machines have been patented and constructed for the purpose. The simplest form of machine for hank consists essentially of two superposed strong steel rollers, on which the hanks are placed and spread out evenly. The upper roller, the bearings of which run in a slotted groove, is then raised by ordinary means until the distance between the two rollers is 60° Tw. is now applied, and the upper roller is caused to revolve slowly, the hanks acting as a belt and causing the lower roller to revolve simultaneously. After about three minutes the caustic soda is allowed to drain off and the hanks are washed by spurt pipes until they slacken, when they are taken off and rinsed, first in dilute sulphuric acid (to neutralize the alkali and facilitate washing), and then in water till neutral. The hanks are then bleached in the ordinary way and may be subsequently dyed, no diminution being brought about in the lustre by these operations. Cotton yarns are usually mercerized on a machine similar in construction to a four box dyeing machine (see DYING), but with the guiding rollers and their bearings of stronger construction and the squeezers at each end of the first box with a double nip (three rollers). The first box contains caustic soda, the second water, the third dilute sulphuric acid, and the fourth water.

For the continuous mercerizing of cotton in the piece much more complicated and expensive machinery is required than for yarn, since it is necessary to prevent contraction in both length and breadth. The mercerizing range in most common use for pieces is constructed on the same principle as the stentering machine used in stretching pieces after bleaching, dyeing or printing, and consists essentially of two endless chains carried at either end by sprocket wheels. The chains carry clips which run in slotted grooves in the horizontal frame of the machine, which is about 40 ft. in length. The clips close automatically and grip the cloth on either side as it is fed on to the machine from the mangle, in which it has been saturated with caustic soda. The stretching of the piece begins immediately on entering the machine, the two rows of clips being caused to diverge by setting the slotted grooves in such a manner that when the piece has travelled about one-third of the length of the machine it is stretched slightly beyond its original width. At this point the piece meets with a spray of water, which is thrown on by means of spurt pipes; and in consequence the tension slackens and the mercerizing is effected. When the piece arrives at the end of the machine the clips open automatically and release it. Thence it passes through a box containing dilute sulphuric acid, and then through a second box where washing with water is effected.

In most large works the caustic soda washings, which were formerly run to waste or were partly used up for bleaching, are evaporated down in multiple effect evaporators to 90° Tw., and the solution is used over again for mercerizing.

Cotton mercerized under tension has not as much affinity for colouring matters as cotton mercerized without tension, and although the amount of hygroscopic moisture which it retains in the air-dried condition is larger than that of cotton in the undressed condition, it is not so great as that held by cotton which has been mercerized without tension. By drying cotton which has been mercerized with or without tension at temperatures above 100° C. its affinity for colouring matters is materially decreased.

The cause of the lustre produced by mercerizing has been variously explained, and in some cases antagonistic views have been expressed on the subject. When viewed under the microscope by reflected light the irregularly twisted and broadened cotton yarns seem to exhibit a strong lustre at those points from which the light is reflected from the surface. Cotton mercerized without tension shows a similar appearance. In the yarn or piece the lustre is not apparent, because the innumerable reflecting surfaces disperse the light in all directions. If, however, the cotton has been mercerized under tension, being plastic while still containing the caustic soda, it is stretched and is set in this condition by the washing. Thus the irregularly twisted and broadened cotton yarns are laid parallel to each other, as in the case of spun silk, and the lustre inherent to the fibre becomes visible to the naked eye.

See *The Life and Labours of John Mercer*, by E. A. Parnell (Longmans Green & Co.); *Die Mercerisation der Baumwolle*, by Paul Gardner (Julius Springer, Berlin); *Mercerisation*, by the editors of *The Dyer and Calico Printer* (Heywood & Co.). (E. K.)

MERCHANT (O. Fr. *marchant*, modern *marchand*; from Lat. *mercari*, to trade, *merx*, goods, merchandise), a trader, one who buys and sells goods for profit. The term is now usually confined to a wholesale dealer or one who trades on an extended scale with foreign countries.

MERCIA, one of the kingdoms of Anglo-Saxon England. The original kingdom seems to have lain in the upper basin of the Trent, comprising the greater part of Derbyshire and Staffordshire, the northern parts of Warwickshire and Leicestershire, and the southern part of Nottinghamshire. The name (*Merco*) seems to denote men of the March, and presumably was first applied when this district bordered upon the Welsh. In later times Mercia successively absorbed all the other territories between the Humber and the Thames except East Anglia, and some districts even beyond the Thames.

The origin of the kingdom is obscure. The royal family, according to Felix, *Life of St Guthlac* (Anglo-Saxon version), were called Iclings. Icel, their ancestor, may have been the founder of the kingdom, but nothing is known of him. The family, however, claimed descent from the ancient kings of Angle (cf. Offa I. and Wermund). The first Mercian king of whom we have any record was Cearl, who apparently reigned about the beginning of the 7th century, and whose daughter Coenburg married Edwin, king of Deira. During Edwin's reign Mercia was subject to his supremacy, though it may have been governed throughout by princes of its own royal family. Its first prominent appearance in English history may be dated in the year 633, when the Mercian prince Penda joined the Welsh king Ceadwalla in overthrowing Edwin. According to the Saxon Chronicle, Penda began to reign in 626, and fought against the

West Saxons at Cirencester in 628. In the Mercian regnal tables, however, he is assigned a reign of only twenty-one years, which, as his death took place in 654 or 655, would give 634 as the date of his accession, presumably on the overthrow of Edwin, or perhaps on that of Ceadwalla. During the reign of Oswald Penda clearly reigned under the suzerainty of that king. In 642, however, Oswald was slain by Penda in a battle at a place called Maserfeld, which has not been identified with certainty. During the early part of Oswio's reign the Northumbrian kingdom was repeatedly invaded and ravaged by the Mercians, and on one occasion (before 651) Penda besieged and almost captured the Northumbrian royal castle at Bamborough. At the same time he extended his influence in other directions, and expelled from the throne of Wessex Coenwalh, who had divorced his sister. Indeed, at this time nearly all the English kingdoms must have acknowledged his supremacy. The kingdom of Middle Anglia, which appears to have included the counties of Northampton, Rutland, Huntingdon, and parts of Bedfordshire, Cambridgeshire, Leicestershire and Lincolnshire, was formed into a dependent principality under his son Peada. At this time also the territory corresponding to the modern counties of Cheshire, Shropshire and Herefordshire seems to have been occupied. The last of these counties is said some time later to have been under the government of another son of Penda, named Merewald. In 654 or 655 Penda again invaded Northumbria, with a huge army divided into thirty *legiones*, each under a royal prince, among whom were Æthelthry, king of East Anglia, and several Welsh kings. He was defeated and slain, however, by Oswio, at a river called the Winwæd. Mercia then came again under Northumbrian rule. Peada, the eldest son of Penda, was allowed to govern the part south of the Trent, while north Mercia was put in charge of Northumbrian officials. Penda, although he did not prohibit the preaching of Christianity, had remained a heathen to the end of his life. His death was followed by the conversion of his kingdom. Peada had embraced Christianity on his marriage with a daughter of Oswio, and under him the first Mercian bishopric was founded. Shortly afterwards Peada was murdered; but in 658 the Mercians rose under his younger brother Wulfhere and threw off the Northumbrian supremacy.

Wulfhere seems to have been a vigorous ruler, for he extended the power of Mercia as far as it had reached in the days of his father, and even farther. According to the Chronicle he invaded Wessex as far as Ashdown in Berkshire in the year 661. At the same time he conquered the Isle of Wight, which he gave to Æthelwath, king of Sussex. Between the years 661 and 665 he was defeated by the Northumbrian king Eggrith and had to give up Lindsey. In 675 he again fought with the West Saxons under Aescwine, and shortly afterwards died. His brother Æthelred, who succeeded him, invaded Kent in the following year, and in 679 fought a battle on the Trent against Eggrith, by which he recovered Lindsey. After this, however, we hear little of Mercian interference with the other kingdoms for some time; and since it is clear that during the last 15 years of the 7th century Wessex, Essex, Sussex and Kent were frequently involved in strife, it seems likely that the Mercian king had somewhat lost hold over the south of England. In 704 Æthelred resigned the crown and became a monk, leaving his kingdom to Coenred, the son of Wulfhere. Coenred also abdicated five years later and went to Rome. Ceolred, the son of Æthelred, who succeeded, fought against the West Saxon king Ine in 715. On his death in the following year Æthelbald, a distant relative, came to the throne, and under him Mercian supremacy was fully restored over all the kingdom south of the Humber. He reigned for 41 years. After his murder in 757 the Mercian throne was held for a short time by Beornred. He was expelled the same year by Offa, who soon restored the power of Mercia, which seems to have suffered some diminution during the later years of Æthelred's reign. Offa's policy was apparently the extinction of the dependencies. In his reign the dynasties of Kent, Sussex and Wessex seem to have disappeared, or at all events to have perished the kingly title. In 787 he associated his son Eggrith

with him in the kingdom, and after his death (796) Eggrith reigned alone for a few months. On the death of Eggrith the throne passed to Coenwulf, a descendant of Pybba, father of Penda. In 821 Coenwulf was succeeded by his brother Ceolwulf, who was deprived of the throne in 823, being succeeded by Beornwulf. In 825 Beornwulf was defeated by Eggrith, king of Wessex, and in the same year he was overthrown and slain by the East Angles. The supremacy now passed to Wessex.

In 827 Ludeca, the successor of Beornwulf, was slain in battle with five of his earls. Wiglaf, who succeeded him, was expelled two years later by Eggrith, but regained the throne in the following year. He died, probably in 839, and was succeeded by Berhtwulf, who reigned until 852. Under these later kings Mercia seems to have extended from the Humber to the Thames, including London, though East Anglia was independent, and that part of Essex which corresponds to the modern county of that name had been annexed to Wessex after 825. Berhtwulf was succeeded in 852 by Burgred, who married Æthelwith, daughter of Æthelwulf. His power seems to have been more or less dependent on the West Saxons. In 853, with the assistance of Æthelwulf he reduced North Wales to subjection. Again in 868 he called upon the West Saxon king Æthelred for assistance against the Danes under Loðbrok's sons, who at this time invaded Mercia after their overthrow of the Northumbrians at York. No battle took place, and the Mercians subsequently made peace with the Danes. In 872 the Danes occupied London on their return from invading Wessex, after which a truce was again made. In 873 the Danes encamped at Torksey in Lincolnshire, and although another truce ensued, they advanced in the following year to Repton, and Burgred was driven from the kingdom. He went to Rome, where he remained until his death. In 874 Ceolwulf, a king's thegn or baron, was made king by the Danes, and definitely acknowledged their overlordship. In 877, after the second invasion of Wessex, the Danes seem to have taken the eastern part of Mercia into their own hands. How long Ceolwulf reigned over the western portion is unknown. About the year 884 the most important person in English Mercia was an earl, Æthelred, who accepted the suzerainty of Alfred, and in or before the year 887 married his daughter Æthelflæd. Æthelred and Æthelflæd appear to have had practically regal power, though they did not use the royal title. In 886 London, which had been recovered by Alfred from the Danes, was restored to Æthelred. During the invasion of 893-97 English Mercia was again repeatedly ravaged by the Danes; but in the last of these years, by the united efforts of Alfred and Æthelred, they were at length expelled. With this exception, Watling Street, the Ouse and the Lea, continued to be the boundary between Mercia and the Danish kingdom of East Anglia down to the death of Æthelred, between 910 and 912. The government was then carried on by Æthelflæd, who built a number of fortresses, and in conjunction with her brother, King Edward the Elder, succeeded in expelling the Danes from Derby and Leicester by the year 917-18. After her death in the latter year her daughter Ælfwyn was soon deprived of the government by Edward, and Mercia was definitely annexed to Wessex. From this time onwards its existence as a separate kingdom was at an end, though during the last years of Eadwig's reign the Mercians and Northumbrians set up Eadgar as king. In the last century of the Saxon period the earls of Mercia frequently occupied a semi-royal position. The most important of these were Ælfhere under Eadgar, Edward and Æthelred, Eadric Streona, under the last-mentioned king, and Leofric, under the Danish kings.

AUTHORITIES.—Bede, *Historia ecclesiastica* (ed. C. Plummer, Oxford, 1896); *Anglo-Saxon Chronicle* (ed. Earle and Plummer, Oxford, 1899); W. de G. Birch, *Carultarian saxonum* (London, 1885-1893). (F. G. M. B.)

MERCÏ, MARIUS JEAN ANTONIN (1845-), French sculptor and painter, was born in Toulouse on the 30th of October 1845. He entered the École des Beaux Arts, Paris, and studied under Falguière and Jouffroy, and in 1868 gained the Grand Prix

de Rome. His first great popular successes were the "David" and "Gloria Victis," which was shown and received the medal of honour of the Salon. The bronze was subsequently placed in the Square Montholon. "The Genius of the Arts" (1877), a relief, is in the Tuileries, in substitution for Barye's "Napoleon III.," a similar work for the tomb of Michelet (1879) is in the cemetery of Père-la-Chaise; and in the same year Mercié produced the statue of Arago with accompanying reliefs, now erected at Perpignan. In 1882 he repeated his great patriotic success of 1874 with a group "Quand Même!" replicas of which have been set up at Belfort and in the garden of the Tuileries. "Le Souvenir" (1885), a marble statue for the tomb of Mme Charles Ferry, is one of his most beautiful works. "Regret," for the tomb of Cabanel, was produced in 1892, along with "William Tell," now at Lausanne. Mercié also designed the monuments to "Meissonnier" (1895), erected in the Jardin de l'Infante in the Louvre, and "Faidherbe" (1896) at Lille, a statue of "Thiers" set up at St Germain-en-Laye, the monument to "Baudry" at Père-la-Chaise, and that of "Louis-Philippe and Queen Amélie" for their tomb at Dreux. His stone group of "Justice" is at the Hôtel de Ville, Paris. Numerous other statues, portrait busts, and medallions came from the sculptor's hand, which gained him a medal of honour at the Paris Exhibition of 1878 and the grand prix at that of 1889. Among the paintings exhibited by the artist are a "Venus," to which was awarded a medal in 1883, "Leda" (1884), and "Michaelangelo studying Anatomy" (1885)—his most dramatic work in this medium. Mercié was appointed professor of drawing and sculpture at the École des Beaux Arts, and was elected a member of the Académie Française in 1891, after being awarded the biennial prize of the institute of £800 in 1887.

MERCIER, HONORÉ (1840-1894), Canadian lawyer and statesman, was the son of Jean Baptiste Mercier, farmer, and of Marie Kimener, his wife. He was born in the village of St Athanasie d'Iberville on the 15th of October 1840. The family came from France, and settled in the district of Montmagny, and later removed to Iberville. Mercier entered the Jesuit College of St Mary, Montreal, at the age of fourteen, and throughout his life retained a warm friendship for the society. He married, firstly in 1866 Leopoldine Boivin, and secondly in 1871 Virginie St Denis. On the completion of his course at St Mary's he studied law in the office of Laframboise and Papineau, in St Hyacinthe, and was admitted to the bar of the province in April 1865. At the age of twenty-two he became the editor of the Conservative *Courrier de St Hyacinthe*, and in this journal supported the policy of the Sicotte administration, which then represented the interests of Quebec, under the Act of Union (1840); but when Sicotte accepted a seat on the bench Mercier joined the Opposition, and contributed largely to the defeat of the Ministerial candidate. In 1864 he vigorously opposed the scheme of confederation, on the ground that it would prove fatal to the distinctive position held by the French Canadians. He resumed the editorship of the *Courrier* in 1866; but after a few months retired from journalism, and for the next five years devoted all his energy to his profession. At the commencement of the year 1871 the national party was organized in Quebec, and Mercier supported the candidates of the party on the platform. In August 1872 he was elected as a member of the House of Commons for the county of Rouville, and proved a vigorous opponent of Sir John A. Macdonald on the question of separate schools for New Brunswick. He was a candidate at the general elections in 1874; but retired on the eve of the contest in favour of another candidate of his own party. Mercier entered the arena of provincial politics in May 1879 as solicitor-general in the Joly government, representing the county of St Hyacinthe; and on the defeat of the ministry in October he passed, with his leader, into opposition. On the retirement of M. Joly from the leadership of the Liberal party in Quebec in 1883 Mercier was chosen as his successor. Towards the close of 1885 the French-Canadian mind was greatly agitated over the execution of Louis Riel, leader of the north-west rebellion, and in consequence of the attitude of Mercier on this question the

Liberal minority in the Legislative Assembly, which had been reduced to fifteen, rapidly gained strength, until at the general elections held in October 1886 the province was carried in the Liberal interest. In January 1887 Mercier was sworn in as premier and attorney-general, and from this moment he exercised an extraordinary influence in the province. He succeeded in passing without opposition the Jesuit Estates Act, a measure to compensate the order for the loss of property confiscated by the Crown. This act came before the Federal House for disallowance, but was carried on division. When Mercier appealed to the electorate in 1890, his policy was endorsed, and he was able to give effect to many important measures. Early in 1891 he negotiated a loan in Europe for the province, and whilst on a visit to Rome he was created a count of the Roman Empire by Leo XIII., who three years previously had conferred upon him the rank of a commander of the order of St Gregory the Great. Of commanding presence, firm, decisive, courteous in manner, convincing in argument, and deeply attached to his native province, he had all the qualities of a popular leader. For a few years he was the idol of the people of Quebec, and French Canada loomed large in the public eye; but towards the end of 1891 serious charges were preferred against his ministry, on the ground that subsidies voted for railways had been diverted to political use, and he was dismissed by the lieutenant-governor. At the subsequent elections held in March 1892 he was returned for the county of Bonaventure, but his party was hopelessly defeated. On the formation of a new government he was brought to trial, and declared not guilty; his health, however, gave way, and he never regained his former influence.

See *Biographie, discours, conférences, &c.*, of l'Hon. Honoré Mercier, by J.-O. Fêland (Montreal, 1893). (A. G. D.)

MERCIER, LOUIS SEBASTIEN (1740-1814), French dramatist and miscellaneous writer, was born in Paris on the 6th of June 1740. He began his literary career by writing heroic epistles, but early came to the conclusion that Boileau and Racine had ruined the French language, and that the true poet was he who wrote in prose. The most important of his miscellaneous works are *L'An 2440* (1770); *L'Essai sur l'art dramatique* (1773); *Néologie* (1801); *Le Tableau de Paris* (1781-1788); *Le nouveau Paris* (1790); *Histoire de France* (1802) and *Satire contre Racine et Boileau* (1808). He decried French tragedy as a caricature of antique and foreign customs in bombastic verse, and advocated the *comédie larmoyante* as understood by Diderot. To the philosophers he was entirely hostile. He denied that modern science had made any real advance; he even carried his conservatism so far as to maintain that the earth was a circular flat plain around which revolved the sun. Mercier wrote some sixty dramas, among which may be mentioned *Jean Hennuyer* (1772); *La Destruction de la ligue* (1782); *Jennetel* (1769); *Le Juge* (1774); *Natalie* (1775) and *La Brouette du vinaigrier* (1775). In politics he was a Moderate, and as a member of the Convention he voted against the death penalty for Louis XVI. During the Terror he was imprisoned, but was released after the fall of Robespierre. He died in Paris on the 25th of April 1814.

See Léon Bechard, *Sebastien Mercier, sa vie, son œuvre* (Paris, 1903); R. Doumic in the *Revue des deux mondes* (15th July 1903).

MERCK, JOHANN HEINRICH (1741-1791), German author and critic, was born at Darmstadt on the 11th of April 1741, a few days after the death of his father, a chemist. He studied law at Giessen, and in 1767 was given an appointment in the paymaster's department at Darmstadt, and a year later himself became paymaster. For a number of years he exercised considerable influence upon the literary movement in Germany; he helped to found the *Frankfurter gelehrte Anzeigen* in 1772, and was one of the chief contributors to Nicolai's *Allgemeine Bibliothek*. In 1782 he accompanied the Landgravine Karoline of Hesse-Darmstadt to St Petersburg, and on his return was a guest of the duke Charles Augustus of Weimar in the Wartburg. Unfortunate speculations brought him into pecuniary embarrassment in 1788, and although friends, notably Goethe, were ready to come to his assistance, his losses—combined with the death of five of his children—so preyed upon his mind that he committed

suicide on the 27th of June 1701. Merck distinguished himself mainly as a critic; his keen perception, critical perspicacity and refined taste made him a valuable guide to the young writers of the *Sturm und Drang*. He also wrote a number of small treatises, dealing mostly with literature and art, especially painting, and a few poems, stories, narratives and the like; but they have not much intrinsic importance. Merck's letters are particularly interesting and instructive, and throw much light upon the literary conditions of his time.

Merck's *Ausgewählte Schriften zur schönen Literatur und Kunst* were published by A. Stahr in 1849, with a biography. See *Briefe an J. H. Merck von Goethe, Herder, Wieland und anderen bedeutenden Zeitgenossen* (1835), *Briefe an und von J. H. Merck* (1838) and *Briefe aus dem Freundeskreise von Goethe, Herder, Höpfer und Merck* (1847), all edited by K. Wagner. Cf. G. Zimmermann, *J. H. Merck, seine Umgebung und seine Zeit* (1871).

MERCCEUR, SEIGNEURS AND DUKES OF. The estate of Merccœur in Auvergne, France, gave its name to a line of powerful lords, which became extinct in the 14th century, and passed by inheritance to the dauphins of Auvergne, counts of Clermont. In 1426 it passed to the Bourbons by the marriage of Jeanne de Clermont, dauphine of Auvergne, with Louis de Bourbon, count of Montpensier. It formed part of the confiscated estates of the Constable de Bourbon, and was given by Francis I. and Louise of Savoy to Antoine, duke of Lorraine, and his wife, Renée de Bourbon. Nicolas de Lorraine, son of Duke Antoine, was created duke of Merccœur and a peer of France in 1569. His son Philippe Emmanuel (see below) left a daughter, who married the duc de Vendôme in 1609.

MERCCEUR, PHILIPPE EMMANUEL DE LORRAINE, Duc DE (1558-1602), French soldier, was born on the 9th of September 1558, and married Marie de Luxembourg, duchesse de Penthièvre. In 1582 he was made governor of Brittany by Henry III., who had married his sister. Merccœur put himself at the head of the League in Brittany, and had himself proclaimed protector of the Roman Catholic Church in the province in 1588. Invoking the hereditary rights of his wife, who was a descendant of the dukes of Brittany, he endeavoured to make himself independent in that province, and organized a government at Nantes, calling his son "prince and duke of Brittany." With the aid of the Spaniards he defeated the duc de Montpensier, whom Henry IV. had sent against him, at Craon in 1592, but the royal troops, reinforced by English contingents, soon recovered the advantage. The king marched against Merccœur in person, and received his submission at Angers on the 20th of March 1598. Merccœur subsequently went to Hungary, where he entered the service of the emperor Rudolph II., and fought against the Turks, taking Stuhlweissenburg (Székes-Fehérvár) in 1599. Merccœur died on the 19th of February 1602.

MERCURY (MERCURIUS), in Roman mythology, the god of merchandise (*merx*) and merchants; later identified with the Greek Hermes. His nature is more intelligible and simple than that of any other Roman deity. In the native Italian states no trade existed till the influence of the Greek colonies on the coast introduced Greek customs and terminology. It was no doubt under the rule of the Tarquins that merchants began to ply their trade. Doubtless the merchants practised their religious ceremonies from the first, but their god Mercurius was not officially recognized by the state till the year 495 B.C. Rome frequently suffered from scarcity of grain during the unsettled times that followed the expulsion of the Tarquins. Various religious innovations were made to propitiate the gods; in 496 the Greek worship of Demeter, Dionysus and Persephone was established in the city, and in 495 the Greek god Hermes was introduced into Rome under the Italian name of Mercurius (Livy ii. 21, 27), as protector of the grain trade, especially with Sicily. Preller thinks that at the same time the trade in grain was regulated by law and a regular college or guild of merchants instituted. This college was under the protection of the god; its annual festival was on the 15th (the *ides*) of May, on which day the temple of the god had been dedicated at the southern end of the Circus Maximus, near the Aventine; and the members were called *mercuriales* as well as *mercatores*. Mommsen, however,

considers the *mercuriales* to be a purely local guild—the *pagani* of the Circus valley. The 15th of May was chosen as the feast of Mercury, obviously because Maia was the mother of Hermes, that is of Mercury; and she was worshipped along with her son by the *mercuriales* on this day. According to Preller, this religious foundation had a political object; it established on a legitimate and sure basis the trade between Rome and the Greek colonies of the coast, whereas formerly this trade had been exposed to the capricious interference of government officials. Like all borrowed religions in Rome, it must have retained the rites and the terminology of its Greek original (Festus p. 257). Mercury became the god, not only of the *mercatores* and of the grain trade, but of buying and selling in general; and it appears that, at least in the streets where shops were common, little chapels and images of the god were erected. There was a spring dedicated to Mercury between his temple and the Porta Capena; every shopman drew water from this spring on the 15th of May, and sprinkled it with a laurel twig over his head and over his goods, at the same time entreating Mercury to remove from his head and his goods the guilt of all his deceits (Ovid, *Fasts*, v. 673 seq.). The word *mercurialis* was popularly used as equivalent to "cheat."

Roman statuettes of bronze, in which Mercury is represented, like the Greek Hermes, standing holding the caduceus or staff in the one hand and a purse in the other (an element very rare in purely Hellenic representations), are exceedingly common.

MERCURY, in astronomy, the smallest major planet and the nearest to the sun; its symbol is ☿. Its proximity to the sun makes the telescopic study of its physical constitution extremely difficult. The result is that less is known on this subject than in the case of any other planet. Even the time of rotation on its axis is uncertain. J. H. Schröter inferred a period of rotation of 24 h. 5 m. 30 s., which was in seeming agreement with the observations of K. L. Harding. This period was generally accepted, though Herschel had been unable to see any changes indicating rotation. In 1882 G. Schiaparelli began a careful study of the face of the planet with a refractor of 8 in. aperture, subsequently replaced by one of 18 in. His unexpected conclusion was that the rotation of Mercury resembles that of the moon, in having its period equal to that of its orbital revolution. As the moon always presents the same face to the earth, so Mercury must, in this case, always present very nearly the same face to the sun. Schiaparelli also announced that the axis of rotation of the planet is nearly perpendicular to the plane of its orbit. The rotation being uniform, while the orbital motion, owing to the great eccentricity of the orbit, is affected by a very large inequality, it would follow that there is a libration in longitude of nearly 24° on each side of the mean position. Percival Lowell in 1897 took up the question anew by combining a long series of measured diameters of the planet with drawings of its apparent surface. The seeming constancy of the surface appearance was considered to confirm the view of Schiaparelli as to the slow rotation of the planet. But there is wide room for doubt on the question.

The period of orbital revolution of Mercury is nearly 88 days, or somewhat less than three months. Consequently, the period of synodic revolution is less than four months, during which the entire round of phases is completed. When near greatest elongation Mercury shines as a star of the first magnitude, or brighter; but in the latitudes of central and northern Europe it is so near the horizon soon after sunset as to be generally obscured by vapours or clouds.

The eccentricity of the orbit, 0.20, is far greater than that of any major planet, and nearly the average of that of the minor planets. Consequently, its distance and its greatest elongation from the sun vary widely with its position in its orbit at the time.

The mass of Mercury can be determined only from its action upon Venus; this is so small that the result is doubtful. Leverrier adopted in his tables 1: 3,000,000 as the ratio of the mass of Mercury to that of the sun. S. Newcomb, from the action upon Venus, reduced this to one-half its amount, or 1: 6,000,000.

G. W. Hill, basing his conclusions on the probable density of the planet, estimated the mass to be less than 1:10,000,000. The adoption of a mass even as large as that of Newcomb implies a greater density than that of the earth, but it is not possible to estimate the probability that such is the case.

The most interesting phenomenon connected with Mercury is that of its occasional transit over the disk of the sun at inferior conjunction. These occur only when the planet is near one of its nodes at the time. The earth, in its orbital revolution, passes through the line of the nodes of Mercury about the 8th of May and the 10th of November of each year. It is only near one of these times that a transit can occur. The periodic times of Mercury and the earth are such that the transits are generally repeated in a cycle of 46 years, during which 8 transits occur in May and 6 in November. The following table shows the Greenwich mean time of the middle of all the transits from 1677, the date of the first one accurately observed, until the end of the present century.

Transits of Mercury from 1677 to 2003.

h.				h.			
1677	Nov.	7	0	1845	May	8	8
1690	Nov.	9	18	1848	Nov.	9	2
1697	Nov.	2	18	1861	Nov.	11	20
1707	May	5	11	1868	Nov.	4	19
1710	Nov.	6	11	1878	May	6	7
1723	Nov.	9	5	1881	Nov.	7	-3
1736	Nov.	10	22	1891	May	9	14
1740	May	2	11	1894	Nov.	10	7
1743	Nov.	4	22	1907	Nov.	14	0
1753	May	5	18	1914	Nov.	7	0
1756	Nov.	6	16	1924	May	7	14
1769	Nov.	9	10	1927	Nov.	9	18
1776	Nov.	2	10	1940	Nov.	11	11
1782	Nov.	12	3	1953	Nov.	14	5
1786	May	3	18	1957	May	5	13
1789	Nov.	5	3	1960	Nov.	7	5
1799	May	7	1	1970	May	8	20
1802	Nov.	8	21	1973	Nov.	9	23
1815	Nov.	11	15	1986	Nov.	12	16
1822	Nov.	4	14	1993	Nov.	5	16
1832	May	5	0	1999 ¹	Nov.	15	9
1835	Nov.	7	8	2003	May	6	19

A perplexing problem is offered by the secular motion of the perihelion of Mercury. In 1845 Leverrier found that this motion, as derived from observation of the transits, was greater by 35^o per century than it should be from the gravitation of all the other planets. This conclusion has been fully confirmed by subsequent investigations, a recent discussion showing the excess of motion to be 43^o per century. It follows from this either that Mercury is acted upon by some unknown masses of matter, or that the intensity of gravitation does not precisely follow Newton's law. The most natural explanation was proposed by Leverrier, who attributed the excess of motion to the action of a group of intra-Mercurial planets. At first this conclusion seemed to be confirmed by the fact that occasional observations of the transit of a dark object over the sun had been observed. But no such observation was ever made by an experienced astronomer, and the frequent photographs of the sun, which have been taken at the Greenwich observatory and elsewhere since 1870, have never shown the existence of any such body. We may therefore regard it as certain that, if a group of intra-Mercurial planets exists, its members are too small to be seen when projected on the sun's disk. During the eclipses of 1900 and 1905 the astronomers of the Harvard and Lick Observatories photographed the sky in the neighbourhood of the sun so fully that the stars down to the 7th or 8th magnitude were imprinted on the plates. Careful examination failed to show the existence of any unknown body. It follows that if the group exists the members must be so small as to be entirely invisible. But in this case they must be so numerous that they should be visible as a diffused illumination on the sky after sunset. Such an illumination is shown by the zodiacal light. But such a group of bodies, if situated in the plane of the ecliptic, would produce a motion of the node of Mercury equal to that of its perihelion, while the observed motion

¹ Mercury grazes sun's limb.

of the node of Mercury is somewhat less than that computed from the gravitation of the known planets. The same is true of the node of Venus, which might also be affected by the same attraction. To produce the observed result, the inclination of the ring would have to be greater than that of the orbit of either Mercury or Venus. In 1895 Newcomb showed that the observed motions, both of the perihelion of Mercury and of the nodes of Mercury and Venus, could be approximately represented by the attraction of a ring of inter-mercurial bodies having a mean inclination of 9^o and the mean node in 48^o longitude. He also showed that if the ring was placed between the orbits of Mercury and Venus, the inclination would be 7.5^o and the longitude of the node 35^o. The fact that the zodiacal light appears to be near the ecliptic, and the belief that, if it were composed of a lens of discrete particles, their nodes would tend to scatter themselves equally around the invariable plane of the solar system, led him to drop these explanations as unsatisfactory, and to prefer provisionally the hypothesis that the sun's gravitation is not exactly as the inverse square. (See GRAVITATION.)

In 1896 H. H. Seeliger made a more thorough investigation than his predecessor had done of the attraction of the matter producing the zodiacal light, assuming it to be formed of a series of ellipsoids. He showed that the motions of the nodes and perihelion could be satisfactorily represented in this way. The following are the three principal elements of the hypothetical orbits as found by the two investigators:—

	Newcomb.		Seeliger.
	Intra-Mercurial Ring.	Ring between Mercury and Venus.	Zodiacal Light Matter.
Inclination . . .	9 ^o	7.5 ^o	6-9 ^o
Node	48 ^o	35 ^o	40-0 ^o
Mass	—	1/37,000,000	1/2,860,000

The demonstration by E. W. Brown that the motion of the moon's perigee is exactly accordant with the Newtonian law of gravitation, seems to preclude the possibility of any deviation from that law, and renders the hypothesis of Seeliger the most probable one in the present state of knowledge. But the question is still an open one whether the zodiacal light has an inclination of the ecliptic as great as that computed by Seeliger. This is a difficult one because the action on Mercury is produced by the inner portions of the matter producing the zodiacal light. These are so near the sun that they cannot be observed, unless possibly during a total eclipse. (S. N.)

MERCURY (symbol Hg, atomic weight = 200), in chemistry, a metallic element which is easily distinguished from all others by its being liquid at even the lowest temperatures naturally occurring in moderate climates. To this exceptional property it owes the synonyms of *quicksilver* in English (with the Germans *Quecksilber* is the only recognized name) and of *hydrargyrum* (from *hōop*, water, and *ἀργυρος*, silver) in Graeco-Latin. This metal does not appear to have been known to the ancient Jews, nor is it mentioned by the earlier Greek writers. Theophrastus (about 300 B.C.) mentions it as prepared from cinnabar by treatment with copper and vinegar; Dioscorides obtained it from the same mineral with the aid of iron, employing at the same time a primitive distillation apparatus. With the alchemists it was a substance of great consequence. Its appearance commended it as a substance for investigation; many of its compounds, especially corrosive sublimate and calomel, were studied, and improved methods for extracting and purifying the metal were devised. Being ignorant of its susceptibility of freezing into a compact solid, they did not recognize it as a true metal, and yet, on the authority of Geber, they held that mercury (meaning the predominating element in this metal) enters into the composition of all metals, and is the very cause of their metallicity (see ELEMENT). When, about the beginning of the 16th century, chemistry and scientific medicine came to merge into one, this same mysterious element of "mercury" played a great part in the theories of pathology; and the metal,

in the free as in certain combined states, came to be looked upon as a powerful medicinal agent.

Occurrence.—Mercury occurs in nature chiefly in the form of a red sulphide, HgS, called cinnabar (*q.v.*), which, as a rule, is accompanied by more or less of the reguline metal—the latter being probably derived from the former by some secondary reaction. The most important mercury mines in Europe are those of Almaden in Spain and of Idria in Illyria; and in America those of California and Texas. Deposits also occur in Russia, the Bavarian palatinate, in Hungary, Italy, Transylvania, Bohemia, Mexico, Peru and in some other countries.

Mercury occurs in formations of all ages from the Archean to the Quaternary, and it has been found in both sedimentary and eruptive rocks of the most varied character, *e.g.* conglomerates, sandstones, shales, limestones, quartzites, slates, serpentines, crystalline schists, and eruptive rocks from the most acid to the most basic. It appears that nearly all known deposits occur along lines of continental uplift, where active shearing of the formations has occurred. Large deposits are seldom found in eruptive rocks, but generally near such formations or near active or extinct hot springs. The deposits are of many types, simple fissure veins being less usual than compound, reticulated, or linked veins. Segregations and impregnations are very common. The form of the deposit seems to depend chiefly on the physical properties and structure of the enclosing rocks and the nature of the fissure systems that result from their disturbance. The principal ore is cinnabar, though metacinnabarite and native mercury are often abundant; the selenide (tiemannite), chloride, and iodide are rare. Of the associated heavy minerals, pyrite (or marcasite) is almost universal, and chalcopyrite, tetrahedrite, blende and realgar are frequent. Many deposits contain traces of gold and silver, and some deposits, as the Mercur in Utah, are more valuable for their gold than their mercury content. The usual gangue-forming minerals are quartz, dolomite, calcite, barite, fluorspar and various zeolites. Some form of bituminous matter is one of the most universal and intimate associates of cinnabar. Formerly quicksilver deposits were supposed to be formed by sublimation, but from a careful study of the California occurrences S. B. Christy was convinced as early as 1875 that this was unlikely, and that deposition from hot alkaline sulphide solutions was more probable. By treating the black mercuric sulphide with such solutions, hot and under pressure, he succeeded in producing artificial cinnabar and metacinnabarite. He also showed that the mineral water at the New Almaden mines, when charged with sulphuric acid and heated under pressure, was capable of effecting the same change, and that this method of production agreed better with all the facts than the sublimation theory. (See *Genesis of Cinnabar Deposits*, "Amer. Jour. Science," xvii, 453.) The investigations of Dr G. F. Becker on the "Quicksilver Deposits of the Pacific" (*U.S. Geol. Survey, Mon. xiii*, 1888) established the correctness of these views beyond doubt.

Production.—At one time the world's supply of mercury was almost entirely derived from the Almaden and Idrian mines; but now the greater proportion is produced in California and Texas, where cinnabar was used by the Indians as a pigment, and first turned to metallurgical purpose in 1845 by Castellero. In the United States mercury has also been found in Utah, Nevada, Oregon and Arizona. In the 16th century the Almaden and Idrian mines were practically the only producers of this metal; statistics of Almaden dating from 1564 and of Idria since 1525 are given in B. Neumann, *Die Metalle* (1904). Spain produced 1151 metric tons in 1870, and in 1889 its maximum of 1975 tons; since then it has, on the whole, been decreasing. The Austria-Hungary output steadily increased to about 550–600 tons at which it appears to remain. In 1887 Russia produced 64 tons, and has steadily improved. The United States output was over 1000 tons, in 1871, and declined to 800–900 in the period 1889–1892; it has since increased and surpassed the supply from Spain. The following table gives the production in various countries for selected years:—

	Spain.	United States.	Russia.	Austria-Hungary.	Italy.	Mexico.	Total (Metric Tons).
1901	754	1031	368	558	278	128	3120
1902	1425	1208	416	556	259	191	4056
1903	914	1288	362	567	314	188	3633
1904	1020	1192	393	581	357	190 ¹	3733
1905	800	1043	318	564	370	190 ¹	3285

¹ Estimated.

Mercury is transported in steel bottles closed by a screw stopper; the Almaden and Idrian bottles contain 76 lb; and until the 1st of June 1904, the Californian bottles contained 76½ lb of mercury; they now hold 75 lb. From the smaller works the metal is sometimes sent out in sheepskin bags holding 55 lb of mercury.

Metallurgy.—Chemically speaking, the extraction of mercury from its ores is a simple matter. Metallic mercury is easily volatilized, and separated from the gangue, at temperatures far below redness, and cinnabar, as a result of the reaction, proceeds to the metallic state by the action of iron or lime or atmospheric oxygen, the sulphur being eliminated, in the first case as iron sulphide, in the second as calcium sulphide and sulphate, in the third as sulphur dioxide. A close iron retort would at first suggest itself as the proper kind of apparatus for carrying out these operations, and this idea was, at one time, acted upon in a few small establishments—for instance, in that of Zweibrücken in the Palatinate, where lime was used as a decomposing agent; but the method has now been discarded. In all the large works the decomposition of the cinnabar is effected by the direct exposure of the ore to the oxidizing flame of a furnace, and the mercury vapour, which gets diffused through an immense mass of combustion gases, is recovered in more or less imperfect condensers.

With the exception of the massive deposits of Almaden in Spain and a few of those in California and Idria, cinnabar occurs in forms so disseminated as to make its mining very expensive. Rude hand-sorting of the ores is usually practised. Wet concentration has not been successful, because it necessitates ore crushing and extensive slime losses of the brittle cinnabar. As a rule low-grade ores can be roasted directly with less loss and expense. At Almaden in Spain the ores average from 7 to 7%, but in other parts of the world much poorer ores have to be treated. In California, in spite of the high cost of labour, improved furnaces enable ores containing not more than ½% to be mined and roasted at a profit.

The furnaces originally used at Almaden and Idria differ only in the condensing plant. The roasting was carried out in internally fired, vertical shafts of brickwork, and, at Almaden, the vapours were led through a series of bottles named *ahudels*, so arranged that the neck of one entered the side of the next; and at Idria the vapours were led into large brickwork chambers lined with cement, and there condensed. The aludel furnace, which was designed in 1633 by Lopez Saavedra Barba in Huancavelica, Peru (where cinnabar was discovered in 1566), and introduced at Almaden in 1646 by Bustamante, by whose name it is sometimes known, has now been entirely given up. The Idrian furnace was designed in 1787 by von Leithner; it was introduced at Almaden in 1800 by Larrañaga, and used side by side with the aludel furnace. The crude mercury is purified by straining through dense linen or chamois leather bags.

The most important improvements in the metallurgy of mercury are the introduction of furnaces for treating coarse ores, and the replacement of the old discontinuous furnaces by those which work continuously. The most successful of these continuous furnaces was a modification of Count Rumford's continuous lime-kiln. This furnace was introduced at New Almaden by J. B. Randol, the author of many improvements in the metallurgy of mercury. The success of the continuous coarse-ore furnace at New Almaden led Randol to attempt the continuous treatment of fine ores also, and the Huebner and Scott continuous fine-ore furnace, which was the result of these experiments, solved the problem completely. It contains several vertical shafts in which the descending ore is retarded at will by inclined shelving, which causes it to be exposed to the flames as long as may be necessary to roast it thoroughly. The time of treatment is determined by the rapidity with which the roasted ore is withdrawn at the bottom. Several similar furnaces are in use, as the Knox and Osborne, the Livermore and the Cormack-Spirek. The fumes from the roasting furnaces are received in masonry chambers, usually provided with water-cooled pipes; from these they pass through earthenware pipes, and finally through others of wood and glass. Not all the yield is in liquid mercury; much of it is entangled in masses of soot that cover the condenser walls, and this is only recovered after much labour.

The conditions for effective condensation are: (1) The furnace gases should be well oxidized, to avoid the production of an excess of soot. Gas firing would meet this requirement better than the use of wood or coal. (2) The volume of permanent gases passing through the furnace should be reduced to a minimum consistently with complete oxidation. (3) The cross-section of the condensers should be sufficient to reduce the velocity of the escaping gases, and the surface large enough for cooling and for the adhesion of condensed mercury. The latter requirement is best provided for by hanging wooden aprons in the path of the cooled gases. (4) The temperature of the escaping gases should not exceed 15° to 20° C., but cooling below this temperature would not give any adequate return for the expense. Cooling by water is quicker, but more expensive than by air. Water sprays, acting directly on the fumes, have not given good results, on account of the difficulty of recovering "floured" quicksilver from the water. (5) The use of an artificial inward draught is absolutely necessary to control the operation of the

furnaces and condensers and to avoid the salivation of the workmen. (6) The condenser should be easily and quickly cleaned during the operation of the furnace. (7) Both furnaces and condensers should have inclined iron plates in their foundations to prevent the infiltration of mercury. (8) There is a great need of some substance for the construction of quicksilver condensers which shall be strong enough to be made thin, be a good conductor of heat, and be resistant to abrasion and the alternate action of heat and cold. It should also resist the action of mercury and warm dilute sulphuric acid, and be not too expensive.

Quicksilver is best removed from the "soot," not by pressure, but by the opposite treatment. A machine in use for this purpose at New Almaden, devised by Colonel von Leitch, consists of an iron bowl, perforated at the bottom, in which revolves a vertical shaft carrying a propeller blade which tosses the soot (mixed with wood ash) into a little coal oil into the air, so that the tangled mercury is free to run out through the bottom of the bowl. The residue from which no more mercury can be extracted mechanically is returned to the roasting furnace.

The losses of treatment are: (1) Furnace loss, which is easily reduced to nothing, and (2) condenser loss, which can never be zero. The latter consists of mercury lost as vapour and as mist, and its minimum amount is determined not by the richness of the ore but by the volume of escaping gases, their velocity and temperature. The percentage of loss will be higher with a poorer than a rich ore. On a 3% ore the losses need not exceed 3 or 4% ore content. On a 1% ore they will run from 5 to 10%. But in poorly arranged plants under bad management they may easily be doubled or even trebled. The Huettnert and Scott fine-ore furnace costs with condensers in California about \$30,000, and roasts from 30 to 45 tons of ore (from 23 in. to dust) in 24 hours at a cost of from \$1 to \$0-62 per ton.

Purification.—Commercial mercury, as a rule, only needs to be forced through canvas leather or allowed to run through a very fine hole to become fit for all ordinary applications; but the metal, having the power of dissolving most other metals, is very liable to get contaminated and requires then to be purified. For this purpose many chemical methods have been proposed; the commonest consist in allowing the metal to fall in a very fine stream through a column of a mixture of nitric acid and mercurous nitrate, or of sulphuric acid, or of potassium bichromate and sulphuric acid; the metal being subsequently dried and filtered through a perforated paper filter. The only really exhaustive method is distillation in a vacuum out of a glass apparatus. Many forms of apparatus have been devised to effect this. Recent researches have shown, however, that the metal so obtained is not chemically pure, there being found in the distillate traces of other metals. Absolutely pure mercury does not at all adhere to any surface which does not consist of a metal soluble in mercury. Hence the least quantity of it, when placed on a sheet of paper, forms a neatly rounded-off globule, which retains its form on being rolled about, and, when subdivided, breaks up into a number of equally perfect globules, which tend to coalesce when sufficiently near to each other. The presence in it of the minutest trace of lead or tin causes it to "draw tails." A very impure metal may adhere even to glass, and in a glass vessel, instead of the normal convex, form an irregular flat meniscus.

Properties.—Pure mercury is a freely flowing liquid, which does not wet objects placed in it, and has a silvery white colour and perfect metallic lustre; in very thin layers it transmits a bluish-violet light. It freezes at about -39°C . (Mallet gives -38.85° ; Hutchins, -39.44°) with contraction, and the formation of a white, very ductile and malleable mass, easily cut with a knife, and exhibiting crystals belonging to the cubic system. When heated the metal expands very uniformly, and vaporizes at about 360° ; the volatility is generally increased by the presence of impurities; its high expansion and the wide range of temperature over which it is fluid render it especially valuable as a thermometric fluid (see THERMOMETRY). The vapour is colourless, and its density points to the conclusion that the molecules are monatomic. Its specific gravity at 0° is 13.5959, i.e. it is about half as heavy again as copper volume for volume, a quarter as heavy again as lead, and nearly twice as heavy as zinc; this property is turned to account in the construction of barometers and air-pumps. Its specific heat is about 0.0333 (see CALORIMETRY); its electrical conductivity is involved in the definition of the ohm (see CONDUCTION, ELECTRIC); and its thermal conductivity is about two thirds that of silver.

Pure mercury remains unchanged in dry air, oxygen, nitrous oxide, carbon dioxide, ammonia and some other gases at ordinary temperatures; hence its application for collecting and measuring gases. In damp air it slowly becomes coated with a film of mercurous oxide; and when heated for some time in air or oxygen it becomes transformed into the red mercuric oxide, which decomposes into mercury and oxygen when heated to

a higher temperature; this reaction is of great historical importance, since it led to the discovery of oxygen at the hands of Priestley and Scheele. The halogen elements and sulphur combine directly with the metal. Mercury is unattacked by dilute sulphuric acid; the strong acid, however, dissolves it on heating with the formation of sulphur dioxide and mercurous or mercuric sulphate according as mercury is in excess or not. Hydrochloric acid has no action. Dilute nitric acid readily attacks it, mercurous nitrate being formed in the cold with excess of mercury, mercuric nitrate with excess of acid, or with strong acid, in the warm. The metal dissolves in solutions containing chlorine or bromine, and consequently in aqua regia.

Mercury readily dissolves many metals to form a class of compounds termed amalgams, which have considerable applications in the arts.

Compounds of Mercury.

Mercury forms two well-defined series of salts—the mercurous salts derived from the oxide Hg_2O , and the mercuric salts from the oxide HgO ; the existence of these salts can hardly be inseparably connected with a variable valency, i.e. that mercury is monovalent in mercurous, and divalent in mercuric compounds, for according to Baker mercurous chloride or calomel (*q.v.*) has the formula Hg_2Cl_2 . Mercurous oxide, Hg_2O , is an amorphous dark brown powder formed when caustic potash acts on calomel; it is decomposed by light or on trituration into mercury and mercuric oxide. Mercuric oxide, HgO , occurs in two forms: it is obtained as a bright-red crystalline powder (also known as "red precipitate," or as *mercurius praecipitatus per se*) by heating the metal in air, or by calcining the nitrate, and as an orange-yellow powder by precipitating a solution of a mercuric salt with potash; the difference is probably one of subdivision. The yellow form is the most reactive and is transformed into the red when heated to 400° . If the red oxide be heated it becomes black, regaining its colour on cooling, and on further heating to 630° it decomposes into mercury and oxygen. It is slightly soluble in water, to which it imparts an alkaline reaction and strongly metallic taste. A peroxide is obtained as a brown solid from mercury and slightly acid 30% hydrogen peroxide at low temperatures.

Mercurous and mercuric chlorides, known respectively as calomel (*q.v.*) and corrosive sublimate (*q.v.*), are two of the most important salts of mercury. Mercurous bromide, Hg_2Br_2 , is a yellowish-white powder, insoluble in water. Mercurous iodide, Hg_2I_2 , forms white crystals, sparingly soluble in cold water, readily in hot, and prepared by the direct union of its components. Mercurous iodide, Hg_2I_2 , is a yellowish-green powder obtained by heating its components to about 250° , or by triturating them with a little alcohol; it is also obtained by precipitating a solution of mercurous nitrate with potassium iodide. It is blackened by exposure to light. Mercuric iodide, HgI_2 , exists in two crystalline forms. By mixing solutions of mercurous chloride and potassium iodide under a microscope, yellow rhombic plates are seen to be formed which are transformed very quickly into scarlet quadratic octahedra. On heating to about 125° the red form is transformed into the yellow modification; on cooling the reverse gradually occurs, and immediately if the yellow iodide be touched. Mercuric iodide is insoluble in water, but soluble in absolute alcohol; and also in potassium iodide solution, with the formation of K_2HgI_4 , which may be obtained in lemon-yellow crystals. A strongly alkaline solution of this salt is known as Nessler's reagent, and is specially used for determining traces of ammonia (see below). Mercuric iodide dissolves in other iodide solutions to form similar compounds; these solutions are characterized by their exceptionally high specific gravity, and hence are employed in density determinations (see DENSITY). It also forms many other double salts. Oxidation with strong nitric acid gives the iodate, $\text{Hg}(\text{IO}_3)_2$. An iodide, Hg_2I_2 , intermediate between mercurous and mercuric iodides, is obtained as a yellow insoluble powder by precipitating mercurous nitrate with a solution of iodine in potassium iodide. Mercurous fluoride, Hg_2F_2 , and mercuric fluoride, HgF_2 , are unstable substances obtained from the corresponding oxide and hydrofluoric acid.

Mercurous Nitrate, $\text{Hg}_2(\text{NO}_3)_2 \cdot 2\text{H}_2\text{O}$, is obtained as a white crystalline salt soluble in water by dissolving the metal in cold dilute nitric acid; if the metal be in excess a basic salt $\text{Hg}_2(\text{NO}_3)_2 \cdot 2\text{Hg}_2\text{O}$ is obtained. Several other basic salts are known. By adding ammonia to a solution of mercurous nitrate a black precipitate of variable composition, known in pharmacy as *mercurius solubilis Hahnemannii*, is obtained.

Mercuric Nitrate.—By dissolving mercuric oxide in strong nitric acid there is obtained a thick liquid which, on hot crystallizing, and which, on addition of strong nitric acid, with hot precipitate of $2\text{Hg}(\text{NO}_3)_2 \cdot \text{H}_2\text{O}$. Water decomposes it to give basic salts of variable composition. By dissolving the oxide in dilute nitric acid, the basic salt $\text{Hg}(\text{NO}_3)_2 \cdot \text{HgO} \cdot \text{H}_2\text{O}$, crystallizing in needles, is obtained.

Mercurous Sulphide, Hg_2S , is an unstable black powder obtained by acting with sulphuretted hydrogen, diluted with carbon dioxide, on calomel at -10° . It decomposes into mercuric sulphide and mercury at 0° . Mercuric sulphide, HgS , is one of the most important

mercury compounds; it is the principal ore, occurring in nature as the mineral cinnabar (*c.v.*), and is extensively used as a pigment, vermilion (*m.v.*). It is obtained as a black powder by triturating mercury with sulphur, the compound thus formed being known in pharmacy as *Aethiops mineralis*, and also by precipitating a mercuric salt with sulphuretted hydrogen. It is only slightly acted upon by nitric acid; it dissolves in aqua regia; chlorine gives a yellow compound, $2\text{HgS} \cdot \text{HgCl}_2$; and it dissolves in potassium sulphide solutions to form double salts of variable composition.

Mercurous Sulphate. Hg_2SO_4 is a white, sparingly soluble, crystalline substance obtained by adding sodium sulphate to a solution of mercurous nitrate. **Mercuric sulphate**, HgSO_4 is a white, soluble salt obtained by dissolving mercury in hot strong sulphuric acid; on digestion with water, it decomposes into a basic salt $\text{HgSO}_4 \cdot 2\text{H}_2\text{O}$ known as *turbith* or *turbith mineral*, and into an acid salt, $\text{HgSO}_4 \cdot 2\text{SO}_4$.

Mercury Phosphide, Hg_3P_2 , is obtained as brilliant red, hexagonal crystals by heating mercury with phosphorus iodide to 300° and removing the mercuric iodide simultaneously formed by means of potassium iodide solution. **Mercurous phosphate**, Hg_2PO_4 , and **mercuric phosphate**, $\text{Hg}_3(\text{PO}_4)_2$, are obtained as white precipitates by adding sodium phosphate to solutions of mercurous and mercuric nitrates respectively.

Mercurammonium Compounds.—By the action of ammonia and ammonium salts mercuric compounds yield a number of substances, many of which have long been used in medicine. By the action of dry ammonia on calomel mercurous-ammonium chloride, NH_4HgCl_2 is obtained; aqueous ammonia on calomel yields mercurous-ammonium chloride, $\text{NH}_4\text{Hg}_2\text{Cl}_2$. By adding ammonia to a solution of mercuric chloride, mercurammonium chloride, known in pharmacy as "infusible white precipitate," NH_4HgCl_2 is obtained; "fusible white precipitate" is mercurous-diammonium chloride, $\text{Hg}(\text{NH}_4\text{Cl})_2$, and is obtained by adding a solution of mercuric chloride to hot solutions of ammonium chloride and ammonia so long as the precipitate first formed redissolves; the substance separates out on cooling. By precipitating a strongly alkaline solution of mercuric iodide in potassium iodide (Nessler's solution) there is obtained a yellow precipitate of $\text{NH}_4\text{Hg}_2\text{OI}$; this reaction is the most delicate test for ammonia, a yellow coloration being given by minute traces. By passing dry ammonia over precipitated mercuric oxide at 130° , a nitride N_2Hg is obtained. The oxide and ammonia solution gives the stable and basic mercurhydroxylamine, NH_2HgOH . The constitution of these compounds has been especially studied by K. A. Hofmann and E. C. Marburg (*Zeit. Anorg. Chem.*, 23, p. 126); these chemists formulate "infusible precipitate" as $\text{Hg}(\text{NH}_4\text{Cl})_2$, "fusible precipitate" as $\text{Hg}(\text{NH}_4\text{Cl})_2$ with a small base of $\text{Hg}_2(\text{NH}_4\text{Cl})_2$, the postulating three distinct types of compounds: (1) amidochlorides; (2) amines; (3) substituted ammonium derivatives.

Analysis.—Mercury compounds, when heated in a closed tube with sodium carbonate, yield a grey to black sublimate of metallic mercury, which readily unites to form visible globules. The metal is precipitated from solutions by digestion with bright copper-foil, a coating being formed on the copper, which becomes silvery on rubbing, and disappears when the quicksilver copper is heated in a sublimation tube.

Solutions of mercurous salts with hydrochloric acid give a white precipitate of calomel, which becomes jet-black on treatment with ammonia. Stannous chloride, in its twofold capacity as a chloride and a reducing agent, precipitates both mercurous and mercuric solutions, at first as calomel, and on addition of an excess of reagent the precipitate becomes grey through conversion into finely-divided quicksilver. Sulphuretted hydrogen, when added very gradually to an acid mercuric solution, gives at first an almost white precipitate, which, on addition of more and more reagent, assumes successively a yellow, orange and at last jet-black colour. The black precipitate is HgS , which is identified by its great solubility, and by being insoluble in boiling nitric and in boiling hydrochloric acid. A mixture of the two (aqua regia) dissolves it as chloride.

"Mercurous" mercury is quantitatively estimated by precipitating as calomel and weighing the precipitate on a tared filter at 100° . The metal may also be estimated by distillation in a closed tube with lime, the metal being collected and weighed, or by precipitating the solution with an excess of stannous chloride. More convenient is the method of precipitating as sulphide by an excess of sulphuretted hydrogen, and weighing the precipitate on a tared filter; or by means of a Gooch crucible.

Pharmacology and Therapeutics

The use of mercury as a therapeutic agent is of comparatively recent date. To the Greeks and Romans its value was unknown, and the Arabian physicians only used it for skin affections. It was not till the middle of the 16th century that the special properties of mercury were fully appreciated, but since that time the metal has continued to hold a high though fluctuating value as a medicine. At first the metal in a finely divided state or in vapour was used; but very soon its various compounds were

found to be endowed with powers even greater than those of the metal itself, and with the discovery of new compounds the number of mercurial medicines has largely increased.

The British Pharmacopœia contains some twenty-five mercurial preparations, including those of calomel (*c.v.*). Only the useful preparations will be mentioned here. Free mercury is contained in Hydrargyrum cum Creta, or "grey powder," which consists of one part of mercury to two of prepared chalk. The power of this valuable and widely used preparation varies somewhat with its age, as old specimens contain some mercuric oxide, which makes them more active. The dose is 1–5 gr., and the preparation is usually employed for children. The Pilula Hydrargyri, or "blue pill," contains one part of mercury in three, and the dose is 4–8 gr. It is usually employed for adults. There are also five preparations of free mercury for external use. Of these the most useful is the Unguentum Hydrargyri, or "blue ointment," which contains one part of mercury in two. Weaker ointments are also prepared from the red and the yellow forms of mercuric oxide. The perchloride of mercury or corrosive sublimate is therapeutically the most important salt of mercury. The dose is $\frac{1}{2}$ – $\frac{1}{4}$ gr. It is incompatible with alkalis, alkaline carbonates, potassium iodide, albumen and many other substances, and should therefore be prescribed alone. It is decomposed by impure water, and distilled water is therefore used in making the Liquor Hydrargyri Perchloridi, in which form it is usually prescribed. This contains half a grain of the perchloride to the fluid ounce and its dose is 30–60 minims. The perchloride is also used in the form of a wash, the *Liquor Hydrargyri Flava*, or "yellow wash," which contains two grains of the salt to the fluid ounce. Mercuric iodide is an equally potent salt and has come into wide use of late years. It has the same dose as the perchloride and is largely prescribed in the *Liquor Arsenii et Hydrargyri Iodidi*, or Donovan's solution, which contains 1% of arsenious iodide and 1% of mercuric iodide, the dose being 5–20 minims. An ointment widely used is prepared from the mercurammonium chloride (*Unguentum Hydrargyri ammoniatum*) of which it contains one part in ten. It is known as "white precipitate ointment."

In discussing the pharmacology of mercury and its compounds, it is of the first importance to observe that metallic mercury is inert as such, and that the same may practically be said of mercurous salts generally. Both mercury itself and mercurous salts tend to be converted in the body into mercuric salts, to which the action is due. When metallic mercury is triturated or exposed to air it is partly oxidized, the first stage of its transformation to an active condition being thus reached.

Metallic mercury can be absorbed by the skin, passing in minute globules through the ducts of the sweat-shanks. The mercury contained in "blue ointment" is certainly thus absorbed, actually circulating in the blood in a very different form, as described below. There is no local action on the skin. The mercuric salts, and especially the chloride and iodide, are probably the most powerful of all known antiseptics. One part of the perchloride in 500,000 will prevent the growth of anthrax bacilli, and one part in 2000—the strength commonly employed in surgery—kills all known bacteria. The action is apparently specific and not due to the fact that perchloride of mercury precipitates albumen, including the albuminous bodies of bacteria. The iodide is still more powerful, but is inactive, though it does not coagulate albumen. These salts cannot be employed for sterilizing metallic instruments, which they tarnish. As these drugs are essentially poisons they must be used with the greatest care in surgical practice, and as they are particularly deleterious to the secreting structure of the kidney they must not be employed as antiseptics in diseases where renal inflammation is already present or probable. They are therefore contra-indicated for application to the throat in scarlet-fever or to the uterus in eclampsia. The stronger mercurial ointments kill cutaneous parasites and also possess some degree of antipruritic action, especially when the cause of the itching is somewhat obscure. Mercuric salts, when in strong solution, are caustic. It is important to observe that the volatility of metallic mercury and many of its compounds causes their absorption by the lungs even when no such effect is intended to follow their external application. This fact explains the occurrence of chronic mercurial poisoning in certain trades.

Single doses of mercury or its compounds have no action upon the mouth, the characteristic salivation being produced only after many doses. Their typical action on the bowel is purgative, the effect varying with the state of the mercury. So related is metallic mercury that a pound of it has been given without ill effects in cases of intestinal obstruction, which it was hoped to relieve by the mere weight of the metal. Half a grain of the perchloride, on the other hand, is a highly toxic dose. The action of mercurials on the bowel is mostly exerted on the duodenum and jejunum, though the lower part of the bowel is slightly affected. Hence a dose of mercury usually needs a saline aperient to complete its action, as in the "blue pill and black draught" of former days. Mercurials do not cause, and in the plebeian doses, an increase in the intestinal secretion, the action being merely exerted upon the muscular wall of the bowel. The bile is rapidly removed from the duodenum, before any re-absorption can occur, and the bacterial action which

decomposes the bile-pigment is arrested by the antiseptic power of the drug, so that the excreta are of a very dark colour. The classical experiments of William Rutherford (1839-1899), of Edinburgh, showed that calomel does not increase the amount of bile formed by the liver. Corrosive sublimate does, however, stimulate the liver to a slight degree. The value of calomel in hepatic torpor is as an excretory, not a secretory, cholagogue, the gall-bladder being stimulated to expel its stagnant contents. In large doses mercurials somewhat diminish the secretion of bile. The greater part of the mercury administered by the mouth, in whatever form, is excreted as mercuric sulphide. Prior to this decomposition the mercury exists as a complex soluble compound with sodium, chlorine and albumen. When perchloride of mercury is injected subcutaneously the sodium chloride in the blood similarly prevents the precipitation of the albuminate of mercury, and it is therefore desirable to add a little sodium chloride to the solution for injection of mercuric chloride.

Some observers assert that mercury is a hæmætic, increasing, like iron, the amount of hæmoglobin in the blood. Whilst this is doubtful it is certain that large doses, when continued, produce marked anaemia. The excretion of the drug is accomplished by all the secreting glands, including the breasts, if these are functioning. All the secretions of the body, except that of the peptic glands of the stomach, are stimulated, but the excretion of mercury is slow, and it is typically one of the drugs that are cumulative, like arsenic and digitalis.

Mercury is largely used in affections of the alimentary canal, and has an obscure but unquestionable value in many cases of heart-disease and arterial degeneration. But its value in syphilis (see VENEREAL DISEASES) far outweighs all its other uses.

Toxicology.—Acute poisoning by mercurials usually occurs in the case of corrosive sublimate. There is intense gastro-intestinal inflammation, with vomiting, frequent "rice-water" stools and extreme collapse. The treatment, except when the case is seen at once, is very difficult, but white-of-egg or other form of albumen is the antidote, forming an insoluble compound with the perchloride.

Chronic poisoning (hydrargyriзм or mercurialism) is of great importance, since any indication of its symptoms must be closely watched for in patients who are under mercurial treatment. Usually the first symptom is slight tenderness of the teeth whilst eating, and some foetor of the breath. These symptoms become more marked and the gums become the seat of severe inflammation, being spongy, vascular and prone to bleed. The salivary glands are swollen and tender, and the saliva pours from the mouth, and may amount to pints in the course of a day. The teeth become quite loose and may fall out. The symptoms are aggravated until the tongue and mouth ulcerate, the jaw-bone necroses, hæmorrhages occur in various parts of the body, and the patient dies of anaemia, septic inflammation or exhaustion. The treatment consists in abstinence from the intake of poison and relieving the symptoms, in the administration of potassium iodide in small, often repeated doses.

BIBLIOGRAPHY.—For the history of mercury see B. Neumann, *Die Metalle* (1904); A. Rossing, *Geschichte der Metalle* (1901). The general chemistry is treated in detail in O. Dammer, *Handbuch der anorganischen Chemie*, and H. Moissan, *Traité de chimie minérale*. For the metallurgy reference may be made to Carl Schnabel, *Handbook of Metallurgy*, vol. ii. (1906), translated by H. Louis.

MERCY (or **MERCY**), **FRANZ**, **FREIHERR VON**, lord of Mandre and Collenburg (d. 1645), German general in the Thirty Years' War, who came of a noble family of Lorraine, was born at Longwy between 1590 and 1598. From 1606 to 1630 he was engaged in the imperial service. By the latter year he had attained high military rank, and after distinguishing himself at the first battle of Breitenfeld (1631) he commanded a regiment of foot on the Rhine and defended Rheinfelden against the Swedes with the utmost bravery, surrendering only after enduring a five-months' siege. He now became a general officer of cavalry (*General-Feldwachtmeister*), and in 1635, 1636 and 1637 took part in further campaigns on the Rhine and Doubs. In September 1638 he was made master-general of ordnance in the army of Bavaria, then the second largest army in Germany. In the next campaign he was practically commander-in-chief of the Bavarians, and at times also of an allied army of Imperialists and Bavarians. He was now considered one of the foremost soldiers in Europe, and was made general field marshal in 1643, when he won his great victory over the French marshal Rantzau at Tuttlingen (Nov. 24-25), capturing the marshal and seven thousand men. In the following year Mercy opposed the French armies, now under the duke of Enghien (afterwards the great Condé) and the vicomte de Turenne. He fought, and in the end lost, the desperate battle of Freiburg, but revenged himself next year by inflicting upon Turenne the defeat of Mergentheim (Marienthal). Later in 1645, fighting once more against Enghien and Turenne, Mercy was killed at the battle of Nördlingen (or

Allerheim) at the crisis of the engagement, which, even without Mercy's guiding hand, was almost a drawn battle. He died on the 3rd of August 1645. On the spot where he fell, Enghien erected a memorial, with the inscription *Sto viator, heroeum calcas*.

His grandnephew **CLAUDIUS FLORIMOND**, **COUNT MERCY DE VILLET** (1666-1734), Imperial field marshal, son of his brother Kaspar, who fell at Freiburg, was born in Lorraine, and entered the Austrian army as a volunteer in 1682. He won his commission at the great battle of Vienna in the following year; and during seven years of campaigning in Hungary rose to the rank of Rittmeister. A wound sustained at this time permanently injured his sight. For five years more, up to 1697, he was employed in the Italian campaigns, then he was called back to Hungary by Prince Eugène and won on the field of Zenta two grades of promotion. He displayed great daring in the first campaigns of the Spanish Succession War in Italy, twice fell into the hands of the enemy in fights at close quarters and for his conduct at the surprise of Cremona (Jan. 31, 1702) received the emperor's thanks and the proprietary colonelcy of a newly raised cuirassier regiment. With this he took part in the Rhine campaign of 1703, and the battle of Friedlingen, and his success as an intrepid leader of raids and forays became well known to friend and foe. He was on that account selected early in 1704 to harry the elector of Bavaria's dominions. He was soon afterwards promoted *General-Feldwachtmeister*, in which rank he was engaged in the battle of the Schellenberg (July 2, 1704). In the rest of the war he was often distinguished by his fiery courage. He rose to be general of cavalry in the course of these ten years. His resolute leadership was conspicuous at the battle of Peterwardein (1716) and he was soon afterwards made commander of the Banat of Temesvár. At the great battle of Belgrade (1717) he led the second line of left wing cavalry in a brilliant and decisive charge which drove the Turks to their trenches. After the peace he resumed the administration of the Banat, which after more than 150 years of Turkish rule needed a humane and capable governor. But before his work was done he was once more called away to a command in the field, this time in southern Italy, where he fought the battle of Francavilla (June 20, 1719), took Messina and besieged Palermo. For eleven years more he administered the Banat, reorganizing the country as a prosperous and civilized community. In 1734 he was made a general field marshal in the army, but on the 29th of June was killed at the battle of Parma while personally leading his troops. He left no children, and his name passed to Count Argenteau, from whom came the family of Mercy-Argenteau (see below).

MERCY (adapted from Fr. *merci*, Lat. *merces*, reward), compassion, pardon, pity or forgiveness. The Latin word was used in the early Christian ages for the reward that is given in heaven to those who have shown kindness without hope of return. The French word, except in such phrases as *Dieu merci*, *sans merci*, is principally used in the sense of "thanks," and is seen in the old English expression "gramercy," i.e. *grant merci*, great, many thanks, which Johnson took for "grant me mercy." In the medieval Church there were seven "corporal" and seven "spiritual works of mercy" (*opera misericordiae*); these were (a) the giving of food to the hungry and drink to the thirsty, the clothing of the naked, the visitation of the sick and of prisoners, the receiving of strangers, and the burial of the dead; (b) the conversion of sinners, teaching of the ignorant, giving of counsel to the doubtful, forgiveness of injuries, patience under wrong, prayer for the living and for the dead. The order of the Sisters of Mercy is a religious sisterhood of the Roman Church. It is found chiefly in England and Ireland, but there are branches in the United States of America, in South America and in Australia and New Zealand. It was founded in 1827 in Dublin by Miss Catherine McAuley (1787-1841). The object was to perform the corporal and spiritual works of mercy.

MERCY-ARGENTEAU, **FLORIMOND CLAUDE**, **COMTE DE** (1727-1794), Austrian diplomatist, son of Antoine, comte de Mercy-Argenteau, entered the diplomatic service of Austria, going to Paris in the train of Prince Kaunitz. He became

Austrian minister at Turin, at St Petersburg, and in 1766 at Paris, where his first work was to strengthen the alliance between France and Austria, which was cemented in 1770 by the marriage of the dauphin, afterwards Louis XVI., with Marie Antoinette, daughter of the empress Maria Theresa. When four years later Louis and Marie Antoinette ascended the throne, Mercy-Argenteau became one of the most powerful personages at the French court. He was in Paris during the turbulent years which heralded the Revolution, and his powerful aid was given first to Loménie de Brienne, and then to Necker. In 1792 he became governor-general of the Belgian provinces, which had just been reduced to obedience by Austria, and here his ability and experience made him a very successful ruler. Although at first in favour of moderate courses, Mercy-Argenteau supported the action of Austria in making war upon his former ally after the outbreak of the Revolution, and in July 1794 he was appointed Austrian ambassador to Great Britain, but he died a few days after his arrival in London.

See T. Juste, *Le Comte de Mercy-Argenteau* (Brussels 1863); A. von Arneth and A. Geoffroy, *Correspondances secrètes de Marie Thérèse avec le comte de Mercy* (Paris 1874); and A. von Arneth and J. Flammermont, *Correspondance secrète de Mercy avec Joseph II. et Kaunitz* (Paris 1889-1891). Mercy-Argenteau's *Correspondances secrètes de Marie Thérèse* has been condensed and translated into English by Lilian Smythe under the title of *A Guardian of Marie Antoinette* (2 vols., London 1902).

MERE. 1. (From Lat. *merus*, pure, unmixed; O. Fr. *mier*), an adjective primarily indicating something pure and unmixed; thus "mere wine" implied pure and unadulterated wine, as "mere lolly" expressed lolly pure and simple. Modern usage has, however, given both to the adjective "mere" and the adverb "merely" a deprecatory and disparaging idea, so that expressions like "the mere truth," a "mere statement of fact," &c., often convey the impression that they are far from being "mere" in the sense of "entire" or "absolute," but are, on the contrary, fragmentary and incomplete. The earlier idea of the word is retained in some legal phrases, especially in the phrase "mere motion," that is, of one's own initiative without help or suggestion from the outside. Another legal phrase is "mere right" (law Latin *jus merum*), *i.e.* right without possession.

2. A word which appears in various forms in several Teutonic and other languages; cf. Dutch and Ger. *Meer*. From the cognate Lat. *mare* are derived the Romanic forms, e.g. Fr. *mer*, Sp. *mar*, &c.; the word appears also in the derivative "marsh" for "marish"; the ultimate origin has been taken to be an Indo-European root, meaning "to die," *i.e.* to lie waste; cf. Sansk. *maru*, desert), an arm of the sea or estuary; also the name given to lakes, pools and shallow stretches of water inland. In the Fr. countries a mere signifies a marsh or a district nearly always under water.

3. (Derived from an O. Eng. source, *maere*, a wall or boundary; cognate with Lat. *murus*, a wall), a landmark or boundary, also an object indicating the extent of a property without actually enclosing it. A special meaning is that of a road, which forms a dividing line between two places. A "meresman" is an official appointed by parochial authorities to ascertain the exact boundaries of a parish and to report upon the condition of the roads, bridges, waterways, &c., within them. In the mining districts of Derbyshire a mere is a certain measurement of land in which lead-ore is found.

MEREDITH, GEORGE (1828-1909), British novelist and poet, was born at Portsmouth, Hampshire, on the 12th of February 1828; the parish church register records his baptism on the 9th of April. About his early life few details are recorded, but there is a good deal of quasi-autobiography, derived apparently from early associations and possibly antipathies, in some of his own novels, notably *Evan Harrington* and *Harry Richmond*, as to which the judicious may speculate. He had, as he used to boast, both Welsh (from his father) and Irish blood (from his mother) in his veins. His father, Augustus Armstrong Meredith, was a naval outfitter at Portsmouth (mentioned as such in *Marryat's Peter Simple*); and his grandfather, Melchisedek Meredith, clearly suggested the "Old Mel" of *Evan*

Harrington. Melchisedek was 35 when in 1796 he was initiated as a freemason at Portsmouth; and he appears to have been known locally as "the count," because of a romantic story as to an adventure he once had at Bath; he was churchwarden in 1801 and 1804; and some of the church plate still bears his name.

Meredith's mother died when he was three years old, and he was made a ward in chancery. He was sent to school at Newuied on the Rhine, and remained in Germany till he was sixteen. During these impressionable years he imbibed a good deal of the German spirit; and German influence, especially through the media of poetry and music, can often be traced in the cast of his thought and sentiment, as well as in some of the intricacies of his literary style. Returning to England he was at first articled to a solicitor in London, but he had little inclination for the law, and soon abandoned it for the more congenial sphere of letters, of which he had become an eager student. At the age of twenty-one he began to contribute poetry to the magazines, and he eked out a livelihood for some years by journalism, for the *Daily News* and other London papers, and for the *Ipswich Journal*, for which he wrote leaders; a certain number of his more characteristic fugitive writings are collected in the memorial edition of his works (1910). In London he became one of the leading spirits in the group of young philosophical and positivistic Radicals, among whom were John (afterwards Lord) Morley, Frederic Harrison, Cotter Morison and Admiral Maxse. But during the years when he was producing his finest novels he was practically unknown to the public. In 1849 he married Mrs Nicholls, daughter of Thomas Love Peacock, the novelist, a widow, eight years his senior, whose husband had been accidentally drowned a few months after her first marriage (1844), and who had one child, a daughter; but their married life was broken by separation; she died in 1861, and in 1864 Meredith married Miss Vulliamy, by whom he had a son and daughter. His second wife died in 1885. Up to that time there is little to record in the incidents of his life; he had not been "discovered" except by an "honourable minority" of readers and critics. It must suffice to note that during the Austro-Italian War of 1866 he acted as special correspondent for the *Morning Post*; and though he saw no actual fighting, he enjoyed, particularly at Venice, opportunities for a study of the Italian people which he turned to account in several of his novels. Towards the close of 1867, when his friend John Morley paid a visit to America, Meredith undertook in his absence the editorship of the *Fortnightly Review* for Messrs Chapman & Hall. They were not only the publishers of his books, but he acted for many years as their literary adviser, in which capacity he left a reputation for being not only eminently wise in his selection of the books to be published, but both critical and encouraging to authors of promise whose works he found himself obliged to reject. Thomas Hardy and George Gissing were among those who expressed their grateful sense of his assistance. He was indeed one of the last of the old school of "publishers' readers." In his early married life he lived near Weybridge, and later at Copsham between Esher and Leatherhead, while soon after his second marriage he settled at Flint Cottage, Mickleham, near Dorking, where he remained for the rest of his life.

Meredith's first appearance in print was in the character of a poet, and his first published poem "Chillian Wallah," may be found in *Chambers's Journal* for the 7th of July 1840. Two years later he put forth a small volume of *Poems* (1851), which was at least fortunate in eliciting the praise of two judges whose opinion was of the first importance to a beginner. Tennyson was at once struck by the individual flavour of the verse, and declared of one poem, "Love in the Valley," that he could not get the lines out of his head. Charles Kingsley's eulogy was at once more public and more particular. In *Fraser's Magazine* he subjected the volume to careful consideration, praising it for richness and quaintness of tone that reminded him of Herrick, for completeness and coherence in each separate poem, and for the animating sweetness and health of the general atmosphere. At the same time he censured the laxity of rhythm, the occasional lack of polish, and the tendency to

overload the description with objective details to the confusion of the principal effect. No doubt as a result of Kingsley's introduction, two poems by Meredith appeared in *Fraser's Magazine* shortly afterwards; but with the exception of these, and a sonnet in the *Leader*, he did not publish anything for the next five years. In the meanwhile he was busy upon his first essay in prose fiction. It was early in 1856 that the *Shaving of Shagpat*, a work of singular imagination, humour and romance, made its appearance. Modelled upon the stories of the *Arabian Nights*, it catches with wonderful ardour the magical atmosphere of Orientalism, and in this genre it remains a unique triumph in modern letters. Though unappreciated by the multitude, its genius was at once recognized by such contemporaries as George Eliot and Dante Gabriel Rossetti, the latter of whom was one of Meredith's intimate friends. For his next story it occurred to Meredith to turn his familiarity with the life and legendary tradition of the Rhineland into a sort of imitation of the grotesquerie of the German romanticists, and in 1857 he put forth *Farina, a Legend of Cologne*, which sought to transfer to English sympathies the spirit of German romance in the same way that *Shagpat* had handled Oriental fairy-love. The result was less successful. The plot of *Farina* lacks fibre, its motive is insufficient, and the diverse elements of humour, serious narrative, and romance scarcely stand in proportion to one another. But the *Ordeal of Richard Feverel*, which followed in 1859, transferred Meredith at once to a new sphere and to the altitude of his accomplishment. With this novel Meredith deserted the realm of fancy for that of the philosophical and psychological study of human nature, and *Richard Feverel* was the first, as it is perhaps the favourite, of those wonderful studies of motive and action which placed him among the demigods of English literature. The essential theme of this fine criticism of life is the question of a boy's education. It depicts the abortive attempt of a proud and opinionated father, hide-bound by theory and precept, to bring up his son to a perfect state of manhood through a "system" which controls all his early circumstances and represses many of the natural and wholesome instincts and impulses of adolescence. The love scenes in *Richard Feverel* are gloriously natural and full of vitality, and the book throughout marked a revolution in the English treatment of manly passion. Those who have not read this novel in the original form, with the chapters which were afterwards omitted, have lost, however, the key to many passages in the story: In the following year Meredith contributed to *Once a Week*, and in 1861 published as a book the second of his novels of modern life, *Evan Harrington*, originally with the sub-title "He Would be a Gentleman"—in allusion to the hero being the son of "Old Mel," the tailor—which contains a richly humorous—in its unrevised form, splendidly farcical—plot, with some magnificent studies of character. Afterwards revised, a certain amount of the farcical element was cut out, with the result that, considered as comedy, it has weak spots; but the Countess de Saldar remains a genuine creation. A year later he produced his finest volume of poems, entitled *Modern Love, and Poems of the English Roadside, with Poems and Ballads*. An attack upon the dramatic poem which gives the volume its title appeared in the *Spectator*, and is memorable for the fact that Meredith's friend, the poet Swinburne, with one of his characteristically generous impulses, replied (*Spectator*, June 7, 1862) in a spirit of fervent eulogy. Some of the individual "sonnets" (of sixteen lines) into which *Modern Love* is divided are certainly worthy of being ranked with the most subtle and most intense poetic work of the 19th century.

Returning to fiction, Meredith next published *Emilia in England* (1864), afterwards renamed *Sandra Belloni*. His powerful story *Rhoda Fleming* (1865) followed soon afterwards. *Vitoria*, published in the *Fortnightly Review* in 1866, and in book form in 1867, is a sequel to *Emilia in England*. Four years later appeared *The Adventures of Harry Richmond* in the pages of *Cornhill* (1870-1871). Its successor was *Beauchamp's Career* (*Fortnightly Review*, 1874-1875), the novel which Meredith usually described as his own favourite. Its hero's character is supposed

to have been founded upon that of Admiral Maxse. *Sandra Belloni*, *Rhoda Fleming*, *Vitoria* and *Beauchamp* are all masterpieces of his finest period, rich in incident, character and workmanship. "The House on the Beach" and "The Case of General Opie and Lady Camper" (*New Quarterly Magazine*, 1877) were slight but glittering exercises in comedy; the next important novel was *The Egoist* (1879), which shows an increase in Meredith's twistedness of literary style and is admittedly hard to read for those who merely want a "story," but which for concentrated analysis and the real drama of the human spirit is an astounding production. In an interesting series of lectures which Meredith delivered at the London Institution in 1877 his main thesis was that a man without a sense of comedy is dead to the finer issues of the spirit, and the conception of Sir Willoughby Patterne, the central figure of *The Egoist*, is an embodiment of this idea in the flesh. *The Tragic Comedians* (1880), the next of Meredith's novels, slighter in texture than his others, combines the spirits of comedy and tragedy in the story of the life of Ferdinand Lassalle, the German Socialist. The appearance of *Diana of the Crossways* (1885), a brilliant book, full of his ripest character-drawing, though here and there tormenting the casual reader by the novelist's mannerisms of expression, marks an epoch in Meredith's career, since it was the first of his stories to strike the general public. Its heroine was popularly identified with Sheridan's granddaughter, Mrs Norton, and the use made in it of the contemporary story of that lady's communication to *The Times* of the cabinet secret of Peel's conversion to Free Trade had the effect of producing explicit evidence of its inaccuracy from Lord Dufferin and others. As a matter of historical fact it was Lord Aberdeen who himself gave Delane the information, but the popular acceptance of the other version of the incident gave a factitious interest to the novel.

Meanwhile further instalments of poems—*Poems and Lyrics of the Joy of Earth* (1883)—had struck anew the full, rich note of natural realism which is Meredith's chief poetic characteristic. "The Woods of Westermain," in particular, has a sense of the mysterious communion of man with nature unapproached by any English poets save Wordsworth and Shelley. *Ballads and Poems of Tragic Life* (1887) and *A Reading of Earth* (1888) gave further evidence of the wealth of thought and vigour of expression which Meredith brought to the making of verse. To "the general," no doubt, Meredith's verse is prohibitive, or nearly so—for, after all, he has written some poems, like "Martin's Puzzle," "The Old Chartist," and "Juggling Jerry," which anybody can read with ease. But his most characteristic style in verse is so concentrated that any one accustomed to "straightforward" writing, and unwilling to read with the mind rather than with the eye, must needs, to his loss, be put off. His readers, of the verse even more than of the prose, must be prepared to meet him on a common intellectual footing. When once that is granted, however, the music and magic of such poems as "Seed-time," "Hard Weather," "The Thrush in February," "The South-Wester," "The Lark Ascending," "Love in the Valley," "Melampus," "A Faith on Trial," are very real, amid all their occasional obscurities of diction.

Meredith had now completed his sixtieth year, and with his advancing years the angles of his individuality began to grow sharper, while the difficulties of his style became accentuated. The increase in mannerism was marked in *One of Our Conquerors* (1891), otherwise a magnificent rendering of a theme full of both tragedy and comedy, and in the poem of "The Empty Purse" (1892). Neither *Lord Ormont and His Aminta* (1894) nor *The Amazing Marriage* (1895) reached the level of the earlier novels, though in the latter he seemed to catch an after-glow of genius. In 1898 appeared his *Odes in Contribution to the Song of French History*, consisting of one ode ("France, December 1870") reprinted from *Ballads and Poems* (1871), and three others previously unpublished; a fine example of his lofty thought, and magnificent—if often difficult—and individual diction. In 1901 another volume of verse, *A Reading*

of *Life*, appeared. In later years too he contributed occasional poems to newspapers and reviews and similar publications, which were collected after his death (*Last Poems*, 1910). His comedy, *The Sentimentalists*, was performed on the 1st of March 1910; his early but unfinished novel, *Celt and Saxon*, was also posthumously published in that summer.

From the early 'nineties onward Meredith's fame had been firmly established. His own literary contemporaries still living could join hands with the younger generation of enthusiastic admirers in insisting on a greatness of which they themselves had been unable to persuade the public. He was chosen to succeed Tennyson as president of the Authors' Society; on his seventieth birthday (1898) he was presented with a congratulatory address by thirty of the most prominent men of letters of the day; before he died he had been included by the king in the Order of Merit; and in various other ways his position as the chief living English writer had come to be popularly recognized. The critics discussed him; and new editions of his books (both prose and verse), for which there had long been but scanty demand, were called for. One of the results was that Meredith, with very doubtful wisdom, recast some of his earlier novels; and in the sumptuous "authorized edition" of 1897 (published by the firm of Constable, of which his son, William Maxse Meredith, was a member) very large alterations are made in some of them. In fact, a reader who compares the first and last editions either of *Richard Feverel* or *Evan Harrington* will notice changes little short of revolutionary. Even in the previously current editions of 1878 onwards, published by Chapman & Hall, *Richard Feverel* had been considerably shortened as compared with the original three-volume edition; but it was now robbed again of some of its best-known passages. It is no doubt competent to an author himself to revise his earlier published work even to the extent to which Meredith in the 1897 edition revised these novels; but certainly it is not necessary to accept his judgment when this involves the excision in old age of some of the most virile passages of books that were written in the full glow and vigour of his prime. In Constable's memorial edition (1910) of his complete works the excisions were published separately, and are therefore on record for those to consult who care. But the wise will read *Richard Feverel* and *Evan Harrington* in the original versions.

Meredith's literary quality must always be considered in the light of the Celtic side of his temperament and the peculiarities of his mental equipment. His nature was intuitive rather than ratiocinative; his mental processes were abrupt and far-reaching; and the suppression of connecting associations frequently gives his language, as it gave Browning's, but even to a greater extent, the air of an impenetrably nebulous obscurity. This criticism applies mainly to his verse, but is also true of his prose in many places, though there is much exaggeration about the difficulties of his novels. When once, however, his manner has been properly understood, it is seen to be inseparable from his method of intellection, and to add to the narrative of description both vividness of delineation and intensity of realization. The essential respect in which Meredith's method of describing action and emotion in narrative differs from that of convention is that, while the ordinary method is to relate what happens from the point of view of the onlooker, Meredith frequently describes it from the point of emotion of the actor; and his influence in this direction has largely modified the art of fiction. Herein lies the secret of the peculiar brilliancy of his style, derived from his combination of the narrator with the creator, or—in its strict sense—the seer. The reader, by the transference of the interest from the audience to the stage, is transported into the very soul of the character, and made to feel as he feels and act as he acts. Moreover, Meredith's instinct for psychology is so intimate, and his sense of motive and action so true, that the interaction of character and character directly dominates the sequence of events depicted in his imaginary world, and discloses the moral idea or criticism of life, instead of the preconceived "moral" being merely illustrated by the plot. In building up the minds, actions,

creeds, and tragedies or comedies of his imaginary personalities amid the selected circumstances, and inspiring them with the identical motives and educational influences of life itself, Meredith spent an elaboration and profundity of thought and an originality and vigour of analysis upon his novels which in explicitness go far beyond what had previously been attempted in fiction, and which give to his works a philosophical value of no ordinary kind. Simplicity can scarcely be expected of his language, for the interplay of ideas is in itself original and complex, and their interpretation is necessarily original and complex too. But when Meredith is at his best he is only involved with the involution of his subject; the aphorisms that decorate his style are simple when the idea they convey is simple, elaborate only in its elaboration. Pregnant, vividly graphic, capable of infinite shades and gradations, his style is a much finer and subtler instrument than at first appears, and must be judged finally by what it conveys to the mind, and not by its superficial sound upon the conventional ear. It owes something to Jean Paul Richter; something, too, to Carlyle, with whose methods of narrative and indebtedness to the apparatus of German metaphysics it has a good deal in common. To the novelist Richardson, too, a careful reader will find that Meredith, both in manner and matter (notably in *The Egoist* and in *Richard Feverel*), owes a good deal; in "Mrs Grandison" in *Richard Feverel* he even recalls "Sir Charles Grandison" by name; and nobody can doubt that Sir Willoughby Patterne, both in idea and often in expression, was modelled on Richardson's creation. Careful students of the early 19th-century English novel will find curious echoes again in Meredith of Bulwer-Lytton's (Baron Lytton's) literary manner and romantic outlook.¹ But he was, after all, an originator, and at first suffered in estimation on that score; he wrote in his own way, and what is most characteristic in Meredith remains individual. Like all the great masters, he has his own tone of voice, his own fashion of expressing an idea. Feeling, perception, reflection, judgment, have equal shares in determining his architectonic relation to a problem or a situation. He rings changes on the changing emotions of humanity, but every chime rings true. He is a literary artist. He takes great themes, not little ones; the characters in his fiction are personalities, human beings, neither "heroes" nor "sports"; and he does not descend to pander to lubricity or cater for the "reading public." His gallery of portraits of real human women, not dolls, would alone place him among the few creators in English literature.

It is beyond our scope here to enter into details concerning the philosophy which represents Meredith's "criticism of life." Broadly speaking, it is a belief in the rightness and wholeness of Nature, when Nature—"Sacred Reality"—is lovingly and faithfully and trustfully sought and known by the pure use of reason. Man must be "obedient to Nature, not her slave." Mystical as this philosophy occasionally becomes, it is yet an inspiring one, clean, austere and practical; and it is always dominated by the categorical imperative of self-knowledge and the striving after honesty of purpose and thought. A strong vein of political Radicalism runs through Meredith's creed. It is, however, a Radicalism allied to that of the French *philosophes*, rather than to the contemporary developments of British party politics, though in later life he gave his open support to the Liberal party. In spite of his German upbringing Meredith was always strongly French in his sympathies, and his appreciation of French character at its best and at its worst is finely shown in his Napoleon odes. In the main his politics may be summed up as a striving after liberty for reason and conscience and the constant progress of humanity—

The cry of the conscience of life;
Keep the young generations in hail,
And begueth them no tumbled house.

¹ The fact that Bulwer-Lytton's son, the 1st Earl of Lytton, Meredith's junior by three years, took the pen-name of "Owen Meredith," led occasionally to some confusion among uninitiated contemporaries, and even the suggestion of a family connexion.

It is part of Meredith's philosophy—and this must be remembered in considering his diction—that verbal expression is itself a test of right thought and action. Hence is derived his passion for verbal analysis. Hence also his impulse towards and vindication of poetry—meaning still “the best words in the best order”; and hence his own dictum, otherwise perhaps hard to undiscerning minds, that Song itself is the test by which truth may be tried. The passage occurs in “The Empty Purse”—a poem which throughout is a careful though mannered exposition of Meredith's general views on life—

Ask of thyself: This furious Yea
Of a speech I thump to repeat,
In the cause I would have prevail,
For seed of a nourishing wheat,
Is it accepted of Song?
Does it sound to the mind through the ear,
Right sober, pure sane? has it disciplined feet?
Thou wilt find it a test severe;
Unerring whatever the theme,
Rings it for Reason a melody clear,
We have bidden old Chaos retreat,
We have called on Creation to hear;
All forces that make us are one full stream.

Meredith is generally ranked far less high as a poet than as a novelist. But he can only be understood and appreciated properly by those who realize that not prose (in the ordinary sense) but poetry was to him the highest form of expression, and that only in it could he fully deliver his message, as a writer who aspired to contribute something more to the common stock of ideas than could be embodied dramatically in prose fiction.

On Meredith's 80th birthday in 1908, the homage of the English literary world was again paid in an address of congratulation. But his health, which for many years had been precarious, was now failing. He died at Flint Cottage, Box Hill, Surrey, on the 18th of May 1909. A strong feeling existed that he should be buried in Westminster Abbey, and a petition to that effect, which was approved by the prime minister, Mr Asquith, was signed by a large number of men of letters. But this was not to be. A memorial service was held in the abbey, but Meredith's own remains, after cremation, were interred at Dorking by the grave of his second wife. He had died only a brief span after his old friend Swinburne, his affection for whom had never suffered abatement, and it was felt that, with them, a great epoch in English literary history had closed. They were the last of the great Victorians; and in Meredith went the writer who had raised the creative art of the novel, as a vehicle of character and constructive philosophy, to its highest point—a point higher indeed than most contemporary readers were prepared for. The estimate of his genius formed by “an honourable minority,” who would place him in the highest class of all, by Shakespeare, has yet to be confirmed by the wider suffrage of posterity.

A carefully compiled bibliography by John Lane was included in *George Meredith: Some Characteristics*, by R. Le Gallienne (1890). This sympathetic essay in criticism was the first substantial publication addressed to that stimulation of a wider appreciation of Meredith which was carried on by several later books, perhaps the best of which is M. Sturge Henderson's *George Meredith: Novelist, Poet, Reformer* (1908); but such earlier testimonies to Meredith's importance as Justin McCarthy's, in his *History of Our Own Times*, must not be forgotten. See also J. A. Hammerton, *George Meredith in Anecdotes and Criticism* (1909).

MEREJKOVSKY (or MEREZHKOVSKY), **DMITRI** **HERGEEVICH** (1865—), Russian novelist and critic, was born at St Petersburg in 1865. His trilogy of historical romances, collectively entitled *Christ and Antichrist*, has been translated into many European languages, notably English and French. It comprises *Smert Bogov* (Eng. trans. “The Death of the Gods,” London, 1901), the central figure in which is Julian the Apostate; *Voskresenie Bogi* (“The Forerunner,” London, 1902), which describes the life and times of Leonardo da Vinci; and *Antikhrisť: Petr i Aleksyey* (“Peter and Alexis,” London, 1905), which is based on the tragic story of the relations between Peter the Great and his son. The influence of Steniewicz can be traced in many of Merejkovsky's writings, which include

critical studies of Pliny the Younger, Calderon, Montaigne, Ibsen, Tolstoy (*Tolstoy as Man and Artist*, London, 1902), and of Gorki and other Russian writers. Merejkovsky married Zinaida Nikolaevna, known in Russia for her poems, essays and short stories written under the pseudonym of Zinaida Hippus (or Gippius); her collected poems (1889–1903) were published in Moscow in 1904.

MERES, **FRANCIS** (1565–1647), English divine and author, was born at Kirtan in the Holland division of Lincolnshire in 1565. He was educated at Pembroke College, Cambridge, where he graduated B.A. in 1587, and M.A. in 1591. Two years later he was incorporated M.A. of Oxford. His kinsman, John Meres, was high sheriff of Lincolnshire in 1596, and apparently helped him in the early part of his career. In 1602 he became rector of Wing in Rutland, where he had a school. He died on the 29th of January 1647. Meres rendered immense service to the history of Elizabethan literature by the publication of his *Palladis Tamia, Wits Treasury* (1598). It was one of a series of volumes of short pithy sayings, the first of which was *Politeuphuia: Wits Commonwealth* (1597), compiled by John Bodenham or by Nicholas Ling, the publisher. The *Palladis Tamia* contained moral and critical reflections borrowed from various sources, and embraced sections on books, on philosophy, on music and painting, and a famous “Comparative Discourse of our English poets with the Greeke, Latin, and Italian poets.” This chapter enumerates the English poets from Chaucer to Meres's own day, and in each case a comparison with some classical author is instituted. The book was issued in 1634 as a school book, and has been partially reprinted in the *Ancient Critical Essays* (1811–1815) of Joseph Haslewood, *Professor E. Arber's English Garner*, and Gregory Smith's *Elizabethan Critical Essays* (1904). A sermon entitled *Gods Arithmetick* (1597), and two translations from the Spanish of Luis de Granada entitled *Granados Devotion* and the *Sinners Guide* (1598) complete the list of his works.

MERGANSER, a word due to C. Gesner (*Hist. animalium* iii. 129) in 1555, and for long used in English as the general name for a group of fish-eating ducks possessing great diving powers, and forming the genus *Mergus* of Linnaeus, now regarded by ornithologists as a sub-family, *Merginae*, of the family *Anatidae*. The mergansers have a long, narrow bill, with a small but evident hook at the tip, and the edges of both mandibles beset by numerous horny denticulations, whence in English the name of “saw-bill” is frequently applied to them. Otherwise their structure does not much depart from the Anatine or Fuliginine type. All the species bear a more or less developed crest or tuft on the head. Three of them, *Mergus merganser* or *castor*, *M. serrator*, and *M. abellus*, are found over the northern parts of the Old World, and of these the first two also inhabit North America, which has besides a fourth species, *M. cucullatus*, said to have occasionally visited Britain. *M. merganser*, commonly known as the goosander, is the largest species, being nearly as big as the smaller geese, and the adult male in breeding-attire is a very beautiful bird, conspicuous with his dark glossy-green head, rich salmon-coloured breast, and the upper part of the body and wings black and white. This full plumage is not assumed till the second year, and in the meantime, as well as in the post-nuptial dress, the male much resembles the female, having, like her, a reddish-brown head, the upper parts grey and the lower white. In this condition the bird is often known as the “dun diver.” This species breeds abundantly in many parts of Scandinavia, Russia, Siberia and North America, and occasionally in Scotland. *M. serrator*, commonly called the red-breasted merganser, is a somewhat smaller bird; and, while the fully-dressed male wants the delicate hue of the lower parts, he has a gorget of rufous mottled with black, below which is a patch of white feathers, broadly edged with black. Both these species have the bill and feet of a bright reddish-orange, while the much smaller *M. abellus*, known as the smew, has these parts of a lead colour, and the breeding plumage of the adult male is white, with quaint crescentic markings of black, and the flanks most beautifully vermiculated.

M. cucullatus, the hooded merganser of North America, is in size intermediate between *M. abellus* and *M. serrator*; the male is easily recognizable by his broad semicircular crest, bearing a fan-shaped patch of white, and his elongated subscapulars of white edged with black. The conformation of the trachea in the male of *M. merganser*, *M. serrator* and *M. cucullatus* is very like that of the ducks of the genus *Clangula*, but *M. abellus* has a less exaggerated development more resembling that of the ordinary *Fuligula*.¹ From the southern hemisphere two species of *Mergus* have been described, *M. octostetaceus* or *brasilianus*, L. P. Vieillot (*N. Dict. d'Hist. naturelle*, ed. 2, vol. xiv. p. 222; *Gal. des oiseaux*, tom. ii. p. 209, pl. 283), inhabiting South America, of which but few specimens have been obtained, having some general resemblance to *M. serrator*, but much more darkly coloured, and *M. australis*, Homborn and Jacquemont (*Ann. sc. nat. zoologie*, ser. 2, vol. xvi. p. 320; *Voy. au Pol Sud*, *oiseaux*, pl. 31, fig. 2), known only by the unique example in the Paris Museum procured by the French Antarctic expedition in the Auckland Islands.

Often associated with the mergansers is the genus *Merganetta*, the so-called torrent-ducks of South America, of which six species have been described; but they possess spiny tails and have their wings armed with a spur. These with *Hymenolaimus Malacorhynchus*, the blue duck of New Zealand, and *Salvadorina waigiensis* of Waigiou are placed in the sub-family *Merganetinae*. (A. N.)

MERGENTHEIM, a town of Germany, in the kingdom of Württemberg, situated in the valley of the Tauber, 7 m. S. from Lauda by rail. Pop. (1905), 4535. It contains an Evangelical and three Roman Catholic churches, a Latin and other schools, and a magnificent castle with a natural history collection and the archives of the Teutonic order. This is now used as barracks. The industries of the town include tanning, the manufacture of agricultural machinery and wine-making. Near the town is a medicinal spring called the Karlsbad.

Mergentheim (*Mariae domus*) is mentioned in chronicles as early as 1058, as the residence of the family of the counts of Hohenlohe, who early in the 13th century assigned the greater part of their estates in and around Mergentheim to the Teutonic order. It rapidly increased in fame, and became the most important of the eleven commanderies of that society. On the secularization of the Teutonic Order in Prussia in 1525, Mergentheim became the residence of the grand master, and remained so until the final dissolution of the order in 1809.

See Höring, *Das Karlsbad bei Mergentheim* (Mergentheim, 1887); and Schmitt, *Garnisonsgeschichte der Stadt Mergentheim* (Stuttgart, 1895).

MERGER (Fr. merger, to sink), in law, the sinking or "drowning" of a lesser estate in a greater, when the two come together in one and the same person without any intervening estate. In order to effect a merger the two estates must vest in the same person at the same time, must be immediately expectant one on the other, and the expectant estate must be larger than the preceding estate. The term is also used for the extinguishment of any right, contract, &c., by absorption in another, e.g. the acceptance of a higher security for a lower, or the embodying of a simple contract in a deed.

MERGUI, the southernmost district of Lower Burma, in the Tenasserim division, bounded on the W. by the Bay of Bengal and on the E. by Siam. Area 9789 sq. m. Two principal ranges cross the district from north to south, running almost

Hybrids between, as is presumed, *M. abellus* and *Clangula glaucion*, the common golden-eye, have been described and figured (Eimbeck, *Ist.*, 1831, 300, tab. iii.; Brehm, *Naturgesch. aller Vög. Deutschlands*, p. 930; Naumann, *Vög. Deutschlands*, xii. 104, frontispiece; Kjærølling, *Jour. für Ornithologie*, 1853, Extrahft. p. 29, Naumaine, 1853, p. 327, *Ornithol. danica*, tab. iv., suppl. tab. 29) under the names of *Mergus anataris*, *Clangula angustirostris*, and *Anas (Clangula) mergoides*, as though they were a distinct species; but the remarks of De Selys-Longchamps (*Bull. Ac. Sc.-Bruxelles*, 1845, pt. ii. p. 354, and 1856, pt. ii. p. 21) leave little room for doubt as to their origin, which, when the cryptogamic habit and common range of their putative parents, the former unknown to the author last-named, is considered, will seem to be still more likely.

parallel to each other for a considerable distance, with the Tenasserim river winding between them till it turns south and flows through a narrow rocky gorge in the westernmost range to the sea. The whole district, from the water's edge to the loftiest mountain on the eastern boundary, may be regarded as almost unbroken forest. The timber trees found towards the interior, and on the higher elevations, are of great size and beauty, the most valuable being teak (*Tectona grandis*), *then-gan* (*Hopea odorata*), *ka-gnyeng* (*Dipterocarpus laevis*), &c. The coast-line of the district, off which lies an archipelago of two hundred and seven islands, is much broken, and for several miles inland is very little raised above sea-level, and is drained by numerous muddy tidal creeks. Southwards of Mergui town it consists chiefly of low mangrove swamps alternating with small fertile rice plains. After passing the mangrove limits, the ground to the east gradually rises till it becomes mountainous, even to the banks of the rivers, and finally culminates in the grand natural barrier dividing Burma from Siam. The four principal rivers are the Tenasserim, Le-nya, Pakchan and Palauk, the first three being navigable for a considerable distance. Coal is found on the banks of the Tenasserim and its tributaries, but is still unworked. Gold, copper, iron and manganese are also found in various parts of the district, and there are tin mines at Maliwun, upon which European methods have been tried without much profit, owing to the cost of labour.

From the notices of early travellers it appears that Mergui, when under Siamese rule, before it passed to the Burmese, was a rich and densely peopled country. On its occupation by the British in 1824-1825 it was found to be almost depopulated—the result of border warfare and of the cruelties exercised by the Burmese conquerors. At that time the entire inhabitants numbered only 10,000. It had a population of 88,744 in 1901, showing an increase of 20% in the decade and giving a density of 9 inhabitants to the sq. m. Mergui carries on a flourishing trade with Rangoon, Bassein and the Straits Settlements. The chief exports consist of rice, rattans, torches, dried fish, arca-nuts, sesame seeds, molasses, sea-slugs, edible birds' nests and tin. The staple imports are piece goods, tobacco, cotton, earthenware, tea and sugar. The climate is remarkably healthy, the heat due to its tropical situation being moderated by land and sea breezes. The rainfall is very heavy and usually exceeds 150 inches.

Mergui town has risen into prominence in recent years as the centre of the pearling trade in the neighbouring archipelago. The pearling grounds were practically unknown in 1890, but in the following decade they produced pearls and mother-of-pearl shell of considerable value. In 1901 the population was 11,987; but the census is taken at a time when many of the fishermen and their families are away in the islands. There is a considerable coasting trade with other Burmese ports and with the Straits Settlements.

MERGUI ARCHIPELAGO, a cluster of islands in the Bay of Bengal, near the southern coast of Lower Burma. They are chiefly noted for their picturesque beauty, some of them rising to 3000 ft. They are only sparsely inhabited by the island race of Selungs.

MERIAN, MATTHEW (1593-1650), Swiss engraver, was born in Basel, on the 25th of September 1593. The family came originally from near Delémont, but in his grandfather's time settled in Basel, where in 1553 it obtained the burghership of the city. As Matthew early showed signs of artistic tastes, he was placed (1609) under the care of Dietrich Meyer, a painter and engraver of Zürich (1572-1658). He went on to Nancy in 1613, where he already displayed considerable talents as an engraver on copper. After studying in Paris, Stuttgart (1616) and the Low Countries, he came to Frankfurt, where in 1618 he married the eldest daughter of J. T. de Bry, who was a publisher and bookseller as well as an engraver. Merian worked for some time with his father-in-law in Oppenheim, but then returned to Basel, whence he came back (1624) to Frankfurt after Bry's death (1623), in order to take over his business;

this remained in his family till 1726, when, after a great fire that destroyed most of the books in stock, it came to an end. In 1625 Merian became a burgher of Frankfurt, then the great centre of the book trade in Germany, and lived there till his death on the 22nd of June 1650. Among his many works two deserve to be specially mentioned. The first is the long series of works, each entitled *Topographia*, which contained descriptions of various countries, illustrated by copper plates, largely done by Merian himself, while the accompanying text was due to Martin Zeiller (1589-1661), an Austrian by birth. The first volume was published in 1642 and described Switzerland, with the Grisons and the Valais; it contains the first known view of the glaciers of Grindelwald. "Austria" appeared in 1649, but the volume relating to Upper Saxony and Bohemia (1650) was the last issued by Merian himself. "France" appeared in 1655-1656, while in 1688 the series (extending to 30 parts, in 18 vols.) came to an end with "Italy," the volume as to Rome having appeared in 1681. The other great enterprise of Merian was the series entitled *Theatrum Europaeum*, which appeared in 21 parts between 1635 and 1738—it is a historical chronicle of events in Europe from 1617 onwards. In 1625-1630 Merian published a series of illustrations to the Bible, and in 1649 a *Dance of Death*. But he is best remembered by his views of towns, which have very considerable historical value. His best pupil, Wenceslaus Hollar (1607-1677), of Prague, settled in London (1635-1643, 1652-1677), and worthily carried on the Merian tradition. (W. A. B. C.)

See Life, by H. Eckardt (Basel, 1887).

MÉRIDA, a city of Mexico and capital of the state of Yucatan, 23 m. by rail S. of Progreso, its port on the Gulf of Mexico. Pop. (1900), 43,630, the Maya element being predominant. Mérida is the centre of an isolated railway system, connected with the ports of Progreso and Campeche, and having short lines radiating in all directions to Peten, Valladolid and Izamal. It stands on a broad, partly open plain near the northern border of the peninsula, where the thin loose soil covering a limestone foundation permits the rapid percolation and evaporation of the rainfall, and therefore supports a comparatively scanty vegetation. It is highly favourable to maguery cultivation, however, and Mérida is the centre of the henequén, or sisal fibre, industry. There is an imposing 16th-century cathedral facing upon the principal plaza, together with the government and episcopal palaces. There are also an old university, with schools of law, medicine and pharmacy, an episcopal seminary and other educational institutions. The most interesting building in the city is a Franciscan convent, dating from 1547, which covers an area of 6 acres and is surrounded by a wall 40 ft. high and 8 ft. thick. It once harboured no less than 2000 friars, but has been allowed to fall into complete decay since the expulsion of the order in 1820. The manufactures include straw hats, hammocks, cigars, soap, cotton fabrics, leather goods, artificial stone, and a peculiar distilled beverage called *astabentan*. The exports are henequén, or sisal fibre, hides, sugar, rum, chicle and indigo—all products of the vicinity. Mérida was founded in 1542 by the younger Francisco de Montejo on the site of a native city called Tihoo, or Thó, whose stone pyramids furnished building material in abundance for the invaders. It became an episcopal see in 1561.

MÉRIDA (anc. *Augusta Emerita*, capital of Lusitania), a town of western Spain, in the province of Badajoz, on the right bank of the river Guadiana, 30 m. E. of Badajoz. Pop. (1900), 11,168. Mérida is an important railway junction, for here the Madrid-Badajoz railway meets the lines from Seville, Huelva and Cáceres. No Spanish town is richer in Roman antiquities. Most of these are beyond the limits of modern Mérida, which is greatly inferior in area to the ancient city. Chief among them is the Roman bridge, constructed of granite under Trajan, or, according to some authorities, under Augustus, and restored by the Visigoths in 686 and by Philip III. in 1610. It comprised 81 arches, 17 of which were destroyed during the siege of Badajoz (1812), and measured 2575 ft. in length. There are a few remnants of Roman

temples and of the colossal wall which encircled the city, besides a Roman triumphal arch, commonly called the Arco de Santiago, and a second Roman bridge, by which the road to Salamanca was carried across the small river Albarregas (*Alba Regia*). The Moorish *alcazar* or citadel was originally the chief Roman fort. From the Lago de Proserpina, or Charca de la Albuera, a large Roman reservoir, 3 m. north, water was conveyed to Mérida by an aqueduct, of which 37 enormous piers remain standing, with ten arches in three tiers built of brick and granite. The massive Roman theatre is in good preservation; there are also a few vestiges of an amphitheatre and of a circus which measured 485 yds. by 120. Other Roman remains are exhibited in the archaeological museum, and much Roman masonry is incorporated in the 16th century Mudéjar palace of the dukes of La Roca, the palace of the counts of Los Corbos, and the convent of Santa Eulalia, which is said by tradition to mark the spot where St Eulalia was martyred (c. 300).

Augusta Emerita was founded in 25 B.C. As the capital of Lusitania it soon became one of the most splendid cities in Iberia, and was large enough to contain a garrison of 90,000 men. Under the Visigoths it continued to prosper, and was made an archbishopric. Its fortifications included five castles and eighty-four gateways; but after a stubborn resistance it was stormed by the Moors in 713. Its Moorish governors frequently, and sometimes successfully, asserted their independence, but Mérida was never the capital of any large Moorish state. In 1129 its archbishopric was formally transferred to Santiago de Compostela, and in 1228, when Alphonso IX. of Leon expelled the Moors, Mérida was entrusted to the order of Santiago, in whose keeping it soon sank into decadence.

MERIDEN, a city of New Haven county, Connecticut, U.S.A., in the township of Meriden, S.W. of the centre of the state, about 18 m. N.N.E. of New Haven and about the same distance S.S.W. of Hartford. Pop. of the township, including the city (1900), 38,695; (1910), 32,066; of the city (1900), 24,296, of whom 7215 were foreign-born; (1910), 27,265. Meriden is served by the New York, New Haven & Hartford railway and by an inter-urban electric line. The city is bisected by Harbor Brook, a small stream, and through the S.W. part of the township flows the Quinnipiac river. A short distance N.W. of the city, in Hubbard Park, an attractive reservation of more than 900 acres, are the Hanging Hills, three elevations (West Mountain, South Mountain and Cat-Hole Mountain) in a broken range of trap ridges, which have resisted the erosion that formed the lowlands of the Connecticut valley; they rise to a height of about 700 ft. above the sea. In their vicinity, near the boundary of Berlin township, is Merimere, one of the city's four reservoirs. Meriden is the seat of the Connecticut School for Boys (Reformatory). There are also a public library (1899), a state armoury, a hospital, the Curtis Home for orphans and aged women, and a tuberculosis sanitarium supported by the city. Meriden is one of the most important manufacturing cities of Connecticut, and in 1905 produced 59.9% of the plated ware manufactured in the state, and much sterling silver. In 1905 the factory product was valued at \$13,763,548, an increase of 17.1% over that of 1900. Meriden was originally a part of the township of Wallingford, but a tract in the northern part of this township was designated as Meriden by an Indian deed of 1664. It was made a separate parish under that name in 1728, but did not become a separate township until 1806. The city was chartered in 1867.

See G. W. Perkins, *Historical Sketches of Meriden* (West Meriden, 1849); C. H. S. Davis, *History of Wallingford* (Meriden, 1879); and G. M. Curtis and C. Bancroft Gillespie, *A Century of Meriden* (Meriden, 1906).

MERIDIAN, a city and the county-seat of Lauderdale county, Mississippi, U.S.A., about 90 m. E. of Jackson. Pop. (1890), 10,624; (1900), 14,050, of whom 5787 were negroes; (1910 census), 23,285. It is served by the Southern, the Alabama Great Southern, the Mobile & Ohio, and the New Orleans & North Eastern and the Alabama & Vicksburg (Queen &

Crescent Route) railways. It is the seat of the East Mississippi Insane Hospital, of the state Masonic Widows and Orphans' Home and of the Meridian Women's College (non-sectarian, opened in 1903), the Meridian Male College (opened in 1901), and, for negroes, the Lincoln School (Congregational) and Meridian Academy (Methodist Episcopal). The city is an important market for cotton grown in the surrounding country, and is the principal manufacturing city in the state. Its factory products, chiefly railway supplies and cotton products, increased in value from \$1,924,465 in 1900 to \$3,267,600 in 1905, or 69.8% in five years. Mineral waters (especially lithia) are bottled in and near the city. Meridian was laid out in 1854 at a proposed railway crossing, and was chartered as a city in 1860. In February 1864 General William Tecumseh Sherman, with an army of about 20,000, made an expedition from Vicksburg to Meridian, then an important railway centre and dépôt for Confederate supplies, chiefly for the purpose of making inoperative the Mobile & Ohio and the Jackson & Selma railways; on the 14th of the month his army entered Meridian, and within a week destroyed nearly everything in the city except the private houses, and tore up over 110 m. of track. In the "Meridian riot" of 1871—a prominent episode of reconstruction—when one of several negroes on trial for urging mob violence had shot the presiding judge, the whites, especially a party from Alabama interested in the trial, killed a number of negroes and burned a negro school. On the 2nd of March 1906 a cyclone caused great loss of life and property.

MERIDIAN (from the Lat. *meridianus*, pertaining to the south or mid-day), in general a direction toward the south or toward the position of the sun at mid-day. The terrestrial meridian of a place is the great circle drawn on the earth's surface from either pole through the place. As determined astronomically the celestial meridian is the great circle passing through the celestial pole and the zenith. The terrestrial meridian as practically determined is the circle on the earth's surface in which the plane of the celestial meridian cuts that surface. Owing to local deviations of the plumb-line the meridian thus determined does not strictly coincide with the terrestrial meridian as ordinarily defined, but the deviation, though perceptible in mountainous regions, is so minute that it is generally ignored.

MÉRIMÉE, PROSPER (1803-1870), French novelist, archaeologist, essayist, and in all these capacities one of the greatest masters of French style during the 19th century, was born at Paris on the 28th of September 1803. His grandfather, of Norman extraction, had been a lawyer and steward to the maréchal de Broglie. His father, Jean François Léonor Mérimée (1757-1836), was a painter of repute. Mérimée had English blood in his veins on the mother's side, and had English proclivities in many ways. He was educated for the bar, but entered the public service instead. A young man at the time of the Romantic movement, he felt its influence strongly, though his peculiar temperament prevented him from joining any of the coteries of the period. Nothing was more prominent among the romantics than the fancy, as Mérimée himself puts it, for "local colour," the more unfamiliar the better. He exhibited this in an unusual way. In 1825 he published what purported to be the dramatic works of a Spanish lady, Clara Gazul, with a preface stating circumstantially how the supposed translator, one Joseph L'Estrange, had met the gifted poetess at Gibraltar. This was followed by a still more audacious and still more successful *supercherie*. In 1827 appeared a small book entitled *La Guzla* (the anagram of Gazul), and giving itself out as translated from the Illyrian of a certain Hyacinthe Maglanovich. This book, which has greater formal merit than *Clara Gazul*, is said to have taken in Sir John Bowring, a competent Slav scholar, the Russian poet Poushkin, and some German authorities, although not only had it no original, but, as Mérimée declares, a few words of Illyrian and a book or two of travels and topography were the author's only materials. In the next year appeared a short dramatic romance, *La Jacquerie*, in which are visible Mérimée's extraordinary

faculty of local and historical colour, his command of language, his grim irony, and a certain predilection for tragic and terrible subjects, which was one of his numerous points of contact with the men of the Renaissance. This in its turn was followed by a still better piece, the *Chronique de Charles IX.* (1829), which stands towards the 16th century much as the *Jacquerie* does towards the middle ages. All these works were to a certain extent second-hand. But they exhibited all the future literary qualities of the author save the two chiefest, his wonderfully severe and almost classical style, and his equally classical solidity and staturesque quality of construction.

He had already obtained a considerable position in the civil service, and after the revolution of July he was *chef de cabinet* to two different ministers. He was then appointed to the more congenial post of inspector-general of historical monuments. Mérimée was a born archaeologist, combining linguistic faculty of a very unusual kind with accurate scholarship, with remarkable historical appreciation, and with a sincere love for the arts of design and construction, in the former of which he had some practical skill. In his official capacity he published numerous reports, some of which, with other similar pieces, have been republished in his works. He also devoted himself to history proper during the latter years of the July monarchy, and published numerous essays and works of no great length, chiefly on Spanish, Russian and ancient Roman history. He did not, however, neglect novel writing during this period, and numerous short tales, almost without exception masterpieces, appeared, chiefly in the *Revue de Paris*. The best of all, *Colomba*, a Corsican story of extraordinary power, appeared in 1840. He travelled a good deal; and in one of his journeys to Spain, about the middle of Louis Philippe's reign, he made an acquaintance destined to influence his future life not a little—that of Mme de Montijo, mother of the future empress Eugénie. Mérimée, though in manner and language the most cynical of men, was a devoted friend, and shortly before the accession of Napoleon III. he had occasion to show this. His friend, Libri Carucci dalla Sommaja, was accused of having stolen valuable manuscripts and books from French libraries, and Mérimée took his part so warmly that he was actually sentenced to and underwent fine and imprisonment. He had been elected to the Academy in 1844, and also of the Academy of Inscriptions, of which he was a prominent member. Between 1840 and 1850 he wrote more tales, the chief of which were *Arsène Guillot* and *Carmen* (1847), this last, on a Spanish subject, hardly ranking below *Colomba*.

The empire made a considerable difference in Mérimée's life. His sympathies were against democracy, and his habitual cynicism and his irreligious prejudices made legitimism distasteful to him. But the marriage of Napoleon III. with the daughter of Mme de Montijo at once enlisted what was always strongest with Mérimée—the sympathy of personal friendship—on the emperor's side. He was made a senator, but his most important rôle was that of a constant and valued private friend of both the "master and mistress of the house," as he calls the emperor and empress in his letters. He was occasionally charged with a kind of irregular diplomacy, and once, in the matter of the emperor's *Caesar*, he had to give literary assistance to Napoleon. But for the most part he was strictly the *ami de la maison*. At the Tuileries, at Compiègne, at Biarritz, he was a constant though not always a very willing guest, and his influence over the empress, was very considerable and was fearlessly exerted, though he used to call himself, in imitation of Scarron, "le bouffon de sa majesté." He found, however, time for not a few more tales, of which more will be said presently, and for correspondences, which are not the least of his literary achievements, while they have an extraordinary interest of matter. One of these consists of the letters which have been published as *Lettres à une inconnue*, another of the letters addressed to Sir Anthony Panizzi, librarian of the British Museum. After various conjectures it seems that the *inconnue* just mentioned was a certain Mlle Jenny Daquin of Boulogne. The acquaintance extended over many

years; it partook at one time of the character of love, at another of that of simple friendship, and Mérimée is exhibited in the letters under the most surprisingly diverse lights, most of them more or less amiable, and all interesting. The correspondence with Panizzi has somewhat less personal interest. But Mérimée often visited England, where he had many friends (among whom the late Mr Ellice of Glangary was the chief), and certain similarities of taste drew him closer to Panizzi personally, while during part of the empire the two served as the channel for a kind of unofficial diplomacy between the emperor and certain English statesmen. These letters are full of shrewd *aperçus* on the state of Europe at different times. Both series, and others since published, abound in gossip, in amusing anecdotes, in sharp literary criticism, while both contain evidences of a cynical and Rabelaisian or Swiftian humour which was very strong in Mérimée. This characteristic is said to be so prominent in a correspondence with another friend, which now lies in the library at Avignon, that there is but little chance of its ever being printed. A fourth collection of letters, of much inferior extent and interest, has been printed by Blaze de Bury under the title of *Lettres à une autre inconnue* (1873), and others still by d'Haussonville (1888), and in the *Revue des Deux Mondes* (1896). In the latter years of his life Mérimée suffered very much from ill-health. It was necessary for him to pass all his winters at Cannes, where his constant companions were two aged English ladies, friends of his mother. The Terrible Year found him completely broken in health and anticipating the worst for France. He lived long enough to see his fears realized, and to express his grief in some last letters, and he died at Cannes on the 23rd of September 1870.

Mérimée's character was a peculiar and in some respects an unfortunate one, but by no means unintelligible. Partly by temperament, partly it is said owing to some childish experience, when he discovered that he had been duped and determined never to be so again, not least owing to the example of Henri Beyle (Stendhal), who was a friend of his family, and of whom he saw much, Mérimée appears at a comparatively early age to have imposed upon himself as a duty the maintenance of an attitude of sceptical indifference and sarcastic criticism. Although a man of singularly warm and affectionate feelings, he obtained the credit of being a cold-hearted cynic; and, though both independent and disinterested, he was abused as a hanger-on of the imperial court. Both imputations were wholly undeserved, and indeed were prompted to a great extent by political spite or by the resentment felt by his literary equals on the other side at the cool ridicule with which he met them. But he deserved in some of the bad as well as many of the good senses of the term the name of a man of the Renaissance. He had the warm partisanship and amiability towards friends and the scorpion-like sting for his foes, he had the ardent delight in learning and especially in matters of art and belles lettres, he had the scepticism, the voluptuousness, the curious delight in the contemplation of the horrible, which marked the men of letters of the humanist period. Even his literary work has this Renaissance character. It is tolerably extensive, amounting to some seventeen or eighteen volumes, but its bulk is not great for a life which was not short, and which was occupied, at least nominally, in little else. About a third of it consists of the letters already mentioned. Rather more than another third consists of the official work which has been already alluded to—reports, essays, short historical sketches, the chief of which latter is a history of Pedro the Cruel (1843), and another of the curious pretender known in Russian story as the false Demetrius (1852). Some of the literary essays, such as those on Beyle, on Turgeniev, &c., where a personal element enters, are excellent. Against others and against the larger historical sketches—admirable as they are—Taine's criticism that they want life has some force. They are, however, all marked by Mérimée's admirable style, by his sound and accurate scholarship, his strong intellectual grasp of whatever he handled, his cool unprejudiced views, his marvellous faculty of designing and proportioning the treatment of his work. In purely archæo-

logical matters his *Description des peintures de Saint-Savin* is very noteworthy. It is, however, in the remaining third of his work, consisting entirely of tales either in narrative or in dramatic form, and especially in the former, that his full power is perceived. He translated a certain number of things (chiefly from the Russian); but his fame does not rest on these, on his already-mentioned youthful supercherries, or on his later semi-dramatic works. There remain about a score of tales, extending in point of composition over exactly forty years, and in length from that of *Colomba*, the longest, which fills about one hundred and fifty pages, to that of *l'Enlèvement de la redoute* (1829), which fills just half a dozen. They are unquestionably the best things of their kind written during the century, the only *nouvelles* that can challenge comparison with them being the very best of Gautier, and one or two of Balzac. The motives are sufficiently different. In *Colomba* and *Mateo Falcone* (1829), the Corsican point of honour is drawn on; in *Carmen* (written apparently after reading Borrow's Spanish books), the gipsy character; in *la Venus d'Ille* (1837) and *Lokis* (two of the finest of all), certain grisly superstitions, in the former case that known in a milder form as the ring given to Venus, in the latter a variety of the were-wolf fancy. *Arsène Guillot* is a singular satire, full of sarcastic pathos, on popular morality and religion; *la Chambre bleue*, an 18th-century *conte*, worthy of C. P. J. Crèbillon for grace and wit, and superior to him in delicacy; *The Capture of the Redoubt* just mentioned is a perfect piece of description; *l'Abbé au bain* is again satirical; *la Double méprise* (the authorship of which was objected to Mérimée when he was elected of the Academy) is an exercise in analysis strongly impregnated with the spirit of Stendhal, but better written than anything of that writer's. These stories, with his letters, assure Mérimée's place in literature at the very head of the French prose writers of the century. He had undertaken an edition of Brantôme for the Bibliothèque Elzévirienne, but it was never completed.

Mérimée's works have only been gradually published since his death. There is no uniform edition, but almost everything is obtainable in the collections of MM. Charpentier and Calmann Lévy. Most of the sets of letters above referred to from those to the first *inconnue*, where the introducer was Taine, have essays-prefaces on Mérimée. Maurice Tourneux's *Prosper Mérimée, sa bibliographie* (1876) and *Prosper Mérimée, ses portraits* (1879), are useful, while *Émile Faguet* and many other critics have dealt with him incidentally. But the best single book on him by far is the *Mérimée et ses amis* of Augustin Filon (1894). M. F. Chambon's *Correspondance inédite* (1897) gives little that is substantive, but supplies and corrects a good many gaps or faults in earlier editions. English translations, especially of *Colomba* and *Carmen*, are numerous. The *Chronique de Charles IX.* was translated by G. Saintsbury in 1889 with an introduction; and the same writer has also prefixed a much more elaborate essay, containing a review of Mérimée's entire work, to an American translation. (G. S.A.)

MERINO, the Spanish name for a breed of sheep, and hence applied to a woollen fabric. The Spanish word is generally taken to be an adaptation to the sheep of the name of an official (*merino*) who inspected sheep pastures. This word is from the medieval Latin *majorinus*, a steward, head official of a village, &c., from *major*, greater.

The merino is a white short-wool sheep, the male having spiral horns, the ewes being generally hornless. It is bred chiefly for its wool, because, though an excellent grazer and very adaptable, it matures slowly and its mutton is not of the best quality. The wool is close and waxy in staple, reaching 4 in. in length, and surpasses that of all other sheep in fineness; it is so abundant that little but the muzzle, which should be of an orange tint, and hoofs, are left uncovered. The best wool is produced on light sandy soils.

The merino is little known in Great Britain, the climatic moisture of which does not favour the growth of the finest wools, but it predominates in all regions where sheep are bred for their wool rather than their mutton, as in the western United States, Cape Colony, Australia, New Zealand and Argentina. In Australasia, especially in New Zealand, the merino has been crossed with Lincolns, Leicesters, Shropshires and other breeds, with the result of improving the quality

of the mutton while sacrificing to some extent that of the wool.

The merino sheep appears to have originated in Africa, whence it was brought by the Moors to Spain and thence spread over Europe, especially to Austria-Hungary, Germany and France. The best-known breeds are the Rambouillet, a large merino named after the village near Paris, to which it was imported towards the end of the 18th century, and the Negretti, which stands in closer relationship to the old Spanish stock and has shorter wool but a more wrinkled fleece. Importations to America began about the beginning of the 19th century. The so-called American merino, the Delaine, the Vermont and the Rambouillet, are well-known breeds in the United States.

The term "merino" is widely employed in the textile industries with very varied meanings. Originally it was restricted to denote the wool of the merino sheep reared in Spain, but owing to the superiority of the wools grown on merino sheep and shipped from Botany Bay, the name as applied to wool was replaced by the term "botany." In the dress-goods and knitting trades the term "merino" still implies an article made from the very best soft wool. The term "cashmere," however, is frequently confused with it, although cashmere goods should be made from true cashmere and not, as is often the case, from the finest botany wool. In the hosiery and remanufactured materials trades the term "merino" is applied to fibre-mixtures of cotton and wool in contradistinction to "all wool" goods.

MERIONETH (Welsh, *Meirionydd*), a county of North Wales, bounded N. by Carnarvon and Denbigh, E. by Denbigh and Montgomery, S.E. by Montgomery, S. by the Dovey (*Dyfi*) estuary, dividing it from Cardigan, and W. by Cardigan Bay. It is nearly triangular, its greatest length from N.E. to S.W. being about 45 m., its greatest breadth about 30 m. The relief is less bold than that of Carnarvon, but the scenery is richer and more picturesquely varied. The highest summits are the peaks of Cader Idris (*g.u.*) including Pen y gader (the head of the chair; 2027 ft.); Aran Fawddwy (2070 ft.); Arenig fawr (2600 ft.); Y Llethr (2475 ft.), and Rhobell fawr (2313 ft.). Perhaps the finest of the valleys are those of Dyfi (Dovey) Dysyni, Tal y llyn (forehead of the lake), Maw (Mawddach), and Festiniog. The Dyfrdwy (Dee) drains Bala Lake (*Llyn Tegid* or *Pimblemere*), which is fed by two brooks rising at the foot of the Berwyn Hills. The Dyfrdwy leaves the lake at the north-east corner, near Castell Goronwy (erected 1202, hardly traceable), flowing slowly to Corwen, after which it is rapid, and receives the tributaries Alwen, Ceiriog, Clywedog and Alun. The Dyfi (Dovey) rising in a small lake near Aran Fawddwy, passes Machynlleth, and expands into an estuary of Cardigan Bay. Rising north of the Aran, the Mawddach (Maw) runs south-west some 12 m., being joined by rivulets. Traeth bach is formed by the Dyfrdwy streamlet among others. Other streams are the Wnion, Eden, Cain (variously spelled). Besides Bala and Tal y llyn lakes, there are among the hills over fifty more, e.g. Llyn Mwyngil. Among the waterfalls may be mentioned Rhaiafyr y glyn (cascade of the glen), near Corwen, Rhaiafyr du (black), and Pistyll Cain (Cain's waterspout), some 150 ft. high.

A mountain tract of the county, 15 m. from north to south by 10 m. from east to west, stretching from the coast inland, is of the Cambrian age, composed of grits, quartzites and slates, and comprising the Merionethshire anticline. The central portion of this tract is occupied mainly by Harlech Grits and Menevian beds; it is bordered on the north, east and south by the Lingula, Tremadoc and Arenig beds, which are pierced by numerous dikes and intrusive masses, mostly greenstone. The andesitic rock of Rhobell-fawr is one of the greatest igneous masses in the whole area of the Lingula beds. The Lingula beds are quarried and mined for slate at Festiniog, and near Dolgelly gold is obtained from a quartz vein, while near Barmouth manganese has been worked. Bordering the Cambrian area are the Ordovician rocks. The Arenig beds are interstratified with and overlaid by accumulations of volcanic ashes, felspathic traps or lava-flows, which form the rugged heights of Cader Idris, the Arans, the Arenigs, Manod and Moelwyn; and these are in turn overlaid by the Llandeilo and Bala beds, the latter including the Bala limestone. Lead and copper ores have been worked near Towyn.

Here and there along the eastern boundary Llandovery and Wenlock strata are included. The structure of the Silurian tract is synclinal; in the Berwyn mountains the Ordovician rocks again appear with associated andesitic and felsitic lavas and tufts. West of Llangar, near Corwen, is a small patch of Carboniferous limestone. Glacial drift with boulder clay is a prominent feature in the valleys and on the mountain sides. A good deal of blown sand fringes the coast north and south of Harlech. At the Llyn Arenig Bach a deposit of kieselsguhr has been found.

The climate varies much with the elevation, from bleak to genial, as at Aberdyfi (Aberdovey). Grain crops cover a small area only, green crops being poor, and fruits practically *nil*. While the soil is generally thin, there are fertile tracts in the valleys, and there is some reclaimed land. The small, hardy ponies (known as Llanbedr, Conway Valley) are now almost restricted to this county and Montgomeryshire. Manufactures include woollen stockings, &c., at and near Bala, flannels at Dolgellau (Dolgelley), Towyn, and a few other places. Slate is the chief staple. The Cambrian railway skirts the coast from Portmadoc to Aberdyfi. At Barmouth junction a branch crosses to Dolgellau, where it is joined by a branch of the Great Western railway. Bala and Festiniog are also united by the Great Western, and Festiniog is further joined with Llandudno junction by the London & North Western railway, and with Portmadoc (Minffordd) by the narrow gauge railway, a light line, opened in 1865, running between Portmadoc and Duffws, rising 700 ft. in 13 m. The tourist traffic is a source of livelihood to many of the inhabitants. The coast is almost un navigable, owing to sandbanks, and the only havens are Barmouth and Aberdyfi.

The area of the ancient county is 427,810 acres or 670 sq. m., with a population in 1801 of 49,212 and 1901 of 49,140. In the 19th century, however, the population nearly doubled. The area of the administrative county is 422,018 acres. Welsh is the tongue *par excellence* of Merionethshire. The county returns one member to parliament, and has neither parliamentary nor municipal borough. The urban districts are: Bala (pop. 1544), Barmouth (Abermaw, 2214), Dolgellau (Dolgellau, 2437), Festiniog (11,435), Mallow (885), Towyn (3756). The shire is in the north-west circuit, and assizes are held at Dolgellau. It is partly in the diocese of St Asaph and partly in that of Bangor, and has 37 ecclesiastical parishes and districts, with parts of four others.

History and Antiquities.—This is the only Welsh county retaining in English its primitive British name, latinized into *Merionia*, a subdivision of *Britannia Secunda*, and in the Ordovices' territory. The poet Churchyard in 1587 described the county as remote and difficult of access in his day, and it was never made the field of battle in Saxon, Danish or Norman times, nor indeed until close on the period of Welsh loss of independence. There are not many remains, Celtic, Roman or medieval. Caer Drewyn, a British fort on the Dee, is near Corwen, where Owen Gwynedd was posted to repel Henry II. and whither Owen Glendower retired before Henry IV. The numerous cromlechs are chiefly near the coast. The Roman *via occidentalis* ran through the county from south to north and was joined by a branch of Watling Street at Tomen y mur (perhaps *Herri Mons*) on Sarn Helen, not far from Castell Prysor. Tomen y mur (*destritus* of the wall) and Castell Prysor have yielded Roman bricks, tiles, urns and coins. Castell y bere, an extensive ruin, and once one of Wales's largest castles, has not been inhabited since the time of Edward I. Cymmer Abbey (*Y Fanner*) near Dolgellau, a Cistercian establishment founded about 1200, and dissolved by Henry VIII., is most perfect at the east end, with lancet windows, and against the south wall there are a few Gothic pillars and arches. The architecture varies from Norman to Perpendicular. Towen y Bala, east of Bala, is supposed to be a Roman encampment. It was afterwards occupied by the Welsh, to check the English lords marchers. Moel Ofirwm is near Dolgellau. Among the county families may be mentioned that of Hengwrt, since the Hengwrt Welsh MSS. are famous in north Wales and among all Celtic scholars.

MERISTEM (Gr. *μεριστός*, divided or divisible), a botanical term for tissue which has the power of developing new

forms of tissue, such as the cambium from which new wood is developed.

MERIVALE, CHARLES (1808-1893), English historian and dean of Ely, the second son of John Herman Merivale and Louisa Heath Drury, daughter of Dr Drury, head master of Harrow, was born on the 8th of March 1808. His father (1779-1844) was an English barrister, and, from 1831, a commissioner in bankruptcy; he collaborated with Robert Bland (1799-1825) in his *Collections from the Greek Anthology*, and published some excellent translations from Italian and German. Charles Merivale was at Harrow School (1818 to 1824) under Dr Butler. His chief friends were Charles Wordsworth, afterwards bishop of St Andrews, and Richard Chenevix Trench, afterwards archbishop of Dublin. In 1824 he was offered a writership in the Indian civil service, and went for a short time to Haileybury College, where he was distinguished for proficiency in Oriental languages. But he eventually decided against an Indian career, and went up to St John's College, Cambridge, in 1826. Among other distinctions he came out as fourth class in 1830, and in 1833 was elected fellow of St John's. He was a member of the Apostles' Club, his fellow-members including Tennyson, A. H. Hallam, Monckton Milnes, W. H. Thompson, Trench and James Spedding. He was fond of athletic exercises, had played for Harrow against Eton in 1824, and in 1829 rowed in the first inter-university boat-race, when Oxford won. Having been ordered in 1833, he undertook college and university work successfully, and in 1839 was appointed select preacher at Whitehall. In 1848 he took the college living of Lawford, near Manningtree, in Essex; he married, in 1850, Judith Mary Sophia, youngest daughter of George Frere. In 1863 he was appointed chaplain to the Speaker of the House of Commons, declined the professorship of modern history at Cambridge in 1869, but in the same year accepted from Mr Gladstone the deanery of Ely, and until his death on the 27th of December 1893 devoted himself to the best interests of the cathedral. He received many honorary academical distinctions. His principal work was *A History of the Romans under the Empire*, in seven volumes, which came out between 1850 and 1862; but he wrote several smaller historical works, and published sermons, lectures and Latin verses. Merivale as a historian cannot be compared with Gibben for virility, but he takes an eminently common-sense and appreciative view. The chief defect of his work, inevitable at the time it was composed, is that, drawing the materials from contemporary memoirs rather than from inscriptions, he relies on literary gossip rather than on numismatics and epigraphy. The dean was an elegant scholar, and his rendering of the *Hyperion* of Keats into Latin verse (1862) has received high praise.

See *Autobiography of Dean Merivale*, with selections from his correspondence, edited by his daughter, Judith A. Merivale (1899); and *Family Memorials*, by Anna W. Merivale (1884).

MERIVALE, HERMAN (1806-1874), English civil servant and author, elder brother of the preceding, was born at Dawlish, Devonshire, on the 8th of November 1806. He was educated at Harrow School, and in 1823 entered Oriel College, Oxford. In 1825 he became a scholar of Trinity College and also won the Ireland scholarship, and three years later he was elected fellow of Balliol College. He became a member of the Inner Temple and practised on the western circuit, being made in 1841 recorder of Falmouth, Helston and Penzance. From 1837 to 1842 he was professor of political economy at Oxford. In this capacity he delivered a course of lectures on the British Colonies in which he dealt with questions of emigration, employment of labour and the allotment of public lands. The reputation he secured by these lectures had much to do with his appointment in 1847 as assistant under-secretary for the colonies, and in the next year he became permanent under-secretary. In 1859 he was transferred to the permanent under-secretaryship for India, receiving the distinction of C.B. In 1870 Merivale was made D.C.L. of Oxford. He died on the 8th of February 1874. Besides his *Lectures on Colonization and Colonies* (1841),

he published *Historical Studies* (1865), and completed the *Memoirs of Sir Philip Francis* (1867); he wrote the second volume of the *Life of Sir Henry Lawrence* (1872) in continuation of Sir Herbert Edwardes's work.

A tribute to his powers as an original thinker by his chief at the Colonial Office, Sir Edward Bulwer-Lytton, is printed with a notice of his career which his brother contributed to the *Transactions* (1884) of the Devonshire Association.

MERKARA, the capital of the province of Coorg, in Southern India, situated on a plateau about 4000 ft. above the sea. Pop. (1901), 6732. It consists of two quarters: the fort, containing the public offices, the old palace, and the residence of the commissioner; and the native town of Mahadevapet. Here are the headquarters of the Coorg and Mysore Rifles, a body of volunteers chiefly composed of coffee planters.

MERLIN, ANTOINE CHRISTOPHE (1762-1833), French revolutionist, called "of Thionville" to distinguish him from his namesake of Douai (see below), was born at Thionville on the 13th of September 1762, being the son of a *procureur* in the *bailliage* of Thionville. After studying theology, he devoted himself to law, and in 1788 was an *avocat* at the parlement of Metz. In 1790 he was elected municipal officer of Thionville, and was sent by the department of Moselle to the Legislative Assembly. On the 23rd of October 1791 he moved and carried the institution of a committee of surveillance, of which he became a member. It was he who proposed the law sequestrating the property of the *émigrés*, and he took an important part in the *émoule* of the 20th of June 1792 and in the revolution of the 10th of August of the same year. He was elected deputy to the National Convention, and pressed for the execution of Louis XVI., but a mission to the army prevented his attendance at the trial. He displayed great bravery in the defence of Mainz. He took part in the reaction which followed the fall of Robespierre, sat in the Council of the Five Hundred under the Directory, and at the *coup d'état* of the 18th Fructidor (Sept. 4, 1797) demanded the deportation of certain republican members. In 1798 he ceased to be a member of the Council of Five Hundred, and was appointed director-general of posts, being sent subsequently to organize the army of Italy. He retired into private life at the proclamation of the consulate, and lived in retirement under the consulate and the empire. He died in Paris on the 14th of September 1833.

See J. Reynaud, *Vie et correspondance de Merlin de Thionville* (Paris, 1860).

MERLIN, PHILIPPE ANTOINE, COUNT (1754-1838), French politician and lawyer, known as Merlin "of Douai," was born at Arleux (Nord) on the 30th of October 1754, and was called to the Flemish bar in 1780. An indefatigable student, he collaborated in the *Répertoire de jurisprudence* published by J. N. Guyot, the later editions of which appeared under Merlin's superintendence, and also contributed to other important legal compilations. Elected to the states-general as deputy for Douai, he was one of the chief of those who applied the principles of liberty and equality embodied in the decree of the 4th of August 1789 to actual conditions. On behalf of the committee appointed to deal with feudal rights, he presented to the Convention reports on the seigniorial rights which were subject to compensation, on hunting and fishing rights, forestry, and kindred subjects. He carried legislation for the abolition of primogeniture, secured equality of inheritance between relations of the same degree, and between men and women. His numerous reports to the Constituent Assembly were supplemented by popular exposition of current legislation in the *Journal de législation*. On the dissolution of the Constituent Assembly he became judge of the criminal court at Douai. He was no advocate of violent measures; but, as deputy to the Convention, he voted for the death of Louis XVI., and as a member of the council of legislation he presented to the Convention on the 17th of September 1793 the infamous law permitting the detention of *suspects*. He was closely allied with his namesake Merlin "of Thionville," and, after the counter-revolution which brought about the fall of Robespierre,

he became president of the Convention and a member of the Committee of Public Safety. His efforts were primarily directed to the prevention of any recrudescence of the tyranny exercised by the Jacobin Club, the commune of Paris, and the revolutionary tribunal. He persuaded the Committee of Safety to take upon itself the closing of the Jacobin Club, on the ground that it was an administrative rather than a legislative measure. He recommended the readmission of the survivors of the Girondin party to the Convention, and drew up a law limiting the right of insurrection; he had also a considerable share in the foreign policy of the victorious republic. With Cambacérés he had been commissioned in April 1794 to report on the civil and criminal legislation of France, with the result that after eighteen months' work he produced his *Rapport et projet de code des délits et des peines* (10 Vendémiaire, an. IV.). Merlin's code abolished confiscation, branding and imprisonment for life, and was based chiefly on the penal code drawn up in September 1791. He was made minister of justice (Oct. 30, 1795) under the Directory, and showed excessive rigour against the emigrants. After the *coup d'état* of the 18th Fructidor he became (Sept. 5, 1797) one of the five directors, and was accused of the various failures of the government. He retired into private life (June 18, 1799), and had no share in the revolution of the 18th Brumaire. Under the consulate he accepted a modest place in the court of cassation, where he soon became procureur-général. Although he had no share in drawing up the Napoleonic code, he did more than any other lawyer to fix its interpretation. He became a member of the council of state, count of the empire, and grand officer of the Legion of Honour; but having resumed his functions during the Hundred Days, he was one of those banished on the second restoration. The years of his exile were devoted to his *Répertoire de jurisprudence* (5th ed., 18 vols., Paris, 1827-1828) and to his *Recueil alphabétique des questions de droit* (4th ed., 8 vols., Paris, 1827-1828). At the revolution of 1830 he was able to return to France, when he re-entered the Institute of France, of which he had been an original member, being admitted to the Académie des Sciences Morales et Politiques. He died in Paris on the 26th of December 1838.

His son, ANTOINE FRANÇOIS EUGÈNE MERLIN (1778-1854), was a well-known general in the French army, and served through most of Napoleon's campaigns.

See M. Mignet, *Portraits et notices historiques* (1852), vol. i.

MERLIN (Welsh, *Myrddhin*), the famous bard of Welsh tradition, and enchanter of Arthurian romance. His history as related in this latter may be summarized as follows. The infernal powers, aghast at the blow to their influence dealt by the Incarnation, determine to counteract it, if possible, by the birth of an Antichrist, the offspring of a woman and a devil. As in the book of Job, a special family is singled out as subjects of the diabolic experiment, their property is destroyed, one after the other perishes miserably, till one daughter, who has placed herself under the special protection of the Church, is left alone. The demon takes advantage of an unguarded moment of despair, and Merlin is engendered. Thanks, however, to the prompt action of the mother's confessor, Blaise, in at once baptizing the child of this abnormal birth, the mother truly protesting that she has had intercourse with no man, Merlin is claimed for Christianity, but remains dowered with demonic powers of insight and prophecy. An infant in arms, he saves his mother's life and confounds her accusers by his knowledge of their family secrets. Meanwhile Vortigern, king of the Britons, is in despair at the failure of his efforts to build a tower in a certain spot; however high it may be reared in a day, it falls again during the night. He consults his diviners, who tell him that the foundations must be watered with the blood of a child who has never had a father; the king accordingly sends messengers through the land in search of such a prodigy. They come to the city where Merlin and his mother dwell at the moment when the boy is cast out from the companionship of the other lads on the ground that he has had no father. The messengers take him to the king, and on the way he astonishes them by certain prophecies which

are fulfilled to their knowledge. Arrived in Vortigern's presence, he at once announces that he is aware alike of the fate destined for him and of the reason, hidden from the magicians, of the fall of the tower. It is built over a lake, and beneath the waters of the lake in a subterranean cavern lie two dragons, a white and a red; when they turn over the tower falls. The lake is drained, the correctness of the statement proved, and Merlin's position as court prophet assured. Henceforward he acts as adviser to Vortigern's successors, the princes Ambrosius and Uther (subsequently Uther-Pendragon). As a monument to the Britons fallen on Salisbury Plain he brings from Ireland, by magic means, the stones now forming Stonehenge. He aids Uther in his passion for Yguerne, wife to the duke of Cornwall, by Merlin's spells Uther assumes the form of the husband, and on the night of the duke's death Arthur is engendered. At his birth the child is committed to Merlin's care, and by him given to Antor, who brings him up as his own son. On Arthur's successful achievement of the test of the sword in the "perron," Merlin reveals the truth of his parentage and the fact that he is by hereditary right, as well as by divine selection, king of the Britons. During the earlier part of Arthur's reign Merlin acts as counsellor; then he disappears mysteriously from the scene. According to one account he is betrayed by a maiden, Nimue or Niniane (a king's daughter, or a water-fairy, both figure in different versions), of whom he is enamoured, and who having beguiled from him a knowledge of magic spells, casts him into a slumber and imprisons him living in a rocky tomb. This version, with the great cry, or *Brail*, which the magician uttered before his death, appears to have been the most popular. Another represents his prison as one of air; he is invisible to all, but can see and hear, and occasionally speak to passers by; thus he holds converse with Gawain. In the prose *Perceval* he retires voluntarily to an "Esplumeur" erected by himself, and is seen no more of man.

The curious personality of Merlin is now generally recognized as being very largely due to the prolific invention of Geoffrey of Monmouth. Nennius, upon whose *Historia* Geoffrey enlarged and "improved," gives indeed the story of Vortigern and the tower, but the boy's name is Ambrosius. Geoffrey calls him Merlin-Ambrosius, a clear proof that he was adapting Nennius' story. He represents the sage in his rôle of court diviner, his "Prophecies" being incorporated in later manuscripts of the *Historia*. Subsequently Geoffrey enlarged on the theme, composing a *Vita Merlini* in which we find the magician in the rôle of a "possessed" wood-abider, fleeing the haunts of men, and consorting with beasts. This gave rise to the idea that there had originally been two Merlins, Merlin-Ambrosius and Merlin-Sylvester, a view now discarded by the leading scholars. The *Vita* was so successful that Geoffrey obtained as reward the bishopric of St Asaph.

Welsh vernacular literature has preserved a small but interesting group of poems, strongly national and patriotic in character, which are attributed to Merlin (*Myrddhin*).

A few years after Geoffrey's death Merlin's adventures were amplified into a romance, the first draft of which is attributed to Robert de Borron, and which eventually took the form of a lengthy introduction to the prose *Lancelot* and cyclic redaction of the Arthurian legend.

The romantic, as distinguished from legendary or historical Merlin, exists in the following forms: (a) a fragmentary poem preserved in a unique manuscript of the Bibl. nat. (this gives no more than the introduction to the story); (b) a prose rendering of the above, of which a fair number of copies exist, generally found, as in the original poem, coupled with a version of the early history of the Grail, known as *Joseph of Arimathea*, and in two cases followed by a *Perceval* and *Mort Artus*, thus forming a small cycle; (c) the Ordinary or Vulgate *Merlin*, a very lengthy romance, of which numerous copies exist (see Dr Sommer's edition); (d) and (e) two continuations to the above, each represented by a single manuscript—(d) the "Huth" *Merlin*, which was utilized by Malory for his translation, and also formed a part of the compilation used by the Spanish and Portuguese translators, and (e) a very curious manuscript, 337, Bibl. nat. (fonds Français), which Paulin Paris calls the *Livre Artus*, containing much matter not found elsewhere. M. La Villemarqué's "critical study" (*Myrddhin, ou l'enchanteur*

Merlin, 1861) cannot be regarded as much more trustworthy than Geoffrey himself. The story of the tower, and the Boy without a Father, has been critically examined by Dr Gaster, in a paper read before the Folk-lore Society and subsequently published in *Folk-lore* (vol. xvi.). Dr Gaster cites numerous Oriental parallels to the tale, and sees in it the germ of the whole Merlin legend. Alfred Nutt (*Revue celtique*, vol. xxvii.) has since shown that Aengus, the magician of the Irish *Poesie de Danouan*, was also of unknown parentage, and it seems more probable that the Boy without a Father theme was generally associated with the Celtic magicians, and is the property of no one in particular. Some years ago the late Mr Ward of the British Museum drew attention to certain passages in the life of St Kentigern, relating his dealings with a "possessed" being, a dweller in the woods, named Lailoken, and pointed out the practical identity of the adventures of that personage and those assigned by Geoffrey to Merlin in the *Vita*; the text given by Mr Ward states that some people identified Lailoken with Merlin (see *Romania*, vol. xxvii.). Ferd. Lot, in an examination of the sources of the *Vita Merlini* (*Annales de Bretagne*, vol. xv.), has pointed out the more original character of the "Lailoken" fragments, and decides that Geoffrey knew the Scottish tradition and utilized it for his *Vita*. He also comes to the conclusion that the Welsh Merlin poems, with the possible exception of the *Dialogue between Merlin and Taliesin*, are posterior to, and inspired by, Geoffrey's work. So far the researches of scholars appear to point to the result that the legend of Merlin, as we know it, is of complex growth, combined from traditions of independent and widely differing origin. Most probably there is a certain substratum of fact beneath all; there may have been, there very probably was, a bard and soothsayer of that name, and it is by no means improbable that curious stories were told of his origin. It is worth noting that Layamon, whose translation of Wace's *Brut* is of so much interest, on account of the variants he introduces into the text, gives a much more favourable form of the "Birth" story; the father is a glorious and supernatural being, who appears to the mother in her dreams. Layamon lived on the Welsh border, and the possibility of his variants being drawn from genuine British tradition is generally recognized. The poem relating a dialogue between Merlin and his brother bard, Taliesin, may also derive from genuine tradition. Further than this we can hardly venture to go; the probability is that anything more told of the character and career of Merlin rests upon the imaginative powers and faculty of combination of Geoffrey of Monmouth.

See also G. Paris and Ulrich (*Société des anciens textes français*, 1886); *Merlin*, ed. Wheatley (Early English Text Society, 1899); *Arthur and Merlin*, ed. Kölling. (J. L. W.)

MERLON, in architecture, the solid part of an embattled parapet between the embrasures, sometimes pierced by loopholes. The word is French, adapted from Ital. *merlone*, possibly a shortened form of *mergola*, connected with Lat. *mergae*, pitchfork, or from a diminutive *moerulus*, from *murus* (*moeruns*), a wall.

MERMAIDS and MERMEN, in the folk-lore of England and Scotland, a class of semi-human beings who have their dwelling in the sea, but are capable of living on land and of entering into social relations with men and women.¹ They are easily identified, at least in some of their most important aspects, with the Old German Meriminni or Meerfrau, the Icelandic Hafgufa, Mærkygr, and Marmennill (mod. Marbendill), the Danish Haïmand or Mærend, the Irish Merrow or Merruach, the Marie-Morgan of Brittany and the Morforwyn of Wales;² and they have various points of resemblance to the vodyany or water-sprite and the rusalka or stream-fairy of Russian mythology. The typical mermaid has the head and body of a woman, usually of exceeding loveliness, but below the waist is fashioned like a fish with scales and fins. Her hair is long and beautiful, and she is often represented, like the Russian rusalka, as combing it with one hand while in the other she holds a looking-glass. For a time at least a mermaid may become to all appearance an ordinary human being; and in Irish legend ("The Overflowing of Lough Neagh and Liban

¹ The name *mermaid* is compounded of *mere*, a lake, and *mægd*, a maid; but, though *mere wif* occurs in Beowulf, *mermaid* does not appear till the Middle English period (Chaucer, *Roman of the Rose*, &c.). In Cornwall the fishermen say *mary-moider* and *merry-men*. The connexion with the sea rather than with inland waters appears to be of later origin. "The Mermaid of Martin Meer" (Roby's *Traditions of Lancashire*, vol. ii.) is an example of the older form of the word; and such "meer-women" are known to the country-folk in various parts of England (e.g. at Newport in Shropshire, where the town is some day to be drowned by the woman's agency).

² See Rhys, "Welsh Fairy Tales," in *Y Cymmrodor* (1881, 1882).

the Mermaid," in Joyce's *Old Celtic Romances*) represents the temporary transformation of a human being into a mermaid.

The mermaid legends of all countries may be grouped as follows. (a) *A mermaid or mermaids either voluntarily or under compulsion reveal things that are about to happen.* Thus the two mermaids (merewip) Hadeburc and Sigelint, in the *Nibelungenlied*, disclose his future course to the hero Hagen, who, having got possession of their garments, which they had left on the shore, compels them to pay ransom in this way. According to Resenius, a mermaid appeared to a peasant of Samsø, foretold the birth of a prince, and moralized on the evils of intemperance, &c. (*Kong Frederichs den andens Krønike*, Copenhagen, 1680, p. 302). (b) *A mermaid imparts supernatural powers to a human being.* Thus in the beautiful story of "The Old Man of Cury" (in Hunt's *Popular Romances of the West of England*, 1871) the old man, instead of silver and gold, obtains the power of doing good to his neighbours by breaking the spells of witchcraft, chasing away diseases, and discovering thieves. (c) *A mermaid has some one under her protection, and for wrong done to her ward exacts a terrible penalty.* One of the best and most detailed examples of this class is the story of the "Mermaid's Vengeance" in Hunt's book already quoted. (d) *A mermaid falls in love with a human being, lives with him as his lawfully wife for a time, and then, some compact being unwittingly or intentionally broken by him, departs to her true home in the sea.* Here, if its mermaid form be accepted, the typical legend is undoubtedly that of *Mélusine* (q.v.), which, being made the subject of a romance by Jean d'Arras, became one of the most popular folk-books of Europe, appearing in Spanish, German, Dutch and Bohemian versions. (e) *A mermaid falls in love with a man, and entices him to go to live with her below the sea; or a merman wins the affection or captures the person of an earthborn maiden.* This form of legend is very common, and has naturally been a favourite with poets. Macphail of Colonsay successfully rejects the allurements of the mermaid of Corrievrekin, and comes back after long years of trial to the maid of Colonsay.³ The Danish ballads are especially full of the theme; as "Agnete and the Merman," an antecedent of Matthew Arnold's "Forsaken Mermaid";⁴ the "Deceitful Merman, or Marstig's Daughter";⁵ and the finely detailed story of Rosmer Hafmand (No. 49 in Grimm).

In relation to man the mermaid is usually of evil issue if not of evil intent. She has generally to be bribed or compelled to utter her prophecy or bestow her gifts, and whether as wife or paramour she brings disaster in her train. The fish-tail, which in popular fancy forms the characteristic feature of the mermaid, is really of secondary importance; for the true Teutonic mermaid—probably a remnant of the great cult of the Vanir—had no fish-tail; and this symbolic appendage occurs in the mythologies of so many countries as to afford no due to its place of origin. The Tritons, and, in the later representations, the Sirens of classical antiquity, the Phœnician Dagon, and the Chaldaean Oannes are all well-known examples; the Ottawas and other American Indians have their man-fish and woman-fish (Jones, *Traditions of the North American Indians*, 1830); and the Chinese tell stories not unlike our own about the sea-women of their southern seas (Dennis, *Folklore of China*, 1875).

Quasi-historical instances of the appearance or capture of mermaids are common enough,⁶ and serve, with the frequent use of the figure on signboards and coats of arms, to show how thoroughly the myth had taken hold of the popular imagination.⁷

³ See Leyden's "The Mermaid," in Sir Walter Scott's *Border Minstrelsy*.

⁴ Karl Blind, "New Finds in Shetlandic and Welsh Folk-Lore," in *Gentleman's Magazine* (1882).

⁵ Compare the strange account of the quasi-human creatures found in the Nile given by Theophrastus, *Historia*, viii. 16, pp. 290-302, of Bekker's edition.

⁶ See the paper in *Journ. Brit. Arch. Assoc.*, xviii., 1882, by H. S. Cumings, who points out that mermaids or mermen occur in the arms of Eales Caledon, Howth and Sandwich, Viscounts Boyne and Hood, Lord Lytton and Scott of Abbotsford, as well as in those of the Ellis, Byron, Phené, Skeffington and other families. The English heralds represent the creatures with a single tail, the French and German heralds frequently with a double one.

A mermaid captured at Bangor, on the shore of Belfast Lough, in the 6th century, was not only baptized, but admitted into some of the old calendars as a saint under the name of Murgen (*Notes and Queries*, Oct. 21, 1882); and Stowe (*Annales*, under date 1187) relates how a man-fish was kept for six months and more in the castle of Orford in Suffolk. As showing how legendary material may gather round a simple fact, the oft-told story of the sea-woman of Edam is particularly interesting. The oldest authority, Joh. Gerbrandus a Leydis, a Carmelite monk (d. 1504), tells (*Annales*, &c., Frankfurt, 1620) how in 1403 a wild woman came through a breach in the dike into Purmerlake, and, being found by some Edam milkmaids, was ultimately taken to Haarlem and lived there many years. Nobody could understand her, but she learned to spin, and was wont to adore the cross. Ocka Scharlensis (*Chronijk van Friesland*, Leeuw., 1597) reasons that she was not a fish because she could spin, and she was not a woman because she could live in the sea; and thus in due course she got fairly established as a genuine mermaid. Vosmaer, who has carefully investigated the matter, enumerates forty writers who have repeated the story, and shows that the older ones speak only of a woman (see "Besch. van de zoogen. Meermin der stad Haarlem," in *Verh. van de Holl. Maatsch. van K. en Wet.*, part 23, No. 1786).

The best account of the mermaid-myth is in Baring-Gould's *Myths of the Middle Ages*. See also, besides works already mentioned, Pontoppidan, who in his logically credulous work collects much matter to prove the existence of mermaids; Maillet, *Telliamed* (Hague, 1755); Grimm, *Deutsche Mythologie*, i. 404, and *Aldân. Heldenlieder* (1811); Waldron's *Description and Train's Hist. and Stat. Acc. of the Isle of Man*; Folk-lore Society's *Records*, vol. ii.; Napier, *Hist. and Trad. Tales connected with the South of Scotland*; Schöller, *Traditions de la haute Bretagne* (1882), and *Contes des marins* (1882).

MEROBAUDES, FLAVIUS (5th century A.D.), Latin rhetorician and poet, probably a native of Baetica in Spain. He was the official laureate of Valentinian III. and Aëtius. Till the beginning of the 19th century he was known only from the notice of him in the *Chronicle* (year 443) of his contemporary Idacius, where he is praised as a poet and orator, and mention is made of statues set up in his honour. In 1813 the base of a statue was discovered at Rome, with a long inscription belonging to the year 435 (*C.I.L.* vi. 1724) upon Flavius Merobaudes, celebrating his merits as warrior and poet. Ten years later, Niebuhr discovered some Latin verses on a palimpsest in the monastery of St Gall, the authorship of which was traced to Merobaudes, owing to the great similarity of the language in the prose preface to that of the inscription. Formerly the only piece known under the name of Merobaudes was a short poem (30 hexameters) *De Christo*, attributed to him by one MS., to Claudian by another; but Ebert is inclined to dispute the claim of Merobaudes to be considered either the author of the *De Christo* or a Christian.

The "Panegyric" and minor poems have been edited by H. G. Niebuhr (1824); by I. Bekker in the *Bonn Corpus scriptorum hist. Byz.* (1836); the "De Christo" in T. Birt's *Claudian* (1892), where the authorship of Merobaudes is upheld; see also A. Ebert, *Geschichte der Literatur des Mittelalters im Abendlande* (1889).

MEROE, the general name (as Island of Meroe) for the region bounded on three sides by the Nile (from Atbara to Khartum), the Atbara, and the Blue Nile; and the special name of an ancient city on the east bank of the Nile, 877 m. from Wadi Halfa by river, and 554 by the route across the desert, near the site of which is a group of villages called Bakarawiya. The site of the city is marked by over two hundred pyramids in three groups, of which many are in ruinous condition. After these ruins had been described by several travellers, among whom F. Cailliaud (*Voyage à Meroë*, Paris, 1826-1828) deserves special mention, some excavations were executed on a small scale in 1834 by G. Ferlini (*Cenno sugli scavi operati nella Nubia e catalogo degli oggetti ritrovati*, Bologna, 1837), who discovered (or professed to discover) various antiquities, chiefly in the form of jewelry, now in the museums of Berlin and Munich. The ruins were examined in 1844 by C. R. Lepsius, who brought

many plans, sketches and copies, besides actual antiquities, to Berlin. Further excavations were carried on by E. W. Budge in the years 1902 and 1905, the results of which are recorded in his work, *The Egyptian Sûdan: its History and Monuments* (London, 1907). Troops were furnished by Sir Reginald Wingate, governor of the Sudan, who made paths to and between the pyramids, and sank shafts, &c. It was found that the pyramids were regularly built over sepulchral chambers, containing the remains of bodies either burned or buried without being mummified. The most interesting objects found were the reliefs on the chapel walls, already described by Lepsius, and containing the names with representations of queens and some kings, with some chapters of the *Book of the Dead*; some steles with inscriptions in the Meroitic language, and some vessels of metal and earthenware. The best of the reliefs were taken down stone by stone in 1905, and set up partly in the British Museum and partly in the museum at Khartum. In 1910, in consequence of a report by Professor Sayce, excavations were commenced in the mounds of the town and the necropolis by J. Garstang on behalf of the university of Liverpool, and the ruins of a palace and several temples were discovered, built by the Meroite kings. (See further ETHIOPIA.)

Meroe was probably also an alternative name for the city of Napata, the ancient capital of Ethiopia, built at the foot of Jebel Barkal. The site of Napata is indicated by the villages of Sanam Abu Dom on the left bank of the Nile and Old Merawi on the right bank of the river. New Merawi, 1 m. east of Sanam Abu Dom and on the same side of the river, was founded by the Sudan government in 1905 and made the capital of the mudiria of Dongola. (D. S. M.)*

MEROPE, the name of several figures in Greek mythology. The most important of them are the following: (1) The daughter of Cypselus, king of Arcadia, and wife of Cresphontes, ruler of Messenia. During an insurrection Cresphontes and two of his sons were murdered and the throne seized by Polyphontes, who forced Merope to marry him. A third son, Aegyptus, contrived to escape, and, subsequently returning to Messenia, put Polyphontes to death and recovered his father's kingdom (Apollodorus ii. 8, 5; Pausanias iv. 3, 6). The fortunes of Merope have furnished the subject of tragedies by Euripides (*Cresphontes*, not extant), Voltaire, Maffei and Matthew Arnold. (2) The daughter of Atlas and wife of Sisyphus. She was one of the seven Pleiades, but remained invisible, hiding her light for shame at having become the wife of a mortal (Apollodorus i. 9, 3; iii. 10, 1; Ovid, *Fastii*, iv. 175).

MEROVINGIANS, the name given to the first dynasty which reigned over the kingdom of the Franks. The name is taken from Merovech, one of the first kings of the Salian Franks, who succeeded to Clodio in the middle of the 5th century, and soon became the centre of many legends. The chronicler known as Fredegarius Scholasticus relates that a queen was once sitting by the seashore, when a monster came out of the sea, and by this monster she subsequently became the mother of Merovech, but this myth is due to an attempt to explain the hero's name, which means "the sea-born." At the great battle of Mauriac (the Catalaunian fields) in which Aetius checked the invasion of the Huns (451), there were present in the Roman army a number of Frankish *federati*, and a later document, the *Vita lupi*, states that Merovech (Merovaeus) was their leader. Merovech was the father of Childeric I. (457-481), and grandfather of Clovis (481-511), under whom the Salian Franks conquered the whole of Gaul, except the kingdom of Burgundy, Provence and Septimania. The sons of Clovis divided the dominions of their father between them, made themselves masters of Burgundy (532), and in addition received Provence from the Ostrogoths (535); Septimania was not taken from the Arabs till the time of Pippin, the founder of the Carolingian dynasty. From the death of Clovis to that of Dagobert (639), the Merovingian kings displayed considerable energy, both in their foreign wars and in the numerous wars against one another in which they found an outlet for their barbarian instincts. After 639, however, the race began to decline, one after another the kings succeeded to the throne,

but none of them reached more than the age of twenty or twenty-five; this was the age of the "rois fainéants." Henceforth the real sovereign was the mayor of the palace. The mayors of the palace belonging to the Carolingian family were able to keep the throne vacant for long periods of time, and finally, in 751 the mayor Pippin, with the consent of the pope Zacharias, sent King Childeric III. to the monastery of St Omer, and shut up his young son Thierry in that of St Wandrille. The Merovingian race thus came to an end in the cloister.

BIBLIOGRAPHY.—See Pétigny, *Études sur l'époque mérovingienne* (Paris, 1851); G. Richter, *Annalen des fränkischen Reichs im Zeitalter der Merowingier* (Halle, 1873); F. Dahn, *Die Könige der Germanen*, vii. (Leipzig, 1894); by the same author, *Urgeschichte der germanischen und romanischen Völker*, iii. (Berlin, 1883); W. Schultz, *Deutsche Geschichte von der Urzeit bis zu den Karolingern*, ii. (Stuttgart, 1896).

Merovingian Legend.—It has long been conceded that the great French national epics of the 11th and 12th centuries must have been founded on a great fund of popular poetry, and that many of the episodes of the *chansons de geste* refer to historical events anterior to the Carolingian period. *Floovant* is obviously connected with the *Gesta Dagoberti*, and there are traces of the influence of popular songs on the Frankish heroes in Gregory of Tours and other chroniclers. See G. Kurth, *Hist. polét. des Mérovingiens* (Paris, Brussels and Leipzig, 1893); A. Darmesteter, *De Floovante vetustiore gallico poemate* (Paris, 1877); *Floovant* (Paris, 1859); ed. MM. F. Guesnard and H. Michelant; P. Rajna, *Delle Origini dell' epopea francese* (Florence, 1884), with which cf. G. Paris in *Romania*, xiii. 602 seq.; F. Settegast, *Quellenstudien zur gallo-romanischen Epik* (Leipzig, 1904); C. Voretzsch, *Epische Studien* (Halle, 1900); H. Groeber, *Grundriss d. roman. Phil.* (Bd. II., abt. i. pp. 447 seq.). (C. Fr.)

MERRILL, a city and the county-seat of Lincoln county, Wisconsin, U.S.A., 185 m. N.W. of Milwaukee, on both sides of the Wisconsin river. Pop. (1910 census), 8689. It is served by the Chicago, Milwaukee & St Paul railroad. The city is situated about 1270 ft. above the sea and has an invigorating climate. Brook trout and various kinds of game, including deer, abound in the vicinity. Grandfather Falls and the Dells of the Prairie river are picturesque places near the city, and furnish good water-power. The principal public building is the Lincoln county court house, and the city contains the T. B. Scott free library, a fine high-school, and the Ravn hospital, a private institution. Riverside Park is maintained by a corporation, and a park along the Prairie river is owned and maintained by the city. Merrill is an important hardwood lumber market, and its principal industry is the manufacture of lumber and lumber products. The manufacture of paper and paper pulp and of lathes is also important. In 1905 the factory products were valued at \$3,260,638. There are granite quarries and brickyards in the vicinity. Merrill was settled in 1875, incorporated as a village in 1880, and chartered as a city in 1883.

MERRIMAC, a river in the north-eastern part of the United States, having its sources in the White Mountains of New Hampshire, and flowing south into Massachusetts, and thence east and north-east into the Atlantic Ocean. With its largest branch it has an extreme length of about 183 m. The Merrimac proper is formed at Franklin, New Hampshire, by the junction of the Pemigewasset and Winnepesaukee rivers. The former is the larger branch and rises in the White Mountains in Grafton county; the latter is the outlet of Lake Winnepesaukee. The valley of the Merrimac was formed before the glacial period and was filled with drift as the ice retreated; subsequently the high flood plain thus formed has been trenched, terraces have been formed, and at different places, where the new channel did not conform to the pre-glacial channel, the river has come upon buried ledges, relatively much more resistant than the drift below, and waterfalls have thus resulted. The river falls 269 ft. in a distance of 110 m. from Franklin to its mouth. The greater part of the total fall is at six points, and at each of four of these is a city which owes its importance in great measure to the water-power thus provided, Lowell and

¹The name is an Indian word said to mean "swift water." In popular usage the spelling "Merrimack" is used at places along the river above Haverhill.

Lawrence in Massachusetts, and Manchester and Concord in New Hampshire; at Lowell there is a fall of 30 ft. (Pawtucket Falls), and at Manchester there is a fall of 55 ft. (Amoskeag Falls). The region drained by the river is 4553 sq. m. in extent, and contains a number of lakes, which together with some artificial reservoirs serve as a storage system. On the navigable portion of the river, which extends 17½ m. above its mouth, are the cities of Newburyport, near its mouth, and Haverhill, at the head of navigation. In 1809-1908 the Federal government dredged a channel from Newburyport to Haverhill (14.5 m.) 7 ft. deep and 150 ft. wide at mean low water; vessels having a draft of 12.5 ft. could then pass over the outer bar of Newburyport.

MERRIMAN, HENRY SETON (d. 1903), the pen-name of Hugh Stowell Scott, English novelist. He was a member of the firm of Henry Scott & Sons, and was for some years an underwriter at Lloyd's. His literary career began in 1889 with *The Phantom Future*, and he made his first decided hit with his Russian story, *The Sowers* (1896), which was followed by many other well-constructed novels remarkable for excellence of plot and literary handling. The author was an enthusiastic traveller, many of his journeys being undertaken with his friend Stanley Weyman. He was about forty when he died at Melton, near Ipswich, on the 19th of November 1903. Among his most successful books were *Roden's Corner* (1898); *The Isle of Unrest* (1899); *In Kedar's Tent* (1897); *The Velvet Glove* (1901); *The Vultures* (1902); *Barlasch of the Guard* (1903); and *The Last Hope* (1904).

MERRITT, WESLEY (1836—), American soldier, was born in New York City on the 16th of June 1836. He graduated at West Point in 1860, and was assigned to the cavalry service. He served in Utah (1861) and in the defences of Washington (1861-62); learnt the field duties of his arm as aide (1862) to General Philip St George Cooke, who then commanded the cavalry of the Army of the Potomac; became brigadier-general, United States Volunteers, in June 1863; and in September 1863 was placed in command of a brigade of regular cavalry in the Army of the Potomac. He won great distinction in the Virginia campaigns of 1864-65 and in Sheridan's Valley campaign, being brevetted major-general of volunteers for his conduct at Winchester and Fisher's Hill, and brigadier-general of the regular army for his services at Five Forks. In the final campaign about Richmond he did such good service in command of a cavalry division that he was brevetted major-general in the regular army and was promoted major-general of volunteers. With two other Federal commissioners he arranged with the Confederate commanders for the surrender of the Army of Northern Virginia. He was mustered out of the Volunteer Service in February 1866, and in July became lieutenant-colonel of the 9th cavalry in the regular army, being promoted gradually to major-general (1895). He served in the Big Horn and Yellowstone Indian campaigns (1876) and in the expedition to relieve the command of Major Thornburgh, who was killed in 1879 by the Utes; was superintendent at West Point (1882-87); and commanded the military department of Missouri in 1887-95, and that of the Atlantic in 1897-98. He was assigned in May 1898 to the command of the United States forces that were sent to the Philippines, after Admiral Dewey's victory; stormed Manila on the 13th of August; and was military governor of the islands until the 30th of August, when he left Manila for Paris to join the peace commission. From 1899 until his retirement from active service in June 1900 he commanded the Department of the East.

MERSEBURG, a town of Germany, in the Prussian province of Saxony, on the river Saale, 10 m. by rail S. of Halle and 15 m. W. of Leipzig. Pop. (1905), 20,024. It consists of a quaint and irregularly built old town, a new quarter, and two extensive suburbs, Altenburg and Neumarkt. The cathedral, which was restored in 1884-1886, has a choir, a crypt and two towers of the 11th, a transept of the 13th and a late Gothic nave of the 16th century. Among its numerous monuments is one to Rudolph of Swabia, the rival of the emperor Henry IV. It contains

a great organ dating from the 17th century. Near the cathedral is the Gothic palace, formerly the residence of the bishops of Merseburg, and now used as public offices. The town hall and the Ständehaus, where the meetings of the provincial estates were held, are also noteworthy buildings. The industries include the manufacture of machinery, paper and celluloid, and tanning and brewing.

Merseburg is one of the oldest towns in Germany. From 968 until the Reformation, it was the seat of a bishop, and in addition to being for a time the residence of the margraves of Meissen, it was a favourite residence of the German kings during the 10th, 11th and 12th centuries. Fifteen diets were held here during the middle ages, when its fairs enjoyed the importance which was afterwards transferred to those of Leipzig. The town suffered severely during the Peasants' War and also during the Thirty Years' War. From 1657 to 1738 it was the residence of the dukes of Saxe-Merseburg.

See E. Hoffmann, *Historische Nachrichten aus Alt-Merseburg* (Mersburg, 1903).

MERSEN (MEERSEN), TREATY OF, a treaty concluded on the 8th of August 870 at Mersen, in Holland, between Charles the Bald and his half-brother, Louis the German, by which the kingdom of their nephew Lothair II. (d. 869) was divided between them. Charles received a portion of the kingdom of Lothair afterwards called Lorraine, extending from the mouths of the Rhine to Toul, together with the town of Besançon, the Lyonnais, the Viennais, the Vivarais, and the Uzège, *i.e.* the lands acquired by Lothair II. in 863 at the death of his brother Charles of Provence; while Louis had the cities of Cologne, Trier and Metz, together with Alsace, the Escuens, and the Varais, *i.e.* the greater part of the diocese of Besançon. The boundary between the two realms was marked approximately by the valleys of the Meuse and Moselle and by the Jura. Great importance has been attached to the determination of this frontier by some historians, who consider that it coincided with the dividing line between the Teutonic and Romance races and languages; but nothing is known of the bases upon which the negotiations were effected, and the situation created by this treaty came to an end in 879.

MERSENNE, MARIN (1588-1648), French philosopher and mathematician, was born of peasant parents near Oizé (Sarthe) on the 8th of September 1588, and died in Paris on the 1st of September 1648. He was educated at the Jesuit College of La Flèche, where he was a fellow-pupil and friend of Descartes. In 1611 he joined the Minim Friars, and devoted himself to philosophic teaching in various convent schools. He settled eventually in Paris in 1620 at the convent of L'Annonciade. For the next four years he devoted himself entirely to philosophic and theological writing, and published *Quæstiones celeberrimæ in Genesim* (1623); *L'Impiété des déistes* (1624); *La Vérité des sciences* (1624). These works are characterized by wide scholarship and the narrowest theological orthodoxy. His greatest service to philosophy was his enthusiastic defence of Descartes, whose agent he was in Paris and whom he visited in exile in Holland. He submitted to various eminent Parisian thinkers a manuscript copy of the *Méditations*, and defended its orthodoxy against numerous clerical critics. In later life, he gave up speculative thought and turned to scientific research, especially in mathematics, physics and astronomy. Of his works in this connexion the best known is *L'Harmonie universelle* (1636), dealing with the theory of music and musical instruments.

Among his other works are: *Euclidis elementorum libri*, &c. (Paris, 1626); *Universæ geometriæ synopsis* (1644); *Les Mécaniques de Galilée* (Paris, 1634); *Questions inouïes ou récréations des savants* (1634); *Questions théologiques, physiques, &c.* (1634); *Nouvelles découvertes de Galilée* (1639); *Cogitata physico-mathematica* (1644). See Baillet, *Vie de Descartes* (1691); Poté, *Éloge de Mersenne* (1816).

MERSEY, a river in the north-west of England. It is formed by the junction of the Goyt and the Etherow a short distance below Marple in Cheshire on the first-named stream. The Goyt rises in the neighbourhood of Axe Edge, south-west of Buxton, and the Etherow in the uplands between Penistone

and Glossop, watering the narrow Longendale in which are several reservoirs for the Manchester water supply. The Mersey thus drains a large part of the Peak district of Derbyshire and of the southern portion of the Pennine system. The general direction from Marple is westerly. At Stockport the river Tame joins from the north, rising in the moors to the north-east of Oldham, and the Mersey soon afterwards debouches upon the low plain to the west of Manchester, which lies on its northern tributary the Irwell. The Bollin joins from the south-east near Heatley, and the main river, passing Warrington, begins to expand into an estuary before reaching Runcorn and Widnes, which face each other across it. The estuary, widening suddenly at the junction of the Weaver from the south-east, 2½ m. below Runcorn, is 3 m. wide off Ellesmere Port, but narrows to less than ¼ m. at Liverpool, and hardly exceeds a mile at the mouth in the Irish Sea. The fall of the Mersey is about 1600 ft. in all and about 300 from Marple; its length, including the Goyt, is 70 m. exclusive of lesser windings, and it drains an area of 1596 sq. m. The estuary is one of the most important commercial waterways in the world. (See LIVERPOOL and BIRKENHEAD.) The Manchester Ship Canal (*q.v.*) joins the estuary through Eastham Locks, skirts its southern shore up to Runcorn, and crosses the river several times. From the name of the river was taken the title of Lord Mersey in 1910 by Sir John Bigham (b. 1840), on his elevation to the peerage after serving as a judge of the high court from 1897 to 1909 and president of the divorce court 1909-1910.

MERSINA, a town on the south-eastern coast of Asia Minor, and capital of a sanjak in the vilayet of Adana. Pop. about 15,000 including many Christians, Armenian, Greek and European. Its existence as a port began with the silting up of the harbour of Tarsus and Pompeiopolis, east and west, in the early middle ages; but it did not rise to importance till the Egyptian occupation of Cilicia (1832). It is now the busiest port on the south coast, being the terminus of the railway from Tarsus and Adana, by which (but still more by road) the produce of the rich "Aleian" plain comes down. It is served by most of the Levantine steamship companies, and is the best point of departure for visitors desiring to see Tarsus, the Cilician remains, and the finest scenery of the East Taurus. There is, however, no enclosed harbour, but only a good jetty. The making of a breakwater has long been under consideration. The anchorage in the roadstead is good, but the bay shoals for a long way out, and is exposed to swell from south-west and south. Mersina is an American mission centre, and the seat of a British vice-consul. Like all lowland Cilicia, it has a notoriously bad summer climate, and all inhabitants, who can do so, migrate to stations on the lower slopes of Taurus.

(D. G. H.)

MERTHYR TYDFIL, or MERTHYR TYDVIL, a municipal, county and parliamentary borough, and market-town of Glamorganshire, south Wales, situated in a bleak and hilly region on the river Taff, on the Glamorganshire Canal, and the Brecon and Merthyr, Great Western, North Western, Taff Vale and Rhymney railways, 25 m. N.N.W. of Cardiff, 30 E.N.E. of Swansea, and 176 from London. Pop. (1901), 69,228. The town is said to have derived its name from the martyrdom of St Tydfil, daughter of Brychan, who was put to death by Saxons in the 5th century. It is for the most part irregularly built and was formerly subject to severe epidemics due to defective sanitation; but it now possesses a supply of the purest water from the lesser Taff on the southern slope of the Breconshire Beacons. The town owes its early industrial prosperity to the abundant ironstone and coal of the district, and it thus became at an early date the chief seat of the iron industry in Wales. Four great ironworks were established here between 1759 and 1782. With the earliest, that of Dowlais, the Guest family were associated, first as partners and later as sole owners from 1782 to 1901 when the works were disposed to the company of Guest, Keen and Nettelfield. In 1765, Cyfarthfa was started by Anthony Bacon, and when firmly established, sold in 1794 to Richard Crawshaw by whose descendants the works were

carried on till the owners formed themselves in 1890 into a limited company (Crawshaw Brothers Cyfarthfa Limited), the controlling interest in which has since been acquired by the Dowlais Company. The Plymouth works, started soon after Cyfarthfa, by Wilkinson and Guest, passed later into the hands of Anthony Hill from whose descendants they were purchased in 1863. They were closed down in 1882, but the collieries belonging to them continue to be worked on a large scale, yielding over 2000 tons of coal a day. The fourth great ironworks were those of Pen-y-darran which were carried on from 1782 to 1859. It was at Dowlais (in 1856) that Bessemer steel was first rolled into rails, but the use of puddled iron was not wholly abandoned at the works till 1882. It has now eighteen blast furnaces, and extensive collieries are also worked by the company, and large branch works were opened on the sea-board at Cardiff in 1891. Cyfarthfa was converted into steel works in 1883. The iron ore used is mainly imported from Spain. Merthyr Vale is almost entirely dependent on coal-mining and has one of the largest collieries in south Wales (Nixon's Navigation). The population of this district more than quintupled between 1881 and 1901.

From 1850 the government of the town was vested in a local board of health which in 1894 became an urban district council; by charter granted on the 5th of June 1905, it was vested in a corporation consisting of a mayor, 8 aldermen and 24 councillors. It was made a county borough from the 1st of April 1908. It comprises about 17,750 acres, is divided into eight wards and besides the older town, it includes Penydarran (1 m. N.E.), Dowlais (2 m. N.E.), Plymouth (1 m. S.) and Merthyr Vale (5 m. S.). It has a separate commission of the peace, and in conjunction with Aberdare and Mountain Ash, has had a stipendiary magistrate since 1829. The parliamentary borough which was created and given one member in 1832 and a second in 1867, includes the parish of Aberdare and parts of the parishes of Llanwanno, Merthyr Tydfil and Vainor (Brecon).

There is an electric tramway (completed in 1901) from the town to Cefn and Dowlais. In 1901 about 50% of the population above three years of age spoke both Welsh and English, 71% spoke Welsh only, and the remainder English only. The ancient parish of Merthyr Tydfil has been divided into five ecclesiastical parishes (Merthyr, Cyfarthfa, Dowlais, Pentrebach, and Penydarran) and part of another parish (Treharris). These six parishes form the rural deanery of Merthyr in the archdeaconry and diocese of Llandaff, and in 1906 had nine churches and fifteen mission rooms. An inscribed stone (Artbeu) has been built into the east wall of the parish church; and two other inscribed stones removed from Abercar Farm in the greater Taff valley now lie in the parish churchyard. The old structure of the parish church has been entirely removed except the base of the tower. There is a Roman Catholic church in Penydarran Park and another at Dowlais. The Nonconformists, of which the chief denominations are the Baptists, Congregationalists and Methodists—Wesleyan and Calvinistic—had in 1906 82 chapels, 49 of which were used for Welsh services and 33 for English.

The public buildings include, besides the churches, a town hall and law courts (1898), drill hall (1866), library, market house, a county intermediate school, general hospital built in 1887 and enlarged in 1897, and an isolation fever hospital, a theatre (1894) and a fountain presented by Sir W. T. Lewis as a memorial to the pioneers of the town's industry. At Dowlais there are public baths (1900) and a free library which have been provided by the owners of the Dowlais Works, Oddfellows' hall (1878), and a fever hospital (1860). At Thomas Town there is a recreation ground of 16 acres, formed in 1902. In 1908 the corporation purchased Cyfarthfa Castle (formerly the residence of the Crawshaw family) with a park of 62 acres including a lake of 6 acres.

The Roman road from Cardiff and Gelligaer to Brecon passed through Merthyr and the remains of a supposed fort were discovered in Penydarran park in 1902. Three miles to the north of Merthyr, on a limestone rock about 470 ft. above the lesser (eastern) Taff are the ruins of Morlais Castle, built about 1286 by Gilbert de Clare

on the northern limits of his lordship of Glamorgan, its erection causing a serious feud between him and de Bohun, earl of Hereford, who claimed its site as part of the lordship of Brecknock.

(D. LL. T.)

MERULA, GEORGIUS (the Latinized name of **GIORGIO MIRLANI**; c. 1430-1404), Italian humanist and classical scholar, was born at Alessandria in Piedmont. The greater part of his life was spent at Venice and Milan, where he held a professorship and continued to teach until his death. To Merula we are indebted for the editio princeps of Plautus (1472), of the *Scriptores rei rustice*, Cato, Varro, Columella, Palladius (1472) and possibly of Martial (1471). He also published commentaries on portions of Cicero (especially the *De finibus*), on Ausonius, Juvenal, Curtius Rufus, and other classical authors. He wrote also *Bellum scodrense* (1474), on account of the siege of Scodra (Scutari) by the Turks, and *Antiquitates viccomitum*, the history of the Visconti, dukes of Milan, down to the death of Matteo the Great (1322). He violently attacked Politian (Poliziano), whose *Miscellanea* (a collection of notes on classical authors) were declared by Merula to be either plagiarized from his own writings or, when original, to be entirely incorrect.

See bibliography by F. Gabotto and Badini-Gonfalonieri (1894) with bibliography; for the quarrel with Politian see also C. Meiners *Lebensbeschreibungen der berühmten Männer* (1796), ii. 158.

MERV, MERU or **MAVR**, an oasis and town of Asia, in the Transcaspian province of Russia. The oasis is situated on the S. edge of the Kara-kum desert, in 37° 30' N. and 62° E. It is about 230 m. N. from Herat, and 280 S.S.E. from Khiva. Its area is about 1900 sq. m. The great chain of mountains which, under the names of Paropamisus and Hindu-Kush, extends from the Caspian to the Pamirs is interrupted some 180 m. south of Merv. Through or near this gap flow northwards in parallel courses the rivers Heri-rud (Tejend) and Murghab, until they lose themselves in the desert of Kara-kum. Thus they make Merv a sort of watch tower over the entrance into Afghanistan on the north-west and at the same time create a stepping-stone or *étape* between north-east Persia and the states of Bokhara and Samarkand. The present inhabitants of the oasis are Turkomans of the Tekke tribe. In 1897 they numbered approximately 240,000. The oasis is irrigated by an elaborate system of canals cut from the Murghab. The country has at all times been renowned throughout the East for its fertility. Every kind of cereal and many fruits grow in great abundance, e.g. wheat, millet, barley and melons, also rice and cotton. Silkworms are bred. The Turkomans possess a famous breed of horses and keep camels, sheep, cattle, asses and mules. They are excellent workers in silver and noted as armourers, and their carpets are superior to the Persian. They also make felts and a rough cloth of sheep's wool. The heat of summer is most oppressive. The least wind raises clouds of fine dust, which fill the air, render it so opaque as to obscure the noonday sun, and make respiration difficult. In winter the climate is very fine. Snow falls rarely, and when it does, it melts at once. The annual rainfall rarely exceeds 5 in., and there is often no rain from June till October. While in summer the thermometer goes up to 97° F., in winter it descends to 10.5°. The average yearly temperature is 60°. Here is a Russian imperial domain of 436 sq. m., artificially irrigated by works completed in 1895.

History.—In Hindu (the *Puranas*), Parsi and Arab tradition, Merv is looked upon as the ancient Paradise, the cradle of the Aryan families of mankind, and so of the human race. Under the name of Mouru this place is mentioned with Bakhdi (Balkh) in the geography of the *Zend-Avesta* (*Vendidad*, ed. Spiegel, 1852-1863), which dates probably from at least 1200 B.C. Under the name of Margu it occurs in the cuneiform (Behistun) inscriptions of the Persian monarch Darius Hystaspis, where it is referred to as forming part of one of the satrapies of the ancient Persian Empire. It afterwards became a province (Margiana) of the Graeco-Syrian, Parthian and Persian kingdoms. On the Margus—the Eparodus of Arrian and now the Murghab—stood the capital of the district, Antiochia Margiana, so called after Antiochus Soter, who rebuilt the city founded by Alexander the Great.

About the 5th century, during the rule of the Persian Sassanian dynasty, Merv was the seat of a Christian archbishopric of the Nestorian Church. The town was occupied (A.D. 646) by the lieutenants of the caliph Othman, and was constituted the capital of Khorasana. From this city as their base the Arabs, under Kotaiba (Qotaiba) ibn Moslim, early in the 8th century brought under subjection Balkh, Bokhara, Ferghana and Kashgaria, and penetrated into China as far as the province of Kan-suh. In the latter part of the 8th century Merv became obnoxious to Islam as the centre of heretical propaganda preached by Mokanna (q.v.). In 874 Arab rule in Central Asia came to an end. During their dominion Merv, like Samarkand and Bokhara, was one of the great schools of learning, and the celebrated historian Yaqut studied in its libraries. In 1040 the Seljuk Turks crossed the Oxus from the north, and having defeated Masud, sultan of Ghazni, raised Toghrul Beg, grandson of Seljuk, to the throne of Persia, founding the Seljukian dynasty, with its capital at Nishapur. A younger brother of Toghrul, Daud, took possession of Merv and Herat. Toghrul was succeeded by his nephew Alp Arslan (the Great Lion), who was buried at Merv. It was about this time that Merv reached the zenith of her glory. During the reign of Sultan Sanjar or Sinjar of the same house, in the middle of the 11th century, Merv was overrun by the Turkish tribes of the Ghuzz from beyond the Oxus. It eventually passed under the sway of the rulers of Khwarizm (Khiva).

In 1221 Merv opened its gates to Tule, son of Jenghiz Khan, chief of the Mongols, on which occasion most of the inhabitants are said to have been butchered. From this time forward the city began to decay. In the early part of the 14th century the town was made the seat of a Christian archbishopric of the Eastern Church. On the death of the grandson of Jenghiz Khan Merv was included (1380) in the possessions of Timur-i-Leng (Tamerlane), Mongol prince of Samarkand. In 1505 the city was occupied by the Uzbegs, who five years later were expelled by Ismail Khan, the founder of the Safawid dynasty of Persia. Merv remained in the hands of Persia until 1787, when it was captured by the emir of Bokhara. Seven years later the Bokharians razed the city to the ground, broke down the dams, and converted the district into a waste. When Sir Alexander Burnes traversed the country in 1832, the Khivans were the rulers of Merv. About this time the Tekke Turkomans, then living on the Heri-rud, were forced by the Persians to migrate northward. The Khivans contested the advance of the Tekkes, but ultimately, about 1856, the latter became the sovereign power in the country, and remained so until the Russians occupied the oasis in 1883.

The ruins of Old Merv cover an area of over 15 sq. m. They consist of a square citadel (Bairam Ali Khan *kalah*), 1½ m. in circuit, built by a son of Tamerlane and destroyed by the Bokharians, and another *kalah* or walled inclosure known as Abdullah Khan. North from these lies the old capital of the Seljuks, known as Sultan Kalah, and destroyed by the Mongols in 1219. Its most conspicuous feature is the burial mosque of Sultan Sanjar, reputedly dating from the 12th century. East of the old Seljuk capital is Gaur Kalah, the Merv of the Nestorian era and the capital of the Arab princes. North of the old Seljuk capital are the ruins of Iskender Kalah, probably to be identified with the ancient Merv of the Seleucid dynasty.

NEW MERV, the present chief town of the oasis, founded in the first quarter of the 19th century, is on the Transcaspian railway, 380 m. by rail south-west from Samarkand. It stands on both banks of the Murghab, 820 ft. above the Caspian. Pop. (1897), 8727, including Russians, Armenians, Turkomans, Persians and Jews. It has a meteorological observatory. Corn, raw cotton, hides, wool, nuts and dried fruit are exported.

See E. O'Donovan, *The Merv Oasis* (2 vols., London, 1882); C. Marvin, *Merv* (London, 1880); and H. Lansdell, *The Russians at Merv and Herat* (London, 1883). (J. T. BE.)

MERX, ADALBERT (1838-1909), German theologian and orientalist, was born at Bleicherode near Nordhausen on the 2nd of November 1838. He studied at Jena, where he became extraordinary professor in 1869. Subsequently he was ordinary

professor of philosophy at Tübingen, and in 1873 professor of theology at Giessen. From 1875 till his death he was professor of theology of Heidelberg. In the course of his researches he made several journeys in the East. Among his many works are: *Grammatica syriaca* (1867-1870); *Vocabulary of the Tigre language* (1868); *Das Gedicht vom Hiob* (1871); *Die Prophetie des Joel und ihre Ausleger* (1879); *Die Saadjanische Uebersetzung der Hohenlieder aus Arabische* (1882); *Christomathia targumica* (1888); *Historia artis grammaticae apud Syros* (1889); *Ein samaritanisches Fragment* (1893); *Idee und Grundlinien einer allgemeiner Geschichte der Mystik* (1893). Merx devoted much of his later research to the elucidation of the Sinaitic palimpsest discovered in 1892 by Mrs Agnes Smith Lewis (see BIBLE, iv. 321, ad fin.), the results being embodied in *Die vier kanonischen Evangelien nach ihrem ältesten bekannten Texte* (1897-1905). His last work was an edition of the books of Moses and Joshua. He died at Heidelberg on the 6th of August 1909.

MÉRYON, CHARLES (1821-1868), French etcher, was born in Paris in 1821. His father was an English physician, his mother a French dancer. It was to his mother's care that Méryon's childhood was confided. But she died when he was still young, and Méryon entered the French navy, and in the corvette "Le Rhin" made the voyage round the world. He was already a draughtsman, for on the coast of New Zealand he made pencil drawings which he was able to employ, years afterwards, as studies for etchings of the landscape of those regions. The artistic instinct developed, and, while he was yet a lieutenant, Méryon left the navy. Finding that he was colour-blind, he determined to devote himself to etching. He entered the work room of one Bléry, from whom he learnt something of technical matters, and to whom he always remained grateful. Méryon was by this time poor. It is understood that he might have had assistance from his kindred, but he was too proud to ask it. And thus he was reduced to the need of executing for the sake of daily bread much work that was mechanical and irksome. Among learners' work, done for his own advantage, are to be counted some studies after the Dutch etchers such as Zeeman and Adrian van de Velde. Having proved himself a surprising copyist, he proceeded to labour of his own, and began that series of etchings which are the greatest embodiments of his greatest conceptions—the series called "Eaux-fortes sur Paris." These plates, executed from 1850 to 1854, are never to be met with as a set; they were never expressly published as a set. But they none the less constituted in Méryon's mind an harmonious series.

Besides the twenty-two etchings "sur Paris," characterized below, Méryon did seventy-two etchings of one sort and another—ninety-four in all being catalogued in Wedmore's *Méryon and Méryon's Paris*; but these include the works of his apprenticeship and of his decline, adroit copies in which his best success was in the sinking of his own individuality, and more or less dull portraits. Yet among the seventy-two prints outside his professed series there are at least a dozen that will add his fame. Three or four beautiful etchings of Paris do not belong to the series at all. Two or three etchings, again, are devoted to the illustration of Bourges, a city in which the old wooden houses were as attractive to him for their own sakes as was the stone-built monuments of Paris. But generally it was when Paris engaged him that he succeeded the most. He would have done more work, however—though he could hardly have done better work—if the material difficulties of his life had not pressed upon him and shortened his days. He was a bachelor, unhappy in love, and yet, it is related, almost as constantly occupied with love as with work. The depth of his imagination and the surprising mastery which he achieved almost from the beginning in the technicalities of his craft were appreciated only by a few artists, critics and connoisseurs, and he could not sell his etchings, or could sell them only for about rod. apiece. Disappointment told upon him, and, frugal as was his way of life, poverty must have affected him. He became subject to hallucinations. Enemies, he said, waited for him at the corners of the streets; his few friends robbed him or owed him that which they would

never pay. A few years after the completion of his Paris series he was lodged in the madhouse of Charenton. Its order and care restored him for a while to health, and he came out and did a little more work, but at bottom he was exhausted. In 1867 he returned to his asylum, and died there in 1868. In the middle years of his life, just before he was placed under confinement, he was much associated with Bracquemond and with Flameng,—skilled practitioners of etching, while he was himself an undeniable genius—and the best of the portraits we have of him is that one by Bracquemond under which the sitter wrote that it represented "the sombre Méryon with the grotesque visage."

There are twenty-two pieces in the Eaux-fortes sur Paris. Some of them are insignificant. That is because ten out of the twenty-two were destined as headpiece, tailpiece, or running commentary on some more important plate. But each has its value, and certain of the smaller pieces throw great light on the aim of the entire set. Thus, one little plate—not a picture at all—is devoted to the record of verses made by Méryon, the purpose of which is to lament the life of Paris. The misery and poverty of the town Méryon had to illustrate, as well as its splendour. The art of Méryon is completely misconceived when his etchings are spoken of as views of Paris. They are often "views," but they are so just so far as is compatible with their being likewise the visions of a poet and the compositions of an artist. It was an epic of Paris that Méryon determined to make, coloured strongly by his personal sentiment, and affected here and there by the occurrences of the moment—in more than one case, for instance, he hurried with particular affection to etch his impression of some old-world building which was on the point of destruction. Nearly every etching in the series is an instance of technical skill, but even the technical skill is exercised most happily in those etchings which have the advantage of impressive subjects, and which the collector willingly cherishes for their mysterious suggestiveness or for their pure beauty. Of these, the Abside de Notre Dame is the general favourite; it is commonly held to be Méryon's masterpiece. Light and shade play wonderfully over the great fabric of the church, seen over the spaces of the river. As a draughtsman of architecture, Méryon was complete; his sympathy with its various styles was broad, and his work on its various styles unbiased and of equal perfection—a point in which it is curious to contrast him with Turner, who, in drawing Gothic, often drew it with want of appreciation. It is evident that architecture must enter largely into any representation of a city, however much such representation may be a vision, and however little a chronicle. Besides, the architectural portion even of Méryon's labour is but indirectly imaginative; to the imagination he has given freer play in his dealings with the figure, whether the people of the street or of the river or the people who, when he is most frankly or even wildly symbolical, crowd the sky. Generally speaking, his figures are, as regards draughtsmanship, "landscape-painter's figures." They are drawn more with an eye to grace than to academic correctness. But they are not "landscape-painter's figures" at all when what we are concerned with is not the method of their representation but the purpose of their introduction. They are seen then to be in exceptional accord with the sentiment of the scene. Sometimes, as in the case of *La Morgue*, it is they who tell the story of the picture. Sometimes, as in the case of *La Rue des Mauvais Garçons*—with the two passing women bent together in secret converse—they at least suggest it. And sometimes, as in *L'Arche du Pont Notre Dame*, it is their expressive gesture and eager action that give vitality and animation to the scene. Dealing perfectly with architecture, and perfectly, as far as concerned his peculiar purpose, with humanity in his art, Méryon was little called upon by the character of his subjects to deal with Nature. He drew trees but badly, never representing foliage happily, either in detail or in mass. But to render the characteristics of the city, it was necessary that he should know how to portray a certain kind of water—river-water, mostly sluggish—and a certain kind of sky—the grey obscured and lower sky that broods over a world of roof and chimney.

This water and this sky Méryon is thoroughly master of; he notes with observant affection their changes in all lights.

Méryon's excellent draughtsmanship, and his keen appreciation of light, shade and tone, were, of course, helps to his becoming a great etcher. But a living authority, himself an eminent etcher, and admiring Méryon thoroughly, has called Méryon by preference a great original engraver—so little of Méryon's work accords with Sir Seymour Haden's view of etching. Méryon was anything but a brilliant sketcher; and, if an artist's success in etching is to be gauged chiefly by the rapidity with which he records an impression, Méryon's success was not great. There can be no doubt that his work was laborious and deliberate, instead of swift and impulsive, and that of some other virtues of the etcher—"selection" and "abstraction" as Hamerton has defined them—he shows small trace. But a genius like Méryon is a law unto himself, or rather in his practice of his art he makes the laws by which that art and he are to be judged.

It is worth while to note the extraordinary enhancement in the value of Méryon's prints. Probably of no other artist of genius, not even of Whistler, could there be cited within the same period a rise in prices of all the same proportion. Thus the first state of the "Struge"—that "with the verses,"—selling under the hammer in 1873 for £5, sold again under the hammer in 1905 for £100. The first state of the "Galerie de Notre Dame," selling in 1873 for £5, and at M. Wasset's sale in 1880 for £11, fetched in 1905, £52. A "Tour de l'horloge," which two or three years after it was first issued sold for half a crown, in May 1903 fetched £70. A first state (Wedmore's, not of course M. Deltel's "first state," which, like nearly all his first states, is in fact a trial proof) of the "Saint Etienne du mont," realizing about £2 at M. Burty's sale in 1876, realized £60 at a sale in May 1906. The second state of the "Morgue" (Wedmore) sold in 1905 for £65; and Wedmore's second of the "Abside," which used to sell throughout the seventies for £4 or £5, reached in November 1906 more than £200. At no period have even Dürer's or Rembrandt's risen so swiftly and steadily.

BIBLIOGRAPHY.—Philippe Burty, *Gazette des beaux arts* (1865); *Descriptive Catalogue of the Works of Méryon* (London, 1879); Aglaüs Bouvenne, *Notes et souvenirs sur Charles Méryon*; P. G. Hamerton, *Etching and Etchers* (1868); F. Seymour Haden, *Notes on Etching*; H. Béraldi, *Les Peintres graveurs du dix-neuvième siècle*; Baudelaire, *Lettres de Baudelaire* (1907); L. Deltel, *Charles Méryon* (1907); Frederick Wedmore, *Méryon and Méryon's Paris*, with a descriptive catalogue of the artist's work (1879; 2nd ed., 1892); and *Fine Prints* (1896; 2nd ed., 1905). (F. W.)

MESA (Span. *mesa*, from Lat. *mensa*, a table), in physical geography, a high table-land capped with hard rock, being the remnant of a former plateau. This type is general where strata are horizontal. In the process of denudation the hard rock acts as a flat protective cap preserving the regions between stream valleys or other places where denudation is especially active, in the form of "table-mountains" or "fortress-hills." Many examples are found in Spain, North and South Africa, the Bad Lands and Colorado regions of North America, in Arabia, India and Australia.

MESHCHERYAKS, or MESHCHERS, a people inhabiting eastern Russia. Nestor regarded them as Finns, and even now part of the Mordvinians (of Finnish origin) call themselves Meshchers. Klapproth, on the other hand, supposed they were a mixture of Finns and Turks, and the Hungarian traveller Reguli discovered that the tatarized Meshchers of the Obi closely resembled Hungarians. They formerly occupied the basin of the Oka (where the town Meshchersk, now Meshchovsk, has maintained their name) and of the Sura, extending north-east to the Volga. After the conquest of the Kazan Empire by Russia, part of them migrated north-eastwards to the basins of the Kama and Byelaya, and thus the Meshchers divided into two branches. The western branch became russified, so that the Meshcheryaks of the governments of Penza, Saratov, Ryazan and Vladimir have adopted the customs, language and religion of the conquering race; but their ethnographical characteristics can be easily distinguished in the Russian population of the governments of Penza and Tambov. The eastern branch has taken on the customs, language and religion of Bashkirs, with whom their fusion is still more complete.

MESHED (properly *Mash-had*, "the place of martyrdom"), capital of the province of Khorasan in Persia, situated in a plain watered by the Kashaf-rud (Tortoise river), a tributary of the

Hari-rud (river from Herat, which after its junction with the Kashaf is called Tejen), 460 m. E. of Teheran (550 by road) and 200 m. N.W. of Herat, in 36° 17' N., 59° 36' E., at an elevation of 3800 ft. Its population is about 70,000 fixed and 10,000 floating, the latter consisting of pilgrims to the shrine of Imam Reza.¹

The town is of irregular shape, about 6 m. in circumference and surrounded by a mud wall flanked with towers. In the south-western corner of the enclosure stands the citadel (ark), within a wall 25 ft. high and a broad dry ditch which is 40 ft. deep in parts and can be flooded from neighbouring water-courses. The city has five gates, and from one of them, called Bala Khiaban gate (upper Khiaban), the main street (Khiaban), 25 yds. broad, runs in a north-west-south-east direction, forming a fine avenue planted with plane and mulberry trees and with a stream of water running down its middle. The shrine of Imam Reza is the most venerated spot in Persia, and yearly visited by more than 100,000 pilgrims. Eastwick thus describes it (*Journal of a Diplomat's Three Years' Residence in Persia*, London, 1864):—

"The quadrangle of the shrine seemed to be about 150 paces square. It was paved with large flagstones and in the centre was a beautiful kiosk or pavilion, covered with gold and raised over the reservoir of water for ablutions. This pavilion was built by Nadir Shah. All round the northern, western and southern sides of the quadrangle ran, a distance of 10 ft. from the ground, a row of alcoves similar to that in which I was sitting, and filled with mullas in white turbans and dresses. In each of the sides was a gigantic archway, the wall being raised in a square from above the entrance. The height to the top of this square wall must have been 90 or 100 ft. The alcoves were white, seemingly of stone or plaster; but the archways were covered with blue varnish or blue tiles, with beautiful inscriptions in white and gold. Over the western archway was a white cage for the muazzin, and outside it was a gigantic minaret 120 ft. high, and as thick as the Duke of York's column in London. The beauty of this minaret cannot be exaggerated. It had an exquisitely carved capital, and above that a light pillar, seemingly 10 ft. high; and this and the shaft below the capital, or about 20 ft., were covered with gold. All this part of the mosque (shrine) was built by Shah Abbas. In the centre of the eastern side of the quadrangle two gigantic doors were thrown open to admit the people into the adytum or inner mosque (shrine) where is the marble tomb of Imam Reza, surrounded by a silver railing with knobs of gold. There was a flight of steps ascending to these doors, and beyond were two smaller doors encrusted with jewels—the rubies were particularly fine. The inner mosque would contain 3000 persons. Over it rose a dome entirely covered with gold, with two minarets at the sides, likewise gilt all over. On the right of the Imam's tomb is that of Abbas Mirza, grandfather of the reigning Shah.² Near him several other princes and chiefs of note are buried. Beyond the golden dome, in striking and beautiful contrast with it, was a smaller dome of bright blue. Here begins the mosque of Gauhar Shád.³ The quadrangle is larger than that of Shah Abbas; and at the eastern side is an immense blue dome, out of which quantities of grass were growing, the place being too sacred to be disturbed. In front of the dome rose two lofty minarets covered with blue tiles. In the boulevard of the Bala Khiaban is a kitchen supported by the revenues of the shrine, where 800 persons are fed daily."

The buildings of the shrine together with a space extending to about one hundred yards beyond the gates of the shrine on each side is sanctuary (*bast*). Within it are many shops and lodgings, and criminals, even murderers, may live there in safety. The only other notable buildings in the place are some colleges (*madresseh*), the oldest being the M. Do-dar, i.e. "college of two doors," built in 1439 by Shah Rukh, and some fine caravanserais, two dating from 1620.

¹Abul Hassan Ali, al Reza, commonly known as Imam Reza, the eighth imam of the Shiites, a son of Mūsā al Kāzīm, the seventh imam, was the leader from whom the party of the Alids (Shiites) had such hopes under the caliphate of Mamūn. Gold coins (dinars) of this caliph are extant on which al Reza's name appears with the title of heir-apparent. The imam died in March 819 in the village Sanabad near Tus, some miles north-west of Meshed. To the Shiites he is a martyr, being believed to have been poisoned by Mamūn.

²This refers to Nasr-ud-din (d. 1896), grandfather of Shah Mahmūd Ali (1907).

³Gauhar Shád was the wife of Shah Rukh (1404-1447), and was murdered by that monarch's successor Abu Said, August 1, 1457. Her mosque was built in 1418.

Without the pilgrims who come to visit it, Meshed would be a poor place, but lying on the eastern confines of Persia, close to Afghanistan, Russian Central Asia and Transcaspia, at the point where a number of trade routes converge, it is very important politically, and the British and Russian governments have maintained consulates-general there since 1889. Meshed had formerly a great transit trade to Central Asia, of European manufactures, mostly Manchester goods, which came by way of Trebizond, Tabriz and Teheran; and of Indian goods and produce, mostly muslins and Indian and green teas, which came by way of Bander Abbasi. With the opening of the Russian railway from the Caspian to Merv, Bokhara and Samarkand in 1886-1887, Russian manufacturers were enabled to compete in Central Asia with their western rivals, and the value of European manufactures passing Meshed in transit was much reduced. In 1894 the Russian government enforced new customs regulations, by which a heavy duty is levied on Anglo-Indian manufactures and produce, excepting pepper, ginger and drugs, imported into Russian Asia by way of Persia; and the importation of green teas is altogether prohibited except by way of Batum, Baku, Uzunada and the Transcaspian railway. Since then the transit trade has been practically nil. In 1890 General Maclean, the British consul-general, reported that there were 650 silk, 40 carpet and 320 shawl looms at work. The carpet-loom at work now number several hundreds, while looms of silk and shawl number less than half what they did in 1890.

Meshed has telegraph (since 1876) and post (since 1879) offices, and the Imperial Bank of Persia opened a branch here in 1891. The climate is temperate and healthy. The coldest month is January, with a mean temperature of about 32° F., while the hottest month is July, with a mean of 78°. The highest temperature recorded in a period of six years was 91°, the lowest 15°. The mean annual rainfall during nine years (1899-1907) was nearly 9½ in., about one-eighth of it being represented by snow. (A. H.-S.)

MESHREBIYA (drinking places), the Arabic term given to the projecting oriel windows in Cairo, enclosed with lattice-work, through which a good view of the street can be obtained by the occupants without being seen; the term was derived from the small semicircular bows, in which porous water-bottles are placed to cool by evaporation in the air.

MESMER, FRIEDRICH (or FRANZ) **ANTON** (1733-1815), Austrian doctor, from whose name the word "Mesmerism" was coined (see HYPNOTISM), was born at Weil, near the point at which the Rhine leaves the Lake of Constance, on the 23rd of May 1733. He studied medicine at Vienna under the eminent masters of that day, Van Swieten and De Haen, took a degree, and commenced practice. Interested in astrology, he imagined that the stars exerted an influence on beings living on the earth. He identified the supposed force first with electricity, and then with magnetism; and it was but a short step to suppose that stroking diseased bodies with magnets might effect a cure. He published his first work (*De planetarum influxibus*) in 1766. Ten years later, on meeting with J. J. Gassner in Switzerland, he observed that the priest effected cures by manipulation alone. This led Mesmer to discard the magnets, and to suppose that some kind of occult force resided in himself by which he could influence others. He held that this force permeated the universe, and more especially affected the nervous systems of men. He removed to Paris in 1778, and in a short time the French capital was thrown into a state of great excitement by the marvellous effects of mesmerism. Mesmer soon made many converts; controversies arose; he excited the indignation of the medical faculty of Paris, who stigmatized him as a charlatan; still the people crowded to him. He refused an offer of 20,000 francs from the government for the disclosure of his secret, but it is asserted that he really told all he knew privately to any one for 100 louis. He received private rewards of large sums of money. His consulting apartments were dimly lighted and hung with mirrors; strains of soft music occasionally broke the profound silence; and the patients sat round a kind of vat in which various chemical ingredients were concocted. Holding each others'

hands, or joined by cords, the patients sat in expectancy, and then Mesmer, clothed in the dress of a magician, glided amongst them, affecting this one by a touch, another by a look, and making "passes" with his hand towards a third. Nervous ladies became hysterical or fainted; some men became convulsed, or were seized with palpitations of the heart or other bodily disturbances. The government appointed a commission of physicians and members of the Academy of Sciences to investigate these phenomena; Franklin and Baillie were members of this commission, and drew up an elaborate report admitting many of the facts, but contesting Mesmer's theory that there was an agent called animal magnetism, and attributing the effects to physiological causes. Mesmer himself was undoubtedly a mystic; and, although the excitement of the time led him to indulge in mummery and sensational effects, he was honest in the belief that the phenomena produced were real, and called for further investigation. For a time, however, animal magnetism fell into disrepute; it became a system of downright jugglery, and Mesmer himself was denounced as a shallow empiric and impostor. He withdrew from Paris, and died at Meersburg in Switzerland on the 5th of March 1815. He left many disciples, the most distinguished of whom was the marquis de Puységur.

MESNAGER (or **LE MESAGNER**), **NICOLAS** (1658-1714), French diplomatist, belonged to a wealthy merchant family. He gave up a commercial career for the law, however, and became advocate before the parlement of Rouen. In 1700 he was sent as deputy of Rouen to the council of commerce which was established in Paris for the extension of French trade. Here he made his mark, and was chosen to go on three missions to Spain, between the years 1704 and 1705, to negotiate financial arrangements. In August 1711 he was sent on a secret mission to London to detach England from the alliance against France, and succeeded in securing the adoption of eight articles which formed the base of the later Treaty of Utrecht. As a reward for his skill he was made one of the three French plenipotentiaries sent to Utrecht in January 1712, and had the honour of signing the treaty the next year. As he had used much of his own large fortune to keep up his state as ambassador, he was granted a reward by the grateful king of France. His portrait by Hyacinthe Rigaud is in the gallery of Versailles.

MESNE (an Anglo-French legal form of the O. Fr. *meien*, mod. *moyen*, mean, Med. Lat. *medius*, in the middle, cf. "mean"), middle or intermediate, an adjective used in several legal phrases. A mesne lord is one who has tenants holding under him, while himself holding of a superior lord. Mesne process was such process as intervened between the beginning and end of a suit (see **PROCESS**). Mesne profits are profits derived from land whilst in wrongful possession, and may be claimed in damages for trespass either in a separate action or joined with an action for the recovery of the land. The plaintiff must prove that he has re-entered into possession, his title during the period for which he claims, the fact that the defendant has been in possession during that period, and the amount of the mesne profits. The amount recovered as mesne profits need not be limited to the rental value of the land, but may include a sum to cover such items as deterioration or reasonable costs of getting possession, &c.

MESOCEPHALIC, a term applied by anthropologists to those skulls which exhibit a cephalic index intermediate between the dolichocephalic and brachycephalic crania (see **CRANIOMETRY**). Taking the longer diameter of a skull, i.e. the one from front to back, as 100, mesocephalic skulls are those of which the transverse diameter varies between 75 to 80.

MESOMEDES of Crete, Greek lyric poet, who lived during the 2nd century A.D. He was a freedman of the emperor Hadrian, on whose favourite Antinous he is said to have written a panegyric. Two epigrams by him in the Greek anthology (*Anthol. pol.* xiv. 63, xvi. 323) and a hymn to Nemesis are extant. The hymn is of special interest as preserving the ancient musical notation written over the text. Two other hymns—to the muse Calliope and to the sun—formerly

assigned to Dionysius of Alexandria, have also been attributed to him.

See J. F. Bellermann, *Die Hymnen des Dionysius und Mesomedes* (1840); C. de Jan, *Musici scriptores graeci* (1899); S. Reinach in *Revue des études grecques*, ix. (1896); Suidas, s.v.

MESONERO ROMANOS, RAMÓN DE (1803-1882), Spanish prose-writer, was born at Madrid on the 19th of July 1803, and at an early age became interested in the history and topography of his native city. His *Manual de Madrid* (1831) was published when literature was at a low ebb in Spain; but the author's curious researches and direct style charmed the public, and next year, in a review entitled *Cartas españolas*, under the pseudonym of "El Curioso parlante," he began a series of articles on the social life of the capital which were subsequently collected and called *Panorama madrileño* (1835-1836). Mesonero Romanos was elected to the Spanish Academy in 1838 and, though he continued to write, had somewhat outlived his fame when he issued his pleasing autobiography, *Memorias de un seletán, natural y vecino de Madrid* (1886). He died at Madrid on the 30th of April 1882, shortly after the publication of his *Obras completas* (8 vols., 4to, 1881).

MESOPOTAMIA (*Mesonotamia*, sc. $\chi\lambda\alpha\sigma\alpha$ or $\Sigma\upsilon\phi\lambda\alpha$, from $\mu\epsilon\sigma\sigma$, middle, $\tau\omicron\rho\alpha\tau\omicron\varsigma$, river), one of the Greek renderings of the earlier Semitic names for the river-country that stretches eastward from northern maritime Syria. The earliest appearance of a Semitic name of this kind is in the last paragraph of the biography of Abhmöse of el-Käh, the aged officer of Tethmosis (Thtumose) I. As early therefore as the late 16th century B.C. the name Naharin (*N'h'ryrn'*) was in use. That the name was connected with *nahar* (a river) was plain to some of the Egyptian scribes, who wrote the word with determinative for "water" in addition to that for "country".

The scribes show no suspicion, however, of the name's being anything but a singular, it is possible that a consciousness that the word was not a plural can have survived till the early Christian centuries, when the Fargum of Onqelos (Onkelos) rendered *Naharaim* by "the river Euphrates" (Pethor of Aram which is on the Euphrates: Deut. xxiii. 4 [5]). The *Naharin* or *Nahoren* of the Egyptian texts appears five generations later in the Canaanitic of the Amarna letters in the form *Naḥrim(a)*, which would seem therefore to be the pronunciation then prevalent in Phoenicia (Gebal) and Palestine (Jerusalem). About the same time *Naharin* (*N'h'ryrn'*) is given as the northern boundary of Egypt's domain (year 30 of Amenhotep or Amenophis III.), over against Kush in the south (tomb of Khiamhet: Breasted, *Anc. Rec.* ii. 350).

The origin of the name is suggested by the Euphrates being called "the water of Naharin,"—on the Karnak stela more fully "the water of the Great Bend (*ph'wr*) of Naharin (*n-h-r-n*)" (Breasted, *Anc. Rec.* ii. 263), or on the Constantinople obelisk simply "the Great Bend of Naharin" (*loc. cit.* note d). The precise meaning of *ph'wr* is not certain. When Breasted renders "the Great Bend" of the Euphrates he is probably thinking of the great sweep round between Birejik-Zeugma and Rakka-Nicephorium. W. M. Müller, on the other hand, rendering *Kreislauf*, explains it of the Euphrates water system as a whole, thought of as encompassing Naharin. The Sea of the Great Bend would seem to be the sea fed by the north-to-south waters of Naharin, just as the Mediterranean, fed by the south-to-north waters of the Nile, is called the Great Circle (*ἄνω κύκλος*).

For many centuries after Amenophis IV. the name cannot be found. The next occurrence is in Hebrew (*Gen.* xxiv. 10-11), where the district from which a wife for Isaac is brought is called Aram-Naharaim. The diphthongal pronunciation of the termination *aim* is probably a much later development. We should probably read something like Aram-Naharim. The meaning is: the Naharin portion of the Aramaic speaking domain.² Probably the author thought primarily of the district of Harrān.³ Some generations later Aram-Naharim is used of a district including Pethor, a town on the west bank of the Euphrates⁴ (*Deut.* xxiii. 4).

¹ The threefold *n* after *Nahar* in a stela of Persian or Greek times (healing of a breast) is probably only a deterioration for "water," a fourth *n* being accidentally omitted (Breasted, *Ancient Records*, iii. § 434).

² Cf. Aram-Damascus, which means, the Damascus portion of the Aramaic domain; and *har-Ephraim*, which means, the Ephraim portion of the (Israelitish) highlands—EV "Mount Ephraim."

³ Halévy's suggestion that we are to look towards the Haurān, and think of the rivers of Damascus, has not met with favour.

⁴ Paddan-Aram (*Rev.* Vers. better Paddan-Aram), *Gen.* xxv. 20, &c., rendered by the Septuagint "Mesopotamia of Syria," is obscure. *Paddan* has been connected phonetically with *Paddan*, one of the Euphrates, and explained by others as a synonym for *Harran*.

4=D). The Syriac version of the Old Testament (2nd cent. A.D.?) uses *Beth Nahrin*. This may or may not imply the belief that *Nahrin* is a plural. Eventually that belief was general, as is proved by the substitution of the normal feminine plural (for the supposed masculine) in the alternative form *Beth Nahrawātha* (e.g. Wright, *Chron. Joshua Spyl.* §§ 49, 50). *Beth* is probably the Syriac equivalent of the Assyrian *Bit* as in *Bit-Adini* (see below, § 3 viii.), as is shown by such names as *Sūtā Arbāyē*, "the district of Arabians," *Bēt Arbāyē*, "the district of Aramaeans," "the *Paropotamia* of Strabo xvi. 2. 11, would be a suitable Greek equivalent. *Mesopotamia* seems to imply the view that *beth* is the preposition "amid," which has the same form,¹ but need not imply the meaning "between," that is, the idea that there were precisely two rivers. There is evidence of the use of this form as early as the Septuagint translation of the Pentateuch (3rd cent. B.C.). It is natural to suppose it was adopted by the Greeks who accompanied Alexander's expedition. Xenophon does not use it.

As early as the time of Ephraim (d. A.D. 373) the use of the Syriac *Gātrāthā*, "island" had come in, and over a century earlier Philostratus reported (*Life of Apollonius*, i. 20) that the Arabs designated *Mesopotamia* as an island.² This term in the form *al-Gātra* became, and still is, the usual Arabic name.

The absence of any equivalent names in Babylonian or Assyrian documents is noteworthy,³ especially as the Babylonians spoke of the "Sea-Country" (*māt Tāmim*). The name was not distinctive enough from the point of view of Babylonia, which belonged to the same water system. Tiglath-pileser I. (Octagon Prism, 6. 40-2) speaks of the "rest" of the "land" of the "chiefs of his first five years" as reaching from the Lower Zab River to the Euphrates Riviera (*ebriān Puratā*, well rendered "Paropotamia" by Winckler⁴) and *Hatte-land*; but this is obviously not a proper name in the same sense as *Naharin*.⁵ That probably originated in the maritime district of Syria.

Whilst the names we have mentioned are derived from physical geography, there are related names the meaning and origin of which are not so clear. Tethmosis III. is said, in a tomb which contains a picture of "the chief of this, to have" "overlorn the lands of My-t" (Breasted, *Anc. Rec.* ii. § 773), which lands are mentioned also in his hymn of victory (Breasted, *Anc. Rec.* ii. § 659). Amenophis II. receives tribute from the "chiefs of My-t" (Breasted, *Anc. Rec.* ii. § 804). In the bilingual Hittite inscription of Tarquidimma the land is called "the land of the city of Metan," just as in the Hittite documents the Hittite country in Asia Minor is called "the land of the city of Khatti." Metan is clearly the same as Mitanni, over against Khatti, mentioned e.g. by Tiglath-pileser I. (vi. 63), which is the same as Mitanni, since letters from which are in the Amarna collection. Since a Mitanni princess of these letters is called in Egyptian scarabs a princess of *Naharin*, it is clear that Mitanni and *Naharin* are more or less equivalent, whilst in the Amarna letters even Tushratta, the king of Mitanni, seems to use in the same way the name *Khanigalbat*. A shorter form of this name is *Khani*, which it is difficult not to connect with *Khana*, the capital of which at one time was *Tirqa*, on the Euphrates, below the *Khābūr* (see § 4). The slowly accumulating data have not yet made it possible to determine precisely the probably varying relations of these various names. The great astronomical work uses a term of still wider significance, *Subartu*, eventually *Suri* (written *Su. E.P.N.*; see especially Winckler's discussion in *Or. Lit.-Zeit.*, 1907). This represented one of the four quarters of the world in the early Babylonian view, the other three being *Akkad* (i.e. Babylonia) in the "north," *Elam* in the "south," and *Amuru* in the "west." It appears to have denoted the territory above Babylonia stretching from Anshan in the south-east towards Asia Minor. At an early time it seems to have formed along with Anshan a distinct kingdom.

Strabo (xvi. 746) makes the south limit of *Mesopotamia* the Median wall; Pliny (v. 24 § 21) seems to extend it to the Persian *Extant*.

Gulf. The Latin term naturally varied in meaning with the changing extent of Roman authority. For example, under Trajan *Mesopotamia* reached the gulf and was bounded by Assyria and Armenia. In modern times it is often

¹ There may be further evidence of the prevalence of the interpretation "amid" if the difficult *baināth ahrāwātha* of Cureton, *Anc. Syr. Doc.* p. 112, l. 21, is correctly rendered in Payne Smith, *Thesaurus Syr.* 469, "Mesopotamia," and if we may assume a reading *Nahrawātha* for *Ahrāwātha*.

² Compare the use of the adjective, Ephr. *Op. Gr.* ii. 403 (cf. *B. O.* i. 145, 168, 169), and the noun, *B. O.* ii. 108, 109.

³ *Mesopotamia* as personal names like *Na-ha-ra-a-u* occur (cf. John *Deeds and Documents*, iii. 127); but no name can be connected with a divine name Nachor.

⁴ *Assurg vorderas. Gesch.* 34; on the meaning see *Alt-orient. Forsch.* iii. 349.

⁵ It seems worth considering, however, whether *ebir narsi* (see Johns, *Assyr. Doomsday Book*, 6; Winckler, *Alt-orient. Forsch.* 212; Hommel, *Anc. Heb. Trad.*, index) is not in origin practically a *Begriff* equivalent to *Naharin*.

used for the whole Euphrates-Tigris country. That would provide a useful name for an important geographical unit, but is too misleading. In view of historical and geographical facts there is much to be said for applying the name *Mesopotamia* to the country drained by the *Khābūr*, the *Belikh*, and the part of the Euphrates connected therewith. It would thus include the country lying between Babylonia on the south and the Armenian Taurus highlands on the north, the maritime Syrian district on the west, and Assyria proper on the east. That is practically the sense in which it is treated in this article.⁶ We may begin, however, with the definition of *Jesira* by the Arabic geographers, who take it as representing the central part of the Euphrates-Tigris system, the part, namely, lying between the alluvial plains in the south and the mountainous country in the north. Measured on the Euphrates, this would be from the place where the river, having bored its way through the rocks, issues on to the high plain a little above *Samsāt* (*Samosata*) only 1500 ft. above the sea, to somewhere about *Hit* (*Is=Id*), where, probably less than 150 ft. above the sea, it begins to make its way through the alluvial deposits of the last few millenniums. In these 750 m. it has descended less than 1400 ft. Measured on the Tigris *Mesopotamia* would stretch from somewhere between *Jeizret-ibn-'Omar* and *Mōsul* to somewhere below *Tekfit*.

In the tract defined, physical changes unconnected with civilization have been slight as compared with those in Babylonia; the two great rivers, having cut themselves deep channels, could not shift their courses far.

i. *Natural Divisions*.—The stretch from *Samsāt* and *Jeizret-ibn-'Omar* to the alluvial plain seems to divide itself naturally into three parallel belts, highland watershed district, undulating plains and steppe. (1) The Taurus foothill barrier that shuts off the east to west course of the Euphrates and Tigris culminates centrally in the rugged volcanic *Karaja-Dāgh* (6075 ft.) which blocks the gap between the two rivers, continued eastwards by the mountainous district of *Tūr-'Abdin* (the modern capital *Midyāt* is at a height of 3500 ft.) and westwards by the elevated tract that sends down southwards the promontory of *J. Tektek* (c. 1950 ft.). (2) At the line where this east to west wall ends begins the sea of undulating plains where there is enough rain for abundant wheat and barley. (3) From the alluvial flats upwards toward these undulating plains is an extensive stretch of steppe land almost destitute of rain. Not far above the transition from the barren steppe a second mountain wall (125 m. between extremities) roughly parallel with the first, consisting of the *Sinjār* chain (about 3000 ft., limestone, 50 m. long, 7 m. broad), continued westwards after a marshy break by the volcanic *Tell Kōkab* (basalt, about 1300 ft.), and then the 'Abd al-'Aziz range (limestone), veering upwards towards its western end as if to meet the *Tektek* promontory from the north.

ii. *Drainage*.—The water system is thus determined. West of *Tektek* drains into the *Belikh*, east of *Tektek* into the *Khābūr*. All this drainage, collected into two rivers, the *Belikh* and the *Khābūr*, towards the left bank of the Euphrates, for the *Mesopotamian* watershed seems to be only some 15 m. or less from the Tigris until, south of the *Sinjār* range, it lies farther west, and the *Tharthār* river is possible. The *Belikh* (*Balich*, *Bilēcha*, *Βαλιχος*), a stream some 30 ft. wide, has its main source some 50 m. north in the 'Ain *Khālil* ar-Rahmān, but receives also the waters of the united *Nahr al-Kūt* (in its upper course formerly the *Daišān*, *Zēipros*) from *Edessa* and *Kōprü Dāgh*, and the *Jullāb* from *Tektek Dāgh* about as much farther north. The *Khābūr* (*Chabur*, *Chabura*), 80-100 ft. wide, before its last 40 m. reach in a south-west direction, has a 70 m. reach due north and south from *Tell Kōkab* (about 1300 ft.), near which are united the *Jaghghi* (earlier, *Hirmās*, 20 ft. in width), which has come 50 m. from *Nasibin* in the north-east, bringing with it the waters of the many streams from the *Tūr 'Abdin* highlands; the north 'Awi, which at certain seasons brings much water due south from *Mārdin*, and the main stream of the *Khābūr*, which has come 60 m. from *Ras al-'Ain* in the north-west, after flowing 50 m. by way of *Wērānshāhr* from *Karaja Dāgh* in the north. The *Tharthār* (Assyrian *Tartar*, in *Tukulti-Ninur II.*'s inscription) begins in the *Sinjār* range and runs southwards, to lose itself in the desert a little above the latitude of *Hit*. So it was two generations before *Ahab* (*Annales de Tukulti-Ninip*, V, Schell, 1909). The Arabian geographers represent the *Tharthār* as connected at its upper end (by a canal?) with the *Khābūr* system.

⁶ In general the Tigris is considered to belong to Assyria or Babylonia, and all west of the Euphrates to Arabia or Syria.

⁷ Cf. Ritter, *Erdbunde*, v. 250-253.

⁸ *Ibid.* xi. 253-265.

iii. *Character of Surface.*—(1) The tract between the Belikh and the Euphrates is in its middle section exceedingly fertile, as is implied in the name *Anthemusia*, and according to v. Oppenheim (*Z. d. Gesellsch. f. Erdkunde*, 36, 1901, p. 80) the same is true of the southern portion also. The plain extending from Urfa to a dozen miles below Harrân has a rich red-brown humus derived from the Nimrud Dâgh east of Edessa. (2) The rolling plains north of the 'Abd al-'Azîz Sinjâr mountains are intersected by the many streams of the Khâbûr system (the Arab geographer Mustaufi says of the Khâbûr, which under favourable political and administrative conditions would produce a marked fertility. At Nasîbin (Nisibis) rice is cultivated with success. (3) The country south of the mountain range is steppe land, imperfectly known, and of little use except for nomadic tribes, apart from the banks of the rivers (on which see EUPHRATES, TIGRIS). It consists mainly of grey dreary flats covered with selenite; and a little below the surface, gypsum. Bitumen is found at Hit, whence perhaps its name (Babylonian *Id* in Tukulti Ninib II.'s inscription referred to above), and near the Tigris.²

iv. *Climate.*—Mesopotamia combines strong contrasts of climate, and is a connecting link between the mountain region of western Asia and the desert of Arabia. At Dêr ez-Zôr, for example, the heat is intense. (1) In the steppe, during the sandstorms which frequently blow from the West Arabian desert the temperature may rise to 120° F. On the other hand, in winter the warm currents coming in from the Persian Gulf being met to a large extent by northerly currents from the snow-covered tracts of Armenia, are condensed down on to the plain and discharge moisture enough to cover the gravel steppes with spring herbage. (2) In the higher plains, in mid winter, since the high temperature air from the gulf is drawn up the valleys of the Euphrates and the Tigris there may be, e.g. at Mésul, a "damp mildness." In spring the grass on the rolling plains is soon parched. So when the hot sandstorms blow in the lower steppe the scorching heat is carried right up to the foot of the mountains. On the other hand, since the spurs of the Taurus bring the winter cold a long way south, and the cold increases from west to east as we leave the mild coast of the Mediterranean, far down into the Mesopotamian plain the influence of the snow-covered ridges can be felt, and in the higher parts of the plain snow altitude to reach the snow in November. In spring the temperature is about 14° F., especially if the cold north winds are blowing.

The cycle of vegetation begins in November. The first winter rains clothe the plain with verdure, and by the beginning of the year various bulbous plants are in bloom. The full summer development is reached in June. By the end of August everything is burnt up; August and September are the low-water months in the rivers, March to May the time of flood.

v. *Flora.*—(1) Botanical lists have been published by von Oppenheim (*Vom Mittelmeer zum Persischen Golf*, ii. 373-388) of a collection made in 1893 containing 43 entries for Mesopotamia, and by E. Herzfeld (*Herbaraufnahmen aus Kalat-Serbûb-Assur, in Beheft II. zur Orl. Zeit*, 1908, pp. 29-37) of a collection made in 1893-1905 in the neighbourhood of Assur, containing 181 entries.

(2) The following are among the more important products of the central zone of Mesopotamia: wheat, barley, rice, *Sarrî* (the Khâbûr), millet, sesameum (for oil, instead of olive), *dura* (*Holcus sorghum* and *H. bicolor*); lentils, peas, beans, vetches; cotton, hemp, safflower, tobacco; *Medicago sativa* (for horses); cucumber, melons, water-melons, figs (those of Sinjâr famed for sweetness), dates (below, 'Ana and Tekrit); a few timber trees; eplane and white poplar (by streams), willow and sumach (by the Euphrates). The sides not now the neighbourhood of Nisibis. (3) In the steppe the vegetation is that which prevails in similar soil from Central Asia to Algeria; but many of the arborescent plants that grow in the rockier and more irregular plateaux of western Asia, and especially of Persia, have been reported as missing. Endless masses of tall weeds, belonging to a few species, cover the face of the country—large *Cruciferae*, *Cynaræe* and *Umbelliferae*—also large quantities of liquorice (*Glycyrrhiza glabra* and *echinata*) and *Lagonychium*, and the white ears of the *Imperata*. In autumn the withered weeds are torn up by the wind and driven immense distances.

vi. *Fauna.*—The following abound: wild swine, hyaena, jackal, cheetah, fox; gazelle (in herds), antelope species (in the steppe); jerboa, mole, foxglove, and especially the common European rat (in the desert); bat, long-haired desert bat. The following are rare: wild ass; beaver, said to have been observed on the Euphrates; wolf, among others a variety of black wolf (*Canis lycaon*), said to be found in the plains; lion, said to roam as far as the Khâbûr. On the Euphrates are the following: vulture, owl, raven, &c., also the falcon (*Tinnanculus alaudarius*), trained to hunt. Among game birds are: wild duck and goose, partridge, francolin, some kinds of dove, and in the steppe the buzzard. The ostrich seems almost to have disappeared. Large tortoises abound, and in the 'Ain el-'Arâs pool, fresh-water turtles and carp. Of domestic

animals in the steppe the first place belongs to the camel; next come goat and sheep (not the ordinary fat-tailed variety); the common buffalo is often kept by the Arabs and the Turksomans on the Euphrates and the Tigris; on the Euphrates is found the Indian zebu.

vii. *Towns.*—The towns that have survived are on the rivers. Such are Samsât (see SAMOSATA), Rakka (Nicheporium) above the mouth of the Belikh, Dêr ez-Zôr, a rising town on the right bank, where there is (since 1897) a stone bridge, 'Ana (on an island; see ANA), Hit (Is. Bab. Id), on the Euphrates; Jeziret ibn 'Omar, Mésul (g.s.), Tekrit, on the Tigris; Edessa (g.s.), Harrân (g.s.), Mârdîn (half-way up the mountain wall), and Nasîbin (Assyria). Nasîbina, Nisibis, on confuents of the Khâbûr; Sinjâr (Singara) on the Tharthâr. Villages are more numerous than has often been supposed. Von Oppenheim counted in the district west of Edessa and Harrân, in a stretch of two days' march, 300 flourishing villages.

At one time, however, Mesopotamia was teeming with life. The lines of the rivers are marked at frequent intervals by the ruins of flourishing towns of Assyrian, Roman and Caliphate times. Such are Birejik, Jerâblû, Tell Ahmar, Kâl at en-Najm, Bâlis, Karkisiyâ (Qarqisiya, Circesium), on the Euphrates; Kuyunjik, Nimrud on the Tigris; Khorsâbâd on a small tributary; 'Arbân, Tell Khalaf, near the Tharthâr. The interesting oasis town el-Hadr (Hatra) is covered with countless mounds (*tells*), each of which marks the site of a town. The documents from the ancient Tîrqa said to have been found at 'Ishâra, a few miles below Karkisiyâ, are referred to below (§ 4). At Anaz (=Dûr of Tiglathpileser IV.) was found in 1901 a slab (Pognon, *Inscript. sem. de la Syrie*, Pl. xxvi, No. 59) with a bas-relief and an inscription of the governor of Dûr, Mushêzib-Shamash. The stele referred to below (§ 7, end) as being probably Nabonidus's was found in 1906 some 15-20' W. of Eski-Harrân, a little nearer to it than to Hmeira, which is west of Eski-Harrân, an hour and a half north-east of the ruins of Harrân. Parts of Mesopotamia have probably always harboured wandering tribes. Exactly how far the intervening lands beyond reach of the streams have done so it is difficult to make out. Fraser (*Short Cut to India*, p. 134) insists that in the undulating plains the direct rainfall is quite sufficient for agricultural purposes.

viii. *Political Divisions.*—On the whole the natural lie of the country has been reflected in the political divisions, which have of course varied in detail. We only mention some of those most often occurring. In the pre-Persian period, besides those referred to elsewhere, we may cite Kashyâr (Tûr 'Abdin), Guzanu (Gozan of 2 Kings xvii. 6; in the Khâbûr district), Bit Adini (Osroene), Kummûsû (north-west corner and beyond); in the Roman period, Osroene (g.s.), Mygdonia (in the east), and in Syriac usage Bêth 'Arbâyê (between Nisibis and Mésul); in the Arab period, Diarbêr (Tûr 'Abdin), Diâr Rebi'â (Mygdonia), Diâr Mu'âr (Osroene).

ix. *Roads.*—The routes of communication have probably changed little in the last 5000 years. It has not yet been proved that Edessa is an ancient city (see EDESSA; § 2) but it probably was, and its neighbour Harrân, the tower of which can be seen from it, bears a name which seems to indicate its position as a highway centre. (1) An obvious series of routes followed the course of the rivers: from Thapsacus (Dibse) down the Euphrates, from Jeziret ibn 'Omar down the Tigris, from Circesium up the Khâbûr. The Euphrates was crossed at Birejik (Til Barsip?), or Jerablû (Carchemish?), or Tell Ahmar (unidentified), or Thapsacus.¹⁰ (2) Probably the modern route from Samosata eastwards behind the Karaja Dâgh to Diarbêr was also well known. The same is doubtless true of the route from Osroene by Râs al-'Ain and Nasîbin, and that by Verânshehr and Mârdîn to the Tigris. About other cross-roads, such as those from Harrân to Tell Shaddâda on the lower Khâbûr, or from 'Ana by el-Hadr to Mésul it is difficult to say.

Functionally, Mesopotamia is the domain that lies between Babylonia and the related trans-Tigris districts on the one hand, and the west Asian districts of Maritime Syria and Asia Minor on the other. Its position has given it a **History: Earliest Times.** complicated and exciting history. The great rivers, in later times theoretically regarded as its boundaries, have never really been barriers (cf. e.g. Winckler, *Allorient. Forschungen*, iii. 348), whence the vagueness of the geographical terminology in all times. Its position, along with its character, has prevented it often or long, if ever, playing a really independent part.

Who the earliest inhabitants of Mesopotamia in approximately historical times were is not yet clear. It is possible that its

¹ Ritter, *Erdkunde*, xi. 279-492.

² For the interpretation cf. *Orl. Lit.-Zei.* xi. 242-244.

³ On the interpretation see P. Dhorme, *Rev. Bibl.* (Jan., 1908).

⁴ Ritter, *Erdkunde*, xi. 265-278.

¹⁰ On these and other crossing places, see Ritter, *Erdkunde*, x. 959-1004.

¹ Ritter, *Erdkunde*, xi. 493-498.

² See *Geog. Journ.* ix. 528-532 (with map).

³ Ritter, xi. 498-499. ⁴ *Ibid.*, xi. 499-502. ⁵ *Ibid.*, xi. 502-510.

connexion with the north, and Asia Minor, goes back to a very early date. It may be that some of the early north Babylonian kingdoms, such as Kish, extended control thither. The earliest Babylonian monarch of whose presence in Mesopotamia there is positive evidence is Lugalzaggisi (before 2500 B.C.), who claims, with the help of En-Il, to have led his countless host victorious to the Mediterranean. His empire, if he founded one, was before long eclipsed, however, by the rising power of the Semites. Excavation in Mesopotamia may in time cast some light on the questions whether the Semites really reached Babylonia by way of Mesopotamia,¹ when, and whom they found there, and whether they partly settled there by the way. Whether Sharru-GI, Manishtusu and Remush (often called Uru-mush) really preceded, and to some extent anticipated, "Sargon" *i.e.* Shargani-sharri, as L. W. King now² plausibly argues, is not certain; nor whether the 32 kings who revolted and were conquered by Manishtusu, as we now learn, were by the Mediterranean, as Winckler argued, or by the Persian Gulf, as King holds. That Sargon was or became supreme in Mesopotamia cannot be doubted, since there is contemporary evidence that he conquered Amurru. The three versions of the proceedings of Sargon (Sharru-GI-NA) in Suri leave us in doubt what really happened. As he must have asserted himself in Mesopotamia before he advanced into the maritime district (and perhaps beyond: see SARGON), what is referred to in the Omens and the Chronicle 26,472 may be, as Winckler argued (*Or. Lit.-Zeit.* 1907, col. 296), an immigration of new elements into Suri—in that case perhaps one of the early representatives of the "Hittite" group. According to the Omens text Sargon seems to have settled colonies in Suri, and suggestions of an anticipation of the later Assyrian policy of transportation have been found by King (*op. cit.*) under the rulers of this time, and there are evidences of lively intercommunication. Mesopotamia certainly felt the Sumero-Babylonian civilization early. It was from the special type of cuneiform developed there, apparently, that the later Assyrian forms were derived (Winckler, *Allorient. Forsch.* i. 86 seq.). What the "revolt of all lands" ascribed to the latter part of Sargon's reign means is not yet clear; but he or his son quickly suppressed it. Mesopotamia would naturally share in the wide trade relations of the time, probably reaching as far as Egypt. The importance of Harrân was doubtless due not only to its fame as a seat of the Moon-god Sin, honoured also west of the Euphrates, and to its political position, but also to its trade relations. Contemporary records of sales of slaves from Amurru are known.

When the Semitic settlers of the age of Sargon, whom it is now common with some justice to call Akkadians (see SUMER), had become thoroughly merged in the population, there appeared a new immigrant element, the Amurrû, whose advance as far as Babylonia is to be traced in the troubled history of the post-Gudean period, out of the confusion of which there ultimately emerged the Khammurabi dynasty. That the Amurrû passed through Mesopotamia, and that some remained, seems most probable. Their god Dagan had a temple at Tirqa (near 'Ishâra, a little below Circesium), the capital of Khana (several kings of which we now know by name), probably taking the place of an earlier deity. At Tirqa they had month names of a peculiar type. It is not improbable that the incorporation of this Mesopotamian kingdom with Babylon was the work of Khammurabi himself.

Not quite so successful eventually was the similar enterprise farther north at Asshur [or Assur (*q.v.*)] on the east margin of Mesopotamia, although we do not know the immediate outcome of the struggle between Asshur and the first Babylonian king, Sumu-abi. Possibly the rulers of Babylon had a freer hand in a city that they apparently raised to a dominant position than the Semitic rulers of Asshur, who seem to have succeeded to men of the stock which we have hitherto called Mitanni, if we may judge

¹ On the theory that it was climatic changes in Arabia that drove the Semites to seek new homes along the route mentioned above, see L. W. King, *History of Sumer and Akkad* (1910), which appeared after this article was written.

² See the preceding note.

from the names of Ushpia who, according to Shalmaneser I. and Esarhaddon, built the temple, and Kikia who, according to Ashur-rem-nisheshu, built the city wall.³ The considerable number of such names already found in First Dynasty records seems to show that people of this race were to be found at home as far south as Babylonia. Whether they were really called Shubarû, as Ungnad suggests, we may now later.

When Khammurabi's fifth successor saw the fall of the Amorite dynasty in consequence of an inroad of "Hittites," these may have been Mesopotamian Shubarû-Mitanni; but they may, as Ungnad suggests, represent rather ancestors of the Hittites of later times. It is difficult in any case not to connect with this catastrophe the carrying away to Khani of the Marduk statue afterwards recovered by Agum, one of the earlier kings of the Kassite dynasty. Whether Hittites were still resident at Khana we do not know. The earlier Kassite kings of Babylon still maintained the Amorite claim to "the four quarters;" but it is improbable that there was much force behind the claim, although we have a document from Khana dated under Kashtilias. It is just as uncertain how long Asshur remained under the Babylonian suzerainty of which there is evidence in the time of Khammurabi, and what the relation of Asshur to western Mesopotamia was under the early kings whose names have lately been recovered. All these matters will no doubt be cleared up when more of the many tells of Mesopotamia are excavated. Only two have been touched: 'Arbân on the Khâbîr, where remains of a palace of uncertain date, among other things an XVIII. dynasty scarab, were found by Layard in 1851, and Tell Khalaf, where the confluents join, and remains of the palace of a certain Kapor, son of Hanpan of "Hittite" affinities but uncertain date, were found by von Oppenheim in 1899. A long inscription of a certain Shamshi-Adad [Samsi-Hadad], extracts from which are quoted by Delitzsch (*Mit. d. Deutsch. Or.-Gesellschaft* No. 21 p. 50), unfortunately cannot be dated exactly, or with certainty even approximately; but if Delitzsch and Ed. Meyer are right, it belongs to a time not many generations after Agum recovered the Marduk statue. Shamshi-Adad's claims extend over the land between the Tigris and the Euphrates, and he says that he erected memorials of himself on the shore of the Great Sea.

The mystery of the Hyksos has not yet been solved; but it is not impossible that they had relations with Mesopotamia. After they had been driven out of Egypt (*q.v.*), when Ahmôse, the officer of Tethmosis (Thutmose) I., mentions Naharin (late 16th century), he does not say anything about the inhabitants. He seems to imply, however, that there was more than one state. The first mention of Mitanni, as we saw, is under Tethmosis III., who clearly crossed the Euphrates. It is at least possible that common enmity to Mitanni led to a treaty with Assyria (under Assur-nadin-akhe).⁴ Victorious expeditions into Naharin are claimed for Amenophis II., Tethmosis IV. and Amenophis III. The Egyptian references are too contemptuous to name the rulers; but Siaushatar may have begun his reign during the lifetime of Tethmosis III., and from cuneiform sources we know the names of six other Mitanni rulers. As they all bear Aryan names, and in some of their treaties appear Aryan deities (Indra, Varuna, Mithra, &c.), it is clear that Mesopotamia had now a further new element in its population, bearing apparently the name Khari.⁵ Many of the dynasts in North Syria and Palestine in the time of Tushratta bear names of the same type. The most natural explanation is that Aryans had made their way into the highlands east of Assyria, and thence bands had penetrated into Mesopotamia, peacefully or otherwise, and then, like the Turks in the days of the Caliphate, founded dynasties. The language of the Mitanni state, however, was neither Aryan nor Semitic, and may very well be that of the mysterious "Hittite" hieroglyphic inscriptions (see HITTITES). Mitanni was one of the great powers, alongside of Egypt and Babylonia, able to send to Egypt the Ninevite 'Ishtar; and at this time as much as at any

³ Ungnad, *Beitr. z. Assyriol.* VI. v. 13.

⁴ See *q.v.* Schnabel, *Stad. z. bab.-ass. Chron.* p. 25 (1908).

⁵ Winckler has identified the Khari with the Aryans, to whom he assigns a state in Armenia (*Or. Lit.-Zeit.*, July 1910).

other, we must think of common political relations binding the districts east and west of the Euphrates. The king mentioned above (Shaushatar) conquered Asshur (Assur), and Assyria remained subordinate to Mitanni till near the middle of the 14th century, when, on the death of Tushratta, it overthrew Mitanni with the help of Alshe, a north Mesopotamian state, the allies dividing the territory between them. The Hittite king's interference restored the Mitannite state as a protectorate, but with a smaller territory, probably in the north-west, where it may have survived long.

Assyria was now free, and Ashur-uballit [Assur-yuballidh acc. to Sayce] knew how to make use of his opportunities, and, in the words of his great grandson, "broke up the forces of the widespread Shubari" (AKA, p. 7, l. 32 seq.). Knowing what we know of the colonizing power of the Assyrians, we may assume that among the "Mitanni" and other elements in the Mesopotamian population there would now be an increase of people of "Assyrian" origin. On the tangled politics of this period, especially Mesopotamia's relations with the north-west, the Boghaz-Keui documents may be expected to throw a great deal of light. We know already a little more of the chequered history of the Amorites in the Naharin district, beset by great powers on three sides. When Mitanni fell Babylon no doubt adhered to its older claims on Mesopotamia; but the Kassite kings could do little to contest the advance of Assyria, although several rectifications of the boundary between their spheres are reported.

Mitanni's fall, however, had opened the way for others also. Hence when Ashur-uballit's grandson, Arik-den-ili (written *Aramaeans*. PU.DI.ili), carried on the work of enforcing Assyria's claim to the heirship of Mitanni, he is described as conquering the warriors¹ (?) of the Akhlame and the Suti. The references to these people, who practically make their first appearance in the Amarna correspondence,² show that they were unsettled bands who took advantage of the loosening of authority to introduce themselves into various parts of the country, in this case Mesopotamia. Gradually settlements were made, the names of many of which are given by the various Assyrian kings who had at one time or another to assert or reassert supremacy over them—such as Chindanu, Laqe, Subi along the South Euphrates boundary of Mesopotamia, and various districts bearing names compounded with *Bit* = settlement (see above), such as Bit-Adini (nearly equal the later Osroene; see EDSSA), or Bit-Zamani in the north near Diarbekr. The specific name Aramaean first appears in the annals of Tiglath-pileser I., unless we identify the Arimi of Shalmaneser I. in Tür 'Abdin with the Aramu;³ but the name may probably with fitness be applied to a very large number of the communities mentioned from time to time. Their position in Mesopotamia must have been very like that of the Shammar at the present time (see *ad fin.*). As they gradually adopted settled life in various parts of the country the use of Aramaic spread more and more (see below, § "Persians").

Meanwhile Mesopotamia continued to be crossed and recrossed by the endless marches of the Assyrian kings (such as Adad-nirari, Shalmaneser I. and his son), building and rebuilding the Assyrian empire (see BABYLONIA AND ASSYRIA), and eventually pushing their conquests towards Asia Minor at the expense of the Hittite domain. If, on the fall of the Kassites, Nebuchadrezzar I. established more direct relations between Mesopotamia and Babylon, his work was presently undone by the vigorous campaigns of Tiglath-pileser I., who seems to have even won Egypt's sanction of his succession to the Hittite claims. The newly recovered (1909) tablet of Tukulti-Ninib, the grandfather of Shalmaneser II., is interesting from its account of an expedition down the course of the Tharthâr to Hit=Id (river and town now first mentioned in cuneiform sources) and up the Euphrates to the Khâbür district.

Now that Mesopotamia had passed out of the hands of Babylon, all that the later kings could do was to encourage local Mesopotamian rulers in their desire for independence (Nabupluiddin). These were convinced that Assyria was master, but refused their tribute when they thought they dared. To thoroughly overpower the troublesome Bit-Adini (see above, § 3, viii.), which had naturally been aided by the states west of the Euphrates, Shalmaneser II. (860-825) settled Assyrians in their midst. Harrân was one of the few places that remained on his side during the great insurrection that darkened his last days. Similarly the province of Guzanu (Heb. Gozan, Γαζανωνίτις), on the Khâbür, held with the capital Asshur in the insurrection that occurred in 763 (the year of the eclipse), when evidently some one (an Adad-nirari?) wore the crown, at least for a time. Harrân was clearly closely associated with Asshur in the rights and institutions that were the subject of so much party struggle in the new Assyrian empire that began with Tiglath-pileser IV. (see BABYLONIA AND ASSYRIA). When the policy of transporting people from one part of the empire to another was developed, new elements were introduced into Mesopotamia, amongst them Israelites, of whom perhaps traces have been found in the neighbourhood of Harrân at Kanna'u.⁴ These new elements may have been more organically attached to the Assyrian state as such than the older inhabitants, to whom the affairs of state at Nineveh would be of little interest. On the conditions at Harrân some light is thrown by the census partly preserved in Ashurbanipal's library.⁵ The governors of several Mesopotamian cities, such as Naşibin, Amid, took their turn as eponyms; but this would not have much significance for the people. Hence even the fall of Nineveh (607 B. C.), apart from what such cities in Mesopotamia as held by its last kings suffered through the invasion, first perhaps of Nabopolassar, who in 609 B. C. claims to be lord of Shubari, and then of the Medes, would be a matter of comparative indifference; tribute paid to Babylon was just as hard to find as it was if they were going to Nineveh. Necho did not succeed, like his great XVIIIth dynasty predecessor, in crossing the Euphrates. He was defeated by Nebuchadrezzar at Carhemish (605 B. C.), and Mesopotamia was confirmed to Babylon. Its troubles began again shortly after Nebuchadrezzar's death; the Medes seized Mesopotamia and besieged Harrân. Before long, however, the overthrow of Astyages by Cyrus cleared Mesopotamia, and Nabonidus (Nabu-aid) was able, drawing on the resources of the whole of Syria for the purpose, to restore the famous temple of Sin at Harrân, where a few years later he erected in memory of his mother, who seems to have been a priestess there, the *stèle* published in 1907 by Pognon.

The fragmentary nature of the records does not enable us to follow the steps by which Cyrus became master of Mesopotamia, in which he probably met with little or no resistance. *Persians.* How much of Mesopotamia was involved in the revolt of what the Persian inscription calls Assyria (*Athur*) is not clear. Nor does it appear with certainty to which of the twenty satrapies into which, according to Herodotus, the Persian empire was divided, Mesopotamia belonged; probably it was included in 'Abar nahâra. The fact is, we have no information from native sources.⁶ The probability is that conditions remained very much what they had been; except that the policy of transportation was not continued. The satraps and other high officials would naturally be of Persian extraction; but local affairs were probably managed in the old way, and there was no important shift of population. The large Aramaic infusion had by this time been merged in the general body of the people. These settlers doubtless influenced the "Assyrian" language;⁷ but gradually, especially in the west, their own language more

¹ S. Schiffer, *Keilinschriftliche Spuren der in der zweiten Hälfte des 8. Jahrhunderts von den Assyriern nach Mesopotamien deportierten Samariter (10 Stämme)* (1907); C. H. W. Johns in *Proc. Soc. Bib. Arch.* (March, May, 1908).

² C. H. W. Johns, *An Assyrian Doomsday Book* (1901).

³ For the history from the time of Herodotus onwards, see Ritter, *Erdbunde*, x, 6-284.

⁴ M. Streck, *Klio*, vi, 222 seq.

¹ See M. Streck, *Zeit. Assyriol.*, 18, 157.

² On a wrongly supposed much earlier occurrence of the name Achlamu, see *Klio*, vi, 193 n. 3.

³ So for example A. Sanda, *Die Aramäer*, 5 (1902).

and more prevailed. Although Aramaic inscriptions of the Assyrian period, like those of Zanjirli or that of King ZKR of Hamath, have not been found in Mesopotamia, already in the time of Shalmaneser II. mention is made of an Aramaean letter (Harper, *Ass. Bab. Letters*, No. 872, obv. l. 10), and Aramaic notes on cuneiform documents begin to appear. Weights with Aramaic inscriptions (the oldest from the reign of Shalmaneser IV., 727-22) were found at Calah. By the Achaemenian period Aramaic had become the international language, and was adopted officially.

How Mesopotamia was affected by the passing of Persian armies on their way to suppress revolts in Syria or Egypt, or to conquer Greece, we do not know; on the whole it probably enjoyed unwanted peace. The expedition of Cyrus the Younger, with which Xenophon has made us so familiar, only skirted the left bank of the Euphrates. The route followed by Alexander, though he also crossed at Thapsacus, took him unresisted across the northern parts; but the poor people of Mesopotamia suffered from the measures taken by their satrap Mazaeus to impede Alexander's progress. In spite of this, where Cyrus failed Alexander succeeded.

What would have happened had Alexander lived we can only guess. Under the Seleucids Babylon was moved across the plain to Seleucia; but before long the central authority was transferred to the other side of Mesopotamia, Antioch or elsewhere—a fateful move. It is improbable that cuneiform and the Babylonian language continued to be used in Mesopotamia during the Hellenistic period, as it did in Babylonia, where it was certainly written as late as the last century B.C.;¹ and may have been a learned language till the second Christian century.² Unfortunately there are no native documents from the pre-Christian Hellenistic period. That the Hellenizing process went as far as it did in Syria is unlikely; and even there Aramaic remained the language of the people, even in the towns (cf. *EDSSA*). Still, Greek influence was considerable. This would be mainly in the towns, the growth of which was quite a feature of the Macedonian rule in Mesopotamia (Pliny, vi. 30, § 117).³ This is seen in the Greek names which now appear: such are Seleucia opposite Samosāta, Apamea (= Birejik) opposite Zeugma, Hierapolis (= Membij), Europolis, Nicatoris, Amphipolis (= Thapsacus, or near it), Niciphorium (er-Rakka), Zenodotium (stormed by Crassus), all on or by the Euphrates; Edessa (*q.v.*) on the upper waters of the Belikh, Ichnae (perhaps Khnēs, above the junction of the Qaramuch with the Belikh). These are all in the Osroene district; but Našbin became an Antioch, and as its district was known as Mygdonia (from Macedon) there were doubtless many other Greek settlements. To a less extent the same influences would be at work in towns called even by Western writers by their real names, such as Batnae, Carrhae (Charran), Rhesaena.

Mesopotamia naturally had its share of suffering in the struggles that disturbed the time, when Eumenes or Seleucus traversed it or wintered there. It was invaded and temporarily annexed in 245 by Ptolemy III. Euergetes in his rapid expedition to beyond the Tigris. When Molon revolted on the accession of the youthful Antiochus III. (224 B.C.) he entered Mesopotamia from the south. Antiochus skirted the northern highlands by way of Našbin. How far the natives of Mesopotamia shared the desire of the Greek settlers (*Antiq.* xiii. 5, 11, § 184-186) to help Demetrius II. Nicator in checking the aggressions of the rising power of Parthia under Mithradates I. we do not know. It was in Mesopotamia that a large part of the army of Antiochus VII. Sidetes was destroyed in 130 B.C., and the Syrian kings did not again seriously attempt to assert their rule beyond the Euphrates. When Phraates II. turned the Scythians against himself, however, even Mesopotamia suffered from the plunderers (*Joh. Antioch.* in Müller *iv.* 561). The immigration of Arabs

must have been going on for long. About this time they even founded a dynasty in Aramaean Osroene (see *EDSSA*).

Under Mithradates II. Mesopotamia was a definite part of the Parthian empire, of which the Euphrates became the western boundary; but in 92 B.C. on that river his ambassador met Sulla, though the long duel did not begin immediately.

Parthian
Period.

It was perhaps a Parthian governor of Mesopotamia that was called in to help Strato of Beroea against Demetrius III.; but before long Mesopotamia (especially the district of Nišibis) was attached to the growing dominions of Armenia under its ambitious king Tigranes, perhaps with the consent of Sinatruces (Sanatruces). The lost territory, however, was recovered by Phraates III., and Mesopotamia was guaranteed to Parthia by the treaties of Lucullus and Pompey (66 B.C.). It was traversed, however, several times by Roman troops crossing from Armenia to Syria, and Parthia's declaration of war against Armenia involved it with Rome. Gabinius crossed the Euphrates (54); but the command was assumed by Crassus, who, though he seized Ichnae, &c., and Raqqa (Rakka), fell near Carrhae (53), and the Parthian dominion was confirmed. The tragedy of the Ides of March saved Mesopotamia and the East from a great campaign by Julius Caesar, and it was at the hands of Ventidius Bassus, and west of the Euphrates, at Gindarus (north east of Antioch), that the Parthians received the check that put an end to any real rivalry with Rome. Mesopotamia narrowly escaped being the scene of the struggle when Antonius in 36 finally decided to make his disastrous attempt against Phraates IV. by way of Armenia. In A.D. 36, Tiridates found support in his attempt to secure the throne of Armenia III. in Mesopotamia, and it was there that he saw his army melt away. The affairs of Armenia continued to be the source of friction between Parthia and Rome, and Nišibis changed hands several times. The expedition against Rome of Vologases I. (*q.v.*) of A.D. 62 reached no further westwards than Nišibis, and in 66 a peaceable arrangement was come to. Of the half-century that preceded Trajan's great oriental undertaking not much is known. When in 115 Trajan entered Mesopotamia from the north no serious resistance was offered, and it became a province as far as Singara. The woods at Nišibis, the headquarters, provided material for the boats with which in 116 he crossed the Tigris. Hatra, an interesting fortress which seems to have been Aramaean, fell, and the army advanced to Hit, where it found the fleet that was subsequently transferred to the Tigris. For the revolt that occurred while Trajan was on the Persian Gulf, in which the Jews had an important hand, Nišibis and Edessa suffered capture and destruction. Hatra successfully withstood siege, however, and Hadrian abandoned Mesopotamia, setting the boundary at the Euphrates. Again for half a century there is not much to relate. Then, when Vologases, yielding to his growing discontent, took advantage of the death of Antoninus to invade Armenia the Romans were victorious (164), and after the storming of places such as Niciphorium, Edessa, Nišibis, western Mesopotamia was once more Roman as far as the Khābīr, Carrhae becoming a free city and Osroene a dependency.

By this time Christianity had secured a foothold, perhaps first among the Jews (see *EDSSA*), and we enter upon the earliest period from which documents in the Edessan dialect of Aramaic, known as Syriac, have been preserved. Unfortunately they contain practically nothing that is not of Christian origin.⁴ On the death of Aurelius Hatra aided Niger against Septimius Severus in 194; Osroene rose against Rome, and Nišibis was besieged and other Roman places taken; but Septimius Severus appeared in person (195), and from Nišibis as headquarters subdued the whole country, of which he made Nišibis metropolis, raising it to the rank of a colony, the Sinjār district, where Arabs from Yemen had settled, being incorporated. On his retiring everything was undone, only Nišibis holding out; but on his reappearance in 198 the Parthians withdrew. Again the Euphrates bore a Roman fleet. Hatra, however, was besieged twice in vain. Peace then prevailed till Caracalla's unprovoked attack on Parthia in 216, after he had reduced Osroene to a province. On his assassination near Carrhae (217), Macrinus was defeated at Nišibis and had to purchase peace, though he retained Roman Mesopotamia, reinstating the princely house in Osroene.

The power of Ardashir, the Sassanian, however, was already rising, and the Parthian Artabanus died in battle in 224 (or 227); and Ardashir proposed to prove himself the successor of the Achaemenidae. Hatra resisted the first Persian attack as it

⁴ The earliest inscription in Syriac yet known dates from A.D. 77, and was found at Serrin (opposite Kal'at en-Najm) by von Oppenheim.

¹ Probably the latest cuneiform document of certain date is a contract of 68 B.C. (cf. *Klio*, vi. 223 n. 3).

² See G. J. F. Gutschmid, *Zeitsch. f. Assyriol.* vi. 26-33; cf. M. Streck, *Klio*, vi. 223 n. 1.

³ See E. R. Bevan, *House of Seleucus*, i. 219-222, and references given there.

had resisted Rome; but Mesopotamia was overrun, Nišibis and Carrhae being taken (233). It was immediately, indeed, recovered by Alexander Severus, and retained, whatever the precise success of the war; but Nišibis and Carrhae were retaken by the Persians in the reign of Maximin.

Under Gordian III. in 242 Mesopotamia was entered by a great Roman army which recovered Carrhae and Nišibis, and defeated the Persians at Rhesaena; but when Gordian, after a difficult march down the Khābūr, was murdered at Zaitha below Circesium, Philip the Arabian (244) made the best terms he could with Shapur I. Whatever they were, the Roman garrisons seem not to have been really withdrawn. A rest for Mesopotamia seems to have followed; but in 258 Shapur, tempted by the troubles in the Roman empire, overran the country taking Nišibis and Carrhae, and investing Edessa, and when Valerian invaded Mesopotamia he was eventually made prisoner, by Edessa (260). After Shapur's cruel victories in Syria, however, he was defeated by Odaenathus, who relieved Edessa, and Mesopotamia became for ten years practically part of an Arabian Empire (see PALMYRA), as it was to be four centuries later. In consequence of the revolt of Zenobia Mesopotamia was lost to Rome, and the Euphrates became the frontier. Aurelian overthrew the Palmyran rule; but he was assassinated before he could carry out his intended expedition against Persia, Probus was assassinated before he was able to do anything (or much), and although Carus easily overran Mesopotamia, which became Roman again, and even took Ctesiphon, the Romans retreated on his death (283-4). The next incident is the defeat of Galerius, between Carrhae and Callinicus, where he had entered Mesopotamia (about 296), in the war provoked by Narses in consequence of his relations with Armenia. When it was retrieved by a signal victory, Diocletian advanced to Nišibis and thence dictated terms of peace by which Mesopotamia to the Tigris was definitely ceded to Rome (298).

One result of the connexion with Rome was, naturally, that Mesopotamia came within the range of the Decian, and later the Diocletian persecutions (see EDENSA: § Sassanian Period). At the Nicene Council there were bishops from Nišibis (Jacob), Rhesaena, Macedonopolis (on the Euphrates, west of Edessa), and Persia (Harnack, *Mission and Expansion of Christianity*, ii. 146; see generally 142-152).

After a forty years' peace the struggle was resumed by Shapur II. Nišibis thrice endured unsuccessful siege (338, 346, 350), although meanwhile Constantine had suffered defeat at Singara (348). Then Mesopotamia enjoyed two short rests (separated by a sharp struggle) while the rivals were engaged elsewhere, when in 363 Julian (*q.v.*) made his disastrous attempt, and Jovian bought peace at the price, among other things, of Singara and Nišibis—*i.e.* practically all eastern Mesopotamia.

The surrender of Nišibis, which had been in the possession of Rome for so many generations, caused consternation among the Christians, and Ephraem (*q.v.*) moved to Edessa, where his "school of the Persians" soon became famous (see EDENSA). In the war of 421, in which the north-east of Mesopotamia was chiefly concerned, the Romans failed to take Nišibis, and it became a natural rallying point for the Nestorians after the decision of Ephesus (431). Matters were still more complicated when the Western Christians of Edessa found themselves unable to accept the ruling of Chalcedon against Monophysitism in 451 (see MONOPHYTES), and there came to be three parties: Nestorians (*q.v.*), Jacobites (see JACOBITE CHURCH) and Melchites (*q.v.*).

In the beginning of the 6th century there was another severe struggle in Mesopotamia, which found an anonymous Syriac historian (see EDENSA), and in infringement of agreement the Romans strongly fortified Dārā against Nišibis. The Persian invasion of Syria under Kavadh I. (*q.v.*) was driven back by Belisarius; but the latter was defeated in his pursuit at Raḡka (531). The peace begun by Chosroes I. (532) was not long kept, and Roman Mesopotamia, except the pagan Ḥarrān, suffered severely (540), Edessa undergoing a trying siege (544). The fifty years' peace also (564) was short lived; the Persian

again failed in an attempt to recover Nišibis (573), whilst Chosroes' siege of Dārā was successful. Mesopotamia naturally suffered during the time of confusion that preceded and followed the accession of Chosroes II., and the Romans recovered their old frontier (591).

With the accession of Phocas (602) began the great war which shook the two kingdoms. The loss of Edessa, where Narses revolted, was temporary; but the Roman fortress of Dārā fell after nine months' siege (*c.* 605); Ḥarrān, Rās al-'Ain and Edessa followed in 607, many of the Christian inhabitants being transported to the Far East, and Chosroes carried the victorious arms of Persia far into the Roman Empire. Finally Heraclius turned the tide, and Kavadh II. restored the conquests of his predecessor. The Syrian Christians, however, found that they had only exchanged the domination of a Zoroastrian monarch for an unsympathetic ecclesiastical despotism. In the confusion that followed, when men of letters had to live and work in exile, Nišibis set up for a time (631-632) a grandson of Chosroes II. Finally all agreed on Yazdegerd III.; but, while Chosroes II. and Heraclius had been at death grips with each other a great invasion had been preparing in Arabia.

The Arab tribes in Mesopotamia were Christian, and Heraclius at Edessa hoped for their support; but Karkisiyā and Hit succumbed (636), and then Tektir; and Heraclius retired to Samošāta. When in 638 he made another attempt, it is said at the entreaty of the Mesopotamian Christians, Arab forces appeared before Raḡka, Edessa, Našibīn and other places, and all Mesopotamia was soon in the hands of the Arabs. Henceforth it looked to Damascus and to Kūfa and Baṣra, instead of to Constantinople or Ctesiphon. The new régime brought welcome relief to the Christian part of the population, for the Arabs took no note of their orthodoxies or heterodoxies. (Moawiya is said to have rebuilt the dome of the great church at Edessa after an earthquake in 678.) Fortunately for Mesopotamia the seats of the factions which immediately broke the peace of Islam were elsewhere; but it could not escape the fate of its geographical position.

The men of Raḡka were compelled to help 'Alī, after his march across Mesopotamia from near Mōsul, in getting a bridge made at Raḡka to convey his men to Siffin. Not long afterwards there was a new excitement in Moawiya's incursion across to the Tigris. The discontent under Yazid III. was keen in Mesopotamia, where Merwān in fact got a footing, and when the troubles increased after he became caliph he abandoned Damascus in favour of his seat at Ḥarrān. His son was besieged by Daḥbāk and his Khafrijites and Saffarijites in Nasibīn; but a fierce battle at Mardīn ended in Merwān's favour (745). The cruelties that accompanied the overthrow of the Omayyad dynasty excited a revolt, which spread to Mesopotamia, and Ḥarrān had to undergo a siege by one of Merwān's generals. It was next besieged by al-Manšūr's brother; but the battle between the brothers was fought at Našibīn. It was decisive, but there were further risings, involving Mesopotamia.¹

An inevitable effect of the reign of Islām had been that the kindred language of the Arabs gradually killed the vernacular Syriac of Mesopotamia (see EDENSA) as the alien Greek and Persian had shown no tendency to do, and the classical period (4th to 8th centuries) of the only Mesopotamian literature we know, such as it is, useful but uninviting, came to an end (see SYRIAC LITERATURE). This naturally encouraged grammatical study. Among the Aramaic-speaking people the revolution which displaced the Arabian court of Damascus in favour of a cosmopolitan world centred at the Babylonian seat of the civilizations dealt with in the preceding paragraphs naturally gave an impulse to the wider scholarship. Translations were made from Greek, as, e.g. by Thābit b. Qurra of Ḥarrān (*d.* 901), and from Pahlavi.

Manšūr built a castle at Raḡqa opposite Raḡka to control the country round, and his son Ḥarrūn al-Rashid actually resided during most of his reign, not at Bagdad but at Raḡka, where two generations later al-Battānī of Ḥarrān was making the astronomical observations on which his tables were based (see ALBATEGNUS). Abu Qurra, bishop of Ḥarrān, and acquaintance of the caliph Ma'mūn, who was one of the earlier Aramaean Christians to use Arabic, has been thought to have contributed to the influences

¹ For this and following section see further CALIPHATE and

that developed the Mutazilite (Motazilite) sect. Naṣībūn was the scene of another revolt (793) under a Khārijite leader, Hārūn's son Motaṣim displeased the people by creating a bodyguard of Turks, and therefore transferred his seat to Sāmarrā. This put the caliphs fatally at the mercy of their guards.

Mesopotamia fell partly under the power of Ahmad ibn Ṭūlūn of Egypt and his son; but before the end of the 9th century the Hamdānids, descendants of the Arab tribe of Ṭāghlib, *Caliphate* were in possession of Mārdīn, and in 919 one of them was generally acknowledged as the Khalīfa. Later the brothers Naṣir ad-Daula and Saif ad-Daula ruled over Mesopotamia and North Syria respectively. Meanwhile the caliph Motaṣim appeared as a fugitive at Mōsul, Naṣībūn, Raḡka (944). The Hamdānids were followed by the 'Oqaylids, who had their seats at various places, such as Mōsul, Naṣībūn, Raḡka, Harrān, between 996 and 1096. By 1055 the Seljuks had taken the caliph under their charge. They arrived at Jerusalem in 1076, the first crusaders reached Asia in 1097, and Bīt Adnīn became the courtship of Edessa (g.v.). The power of the Seljuks quickly disintegrated. The son of a slave of the third Seljuk sultan, Zangī, governor of 'Irāk, made himself gradually (Mōsul, Sinjār, Jezira, Harrān) master of Mesopotamia (1128), capturing Edessa in 1144. Mesopotamia fell to one of his sons, Saif ad-Dīn, and branches sprang up at Sinjār and Jezira. To the same period belong the other Atābeg dynasties; Beḡtīgnīds at Harrān, Tekrit, &c.; Ortoḡkīds at Edessa, 'Ana, &c., with Mārdīn as their headquarters. By 1185-1186 Salādīn had made Egypt supreme over all these principalities, thus achieving what the XVIIIth and XIXth Egyptian dynasties had attempted in vain. Mesopotamia remained in the hands of the Ayyūbīte family till the appearance of the Mongols. The petty principalities were unable to unite to resist the able attack, and Jezira, Edessa, Naṣībūn, Mārdīn, &c., fell in 1259-60. The leading men of Harrān emigrated into Syria, the rest were carried into slavery, and the ancient town was laid in ruins. It was the Mamlik sultan of Egypt that checked the death-bringing flood. Near Bīra was the scene of one of their victories (in 1273), and their authority extended to Karḡsīyā. The Ortoḡkīd dynasty survived the Mongol inundation, and it was in the 14th century that its laureate Saḡy ad-Dīn al-Hillī flourished. From the Mongol invasions of the 13th century western Asia has never recovered. Then, before the close of that century, came the invasion of Timur (1397-94). The Ortoḡkīds were followed by the Karakūyunī. In 1517 Mesopotamia passed for a time into the hands of the Safawīd shah, Ishmael; but in 1516 it came under the Osmanli Turks, to whom it has belonged ever since. The inroad of the Persians in the 17th century was confined to the south.

Since Mesopotamia finally came into the power of the Ottoman sultans considerable changes in the population have occurred.

About that time parts of a confederation of tribes *Named* which had taken the name of Shammar from a mountain *Arabs*, in their neighbourhood, moved northwards from Central Arabia in search of better pasture, &c. Successfully displacing their forerunners, they made themselves at home in the Syrian steppe—until their possession was in turn disputed by a later emigrant from Arabia, for whom they finally made room by moving on into Mesopotamia, over which they spread, driving before them their predecessors the Ṭai (whose name the Mesopotamian Aramaeans had adopted as a designation for Arab in general), partly north of the Sinjār, partly over the Tigris. Others they forced to abandon the nomadic life, and settle by the Khābūr (e.g. the Jebur) or the Euphrates. These adjustments, it is supposed, had been effected by 1700.

In 1831 'Alī, a newly appointed Turkish governor of Bagdad, induced Suḡfīg the chief of the Jerbā, the more important division of the Shammar, to help him to dislodge his predecessor, Dāvūd, who would not vacate his position, but then refused them the promised payment. To defend himself from the enraged Shammar 'Alī summoned the 'Anaza from across the Euphrates. Having also succeeded in detaching part of the Shammar under Shlōsh, he told the 'Anaza he no longer needed their help. In the futile attempt of the three parties to dislodge the 'Anaza Shlōsh lost his life; but with the help of Ṭa Zubeid the other two succeeded, and Suḡfīg was now supreme "King of the Steppe," leaving blackmail as his pleasure. Other methods of disposing of him having failed, the Porte made his nephew a rival *sheikh*; but he basely assassinated him. Suḡfīg then suffered the same fate himself at the hands of the pasha, but has since become a hero. Two of his sons became involved in a quarrel with the government, in consequence of which for years all Mesopotamia was in danger, till the second was put to death in 1868, and Ferḡān, the eldest son, a peaceable man who had been made pasha, became supreme. One of Suḡfīg's youngest had fled to her Ṭai kindred in Central Arabia with her widowed son Fāris; but when he grew up she brought him back; in the seventies, and he immediately attracted a great following. He kept to the far north of Mesopotamia to avoid his brother Ferḡān; but

finally half-sedentary tribes on the Khābūr and the Belikh became tributary to him, and a more or less active warfare sprang up between the brothers, which ended in a partition of Mesopotamia.

Ferḡān and the South Shammar claimed the steppe south-east of a line from Mōsul to Mayādīn (just below Karḡsīyā), and Fāris and the North Shammar the north-west. Since Ferḡān's death the Porte has favoured one after another of his many sons, hoping to keep the South Shammar disunited, especially as they are more than the others. The Shammar have been in undisputed mastery from Urfa to the neighbourhood of Bagdad, practically all tribes paying *kharwa* to them, and even the towns, till the government *ghisaw* them. Some 60 of these more or less nomadic communities, of one or two thousand tents (or houses) each, representing a population of several hundred thousands are described by Oppenheim. Each has its recognized camping ground, usually one for summer and another for winter. Most of them are Arab and Mahomedan. Some are Christian and some are not Arab: viz. Kurds, Turkomans or Circassians. For some years the Porte has been applying steady pressure on the nomads to induce them to settle, by increasing the number of military posts, by introducing Circassian colonies, as at Ras al-'Ain, sometimes by forcible settlement. More land is thus being brought under cultivation, the disturbing elements are being slowly brought under control, and life and property are becoming more secure.

Security is what the country chiefly needs. Hence its primary interest in the railway scheme, with a view to agricultural development and perhaps the growth of cotton; Sir W. Willcocks' irrigation schemes had *Present Time* not up to 1910 affected "Mesopotamia" directly.

Apparently the real problem is one of population adequate to effect the improvements demanded. The new régime introduced in 1908 seems to justify a hopeful attitude. Apart from the disturbing effects of recent events in Persia, an exposition of present conditions would show progress. Exact statistics are not available because the vilayet of Mōsul (35, 130,900 m., 351,200 pop.) takes in on the east territory with which we are not concerned, and omits the Osroene district, which goes with Aleppo. Urfa is a town of 55,000; Mōsul, 61,000, Bagdad, 145,000. The exports of Mōsul for 1908 were (in thousands of pounds sterling): United Kingdom 195, India 42, other countries 52, parts of Turkey 218; the imports: United Kingdom 56, India 16, other countries 35, parts of Turkey 24. The language is in most parts Arabic; but Turkish is spoken in Birejīk and Urfa, Kurdish and Armenian south of Diarbekr, and some Syriac in Tūr 'Abdin. There are Christian missionary institutions of European origin in various places, such as Urfa, Mārdīn, Mōsul. An interesting survival of early faiths is to be found in the Yazīdīs of the Sinjār district.

AUTHORITIES—Land and People: full references to Greek, Latin, Arabic and other writers are given in Ritter, *Erdbunde* x. 6-284, 921-1149; ju. 247-510, 660-762; for the conditions since the Arab conquest, Guy le Strange, *Lands of the Eastern Caliphate* (1905), chiefly pp. 86-114, is especially useful. Of recent works the following are valuable: E. Sachau, *Reise in Syrien u. Mesopotamien* (1883); M. v. Oppenheim, *Vom Mittelmeer zum Persischen Golf*, vol. ii (1889). We may mention further D. G. Hogarth, *The Near East* (1902), *passim*; K. Regling, "Zur historischen Geographic des mesopotamischen Parallelograms" (Sarug district), in *Klio*, I. 443-476; M. Sykes, "Journeys in North Mesopotamia" in *Geog. Journ.*, xxx. 237-254, 384-395; "The Western Bend of the Euphrates," *op. cit.* xxxiv. 61-65 (plans of two castles); D. Fraser, *Short Cut to India* (1909); W. Kurz, "Beurteilung der Aussichten auf eine Wiederbelebung der Kultur der Euphrat- und Tigrisniederung," in *Deutsche geographische Blätter*, xxxi. 147-179 (1908); E. Pénz, "The Bagdad Railway," in *Contemp. Rev.*, 1908, 570-591; K. Baedeker, *Palestine and Syria* (1906), pp. 189-412. The annual Consular Reports most nearly bearing on Mesopotamia are those for Aleppo, Mōsul, Bagdad and Basra.

Maps.—The following deserve special mention: v. Oppenheim, *op. cit.*, a most valuable large scale folding map in pockets of volumes; Sachau, *op. cit.*; M. Sykes, *Geog. Journ.*, xxx. opp. p. 356, and xxxiv. opp. p. 120; Hogarth, *op. cit.*, orographic, &c.

Excavations at 'Arban: A. H. Layard, *Nineveh and Babylon* (1849-1851), pp. 230-242; at Tell Khafal: M. v. Oppenheim, *Der Tell Kalaf* (1908), in the *Der alte Orient* series (see an account by J. L. Myers in *Annals of Archaeology and Anthropology*, ii. 139-144; at Asshur: *Sendschriften der deutsch. od. Gesellsch.*, and W. Andrae,

Der Anu Adad Tempel (1909). See also D. G. Hogarth, "Carchemesh and its Neighbourhood" (*Annals*, &c. ii. 165-184), and W. Andrae's *Die Ruinen von Hatra* (1908).

History.—Early period: besides the histories of Babylonia and Assyria see Winckler, various essays in his *Allor. Forschungen*, "Vorläufige Nachrichten über die Ausgrabungen in Boghaz-koï im Sommer, 1907," in *Mitteilungen der Deutsch. Orient. Gesellschaft*, No. 35, and "Suri" in *Oriental. Lit.-Zeit.*, x. 281-299, 345-357, 401-412, 643; O. Weber, the notes to Knudtzon's *Die El-Amarna Tafeln*; A. Ungnad, *Untersuchungen zu den . . . Urkunden aus Dabab* (1909), pp. 8-21; P. Schnabel, *Städte zur bab.-assyrischen Chronologie* (1908); A. Sanda, *Die Aramäer* (1902) in the *Der Alte Orient* series; M. Streck, "Über die älteste Geschichte der Aramäer" in *Klio*, vi. 185-225. For the later periods see PERSIA: **History**; HELLENISM; ROME: **History**; PARTHIA; SYRIAC LITERATURE; CALIPHATE and authorities there given. (H. W. H.)

MESOXALIC ACID (dioxymalonic acid), $(HO_2C)_2C(OH)_2$ or $C_2H_2O_6$, is obtained by hydrolysis of alloxan with baryta water (J. v. Liebig, *Ann.*, 1838, 26, p. 298), by warming caftaric acid with lead acetate solution (E. Fischer, *Ann.*, 1882, 215, p. 283), or from glycerin diacetate and concentrated nitric acid in the cold (E. Seelig, *Ber.*, 1891, 24, p. 3471). It crystallizes in deliquescent prisms and melts with partial decomposition at 119-120° C. It behaves as a ketonic acid, being reduced in aqueous solution by sodium amalgam to tartaric acid, and also combining with phenylhydrazine and hydroxylamine. It reduces ammoniacal silver solutions. When heated with urea to 100° C. it forms allantoin. By continued boiling of its aqueous solution it is decomposed into carbon dioxide and glyoxylic acid, $C_2H_2O_4$.

MESOZOA. Van Beneden¹ gave this name to a small group of minute and parasitic animals which he regarded as intermediate between the Protozoa and the Metazoa.

The Mesozoa comprise two classes: (1) the *Rhombozoa*, which are found only in the kidneys of Cephalopods, and (2) the *Orthonecrida*, which infest specimens of Ophiurids, Polychaets, Nematines, Turbellaria and possibly other groups.

Class I. RHOMBOZOA (E. van Beneden).—These animals consist of a central cell from which certain reproductive cells arise, enclosed in a single layer of flattened and for the most part ciliated cells; some of them are modified at the anterior end and form the polar cap. The *Rhombozoa* comprises two orders: (a) *Dicyemida*, ciliated vermiform creatures whose polar cap has 8 or 9 cells arranged in two rows (*Dicyema*, Koll., *Dicyemenna*, Whitm.); (b) *Heterocyemida*, non-ciliated animals with no polar cap, but whose anterior ectodermal cells contain refringent bodies and may be produced into wart-like processes (*Conoclypeus*, v. Ben. in *Ocyropsis vulgaris*; *Microclypeus* in *Sepia officinalis*). Unlike the *Dicyemida*, which are fixed in the renal cells of their host by their polar cap, the *Heterocyemida* are free. The number of ectoderm cells apart from the polar cap is few, some fourteen to twenty-two.

(From *Cambridge Natural History*, vol. II, "Worms, &c.," by permission of Macmillan & Co. Ltd. After Gamble.)

FIG. 1.—*Dicyemenna eladones* Wäg. from the kidney of *Eledone moschata*.
 A. Full-grown Rhombogen with infusoriform embryos (emb).
 g. Part of endoderm cell where formation of the embryos is actively proceeding.
 n. ect. Nucleus of ectoderm cell.
 n. end. Nucleus of endoderm cell.
 p. "Calotte."
 B. Developing infusoriform embryo.
 C. One fully developed.
 D. "Calotte" of nine cells.

The central cell is formed by the layer of the first two blastomeres, and remains quiescent until surrounded by the micromeres or products of division of the smaller blastomere. It then divides unequally, and of the two cells thus formed the larger repeats the process. Each of the two small cells are now called "primary germ cells," and they enter into and lie inside the large central cell. The primary germ cells divide until there are eight of them all lying within the axial cell. At this stage the future of the parasite may take one of two directions. Following one path, the animal (now called a "Nematogen") gives rise by the segmentation of its primary germ cells to vermiform larvae which, though smaller, are but replicas of the parent form. Following the other path, the animal (now termed a "Rhombogen") gives origin to a number of "infusoriform larvae," several of these arising from each primary germ-cell. The vermiform larvae leave their Nematogen parent and swimming through the renal fluid attach themselves to the renal cells. They never leave their host, and die in sea-water. The infusoriform larvae have a very complicated structure; they escape from the Rhombogen, and, unlike the vermiform larvae they can live in sea-water. They possibly serve to infect new hosts. Some authorities look upon these infusoriform larvae as males, and consider that they fertilize some of the Nematogens,

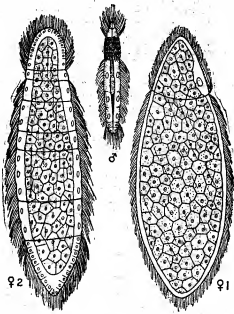

(From *Cambridge Natural History*, vol. II, "Worms, &c.," by permission of Macmillan & Co. Ltd. After Julin.)

FIG. 2.—*Rhopalura giardii* Metschn. from *Amphihura squamata*.

- ♂. Full grown male.
- ♀1. Flattened form of female.
- ♀2. Cylindrical female.

which then give rise to males again, whereas the females which produce the vermiform embryos arise from unfertilized vermiform larvae. After the infusoriform larvae have left the parent's body, the Rhombogen takes to producing vermiform offspring, and thus becomes a secondary Nematogen. Thus, if the above views be correct, a Rhombogen is a protandrous hermaphrodite.

E. Nerescheimer has recently described under the name of *Lohmannia calenata* an organism parasitic in *Fritillaria* which shows marked affinities with the *Rhombozoa*. The genus *Haplosoon* of which two species have been found in the worms *Travisia* and *Clymene* by Dogiel is classed as a new group of Mesozoa.

Class II. ORTHONECRIDA (A. Giard).—The *Orthonecrida* contain animals with a central mass of eggs destined to form male and female reproductive cells surrounded by a single layer of ciliated ectoderm cells arranged in regular rings which contain varying numbers of rows of cells. Muscular fibrils occur between the outer and inner cells. The sexes are separate and unlike, and there are two kinds of females, cylindrical and flat. There are but two genera, *Rhopalura* and *Staecharthrum*, the latter found in a Polychaet. The male *R. giardii* lives in the body-cavity of *Amphihura squamata*, has six rings of ectodermal cells all ciliated except the second, whose cells contain refringent granules. The ectoderm encloses the testis, a mass of cells which have arisen from a single axial cell in the embryo. The female differs from the male in appearance, and in size it is larger. It occurs in two forms: (1) The cylindrical with 8 (or 9) laws of ectoderm cells; here as in the male the second ring is devoid of cilia. (2) The flat; females are broader, uniformly ciliated, and have not rings of ectoderm cells. The central mass of cells forms

¹ *Bull. Ac. Belgique* (1876), p. 35.

ova which are free in the cylindrical forms; they leave the mother through the dehiscing of the cells of the non-ciliated ring, are fertilized and develop parthenogenetically into females both flat and cylindrical.

R. pelseneri and *S. giardi* are said to be hermaphrodite. The parasites first make their appearance in a host in the form of a plasmodium comparable with the sporocyst of a Trematode. By the segregation of nuclei and some of the surrounding protoplasm, germ cells arise which develop into ciliated larvae and ultimately into males and females which only discharge their spermatozoa and ova when they reach sea-water. The product of the consequent fertilization is unknown; presumably it infects new hosts, entering them in the form of a nucleated plasmodium.

The original idea that in the Rhombozoa and Orthothecida we had animals intermediate between the Protozoa and Metazoa is no longer widely held. The modern view is that the simplicity of their structure is secondary and not primary, and is correlated with their parasitic habit of life. They are probably derived from some Platyhelminthine ancestor and perhaps come nearer to the Trematoda than to any other group.

LITERATURE.—E. van Beneden, *Bull. Ac. Belgique* (2), (1876) xli. 85, 116; (1876), xlii. 35; also *Arch. Biol.* (1882), iii. 197; C. O. Whitman, *Mt. St. Neapel*, (1883), iv. 1; W. M. Wheeler, *Zool. Anz.*, (1899), xxii. 169; A. Giard, *Jour. anat. physiol.* (1879), xv. 440; *Quart. Jour. Micr. Soc.* (1880), xx. 225; St Joseph, *Bull. Soc. Zool. France* (1896), xxi. 58; Cautley and Messil, *C. R. ac. sci.* (1899), cxviii. 457 and 516; C. Julin, *Arch. Biol.* (1882), iii. 1; E. Nerescheimer, *Zeitschr. wiss. Zool.* (1904), lxxvi. 137; V. A. Dögel, *Tras. soc. imp. natur. St Petersburg* (1907), xxxiv. 28, and *Zool. Anz.* (1906), cxx. 895. (A. E. S.)

MESOZOIC ERA, in geology, the name given to the period of time between the Palaeozoic and Cainozoic eras; it is synonymous with the older and less satisfactory term "Secondary" as applied to the major divisions of geological time and with the "Flözgebirge" of the Wernerian school. This era is subdivided into a lower, Triassic, a middle, Jurassic, and an upper, Cretaceous period or epoch. The duration of the Mesozoic era was not more than one fourth of that of the Palaeozoic era, measured by the thickness of strata formed during these periods. It was an era marked by peaceful conditions in the earth's crust and by a general freedom from volcanic activity. The sediments as a whole are characterized by the prevalence of limestones as compared with those of the preceding era; they are seldom much altered or disturbed except in the younger mountain regions. Mammals, represented by small marsupials, and primitive forms of birds and bony fishes make their first appearance in rocks of Mesozoic age. Saurian reptiles played an extremely prominent part; ammonites and belemnites lived in extraordinary variety in the seas along with the echinoids and pelycypods, which had to a great extent supplanted the crinoids and brachiopods of the preceding periods. The first clear indications of monocotyledonous and dicotyledonous angiosperms made their appearance, while Cycads and Conifers constituted the bulk of the land flora.

MESQUITE, or **HONEY LOCUST**, in botany, a tree, native of the southern United States and extending southwards through Mexico and the Andean region to Chile and the Argentine Republic. It is known botanically as *Prosopis juliflora*, and belongs to the natural order Leguminosae (suborder Mimoseae). It reaches 40 or 50 ft. in height with a trunk usually not more than 6 to 12 in. in diameter, and divided a short distance above the ground into numerous irregular-crooked branches forming a loose straggling head. The remarkable development of its main root in relation to water-supply renders it most valuable as a dry-country plant; the root descends to a great depth in search of water, and does not branch or decrease much in diameter till this is reached. It can thus flourish where no other woody plant can exist, and its presence and condition afford almost certain indications of the depth of the water-level. When the plant attains the size of a tree, water will be found within 40 or 50 ft. of the surface; when it grows as a bush, between 50 or 60 ft.; while, when the roots have to descend below 60 ft., the stems are only 2 or 3 ft. high. These woody roots supply valuable fuel in regions where no wood of fuel value is produced above ground. The leaves are compound, the main axis bearing two or sometimes four secondary axes on which are borne a number of pairs of narrow bluish leaflets. The minute greenish-white fragrant flowers are densely crowded

on slender cylindrical spikes from 1½ to 4 in. long; the long narrow pods are constricted between the seeds, of which they contain from ten to thirty surrounded by a thick spongy layer of sweet pulp. The wood is heavy, hard and close-grained,² but not very strong; it is almost indestructible in contact with water, and is largely used for fence-posts and railway ties. The ripe pods supply the Mexicans and Indians with a nutritious food; and a gum resembling gum arabic exudes from the stem.

An allied species *Prosopis pubescens*, a small tree or tall shrub, native of the arid regions of the south-western United States, is known as the screw-bean or screw-pod mesquite from the fact that the pods are twisted into a dense screw-like spiral; they are used for fodder and are sweet and nutritious, but smaller and less valuable than those of the mesquite.

For a fuller account of these trees see Charles Sprague Sargent, *Silva of North America*, iii. p. 99 (1892).

MESS (an adaptation of O. Fr. *mes*, mod. *meis*; Ital. *messo*; derived from the Late Lat. *missum*, past participle of *mittere* "to send or place in position"), a service of meat, a dish sent to table. The term is also used of the persons who are in the habit of eating their meals together, and thus particularly of the parties into which a ship's company or a regiment is divided, either according to their rank, or for convenience in catering. Originally, a mess in this sense was a group of four persons sitting at one table and helped from the same dishes. In the Inns of Court, London, the original number is preserved, four benchers or four students dining together.

In early times the word mess was applied to food of a more or less liquid character, as soup, porridge, broth, &c. It is probably in allusion to the sloppy nature of semi-liquid messes of food that a mess has come also to mean a state of disorder, confusion and discomfort. Sateat takes the word in this sense to be a variant of "mash," originally to mix up.

MESSAGE (a word occurring in slightly different forms in several languages, e.g. Fr. *message*, Span. *mensaje*, Ital. *messaggio*; adapted from the Low Lat. *missalicium*, from *mittere*), a communication either verbal, written or printed, sent from one person to another. Message is the term generally applied to the official communications addressed by the heads of states to their legislatures at the opening of the session or at other times. These also, though written, are borne and delivered by special messengers and have the force of a face to face speech. The sessional and other messages to Congress of the president of the United States of America are printed state documents. Washington and John Adams delivered them in person but the practice was discontinued by Jefferson.

"Messenger" is of the same derivation; the earlier form of the word was *messager* (cf. *passenger*, *scavenger*). In ordinary language the word means one who is charged with the delivery of a message. In Scottish law a messenger-at-arms is an official appointed by Lyon-King-at-Arms to execute summonses and letters of diligence connected with the Court of Sessions and Court of Justiciary (see WRIT: § *Scotland*). Technically the term "messenger" is given to an endless rope or chain, passing from the capstan to the cable so that the latter may be hauled in when the messenger is wound round the capstan; also to a similar contrivance for hauling in a dredge.

MESSEGER, ANDRE CHARLES PROSPER (1853–), French musician, was born at Montluçon on the 30th of December 1853; he studied at Paris, and in 1874 became organist at St Sulpice. He was for some time a pupil of Saint-Saëns. In 1876 he won the gold medal of the Société des Compositeurs with a symphony. In 1880 he was appointed music director at Ste Marie-des-Batignolles. In 1883 he completed Firmin Bernicat's comic opera *François des bas bleus*; and in 1885 produced his own operettas, *La Fawette du temple* and *La Béarnaise*, the latter being performed in London in 1886. His ballet *Les Deux pigeons* was produced at the Paris Opéra in 1886. But it was the production of his comic opera *La Basoche* in 1890 at the Opéra Comique (English version in London the following year) that established his reputation; and subsequently this was increased by such tuneful and tasteful light

operas as *Madame Chrysanthème* (1893), *Mirette* (1894), *Les Petites Michus* (1897), and *Véronique* (1898), the latter of which had a great success in London. Besides conducting for some years at the Opéra Comique in Paris, Messager's services were also secured in London in 1901 and later years as one of the directors of the Covent Garden opera.

MESSALLA CORVINUS, MARCUS VALERIUS (64 B.C.—A.D. 8), Roman general, author and patron of literature and art. He was educated partly at Athens, together with Horace and the younger Cicero. In early life he became attached to republican principles, which he never abandoned, although he avoided offending Augustus by too open an expression of them. He moved that the title of *pater patriae* should be bestowed upon Augustus, and yet resigned the appointment of praefect of the city after six days' tenure of office, because it was opposed to his ideas of constitutionalism. In 43 B.C. he was proscribed, but managed to escape to the camp of Brutus and Cassius. After the battle of Philippi (42) he went over to Antony, but subsequently transferred his support to Octavian. In 31 Messalla was appointed consul in place of Antony, and took part in the battle of Actium. He subsequently held commands in the East, and suppressed the revolted Aquitanians; for this latter feat he celebrated a triumph in 27.

Messalla restored the road between Tusculum and Alba, and many handsome buildings were due to his initiative. His influence on literature, which he encouraged after the manner of Maecenas, was considerable, and the group of literary persons whom he gathered round him—including Tibullus, Lygdamus and the poet Sulpicia—has been called "the Messalla circle." With Horace and Tibullus he was on intimate terms, and Ovid expresses his gratitude to him as the first to notice and encourage his work. The two panegyrics by unknown authors (one printed among the poems of Tibullus as *lv. 1*, the other included in the *Catalepton*, the collection of small poems attributed to Virgil) indicate the esteem in which he was held. Messalla was himself the author of various works, all of which are lost. They included *Memoirs* of the civil wars after the death of Caesar, used by Suetonius and Plutarch; bucolic poems in Greek; translations of Greek speeches; occasional satirical and erotic verses; essays on the minutiae of grammar. As an orator, he followed Cicero instead of the Atticizing school, but his style was affected and artificial. Later critics considered him superior to Cicero, and Tiberius adopted him as a model. Late in life he wrote a work on the great Roman families, wrongly identified with an extant poem *De progenie Augusti Caesaris* bearing the name of Messalla, but really a 15th-century production.

Monographs by L. Wiese (Berlin, 1829), J. M. Valetton (Grönigen, 1874), L. Fontaine (Versailles, 1878); H. Schulz, *De M. V. aetate* (1886); "Messalla in Aquitania" by J. P. Postgate in *Classical Review*, March 1903; W. Y. Sellar, *Roman Poets of the Augustan Age. Horace and the Elegiac Poets* (Oxford, 1892), pp. 213 and 221 to 258; the spurious poem ed. by R. Mecenatē (1820).

Two other members of this distinguished family of the Valerian gens may be mentioned:—

1. **MARCUS VALERIUS MESSALLA**, father of the preceding, consul in 53 B.C. He was twice accused of illegal practices in connexion with the elections; on the first occasion he was acquitted, in spite of his obvious guilt, through the eloquence of his uncle Quintus Hortensius; on the second he was condemned. He took the side of Caesar in the civil war. Nothing appears to be known of his later history. He was augur for fifty-five years and wrote a work on the science of divination.

Cicero, *Ad Fam.* vi. 18, viii. 4, *ad Atticum*, iv. 16; Dio Cassius xi. 17, 45; *Belorum africanum*, 28; Macrobius, *Saturmalia*, i. 9, 14; Aulus Gellius xiii. 14, 3.

2. **MANIUS VALERIUS MAXIMUS CORVINUS MESSALLA**, consul 263 B.C. In this year, with his colleague Manius Otacilius (or Octacilius) and Syracusans, he gained a brilliant victory over the Carthaginians and Syracusans; the honour of a triumph was decreed to him alone. His relief of Messina obtained him the cognomen Messalla, which remained in the family for nearly 800 years. To commemorate his Sicilian victory, he caused it to be pictorially represented on the wall of the Curia Hostilia,

the first example of an historical fresco at Rome. He is said also to have brought the first sun-dial from Catania to Rome, where it was set up on a column in the forum.

Polybius i. 16; Dio. Sic. xxiii. 4; Zonaras viii. 9; Pliny, *Nat. Hist.*, vii. 60, xxxv. 4 (7).

MESSALLINA, VALERIA, the third wife of the Roman emperor Claudius (q.v.). She was notorious for her profligacy, avarice and ambition, and exercised a complete ascendancy over her weak-minded husband, with the help of his all-powerful freedmen. During the absence of Claudius from the city, Messallina forced a handsome youth named Gaius Silius to divorce his wife and go through a regular form of marriage with her. The freedman Narcissus, warned by the fate of another freedman Polybius, who had been put to death by Messallina, informed Claudius of what had taken place, and persuaded him to consent to the removal of his wife. She was executed in the gardens of Lucullus, which she had obtained on the death of Valerius Asiaticus, who through her machinations had been condemned on a charge of treason. She was only twenty-six years of age. By Claudius she was the mother of the unfortunate Britannicus, and of Octavia, wife of Nero.

See Tacitus, *Annals*, xi. 1-38; Dio. Cassius lx. 14-31; Juvenal vi. 115-135, x. 333, xiv. 331; Suetonius, *Claudius*; Merivale, *Hist. of the Romans under the Empire* ch. 50; A. Stahr, "Agrippina" in *Bilder aus dem Alterthume*, iv. (1865).

MESSAPII, an ancient tribe which inhabited, in historical times, the south-eastern peninsula or "heel" of Italy, known variously in ancient times as Calabria, Messapia and Iapygia. Their chief towns were Ugentum, Rudiae, Brundisium and Uria. They are mentioned (Herod. vii. 170) as having inflicted a serious defeat on the Greeks of Tarentum in 473 B.C. Herodotus adds a tradition which links them to the Cretan subjects of "King Minos." Their language is preserved for us in a scanty group of perhaps fifty inscriptions of which only a few contain more than proper names, and in a few glosses in ancient writers collected by Mommsen (*Unteritalische Dialekte*, p. 70). Unluckily very few originals of the inscriptions are now in existence, though some few remain in the museum at Taranto. The only satisfactory transcripts are those given by (1) Mommsen (*loc. cit.*) and by (2) I. P. Droop in the *Annual of the British School at Athens* (1905-1906), xii. 137, who includes, for purposes of comparison, as the reader should be warned, some specimens of the unfortunately numerous class of forged inscriptions. A large number of the inscriptions collected by Gamurini in the appendices to Fabretti's *Corpus inscriptionum italicarum* are forgeries, and the text of the rest is negligently reported. It is therefore safest to rely on the texts collected by Mommsen, cumbered though they are by the various readings given to him by various authorities. In spite, however, of these difficulties some facts of considerable importance have been established.

The inscriptions, so far as it is safe to judge from the copies of the older finds and from Droop's facsimiles of the newer, are all in the Tarentine-Ionic alphabet (with λ for ν and β for h). For limits of date 400-150 B.C. may be regarded as approximately probable; the two most important inscriptions—those of Bindsis and Vaste—may perhaps be assigned provisionally to the 3rd century B.C.

Mommsen's first attempt at dealing with the inscriptions and the language attained solid, if not very numerous, results, chief of which were the genitival character of the endings—*-iñi* and *-iñi*; and the conjunctival value of *inñi* (*loc. cit.* 79-84 sqq.). Since that time (1850) very little progress has been made. There is, in fact, only one attempt known to the present writer to which the student can be referred as proceeding upon thoroughly scientific lines, that of Professor Alf Tropp in *Indogermanische Forschungen* (1895), v. 195, which deals fully with the two inscriptions just mentioned, and practically sums up all that is either certain or probable in the conjectures of his predecessors. Hardly more than a few words can be said to have been separated and translated with certainty—*kalatoras* (masc. gen. sing.) "of a herald" (written upon a herald's staff which was once in the Naples Museum); *aran* (acc. sing. fem.) "arable

land"; *mazes*, "greater" (neut. acc. sing.), the first two syllables of the Latin *maiestas*; while *tepiše* (3rd sing. aorist indic.) "placed" or "offered"; and forms corresponding to the article (*ta* = Greek *tō*) seem also reasonably probable.

Some phonetic characteristics of the dialect may be regarded as quite certain: (1) the change of the original short *ō* to *ā* (as in the last syllable of the genitive *kalaotras*); (2) of final *-m* to *-n* (as in *aran*); (3) of *-i-* *-ŕ-* *-š-* respectively to *-m-* *-th-* and *-ss-* as in *dazohannes* = "Dasōnius," *dazohonnih* = "Dasōnii"; *dazelles*, gen. *dazēlīh* = "Dazetius, Dazetii," from the shorter stem *dazet-*; *Vallaso* for *Vallasio* (a derivative from the shorter name *Valla*); (4) the loss of final *d* (as in *tepiše*), and probably of final *t* (as in *-des*, perhaps meaning "set," from the root of Gr. *τίθημι*); (5) the change of original *dh* to *d* (*anda* = Gr. *ἄνθα* and *bh* to *b* (*beran* = Lat. *ferant*); (6) *-au-* before (at least some) consonants becomes *-ā-* (*Bāsta*, earlier *baūstra*). (7) Very great interest attaches to the form *penkahek*—which Torp very probably identifies with the Oscan stem *pompaiō*—which is a derivative of the Indo-European numeral "penque = 5."

If this last identification be correct it would show that in Messapian (just as in Venetic and Ligurian) the original velars were retained as gutturals and not converted into labials. The change of *o* to *a* is exceedingly interesting as being a phenomenon associated with the northern branches of Indo-European such as Gothic, Albanian and Lithuanian, and not appearing in any other southern dialect hitherto known. The Greek *Ἀφροδίτα* appears in the form *Aproditā* (dat. sing., fem.). The use of double consonants which has been already pointed out in the Messapian inscriptions has been very acutely connected by Deecke with the tradition that the same practice was introduced at Rome by the poet Ennius who came from the Messapian town Rudiae (Festus, p. 293 M).

It should be added that the proper names in the inscriptions show the regular Italic system of gentile names preceded by a personal praenomen; and that some inscriptions show the interesting feature which appears in the Tables of Heraclea of a crest or coat of arms, such as a triangle or an anchor, peculiar to particular families. The same reappears in the Iovilae (*q.v.*) of Capua and Cuma.

For further information the student must be referred to the sources already mentioned and further to W. Deecke in a series of articles in the *Rheinisches Museum*, xxxvi. 576 sqq.; xxxvii. 373 sqq.; xl. 131 sqq.; xlii. 226 sqq.; S. Bugge, *Bezenbergers Beiträge*, vol. 18. A newly discovered inscription has been published by L. Ceci *Notizie degli Scavi* (1908), p. 86; and one or two others are recorded by Professor Viola, *ibid.*, 1884, p. 128 sqq. and in *Giornale degli Scavi di Pompei*, vol. 4 (1898), pp. 70 sqq. The place-names of the district are collected by R. S. Conway, *The Italic Dialects*, p. 31; for the Tarentine-Ionic alphabet see *ibid.*, ii. 461.

For a discussion of the important ethnological question of the origin of the Messapians see W. Helbig, *Hermes*, xi. 257; P. Kretschmer, *Einführung in die Geschichte der griechischen Sprache*, pp. 262 sqq., 272 sqq.; H. Hirt, *Die sprachliche Stellung der Illyrischen (Festschrift für H. Kiepert)*, pp. 179-188. Reference should also be made to the discussion of their relation to the Veneti by C. Pauli in *Die Veneter*, p. 413 sqq., especially p. 437; and also to R. S. Conway, *Italic Dialects*, p. 15.

MESSENE, an ancient Greek city, the capital of Messenia, founded by Epaminondas in 369 B.C., after the battle of Leuctra and the first Theban invasion of the Peloponnese. The town was built by the combined Theban and Argive armies and the exiled Messenians who had been invited to return and found a state which should be independent of Spartan rule. The site was chosen by Epaminondas and lay on the western slope of the mountain which dominates the Messenian plain and culminates in the two peaks of Ithome and Eua. The former of these (2630 ft.) served as the acropolis, and was included within the same system of fortifications as the lower city. Messene remained a place of some importance under the Romans, but we hear nothing of it in medieval times and now the hamlet of Mavromati occupies a small part of the site.

Pausanias has left us a description of the city (iv. 31-33), its chief temples and statues, its springs, its market-place and gymnasium, its place of sacrifice (*τεροθύσιον*), the tomb of the hero Aristomenes (*q.v.*) and the temple of Zeus Ithomatas on the

summit of the acropolis with a statue by the famous Argive sculptor Ageladas, originally made for the Messenian helots who had settled at Naupactus at the close of the third Messenian War. But what chiefly excited his wonder was the strength of its fortifications, which excelled all those of the Greek world. Of the wall, some 5½ m. in extent, considerable portions yet remain, especially on the north and north-west, and almost the entire circuit can still be traced, affording the finest extant example of Greek fortification. The wall is flanked by towers about 31 ft. high set at irregular intervals: these have two storeys with loopholes in the lower and windows in the upper, and are entered by doors on a level with the top of the wall which is reached by flights of steps. Of the gates only two can be located, the eastern or Laconian, situated on the eastern side of the saddle uniting Ithome and Eua, and the northern or Arcadian gate. Of the former but little remains: the latter, however, is excellently preserved and consists of a circular court about 20 yds. in diameter with inner and outer gates, the latter flanked by square towers some 11 yds. apart. The lintel of the inner gate was formed by a single stone 18 ft. 8 in. in length, and the masonry of the circular court is of astonishing beauty and accuracy. The other buildings which can be identified are the theatre, the stadium, the council chamber or Bouleuterion, and the propylaeum of the market, while on the shoulder of the mountain are the foundations of a small temple, probably that of Artemis Laphria.

See E. Curtius, *Peloponnesos*, ii. 138 sqq.; W. M. Leake, *Travels in the Morea*, i. 366 sqq.; J. G. Frazer, *Pausanias's Description of Greece*, iii. 429 sqq.; W. G. Clark, *Peloponnesos*, 232 sqq.; A. Blouet, *Expéd. scient. de Morée: Architecture*, i. 37-42, Plates 38-47; E. P. Boblaye, *Recherches géogr. sur les ruines de la Morée*, 107 sqq.; C. Bursian, *Geographie von Griechenland*, ii. 165 sqq. (M. N. T.)

MESSENIAN (Gr. *Μεσσηνίη* or *Μεσσηνία*), the S.W. district of the Peloponnese, bounded on the E. by Mt Taygetus, on the N. by the river Neda and the Arcadian Mountains, on the S. and W. by the sea. Its area is some 825,000 acres, considerably less than that of Shropshire or Wiltshire. Historically and economically its most important part is the great plain, consisting of two distinct portions, watered by the river Pamis (mod. Pirnataz) and its affluents. This is the most fertile tract in Greece, and at the present day produces oranges, citrons, almonds, figs, grapes and olives in great abundance and of excellent quality. The plain is bounded on the north by the Nomian Mountains (mod. Tetrási, 5210 ft.) and their westerly extension, on the west by the mountains of Cyparissia (4000 ft.), a southern continuation of which forms the south-west peninsula of the Morea, attaining its greatest height in Mt Mathia (mod. Lykódimo 3160 ft.). Off the south coast of this peninsula lie the three Onussae islands and the islet of Theganussa (Venetikó). In spite of its long coast-line, Messenia has no good harbours except the Bay of Pylos (Navarino), and has never played an important part in Greek naval history.

The earliest inhabitants of Messenia are said to have been Pelasgians and Leleges (*qq.v.*), of whom the latter had their capital at Andania. They came as Aeolo-Minyan immigration, which apparently extended to Messenia, though the Pylos of Nestor almost certainly lay in Triphylia, and not at the site which in historic times bore that name. In the Homeric poems eastern Messenia is represented as under the rule of Menelaus of Sparta, while the western coast is under the Neleids of Pylos, but after Menelaus's death the Messenian frontier was pushed eastwards as far as Taygetus. A body of Dorians under Cresphontes invaded the country from Arcadia, and, taking as their capital Stenyclarus in the northern plain, extended first their suzerainty and then their rule over the whole district. The task apparently proved an easy one, and the Dorians blending with the previous inhabitants produced a single Messenian race with a strong national feeling. But the fertility of the soil, the warm and genial climate, the mingling of races and the absence of opposition, combined to render the Messenians no match for their hardy and warlike neighbours of Sparta. War broke out—in consequence, it was said, of the murder of the Spartan king Teleclus by the Messenians—which, in spite of

the heroism of King Euphaes and his successor Aristodemus (*q.v.*) ended in the subjection of Messenia to Sparta (*c.* 720 B.C.). Two generations later the Messenians revolted and under the leadership of Aristomenes (*q.v.*) kept the Spartans at bay for some seventeen years (648-631 B.C., according to Grote): but the stronghold of Ira (Eira) fell after a siege of eleven years, and those Messenians who did not leave the country were reduced to the condition of helots. The next revolt broke out in 464, when a severe earthquake destroyed Sparta and caused great loss of life; the insurgents defended themselves for some years on the rock-citadel of Ithome, as they had done in the first war; but eventually they had to leave the Peloponnese and were settled by the Athenians at Naupactus in the territory of the Locri Ozolae. After the battle of Leuctra (371 B.C.) Epaminondas invited the exiled Messenians scattered in Italy, Sicily, Africa and elsewhere to return to their country: the city of Messene (*q.v.*) was founded in 369 to be the capital of the country and, like Megalopolis in Arcadia, a powerful check on Sparta. Other towns too were founded or rebuilt at this time, though a great part of the land still remained very sparsely peopled. But though independent Messenia never became really powerful or able to stand without external support. After the fall of the Theban power, to which it had owed its foundation, it became an ally of Philip II. of Macedon and took no part in the battle of Chaeroneia (338 B.C.). Subsequently it joined the Achaean League, and we find Messenian troops fighting along with the Achaeans and Antigonus Doston at Sellasia in 222 B.C. Philip V. sent Demetrius of Pharos to seize Messene, but the attempt failed and cost the life of Demetrius: soon afterwards the Spartan tyrant Nabis succeeded in taking the city, but was forced to retire by the timely arrival of the Philopomen and the Megalopolitans. A war afterwards broke out with the Achaean League, during which Philopomen was captured and put to death by the Messenians (183 B.C.), but Lycortas took the city in the following year, and it again joined the Achaean League, though much weakened by the loss of Abia, Thuria and Pherae, which broke loose from it and entered the League as independent members (see ACHAEAN LEAGUE). In 146 B.C. the Messenians, together with the other states of Greece, were brought directly under Roman sway by L. Mummius. For centuries there had been a dispute between Messenia and Sparta about the possession of the *Ager Dentheliales* on the western slope of Taygetus: after various decisions by Philip of Macedon, Antigonus, Mummius, Caesar, Antony, Augustus and others, the question was settled in A.D. 25 by Tiberius and the Senate in favour of the Messenians (*Tac. Ann.* iv. 43).

In the middle ages Messenia shared the fortunes of the rest of the Peloponnese. It was overrun by Slavic hordes, who have left their traces in many village names, and was one of the chief battlefields of the various powers—Byzantines, Franks, Venetians and Turks—who struggled for the possession of the Morea. Striking reminders of these conflicts are afforded by the extant ruins of the medieval strongholds of Kalamata, Coron (anc. *Asine*, mod. Korone), Modon (*Methone*) and Pylos. At the present day Messenia forms a department with its capital at Kalamata, and a population numbering (according to the census of 1907), 127,991.

See W. M. Leake, *Travels in the Morea* (London, 1830), i. 324 sqq.; E. Curtius, *Peloponnensis* (Gotha, 1852), ii. 121 sqq.; C. Bursian, *Geographie von Griechenland* (Leipzig, 1868), li. 155 sqq.; E. P. Bohlave, *Recherches géographiques sur les ruines de la Morée* (Paris, 1835), 103 sqq.; Strabo viii. 358 sqq.; Pausanias iv. and the commentary in J. G. Frazer, *Pausanias's Description of Greece*, vol. iii.; and articles by W. Kolbe, *Athenische Mittheilungen* (1904), 364 sqq.; and M. N. Tod, *Journal of Hellenic Studies*, xxv. 32 sqq. Physical features: A. Philippson, *Der Peloponnes* (Berlin, 1892), 340-381. Inscriptions: *Inscriptiones graecae*, v.; Le Bas-Foucart, *Voyage archéologique: Inscriptions*, Nos. 291-326 A.; Collitz-Bechtel, *Sammlung der griech. Dialektschriften*, iii. 2, Nos. 4637-4692.

(M. N. T.)

MESSIAH (Dan. x. 25, 26), and **MESSIAS** (John i. 41; ii. 25), transcriptions (the first form modified by reference to the etymology) of the Greek *Μεσσίας*, (*Meśias*), which in

turn represents the Aramaic מְשִׁיחָא (*mēshīhā*), answering to the Hebrew מָשִׁיחַ, "the anointed."¹ There can be no doubt that a magical power was ascribed to the anointing oil (cf. Frazer, *Golden Bough*, 2nd ed., ii. 364 sqq.). The king was thereby rendered sacrosanct (1 Sam. xxiv. 6 sqq.; 2 Sam. i. 14 sqq.; iv. 9 sqq.), and he was considered to be endowed with a special virtue. Thus whoever curses the king is stoned as though God Himself had been cursed (2 Sam. xix. 22). In ancient Egyptian cultus the priest, after he has solemnly saluted the gods, begins the daily toilet of the god, which consists in sprinkling his image, clothing it with coloured cloths, and anointing it with oil (Erman, *Die ägyptische Religion*, p. 49). In the magical texts of Babylonia a similar virtue was attached to oil: "bright oil, pure oil, resplendent oil that bestows magnificence on the Gods . . . the oil for the conjuration (*šiptu*) of Marduk" (Tallquist, *Maklā* series, tablet vii. col. 1, 31 sqq.; cf. Gressmann, *Der Ursprung der israelitisch-jüdischen Eschatologie*, p. 258, sqq.). We have, in Schrader's *K.I.B.* v. letter 37 (p. 68), evidence from the Tell el-Amarna tablets that the anointing of kings was practised in Egypt or Syria in 1450 B.C. (c.) in a letter addressed to the Egyptian king by Rammam-nirari of Nubāssi. On the intimate relation which in primitive times subsisted between the sorcerer and the king see the citation from Frazer's *Early History of Kingship*, p. 127, in the article **PRIEST**, and cf. p. 20: "Classical evidence points to the conclusion that in prehistoric ages . . . the various tribes or cities were ruled by kings who discharged priestly duties" (p. 31). Thus the early kings of Assyria were priests of Assur (Āšur), the tutelary deity of Assyria. Tiglath-Pileser I. (c. 1100 B.C.) calls his predecessors, Šamsi-Rammam and Ismi-Dagan, *iššakku* (*pa-te-st*) of the God Assur (Prism-insc. col. vii. 62, 63). Later kings, e.g. Salmāneser II. (Nimrud-obelisk, line 15, monolith, line 11) and Assur-bani-pal (Rassam cyl. col. vii. 94) call themselves by the more definite title of *Sangu* of Assur. The Hebrew word with the article prefixed occurs in the Old Testament only in the phrase "the anointed priest" (Lev. iv. 3, 5, 16; vi. 22 [15]), but "Yahweh's anointed" is a common title of the king of Israel, applied in the historical books to Saul and David, in Lam. iv. 20 to Zedekiah, and in Isa. xlv. 1 extended to Cyrus. In the Psalms corresponding phrases (My, Thy, His anointed)² occur nine times, to which may be added the lyrical passages 1 Sam. ii. 10, Hab. iii. 13.

In the present attitude of literary criticism it would be most difficult to assert, as Robertson Smith did in the 6th edition of this work, that "in the intention of the writers it [*i.e.* the term messiah or "anointed"] refers to the king then on the throne." Nor would most recent critics agree with Professor Driver (*L.O.T.*, 8th ed. p. 385) in considering Pss. ii. and lxxiii. as "presumably pre-exilic." G. Buchanan Gray (*J.Q.R.*, July 1895, p. 658 sqq.) draws a parallel between the "king" in the Psalms and the "servant" in Deutero-Isaiah or Yahweh's "Son" (in Hos. xi. 1, &c.) which is applied to Israel either actual or idealized. It would be possible so to interpret "king" or "anointed" in some Psalms, e.g. lxi., lxiii., and lxxiv., but hardly in Pss. ii., lxxii., and lxxxix., where the Messianic reference is strongly personal.³ In the Psalms the ideal aspect of the kingship, its religious importance as the expression and organ of Yahweh's sovereignty, is prominent. When the Psalter became a liturgical book the historical kingship had gone by, and the idea alone remained, no longer as the interpretation of a present political fact but as part of Israel's religious inheritance. It was impossible, however, to think that a true idea had become obsolete merely because it found no expression on earth for the time being; Israel looked again for an anointed king to whom the words of the sacred hymns should apply with a force

¹ The transcription is as in *Ἐσαοβελ Γεωργίου* for *Ἐσ*, *Onomastica*, ed. Lagar. pp. 247, 281, *Bae. β.ii. 3*. For the termination -as for *mt*, see Lagarde, *Psalm. Memph.*, p. vii.

² The plural is found in Ps. cv. 15, of the patriarchs as consecrated persons.

³ In Ps. lxxv. 9 [10] it is disputed whether the anointed one is the king, the priest, or the nation as a whole. The second view is perhaps the best.

never realized in the imperfect kingship of the past. Thus the Psalms were necessarily viewed as prophetic; and meantime, in accordance with the common Hebrew representation of ideal things as existing in heaven, the true king remains hidden with God. The steps by which this result was reached must, however, be considered in detail.

The hope of the advent of an ideal king was only one feature of that larger hope of the salvation of Israel from all evils, which was constantly held forth by all the prophets, from the time when the seers of the 8th century B.C. proclaimed that the true conception of Yahweh's relation to His people could become a practical reality only through a great deliverance following a sifting judgment of the most terrible kind. The idea of a judgment so severe as to render possible an entire breach with the guilty past is common to all the prophets, but is expressed in a great variety of forms and images. As a rule the prophets directly connect the final restoration with the removal of the sins of their own age; to Isaiah the last troubles are those of Assyrian invasion, to Jeremiah the restoration follows on the exile to Babylon, to Daniel on the overthrow of the Greek monarchy. But all agree in giving the central place to the realization of a real effective kingship of Yahweh; in fact the conception of the religious subject as the nation of Israel, with a national organization under Yahweh as king, is common to the whole Old Testament, and connects prophecy proper with the so-called Messianic psalms and similar passages which speak of the religious relations of the Hebrew commonwealth, the religious meaning of national institutions, and so necessarily contain ideal elements reaching beyond the empirical present. All such passages are frequently called Messianic; but the term is more properly reserved as the specific designation of one particular branch of the Hebrew hope of salvation, which, becoming prominent in post-canonical Judaism, used the name of the Messiah as a technical term (which it never is in the Old Testament), and exercised a great influence on New Testament thought—the term "the Christ" (ὁ χριστός) being itself nothing more than the translation of "the Messiah."

In the period of the Hebrew monarchy the thought that Yahweh is the divine king of Israel was associated with the conception that the human king reigns by right only if he reigns by commission or "unction" from Him. Such was the theory of the kingship in Ephraim as well as in Judah (Deut. xxxiii.; 2 Kings ix. 6), till in the decadence of the northern state Amos (ix. 11) foretold¹ the redintegration of the Davidic kingdom, and Hosea (iii. 5; viii. 4) expressly associated a similar prediction with the condemnation of the kingship of Ephraim as illegitimate. So the great Judaean prophets of the 8th century connect the salvation of Israel with the rise of a Davidic king, full of Yahweh's Spirit, in whom all the energies of Yahweh's transcendental kingship are as it were incarnate (Isa. ix. 6 seq.; xi. 1 seq.; Micah v.). This conception, however, is not one of the constant elements of prophecy; other prophecies of Isaiah look for the decisive interposition of Yahweh in the crisis of history without a kingly deliverer. Jeremiah again speaks of the future David or righteous sprout of David's stem (xxiii. 5 seq.; xxx. 9) and Ezekiel uses similar language (xxiv., xxxvii.); but that such passages do not necessarily mean more than that the Davidic dynasty shall be continued in the time of restoration under worthy princes seems clear from the way in which Ezekiel speaks of the prince in chs. xlv., xlvi. As yet we have no fixed doctrine of a personal Messiah, but only material from which such a doctrine might be drawn. The religious view of the kingship is still essentially the same as in 2 Sam. vii., where

the endless duration of the Davidic dynasty is set forth as part of Yahweh's plan.

There are other parts of the Old Testament—notably 1 Sam. viii., xii. (belonging to the later stratum)—in which the very existence of a human kingship is represented as a departure from the theocratic ideal, and after the exile, when the monarchy had come to an end, we find pictures of the latter days in which its restoration has no place. Such is the great prophecy of Isa. xl.-xlviii., in which Cyrus is the anointed of Yahweh. So too there is no allusion to a human kingship in Joel or in Malachi; the old forms of the Hebrew state were broken, and religious hopes expressed themselves in other shapes.² In the book of Daniel it is collective Israel that, under the symbol of a "son of man," receives the kingdom (vii. 13, 18, 22, 27).

Meantime, however, the decay and ultimate silence of the living prophetic word concurred with prolonged political servitude to produce an important change in Hebrew religion. To the prophets the kingship of Yahweh was not a mere ideal, but an actual reality. Its full manifestation indeed, to the eye of sense and to the unbelieving world, lay in the future; but true faith found a present stay in the sovereignty of Yahweh, daily exhibited in providence and interpreted to each generation by the voice of the prophets. And, while Yahweh's kingship was a living and present fact, it refused to be formulated in fixed invariable shape.

But when the prophets were succeeded by the scribes, the interpreters of the written word, and the yoke of foreign oppressors rested on the land, Yahweh's kingship, which presupposed a living nation, found not even the most inadequate expression in daily political life. Yahweh was still the lawgiver of Israel, but His law was written in a book, and He was not present to administer it. He was still the hope of Israel, but the hope too was only to be read in books, and these were interpreted of a future which was no longer the ideal development of forces already at work, but wholly new and supernatural. The present was a blank, in which religious duty was summed up in patient obedience to the law and penitent submission to the Divine chastisements. The scribes were mainly busied with the law; but no religion can subsist on mere law; and the systematization of the prophetic hopes, and of those more ideal parts of the other sacred literature which, because ideal and discovered from the present, were now set on one line with the prophecies, went on side by side with the systematization of the law, by means of a harmonistic exegesis, which sought to gather up every prophetic image in one grand panorama of the issue of Israel's and the world's history. The beginnings of this process can probably be traced within the canon itself, in the book of Joel and the last chapters of Zechariah;³ and, if this be so, we see from Zech. ix. that the picture of the ideal king claimed a place in such constructions. The full development of the method belongs, however, to the post-canonical literature, and was naturally much less regular and rapid than the growth of the legal traditions of the scribes. It was in crises of national anguish that men turned most eagerly to the prophecies, and sought to construe their teachings as a promise of speedy deliverance (see APOCALYPTIC LITERATURE). But these books, however influential, had no public authority, and when the yoke of oppression was lightened but a little their enthusiasm lost much of its contagious power. It is not therefore safe to measure the general growth of eschatological doctrine by the apocalyptic books, of which Daniel alone attained a canonical position. In the Apocrypha eschatology has a relatively small place; but there is enough to show that the hope of Israel was never forgotten, and that the imagery of the prophets was accepted with a literalness not contemplated by the prophets themselves.

It was, however, only very gradually that the figure and name of the Messiah acquired the prominence which they have in

¹ The hopes which Haggai and Zechariah connect with the name of Zerubbabel, a descendant of David, hardly form an exception to this statement. There may even be a reference to him in Isa. lv. 3, 4.

² See Stade's articles "Deuterocacharia," *Z. f. A.-T.-liche Wiss.*, 1881-1882. Cf. Dan. ix. 2 for the use of the older prophecies in the solution of new problems of faith.

³ Most recent critics regard Amos ix. 9-15 as a later addition, and the same view is held by Nowack, Harper and others respecting Hos. iii. 5, though on grounds which seem questionable. Isa. ix. 1-7, xi. 1 sqq. are held by Hackmann, Cheyne, Marti, and other critics to be post-exilian. Duhm and others hold that they are genuine. It may be admitted that Isa. xi. 1 seq. might be held to be contemporary with Isa. lv. 3, 4, and to refer to Zerubbabel. Cf. Haggai ii. 21-23, composed seventeen years afterwards. Mic. v. 1-8 can with difficulty be regarded as genuine.

later Jewish doctrine of the last things and in the official exegesis of the Targums. In the very developed eschatology of Daniel they are, as we have seen, altogether wanting, and in the Apocrypha, both before and after the Maccabean revival, the everlasting throne of David's house is a mere historical reminiscence (Eccles. xvii. 11; 1 Macc. ii. 57). So long as the wars of independence occupied the Palestinian Jews, and the Hasmonæan sovereignty promised a measure of independence and felicity under the law, the hope that connected itself with the House of David was not likely to rise to fresh life, especially as a considerable proportion of the not very numerous passages of Scripture which speak of the ideal king might with a little straining be applied to the rising star of the new dynasty (cf. 1 Macc. xiv. 4-15). It is only in Alexandria, where the Jews were still subject to the yoke of the Gentile, that at this time (c. 140 B.C.) we find the oldest Sibylline verses (iii. 652 seq.) proclaiming the approach of the righteous king whom God shall raise up from the East (Isa. xli. 2). The name Messiah is still lacking, and the central point of the prophecy is not the reign of the deliverer but the subjection of all nations to the law and the temple.¹

With the growing weakness and corruption of the Hasmonæan princes, and the alienation of a large part of the nation from their cause, the hope of a better kingship begins to appear in Judæa also; at first darkly shadowed forth in the *Book of Enoch* (chap. xc.), where the white steer, the future leader of God's herd after the deliverance from the heathen, stands in a certain contrast to the actual dynasty (the horned lambs); and then much more clearly, and for the first time with use of the name Messiah, in the *Psalter of Solomon*, the chief document of the protest of Pharisaism against its enemies the later Hasmonæans. The struggle between the Pharisees and Sadducees, between the party of the scribes and the aristocracy, was a struggle for mastery between a secularized hierarchy whose whole interests were those of their own selfish politics, and a party to which God and the exact fulfilment of the law according to the scribes were all in all. This doctrine had grown up under Persian and Grecian rule, and no government that possessed or aimed at political independence could possibly show constant deference to the punctilios of the schoolmen. The Pharisees themselves could not but see that their principles were politically impotent; the most scrupulous observance of the Sabbath, for example—and this was the culminating point of legality—could not thrust back the heathen. Thus the party of the scribes, when they came into conflict with an active political power, which at the same time claimed to represent the theocratic interests of Israel, were compelled to lay fresh stress on the doctrine that the true deliverance of Israel must come from God.

But now the Jews were a nation once more, and national ideas came to the front. In the Hasmonæan sovereignty these ideas took a political form, and the result was the secularization of the kingdom of God for the sake of a harsh and rapacious aristocracy. The nation threw itself on the side of the Pharisees; not in the spirit of punctilious legalism, but with the ardour of a national enthusiasm deceived in its dearest hopes, and turning for help from the delusive kingship of the Hasmonæans to the true kingship of Yahweh, and to His vicegerent the king of David's house. It is in this connexion that the doctrine and name of the Messiah appear in the *Psalter of Solomon*. The eternal kingship of the House of David, so long forgotten, is seized on as the proof that the Hasmonæans have no divine right.

"Thou, Lord, art our king for ever and ever. . . . Thou didst choose David as king over Israel, and swarest unto him concerning his seed for ever that his kingship should never fail before Thee. And for our sins sinners (the Hasmonæans) have risen up over us, taking with force the kingdom which Thou didst not promise to them, profaning the throne of David in their pride. But Thou, O Lord, wilt cast them down and root out their seed from the land, when a man not of our race (Pompey) rises up against them. . . . Behold, O Lord, and raise up their king the Son of David at the time that Thou hast appointed, to reign over Israel Thy servant; and gird him with strength to crush unjust rulers; to cleanse Jerusalem from the heathen that tread it under foot, to cast out sinners from Thy

inheritance; to break the pride of sinners and all their strength as potter's vessels with a rod of iron (Ps. ii. 9); to destroy the lawless nations with the word of his mouth (Isa. xi. 4); to gather a holy nation and lead them in righteousness. . . . He shall divide them by tribes in the land, and no stranger and foreigner shall dwell with them; he shall judge the nations in wisdom and righteousness. The heathen nations shall serve under his yoke; he shall glorify the Lord before all the earth, and cleanse Jerusalem in holiness, as in the beginning. From the ends of the earth all nations shall come to see his glory, and bring the weary sons of Zion as gifts (Isa. lx. 3 seq.); to see the glory of the Lord with which God hath crowned him; for he is over them a righteous king taught of God. In his days there shall be no unrighteousness in their midst; for they are all holy and their king the anointed of the Lord (Χριστός κτιστός, mistranslation of משיח מרומם)—*Psalter*. Sol. xvii.

This conception is traced in lines too firm to be those of a first essay; it had doubtless grown up as an integral part of the religious protest against the Hasmonæans. And while the polemical motive is obvious, and the argument from prophecy against the legitimacy of a non-Davidic dynasty is quite in the manner of the scribes, the spirit of theocratic fervour which inspires the picture of the Messiah is broader and deeper than their narrow legalism. In a word, the Jewish doctrine of the Messiah marks the fusion of Pharisaism with the national religious feeling of the Maccabean revival. This national feeling, claiming a leader against the Romans as well as deliverance from the Sadducee aristocracy, again sets the idea of the kingship rather than that of resurrection and individual retribution in the central place. Henceforward the doctrine of the Messiah is the centre of popular hope and the object of theological culture. The New Testament is the best evidence of its influence on the masses (see especially Matt. xxi. 9); and the exegesis of the Targums, which in its beginnings doubtless reaches back before the time of Christ, shows how it was fostered by the Rabbins and preached in the synagogues.² Its diffusion far beyond Palestine, and in circles least accessible to such ideas, is proved by the fact that Philo himself (*De praem. et poen.* § 16) gives a Messianic interpretation of Num. xxiv. 27 (LXX). It must not indeed be supposed that the doctrine was as yet the undisputed part of Hebrew faith which it became when the fall of the state and the antithesis to Christianity threw all Jewish thought into the lines of the Pharisees. It has, for example, no place in the *Assumption of Moses* or the *Book of Jubilees*. But, as the fatal struggle with Rome became more and more imminent, the eschatological hopes which increasingly absorbed the Hebrew mind all group themselves round the person of the Messiah. In the later parts of the *Book of Enoch* (the "symbols" of chap. xiv. seq.) the judgment day of the Messiah (identified with Daniel's "Son of Man") stands in the forefront of the eschatological picture. Josephus (*B. J.* vi. 5, § 4) testifies that the belief in the immediate appearance of the Messianic king gave the chief impulse to the war that ended in the destruction of the Jewish state; after the fall of the temple the last apocalypses (*Baruch*, 4 *Ezra*) still loudly proclaim the near victory of the God-sent king; and Bar Cochebas, the leader of the revolt against Hadrian, was actually greeted as the Messiah by Rabbi Aqiba (cf. Luke xli. 8). These hopes were again quenched in blood; the political idea of the Messiah, the restorer of the Jewish state, still finds utterance in the daily prayer of every Jew (the *Shemônê Esrê*), and is enshrined in the system of Rabbinical theology; but its historical significance was buried in the ruins of Jerusalem.³

¹ The Targumic passages that speak of the Messiah are registered by Buxtorf, *Lex. Chald.*, s.v.

² False Messiahs have continued from time to time to appear among the Jews. Such was Serenus of Syria (c. 720 A.D.). Soon after, Messianic hopes were active at the time of the fall of the Omayyads, and led to a serious rising under Abu 'Isa of Ispahan, who called himself forerunner of the Messiah. The false Messiah David Alru (Alroy) appeared among the warlike Jews in Azerbaijan in the middle of the 12th century. The Messianic claims of Abraham Abulafia of Saragosa (born 1240) had a cabalistic basis, and the same studies encouraged the wildest hopes at a later time. Thus Abarbanel calculated the coming of the Messiah for 1503 A.D.; the year 1500 was in many places observed as a preparatory season of penance; and throughout the 16th century the Jews were much stirred and more than one false Messiah appeared. See also SABBATAI, SEBI.

³ In *Sibyll.* iii. 775, $\epsilon\mu\theta\omega$ must undoubtedly be read for $\epsilon\lambda\theta\omega$.

But this proof that the true kingdom of God could not be realized in an earthly state, under the limitations of national particularism, was not the final refutation of the Old Testament hope. Amidst the last convulsions of political Judaism a new spiritual conception of the kingdom of God, of salvation, and of the Saviour of God's anointing, had shaped itself through the preaching, the death, and the resurrection of Jesus of Nazareth. As applied to Jesus the name of Messiah lost all its political and national significance. Between the Messiah of the Jews and the Son of Man who came to give His life a ransom for many there was on the surface little resemblance; and from their standpoint the Pharisees reasoned that the marks of the Messiah were conspicuously absent from this Christ. But when we look at the deeper side of the Messianic conception in the *Psalter of Solomon*, at the heartfelt longing for a leader in the way of righteousness and acceptance with God which underlies the aspirations after political deliverance, we see that it was in no mere spirit of accommodation to prevailing language that Jesus did not disdain the name in which all the hopes of the Old Testament were gathered up.

Messianic Parallels.—Within the limits of this article it is impossible to attempt any extended survey of parallels to Hebrew Messianic conceptions drawn from other religions. One interesting analogy communicated by Professor Rappson, may however, be cited from the *Bhagavad-gītā*, iv. 5-8, in which Krishna says:—
5 "Many are the births that have passed of me and of thee
Arjuna.
All these I know: thou knowest them not, O conqueror of
thy foes.

- 6 Unborn, of imperishable soul, the Lord of all creatures,
7 Taking upon me mine own nature, I arise by my own power.
7 For whenever, O son of Bharata, there is decay of righteousness
8 And a rising up of unrighteousness, then I create myself,
8 For the protecting of the good and for the destroying of
evil-doers,
And for the establishing of righteousness I arise from age
to age."

"Somewhat similar are the avatars of Vishnu, who becomes incarnate in a portion of his essence on ten occasions to deliver mankind from certain great dangers. Krishna himself is usually regarded as one of these avatars." This we may consider as one of the striking parallels which meet us in other religions to that "hope of the advent of an ideal king which was one of the features of that larger hope of the salvation of Israel from all evils, the realization of perfect reconciliation with Jehovah and the felicity of the righteous in Him," to which reference was made in an early portion of this article and which constitutes the essential meaning of Messiahship. The form in which the Indian conception presents itself in the above quoted lines is more closely analogous amid many differences to the later and apocalyptic type of the Messianic idea as it appears in Judaism.

The interesting parallels between the Babylonian Marduk (Merodach) god of light and Christ as a world saviour are ingeniously set forth by Zimmern in *K.A.T.*, 3rd ed., pp. 376-391, but the total impression which they leave is vague.

It would carry us too far to consider in this place the details of the Jewish conception of the Messiah and the Messianic times as they appear in the later apocalypses or in Talmudic theology. See for the former the excellent summary of Schürer, *Geschichte des jüdischen Volkes im Zeitalter Jesu Christi*, 3rd ed., vol. ii, pp. 497-556. See also Weber, *Jüdische Theologie*, ch. xxiii. For the whole subject see also Drummond, *The Jewish Messiah*, and Kuonen, *Religion of Israel*, ch. xii. For the Messianic hopes of the Pharisees and the *Psalter of Solomon* see especially Wellhausen, *Pharisäer und Sadducäer* (Greifswald, 1874). In its ultimate form the Messianic hope of the Jews is the centre of the whole eschatology, embracing the doctrine of the last troubles of Israel (called by the Rabbins the "birth pangs of the Messiah"), the appearing of the anointed king, the annihilation of the hostile enemy, the return of the dispersed of Israel, the glory and world-sovereignty of the elect, the new world, the resurrection of the dead and the last judgment. But even the final form of Jewish theology shows much vacillation as to these details, especially as regards their sequence and mutual relation, thus betraying the inadequacy of the harmonistic method by which they were derived from the Old Testament and the stormy excitement in which the Messianic idea was developed. It is, for example, an open question among the Rabbins whether the days of the Messiah belong to the old or to the new world (1797 or 1797), whether the resurrection embraces all men or only the righteous, whether it precedes or follows the Messianic age. Compare MILLENNIUM.

We must also pass over the very important questions that arise as to the gradual extrication of the New Testament idea of the

Christ from the elements of Jewish political doctrine which had so strong a hold of many of the first disciples—the relation, for example, of the New Testament Apocalypse to contemporary Jewish thought. A word, however, is necessary as to the Rabbinical doctrine of the Messiah who suffers and dies for Israel, the Messiah son of Joseph or son of Ephraim, who in Jewish theology is distinguished from and subordinate to the victorious son of David. The developed form of this idea is almost certainly a product of the polemic with Christianity, in which the Rabbins were hard pressed by arguments from passages (especially Isa. liii.) which their own exegesis admitted to be Messianic, though it did not accept the Christian inferences as to the atoning death of the Messianic king. That the Jews in the time of Christ believed in a suffering and atoning Messiah is, to say the least, unproved and highly improbable. See, besides the books above cited, De Wette, *Opuscula*; Wünsche, *Die Leiden des Messias* (1870).

See the articles on "Messiah" in Hastings's *D. B.* (together with Fairweather's art. "Development of Doctrine," in extra vol., pp. 295-305) and in *Encyc. Bibl.* Also *P.R.E.*, 3rd ed., as well as Hastings's *Dict. of Christ and the Gospels*, should be consulted. Comp. Ederheim, *Life and Times of Jesus the Messiah*, 2nd ed., i. 160-179, ii. 434 sqq., 710-741; Stanton, *The Jewish and the Christian Messiah* (1886); Wendt, *Teaching of Jesus*, i. 60-84, 176-181, ii. 122-139; Holtzmann, *N. T. Theologie* (1897), pp. 81-85, 234-304; Baldensperger, *Das Selbstbewusstsein Jesu*; Wellhausen, *Israel. u. jüd. Geschichte* (1895), pp. 198-204; Charles's *Book of Enoch and Apocalypse of Baruch* (especially the introductions); Bousset, *Religion des Judentums*, 2nd ed., pp. 245-277; Volz, *Lehrbuch Eschatologie von Daniel bis A. 70*, pp. 15-68, 213-237; Schürer, *Die jüdische u. arabisch-jüdische Messias*; Gressmann, *Ursprung der israelitisch-jüdischen Eschatologie*, pp. 250-345. A fuller survey of literature will be found in Schürer, *op. cit.*, p. 496 sqq. (W. R. S.; O. C. W.)

MESSINA, a city of Sicily, 7 m. S.S.W. of the promontory of Faro (anc. *Promontorium Pelorum*), which forms the north-eastern angle of the island, the capital of the province of Messina and the seat of an archbishop. Pop. (1850), 97,074; (1881), 126,497; (1901), 149,778; (1905), 158,812. The site of the town curves round the harbour, between it and the strongly fortified hills of Antennamare, the highest point of which is 3707 ft. The straits, which take their name from the town, are here about 3½ m. wide, and only a little over 2 m. at the promontory of Faro. The numerous earthquakes from which the city had suffered, notably that in 1783, had left it few remains of antiquity. But it was a flourishing and beautiful city when in 1908 one of the most disastrous earthquakes ever recorded destroyed it totally. The earthquake occurred early in the morning of December 28, and so far as Messina was concerned the damage was done chiefly by the shock and by the fires which broke out afterwards; the seismic wave which followed was comparatively innocuous. But it did vast damage elsewhere along the strait, notably at Reggio, Calabria, which was also totally destroyed. Many other smaller towns suffered both in Sicily and in Calabria; the loss of life was appalling and the distress widespread, in spite of the prompt assistance rendered by Italian naval and military forces and by the crews of British, Russian and German warships and other vessels, and the contribution of funds for relief works from every part of the world. The immediate seismic focus appeared to be in the straits, but Dr E. Suess pointed out that it was surrounded by a curved line of earth-fracture, following an arc drawn from a centre in the Lipari Islands, from Catanzaro to Etna, and so westward; within this arc he held that the crust of the earth is gradually sinking, and is in an unstable condition. According to an official estimate the earthquake caused the loss of 77,283 lives.¹ (See also EARTHQUAKE.)

The façades of buildings at Messina in great part withstood the earthquake, but even when they did so the remainder of the buildings was destroyed. The cathedral, which was completely wrecked, was begun in 1098 and finished by Roger II. It had a fine Gothic façade: the interior had mosaics in the apses dating from 1330, and the nave contained 26 granite columns, said to have been brought from a temple of Poseidon near Faro, and had a fine wooden roof of 1260. The rest of the edifice was in the baroque style; the high altar (containing the supposed letter of the Virgin Mary to the people of Messina), richly decorated with marbles, lapis lazuli, &c., was begun in 1628 and completed in 1726. The impotence of Messina was almost entirely due to its

¹ See S. Franchi, "Il Terremoto . . . a Messina . . ." in *Boll. R. Comit. geologico d'Italia*, 4th series, vol. x. (1909).

harbour, a circular basin open on the north only, formed by a strip of land curving round like a sickle, from which it took its original name, Zancle (ζάγκλον, or rather δάγκλον, the Sicilian equivalent of the Greek δρέπανον,¹ according to Thucydides, vi. 4).

Zancle was first founded, no doubt on the site of an earlier settlement, by pirates from Cumae, and again more regularly settled, after an unknown interval, by settlers from Cumae under Perieres, and from Chalcis under Crataemenes, in the first quarter of the 8th century B.C. Mylae must have been occupied as an outpost very soon afterwards, but the first regular colony of Zancle was Himera, founded in 648 B.C. After the capture of Miletus by the Persians in 494 B.C. Skythes, king of Zancle, invited the Ionians to come and settle at Καλή 'Ακρόη, then in the occupation of the Sicels (the modern Marina di Catania, 25 m. east of Cefalù); but at the invitation of Anaxilas of Regium the Samians proceeded instead to the latter place. About 488 B.C. Anaxilas and the Samians occupied Zancle in the absence of Skythes, and it was then that the name was changed to Messene, as the existence of coins of the Samian type, bearing the new name, proves. About 480, however, Anaxilas thoroughly established his authority at Messene, and the types of coinage introduced by him persevere down to about 306 B.C.,² when Anaxilas himself zealously supported his son-in-law Terillus in inviting the Carthaginians' invasion of 480 B.C. In 426 the Athenians gained the alliance of Zancle, but soon lost it again, and failed to obtain it in 415.

Messina fell into the hands of the Carthaginians during their wars with Dionysius the elder of Syracuse (397 B.C.). The Carthaginians destroyed the city, but Dionysius recaptured and rebuilt it. During the next fifty years Messina changed masters several times, till Timoleon finally expelled the Carthaginians in 343 B.C. In the wars between Agathocles of Syracuse and Carthage, Messina took the side of the Carthaginians. After Agathocles' death, his mercenaries, the Mamertines, treacherously seized the town about 282 B.C. and held it. They came to war with Hiero II. of Syracuse and appealed for help to Rome, which was granted, and this led to a collision between Rome and Carthage, which ended in the First Punic War. Messina was almost at once taken by Rome. At the close of the war, in 241 B.C., Messina became a free and allied city (*civitas foederata*), and obtained Roman citizenship before the rest of Sicily, probably from Caesar himself. During the civil wars which followed the death of Caesar, Messina held with Sextus Pompeius; and in 35 B.C. it was sacked by Octavian's troops. After Octavian's proclamation as emperor he founded a colony here; and Messina continued to flourish as a trading port. In the division of the Roman empire it belonged to the emperors of the East; and in A.D. 547 Belisarius collected his fleet here before crossing into Calabria. The Saracens took the city in A.D. 831; and in 1061 it was the first permanent conquest made in Sicily by the Normans. In 1190 Richard I. of England, with his crusaders, passed six months in Messina. He quarrelled with Tancred, the last of the Hauteville dynasty, and sacked the town. In 1194 the city, with the rest of Sicily, passed to the house of Hohenstaufen under the emperor Henry VI., who died there in 1197; and after the fall of the Hohenstaufen was contended for by Peter I., king of Aragon, and Charles I., count of Anjou. At the time of the Sicilian Vespers (1282), which drove the French out of Sicily, Messina bravely defended itself against Charles of Anjou, and repulsed his attack. Peter I., through his commander Ruggiero di Loria, defeated the French off the Faro; and from 1282 to 1713 Messina remained a possession of the Spanish royal house. In 1571 the fleet fitted out by the Holy League against the Turk assembled at Messina, and in the same year its commander, Don John of Austria, celebrated a triumph in the city for his victory at Lepanto. Don John's statue stands in the Piazza dell' Annunziata. For one hundred years, thanks to the favours and

the concessions of Charles V., Messina enjoyed great prosperity. But the internal quarrels between the Merli, or aristocratic faction, and the Malvezzi, or democratic faction, fomented as they were by the Spaniards, helped to ruin the city (1671-1678). The Messinians suspected the Spanish court of a desire to destroy the ancient senatorial constitution of the city, and sent to France to ask the aid of Louis XIV. in their resistance. Louis despatched a fleet into Sicilian waters, and the French occupied the city. The Spaniards replied by appealing to Holland, who sent a fleet under Ruyter into the Mediterranean. In 1676 the French admiral, Abraham Duquesne, defeated the combined fleet of Spain and Holland; but, notwithstanding this victory, the French suddenly abandoned Messina in 1678, and the Spanish occupied the town once more. The senate was suppressed, and Messina lost its privileges. This was fatal to the importance of the city. In 1743 the plague carried off 40,000 inhabitants. The city was partially destroyed by earthquake in 1783. During the revolution of 1848 against the Bourbons of Naples, Messina was bombarded for three consecutive days. In 1854 the deaths from cholera numbered about 15,000. Garibaldi landed in Sicily in 1860, and Messina was the last city in the island taken from the Bourbons and made a part of united Italy under Victor Emmanuel.

Messina was the birthplace of Dicaearchus, the historian (c. 322 B.C.); Aristocles, the Peripatetic; Eudemus, the rationalist (c. 316 B.C.); Stefano Protonotario, Mazzeo di Ricco and Tommaso di Sasso, poets of the court of Frederick II. (A.D. 1250); and Antonello da Messina, the painter (1447-1499), of whose works one is preserved in the museum. During the 15th century the grammarian, Constantine Lascaris, taught in Messina; and Bessarion was for a time archimandrite there. (T. As.)

MESSAGE (from Anglo-French *message*, probably a corruption of *message, ménage*, popular Lat. *mansionaticum*, from *mansio*, whence mod. Fr. *maison*, from *manere*, to dwell), in law, a term equivalent to a dwelling-house, and including out-buildings, orchard, curtilage or court-yard and garden. At one time "message" is supposed to have had a more extensive meaning than that comprised in the word "house," but such distinction, if it ever existed, no longer survives.

MESTIZO (adopted from the Spanish, the Portuguese form being *mestiço*, from Lat. *miscere*, to mix), a term originally meaning a half-breed, one of whose parents was Spanish, and now used occasionally of any half-breed, but especially to denote persons of mixed Spanish (or Portuguese) and American Indian blood. The offspring of such half-breeds are also called *mestizoes*. The feminine form is *mestiza*.

MESUREUR, GUSTAVE EMIL EUGÈNE (1847-), French politician, was born at Marcq-en-Bareuil (Nord) on the 2nd of April 1847. He worked as a designer in Paris, and became prominent as a member of the municipal council of Paris, rousing much angry discussion by a proposal to rename the Parisian streets which bore saints' names. In 1887 he became president of the council. The same year he entered the Chamber of Deputies, taking his place with the extreme left. He joined the L. Bourgeois ministry of 1895-1896 as minister of commerce, industry, post and telegraphs, was vice-president of the Chamber from 1898 to 1902, and presided over the Budget Commission of 1899, 1901 and 1902. He was defeated at the polls in 1902, but became director of the Assistance Publique. His wife, Amélie de Wailly (b. 1853), is well known as a writer of light verse and of some charming children's books.

META, the Latin word for the goal which formed the turning-point for the chariot races in the Roman circus. The metae consisted of three conical pillars resting on a single podium. None have been preserved, but they are shown on coins, gems and terra-cotta bas-reliefs.

METABOLIC DISEASES. All disease is primarily due to alterations (Gr. *μεταβολή*, change), quantitative or qualitative, in the chemical changes in the protoplasm of some or all of the tissues of the body. But while in some pathological states these modifications lead to structural changes, in others they do not produce gross lesions, and these latter conditions are commonly classified as Functional Diseases. When such

¹ From this word Trapani derives its name.

² This account is at variance with the literary evidence and rests on that of the coins, as set forth by I. H. Dodd in *Journal of Hellenic Studies*, xxviii. (1908) 56 sqq.

functional disturbances affect the general nutrition of the body they have been termed Metabolic Diseases (*Stoffwechselskrankheiten*). It is impossible to draw a hard and fast line between functional and organic disease, since the one passes gradually into the other, as is well seen in gout. Nor is it always easy to decide how far the conditions are due merely to quantitative alterations in the metabolism and how far to actual qualitative changes, for it is highly probable that many of the apparently qualitative alterations are really quantitative disturbances in one part of the protoplasmic mechanism, leading to an apparent qualitative change in the total result of the activity.

Obesity.—It is as fat that the surplus food absorbed is stored in the body; but the power of storing fat varies enormously in different individuals, and in some it may be considered pathological. The reasons of this are very imperfectly understood. One undoubted cause of obesity is taking a supply of food in excess of the energy requirements of the individual. The amount of food may be absolutely large, or large relatively to the muscular energy evolved in mechanical work or in heat-production; but in either case, when fat begins to be deposited, the muscular activity of the body tends to diminish and the loss of heat from the surface is reduced; and thus the energy requirements become less, and a smaller diet is sufficient to yield the surplus for further storage of fat. Fat is formed from carbohydrates, and possibly indirectly from proteids (see *ΝΥΤΚΤΙΟΝ*). Individuals probably vary in their mode of dealing with these substances, some having the tendency to convert them to fat, some to burn them off at once. Carl von Noorden, however, who has studied the metabolism in cases of obesity, finds no marked departure from the normal. It may be that in some persons there is a very perfect absorption of food, but so far no scientific evidence for this view is forthcoming. In all cases the fat stored is available as a source of energy, and this circumstance is taken advantage of in the various fat "cures," which consist in giving a diet containing enough proteids to cover the requirements of the body, with a supply of fats and carbohydrates insufficient to meet the energy requirements of the individual. This is illustrated by the dietaries of some of the best known of these "cures":—

	In Grms. per Diem.			
	Proteid.	Fat.	Carbo- hydrates.	Calories.
Banting's cure . . .	172	8	81	1112
Oertel's	156-170	25-45	75-120	1180-1608
Ebstein's "	102	85	47	1401

In a normal individual in moderate muscular activity about 3000 Calories per diem are required (see *DIETETICS*), and therefore under the diets of these "cures," especially when accompanied by a proper amount of muscular exercise, the fats stored in the body are rapidly used up.

Diabetes, as distinguished from transitory glycosuria, is produced by a diminution in the power of the tissues to use sugar, which thus accumulates in the blood and escapes in the urine. One great source of energy being unavailable, the tissues have to use more fats and more proteids to procure the necessary energy, and hence, unless these are supplied in very large quantities, there is a tendency to emaciation.

The power of storing and using sugar in the tissues is strictly limited, and varies considerably in healthy individuals. Normally, when about 200 grms. of glucose are taken at one time, some of it appears in the urine within one hour. In some individuals the taking of even 100 grms. leads to a transient glycosuria, while others can take 250 grms. or more and use it all. But even in the same healthy individual the power of using sugar varies at different times and in different conditions, muscular exercise markedly increasing the combustion. Again, some sugars are more readily used than others, and therefore have a less tendency to appear in the urine when taken in the food. Milk-sugar and lactulose appear in the urine more readily than glucose. This power of using sugar possessed by an individual may depend to a

small extent on the capacity of the liver to store as glycogen any excess of carbohydrates absorbed from the food, and some slight cases of transient glycosuria may be accounted for by a diminution of this capacity. But the typical form of diabetes cannot be thus explained. It has been maintained that increased production of sugar is a cause of some cases of the disease, and this view has been supported by Claude Bernard's classical experiment of producing glycosuria by puncturing the floor of the fourth ventricle in the brain of the rabbit. But after such puncture the glycosuria occurs only when glycogen is present in the liver. It is transient and has nothing to do with true diabetes. The fact that various toxic substances, e.g. carbon monoxide, produce glycosuria has been used as an argument in support of this view, but they too seem to act by causing a conversion of glycogen to glucose, and are effective only when the liver is charged with the former substance. At one time it was thought that the occurrence of glycosuria under the administration of phloridzin proved that diabetes is due to a poison. But the fact that, while sugar appears abundantly in the urine under phloridzin, it is not increased in the blood, shows that the drug acts not by diminishing the power of the tissues to use sugar, but by increasing the excretion of sugar through the kidneys and thus causing its loss to the body. Hence the tissues have to fall back upon the proteids, and an increased excretion of nitrogen is produced. This, however, is a totally different condition from diabetes.

Anything which produces a marked diminution in the normally limited power of the tissues to use sugar will cause the disease in a lighter or graver form. As age advances the activity of the various metabolic processes may diminish irregularly in certain individuals, and it is possible that the loss of the power of using sugar may be sooner impaired in some than in others, and thus diabetes be produced. But Minkowski and von Mering have demonstrated, by experiments upon animals, that pathological changes in the pancreas have probably a causal relationship with the disease. They found that excision of that organ in dogs, &c., produced all the symptoms of diabetes—the appearances of sugar in the urine, its increased amount in the blood, the rapid breaking-down of proteids, and the resulting emaciation and azoturia. At the same time the absorption from the intestine of proteids, fats and carbohydrates was diminished. How this pancreatic diabetes is produced has not been explained. It has been suggested that the pancreas forms an internal secretion which stimulates the utilization of sugar in the tissues. Though in a certain number of cases of diabetes disease of the pancreas has been found, other cases are recorded where grave disease of that organ has not produced this condition. But the apparent extent of a lesion is often no measure of the depth to which the functions of the structure in which it is situated are altered, and it is very possible that the functions of the pancreas may in many cases be profoundly modified without our methods of research being able to detect the change. The pancreas consists of two parts, the secreting structure and the epithelial islets, and one or other of these may be more specially involved, and thus alteration in digestion and absorption on the one hand, and changes in the utilization of carbohydrates on the other, may be separately produced. The subcutaneous injection of large doses of extracts of the supra-renal bodies causes glycosuria and an increase of sugar in the blood, but the relationship of this condition to diabetes has not yet been investigated.

The disease may be divided into two forms:—

1. *Slight Cases.*—The individual can use small quantities of sugar, but the taking of larger amounts causes glycosuria. Supposing that the energy requirements of an individual are met by a diet of—

Proteid	100 grms.	410 Calories.
Fat	100 "	930 "
Carbohydrate	400 "	1640 "

2980

then if only 100 grms. of glucose can be used, the energy value of 300 grms., i.e. 1230 Calories, must be supplied from proteids and fats. To yield this, 300 grms. of proteids or 132 grms. of fats would be required. If these are not forthcoming in the diet, they must

be supplied from the tissues, and the individual will become emaciated; hence a diabetic on an ordinary diet is badly nourished, and hence the huge appetite characteristic of the disease.

2. *Grave Cases.*—From the products of the splitting of proteins sugar can be formed, probably in the liver, and in the more serious form of the disease, even when carbohydrates are excluded from the food, a greater or lesser quantity of the sugar thus formed escapes consumption and may be excreted. Theoretically, 100 grms. of protein can yield 113.6 grms. of glucose, i.e. 1 gm. of nitrogen will be set free for each 7.5 grms. of glucose formed. In the urine of grave cases of diabetes on a proteid diet, the proportion of nitrogen to sugar is about 1 to 2. This may mean that the theoretically possible amount of sugar is not yielded, or that some of the sugar formed is used in the economy. Both hypotheses may be correct, but the latter is supported by the fact that even in grave cases the decomposition of proteid may be diminished by giving sugar, and that in muscular exercise the proportion of sugar may fall.

In the course of the disease the amount of sugar which the tissues can use varies from day to day. It is in the utilization of glucose—the normal sugar of the body—that the tissues chiefly fail. Many diabetics are able to use laevulose, or the inulin from which it is derived, and lactose (milk-sugar) to a certain extent. It has, however, been observed that under the administration of these sugars the excretion of glucose may be increased, the tissues, apparently by using the foreign sugar, allowing part of the glucose which they would have consumed to escape.

The increased decomposition of proteid, rendered necessary to supply the energy not forthcoming in the star, leads to the appearance of a large quantity of nitrogen in the urine—*azoturia*—and it also leads to the formation of various acids. Sulphuric acid and phosphoric acid are formed by oxidation of the sulphur and phosphorus in the proteid molecule. Organic acids of the lower fatty acid series β oxybutyric and aceto-acetic acid with their derivative acetone also appear in the course of diabetes. They are in part formed from the disintegration of proteins and in part from fats, as the result of a modified metabolism induced by the withdrawal of carbohydrates. To neutralize them ammonia is developed, and hence the proportion of ammonia in the urine is increased. By the development of these various acids the alkalinity of the blood is diminished. The development of these acids in large quantities is associated with extensive decomposition of proteid, and is sometimes indicative of the onset of a comatose condition, which seems to be due rather to an acid intoxication than to the special toxic action of any particular acid.

Myxoedema.—The thyroid gland forms a material which has the power of increasing the metabolism of proteins and of fats; and when the thyroid is removed, a condition of sluggish metabolism, with low temperature and a return of the connective tissues to an embryonic condition, supervenes, accompanied by the appearance of depression of the mental functions and by other nervous symptoms. The disease myxoedema, which was first described by Sir William Gull in 1873, was shown by Ord in 1878 to be due to degenerative changes in the thyroid gland. It affects both sexes, but chiefly females, and is characterized by a peculiar puffy appearance of the face and hands, shedding of the hair, a low temperature, and mental hebetude. The symptoms are similar to those produced by removal of the thyroid, and are indicative of a condition of diminished activity of metabolism. The nervous symptoms may be in part due to some alteration in the metabolism, leading to the formation of toxic substances. The administration of thyroid gland extract causes all the symptoms to disappear.

Cretinism may now be defined as myxoedema in the infant, and it has been definitely proved to be associated with non-development or degeneration of the thyroid gland. The characters of the disease are all due to diminished metabolism, leading to retarded development, and the treatment which has proved of service, at least in some sporadic cases, is the administration of various thyroid preparations.

Ophthalmic Goitre—Graves's Disease or Basedow's Disease.—This disease chiefly affects young women, and is characterized by three main symptoms: increased rate and force of the heart's action, protrusion of the eyeballs, and enlargement of the thyroid gland. The patient is nervous, often sleepless, and generally becomes emaciated and suffers from slight febrile attacks. The increased action of the heart is the most constant symptom, and the enlargement of the thyroid gland may not be manifest. Various theories as to the pathology of the condition have been advanced, but in the light of our knowledge of the physiology of the thyroid the most probable explanation is an increased functional activity of that gland or of changes in the parathyroids.

Gout has often been divided into the typical and atypical forms. The first is undoubtedly a clinical and pathological entity, but the second, though containing cases of less severe forms of true gout, is largely constituted of imperfectly diagnosed morbid conditions. The accumulation of urate of soda in the tissues in gout formerly led physicians to believe in a causal relationship between an increased formation of that substance and the onset of the disease. Sir A. Garrod's investigations, however, seemed to indicate that diminished excretion rather than increased production is the cause of the condition. He found an accumulation of uric acid in the blood and a diminution in its amount in the urine during the attack. That uric acid is increased in the blood is undoubted, but the changes described by Garrod in the urine, and considered by him as indicative of diminished excretion and retention, are rendered of less value by the imperfections of the analytic method employed. More recent work with better methods has thrown still further doubt upon the existence of such a relationship, and points rather to the accumulation of uric acid being, like the other symptoms of the condition, a result of some unknown modification in the metabolism, and a purely secondary phenomenon. The important fact that in leucaemia (von Jaksch), in lead-poisoning (Garrod), and in other pathological conditions, uric acid may be increased in the blood and in the urine without any gouty symptoms supervening, is one of the strongest arguments against the older views. That the gouty inflammation is not caused by the deposit of urate of soda, seems to be indicated by the occurrence of cases in which there is no such deposition. The source of the uric acid which is so widely deposited in the gouty is largely the phosphorus containing nucleins of the food and tissues. These in their decomposition yield a series of di-urides, the purin bodies, of which uric acid is one. Their excretion is increased when substances rich in nuclein, e.g. sweetbreads, &c., are administered. While uric acid itself has not been demonstrated to have any injurious action, the closely allied adenin has been found to produce toxic symptoms. After the discovery of this source of uric acid, physiologists for a time inclined to regard it as the only mode of production. But it must be remembered that in birds uric acid is formed from the ammonia compounds coming from the intestine and muscles, just as urea is formed from the same substance in mammals. Uric acid is a di-uride—a body composed of two urea molecules linked by acrylic acid—an unsaturated propionic acid. It is therefore highly probable that in many conditions the conversion of ammonia compounds to urea is not complete, and that a certain amount of uric acid is formed apart from the decomposition of nucleins.

Sir William Roberts has adduced evidence to show that uric acid circulates in the blood in a freely soluble combination or quadrate—that is, a compound in which one molecule of an acid salt BH_2U is linked to a molecule of the acid BH_2U . These compounds are said to be readily decomposed and the bi-urates formed, which are at first gelatinous but become crystalline. The deposition of urate of soda in joints, &c., has been ascribed to this change. Francis Tunnicliffe, however, has published the results of certain investigations which throw doubt upon this explanation. The most recent investigations on the metabolism of the gouty have shown that there is undoubtedly a slowing in the rate of elimination of uric acid and also of the total nitrogen of the urine with occasional sudden increases sometimes connected with a gouty paroxysm, sometimes independent of it. Whether this is due to the action of some toxin developed in the body or is caused by a constitutional renal inadequacy is difficult to decide. Certain it is these renal diseases often develop in the course of gout.

Rheumatism.—Rheumatic fever was formerly regarded as due to some disturbance in the metabolism, but it is now known to be a specific micro-organismal disease. The whole clinical picture is that of an infective fever, and it is closely related to gonorrhoeal rheumatism and to certain types of pyaemia. A number of independent observers have succeeded in isolating from cases of rheumatic fever a diplococcus which produces similar

symptoms in the rabbit to those which characterize the disease in man.

Excluding the peculiar changes in the joints which occur in *rheumatoid arthritis* and in *Charcot's disease*, and which are almost certainly primary affections of the nervous system, it is found that a large number of individuals suffer from pain in the joints, in the muscles, and in the fibrous tissues, chiefly on exposure to cold and damp or after indiscretions of diet. This so-called *chronic rheumatism* appears to be a totally distinct condition from rheumatic fever; and although its pathology is not determined, it looks as if it were due either to a diminished diminution or an increased production of some toxic substance or substances, but so far we have no evidence as to their nature.

Rickets is undoubtedly a manifestation of a profound alteration of the metabolism in childhood, but how far it is an idiopathic condition and how far a result of the action of toxins introduced from without is not yet definitely known. Kassowitz long ago showed that the bone changes are similar to those which can be produced in animals by chronic phosphorus poisoning, and that they are really irritative in nature. Spillmann, in his work *Le Rachitisme*, discusses the evidence as regards the action of various conditions, and comes to the conclusion that there is no evidence that it is due to a mere primary disturbance of the metabolism, or to excessive production of lactic acid, or to any specific micro-organismal poisoning. But he adduces evidence, perhaps not very convincing, that in the disease there is a specific intoxication derived from the alimentary canal and provoking inflammatory lesions in the bones.

See generally Carl von Noorden, *Metabolism and Practical Medicine* (1907). (D. N. P.)

METABOLISM (from Gr. *μεταβολή*, change), the biological term for the process of chemical change in a living cell (see **PHYSIOLOGY**).

METAL (through Fr. from Lat. *metallum*, mine, quarry, adapted from Gr. *μέταλλον*, in the same sense, probably connected with *μετάλλω*, to search after, explore, *μετά*, after, *ἄλλω*, other). Originally applied to gold, silver, copper, iron, tin, lead and bronze, *i.e.* substances having high specific gravity, malleability, opacity, and especially a peculiar lustre, the term "metal" became generic for all substances with these properties. In modern chemistry, however, the metals are a division of the elements, the members of which may or may not possess all these characters. The progress of science has, in fact, been accompanied by the discovery of some 70 elements, which may be arranged in order of their "metallic" properties as above indicated, and it is found that while the end members of the scale are most distinctly metallic (or non-metallic), certain central members, *e.g.* arsenic, may be placed in either division, their properties approximating to both metallic and non-metallic. One chemical differentia utilizes the fact that metals always form at least one basic oxide which yields salts with acids, while non-metals usually form acidic oxides, *i.e.* oxides which yield acids with water. This definition, however, is highly artificial and objectionable on principle, because when we speak of metals we think, not of their chemical relations, but of a certain sum of mechanical and physical properties which unites them all into one natural family.

All metals, when exposed in an inert atmosphere to a sufficient temperature, assume the form of liquids, which all present the following characteristic properties. They are (at least practically) non-transparent; they reflect light in a peculiar manner, producing what is called "metallic lustre." When kept in non-metallic vessels they take the shape of a convex meniscus. These liquids, when exposed to higher temperatures, some sooner than others, pass into vapours. What these vapours are like is not known in many cases, since, as a rule, they can be produced only at very high temperatures, precluding the use of transparent vessels. Silver vapour is blue, potassium vapour is green, many others (mercury vapour, for instance) are colourless. The liquid metals, when cooled down sufficiently, some at lower, others at higher, temperatures freeze into compact solids, endowed with the (relative) non-transparency and the lustre of their liquids. These

frozen metals in general form compact masses consisting of aggregates of crystals belonging to the regular or rhombic or (more rarely) the quadratic system. Compared with non-metallic solids, they in general are good conductors of heat and of electricity. But their most characteristic, though not perhaps their most general, property is that they combine in themselves the apparently incompatible properties of elasticity and rigidity on the one hand and plasticity on the other. To this remarkable combination of properties more than to anything else the ordinary metals owe their wide application in the mechanical arts. In former times a high specific gravity used to be quoted as one of the characters of the genus; but this no longer holds, since we now know a series of metals lighter than water.

Non-Transparency.—This, in the case of even the solid metals, is perhaps only a very low degree of transparency. In regard to gold this has been proved to be so; gold leaf, or thin films of gold produced chemically on glass plates, transmit light with a green colour. On the other hand, infinitely thin films of silver which can be produced chemically on glass surfaces are absolutely opaque. Very thin films of liquid mercury, according to Melsens, transmit light with a violet-blue colour; also thin films of copper are said to be translucent.

Colour.—Gold is yellow; copper is red; silver, tin, and some others are pure white; the majority are greyish.

Reflection of Light.—Polished metallic surfaces, like those of other solids, divide any incident ray into two parts, of which one is refracted while the other is reflected—with this difference, however, that the former is completely absorbed, and that the latter, in regard to polarization, is quite differently affected. The following values are due to Rubens and Hagen (*Ann. der Phys.*, 1900, p. 352); they express the percentage of incident light reflected. The superiority of silver is obvious.

Name of Metal.	Violet.	Yellow.	Red.
	$\lambda = 450$	$\lambda = 550$	$\lambda = 650$
Silver	90.6	92.5	93.6
Platinum	55.8	61.1	66.3
Nickel	58.5	62.6	65.9
Steel	58.6	59.4	60.1
Gold	36.8	74.7	88.2
Copper	48.8	59.5	89
Glass backed with silver	79.3-85.7	82-88	83-89
Glass backed with mercury	72.8	71.2	71.5

Crystalline Form and Structure.—Most (perhaps all) metals are capable of crystallization. The crystals belong to the following systems: *regular system*—silver, gold, palladium, mercury, copper, iron, lead; *quadratic system*—tin, potassium; *rhombic system*—antimony, bismuth, tellurium, zinc, magnesium. Perhaps all metals are crystalline, only the degree of visibility of the crystalline arrangement is very different in different metals, and even in the same metal varies according to the slowness of solidification and other circumstances.

Antimony, bismuth and zinc exhibit a very distinct crystalline structure: a bar-shaped ingot readily breaks, and the crystal faces are distinctly visible on the fracture. Tin also is crystalline: a thin bar, when bent, "creaks" audibly from the sliding of the crystal faces over one another; but the bar is not easily broken, and exhibits an apparently non-crystalline fracture.—Class I.

Gold, silver, copper, lead, aluminium, cadmium, iron (pure), nickel and cobalt are practically amorphous, the crystals (where they exist) being so closely packed as to produce a virtually homogeneous mass.—Class II.

The great contrast in apparent structure between cooled ingots of Class I. and of Class II. appears to be owing chiefly to the fact that, while the latter crystallize in the regular system, metals of Class I. form rhombic or quadratic crystals. Regular crystals expand equally in all directions; rhombic and quadratic expand differently in different directions. Hence, supposing the crystals immediately after their formation to be in absolute contact with one another all round, then, in the case of Class II., such contact will be maintained on cooling, while in the case of Class I. the contraction along a given straight line will in general have different values in any two neighbouring crystals, and the crystals consequently become slightly detached from one another. The crystalline structure which exists on both sides becomes visible only in the metals of the first class, and only three manifest itself as brittleness.

Closely related to the structure of metals is their degree of "plasticity" (susceptibility of being constrained into new forms without breach of continuity). This term of course includes as special cases the qualities of "malleability" (capability of being flattened out under the hammer) and "ductility" (capability of being drawn into wire); but these two special qualities do not always go parallel to each other, for this reason amongst others—that ductility in a higher degree than malleability is determined by the tenacity of a metal. Hence tin and lead, though very malleable, are little ductile. The quality of plasticity is developed to very different degrees in different metals, and even in the same species it depends on temperature, and may be modified by mechanical or physical operations.

A bar of zinc, for instance, as obtained by casting, is very brittle; but when heated to 100° or 150° C. it becomes sufficiently plastic to be rolled into the thinnest sheet or to be drawn into wire. Such sheet or wire then remains flexible after cooling, the originally only loosely cohering crystals having got intertwisted and forced into absolute contact with one another—an explanation supported by the fact that rolled zinc has a somewhat higher specific gravity (7.2) than the original ingot (6.9). The same metal, when heated to 205° C., becomes so brittle that it can be powdered in a mortar. Pure iron, copper, silver and other metals are easily drawn into wire, or rolled into sheet, or flattened under the hammer. But all these operations render the metals harder, and detract from their plasticity; their original softness can be restored to them by "annealing," i.e. by heating them to redness and then quenching them in cold water. In the case of iron, however, this applies only if the metal is perfectly pure. If it contains a few parts of carbon per thousand, the annealing process, instead of softening the metal, gives it a "temper," meaning a higher degree of hardness and elasticity (see below).

What we have called plasticity must not be confused with the notion of a "softness," which means the degree of facility with which the plasticity of a metal can be discounted. Thus lead is far softer than silver, and yet the latter is by far the more plastic of the two. The famous experiments of H. E. Tresca show that the plasticity of certain metals at least goes considerably farther than had before been supposed.

He operated with lead, copper, silver, iron and some other metals. Round disks made of these substances were placed in a closely fitting cylindrical cavity drilled in a block of steel, the cavity having a circular aperture of two or four centimetres below. By an hydraulic press a pressure of 100,000 kilos was made to act upon the disks, when the metal was seen to "flow" out of the hole like a viscid liquid. In spite of the immense rearrangement of parts there was no breach of continuity. What came out below was a compact cylinder with a rounded bottom, consisting of so many layers superimposed upon one another. Parallel experiments with layers of dough or sand plus some connecting material proved that the particles in all cases moved along the same tracks as would be followed by a flowing cylinder of liquid. Of the better known metals potassium and sodium are the softest; they can be kneaded between the fingers like wax. After these follow first thallium and then lead, the latter being the softest of the metals used in the arts. Amongst these the softness decreases in about the following order: lead, pure silver, pure gold, tin, copper, aluminium, platinum, pure iron. As liquidity might be looked upon as the *ne plus ultra* of softness, this is the right place for stating that, while most metals, when heated up to their melting points, pass pretty abruptly from the solid to the liquid state, platinum and iron first assume, and throughout a long range of temperatures retain, a condition of viscous semi-solidity which enables two pieces of them to be "welded" together by pressure into one continuous mass.

According to Prechtl, the ordinary metals, in regard to the degree of facility or perfection with which they can be hammered flat on the anvil, rolled out into sheet, or drawn into wire, form the following descending series:—

<i>Hammering.</i>	<i>Rolling into Sheet.</i>	<i>Drawing into Wire.</i>
Lead.	Gold.	Platinum.
Tin.	Silver.	Silver.
Gold.	Copper.	Iron.
Zinc.	Tin.	Copper.
Silver.	Lead.	Gold.
Copper.	Zinc.	Zinc.
Platinum.	Platinum.	Tin.
Iron.	Iron.	Lead.

To give an idea of what can be done in this way, it may be stated that gold can be beaten out to leaf of the thickness of $\frac{3}{81000}$ mm.; and that platinum, by judicious work, can be drawn into wire $\frac{1}{10000}$ mm. thick.

By the "hardness" of a metal we mean the resistance which it offers to the file or engraver's tool. Taking it in this sense, it does not necessarily measure, e.g. the resistance of a metal to abrasion by friction. Thus, for instance, 10% aluminium bronze is scratched by an ordinary steel knife-blade, yet the sets of needles used for perforating postage stamps last longer if made of aluminium bronze than if made of steel.

Elasticity.—All metals are elastic to this extent that a change of form, brought about by stresses not exceeding certain limit values will disappear on the stress being removed. Strains exceeding the "limit of elasticity" result in permanent deformation or (if sufficiently great) in rupture. Referring the reader to the article ELASTICITY for the theoretical and to the STRENGTH OF MATERIALS for the practical aspects of this subject, we give here a table of the "modulus of elasticity," E (column 2), for millimetre and kilogramme. Hence 1000/E is the elongation in millimetres per metre length per kilo. Column 3 shows the change causing a permanent elongation of 0.05 mm. per metre, which, for practical purposes, Wertheim takes as the limit of elasticity; column 4 gives the breaking strain. These values may vary within certain limits for different specimens.

Name of Metal.	E.	For Wire of 1 sq. mm. Section, Weight (in Kilos) causing	
		Permanent Elongation of 0.05 mm.	Breakage.
Lead, drawn	1,803	0.25	2.1
" annealed	1,727	0.20	1.8
Tin, drawn	4,148	0.45	2.45
" annealed	1,700	0.20	
Cadmium	7,070		2.24
Gold, drawn	8,141	13.5	27
" annealed	5,585	3.0	10
Silver, drawn	7,357	11.3	29
" annealed	7,140	2.6	16
Zinc, pure, cast in mould.	9,021		
" ordinary, drawn	8,735	0.75	13
Palladium, drawn	11,759	18	
" annealed	9,709	under 5	27
Copper, drawn	12,449	12	40
" annealed	10,519	under 3	30
Platinum wire, medium thickness, drawn	17,003	26	34
Platinum, annealed	15,818	14	23
Iron, drawn	20,869	32	67
" annealed	20,794	under 5	41
Nickel, drawn	23,950		1/2 X 61
Aluminium	7,200		
" bronze	10,700		
Brass (ZnCu)	8,543		
German silver (Zn,Cu ₁₂ Ni ₄)	10,788		

Specific Gravity.—This varies in metals from .594 (lithium) to 22.48 (osmium), and in one and the same species is a function of temperature and of previous physical and mechanical treatment. It has in general one value for the powdery metal as obtained by reduction of the oxide in hydrogen below the melting point of the metal, another for the metal in the state which it assumes spontaneously on fretting, and this latter value, in general, is modified by hammering, rolling, drawing, &c. These mechanical operations do not necessarily add to the density; stamping, it is true, does so necessarily, but rolling or drawing occasionally causes a diminution of the density. Thus, for instance, chemically pure iron in the ingot has the specific gravity 7.844; when it is rolled out into thin sheet, the value falls to 7.6; when drawn into thin wire, to 7.75. The following table gives the specific gravities of many metals. Where special statements are not made, the numbers hold for the ordinary temperature (15° to 17° or 20° C.), referred to water of the same temperature as a standard, and to hold for the natural frozen metal.

Name of Metal.	Specific Gravity.
Lithium594
Potassium875
Sodium	1.978
Rubidium	1.52
Calcium	1.578
Magnesium	1.743
Caesium	1.88
Beryllium	2.1
Strontium	2.5
Aluminium, pure, ingot	2.583 at 4°
" ordinary, hammered	2.67

Name of Metal.	Specific Gravity.
Barium	3.75
Zirconium	4.15
Vanadium, powder	5.5
Gallium	5.95
Lanthanum	6.163
Cerium	6.68
Antimony	6.62
Chromium	6.50
Zinc, ingot	6.915
" rolled out	7.2
Manganese	7.39
Tin, cast	7.29 to 7.299
" crystallized by electrolysis from solutions	7.178
Indium	7.42
Iron, chemically pure, ingot	7.844
" thin sheet	7.6
" wrought, high quality	7.8 to 7.9
Nickel, ingot	8.279
" forged	8.666
Cadmium, ingot	8.546
" hammered	8.667
Cobalt	8.6
Molybdenum, containing 4 to 5% of carbon	8.6
Copper, native	8.94
" cast.	8.92
" wire or thin sheet	8.94 to 8.95
" electrolyte, pure	8.945
Bismuth	9.823 at 12°
Silver, cast	10.4 to 10.5
" stamped	10.57
Lead, very slowly frozen	11.254
" quickly frozen in cold water	11.363
Palladium	11.4 at 22.5°
Thallium	11.86
Rhodium	12.1
Ruthenium	12.26 at 0°
Mercury, liquid	13.595 at 0°
" solid	14.39 below -40°
Tungsten, compact, by H ₂ from chloride vapour	16.54
" as reduced by hydrogen, powder	19.13
Uranium	18.7
Gold, ingot	19.265 at 13°
" stamped	19.31 to 19.34
" powder, precipitated by ferrous sulphate	19.55 to 19.72
Platinum, pure	21.50
Iridium	22.2
Osmium	22.477

Thermal Properties.—The specific heats of most metals have been determined. The general result is that, conformably with Dulong and Petit's law, the "atomic heats" all come to very nearly the same value (of about 6.4); i.e. atomic weight by specific heat = 6.4. Thus we have for silver by theory $6.4/108 = .0593$, and by experiment .0570 for 10° to 100° C.

The expansion by heat varies greatly. The following table gives the linear expansions from 0° to 100° C. according to Fizeau (*Comptes rendus*, lxxviii. 1125), the length at 0° being taken as unity.

Name of Metal.	Expansion 0° to 100°.
Platinum, cast	.000 907
Gold, cast	.001 451
Silver, cast	.001 936
Copper, native, from Lake Superior	.001 708
" artificial	.001 869
Iron, soft, as used for electromagnets	.001 228
" reduced by hydrogen and compressed	.001 208
Cast steel, annealed	.001 110
Bismuth, in the direction of the axis	.001 642
" at right angles to axis	.001 239
" mean expansion, calculated	.001 374
Tin, of Malacca, compressed powder	.002 269
Lead, cast	.002 948
Zinc, distilled, compressed powder	.002 995
Cadmium, distilled, compressed powder	.003 102
Aluminium, cast	.002 336
Brass (71.5% copper, 28.5% zinc)	.001 879
Bronze (86.3% copper, 9.7% tin, 4.0% zinc)	.001 802

The coefficient of expansion is constant for such metals only as crystallize in the regular system; the others expand differently in the directions of the different axes. To eliminate this source of

uncertainty these metals were employed as compressed powders. The cubical expansion of mercury from 0° to 100° C. is .018153 = $\frac{18.153}{1000}$ (Regnault). (See THERMOMETRY.)

Fusibility and Volatility.—The fusibility in different metals is very different, as shown by the following table, which, besides including all the fusing points (in degrees C.) of metals which have been determined numerically, indicates those of a selection of other metals by the positions assigned to them in the table.

Name of Metal.	Melting Point.	Boiling Point.
Mercury	-38.8	
Cæsium	26-27	357.3
Gallium	30.1	
Rubidium	38.5	
Potassium	62.5	719-731
Sodium	95.6	861-954
Indium	155	
Lithium	180.0	
Tin	231.9	1450-1600
Bismuth	269.2	1090-1450
Thallium	290	
Cadmium	320.7	780
Lead	327.7	1450-1600
Zinc	419	929-954
<i>Incipient red heat</i>	525	
Antimony	629.5	
Magnesium	632.6	about 1100
Aluminium	655	
<i>Cherry red heat</i>	700	
Calcium	780	
Lanthanum	810	
Barium	850	
Silver	962	
Gold	1064	
Copper	1082	2100
<i>Yellow heat</i>	1100	
Iron	1300-1400	
Nickel	1427	
Cobalt	1800 (?)	
<i>Dazzling white heat</i>	1500-1600	
Palladium	1500	
Platinum	1760	
Rhodium	above Pt.	
Iridium	" 2200	
Ruthenium	" Ir.	
Tantalum	In electric furnace	
Osmium		

For practical purposes the volatility of metals may be stated as follows:—

1. Distillable below redness: mercury.
2. Distillable at red heats: cadmium, alkali metals, zinc, magnesium.
3. Volatilized more or less readily when heated beyond their fusing points in open crucibles: antimony (very readily), lead, bismuth, tin, silver.
4. Barely so: gold, (copper).
5. Practically non-volatile: (copper), iron, nickel, cobalt, aluminium; also lithium, barium, strontium and calcium.

In the oxyhydrogen flame silver boils, forming a blue vapour, while platinum volatilizes slowly, and osmium, though infusible, very readily.

Latent Heats of Liquefaction.—Of these we know little. The following numbers are due to Person—i.e. it may be stated, being 80.

Name of Metal.	Latent Heat.	Name of Metal.	Latent Heat.
Mercury	2.82	Cadmium	13.6
Lead	5.37	Silver	21.1
Bismuth	12.4	Zinc	28.1

The latent heat of vaporization of mercury was found by Marignac to be 103 to 106.

Conductivity.—Conductivity, whether thermic or electric, is very differently developed in different metals; and, as an exact knowledge of these conductivities is of great importance, much attention has been given to their numerical determination (see CONDUCTION, ELECTRIC, and CONDUCTION OF HEAT).

The following table gives the electric conductivities of a number of metals as determined by Matthiessen, and the relative internal thermal conductivities of (nominally) the same metals as determined by Wiedemann and Franz, with rods about 5 mm. thick, of which one end was kept at 100° C., the rest of the rod in a "vacuum" (of 5 mm. tension) at 12° C. Matthiessen's results, except in the two cases noted, are from his memoir in *Pogg. Ann.*, 1858, ciii. 428

Name of Metal.	Relative Conductivities.	
	Electric.	Thermic.
Copper, commercial, No. 3	.774 at 18-8°	
" " " " No. 2	.721 " 22-6	
" " chemically pure, hard drawn	.931 " "	
Copper, pure	.552 " 21-8	.748
Gold, pure	.731 " 19-0	.548
" " absolutely pure		
Brass		.25
Tin, pure	.115 " 21-0	.154
Bismuth wire	.144 " 20-4	
Iron rod		.101
Steel		.103
Lead, pure	.0777 " 17-3	.079
Platinum	.105 " 20-7	.094
German silver	.0767 " 18-7	.073
Bismuth	.1019 " 13-8	
Aluminium	.196 " 19-6	
Mercury	.1063 " 22-8	
Silver, pure	1-000 " 0	1-000

Magnetic Properties.—Iron, nickel and cobalt are the only metals which are attracted by the magnet and can become magnets themselves. But in regard to their power of retaining their magnetism none of them comes at all up to the compound metal steel. See MAGNETISM.

Chemical Changes.—Metals may unite chemically both with metals and with non-metals. The compounds formed in the first case, which may be either definite chemical compounds or solid solutions, are discussed under ALLOYS; in this place only combinations with non-metals are discussed, it being premised that the free metal takes part in the reaction.

Metallic Substances Produced by the Union of Metals with Small Proportions of Non-Metallic Elements.

Hydrogen, as was shown by Graham, is capable of uniting with or being occluded by certain metals, notably with palladium (*q.v.*), into metal-like compounds.

Oxygen.—Mercury and copper and some other metals are capable of dissolving their own oxides. Mercury, by doing so, becomes viscid and unfit for its ordinary applications. Copper, when pure to start with, suffers considerable deterioration in plasticity. But the presence of moderate proportions of cuprous oxide has been found to correct the evil influence of small contaminations by arsenic, antimony, lead and other foreign metals. Commercial coppers sometimes owe their good qualities to this compensating influence.

Arsenic combines readily with all metals into true arsenides, which latter, in general, are soluble in the metal itself. The presence in small even small proportions of arsenide generally leads to considerable deterioration in mechanical qualities.

Phosphorus.—The remark just made might be said to hold for phosphorus were it not for the existence of what is called "phosphorus-bronze," an alloy of copper with phosphorus (*i.e.* its own phosphide), which possesses valuable properties. According to Abel, the most favourable effect is produced by from 1 to 1½% of phosphorus. Such an alloy can be cast like ordinary bronze, but excels the latter in hardness, elasticity, toughness and tensile strength.

Carbon.—Most metals when molten are capable of dissolving at least small proportions of carbon, which, in general, leads to a deterioration in metallicity, except in the case of iron, which by the addition of small percentages of carbon gains in elasticity and tensile strength with little loss of plasticity (see IRON).

Silicon, so far as we know, behaves to metals pretty much like carbon, but our knowledge of facts is limited. What is known as cast iron is essentially an alloy of iron proper with 2 to 6% of carbon dissolved more or less readily, with evolution of hydrogen gas and formation of a basic hydrate, by (1) potassium (formation of KHO), sodium (NaHO), lithium (LiOH), barium, strontium, calcium (BaH₂O, &c.); (2) magnesium, zinc, manganese (MgO₂H₂, &c.).

Action of the More Ordinary Chemical Agents on Simple Metals.

The metals to be referred to are always understood to be given in the compact (frozen) condition, and that, wherever metals are enumerated as being similarly attacked, the degree of readiness in the action is indicated by the order in which the several members are named—the more readily changed metal always standing first.

Water, at ordinary or slightly elevated temperatures, is decomposed more or less readily, with evolution of hydrogen gas and formation of a basic hydrate, by (1) potassium (formation of KHO), sodium (NaHO), lithium (LiOH), barium, strontium, calcium (BaH₂O, &c.); (2) magnesium, zinc, manganese (MgO₂H₂, &c.).

In the case of group 1 the action is more or less violent, and the hydroxides formed are soluble in water and very strongly basic; metals of group 2 are only slowly attacked, with formation of relatively feebly basic and less soluble hydroxides. Disregarding the rarer elements, the metals not named so far may be said to be proof against the action of water in the absence of free oxygen (air). By the joint action of water and air, thallium, lead, bismuth are oxidized, with formation of more or less sparingly soluble hydroxides (ThHO, PbH₂O, BiH₂O₂), which, in the presence of carbonic acid, pass into still less soluble basic carbonates. Iron, when exposed to moisture and air, "rusts"; but this process never takes place in the absence of air, and it is questionable whether it ever sets in in the absence of carbonic acid (see RUST).

Copper, in the present connexion, is intermediate between iron and the following group of metals.

Mercury, if pure, and all the "noble" metals (silver, gold, platinum and titanium-metals), are absolutely proof against water even in the presence of oxygen and carbonic acid.

The metals grouped together above, under 1 and 2, act on steam pretty much as they do on liquid water. Of the rest, the following are readily oxidized by steam at a red heat, with formation of hydrogen gas—zinc, iron, cadmium, cobalt, nickel, tin. Bismuth is similarly attacked, but slowly, at a white heat. Aluminium is barely affected even at a white heat, if it is pure; the ordinary impure metal is liable to be very readily oxidized.

Aqueous Sulphuric or Hydrochloric Acid readily dissolves groups 1 and 2, with evolution of hydrogen and formation of chlorides or sulphates. The same holds for the following group (A): [manganese, zinc, magnesium] iron, aluminium, cobalt, nickel, cadmium. Tin dissolves readily in strong hot hydrochloric acid as SnCl₂; aqueous sulphuric acid does not act on it appreciably in the cold; at 150° it attacks it more or less quickly, according to the strength of the acid, with evolution of sulphuretted hydrogen or, when the acid is stronger, of sulphurous acid gas and deposition of sulphur (Calve and Johnson). A group (B), comprising copper, is, substantially, attacked only in the presence of oxygen or air. Lead, in sufficiently dilute acid, or in stronger acid if not too hot, remains unchanged. A group (C) may be formed of mercury, silver, gold and platinum, which are not touched by either aqueous acid in any circumstances.

Hot (concentrated) sulphuric acid does not attack gold, platinum and platinum-metals generally; all other metals (including silver) are converted into sulphates, with evolution of sulphur dioxide. In the case of iron, ferric sulphate, Fe₂(SO₄)₃, is produced; tin yields a somewhat indefinite sulphate of its oxide SnO₂.

Nitric Acid (Aqueous)—Gold, platinum, iridium and rhodium only are proof against the action of this powerful oxidizer. Tin and antimony (also arsenic) are converted by it (ultimately) into hydrates of their highest oxides SnO₂, Sb₂O₅ (As₂O₅)—the oxides of tin and antimony being insoluble in water and in the acid itself. All other metals, including palladium, are dissolved as nitrates, the oxidizing part of the reagent being generally reduced to oxides of nitrogen. Iron, zinc, cadmium, also tin under certain conditions, reduce the dilute acid, partially at least, to nitrous oxide, N₂O, or ammonium nitrate, NH₄NO₃.

Aqua Regia, a mixture of nitric and hydrochloric acids, converts all metals (even gold, the "king of metals," whence the name) into chlorides, except only rhodium, iridium and ruthenium, which, when pure, are not attacked.

Caustic Alkalis.—Of metals not decomposing liquid pure water, only a few dissolve in aqueous caustic potash or soda, with evolution of hydrogen. The most important of these are aluminium and zinc, which are converted into aluminate, Al(OK,Na), and zincate, Zn(OK,Na), respectively. But of the rest the majority, when treated with boiling sufficiently strong alkali, are attacked at least superficially; of ordinary metals only gold, platinum, and silver are perfectly proof against the reagents under consideration, and these accordingly are used preferably for the construction of vessels intended for analytical operations involving the use of aqueous caustic alkalis. For commercial purposes iron is universally employed and works well; but it is not available analytically, because a superficial oxidation of the empty part of the vessel (by the water and air) cannot be prevented. Basins made of pure malleable nickel are free from this drawback; they work as well as platinum, and rather better than silver ones do. There is hardly a single metal which holds out against the alkalis themselves when in the state of fiery fusion; even platinum is most violently attacked. In chemical laboratories fusions with caustic alkalis are always effected in vessels made of gold or silver; the metals holding out fairly well even in the presence of air. Gold is the better of the two. Iron, which stands so well against aqueous alkalis, is most violently attacked by the fused reagents. Yet tons of caustic soda are fused daily in chemical works in iron pots without thereby suffering contamination, which seems to show that (clean) iron, like gold and silver, is attacked only by the joint action of fused alkali and air, the influence of the latter being of course minimized in large-scale operations.

Oxygen or Air.—The noble metals (from silver upwards) do not combine directly with oxygen given as oxygen gas (O₂), although, like silver, they may absorb it in large quantities, when in the fused condition, and may not be proof against ozone, O₃. Mercury, within

¹ Published in 1860, and declared by Matthiessen to be more exact than the old numbers.

a certain range of temperatures situated close to its boiling point, combines slowly with oxygen into the red oxide, which, however, breaks up again at higher temperatures. All other metals, when heated in oxygen or air, are converted, more or less readily, into stable oxides. Potassium, for example, yields peroxide, K_2O_2 or K_2O ; sodium gives Na_2O ; the barium-group metals, as well as magnesium, cadmium, zinc, lead, copper, are converted into their monoxides MeO . Bismuth and antimony give the latter very readily sesquioxide (Me_2O_3) and Sb_2O_3 , the latter being capable of passing into Sb_2O_4 . Aluminium, when pure and kept out of contact with siliceous matter, is only oxidized at a white heat, and then very slowly, into alumina, Al_2O_3 . Tin, at high temperatures, passes slowly into oxide, SnO_2 .

Sulphur.—Amongst the better known metals, gold and aluminium are the only ones which, when heated with sulphur or in sulphur vapour remain unchanged. All the rest, under these circumstances, are converted into sulphides. The metals of the alkalis and alkaline earths, also magnesium, burn in sulphur vapour as they do in oxygen. Of the heavy metals, copper is the one which exhibits by far the greatest avidity for sulphur, its subsulphide Cu_2S being the stablest of all heavy metallic sulphides in opposition to dry reactions.

Chlorine.—All metals, when treated with chlorine gas at the proper temperatures, pass into chlorides. In some cases the chlorine is taken up in two instalments, a lower chloride being produced first, to pass ultimately into a higher chloride. Iron, for instance, is converted first into $FeCl_2$, ultimately into $FeCl_3$, which practically means a mixture of the two chlorides, or pure $FeCl_3$ as a final product. Of the several products, the chlorides of gold and platinum ($AuCl_3$ and $PtCl_4$) are the only ones which when heated beyond their temperature of formation dissociate into metal and chlorine. The ultimate chlorination product of copper, $CuCl_2$, when heated to redness, decomposes into the lower chloride, $CuCl$, and chlorine. All the rest, when heated by themselves, volatilize, some at lower, others at higher temperatures.

Of the several individual chlorides, the following are liquids or solids, volatile enough to be distilled from glass vessels: $AsCl_3$, $SbCl_3$, $SnCl_4$, $BiCl_3$, $HgCl_2$, the chlorides of arsenic, antimony, tin, bismuth, mercury respectively. The following are readily volatilized in a current of chlorine, at a red heat: $AlCl_3$, $CdCl_2$, $FeCl_3$, the chlorides of aluminium, chromium, iron. The following, though volatile at higher temperatures, are not volatilized at dull redness: KCl , $NaCl$, $LiCl$, $NiCl_2$, $CoCl_2$, $MnCl_2$, $ZnCl_2$, $MgCl_2$, $PbCl_2$, $AgCl$, the chlorides of potassium, sodium, lithium, nickel, cobalt, manganese, zinc, magnesium, lead, silver. Some what less volatile than the last-named group are the chlorides (MCl) of barium, strontium and calcium.

Metallic chlorides, as a class, are readily soluble in water. The following are the most important exceptions: silver chloride, $AgCl$, and mercurous chloride, Hg_2Cl_2 , are absolutely insoluble; lead chloride, $PbCl_2$, and cuprous chloride, Cu_2Cl_2 , are very sparingly soluble in water. The chlorides $AsCl_3$, $SbCl_3$, $BiCl_3$, are at once decomposed by (liquid) water, with formation of oxide (As_2O_3) or oxychlorides ($SbOCl$, $BiOCl$) and hydrochloric acid. The chlorides $MgCl_2$, $AlCl_3$, $CrCl_3$, $FeCl_3$, suffer a similar decomposition when evaporated with water in the heat. The same holds in a limited sense for $ZnCl_2$, $CoCl_2$, $NiCl_2$, and even $CaCl_2$. All chlorides, except those of silver and mercury (and, of course, those of gold and platinum), are oxidized by steam at high temperatures, with elimination of hydrochloric acid.

For the characters of metals as chemical elements see the special articles on the different metals.

See generally A. Rosing *Geschichte der Metalle* (1901); B. Neumann, *Die Metalle* (1904); also treatises on chemistry.

METALLOGRAPHY.—The examination of metals and alloys by the aid of the microscope has assumed much importance in comparatively recent years, and it might at first be considered to be a natural development of the use of the microscope in determining the constitution of rocks, a study to which the name petrography has been given. It would appear, however, that it is an extension of the study of the structure of meteoric irons. There can be no question that in the main it was originated by Dr H. C. Sorby, who in 1864 gave the British Association an account of his work. Following the work of Sorby came that of Professor A. Mariens of Charlottenburg, presenting many features of originality. F. Osmond has obtained results in connexion with iron and steel which are of the highest interest. A list of the more important papers by these and other workers will be found in the appended bibliography.

Preparation of the Specimen.—Experience alone can enable the operator to determine what portion of a mass of metal or alloy will afford a trustworthy sample of the whole. In studying a series of binary alloys it has been found advantageous in certain cases to obtain one section which will show in a general way the variation in structure from one end of the series to the other.

This has been effected by pouring the lighter constituent carefully on the surface of the heavier constituent, and allowing solidification to take place. A section through the cast as obtained will show a gradation in structure from pure metal on one side to pure metal on the other. A thin slice of metal is usually cut by means of a hack-saw driven by mechanism. The thickness of the piece should not be less than $\frac{1}{2}$ in. and in order that it may be firmly held between the fingers it should not be less than 1 in. square. The preliminary stages of polishing are effected by emery paper placed preferably on wooden disks capable of being revolved at a high rate of speed. The finest grade of emery paper that can be obtained is used towards the end of the operation. Before use the finer papers should be rubbed with a hard steel surface to remove any coarse particles. The completion of the operation of polishing is generally effected on wet cloth or parchment covered with a small amount of carefully washed jeweller's rouge. Various mechanical appliances are employed to minimize the labour and time required for the polishing. These usually consist of a series of interchangeable revolving disks, each of which is covered with emery paper, cloth or parchment, according to the particular stage of polishing for which it is required. In the case of brittle alloys and of alloys having a very soft constituent, which during polishing tends to spread over and obliterate the harder constituents, polishing is in many cases altogether avoided by casting the alloy on the surface of glass or mica. In this way, with a little care, a perfect surface is obtained, and it is only necessary to develop the structure by suitable etching. In adopting this method, however, instances have occurred in which the removal of the cast surface has shown a structure differing considerably from the original.

Polishing in Bas-Relief.—If the polishing be completed with fine rouge on a sheet of wet parchment, placed upon a comparatively soft base such as a piece of deal, certain soft constituents of an alloy may often be eroded in such a manner as to leave the hardest portions in relief. For the later stages of polishing H. L. Le Chatelier recommends the use of alumina obtained by the calcination of ammonium alum; and for the final polish of soft metals, chromium oxide.

Although in some cases a pattern becomes visible after polishing, yet more frequently a mirror-like surface is produced in which no pattern can be detected, or if there is a pattern it is blurred, as if seen through a veil or mist. This is due to a thin layer of metal which has been dragged, or smeared, uniformly over the whole surface by the friction of the polishing process. Such a surface layer is formed in all cases of polishing, and the peculiar lustre of burnished silver or steel is probably due to this layer. But to the metallographist it is an inconvenience, as it conceals scratches left by imperfect polishing, and also hides the pattern. It is therefore desirable to conduct the polishing so as to make this layer as thin as possible: it is claimed for alumina that it can be so used as to produce a much thinner surface layer than that due to the employment of rouge. The surface layer is very readily removed by appropriate liquid reagents, and the true surface of the metal having been laid bare, the etching reagent acts differently on the individual substances in the alloy and the pattern can thus be emphasized to any required extent. Osmond divides etching reagents into three classes—acids, halogens and salts. As regards acids, water containing from 2 to 10% of hydrochromic acid is useful. It is made by mixing 10 grams of potassium bichromate with 10 grams of sulphuric acid in 100 grams of water. The use of nitric acid requires much experience. It is frequently employed in the examination of steels, Sir W. C. Roberts-Austen preferred a 1% solution in alcohol, but many workers use concentrated acid, and effect the etching by allowing a stream of water to dilute the film of acid left on the surface of the specimen after dipping it. Of the halogens, iodine is the most useful. A solution in alcohol is applied, so that a single drop covers half a square inch of surface. The specimen is then washed with alcohol, and dried with a piece of fine linen or camois leather. Tincture of iodine also affords a means of identifying lead in certain alloys by the formation of a yellow iodide of lead, while the vapour of iodine has in certain cases been

used to tint the constituents. Thin coloured films may often be produced by the oxidation of the specimen when heated in air. This, as a means of developing the structure, in the case of the copper alloys is specially useful. Tinted crystals may thus be distinguished from the investing layer caused by the presence of a minute quantity of another constituent. The temper colours produced by heating iron or steel in air are well known. Carbide of iron is less oxidizable than the iron with which it is intimately associated, and it assumes a brown tint, while the iron has reached the blue stage. These coloured films may be fixed by covering with thin films of gelatine.

In some cases the alloy may be attacked electrolytically by exposing it for a few minutes to a weak electric current in a bath of very dilute sulphuric acid. Certain organic bodies give very satisfactory results. The Japanese, for instance, produce most remarkable effects by simple reagents of which an infusion of certain forms of grass is a not unimportant constituent. In the case of iron and steel a freshly prepared infusion of liquorice root has been found to be most useful for colouring certain constituents of steel. Osmond, who was the first to use this reagent, insisted that it should be freshly prepared and always used under identical conditions as regards age and concentration. His method of applying it was to rub the specimen on parchment moistened with it, but he has subsequently modified this "polish attack" by substituting a 2% solution of ammonium nitrate for the liquorice infusion. In each case a small quantity of freshly precipitated calcium sulphate is used on the parchment to assist the polishing.

Appliances used in Micrography.—The method of using the microscope in connexion with a camera for photographic purposes will now be considered. Every micrographer has his own views as

should be an achromatic one, as colour effects cause trouble in photographing the objects. For lower powers the Lieberkuhn parabolic illuminator is useful. Certain groups of alloys show better under oblique illumination, which may be effected by the aid of a good condensing lens, the angle of incidence being limited by the distance of the object from the objective in the case of high magnification. As regards objectives, the most useful are the Zeiss 2 mm., 4 mm. and 24 mm.; two other useful objectives for low powers being 35 mm. and 70 mm., both of which are projecting objectives. A projecting eye-piece, preferably of low power, should be employed with all but the two latter objectives. The immersion lens, the Zeiss 2 mm., is used with specially thickened cedar oil, and if the distance from the objective to the plate is 7 feet, magnifications of over 2000 diameters can easily be obtained. As regards sensitized plates, excellent results have been obtained with Lumière plates sensitive to yellow and green. The various brands of "process" plates are very serviceable where the contrasts on the specimen are not great. Some reproductions of photo-micrographs of metals and alloys will be found in the plate accompanying the article ALLOYS.

AUTHORITIES.—H. C. Sorby, "On Microscopical Photographs of Various Kinds of Iron and Steel," *Brit. Assoc. Report* (1864), pt. ii. p. 189; "Microscopical Structure of Iron and Steel," *Journ. Iron and Steel Inst.* (1887), p. 255; A. Martens, "Die mikroskopische Untersuchung der Metalle," *Glaser's Annalen* (1892), xxx. 201; H. Wedding, "Das Gefüge der Schienenköpfe," *Stahl und Eisen* (May 15, 1892), xii. 478; F. Osmond, "Sur la metallographie microscopique," *Rapport présenté à la commission des méthodes d'essai des matériaux de construction le 10 février 1892*; et li. 7-17 (Paris, 1895); "Microscopic Metallography," *Trans. Amer. Inst. Mining Eng.* xxii. 243; J. E. Stead, "Methods of preparing Specimens for Microscopic Examination," *Journ. Iron and Steel Inst.* (1894), pt. i. p. 292; W. C. Roberts-Austen and F. Osmond, "On the Structure of Metals, its Origin and Causes," *Phil. Trans. Roy. Soc. Cxxxvii.* 417-432; and *Bull. de la Soc. d'encouragement pour l'industrie nationale*, 5^e série, i. 1136 (Août. 1896); G. Charpy, "Microscopic Study of Metallic Alloys," *Bull.*

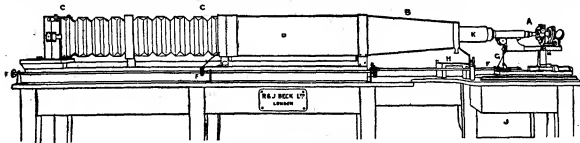

Micrographic Apparatus.

to the form of an installation to be adopted, and it will therefore be well to give an illustration of a definite apparatus which has been found to give satisfactory results. It consists of a microscope A with a firm base placed in a horizontal position. The microscope can be connected by a tube B with the expanded camera CC, at the end of which is the usual frame to receive the photographic plate. A practised observer can focus on a plate of clear glass by the aid of a subsidiary low-power microscope lens. If a semi-transparent plate is employed it should be as fine as possible. The surface of the table is cut in such a way near H that the observer who is seated may conveniently examine the object on the stage of the microscope, the portion B turning aside for this purpose. The subsequent focusing is effected by a rod, FFF, and gearing attached to the fine adjustment of the microscope, GA; flap J when raised forms the support of the lamp used for illumination. As an illuminant an arc light has many advantages, as the exposure of the plate used will seldom exceed to seconds. The filament of a Nernst lamp can be used as the source of light; though not so brilliant as the arc it possesses the great advantage of perfect immobility. For the best results, especially with high powers, the source of light must be small, so that its image can be focussed on to the surface of the object; this advantage is possessed by both of these illuminants. Next in value comes the acetylene flame, and an incandescent lamp or a gas lamp with a mantle will give good results, but with much longer exposure. Actual illumination is best effected by a Beck vertical illuminator or a Zeiss prism. It is necessary that the lens used for concentrating the light on the illuminator

de la soc. d'encouragement pour l'industrie nationale (March, 1897); A. Sauveur, "Constitution of Steel," *Technology Quarterly* (June, 1898); *Metallographist*, vol. i. No. 3; "Metallography applied to Foundry Work," *The Iron and Steel Magazine*, vol. ix. No. 6, and vol. x. No. 1; J. E. Stead, "Crystalline Structure of Iron and Steel," *Journ. Iron and Steel Inst.* (1898), i. 145; "Practical Metallography," *Proc. Cleveland Inst. of Engineers* (Feb. 26, 1900); Ewing and Rosenhain, "Crystalline Structure of Metals," *Phil. Trans. Roy. Soc.* cxciii. 353 and excv. 279; F. Osmond, "Crystallography of Iron," *Annales des Mines* (January 1900); Le Chatelier, "Technologie de Metallography," *Metallographist*, vol. iv. No. 1; *Contribution à l'étude des alliages*, *Société d'encouragement pour l'industrie nationale* (1901); Smeaton, "Notes on the Etching of Steel Sections," *Iron and Steel Magazine*, vol. ix. No. 3. (W. C. R.-A.; F. H. Nb.)

METALLURGY, the art of extracting metals from their ores; the term being customarily restricted to commercial as opposed to laboratory methods. It is convenient to treat electrical processes of extraction as forming the subjects of Electrochemistry and Electrometallurgy (*qq.v.*). The following table enumerates in the order of their importance the metals which our subject at present is understood to include; the second column gives the chemical characters of the ores utilized, italics indicating those of subordinate importance. The term "oxide" includes carbonate, hydrate, and, when marked with *, silicate.

Metal.	Character of Ores.
Iron	Oxides, sulphide.
Copper	Complex sulphides, also oxides, metal.
Silver	Sulphide and reguline metal, chloride.
Gold	Reguline metal.
Lead	Sulphide and basic carbonate, sulphate, &c.
Zinc	Sulphide, oxide.*
Tin	Oxide.

Metal.	Character of Ores.
Mercury	Sulphide, reguline metal.
Antimony	Sulphide.
Bismuth	Reguline metal.
Nickel and cobalt	Arsenides.
Platinum, iridium, &c.	Reguline.

General Sequence of Operations.—Occasionally, but rarely, metallic ores occur as practically pure compact masses, from which the accompanying matrix or "gangue" can be detached by hand and hammer. In most cases the "ore" (see MINERAL DEPOSITS; VEINS), as it comes out of the mine or quarry, is simply a mixture of ore proper and gangue, in which the latter not unfrequently predominates. Hence it is generally necessary to purify the ore before the liberation of the metal is attempted. Most metallic ores are specifically heavier than the accompanying impurities and their purification is generally effected by reducing the crude ore to a fine enough powder to detach the metallic from the earthy part, and then washing away the latter by a current of water, as far as possible (see ORE-DRESSING).

The majority of ores being chemical compounds, the extraction of their metals demands chemical treatment. The chemical operations involved may be classified as follows:—

1. **Fiery Operations.**—The ore, generally with some "flux," is exposed to the action of fire. The fire in most cases has a chemical, in addition to its physical, function. Moreover the furnace (*q.v.*) is designed so as to facilitate the action of the heat and furnace gases in the desired direction. It is intended either to burn away certain components of the ore—in which case it must be so regulated as to contain a sufficient excess of unburned oxygen; or it is meant to deoxidize ("reduce") the ore, when the draught must be restricted so as to keep the ore constantly wrapped up in combustible flame gases (carbon monoxide, hydrogen, marsh-gas, &c.). The majority of the chemical operations of metallurgy fall into this category, and in these processes other metal-reducing agents than those naturally contained in the fire (or blast) are only exceptionally employed.

2. **Amalgamation.**—The ore by itself (if it is a reguline one), or with certain reagents (if it is not), is worked up with mercury so that the metal is obtained as an amalgam, which can be separated mechanically from the dross. The purified amalgam is distilled, when the mercury is recovered as a distillate while the metal remains.

3. **Wet Processes.**—Strictly speaking, certain amalgamation methods fall under this head; but, in its ordinary acceptance, the term refers to processes in which the metal is extracted either from the natural ore, or from the ore after roasting or other preliminary treatment, by an acid or salt solution, and from this solution precipitated—generally in the reguline form—by some suitable reagent.

Few methods of metal extraction at once yield a pure product. What as a rule is obtained is a more or less impure metal, which requires to be "refined" to become fit for the market.

Chemical Operations.—Amalgamation and wet-way processes have limited applications, being practically confined to copper, gold and silver. We therefore here confine ourselves, in the main, to pyro-chemical operations.

The method to be adopted for the extraction of a metal from its ore is determined chiefly, though not entirely, by the nature of the non-metallic component with which the metal is combined. The simplest case is that of the reguline ores where there is no non-metallic element. The important case is that of gold.

Oxides, Hydrates, Carbonates and Silicates.—All iron and tin ores proper fall under this heading, which, besides, comprises certain ores of copper, of lead and of zinc. The first step consists in subjecting the crude ore to a roasting or calcining process, the object of which is to remove the water and carbon dioxide, and burn away, to some extent at least, the sulphur, arsenic or organic matter. The residue consists of an impure oxide of the respective metal, which in all cases is reduced by treatment with fuel at a high temperature. Should the metal be present as a silicate, lime must be added in the smelting to remove the silica and liberate the oxide.

The temperature required for the reduction of zinc lies above the boiling point of the metal; hence the mixture of ore and reducing agent (charcoal is generally used) must be heated in a retort combined with condensing apparatus. In all the other cases the reduction is effected in the fire itself, a tower-shaped blast furnace being preferably used. The furnace is charged with alternate layers of fuel and ore (or rather ore and flux, see below), and the whole kindled

from below. The metallic oxide, partly by the direct action of the carbon with which it is in contact, but principally by that of the carbon monoxide produced in the lower strata from the oxygen of the blast and the hot carbon there, is reduced to the metallic state; the metal fuses and runs down, with the slag, to the bottom of the furnace, whence both are withdrawn by opening plug-holes.

Sulphides.—Iron, copper, lead, zinc, mercury, silver, and antimony very frequently present themselves in the form of combination, as components of a family of ores which may be divided into two sections: (1) such as substantially consist of simple sulphides, as iron pyrites (FeS₂), galena (PbS), zinc blende (ZnS), cinnabar (HgS); and (2) complex sulphides, such as the various kinds of sulphureous copper ores (all substantially compounds or mixtures of sulphides of copper and iron); bournonite, a complex sulphide of lead, antimony and copper; rothgiltigerz, sulphide of silver, antimony and arsenic; fahlerz, sulphides of arsenic and antimony, combined with sulphides of copper, silver, iron, zinc, mercury, silver; and mixtures of these and other sulphides with one another.

In treating a sulphureous ore, the first step as a rule is to subject it to oxidation by roasting it in a reverberatory or other furnace, which leads to the burning away of at least part of the arsenic and part of the sulphur. The effect on the several individual metallic sulphides (supposing only one of these to be present) is as follows:—

1. Those of silver (Ag₂S) and mercury (HgS) yield sulphur dioxide gas and metal; in the case of silver, sulphate is formed at low temperatures, and in the case of mercury, zinc, mercury, iron, zinc, mercury, a vapour, which is collected and condensed; silver remains as a regulus, but pure sulphide of silver is hardly ever worked.
2. Sulphides of iron and zinc yield the oxides Fe₂O₃ and ZnO as final products, some basic sulphate being formed at the earlier stages, especially in the case of zinc. The oxides can be reduced by carbon.
3. The sulphides of lead and copper yield, the former a mixture of oxide and normal sulphate, the latter one of oxide and basic sulphate. Sulphate of lead is stable at a red heat; sulphate of copper breaks up into oxide, sulphur dioxide and oxygen. In practice, neither oxidation process is ever pushed to the end; it is stopped as soon as the mixture of roasting-product and unchanged sulphide contains oxygen and sulphur in the ratio of O₂ : S. The access of air is then stopped and the whole heated to a higher temperature, when the whole of the sulphur and oxygen is eliminated. This method is largely utilized in the smelting of lead from galena and of copper from copper pyrites.

4. Sulphide of antimony, when roasted in air, is converted into a kind of siliceous and oxide, the iron, and the iron, into its oxysulphide is quite readily converted into the pure oxide Fe₂O₃ by further roasting. Oxysulphide of antimony, by suitable processes can be reduced to metal, but these processes are rarely used, because the same end is far more easily obtained by "precipitation," *i.e.* withdrawing the sulphur by fusion with metallic iron, forming metallic antimony and sulphide of iron. Both products fuse, but readily part, because fused antimony is far heavier than fused sulphide of iron. A precisely similar method is used occasionally for the reduction of lead from galena. Sulphide of lead, when fused together with metallic iron in the proportion of 2Fe : 1Pb yields a regulus (= 1Pb) and a "mat" FeS, which, however, on cooling, decomposes into the ordinary sulphide FeS, and finely divided iron. What we have been explaining are special cases of a more general metallurgical proposition: Any one of the metals, copper, iron, tin, zinc, lead, silver, antimony, arsenic, in general, is capable of desulphurizing (at least partially) any of the others that follows it in the series just given, and it does so the more readily and completely the greater the number of intervening terms. Hence, supposing a complete mixture of these metals, to be melted down under circumstances admitting of only a partial sulphuration of the whole, the copper has the best chance of passing into the "mat," while the arsenic is the first to be eliminated as such, or, in the presence of oxidants, as oxide.

Arsenides.—Although arsenides are amongst the commonest impurities of ores generally, ores consisting essentially of arsenides are comparatively rare. The most important are certain double arsenides of cobalt and nickel, which in practice are always contaminated with the arsenic or other compounds of foreign metals, such as iron, manganese, &c. The general mode of working these ores is as follows. The ore is first roasted by itself, when a part of the arsenic goes off as such and as oxide, while a complex of lower arsenides remains. This residue is now subjected to careful oxidizing fusion in the presence of some solvent for metallic bases. The effect is that the several metals are oxidized away and pass into the slag (as silicates) in the following order—manganese, iron, cobalt, nickel; and at any stage the as yet unoxidized residue of arsenic assumes the form of a fused regulus, which sinks down through the slag as a "speis." (This term has the same meaning in reference to arsenides as "mat" has in regard to sulphides.) By stopping the process at the right moment, we can produce a speis which contains only cobalt and nickel, and if at this stage also the flux is renewed we can further produce a speis which contains only nickel and a slag which substantially is one of cobalt metal. The composition of the speises generally varies from As₂Me₂ to AsMe₃, where "Me" means one atomic weight of metal *in toto*, so that in general 1Me = xFe + yCo + zNi, where $x + y + z = 1$. The siliceous

cobalt is utilized as a blue pigment called "smalt"; the nickel-splis is worked up for metal.

Minor Reagents.—Besides the oxidizing and reducing agents present in the fire, and the "fluxes" added for the production of slags, various minor reagents may be noticed. Metallic iron as a desulphurizer has already been referred to.

Oxide of lead, PbO (litharge), is largely used as an oxidizing agent. At a red heat, when it melts, it readily attacks all metals, except silver and gold. The general result being the formation of a mixed oxide and of a mixed regulus, a distribution, in other words, of both the lead and the metal acted on between slag and regulus. More important is its action on metallic sulphides, which, in general, results in the formation of three things besides sulphur dioxide, viz. a mixed oxide slag including the excess of litharge, a regulus of lead (which may include bismuth and other more readily reducible metals), and, if the litharge is not sufficient for a complete oxidation, a "mat" comprising the more readily sulphurizable metals. Oxide of lead, being a most powerful solvent for metallic oxides generally, is also largely used for the separation of silver or gold from base metallic oxides.

Metallic lead is to metals generally what oxide of lead is to metallic oxides. It accordingly is available as a solvent for taking up small particles of metal diffused throughout a mass of slag, and uniting them into one regulus. This leads us to the process of "cupellation," which serves for the extraction of gold (p. 27: see also ASSAYING) and silver from their alloys with base metals.

Fluxes.—All ores are contaminated with more or less gangue, which in general consists of infusible matter, and if left unabsorbed, in the reduction of the metallic part of the ore would retain more or less of the metal disseminated through it, or at best furl the furnace. To avoid this, the ore as it goes into the furnace is mixed with "fluxes" so selected as to convert the gangue into a fusible "slag," which readily runs down through the fuel with the regulus and separates from the latter. The quality and proportion of flux should, if possible, be so chosen that the formation of the slag sets in only after the metal has been reduced and molten; or else part of the basic oxide of the metal to be extracted may be dissolved by the slag and its reduction thus be prevented or retarded. Slags are not a necessary evil: if an ore were free from gangue we should add gangue and flux from without to produce a slag, because one of its functions is to form a layer on the regulus which protects it against the further action of the blast or furnace gases. Fluxes may be arranged under the three heads of (1) fluor-spar, (2) basic fluxes and (3) acid fluxes.

Fluor-spar fuses up at a red heat with silica, sulphates of calcium and barium, and a few other infusible substances into homogeneous melt. It shows a little tendency to dissolve such substances as lime, &c. One part of fluor-spar liquefies about half a part of silica, four parts of calcium sulphate and one and a half parts of barium sulphate. Upon these facts its extremely wide application in metallurgy is founded. Carbonate of soda (or potash) is the most powerful basic flux. It dissolves silica and all silicates into fusible glasses. On the other hand, borax may be taken as a type for the acid fluxes. At a red heat, when it forms a viscid fluid, it readily dissolves all basic oxides into fusible complex borates. Now the gangue of an ore in general consists either of some basic material such as carbonate of lime (or magnesia), ferric oxide, alumina, &c., or of silica (quartz) or some more or less acid silicate, or else of a mixture of the two classes of bodies. So any kind of gangue might be liquefied by means of borax or by means of alkaline carbonate; but neither of the two is used otherwise than for assaying; what the metal-smelter does is to add to a basic gangue the proportion of silica, and to an acid ore the proportion of lime, or, indirectly, of ferrous or perhaps manganous oxide, which it may need for the formation of a slag of the proper qualities. The slag must possess the proper degree of saturation in other words, taking $\text{SiO}_2 + \text{MeO}$ (where MeO means an equivalent of base) as a formula for the potential slag, Me must have the proper value. If Me is too small, i.e. if the slag is too acid, it may dissolve part of the metal to be recovered; if Me is too great, i.e. the slag too basic, it may refuse to dissolve, for instance, the ferrous oxide which is meant to go into it, and this oxide will then be reduced, and its metal (iron in our example) contaminate the regulus. In reference to the problem under discussion, it is worth noting that oxides of lead and copper are more readily reduced to metal than those of FeO, and FeO to Fe, and FeO more readily to metal than manganous oxide is. Oxide of calcium (lime) is not reducible at all. The order of basicity in the oxides (their readiness to go into the slag) is precisely the reverse.

Most slags being, as we have seen, complex silicates, it is a most important problem of scientific metallurgy to determine the relations in this class of bodies between chemical composition on the one hand and fusibility and solvent power for certain oxides (CaO, FeO, Fe₂O₃, Al₂O₃, &c.) on the other. Their general composition may be expressed as $\text{Me}_x\text{SiO}_y + \text{SiO}_2$ (or $\text{a}(\text{Me}_x\text{SiO}_y) + \text{b}(\text{SiO}_2)$) (M = Ca, Mg, Fe, K, &c.; $\text{e} = \text{KFe}$, $\text{a} = \text{Al}$). The following mode of classifying and naming composition in silicates is metallurgical; scientific chemists designate Class I. as orthosilicates, Class II. as metasilicates, Class III. as sesquosilicates. In the formulae M stands for K, Ca, Fe, &c., or as equivalents, $\text{e} = \text{KFe}$, &c.

Name.	Formula.	Oxygen Ratio.		π
		Basic.	Acid.	
I. Singulo-silicates . . .	$\frac{1}{2}\text{SiO}_2 + \text{MeO}$	1	1	$\frac{1}{2}$
II. Bi-silicates . . .	$\text{SiO}_2 + \text{MeO}$	1	2	1
III. Tri-silicates . . .	$\frac{3}{2}\text{SiO}_2 + \text{MeO}$	1	3	$\frac{1}{2}$

It should be possible to represent each quality of a silicate as a function of x , m , and of the nature of the individual bases that make up the MO and (fe or al) O respectively. Our actual knowledge falls far short of this possibility. The problem, in fact, is very difficult, the more so as it is complicated by the existence of aluminates, compounds such as $\text{Al}_2\text{O}_3 \cdot 3\text{CaO}$, in which the alumina plays the part of acid, and the occasional existence of compounds of fluorides and silicates in certain slags. The formation of slags, or, what comes to the same thing, of metallic silicates, was especially studied by Percy, Smith, Bischof, Plattner and others, and in more recent times by Vogt, Doelter, and at the Geophysical laboratory of the Carnegie Institution, Washington.

BIBLIOGRAPHY.—W. Roberts-Austen, *Introduction to the Study of Metallurgy*; J. A. Phillips and H. Bauerman, *Elements of Metallurgy* (1885); and L. Babu, *Métallurgie générale* (Paris, 1906), deal with the principles of metallurgy. A standard work treating the metallurgy of various metals is Carl Schnabel, *Handbuch der Metallhüttenkunde*, i. (1901), ii. (1904), Eng. trans. by H. Louis, i. (1905), ii. (1907).

METAL-WORK. Among the many stages in the development of primeval man, none can have been of greater moment in his struggle for existence than the discovery of the metals, and the means of working them. The names generally given to the three prehistoric periods of man's life on the earth—the Stone, the Bronze and the Iron age—imply the vast importance of the progressive steps from the flint knife to the bronze celt, and lastly to the keen-edged elastic iron weapon or tool.

The metals chiefly used in the arts have been gold, silver, copper and tin (the last two generally mixed, forming an alloy called bronze), iron and lead (see the separate articles on these metals). Their peculiarities have naturally marked out each of them for special uses and methods of treatment. The durability and the extraordinary ductility and pliancy of gold, its power of being subdivided, drawn out or flattened into wire or leaf of almost infinite fineness, have led to its being used for works where great minuteness and delicacy of execution were required; while its beauty and rarity have, for the most part, limited its use to objects of adornment and luxury, as distinct from those of utility. In a lesser degree most of the qualities of gold are shared by silver, and consequently the treatment of these two metals has always been very similar, though the greater abundance of the latter metal has allowed it to be used on a larger scale and for a greater variety of purposes. The great fluidity of bronze when melted, the slowness of its contraction on solidifying, together with its density and hardness, make it especially suitable for casting, and allow of its taking the impress of the mould with extreme sharpness and delicacy. In the form of plate it can be tempered and annealed till its elasticity and toughness are much increased, and it can then be formed into almost any shape under the hammer and punch. By other methods of treatment, known to the ancient Egyptians, Greeks and others, but now forgotten, it could be hardened and formed into knife and razor edges of the utmost keenness. In many specimens of ancient bronze, small quantities of silver, lead and zinc have been found, but their presence is probably accidental. In modern times brass has been much used, chiefly for the sake of its cheapness as compared with bronze. In beauty, durability and delicacy of surface it is very inferior to bronze, and, though of some commercial importance, has been of but little use in the production of works of art. To some extent copper was used in an almost pure state during medieval times, especially from the 12th to the 15th century, mainly for objects of ecclesiastical use, such as pyxes, monstrances, reliquaries and croziers, partly on account of its softness under the tool, and also because it was slightly easier to apply enamel and gilding to pure copper than to bronze (see fig. 1). In the medieval period it was used to some extent in the shape of thin sheeting for roofs, as at St Mark's, Venice; while during the 16th and 17th centuries it was largely employed for ornamental domestic vessels of various sorts.

Iron.—The abundance in which iron is found in so many places, its great strength, its remarkable ductility and malleability in a red-hot state, and the ease with which two heated surfaces of

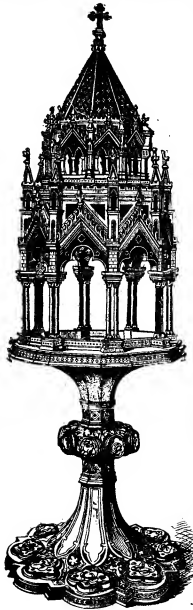

FIG. 1.—Monstrance of Copper Gilt; Italian work of the 15th century.

wrought, was very limited, bronze being the favourite metal almost for all purposes. The difficulty of smelting the ore was probably one reason for this, as well as the now forgotten skill which enabled bronze to be tempered to a steel-like edge. It had, however, its value, of which a proof occurs in Homer (*Il. xxiii.*), where a mass of iron is mentioned as being one of the prizes at the funeral games of Patroclus.

Methods of Manipulation in Metal-Work.—Gold, silver and bronze may be treated in various ways, the chief of which are (1) casting in a mould, and (2) treatment by hammering and punching (*Fr. repoussé*).

The first of these, casting is chiefly adapted for bronze, or ¹Analyses of the iron of prehistoric weapons have brought to light the interesting fact that many of these earliest specimens of iron manufacture contain a considerable percentage of nickel. This special alloy does not occur in any known iron ores, but is invariably found in meteoric iron. It thus appears that iron was manufactured from meteorites which had fallen to the earth in an almost pure metallic state, possibly long before prehistoric man had learnt how to dig for and smelt iron in any of the forms of ore which are found on this planet.

iron can be welded together under the hammer combine to make it specially suitable for works on a large scale where strength with lightness are required—things such as screens, window-grills, ornamental hinges and the like. In its hot plastic state iron can be formed and modelled under the hammer to almost any degree of refinement, while its great strength allows it to be beaten out into leaves and ornaments of almost paperlike thinness and delicacy. With repeated hammering, drawing out and annealing, it gains much in strength and toughness, and the addition of a very minute quantity of carbon converts it into steel, less tough, but of the keenest hardness. The large employment of cast iron is comparatively modern, in England at least only dating from the 16th century; it is not, however, incapable of artistic treatment if due regard be paid to the necessities of casting, and if no attempt is made to imitate the fine-drawn lightness to which wrought iron so readily lends itself. At the best, however, it is not generally suited for the finest work, as the great contraction of iron in passing from the fluid to the solid state renders the cast somewhat blunt and spiritless.

Among the Assyrians, Egyptians and Greeks the use of iron, either cast or

in the case of the more precious metals only if they are used on a very small scale. The reason of this is that a repoussé relief is of much thinner substance than if the same design were cast, even by the most skillful metal-worker, and so a large surface may be produced with a very small expenditure of valuable metal. Casting is probably the most primitive method of metal-work. This has passed through three stages, the first being represented by solid castings, such as are most celts and other implements of the prehistoric time; the mould was formed of clay, sand or stone, and the fluid metal was poured in till the hollow was full. The next stage was, in the case of bronze, to introduce an iron core, probably to save needless expenditure of the more valuable metal. The British Museum possesses an interesting Etruscan or Archaic Italian example of this primitive device. It is a bronze statuette from Sessa on the Volturno, about 2 ft. high, of a female standing, robed in a close-fitting chiton. The presence of the iron core has been made visible by the splitting of the figure, owing to the unequal contraction of the two metals. The forearms, which are extended, have been cast separately and soldered or brazed on to the elbows. The third and last stage in the progress of the art of casting was the employment of a core, generally of clay, round which the metal was cast in a mere skin, only thick enough for strength, without waste of metal. The Greeks and Romans attained to the greatest possible skill in this process. Their exact method is not certainly known, but it appears probable that they were acquainted with the process now called *à cire perdue*—the same as that employed by the great Italian artists in bronze. Cellini, the great Florentine artist of the 16th century, has described it fully in his *Trattato della Scultura*. If a statue was to be cast, the figure was first roughly modelled in clay—only rather smaller in all its dimensions than the future bronze; all over this a skin of wax was laid, and worked by the sculptor with modelling tools to the required form and finish. A mixture of pounded brick, clay and ashes was then ground finely in water to the consistence of cream, and successive coats of this mixture were then applied with a brush, till a second skin was formed all over the wax, fitting closely into every line and depression of the modelling. Soft clay was then carefully laid on to strengthen the mould, in considerable thickness, till the whole statue appeared like a shapeless mass of clay, round which iron hoops were bound to hold it all together. The whole was then thoroughly dried, and placed in a hot oven, which baked the clay, both of the core and the outside mould, and melted the wax, which was allowed to run out from small holes made for the purpose. Thus a hollow was left, corresponding to the skin of wax between the core and the mould, the relative positions of which were preserved by various small rods of bronze, which had previously been driven through from the outer mould to the rough core. The mould was now ready, and melted bronze was poured in till the whole space between the core and the outer mould was full. After slowly cooling, the outer mould was broken away from outside the statue and the inner core as much as possible broken up and raked out through a hole in the foot or some other part of the statue. The projecting rods of bronze were then cut away, and the whole finished by rubbing down and polishing over any roughness or defective places. The most skillful sculptors, however, had but little of this after-touching to do, the final modelling and even polish which they had put upon the wax being faithfully reproduced in the bronze casting. The further enrichment of the object by enamels and inlay of other metals was practised at a very early period by Assyrian, Egyptian and Greek metal-workers, as well as by the artists of Persia and mediæval Europe.

The second chief process, that of hammered work (*Gr. σφουρηλατος; Fr. repoussé*), was probably adopted for bronze-work on a large scale before the art of forming large castings was discovered. In the most primitive method thin plates of bronze were hammered over a wooden core, rudely cut into the required shape, the core serving the double purpose of giving shape to and strengthening the thin metal. A further development in the art of hammered work consisted in laying the metal plate on a soft

and elastic bed of cement made of pitch and pounded brick. The design was then beaten into relief from the back with hammers and punches, the pitch bed yielding to the protuberances which were thus formed, and serving to prevent the punch from breaking the metal into holes. The pitch was then melted away from the front of the embossed relief, and applied in a similar way to the back, so that the modelling could be completed on the face of the relief, the final touches being given by the graver. This process was chiefly applied by medieval artists to the precious metals, but by the Assyrians, Greeks and other early nations it was largely used for bronze. The great gates of Shalmaneser II., 858-823 B.C., from Balawat, now in the British Museum, are a remarkable example of this sort of work on a large scale, though

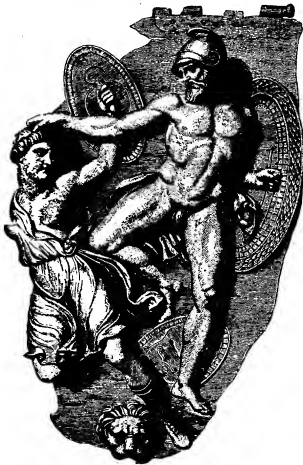

FIG. 2.—One of the Siris Bronzes.

the treatment of the reliefs is minute and delicate. The "Siris bronzes," in the same museum, are a most astonishing example of the skill attained by Greek artists in this repoussé work (see Brönsted's *Bronzes of Siris*, 1836). They are a pair of shoulder-pieces from a suit of bronze armour, and each has in very high relief a combat between a Greek warrior and an Amazon. No work of art in metal has probably ever surpassed these little figures for beauty, vigour and expression, while the skill with which the artist has beaten these high reliefs out of a flat plate of metal appears almost miraculous. The heads of the figures are nearly detached from the ground, their substance is little thicker than paper, and yet in no place has the metal been broken through by the punch. They are probably of the school of Praxiteles, and date from the 4th century B.C. (see fig. 2).

Copper and tin have been but little used separately. Copper in its pure state may be worked by the same methods as bronze, but it is inferior to it in hardness, strength and beauty of surface. Tin is too weak and brittle a metal to be employed alone for any but small objects. Some considerable number of tin drinking-cups and bowls of the Celtic period have been found in Cornwall

in the neighbourhood of the celebrated tin and copper mines, which have been worked from a very early period. The use of lead has been more extended. In sheets it forms the best of all coverings for roofs and even spires. In the Roman and medieval periods it was largely used for coffins, which were often richly ornamented with cast work in relief. Though fusible at a very low temperature, and very soft, it has great power of resisting decay from damp or exposure. Its most important use in an artistic form has been in the shape of baptismal fonts, chiefly between the 11th and the 14th centuries. The superior beauty of colour and durability of old specimens of lead is owing to the natural presence of a small proportion of silver. Modern smelters carefully extract this silver from the lead ore, thereby greatly impairing the durability and beauty of the metal.

As in almost all the arts, the ancient Egyptians excelled in their metal-work, especially in the use of bronze and the precious metals. These were worked by casting and hammering, and ornamented by inlay, gilding and enamels with the greatest possible skill. From Egypt perhaps was derived the early skill of the Hebrews. Further instruction in the art of metal-working came probably to the Jews from the neighbouring country of Tyre. The description of the great gold lions of Solomon's throne, and the laver of cast bronze supported on figures of oxen, shows that the artificers of that time had overcome the difficulties of metal-working and founding on a large scale. The Assyrians were perhaps the most remarkable of all ancient nations for the colossal size and splendour of their works in metal; whole circuit walls of great cities, such as Ecbatana, are said to have been covered with metal plates, gilt or silvered. Herodotus, Athenæus and other Greek and Roman writers have recorded the enormous number of colossal statues and other works of art for which Babylon and Nineveh were so famed. The numerous objects of bronze and other metals brought to light by the excavations in the Tigris and Euphrates valleys, though mostly on a small scale, bear witness to the great skill and artistic power of the people who produced them; while the discovery of some bronze statuettes, shown by inscriptions on them to be not later than 2200 B.C., proves how early was the development of this branch of art among the people of Assyria.

The Metal-Work of Greece.—The early history of metal-working in Greece is extremely obscure, and archaeologists are divided in opinion even on so important a question as the relative use of bronze and iron in the Homeric age. The evidence of Mycenaean remains, as compared with the literary evidence of Homer, is both inadequate and inconclusive (see *ÆGÆAN CIVILIZATION; GREEK ART; ARMS AND ARMOUR, Ancient; PLATE; &c.*). The poems of Homer are full of descriptions of elaborate works in bronze, gold and silver, which, even when full allowance is made for poetic fancy, show clearly enough very advanced skill in the working and ornamenting of these metals. Homer's description of the shield of Achilles, made of bronze, enriched with bands of figure reliefs in gold, silver and tin, could hardly have been written by a man who had not some personal acquaintance with works in metal of a very elaborate kind. Again, the accuracy of his descriptions of brazen houses—such as that of Alcinoüs, *Od. vii. 81*—is borne witness to by Pausanias's mention of the bronze temple of Athena Χαλκίαικος in Sparta, and the bronze chamber dedicated to Myron in 648 B.C., as well as by the discovery of the stains and bronze nails, which show that the whole interior of the so-called treasury of Atreus at Mycenæ was once covered with a lining of bronze plates. Of the two chief methods of working bronze, gold and silver, it is probable that the hammer process was first practised, at least for statues, among the Greeks, who themselves attributed the invention of the art of hollow casting to Theodorus and Rhoecus, both Samian sculptors, about the middle of the 6th century B.C. Pausanias specially mentions that one of the oldest statues he had ever seen was a large figure of Zeus in Sparta, made of hammered bronze plates riveted together. With increased skill in large castings, and the discovery of the use of cores, by which the fluid bronze was poured into a mere skin-like cavity, hammered or repoussé work was only used in the case of small objects in which lightness was

desirable, or for the precious metals in order to avoid large expenditure of metal. The colossal statues of ivory and gold by Pheidias were the most notable examples of this use of gold, especially his statue of Athena in the Parthenon, and the one of Zeus at Olympia. The nude parts, such as face and hands, were of ivory, while the armour and drapery were of beaten gold. The comparatively small weight of gold used by Pheidias is very remarkable when the great size of the statues is considered.

A graphic representation of the workshop of a Greek sculptor in bronze is given on a fictile vase in the Berlin Museum (see Gerhard's *Trinkschalen*, plates xii., xiii.). One man is raking out the fire in a high furnace, while another behind is blowing the bellows. Two others are smoothing the surface of a statue with scraping tools, formed like a strigil. A fourth is beating the arm of an unfinished figure, the head of which lies at the workman's feet. Perhaps the most important of early Greek works in cast bronze, both from its size and great historical interest, is the bronze pillar (now in the Hippodrome at Constantinople) which was erected to commemorate the victory of the allied Greeks states over the Persians at Plataea in 479 B.C. (see Newton's *Travels in the Levant*). It is in the form of three serpents twisted together, and before the heads were broken off was at least 20 ft. high. It is cast hollow, all in one piece, and has the names of the allied states engraved on the lower part of the coils. Its size and the beauty of its surface show great technical skill in the founder's art. On it once stood the gold tripod dedicated to Apollo as a tenth of the spoils. It is described by both Herodotus and Pausanias.

Marble was comparatively but little used by the earlier Greek sculptors, and even Myron, a rather older man than Pheidias,



FIG. 3.—Boss from the Milanese Candelabrum.

seems to have excelled nearly all his most important statues in metal. Additional richness was given to Greek bronze-work by gold or silver inlay on lips, eyes and borders of the dress; one remarkable statuette in the British Museum has eyes inlaid with diamonds and fret-work inlay in silver on the border of the chiton. The mirrors of the Greeks are among the most important specimens of their artistic metal-work. These are bronze disks, one side polished to serve as a reflector, and the back ornamented with engraved outline drawings, often of great beauty (see Gerhard, *Etruskische Spiegel*, 1843-1867). In metal-work, as in other arts, the Romans were pupils and imitators of the Greeks. Owing to the growth of the spirit of luxury, a considerable demand arose for magnificent articles of gold and silver plate. The finest specimens of these that still exist are the very beautiful set of silver plate found buried near Hildesheim in 1860, now in the Berlin Museum. They consist of drinking vessels, bowls, vases, ladies and other objects of silver, parcel-gilt, and exquisitely decorated with figures in relief, both cast and repoussé. There are electrotypes of these in the Victoria and Albert Museum. When the seat of the empire was changed, Byzantium became the chief centre for the production of artistic metal-work. From Byzantium the special skill in this art was transmitted in the

9th and 10th centuries to the Rhenish provinces of Germany and to Italy, and thence to the whole of western Europe; in this way the 18th century smith who wrought the Hampton Court iron gates was the heir to the mechanical skill of the ancient metal-workers of Phœnicia and Greece. In that period of extreme degradation into which all the higher arts fell after the destruction of the Roman Empire, though true feeling for beauty and knowledge of the subtleties of the human form remained for centuries almost dormant, yet at Byzantium at least there still survived great technical skill and power in the production of all sorts of metal-work. In the age of Justinian (first half of the 6th century) the great church of St Sophia at Constantinople was adorned with an almost incredible amount of wealth and splendour in the form of screens, altars, candlesticks and other ecclesiastical furniture made of massive gold and silver.

Metal-Work in Italy.—It was therefore to Byzantium that Italy turned for metal-workers, and especially for goldsmiths, when, in the 6th to the 8th centuries, the basilica of St Peter's in Rome was enriched with masses of gold and silver for decorations and fittings, the gifts of many donors from Belisarius to Leo III., the mere catalogue of which reads like a tale from the *Arabian Nights*. The gorgeous Pala d'oro, still in St Mark's at Venice, a gold retable covered with delicate reliefs and enriched with enamels and jewels, was the work of Byzantine artists during the 11th century. This work was in progress for more than a hundred years, and was set in its place in 1106 A.D., though still unfinished (see Bellomo, *Pala d'oro di St Marco*, 1847). It was, however, especially for the production of bronze doors for churches, ornamented with panels of cast work in high relief, that Italy obtained the services of Byzantine workmen (see Garrucci, *Arte cristiana*, 1872-1882). One artist, named Staurachios, produced many works of this class, some of which still exist, such as the bronze doors of the cathedral at Amalfi, dated 1066 A.D. Probably by the same artist, though his name was spelled differently, were the bronze doors of San Paolo fuori le Mura, Rome, careful drawings of which exist, though the originals were destroyed in the fire of 1824. Other important examples exist at Ravello (1197), Salerno (1099), Amalfi (1062), Atrani (1087); and doors at Monreale in Sicily and at Trani, signed by an artist named Barisanos (end of the 12th century); the reliefs on these last are remarkable for expression and dignity, in spite of their early rudeness of modelling and ignorance of the human figure. Most of these works in bronze were enriched with fine lines inlaid in silver, and in some cases with a kind of niello or enamel. The technical skill of these Byzantine metal-workers was soon acquired by native Italian artists, who produced many important works in bronze similar in style and execution to those of the Byzantine Greeks. Such, for example, are the bronze doors of San Zenone at Verona (unlike the others, of repoussé, not cast work); those of the Duomo of Pisa, cast in 1180 by Bonannus, and of the Duomo of Troia, the last made in the beginning of the 12th century by Oderisio of Benevento. Another artist, named Roger of Amalfi, worked in the same way; and in the year 1219 the brothers Hubertus and Petrus of Piacenza cast the bronze door for one of the side chapels in San Giovanni in Laterano. One of the most important early specimens of metal-work is the gold and silver altar of Sant' Ambrogio in Milan. In character of work and design it resembles the Venice Pala d'oro, but is still earlier in date, being a gift to the church from Archbishop Angilbert II. in 835 A.D. (see Du Sommerard, and D'Agincourt, *Moyen Âge*). It is signed WOLVINSI MAGISTER PHABER; nothing is known of the artist, but he probably belonged to the semi-Byzantine school of the Rhine provinces; according to Dr Rock he was an Anglo-Saxon goldsmith. It is a very sumptuous work, the front of the altar being entirely of gold, with repoussé reliefs and cloisonné enamels; the back and ends are of silver, with gold ornaments. On the front are figures of Christ and the twelve apostles; the ends and back have reliefs illustrating the life of St Ambrose.

The most important existing work of art in metal of the 13th century is the great candelabrum now in Milan Cathedral. It is of gilt bronze, more than 14 ft. high; it has seven branches for

candles, and its upright stem is supported on four winged dragons. For delicate and spirited execution, together with refined gracefulness of design, it is unsurpassed by any similar work of art. Every one of the numerous little figures with which it is adorned is worthy of study for the beauty and expression of the face, and the dignified arrangement of the drapery (see fig. 3). The semi-conventional open scroll-work of branches and fruit which wind around and frame each figure or group is devised with the most perfect taste and richness of fancy, while each minute part of this great piece of metal-work is finished with all the care that could have been bestowed on the smallest article of gold jewellery. Though something in the grotesque dragons of the base recalls the Byzantine school, yet the beauty of the figures and the keen feeling for graceful curves and folds in the drapery point to a native Italian as being the artist who produced this wonderful work of art. There is a cast in the Victoria and Albert Museum.



FIG. 4.—Silver Repoussé Reliefs from the Pistoia Retable.

During the 13th and 14th centuries in Italy the widespread influence of Nicola Pisano and his school encouraged the sculptor to use marble rather than bronze for his work. At this period wrought iron came into general use in the form of screens for chapels and tombs, and grills for windows. These are mostly of great beauty, and show remarkable skill in the use of the hammer, as well as power in adapting the design to the requirements of the material. Among the finest examples of this sort of work are the screens round the tombs of the Scala family at Verona, 1350-1375,—a sort of network of light cusped quatrefoils, each filled up with a small ladder (scala) in allusion to the name of the family. The most elaborate specimen of this wrought work is the screen to the Rinuccini chapel in Santa Croce, Florence, of 1371, in which moulded pillars and window-like tracery have been wrought and modelled by the hammer with extraordinary skill (see Wyatt, *Metal-Work of Middle Ages*). Of about the same date are the almost equally magnificent screens in, Sta Trinita, Florence, and at Siena across the chapel in the Palazzo Pubblico. The main part of most of these screens is filled in with quatrefoils, and at the top is an open frieze formed of plate iron pierced, repoussé, and enriched with engraving. In the 14th century great quantities of objects for ecclesiastical use were

produced in Italy. The silver altar of the Florence baptistry was begun in the first half of the 14th century, and not completed till after 1477 (see *Gas. des beaux-arts*, Jan. 1883). The greatest artists in metal laboured on it in succession, among them Orcagna, Ghiberti, Verrocchio, Ant. Pollaiuolo and many others. It has elaborate reliefs in repoussé work, cast canopies and minute statuettes, with the further enrichment of translucent coloured enamels. The silver altar and retable of Pistoia Cathedral (see fig. 4), and the great shrine at Orvieto, are works of the same class, and of equal importance.

Whole volumes might be devoted to the magnificent works in bronze produced by the Florentine artists of this century, works such as the baptistry gates by Ghiberti, the statues of Verrocchio, Donatello and many others, the bronze screen in Prato cathedral by Simone, brother of Donatello, in 1444-1461, and the screen and bronze ornaments of the tomb of Piero and Giovanni dei Medici in San Lorenzo, Florence, by Verrocchio, in 1472. At the latter part of the 15th century and the beginning of the 16th the Pollaiuoli, Ricci and other artists devoted much labour and artistic skill to the production of candlesticks and smaller objects of bronze, such as door-knockers, many of which are works of the greatest beauty. The candlesticks in the Certosa near Pavia, and in the cathedrals of Venice and Padua, are the finest examples of these. Niccolò Grossi, who worked in wrought iron under the patronage of Lorenzo dei Medici, produced some wonderful specimens of metal-work, such as the candlesticks, lanterns, and rings fixed at intervals round the outside of the great palaces (see fig. 5). The Strozzi palace in Florence and the Palazzo del Magnifico at Siena have fine specimens of these — the former of wrought iron, the latter in cast bronze. At Venice



FIG. 5.—Wrought-iron Candle Pricket; late 15th-century. Florentine work.

fine work in metal, such as salvers and vases, was being produced, of almost Oriental design, and in some cases the work of resident Arab artificers. In the 16th century Benvenuto Cellini was supreme for skill in the production of enamelled jewellery, plate and even larger works of sculpture (see Plon's *Ben. Cellini*, 1882), and Giovanni de Bologna in the latter part of the same century inherited to some extent the skill and artistic power of the great 15th-century artists.

Spain.—From a very early period the metal-workers of Spain have been distinguished for their skill, especially in the use of the precious metals. A very remarkable set of specimens of goldsmith's work of the 7th century are the eleven votive crowns, two crosses and other objects found in 1858 at Guarrazar, and now preserved at Madrid and in Paris in the Cluny Museum (see Du Sommerard, *Musée de Cluny*, 1852). Magnificent works in silver, such as shrines, altar crosses and church vessels of all kinds, were produced in Spain from the 14th to the 16th century—especially a number of sumptuous tabernacles (*custodia*) for the host, magnificent examples of which still exist in the cathedrals of Toledo and Seville. The bronze and wrought-iron screens—*rejas*, mostly of the 15th and 16th centuries—to be found in almost every important church in Spain are very fine examples of metal-work. They generally have moulded rails or balusters, and rich friezes of pierced and repoussé work, the whole being often thickly plated with silver. The common use of metal for pulpits is a peculiarity

of Spain, they are sometimes of bronze, as the pairs in Burgos and Toledo cathedrals, or in wrought iron, like those at Zamora and in the church of San Gil, Burgos. The great candellabrum or *lenerbrarium* in Seville Cathedral is the finest specimen of 16th-century metal-work in Spain; it was mainly the work of Bart. Morel in 1562. It is of cast bronze enriched with delicate scroll-work foliage, and with numbers of well-modelled statuettes. Especially in the art of metal-work Spain was much influenced in the 15th and 16th centuries by both Italy and Germany, so that numberless Spanish objects produced at that time owe little or nothing to native designers. At an earlier period Arab and Moorish influence is no less apparent.

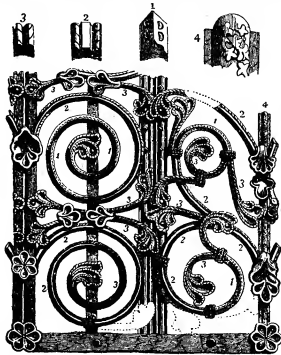

FIG. 6.—Part of the "Eleanor Grill."

England.—In Saxon times the English metal-workers, especially of the precious metals, possessed great skill, and appear to have produced shrines, altar-frontals, retables and other ecclesiastical furniture of considerable size and magnificence. Dunstan, archbishop of Canterbury (925-988), like Bernard, bishop of Hildesheim a few years later, and St Elói of France three centuries earlier, was himself a skilful worker in all kinds of metal. The description of the gold and silver retable given to the high altar of Ely by Abbot Theodwin in the 11th century, shows it to have been a large and elaborate piece of work decorated with many reliefs and figures in the round. In 1241 Henry III. gave the order for the great gold shrine to contain the bones of Edward the Confessor. It was the work of members of the Otho family, among whom the goldsmith's and coiner's crafts appear to have been long hereditary. Countless other important works in the precious metals adorned every abbey and cathedral church in the kingdom. In the 13th century the English workers in wrought iron were especially skilful. The grill over the tomb of Queen Eleanor at Westminster, by Thomas de Leghton, made about 1294, is a remarkable example of skill in welding and modelling with the hammer (see fig. 6). The rich and graceful iron hinges, made often for small and out-of-the-way country churches, are a large and important class in the list of English wrought-iron work. Those on the refectory door of Merton College, Oxford, are a beautiful and well-preserved example dating from the 14th century. More mechanical in execution, though still very rich in effect, is that sort of iron tracery work produced by cutting out patterns in plate, and superimposing one plate over the other, so as to give richness of effect by the shadows

produced by these varying planes. The screen by Henry V.'s tomb at Westminster is a good early specimen of this kind of work. The screen to Bishop West's chapel at Ely, and that round Edward VI.'s tomb at Windsor, both made towards the end of the 15th century, are the most magnificent English examples of wrought iron; and much wrought-iron work of great beauty was produced at the beginning of the 18th century, especially under the superintendence of Sir Christopher Wren (see Ebbetts, *Iron Work of 17th and 18th Centuries*, 1880). Large flowing leaves of acanthus and other plants were beaten out with wonderful spirit and beauty of curve. The gates from Hampton Court are the finest examples of this class of work (see fig. 7).

From an early period bronze and latten (a variety of brass) were much used in England for the smaller objects both of ecclesiastical and domestic use, but except for tombs and lecterns were but little used on a large scale till the 16th century. The full-length recumbent effigies of Henry III. and Queen Eleanor at Westminster, cast in bronze by the "cire perdue" process, and thickly gilt, are equal, if not superior, in artistic beauty to any sculptor's work of the same period (end of the 13th century) that was produced in Italy or elsewhere. These



FIG. 7.—Part of one of the Hampton Court Gates.

effigies are the work of an Englishman named William Torek. The gates to Henry VII.'s chapel, and the screen round his tomb at Westminster (see fig. 8), are very elaborate and beautiful examples of "latten" work, showing the greatest technical skill in the founder's art. In latten also were produced the numerous monumental brasses of which a large number still exist in England (see BRASSES, MONUMENTAL).

In addition to its chief use as a roof covering, lead was sometimes used in England for making fonts, generally tub-shaped, with figures cast in relief. Many examples exist: e.g. at Tidenham, Gloucestershire; Warborough and Dorchester Oxon; Chilton, Wilts; and other places.

Germany.—Unlike England, Germany in the 10th and 11th centuries produced large and elaborate works in cast bronze, especially doors for churches, most resembling the contemporary doors made in Italy under Byzantine influence. Bernward, bishop of Hildesheim, 992-1022, was especially skilled in this

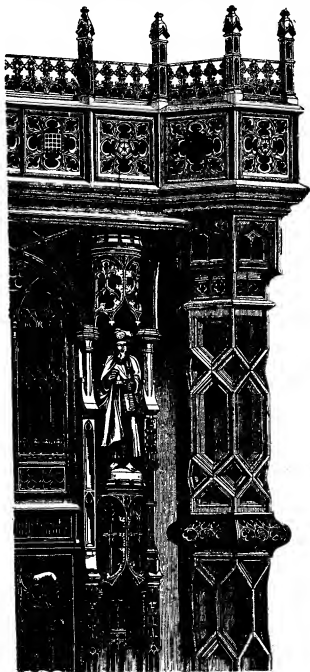

FIG. 8.—Part of Henry VII.'s Bronze Screen.

work, and was much influenced in design by a visit to Rome in the suite of Otho III. The bronze column with winding reliefs now at Hildesheim was the result of his study of Trajan's column, and the bronze door which he made for his own cathedral shows classical influence, especially in the composition of the drapery of the figures in the panels. The bronze doors of Augsburg (1047-1072) are similar in style. The bronze tomb of Rudolph of Swabia in Merseburg Cathedral (1080) is another fine work of the same school. The production of works in gold and silver was also carried on vigorously in Germany. The shrine of the three kings at Cologne is the finest surviving example. At a later time Augsburg and Nuremberg were the chief centres for the production of artistic works in the

various metals. Hermann Vischer, in the 15th century, and his son and grandsons were very remarkable as bronze founders. The font at Wittenberg, decorated with reliefs of the apostles, was the work of the elder Vischer, while Peter and his son produced, among other important works, the shrine of St Sebald at Nuremberg, a work of great finish and of astonishing richness of fancy in its design. The tomb of Maximilian I., and the statues round it, at Innsbruck, begun in 1521, are perhaps the most meritorious German work of this class in the 16th century, and show considerable Italian influence. In wrought iron the German smiths, especially during the 15th century, greatly excelled. Almost peculiar to Germany is the use of wrought iron for grave-crosses and sepulchral monuments, of which the Nuremberg and other cemeteries contain fine examples. Many elaborate well-canopies were made in wrought iron, and gave



FIG. 9.—Brass Vase, pierced and gilt; 17th century Persian work.

full play to the fancy and invention of the smith. The celebrated 15th-century example over the well at Antwerp, attributed to Quintin Metsys, is the finest of these.

France.—From the time of the Romans the city of Limoges has been celebrated for all sorts of metal-work, and especially for brass enriched with enamel. In the 13th and 14th centuries many life-size sepulchral effigies were made of beaten copper or bronze, and ornamented by various-coloured "champlevé" enamels. The beauty of these effigies led to their being imported into England; most are now destroyed, but a fine specimen still exists at Westminster on the tomb of William de Valence (1296). In the ornamental iron-work for doors the French smiths were pre-eminent for the richness of design and skilful treatment of their metal. Probably no examples surpass those on the west doors of Notre Dame in Paris—unhappily much falsified by restoration. The crockets and finials on the *fûches* of Amiens and Rheims are beautiful specimens of a highly ornamental treatment of cast lead, for which France was especially celebrated. In most respects, however, the development of

the various kinds of metal-working went through much the same stages as in England.

Persia and Damascus.—The metal-workers of the East, especially in brass and steel, were renowned for their skill even in the time of Theophilus, the monkish writer on the subject in the 13th century. But it was during the reign of Shah Abbas I. (d. 1628) that the greatest amount of skill both in design and execution was reached by the Persian workmen. Delicate pierced vessels of gilt brass, enriched by tooling and inlay of gold and silver, were among the chief specialties of the Persians (see fig. 9). A process called by Europeans "damascening" (from Damascus, the chief seat of the export) was used to produce very delicate and rich surface ornament. A pattern was incised with a graver in iron or steel, and then gold wire was beaten into the sunk lines, the whole surface being then smoothed and polished. In the time of Cellini this process was copied in Italy, and largely used, especially for the decoration of weapons and armour. The repoussé process both for brass and silver was much used by Oriental workers, and even now fine works of this class are produced in the East, old designs still being adhered to. (J. H. M.)

Modern Art Metal-Work.—The term "art metal-work" is applied to those works in metal in which beauty of form or decorative effect is the first consideration, irrespective of whether the object is intended for use or is merely ornamental; and it embraces any article from a Birmingham brass bedstead to works of the highest artistic merit. The term, as definitely distinguishing one branch of metal-working from another, is objected to by many on the ground that no such prefix was required in the best periods of art, and that allied crafts continue to do without it to the present day. Indeed, as long as metal-working remained a handicraft—in other words, until the introduction of steam machinery—every article, however humble its purpose, seems to have been endowed with some traditional beauty of form. The robust, florid and distinctly Roman rendering of the classic, which followed the refined and attenuated treatment associated with the architecture of the brothers Adam, who died in 1792 and 1794, is the last development in England which can be regarded as a national style. The massively moulded ornolu stair balustrade of Northumberland House, now at 49 Prince's Gate; the candelabra at Windsor and Buckingham Palace, produced in Birmingham by the firm of Messenger; the cast-iron railings with javelin heads and lictors' fasces, the tripods, Corinthian column standard lamps and candelabra, boat-shaped oil lamps and tent-shaped lustres with classic mountings, are examples of the metal-work of a style which, outside the eccentric Brighton Pavilion and excursions into Gothic and Elizabethan, was universally accepted in the United Kingdom from the days of the Regency until after the accession of Victoria. Except perhaps the silversmiths, no one was conscious of being engaged in "art metal-working," yet the average is neither vulgar nor in bad taste, and the larger works are both dignified and suited to their architectural surroundings.

The introduction of gas as an illuminant, about 1816, at once induced a large demand and a novel description of metal fitting; and the craft fell under the control of a new commercial class, intent on breaking with past traditions, and utilizing steam power, electro-deposition, and every mechanical and scientific invention tending to economize metal or labour. But when all artistic perception in Great Britain appeared lost in admiration of the triumphs of machinery and the expansion of trade, a new influence in art matters, that of the prince consort, began to make itself felt. The Great Exhibition, state-aided schools of design, the South Kensington Museum, and the establishment of a Science and Art Department under Government, were among the results of the important art revival which he inaugurated. He is credited with having himself designed candelabra and other objects in metal, and he directly encouraged the production of the sumptuous treatise on metal-work by Digby Wyatt, which laid the foundations of the revival. To this work, and that of Owen Jones, can be traced the origin of the

eclecticism which has laid all past styles of art under contribution. The Gothic revival also helped the recognition of art, without very directly affecting the movement. It was valuable in teaching how to work within definite limitations, but without slavish copying; it also emancipated a considerable body of craftsmen from the tyranny of manufacturers whose sole idea was that machine-work should supersede handicraft. Its greatest efforts were the metal chancel-screens designed by Sir G. G. Scott, that for Hereford Cathedral having been exhibited in 1862. It does not appear that the influence either of Owen Jones or Digby Wyatt on metal-working extended beyond bringing the variety and beauty of past styles to the direct notice of designers. Neither can the London silversmiths, though they employed the best talent available, particularly in the decade following the Great Exhibition of 1851, be credited with much influencing the art metal revival. They were rivalled by Elkington of Birmingham, who secured the permanent assistance of at least one fine artist, Morel Ladeuil, the producer of the Elcho Challenge Shield. Perhaps the first actual designer to make a lasting impression on the crafts was Thomas Jeckyll, some of whose work, including gates for Sandringham, was exhibited in 1862. Infinitely greater as a designer was Alfred Stevens, whose influence on English craftsmen might be regarded as almost comparable to that of Michelangelo on that of his Italian contemporaries. Stevens's designs certainly directly raised the standard of production in several metal-working firms by whom he was employed; whilst in the Wellington Memorial in St Paul's Cathedral, and in Dorchester House, his work is seen unfettered by commercial considerations. Omitting many whose occasional designs have had little influence on the development of the metal crafts, we come to Alfred Gilbert, whose influence for a time was scarcely less than that of Stevens himself. Monumental works, such as his statue of Queen Victoria at Winchester and his work at Windsor, may be handed down as his greatest achievements, but judged as art metal-work, his smaller productions, such as the centrepiece presented by the army and navy to Queen Victoria on her Jubilee, have been more important.

The charming bronze statuettes of Onslow Ford, the most representative of which are in the Tate Gallery; the work of George Frampton, as seen in the Mitchell Memorial; and the beautiful bas-reliefs of W. Stirling Lee, examples of which are the bronze gates of the Adelphi Bank at Liverpool, have all contributed, especially when applied to architectural decoration, to a high standard of excellence. Painters also have frequently designed and modelled for metal-work, for example, Lord Leighton, who produced bronze statuettes of most refined character; and Sir L. Alma-Tadema, who designed the grilles for his studio and entrance hall; but none so conspicuously as Professor H. von Herkomer, who, whether working in gold and enamel, iron, or his favourite alloy, pewter, infuses a freshness into his designs and methods which displays an unusual mastery over materials.

The gift of reproducing effects of nature or art by brush or chisel is not necessarily accompanied by power to design; but a noteworthy exponent of the dual faculty is G. C. Haité, whose designs are widely applied.

It is chiefly to architecture that metal-work owes its permanent artistic improvement. In England buildings of Norman Shaw and Ernest George demanded quiet and harmonious metal-work; and the custom of these architects of superintending and designing every detail, even for interiors, created the supply. The work of every worthy architect raises the standard of the crafts; but beyond others Messrs Ashbee, Lethaby and Wilson have taken an active personal interest in schools of metal-work. The technical schools have also been of immense service in creating a class of self-respecting craftsmen, whose wages enable them to regard their work as worthy occupation abounding in interest. Home industries such as the metal-working round Keswick (founded in 1884 by Canon and Mrs Rawnsley), executed during hours of idleness by field labourers and railway porters, educate the passer-by as well as the worker.

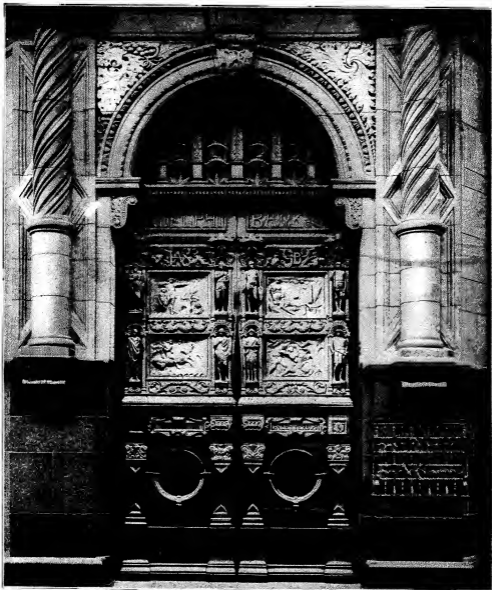

CAST BRONZE GATES, ADELPHI BANK, LIVERPOOL.

Designed by W. D. CAROË, the figures by STIRLING LEE, executed by STARKIE GARDNER AND CO.

METAL-WORK



RAIN-WATER HEAD, IN LEAD, FOR THE VICTORIA LAW COURTS, BIRMINGHAM.
Designed by ASTON WEBB and INGRES BELL, and executed by DENT AND HELLIER.



COVERED BRIDGE OF IRON, SHEATHED IN CAST LEAD, GRAND HOTEL, LONDON.
Designed by WILLIAM WOODWARD, and executed by STARRIE GARDNER AND CO.

British architects and artists who design for the principal decorating firms are to-day as conversant with the Renaissance and succeeding styles of France and Italy as medieval revivalists were familiar with the Gothic styles with which they made us so well acquainted. Metal-work more or less based upon every kind of past style is produced in vast quantities, and in some cases so skilful are the workers that modern forgeries and reproductions are almost beyond the power of experts to detect. This large class of designers and craftsmen, to whom a thorough knowledge of the history of design is a necessity, follows and develops traditional lines. The new art school, on the contrary, breaks wholly with tradition, unless unconsciously influenced by the Japanese, and awards the highest place to originality in design. It is not to be expected that an art-revival following on, and in possession of, all the results of a period of unprecedented activity in scientific research should proceed with the same restraint as heretofore; but the unfettered activity, and the general encouragement to abandon the traditions of art, have no exact parallel in the past, and may yet prove a danger. It is perhaps the very rapidity of the movement that is likely to retard its progress, and to fail to carry with it the wealthy clients and the decorators they employ, or perhaps even to increase the disposition to cling to the reproductions of the styles of the 17th and 18th centuries. The multiplication of art periodicals, lectures, books, photographs, meetings of societies and guilds, museums, schools of arts and crafts, polytechnics, scholarships, facilities for travel, exhibitions, even those of the Royal Academy, to which objects of applied art are now admitted, not only encourages many persons to become workers and designers in the applied arts, but exposes everything to the plagiarist, who travels the freshest idea before it has well left the hands of its originator. Thus the inspirations of genius, appropriated by those who imperfectly appreciate their subtle beauty and quality, become hackneyed and lose their charm and interest. The keen desire to be unconventional in applied art has spread from Great Britain and the United States to Germany, Austria and other countries, but without well-defined first principles, or limitations. It seems agreed in a general way that the completed work in metal is to be wholly the conception and, as far as possible, the actual handiwork of the designer: casting by the *cire-perdue* process, left practically untouched from the mould, and embossing, being the two most favoured processes. The female figure is largely made use of, and rich and harmonious colours are sought, the glitter of metal being invariably subdued by deadening its lustre, or by patinas and oxides. Gilding, stains and lacquers, electro-plating, chasing, "matting," frosting, burnishing, mechanically produced mouldings and enrichments, and the other processes esteemed in the 19th century, are disused and avoided. New contrasts are formed by the juxtaposition of differently toned metals; or these with an inlay of haliothis shell, introduced by Alfred Gilbert; or of coloured wax, favoured by Onslow Ford; or enamelling, perfected by Professor von Herkomer; or stained ivory, pearls, or semi-precious stones. The quality of the surface left by the skilled artist or artisan is more regarded than symmetry of design, or even than correct modelling. Frequently only the important parts in a design are carefully finished and the rest merely sketched: the mode of working, whether by modelling-tools or hammer, being always left apparent.

The newer kinds of art metal-work have, until recently, reached the purchaser direct from the producer's workshop; but they may now also be seen in the shops of silversmiths, jewellers, and general dealers, who are thus helping to transfer production from large commercial manufactories to smaller ateliers under artistic control. The production of the larger household accessories, such as bedsteads, fenders, gas and electric fittings, clocks, &c., has hardly as yet come under the influence of the art movement. The services rendered by Mr W. A. S. Benson of Chiswick, who commenced about 1886 to revolutionize the production of sheet-brass and copper utensils, cannot be passed over. The average ecclesiastical

metal-work has rather receded than progressed in merit, except when designed by architects and executed under their supervision. Though the demand for good domestic wrought-iron work has enormously increased, adaptations from the beautiful work of the 17th and 18th centuries have been found so suited to their architectural surroundings, that new departures have been relatively uncommon. Of such the gates for Sandringham, by Jeckyll; for Crewe Hall, by Charles Barry; and for the Victoria and Albert Museum, by Gamble, are the earliest and best known. Of the vast number designed upon traditional lines may be cited those for Lambton Castle, Welbeck, Eaton Hall, Twickenham, Cliveden, and the Astor Estate Office on the Victoria Embankment. Cast iron, brought to perfection by the Coalbrookdale Company about 1860, but now little esteemed, owing to the poverty of design which so often counterfeits smiths' work, presents great opportunities to founders possessing taste or willing to submit to artistic control. A very large field is also opening for cast-lead work, whether associated with architecture, as in the leaden covered-way over Northumberland Street, in London (see Plate), and the fine rain-water heads of the Birmingham Law Courts (see Plate), or with the revival of the use of metal statuary and vases in gardens. The subdued colour and soft contours of pewter render it once more a favoured material, peculiarly adapted to the methods of the art revival, and perhaps destined to supersede electro-plate for household purposes. In silver-work the proportion of new art designs exhibited by dealers and others is still relatively small; but jewellers, except when setting pure brilliants and pearls, are becoming more inclined to make their jewels of finely modelled gold and enamel enriched with precious and semi-precious stones, than of gems merely held together by wholly subordinate settings.

On the continent of Europe, France was the first to recognize the merits of its bygone designers and craftsmen, and even antecedent to the Exhibition of 1857, when art in Great Britain was dormant, it was possible to obtain in Paris faithful reproductions of the finest ormolu work of the 18th century. At the same time a most active production of modern designs was proceeding, stimulated by rewards, with the result that the supply of clocks, lamps, candelabra, statuettes, and other ornaments in bronze and zinc to the rest of Europe became a monopoly of Paris for nearly half a century. In all connected with their own homes the French adhere to their traditions far more than other nations, and the attempt at originality in the introduction of metal-work into the scheme of decoration of a room is almost unknown. In the domain of bronze and imitation bronze statuary the originality of the French is absolutely unrivalled. And not only in bronze, but in Paris jewellery, enamels, silver, pewter and iron work a cultured refinement is apparent, beside which other productions, even the most finished, appear crude. The French artist attains his ideal, and it is difficult to imagine, from his standpoint, that the metal-work of the present can be surpassed. The best English metal-worker, on the contrary, is probably not often quite satisfied with the results he attains, perhaps because in Great Britain the pursuit of art has for centuries been fitful and individual, while in France art traditions are hereditary. The metal-work of Belgium is based at present entirely on that of France, without attaining the same standard, unless designed for ecclesiastical uses. In Holland these crafts have not progressed. Italian metal-workers are mainly employed in reproduction; but traditions linger in some remote parts, while the sporadic appearance of craftsmen of a high order is evidence that the ancient artistic spirit is not wholly extinct. Similarly, the surprising damascening by Messrs Zuluaga of Madrid in the monument to General Prim, and that of Alvarez of Toledo, give hope that the Spanish craftsman only needs to be properly directed. German and Austrian workers had for years shown more energy than originality, but they have recently embraced the newest English developments and carried them to extremes of exaggeration. For really fresh and progressive indigenous art we may perhaps have, in the near future, to turn to America

and to Russia, where, having little artistic past to refer to, designers and craftsmen display unequalled individuality and force. It is from the Far East, however, that the most serious rivalry may be anticipated. The metal-work of China and Japan, so pleasantly naive and inexpensive, though becoming undesirably modified as to design through contact with European buyers, is losing none of its matchless technique, which indeed in Japan is still being developed. In any history of the art revival the influence of such firms as Barbedienne and Christofle in Paris and Tiffany in New York cannot be ignored.

Industrial Metal-Work.

(J. S. G.)

The malleability and ductility of metals lie at the basis of the work of the gold- and silver-smiths at one extreme, and of the boiler-maker at the other. Sheet metals can be made to assume almost any shape under the hammer, or by pressure, provided they are subjected to annealing to restore the property of malleability. The most awkward shapes, involving excessive extensions of metal, are produced by drawing processes between dies of iron and steel in power presses. All the common domestic utensils in tinned and enamelled ware, and all the ordinary patterns of the silversmiths, are similarly done. Frequent annealings are a necessary and frequent fraction of the metal; but, in these, the observance of certain other precautions of a practical character the degree of extension possible is enormous. Another illustration of the malleability of metal is afforded by metal spinning. A sheet of metal set revolving at a high speed in a lathe is bent over into cup-shaped forms with numerous mouldings, by a blunt hardened tool. A great deal of work is done in this way, though this sphere has also been invaded by the draw presses, whose output would seem incredible to those not familiar with the work. Objects that do not require annealing are produced by dozens per minute, and all the movements of feeding and stamping and removal are often automatic. The ductility of metals and alloys is utilized in wire and tube-drawing through dies on long benches. This work also requires frequent annealing, for otherwise the wires or tubes would rupture. Even hard steel is treated in this way to form tubes for the highest hydraulic and steam pressures.

Platers' Work (see **BOILER**) is distinguished from work in sheet metals by the fact that plates have considerable thickness, which sheets have not, and that their thickness ranges from $\frac{1}{8}$ in. to 1 in. or more, but for most purposes they do not go beyond $\frac{1}{2}$ in. or 1 in. Over these thicknesses they are used chiefly for the largest marine boilers. Armour plates which are several inches in thickness do not come in this group, being a special article of manufacture. Sheets are of thicknesses of less than $\frac{1}{2}$ in. This distinction of thickness is of importance in its bearing on workshop practice. A thin sheet requires a very different kind of treatment from a thick plate. Not only is more powerful machinery required for the latter, but in bending it allowance has to be made for the difference in radius of the outer and inner layers which increases with increase of thickness. Short, sharp bends which are readily made in thin sheets cannot be done in thick plates, as the metal would be stressed too much in the outer layers. The methods of union also differ, riveting being adopted for thick plates, and soldering or brazing generally for thin.

Coppersmiths' Work is an important section of sheet-metal working. It is divided into two great departments: the domestic utensil side, on which the brazier's craft is exercised; and the engineering side, which is concerned in some engine-work, locomotive and marine, and in the manufacture of brewers' utensils. The methods of the first are allied to those of the tinman, those of the second to the methods of the plater. Tinsmiths' work resembles the lighter part of the work of the coppersmith. There is no essential difference in dealing with tin (*i.e.* sheets of iron or steel coated with tin) and copper of the same thickness. Hence the craft of tinmen and braziers is carried on by the same individuals. There are, however, differences of treatment in detail, because copper is more malleable and softer than tin plate. The geometry of sheet-metal work and of platers' and boiler-makers' work is identical up to a certain stage. The divergence appears when plates are substituted for sheets. A thin sheet has for all practical purposes no thickness—that is, the geometrical pattern marked on it will develop the object required after it is bent. Nearly all patterns are the developments of the envelopes of geometrical solids of regular or irregular outlines, few of plane faces; when they are made up of combinations of plane faces, or of faces curved in one plane only, there is no difference in dealing with thin sheets or thick plates. But when curving occurs in different planes at right or other angles (hollowing), the metal has to be drawn or extended on the outside, and important differences arise. A typical form is the hemisphere, from which many modified forms are derived. The production of this is always a tedious task. It involves details of "wrinkling" and "raising," if done by hand-work in copper. In thick plates it is not attempted by hand, but pressing is done between dies, or segments of the sphere are prepared separately and riveted together. In tin it is effected by stamping. In all work done in thick plates the dimensions marked out must have reference to the final shape of the article. Generally

the dimensions are taken as in the middle of the plate, but they may be on the inside or outside according to circumstances. But in any case the thickness must enter into the calculations, whereas in thin sheets no account is taken of thickness.

Raised Work.—All the works in sheet metal that are bent in one plane only are easily made. The shapes of all polygonal and all cylindrical and conical forms are obtained by simple development—that is, the envelopments of these bodies are marked out on a flat plane, and when cut, are bent or folded to give the required envelopes. Only common geometrical problems are involved in the case of sheets of sensible thickness, and allowances are made for thickness. But in those forms where curving must take place in different directions the layers or fibres of metal are made to glide over one another, extension taking place in some layers but not in others, and this goes on without producing much reduction in the thickness. This is also possible with malleable and ductile metals and alloys. As a general rule it is restricted to metals which are not cast, or, with some slight exceptions, it is impossible to produce relative movements of the layers in cast iron, steel or cast brass. But most rolled metals and alloys can be so treated, copper being the best for the purpose. The methods employed are "raising" by the hammer, and pressing in dies. But the severity of the treatment would tear the material asunder if rearrangement of the particles were not abated by frequent annealing (*q.v.*).

There has been a habit of beating into concave form from a flat thin sheet the outer portions of mugs, hammered until they occupy smaller dimensions than on the flat sheet. If a circular disk is wrought into a hemisphere and the attempt is made to hammer the edges round, crumpling must occur. This in fact is the first operation, termed wrinkling, the edge showing a series of flutes. These flutes have to be obliterated by another series of hammerings termed raising. The result is that the object assumes a smooth concave and convex shape, without the thickness of the metal becoming reduced.

Cast Work.—The metals and alloys which are neither malleable nor ductile can only be worked into required shapes by melting and casting in moulds. Abundance of remains which date from the Neolithic period testify to the high antiquity of this class of work, and also to the great skill which the ancient founders had acquired. Statue-founding is a highly specialized department of metal-work, in which the artists of the middle ages excelled. Two methods have been employed, the *cire-perdue*, or wax process (see above), and the present, or all sand method. In the latter the artist provides a model in plaster from which the founder casts the mould within an encircling box. This mould must obviously be made in scores of little separate sections (false cores or drawbacks) to permit of their removal from the model without causing fracture of the sand. These are subsequently replaced piece by piece in the encircling frame, and a core made within it, leaving a space of $\frac{1}{4}$ in. or thereabouts into which the metal is poured. The advantage of this process is that the artist's model is not destroyed as in the *cire-perdue*, and if a waster results, a second mould can be taken. A large statue occupies from one to three months in the moulding.

The extreme tenacity of objects which are hammered, drawn or rolled cannot for obvious reasons be attained by casting. Casting also is complicated by the shrinkage which occurs in cooling down from the molten state, and in some alloys by the formation of eutectics, and the liquation of some constituents. The temperature of pouring is now known to be of more importance than was formerly suspected. The after-treatment of castings by annealing exercises great influence on results in malleable cast iron and steel.

There are many metals and alloys which are malleable and ductile, and also readily fused and cast. This is the case with gold, silver, copper, tin, lead and others, and especially with low carbon steel, which is first cast as an ingot, then annealed and rolled into plates as well as the thinnest sheets. The ancient wootz, and the products of the native furnaces of Africa are first cast, then hammered out thin. Many of the patent bronzes are by slight variations in the proportions of the constituents made suitable for casting, for forging, and for rolling into sheets. But in all the great modern manufacturing processes it is true that metals and alloys, though of the same name, have different composition according as they are intended for casting on the one hand, and for forging, rolling and drawing on the other. Wrought or malleable iron has less of carbon and other elements in its composition than has cast iron. Steel intended for castings has slightly more carbon and other elements than the cast-steel ingot intended for rolling into plates. So also with the numerous bronzes, the phosphor, the delta, the aluminium and other alloys of copper; each is made in several grades to render it suitable for different kinds of treatment.

The art of the manufacturer of which the craftsman is able to vary the composition and physical qualities so extensively as the metals and their alloys. Much light has been thrown on facts which have long been known in a practical way, by the labours of the Alloys Research Committee of the Institution of Mechanical Engineers (England). These, together with independent researches into the heat treatment of steel and iron, have opened up many unsolved problems fraught with deepest interest and importance.

One of the most difficult problems with which the metal-worker

who handles constructional forms has to deal is the maintenance of a due relation between absolute strength and a useful degree of elasticity. Only after many failures has the fact been grasped that a very high degree of strength is inconsistent with a trustworthy degree of elasticity. The reasons were not understood until the researches of Wöhler demonstrated the difference between the effects of merely dead loads and of live loads, and between repetitions of stress of one kind only, and the vastly more destructive effects of both kinds alternating.

The texture of metals and alloys is related to the character of the operations which can be done upon them. Broadly the malleable and ductile metals and alloys show a fibrous character when ruptured, the fusible ones a crystalline fracture. The difference is seen both in the workshop and in the specimens ruptured in testing-machines. A piece of wrought iron, or mild steel or copper, if torn asunder shows long lustrous fibres, resembling a bundle of threads in appearance. A piece of cast iron, or steel or bronze, shows on rupture a granular, crystalline surface destitute of any fibre. The ductile metals and alloys also extend from 10 to 30% with reduction of area before they fracture, the crystalline ones snap shortly without warning. In some instances, however, the method of application of stress exercises an influence. Wrought iron and mild steel may be made to show a short and crystalline fracture by a sudden application of stress, while if drawn asunder slowly they develop the silky, fibrous appearance. The men who design and work in metals have to take account of these vital differences and characteristics, and must be careful not to apply treatment suitable to one kind to another of a dissimilar character. Tools, appliances and methods have to be adapted to the work of the smith, the sheet-metal worker and the founder, there is a great gulf. An artistic taste will recognize the essential differences, and not endeavour, apart from questions of strength, to graft a design suitable for one on another. It is bad taste to imitate the tracery of the ductile wrought iron in cast designs, the foliations of ancient wrought-iron grilles and screens in heavy cast iron. Severe simplicity is also most in harmony with constructional designs in plated work, where stresses occur in straight lines. From this point of view the lattice-girder bridge is an ideal design in steel.

One of the most valuable characteristics of the iron alloys is their capacity for hardening, which they owe in the main to the presence of certain small percentages of carbon relatively to minute quantities of other elements: as manganese, tungsten, nickel and others of less importance. The capacity for hardening is an invaluable property not only in regard to cutting-tools, but also in prolonging the life of parts subjected to severe friction. Great advances have been made in the utilization of this property as a result of the growth of the precision grinding-machines, which are able to correct the inaccuracies of hardened work as effectively as those of soft materials. It is utilized in the spindles of machine-tools, in the balls and rollers for high-speed bearings, slides, pivots and such like.

Methods of Union.—The methods of union of works in metal are extremely varied. An advantage in casting is that the most complicated shapes are made in one piece. But all other complicated forms have to be united by other means—as welding, soldering, riveting or bolting. The two first-named are trustworthy, but are evidently unsuitable for the greatest portion of engineers' work, for which riveting and bolting are the methods adopted. Even the simple elements of rivets and bolts have produced immense developments since the days when bolts were made by hand, holes cored or hand-drilled, and rivets formed and closed by hand labour. Nut- and bolt-making machinery, both for forging and screw cutting, operates automatically, and drilling machinery is highly specialized. Hand-riveting on large contracts has been wholly displaced by power-riveting machines. The methods of union adopted are not allowed to impair the strength of structures, which is calculated to the limit. Bolting is used for rivets or bolt-anchors. Hence much ingenuity is exercised in order to obtain the strongest joint which is consistent with security of union. This is the explanation of all the varied forms of riveted joints, which to casual observers often appear to be of a fanciful character.

Protection of Surfaces.—The protection and coloration of metals and alloys includes a large number of industries. The engineer uses paints for his iron and steel. A small amount of work is treated by the Bower-Barff and allied processes, by which a coating of magnetic oxide is left on the metal. Hot tar—Angus Smith's process—is used for water-pipes. Boiler linings are employed as a non-corrosive coating, preventing the application of the lead and iron oxide paints. In steam boilers artificial galvanic couples are often set up by the suspension of zinc plates in the boiler, so that the corrosion of the zinc may preserve the steel boiler plates from waste. Various artificial protective coatings are applied to the plates of steel ships. Bright surfaces are protected with oil or with lacquer. The ornamental bronzes and brasses are generally lacquered, though in engineers' machinery they are as a rule not protected with any coating. For ornamental work lacquering divides favour with colouring—sometimes done with coloured lacquers, but often with the best colourings, of which the copper and iron salts are the chief basis. (J. G. H.)

LITERATURE.—Prehistoric: Worsaae, *Nordiske Oldsager i Kjøbenhavn* (1854); Perrin, *Étude préhistorique—Âge du bronze* (1870). Classical: Layard, *Nineveh and Babylon* (1853); Pliny, *Natural History*, bk. xxvii.; Brøndsted, *Den Fikonomiske Cista* (1847); Gerhard, various monographs (1843-1867); Müller, *Etrusker*, &c., and other works; Ciampi, *Dell' Antica Itonica* (1815); Von Bibra, *Die Bronzen und Kupfer-Legirungen der alten und ältesten Völker* (1856); C. Bischoff, *Das Kupfer in der vorchristlichen Zeit* (1865). Medieval, &c.: Digby Wyatt, *Metal-Work in the Middle Ages* (1849); Shaw, *Oriental Metal-Work* (1836); Drury Fortnum, *S.K.M. Handbook of Bronzes* (1877); King, *Orfèverie et ouvrages en métal du moyen âge* (1852-1854); Helfner-Altenack, *Serrurerie du moyen âge* (1869); Viollet-le-duc, *L'Art du mobilier*, "Serrurerie" and "Orfèverie." (1858 &c.); Dactis, *Trésor de S. Denis, and L'Art du moyen âge* (various dates); Karch, *Die Rathsblätter von der Bronzchüre zu Augsburg* (1869); Krug, *Entwürfe für Gold-, Silber-, und Bronze-Arbeiter*; Linas, *Orfèverie merovingienne* (1864), and *Orfèverie du XIII^{ème} siècle* (1856); Bordeaux, *Serrurerie du moyen âge* (1858); Didron, *Manuel des auteurs de bronze et d'orfèverie du moyen âge* (1859); Du Sommerard, *Arts au moyen âge* (1838-1846), and *Musée de Cluny* (1852); Rico y Sinobas, *Trabajos de metales* (1871); Bock, *Die Goldschmiedekunst des Mittelalters* (1855), and *Kleinodien des heil.-römischen Reiches*; Jouy, *Les gemmes et les bijoux* (1865); Texier, *Dictionnaire d'orfèverie* (1857); Virgil Solis, *Designs for Gold- and Silversmiths* (1512), (facsimile reproduction, 1862); Molinier, *Les Bronzes de la Renaissance* (1886); Servant, *Les bronzes d'art* (1890); Wilhelm Bode, *Italian Bronze Statuettes of the Renaissance* (Eng. trans. by W. Gröber, first 2 vols., 1900). Practical Treatises: Theophilus, *Diversarum artium schedula* (12th cent.). (see *Quellenchriften für Kunstgeschichte*, VII., Vienna 1877); Cellini, *Trattati dell' oreficeria e della scultura* (ed. Milanesi, Florence, 1856); Vasari, *Tré arti del disegno*, pt. ii. (Milanesi's ed., 1882); Garnier, *Manuel du ciseleur* (1859); Haas, *Der Metallarbeiter* (1902).

METAMERISM (Gr. *μετά*, after, *μέρος*, a part), a technical term used in natural science. In chemistry it denotes the existence of different substances containing the same elements in the same proportions and having the same molecular weight; it is a form of isomerism.

In zoology, metamerism is the repetition of parts in an organized body, a phenomenon which is, as E. Haeckel, W. Bateson and others have recognized, only a special case of a tendency to repetition of structural units or parts which finds one expression in bilateral symmetry. It occurs in almost every group of the animal kingdom, but is most conspicuous in segmented worms, arthropods and vertebrates. In certain worms (the Cestoidea and some Planarians) metamerism is accompanied by the separation of the completed metameres one by one from the older (anterior) extremity of the chain (strobilation), but it by no means follows that metamerism segmentation has a necessary origin in such completion and separation of the "meres." On the contrary, metamerism seems to arise from a property of organisms which is sometimes more (eumetamerism) and sometimes less (dysmetamerism) fully exhibited, and in some groups not exhibited at all. The most complete and, at the same time, simplest instances of metamerism segmentation are to be seen in the larger Chaetopods, where some hundreds of segments succeed one another—each practically indistinguishable in structure from the segment in front or from that behind; muscles, right and left appendage or parapodium, colour-pattern of the skin, gut, blood-vessels, coelom, nephridia, nerve-ganglion and nerves are precisely alike in neighbouring segments. The segment which is least like the others is the first, for that carries the mouth and a lobe projecting beyond it—the prostomium. If (as sometimes happens) any of the hinder segments completes itself by developing a prostomium, the chain breaks at that point and the segment which has developed a prostomium becomes the first or head-bearing segment of a new individual. Compare such an instance of metamerism segmentation with that presented by one of the higher Arthropods—e.g. the crayfish. Here the somites are not so clearly marked in the tegumentary structures; nevertheless, by examining the indications given by the paired parapodia, we find that there are twenty-one somites present—a limited definite number which is also the precise number found in all the higher Crustacea.

We can state as a **FIRST LAW** of metamerism or somite formation

¹ The word "LAW" is used in this summary merely as a convenient heading for the statement of a more or less general proposition.

that it is either indefinite in regard to number of metameres or somites produced, or is definite. Animals in the first case we call anomeristic; those in the second case, nomeristic. The nomeristic condition is a higher development, a specialization, of the anomeristic condition.

The SECOND LAW, or generalization, as to metamerism which must be noted is that the meres or somites (excepting the first with its prostomium) may be all practically alike or may differ from one another greatly in modification; the various constituent parts of the mere or somite. Metamerized animals are either homoeromic or hetereromic. The reference of the variation in the form of the essential parts contained in a "metamere" or "somite" introduces us to the necessity of a general term for these constituent or subordinate parts; they may be called "meromes" ($\mu\epsilon\rho\omicron\sigma$). The meromes present in a metamere or somite differ in different annulate or segmented animals according to the general organization of the group to which the animal belongs. As a matter of convenience we distinguish in the Arthropod as meromes, first, the tegumentary chitined plates called terga, placed on the dorsal margin of the somites; second, the similar sternal plates. In Chaetopods we should take next to these the masses of circular and longitudinal muscular fibres of the body-wall and the dorso-ventral muscles. The latter form the third sort of merome present in the Arthropods. The fourth kind of merome is constituted by the parapodia or appendages; the fifth by the coelomic pouches and their ducts and external apertures (coelomo-ducts), whether renal or genital. The sixth by the blood-vessels of the somite; the seventh by the bit of alimentary tract which traverses it; and the eighth by the neuromere (nerve ganglion pair), commissures and connectives of the nerve system.

The THIRD LAW of metamerism is that heteromerism may operate in such a way as to produce definite regions of like modification of the somites and their appendages, differing in their modification from that observed in regions before and behind them. It is convenient to have a special word for such regions of like meres, and we call each a tagma ($\tau\alpha\gamma\mu\alpha$, a regiment). The word "tagmosis" is applicable to the formation of such regions. In the Chaetopods tagmosis always occurs to a small extent so as to form the head. In some Chaetopods, such as *Chaetopterus* and the sedentary forms, this is markedly extensive, extending to three or even many tagmata. In Arthropods, besides the head, we find very frequently other tagmata developed. But it is to be noted that in the higher members of each great class or line of descent, the tagmosis becomes definite and characteristic just as do the total number of meres or somites, whilst in the lower grades of each great class we find what may be regarded as varying examples of tentative tagmosis. The terms nomotagmic and anomotagmic are applicable with the same kind of implication as the terms nomeristic and anomeristic.

The FOURTH LAW of metamerism (auto-heterosis of the meromes) is that the meromes of a somite may be all alike or may be partly and dissimilarly affected by heteromerism. It is common enough for small changes only to occur in the inner visceral meromes whilst the appendages and terga or sterna are largely changed in form. But of equal importance is the independent "heterosis" of these visceral meromes without any corresponding heterosis of the body wall. As instances, we may cite the gizzards of various earthworms and the special localization of renal, genital and gastric meromes, with obliteration elsewhere, in a few somites in Arthropoda.

The FIFTH LAW, relating also to the independence of the meromes as compared with the whole somite, is the law of arhythmicity of the meromes. Metamerism does not always manifest itself in the formation of complete new segments; but one merome may be repeated so as to suggest several metameres, whilst the remaining meromes are, so to speak, out of harmony with it and exhibit no repetition. Thus in the hinder somites of the body of *Apus* the Crustacean we find a series of segments corresponding apparently each to a complete single somite; but when the appendages are examined we find that they have multiplied without relation to the other meromes of a somite; we find that the somites carry from two to seven pairs of appendages, increasing in number as we pass backwards from the genital segment. The appendages are arhythmic meromes in this case. They take on a quasi-independent metameric and are produced in numbers which have no relation to the numbers of the body-rings, muscles and neuromeres. This possibility of the independent metameric multiplication of a single merome must have great importance in the case of dislocated meromes, and no doubt has application to some of the metameric phenomena of Vertebrates.

The SIXTH LAW is the law of dislocation of meromes. This is a very important and striking phenomenon. A merome, such as a pair of appendages (Aranea) or a neuromere of muscular mass (frequent), may (by either a gradual or sudden process, we cannot always say which) quit the metamere to which it belongs, and in which it originated, and pass by actual physical transference to another metamere. Frequently this new position is at a distance of several metameres from that to which the wandering merome belongs in origin. The movement is more usual from behind forwards than in the reverse direction; but this, probably, has no profound significance and depends simply on the fact that, as a rule, the head must be the chief region of development on account of its containing the sense organs and the mouth.

In the Vertebrata the independence of the meromes is more fully developed than in other metameric animals. Not only do we get auto-heterosis of the meromes on a most extensive scale, but the dislocation of single meromes and of whole series (tagmata) of meromes is a common phenomenon. Thus, in fishes the pelvic fins may travel forwards to a thoracic and even jugal position in front of the pectoral fins; the branchiomeromes lose all relation to the position of the meromes of muscular, skeletal, coelomic and nervous nature, and the heart and its vessels may move backwards from their original metameres in the higher Vertebrates carrying nerve-loops with them.

The SEVENTH LAW of metamerism is one which has been pointed out to the writer by E. S. Goodrich. It may be called the law of "translation of heterosis." Whilst actual physical transference of the substance of meromes undeniably takes place in such a case as the passage of the pelvic fins of some fishes to the front of the pectorals, and in the case of the backward movement of the opisthomatic appendages of spiders, yet the more frequent mode in which an alteration in the position of a specialized organ in the series or scale of metameres takes place is not by migration of the actual material organ from somite to somite, but by translation of the quality or morphogenetic peculiarity from somite to somite, accompanied by correlative change in all the somites of the series. The phenomenon may be compared to the transposition of a piece of music to a higher or lower key. It is thus that the lateral fins of fishes move up and down the scale of vertebral somites; and thus that whole regions (tagmata), such as those indicated by the names cervical, thoracic, lumbar and sacral, are translated (accompanied by certain increase or decrease in the total number of somites) so as to occupy differing numerical positions in closely allied forms (cf. the varying number of cervical somites in allied Reptiles and Birds).

What, in this rapid enumeration, we will venture to call the EIGHTH LAW of metamerism is the law of homoecosis, as it is termed by W. Bateson. Homoecosis is the making of a merome into the likeness of one belonging to another metamere, and is the opposite of the process of "heterosis"—already mentioned. We cite this law here because the result of its operation is to simulate the occurrence of a dislocation of meromes and has to be carefully distinguished from that process. A merome can be translated in an individual of abnormality, assume the form and character of the corresponding merome of a distant somite. Thus the antenna of an insect has been found to be replaced by a perfectly well-formed walking leg. After destruction of the eye-stalk of a shrimp a new growth appears, having the form of an antenna. Other cases are frequent in Crustacea, as individual abnormalities. They prove the existence in the mechanism of metameric animals, of structural conditions which are capable of giving these results. What those structural conditions are is a matter for separate inquiry, which we cannot even touch here.

We now come to the questions of the production of new somites or the addition of new somites to the series, and the converse problem of the suppression of somites, whole or partial. We state as the NINTH LAW of metamerism "that new somites or metameres are added to a chain consisting of two or more somites by growth and gradual elaboration—what is called 'budding'—of the anterior border of the hindermost somite. This hindermost somite is therefore different from all the other somites and is called the telosomite. However long or short or heteromerized the chain may be, a new metameric somite or series of produced at the anterior border of the telosomite, except in the Vertebrata." That is the law. But amongst some groups of metameric animals partial exceptions to it occur. It is probably absolutely true for the Arthropoda from lowest to highest. It is not so certain that it is true for the Chaetopoda, and would need modification in statement to meet the cases of fissiparous multiplication occurring among Syllids and Naidids. In the Vertebrata, where tagmosis and heterosis of meromes and dislocation of meromes and tagmata are, so to speak, rampant, new formation of metameres (at any rate as represented by important meromes) takes place at more than one point in the chain. Such points are found where two highly diverse "tagmata" abut on one another. It is possible, though the evidence at present is entirely against the supposition, that at such points in Arthropoda new somites may be formed. Such new somites are said to be "intercalated." The question of the intercalation of vertebrae in the Vertebrata has received some attention. It must be remembered that a vertebra even taken with its muscular, vascular and neural accessories is only a partial metamere—a merome—and that, so far as complete metameres are concerned, the Vertebrata conform to the same law as the Arthropods. Intercalation of meromes or branchial apparatus (fin supports) seems to have taken place in Vertebrata in the fishes, while in higher groups intercalation of vertebrae in large series has been accepted as the only possible explanation of the structural facts established by the comparison of allied groups. The elucidation of this matter forms a very important part of the work lying to the hand of the investigator of vertebrate anatomy, and it is possible that the application of Goodrich's law (the seventh of our list) may throw new light on the matter.

In regard to the diminution in the number of somite in the

course of the historical development of those various groups of metamized animals, which have undoubtedly sprung from ancestors with more numerous somites than they themselves possess, it appears that we may formulate the following laws as the tenth, eleventh, twelfth and thirteenth laws of metamorphism.

The Tenth Law is that individual somites tend to atrophy and finally disappear as distinct structures, most readily at the anterior and the posterior ends of the series constituting an animal body. This is very generally exhibited in the head of Arthropoda, where, however, the operation of the law is largely modified by fusion (see below). With regard to the posterior end of the body, the atrophy of segments does not, as a rule, affect the telson itself so much as the somites in front of it and its power of producing new somites. Sometimes, however, the telson is very minute and nonchitinated (Hexapoda).

The Eleventh Law may be stated thus: any somite in the series which is the anterior or posterior somite of a tagma may become atrophied, reduced in size or partially aborted by the suppression of some of its meromes; and finally, such a somite may disappear and leave no obvious trace in the adult structure of its presence in ancestral forms. This is called the exalation of a somite. Frequently, however, such "exalated" somites are obvious in the embryo or leave some merome (e.g. neuromere, muscle or chitin-plate) which can be detected by minute observation (microscopic) as evidence of their former existence. The somite of the maxillipede (third post-oral appendage) of *Apus caneriformis* is a good example of a somite on its way to exalation. The third pre-oral and the premaxillary somites of Hexapod insects are instances where the only traces of exalated somites are furnished by the microscopic study of early embryos. The praegenital somite of the Arachnida is an example of a somite which is preserved in some members of the group and partially or entirely exalated in other cases, sometimes with fusion of its remnants to neighbouring somites.

The Twelfth Law of metamorphism might very well be placed in logical order as the first. It is the law of *lipomerism*, and asserts that just as the metameres of a single merome, or a series of meromes of the descendants of unisegmental ancestors, so highly metamized forms—i.e. strongly segmented forms with specialized regions of differentiated metameres—may gradually lose their metamized structure and become apparently and practically unisegmental animals. The change here contemplated is not the atrophy of terminal segments one by one so as to reduce the size of the animal and leave it finally as a single somite. On the contrary, no loss of size or of high organization is involved. On the other hand, and gradually, the metameric grouping of the bodily structures disappears. The cuticle ceases to be thickened in rings—the muscles of the body-wall over-run their somite boundaries. Internal septa disappear. The nerve-ganglia concentrate or else become diffused equally along the cords; one pair of renal coelomoducts and one pair of genital coelomoducts grow to large size and remain—the rest disappear. The appendages atrophy or become limited to one or two pairs which are widely separated from their ancestral position. The animal ceases to present any indication of metameric repetition of parts in its entire structure. Degrees in this process are frequently to be recognized. We certainly can observe such a change in the posterior region of some Arthropods, such as the hermit-crabs and the spiders. Admitting that the Echiurids are descended from Chaetopoda, such a change has taken place in them, amounting to little short of complete lipomerism, though not absolutely complete.

Recent suggestions as to the origin of the Mollusca involve the supposition that such an effacement of once well-marked metamorphism has occurred in them, leaving its traces only in a few structures such as the multiple gill-plumes and shell-shields of the Chitons and the duplicated renal sacs of *Nautilus*.

A further matter of importance in this connexion is that when the old metameres have been effaced, a new secondary segmentation may arise, as in the jointed worm-like body of the degenerate *Acariid*, *Demodex folliculorum*.

Such secondary annulation of the soft body calls to mind the secondary annulation of the metameres of leeches and some earth-worms. Space does not permit of more than an allusion to this subject; but it is worth while noting that the secondary annuli marking the somites of leeches and *Lumbricidae* in definite number and character are perhaps comparable to the redundant pairs of appendages on the hinder somites of *Apus*, and are in both cases examples of independent repetition of tegumentary meromes—a sort of ineffectual attempt to subdivide the somite which only prevails on the more-readily susceptible meromes of the integument.

The last law of metamorphism which we shall attempt to formulate here, as the Thirteenth, relates to the fusion or blending of neighbouring somites. Fusion of adjacent somites has often been erroneously interpreted as the study of Arthropoda. There are, in fact, very varying degrees of fusion which need to be carefully distinguished. The following generalization may be formulated. "The homologous meromes of two or more adjacent somites tend to fuse with one another by a blending of their substance. Very generally, but not invariably, the fused meromes are found as distinct separated structures in the embryo of the animal, in which they unite at a

later stage of growth." The fusion of neighbouring meromes is often preceded by more or less extensive atrophy of the somites concerned, and by arrest of development in the individual ontogeny. Thus, a case of fusion of partially atrophied somites may simulate the appearance of incipient merogenesis or formation of new somites, and, vice versa, incipient merogenesis may be misinterpreted as a case of fusion of once separate and fully-formed somites.

A very complete fusion of somites is that seen on the head of Arthropoda. The head or prosoma of Arthropoda is a tagma consisting of one, two, or three prothoraxes or somites in front of the mouth and of one, two, three, up to five or six opisthomeromes. The cephalic tagma or prosoma may thus be more or less sharply divided into two subtagmata, the pre-oral and the post-oral. (E. R. L.)

METAMORPHISM (Gr. *μετά*, change of, and *μορφή*, shape), in petrology, the alteration of rocks in their structural or mineral characters by which they are transformed into new types. In the history of rock masses changes of many kinds are inevitable. Loose sands, clays and heaps of shells are gradually converted into sandstones, shales and limestones by the action of percolating water and the pressure of over-lying accumulations. All rocks exposed at the earth's surface or traversed by waters circulating through the earth's crust, undergo changes in their component minerals due to weathering and the chemical action of the atmosphere and of rain. These processes of cementation and decomposition, though not unlike those of metamorphism, are not regarded as essentially the same. They are considered, so to speak, normal episodes in the history of rocks to which all are subject. When rocks, however, are exposed to the heat of intrusive masses (granite, &c.) or have been compressed, folded, crushed, and more or less completely recrystallized, they assume new characters so different from their original ones that they are ascribed to a quite distinct class, namely, the *metamorphic rocks*.

The transformation is always gradual, so that in suitable districts every stage can be followed from an unaltered or nearly unaltered sedimentary or igneous rock to a perfectly metamorphic one. The transition may be slow or rapid, and the abundance of intermediate forms renders it impossible to lay down any hard and fast lines of distinction. A black shale with fossils may in two or three feet pass into a splintery hornfels; a sandstone or grit becomes a sheared grit, a granulitic gneiss, and a completely recrystallized gneiss sometimes within a few hundred yards; in a thoroughly metamorphic hornblende-schist or chlorite-schist small kernels sometimes occur which can easily be recognized as little modified dolerites or diabases. Still, the metamorphic rocks as a class have many well-defined characteristics, and in perfectly typical development cover enormous areas of the earth's surface and must be, in the aggregate, of vast thickness. A great number of them are recognizably of igneous origin; others are equally certainly sedimentary. Hence some writers have suggested that they are not entitled to rank as a separate class, but only as states or conditions of other rocks. It is generally agreed, however, that when the primitive structures and the original minerals of sedimentary or igneous rocks are so transformed as to be no longer easily recognizable the rock should be included in the metamorphic class.

Only rarely, however, does metamorphism produce much difference in the chemical composition of the rocks affected. Sandstones become quartzites and quartz schists, limestones are converted into marbles, granite passes into gneiss, and so on, without their bulk composition being greatly modified. From all that we know it seems established that however great the heat and pressure to which metamorphic rocks have been exposed they have very rarely been melted or reduced to the liquid state. Hence there has been no opportunity for intermixture by solution or diffusion; the changes, including the growth of crystals of new-formed minerals, have gone on in the solid rocks. The chemical molecules already present have aggregated into new combinations and have built up new minerals without travelling for more than infinitesimal distances from the places they occupied in the original rock. Exceptions to this occur, but they are so few that they do not

invalidate the general rule. Thin bands of limestone, for example, may be followed for miles in belts of mica-schist or gneiss, never losing their identity by blending with the rocks on either side of them. By tracing out zones such as these it is often possible to unravel the highly complicated stratigraphy of metamorphic regions where the rocks have been greatly folded and displaced. Another important consequence of the persistence of the chemical individuality of metamorphosed rocks is that very often an analysis indicates in the clearest possible fashion what was the original nature of the rock mass. Sandstones, limestones, ironstones, shales, granites, dolerites and serpentines may be totally changed in structure and very completely also in mineral composition, but their chemical characters are practically indelible. Confusion arises sometimes from the fact that two rocks of different origin may have much the same composition, e.g. a felspathic sandstone may closely approach a granite, or an impure dolomite may simulate a basic igneous rock. Individual specimens, consequently, cannot always be relegated with perfect certainty to sediments or igneous rocks; but in dealing with a complex containing a variety of types the geologist is rarely long in doubt as to their original nature.

Two distinct kinds of metamorphism are recognized, namely contact or thermal metamorphism, and folding or regional metamorphism. The former is associated with intrusive masses of molten igneous rock which were injected at a very high temperature and produced extensive changes in the surrounding rocks. The second occurs in districts where earth folding and the movements attendant on the formation of mountain ranges have flexured and crushed the strata, probably at the same time considerably raising their temperature. Although these processes are very different in their origin, and in the great majority of cases produce quite different effects on the rocks they involve, there are instances in which the results are closely comparable. A sandstone may be converted into quartzite and a limestone into marble by either kind of metamorphism. It is best, however, to describe them as phenomena essentially different from one another.

Contact Metamorphism (thermo-metamorphism).—Any kind of rock—igneous or sedimentary—which has come in contact with an igneous molten magma is likely to show alteration of this type. The extent and intensity of the changes depend principally on two factors: (1) the nature of the rock concerned, and (2) the magnitude of the igneous mass. It is to be expected that a great intrusion of granite will produce more extensive effects of this kind than a narrow dike a few inches or a few feet broad. At the edges of such dikes only a slight induration may be noticeable in the country rock, or there may be recrystallization with formation of new minerals for a few inches. Rarely does the alteration extend beyond this. Shales are baked and hardened, sandstones are rendered more compact or occasionally are partly fused, limestones may be converted into marble containing garnet, wollastonite, augite or other calc-silicates. A great granite boss, which may be ten or twenty miles broad, is often surrounded by a wide aureole of contact alteration. This may be a few hundred yards or a couple of miles; in rare cases the breadth of the aureole is only a few yards. These variations may have structural causes; thus when the aureole is narrow the junction of granite with country rock may be vertical; when the aureole is broad the granite may be a flat-topped mass which dips at low angles outwards on each side. When a broad aureole accompanies a vertical junction we may suppose that molten rock has flowed upwards along this boundary line for a prolonged period, and has gradually raised the rocks to a very high temperature, even at some distance away from the contact. Where the alteration is slight and local there is usually something in the composition of the rocks or in their crystalline state to account for this.

No less important is the nature of the rocks involved. Where a granite intrudes into a succession of various types of sedimentary and igneous rocks the differences in their behaviour are often very marked. Sandstones alter less readily than shales or slates, and limestones, especially if they be marly or argillaceous, are often full of new minerals, when purer shales on each side of them are not visibly altered. Schists and gneisses, being already highly crystalline, are very resistant to thermal alteration, and may show it only for a few inches where they are in actual contact with the granite, or in minute fragments which have been broken off and surrounded by the invading magma. Igneous rocks, since they consist of minerals which have formed at very high temperatures, may show no change whatever. If they are decomposed, however,

their secondary products, including those which fill veins and amygdaloidal cavities, are often entirely recrystallized in new combinations. Instances of this will be given later.

The intensity of the alteration depends very greatly on the proximity to the intrusive rock. A typical aureole surrounding a granite boss, for example, consists of rocks in all stages of alteration, the most affected being nearest the granite, while as we travel outwards the more quiet zones are successively diminishing metamorphism. Around the granites of Cornwall, the Lake District and Ireland there are tracts of altered slate which show these stages very well. The first sign of metamorphism is a slight increase in hardness and glossiness, making the slate a little brighter and more brittle. This is due to the formation of mica in small crystalline plates mostly parallel to the cleavage of the rock. Nearer the granite a faint spotting is visible on broken surfaces of the slates, and this becomes more pronounced as we enter the middle part of the aureole. These spotted slates, in Cornwall for instance, often occupy a zone a mile in breadth. They are less fissile than the unaltered slates and have rounded or elliptical spots about a quarter of an inch across. The spots are usually darker than the body of the slate, though sometimes paler. Angular, branched, lenticular and rhomboidal spots sometimes occur. Under the microscope these rocks consist mainly of brown mica, quartz and organic matters, iron oxides, &c.; the spots may be due to aggregation of biotite or of quartz, but often differ little in composition from the surrounding rock. Their dark colour is due to abundance of iron oxides or graphite, and their lenticular and rhomboidal shape is due to the development of crystals taking place in the slates. The commonest are andalusite, chloriastole (with cross-shaped dark enclosures), cordierite, staurolite and garnet. At the same time the minerals formerly enumerated crystallize in larger individuals (biotite, quartz, iron oxides, &c.), so that the rock becomes rather more coarse-grained. At this stage the fissility and cleavage structures of the slate tend to be obliterated, and the rocks are dark, lustrous (from the abundance of mica), hard and splintery. To this type the name *hornfels* is given. The innermost zones of the aureole consist mainly of hornfels, and where there are slate fragments enclosed in the granite they usually show these characters in their most pronounced form.

The nature of the new minerals produced depends principally, of course, on the chemical composition of the rocks affected. In pure sandstones only quartz is formed, and pure limestones merely recrystallize as marbles. Argillaceous rocks are characterized by abundance of alumina; hence, when thermally altered, they may contain corundum, or silicates of alumina such as sillimanite, kyanite, andalusite and staurolite. In most rock masses, however, are far from pure, and hence the variety of minerals which may be formed in them from contact alteration is very great. Argillaceous limestones, for example, very frequently contain garnet, vesuvianite, wollastonite, diopside, tremolite, sphene, epidote and feldspar; that is to say, minerals in which lime is present along with silica, alumina, magnesia and other substances. Calcareous sandstones yield augite, garnet, sphene, epidote; argillaceous sandstones are characterized rather by biotite, sillimanite and spinel.

In each case the materials already present in the rock have united to form new mineral combinations. Crystallization has been stimulated by the rise of temperature, aided, no doubt, by moisture. Water vapour, even at comparatively low temperatures when the pressure is considerable, is a powerful mineralizing agent and greatly facilitates crystallization. Often the rocks acquire ultimately a pseudoporphyrithic or porphyro-blastic structure, as they contain large or conspicuous crystals scattered through a finer grained ground-mass; not only these porphyritic ingredients but the body of the rock shows increased crystallization, for contact alteration as a rule raises the temperature above the melting point.

In rare instances fusion may take place, but this must be exceptional, as the finest original structures are often very perfectly preserved by rocks which have been in great measure recrystallized. Finely laminated argillaceous sandstones, for example, may pass into cordierite—or andalusite—hornfels showing a mineral banding which corresponds exactly with the original lamination. For this reason the newly developed minerals are not frequently of good crystalline form. When weathered out of the rock they have mostly rough, imperfect surfaces, but exceptions to this occur in garnet, staurolite, tourmaline and a few others which often produce good crystals even in these adverse circumstances.

It is only true in a general way that the rocks which are thermally altered experience no change in their chemical composition. The new minerals which are substituted for the original ones are such as are stable at high temperatures. Many of the silicates which form a large part of sedimentary rocks contain combined water; examples are chlorite, kaolin and clay. The water, or part of it, is expelled, forming silicates with little or no water, e.g. biotite, feldspar, andalusite. Calcic acid may be retained or driven out; in a siliceous limestone the silica tends to combine with the iron and calc-silicates by replacing the carbonic acid. In a pure limestone the carbonate merely recrystallizes as marble. This loss of volatile ingredients must occasion a diminution in the bulk of the sedimentary mass involved; in cooling there will be contraction, and fissures are produced which may be filled with igneous dikes or with

veins deposited by ascending hot waters. Hence contact aureoles are common sites for mineral deposits of economic value.

In some aureoles the sediments or schists have their bedding and foliation planes wedged apart by the intrusive force of the granite, and are permeated by igneous material invading them along these fissures. In this way a *mélange* is produced of sedimentary rock with threads and veinlets of igneous nature, and to some extent a blending of the two rocks takes place, though usually each preserves its identity however intimately mixed. In microscopic sections veins of granite not more than a tenth of an inch in width may be traced, sharply distinct from the slate or schist they penetrate. Cases, however, are described in which the rocks of the aureole have been felspathized or filled with new felspar derived from the granite; this, however, is not common. Shales are often converted, when in contact with diabase, into pale-coloured, flinty-looking rocks known as adinoleths. These are exceptionally rich in albite and contain as much as 10% of soda, an amount which is not met with in unaltered shales. It seems probable that alkalis have been transferred from the igneous rock to the sedimentary, perhaps through the medium of the vapours exhaled. The breadth of the adinole belt is as a rule only a few inches or a foot or two.

The vapours given off by intrusive igneous masses may contain substances which combine with the ingredients of the surrounding rocks and thus modify their composition. Boron, fluorine and phosphorus are the principal elements which are transferred in this way, and minerals such as tourmaline, topaz and mica are the characteristic products in quartzose or argillaceous rocks; while apatite, fluorapatite, axinite, datolite and chondrodite are commonest in limestones. This is a form of pneumatolytic action (see PNEUMATOLYSIS).

Extreme cases of the mutual interaction of the intrusive rock with the masses invaded by it are provided by the fragments enclosed in the molten magma (known as *xenoliths*). These are often rounded and eroded, as if softened or partly fused and dissolved. Similar changes are found in the rocks of the aureole for a few feet or yards where in actual contact with the granite. This belt of indurated hornfels often weathers much more slowly than the igneous rock, and stands out as a prominent, sharp-edged ridge running round the granite margin.

Where sediments are dissolved in igneous rock we may expect to find modifications in the chemical composition and in the minerals produced on crystallization of the magma. Some granites, for example, which contain many rounded, partly dissolved enclosures of slate are themselves full of corundum, andalusite, cordierite and other minerals of this type, and are also rich in absorbed slate material. Much discussion has taken place as to the importance of such processes in modifying the facies presented by igneous rocks. Granites are alleged to have absorbed impure limestones and thus to be changed to diorites (Pyrénées). At the contact of the two rocks a narrow zone of diorite intervenes between the granite and the limestone. In this case an acid rock has become basic (or intermediate) in character; similarly, basic rocks—such as gabbro—are said to become granitic where they have melted down large quantities of felspathic quartzite. On the other side it is argued that as precisely the same modifications of the igneous rocks are known to occur where these explanations cannot possibly hold good—e.g. zones of diorite at the contact of granite with quartzite or mica-schist—they are really due to the chemical segregation or differentiation in the magma and not to any admixture with foreign material.

Such modifications in the igneous rock at its contacts are often said to be endomorphic, while those which take place in the aureole or country rocks are exomorphic. The endomorphic changes are not always strictly of the nature of contact alteration. The commonest are the presence of a fine-grained, sometimes glassy, chilled edge due to rapid solidification from sudden cooling of the magma. The fine-grained marginal facies is often porphyritic, while the interior of the mass is granular or eugranitic. There is often a tendency to the development of special minerals in the edge of intrusive masses. Some of these arise probably from absorption of country rock, e.g. cordierite, andalusite, iron oxides (in granite). At the same time there may be a great abundance of angular or rounded enclosures, so that the marginal rock is brecciated. Where granite penetrates gabbro the fragments of the latter are sometimes melted down and digested in the granite till only the crystals of their augite or diallage are left (Skye). Granite margins are not always more basic than the average of the mass; they may be exceedingly rich in quartz and at the same time very coarse-grained or pegmatitic. This seems to arise from the production of fissures at the contact after the granite has to a large extent solidified. In these fissures the pegmatites are laid down by escaping vapours. The pegmatitic changes are especially common in this situation, and have often for their very valuable mineral deposits along igneous contacts. There also pneumatolytic processes often concentrate their attack; schorl-rocks, greisen, topaz-rock and china-stone (or kaolinized granite) are characteristic products, and the active vapours often transform the sediments around, forming schorl-schist, calc-silicate rocks and sericite-schists.

Regional Metamorphism.—The second kind of metamorphism is known as "regional" because it is not confined to narrow areas like contact metamorphism, but affects wide tracts of country.

Metamorphic rocks of this kind often cover a large part of a continent (e.g. the centre of Africa or Scandinavia and Finland). Whatever the causes be which produced it, they must have been of widespread operation and connected either with great geophysical processes or with definite stages of the earth's development. Where such rocks occur there is generally much evidence of earth movements accompanying the crushing and folding. They are very characteristic of the central axes of great mountain chains, especially when these have been denuded and their deeper cores exposed. Most geologists believe that this connexion is causal, holding that the contraction of the outer layers of the earth's crust, due to shrinkage of a nearly rigid shell upon a cooling and contracting interior, has bent and folded the rocks, and at the same time has crushed and largely recrystallized them. According to this view regional metamorphism is the result of pressure and folding; hence the name *dynamo-metamorphism* is frequently applied to it.

A great number of observations collected at all regions of the globe may be adduced in support of this hypothesis, forming a mass of evidence so strong as to be almost overwhelming. The structural features which prove that there has been great folding in these rocks are accompanied by microscopic and lithological characters which demonstrate that extensive crushing has taken place. Through progressive stages a slate with fossils may be traced into a phyllite, which becomes a mica-schist, or, in places, a micaceous gneiss. At first the fossils are distorted or torn apart, but they disappear in crystalline schists. The rocks are broken into small fragments, and flow almost like plastic masses, losing their fossils and becoming crystalline. Grits, quartzites and granites show the effects of crushing in the pulverization of their minerals and the breaking down of their original clastic or igneous textures, fine slabby mylonites (*g.v.*) and granulites being produced. Moreover, the degree of metamorphism in the rock can often be shown to correspond closely to the extent to which it has been folded and crushed.

Another argument in favour of dynamo-metamorphism, which has been urged with much insistence by the extreme supporters of these theories, is the retention of original chemical characters in the metamorphic rocks. Some of them bear unmistakably the stamp of sedimentary origin, e.g. the limestones and marbles, quartzites, graphite-schists and aluminous mica-schists. Others have the normal composition of granites, diorites, gabbros and other types of plutonic igneous rocks. This leads to the inference that these were originally normal sediments and intrusives or lavas, and that their present crystalline state and foliated structure are the result of agencies which operated on them subsequently to their formation. Where the degree of deformation is not too high, and the folding and dislocation not too complex, the sandstones, shales and limestones may be mapped out, and igneous bosses, dikes and sills, with their contact aureoles, veins, pegmatites and segregations, convincingly delineated on the maps. This shows that a whole complex or terrane, consisting of diverse petrological types of normal sediments and igneous rocks, may be converted by metamorphism into a great series of gneisses and schists. Although recrystallization has been complete, the original rock masses still retain their identity in their new state.

The metamorphism in a rock series may be of nearly uniform intensity over a large area; the sediments, for example, may have all their clastic and organic structures effaced, and in the igneous rocks the porphyritic, oplitic, graphic and other textures may have completely disappeared. This, however, is not always the case, especially when the metamorphism is not of very intense degree. Parts of the rock may retain original structures, while others are typical crystalline schists and gneisses. Kernels, lumps or shreds of mass rock are often found embedded in schists, and it is clear upon inspection that the phacoids represent the original state of the rock, while the schist is the effect of metamorphism. At other times a rock mass, such as an intrusive sill, is schistose at its edges and surrounded by schistose sediments, while near its centre it is almost entirely massive. The hard igneous rock has proved more rigid than the soft and plastic sediments; in folding, the latter have yielded to the stresses, and internal movement has produced foliation. The crystalline rock of the intrusive sheet has been strong enough to withstand the pressures and has folded like a rigid mass. At the junctions the effect of differential movement is shown by the presence of a belt of rock which often has a most pronounced schistosity. Some intrusive dikes show foliation especially marked along their edges; or they may be traversed by planes of movement, running obliquely or directly across them, and characterized by the development of very marked schistosity. Exceedingly sudden transitions between normal igneous rocks and schists or gneisses have been described in many places. In normal dolerite, with oplitic structure and abundant augite, has been shown to pass in a few feet or inches into an epidiorite, where hornblende has replaced the primary augite, and lastly into a perfectly typical hornblende-schist, completely recrystallized with development of epidote, green hornblende, sphene and other minerals of metamorphic facies from the original constituents of the dolerite. These phenomena are regarded as establishing that the rock had consolidated as a normal dolerite before the processes which caused the metamorphism began to act; that these processes resulted in internal movement in the rock

mass along certain narrow belts; and that recrystallization was set up along with the development of schistose structure. The operating cause cannot have been anything but pressure, especially as the foliated rocks occur not infrequently in lines of dislocation and shear; in other cases the foliated types are at the margins of morphic schist may take place within the space of one inch. The best examples of phenomena of this order are those described by J. J. H. Teall from Scourie in the north-west of Scotland.

Where rocks of any kind are traversed by powerful dislocations or thrusts they often present a schistose facies in the immediate vicinity of the planes of movement. In the Highlands of Scotland great thrusts occur, along which the rocks are displaced for distances which may be as much as ten miles; and immediately after the rocks, sedimentary, igneous or metamorphic, which have been involved in the movements. The minute structure of these rocks is generally of the mylonitic, granulitic or finely crushed type. In the same way the serpentine of the Lisian in Cornwall passes into fine talcose and tremolitic schists along narrow zones of displacement. Many other examples of this might be cited from regions where folding and crushing have taken place on a large scale. As a rule, almost without exception, the foliation thus produced is parallel to the direction of movement in the rock masses.

In the mineral transformations which accompany metamorphism the operation of pressure is no less clearly indicated. There are, for example, three minerals which consist of silicates of alumina, viz. andalusite, sillimanite and kyanite. The latter two have the highest specific gravity. In andalusite-bearing rocks which have been sheared, with production of foliation, we sometimes find pseudomorphs of kyanite after andalusite, retaining the characteristic form of the original mineral. Compression, it seems reasonable to suppose, would produce that one of the three crystalline silicates of alumina which has its molecules most closely packed, and consequently the highest specific gravity. This explains the conversion of andalusite into kyanite. The same principle that substances tend to assume that mineral form which has the smallest molecular volume is of wide application among metamorphic rocks. It has been calculated, for example, that when olivine and anorthite feldspar are replaced by garnet (a change which takes place not infrequently when basic igneous rocks are metamorphosed) the molecular volume of the mineral aggregate diminishes from 145 to 121 or about 17%. On the other hand, when garnet is fused it recrystallizes as a mixture of olivine and anorthite. This has led to the generalization that all minerals formed by the crystallization of a fused magma at high temperatures have a large molecular volume, while those which are produced in rocks at temperatures below their fusion point and under great pressures have smaller molecular volumes. Loewinson Lessing pointed out that some minerals have a greater molecular volume than the oxides which enter into their composition; in other minerals the reverse holds good. The former group are, on the whole, characteristic of igneous rocks and products of contact alteration, both of which classes have been formed at high temperatures. (e.g. wollastonite, spinel, nepheline, leucite and andalusite). The minerals of the second group are often of common occurrence in metamorphic schists and gneisses (e.g. staurolite, kyanite, hornblende, talc, epidote and garnet). Although there are exceptions to this rule, there can be no doubt that it expresses a generalization which is of great value in the study of mineral paragenesis.

The mineral changes are usually not of so simple a kind as those above enumerated. Mutual interaction takes place between adjacent components of the rocks. Titaniferous iron oxides, for instance, obtain silica and lime from such minerals as augite, or lime feldspar andesine products. Felspar often breaks up into epidote, quartz and albite. Epidote obtains its iron from adjacent crystals of augite or hornblende. Equations can be written to show the transformation of one rock to another; thus, diopase (labradorite, augite, ilmenite) may be converted into amphibole (acid plagioclase, hornblende, garnet, sphene and quartz). In this case, the molecular volumes are for diopase 671 and for amphibole 635.6, indicating a diminution on metamorphism. Many striking illustrations of this principle have been adduced. Caution, however, is required in applying it to concrete cases; if it was always strictly correct the metamorphic rocks should have higher specific gravities than the representatives among sediments and igneous rocks. Very frequently this is not the case, and there must be some counteracting process at work. We find this antagonistic principle in the tendency for the minerals of metamorphic rocks to contain water of combination, e.g. epidote, muscovite, chlorite, hornblende, talc. This indicates that they were formed at comparatively low temperatures.

We arrive then by many independent lines of reasoning (stratigraphical, microscopic, chemical and mineralogical evidence being abundantly available) to the conclusion that pressure acting on sedimentary and igneous rocks at temperatures below their fusion points has been able to change them into metamorphic rocks. This is the theory of dynamo-metamorphism, which has won acceptance from the majority of geologists who have made the petrology of

metamorphic rocks their special study. It has still, however, many incisive critics, and in recent years dissent has on the whole gained strength.

One of the principal objections is that by these processes it is possible to destroy original structures and to break down the minerals of which a rock consists, but not to induce crystallization and build up rock structures of a new type. It is pointed out that in many regions the rocks though intensely folded are not highly metamorphic; in other places immense dislocations can be proved to exist, yet the mylonites are only slightly altered or are converted into fine-grained mylonites and not into typical schists and gneisses. Conversely, it is argued, there are many districts where metamorphism is very intense, yet evidence of folding is absent or only slight. It seems clear that another factor must be taken into account, and in all probability that factor is the action of water in rocks at a comparatively high temperature. All rock masses contain interstitial water, and many also consist of minerals in some of which water exists in combination. Hence all metamorphism must be regarded as taking place in presence of water. It is almost equally certain that metamorphism must be accompanied by a rise of temperature in nearly every case—in fact it is difficult to imagine such a process going on without considerable heat. Now heated water (or water vapour) is a most potent mineralizer. Crystals of quartz, for example, have been produced in glass tubes containing a little water, heated in a furnace to a temperature of about 300° C.

The heat required for the more intense stages of metamorphism may be derived from more than one source. Most regions of gneiss masses, though themselves are frequently gneissose, and the older rocks at a time when folding, as they were injected into the morphism would then be partly of the contact type and partly the effect of pressure and movement, "pressure-contact-metamorphism." The vapours already present would be augmented by those given out from the igneous rock, and intensely crystalline, foliated masses, often containing minerals found in contact zones (andalusite, cordierite, sillimanite, staurolite, &c.), would be produced. Cases are now known where it is in every way probable that the metamorphism is the result of a combination of causes of this order. Some of the Alps, which are surrounded by gneisses have been referred to this group.

Heat must also have been produced by the crushing of the rock components. In many metamorphic rocks we find hard minerals possessing little cleavage (such as quartz) reduced to an exceedingly fine state of division, and it is clear that the stresses which have acted on regions of metamorphic rocks are often so powerful that all the minerals may have been completely shattered. The interstitial movement of the particles must also have generated heat. There is no experimental data to enable us to say what rise of temperature may have been produced in this way, but we cannot doubt that it was considerable. If the crushing was slow the heat generated may have been conducted away to the surface almost as fast as it was produced. If the belt of crushing was narrow, heat would rapidly pass away into the colder rocks beyond. This explains why in some rocks there has been much grinding down but little crystallization. The heat also may be absorbed in promoting chemical combinations of the endothermal type, but it is not likely that much was used up in this way. With rising temperature the rocks would become more plastic and fold more readily. Then if the temperature gradually ceased, a long period would follow in which larger grains after the well-known law of Ostwald would tend to grow at the expense of the smaller ones; the larger particles tend to aggregate would be replaced by mosaics of coarser structure. If there has been a considerable rise of temperature we might expect analogies in structure and constitution between the folded rocks and those which come from a contact aureole; this has in fact been noted by many geologists.

Another factor which must have been of importance is the depth below the surface at which the rocks lay at the time when they were folded. In the deeper zones the pressures must have been greater, and the escape of the heat generated must have been less rapid. The uppermost members of a complex which is undergoing folding are under the lowest pressures, are at the lowest temperatures, and probably also contain most moisture. Hence minerals such as epidote, chlorite, albite, sericite and carbonates, which are often produced by weathering alone, might be expected to prevail. In the deepest zones the temperature and pressure are high from the first and are increased by folding; such minerals as biotite, augite, garnet, feldspar, sillimanite, kyanite and staurolite might be produced under these conditions. The earth's crust might in this way be divided into bathymetric zones, each of which was characterized by distinctive types of mineral paragenesis. Some geologists ascribe the greatest importance to this conception, they establish two or three types of metamorphism, each of which belongs, in their opinion, to a definite horizon. This is to some extent a resuscitation of the old idea, now discarded, that the Archean rocks are sediments of a peculiar kind formed only in the heated waters of the primal globe; the first deposits were laid down under great heat and pressure and

are typical gneisses which may resemble igneous rocks; the schists of later origin exhibit a progressive transition to normal sediments. Without admitting that it is possible to classify metamorphic rocks according to the depth at which they were situated when metamorphosed, we may admit that there is much reason to believe that the more intense stages of alteration characterize as a rule the rock masses which were oldest or most deeply situated during the epoch of folding.

While rocks near the surface which are under comparatively slight pressures yield to stress by fracturing, it is conceivable that at greater depths the minerals would become plastic and suffer deformation without rupture. For this zone of "flowage," as he terms it, van Hise estimates a depth of not more than 12 kilometres, depending on many factors such as the strength of the rocks and nature of the minerals concerned, the temperature, amount of moisture and rigidity of the strata. Between it and the zone of fracturing, which lies above, a gradual transition must take place. Doeberl, on the other hand, believes that the depth at which plastic flow begins must be at least 35 kilometres; it is difficult to imagine that rocks which have been so profoundly buried can now be exposed at any part of the earth's surface.

In the attempt to explain the existence of large masses of metamorphic rocks which are perfectly foliated, but at the same time coarsely crystalline, and show no grinding down of their components, as might be expected on the hypothesis of pure dynamo-metamorphism, F. Becke brought into prominence another principle which may prove to be widely applicable. Although known as Riecke's law, it was advanced many years ago by Sorby. It enunciates that when minerals are subjected to unilateral pressure (acting in a definite direction and not like hydrostatic pressure, equally in all directions) they tend to be dissolved on those sides which face the pressure, while the sides which are not compressed tend to grow by additional deposit. Minerals having platy or rod-like forms will thus be produced, all having a parallel orientation, and a conglomerate will be schistose, with foliation corresponding in direction to the extension of the mineral plates, and perpendicular to the stresses which were in action. The solvents which dissolve the mineral on one side and deposit it on the other side are the interstitial moisture and vapours present in the rock. By this means schists and gneisses will be produced, which are perfectly foliated yet have their minerals homogeneous and uncrushed. Experimental data are at present wanting to show how far this principle is operative and what are its limits, but as a supplementary contribution to the theory of dynamo-metamorphism it may prove to be of great importance. This has been described as the development of "schistosity by crystallization."

More interesting still are E. Weinschenk's theories of pressure-crystallization and piezo-crystallization (pressure-contact action). He adduces evidence to show that many gneisses are igneous rocks which were foliated from the first, and a large body of observations in many European countries confirms his statement. In his opinion plutonic rocks crystallizing under certain conditions of pressure necessarily assume a banded structure, and contain minerals which are not identical with those of igneous rocks but with the components of schists and gneisses. In the surrounding rocks there is contact alteration but not of the ordinary type as the recrystallized products also have a banding or foliation owing to the pressure acting on them during metamorphism. Bonney urged the hypothesis that many gneisses are merely plutonic igneous rocks which exhibit a flow banding and an imperfect idiomorphism of their minerals owing to their having been injected in a half-solid state; the component crystals by mutual attrition assume rounded or lenticular forms. Undoubtedly there is much truth in these hypotheses, yet in both cases they seem to necessitate the presence of extraordinary earth-pressures such as accompany mountain building. We know that heat greatly increases the plasticity of rocks. Assuming that intrusions take place during an epoch of earth movement, we may be certain that as solidification goes on the pressures will force the rock forward, and the structures will be very different from those assumed by a rock which has crystallized in a condition of rest.

Lastly, there are many geologists who hold that certain kinds of gneiss are due to the injection of plutonic igneous rocks as masses of all sizes into sedimentary schists forming a *mélange*. The igneous rock veins the sediment in every direction; the veins are often exceedingly thin and nearly parallel or branch again and again. In this way a banding or foliation is set up, and the mixed rock has the appearance of a gneiss. In the sediment, intensely heated, new minerals are set up. The igneous rock digests or absorbs the materials which it penetrates; and it is often impossible to say what is igneous and what is sedimentary. Acid intrusions may in this way break up and partly assimilate older basic rocks. Very good examples of this process are known, and they may be much more common than is at present suspected. Conditions which favour assimilation at great depths are the enormous pressures and the high temperature of the earth's crust; the igneous rocks may also be much above the unconsolidation points, quite reasonable to believe that at deep levels absorption of sediments by igneous masses goes on extensively, while in higher zones there is little or none of this action. (J. S. F.)

METAMORPHOSIS, a term used in zoology in different senses by different authors, and sometimes in different senses by the same author. E. Korschelt and K. Heider, in their work on the development of the Invertebrata, usually apply it to the whole of the larval development. For instance, in their account of the Bryozoa, they say (p. 18, part 2, of the English translation): "The metamorphosis of a Bryozoa larva comprises a more or less protracted free-swimming stage during which no perceptible advance is made in the development of the larva, and the subsequent somewhat complicated changes which bring about its transformation into the first primary zooid of the young Bryozoa colony." Throughout their account of the Crustacea they use the word in the same sense, i.e. as applied to the whole of the changes which the larva undergoes in passing into the adult. On the other hand, in their account of Mollusca they seem to restrict the term to the final change by which the larva passes into the adult form (*op. cit.*, part 4, p. 14). F. Balfour in his great work on Comparative Embryology seems to limit the word to a sudden change in the larval history. For instance, he says: "The chief point of interest in the above development is the fact of the primitive nauplius form becoming gradually converted without any special metamorphosis into the adult condition" (*Comparative Embryology*, 1885, i. 463). "By the free Cypris stage into which the larva next passes a very complete metamorphosis has been effected" (*op. cit.* i. 490). "The change undergone by the Tadpole in its passage into the Frog is so considerable as to deserve the name of a metamorphosis" (*op. cit.* ii. 137). Finally and most decisively he says in his general account of larvae: "In the larval type [of development] they are born at an earlier stage of development, in a condition differing to a greater or less extent from the adult, and reach the adult state either by a series of small steps or by a more or less considerable metamorphosis" (*op. cit.* ii. 360). Here the term will be used in the sense of the last quotations from Balfour and will be regarded as applicable only to those cases of sudden and marked change which frequently occur at the end of the larval period and sometimes at more or less frequent intervals during its course (Crustacea).

Some authors (see H. G. Bronn, *Thierreich*, "Myriapoda," Bd. 5, Abth. 2, p. 113) have applied the term "metamorphosis" only to those cases of larval development in which the young leaves the egg with provisional organs which are lost in the later development. Such authors apply the term "anamorphosis" to cases in which the just-hatched young is without provisional organs but differs from the adult in size, and in the number of segments and joints, &c. Such writers apply the term "epimorphosis" when there is merely an acquisition of sexual maturity and increase in size after birth or hatching.

The essential feature of metamorphosis is the sudden bursting into function of new organs, whether these organs suddenly arise or have been gradually formed, without becoming functional in preceding larval stages. Another feature of it is the disappearance of organs which have been of use to the larva but which are not required at all or are not required in the same form in the new environment. The term is only used in connexion with larval development and is not applied to the sudden changes, due to a change of environment (e.g. the passage of the mammalian embryo from the oviduct into the uterus), which sometimes occur in embryos. Neither is it used in connexion with the sudden changes of conditions which occur at the birth or hatching of an embryo, although, especially, in the case of birth, this event is frequently accompanied by profound morphological alteration.

The most familiar examples of metamorphosis are the abrupt changes which occur at the end of the larval history of the frog and of many insects. In both these cases there is a sudden and great change of environment; there is a sudden demand for new organs which would have been quite useless in the old environment, and organs which were of use in the old environment and are of no use in the new have to be eliminated. The two examples we have chosen have the advantage of showing us the two methods by which the crisis in the life-history is met.

In the frog (fig. 1) the structural changes which obtain full fruition at the metamorphosis take place gradually during the previous tadpole life. They relate mainly to the alterations of the respiratory organs and vascular system which are required for the purely terrestrial life of the frog, and to the appearance of the paired limbs. The changes in the respiratory and vascular

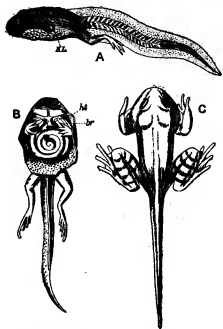

After Leuckart and Nitsche's *Wandtafeln*, by permission of T. G. Fisher & Co.

FIG. 1.—Drawings illustrating the metamorphosis of the frog (*Rana temporaria*).

A. Side view of an advanced tadpole with well-developed posterior limbs; the anterior limbs are present but hidden beneath the operculum.

B. Ventral view of the same with operculum removed showing the anterior limbs *in situ*; the ventral body wall has also been removed and the heart (*hl*) and intestine exposed. (*br*) Gills; (*KL*) spiracle.

C. A frog after the metamorphosis but before the absorption of the tail.

organs are led up to in the tadpole, which during the greater part of its aquatic life is a truly amphibious animal, breathing by lungs as well as by gills; but a sudden change occurs in these organs at the metamorphosis. The limbs which were slowly formed during tadpole life—the posterior pair visibly, the anterior under cover of the operculum (fig. 1, B)—are of no use to the tadpole and must constitute a pure burden to it. The principal events of the metamorphosis are the sudden appearance of the anterior limbs, and the complete closure of the gill aperture (fig. 1, C). The appearance of the anterior limbs and the acquisition of functional importance by both pairs enable the frog to leave the water and pass on to the land to lead its terrestrial life. The other larval organs, such as the gills and the tail, gradually shrink in size and ultimately vanish. In the case of the gills this shrinkage had begun before the metamorphosis, but the tail shows no sign of diminution until the frog is ready to pass on to the land.

The distinguishing feature of this type of metamorphosis is that the animal is burdened for a certain period, both before and after, with organs which are useless to it. In the next type, which is exemplified by the metabolous Insecta, this occurs to a much smaller extent, although the changes of habitat and the corresponding changes of structure are more remarkable. In insects the change is usually from a terrestrial or aquatic habitat to an aerial one. The larva of a butterfly is a worm-like organism which creeps on and voraciously devours the foliage of certain plants (fig. 2, C). During its life it undergoes much growth, but no important change in structure. When it leaves the egg

it is adapted to live and feed on a particular species of plant, on or near which the eggs are deposited by the parent butterfly. It has powerful biting jaws by which it procures its vegetable food. The adult, on the other hand, is a winged creature which also lives on plants but in quite a different way to the larva (fig. 2, A). It flies from plant to plant and obtains its food by sucking the juices of flowers and other parts. The powerful mandibles of the larva have disappeared and in their place we find a suctorial proboscis formed by the first maxillae (fig. 2, A (4)).

Between the larva and the adult insect there is interposed a resting stage, the so-called pupa (fig. 2, B), during which no food is taken, but very important changes of structure occur. These changes consist of two processes: (1) histolysis, by which most of the larval organs are destroyed by the action of phagocytes; and (2) histogenesis, by which the corresponding organs of the imago are developed from the imaginal disks.

The imaginal disks appear to arise in the embryo in which they develop, some of them from the epiblast and some from the hypoblast. They persist practically unchanged through larval life and become active as centres of growth in the pupa. The pupal stage in such a metamorphosis may be compared to a second embryonic stage in which the organs of the adult assume their final shape. In this kind of metamorphosis the larval organs are entirely got rid of in the pupal stage, during which the insect is as a rule incapable of locomotion and takes no food; and the new formation of organs—especially those of locomotion and alimentation—which is necessitated by the totally different habits of the larva and mature insect, is also accomplished at the same period, largely, no doubt, at the expense of the material afforded by the disrupted larval organs. The larva itself does not form any of these organs and carry them about during its active life, though it does possess the very minute centres of growth known as the imaginal disks which burst into activity after the larval life is over. It must not be supposed that in all insects in which the sexual animal has a different habitat from the young form, there is a metamorphosis of the kind just described. In the may-flies and dragon-flies, in which the larva is aquatic, the change is prepared for some time before the actual metamorphosis, the organs which are necessary for the aerial existence being gradually acquired during larval life. In such cases, the metamorphosis belongs to our first type and consists of the act by which the organs previously and gradually acquired suddenly become functional. We have now considered in detail two typical cases of metamorphosis. In the first the change is gradually led up to and the larva is burdened, in its later stages at least, with organs which are of no use to it and only become functional at the metamorphosis. In the other, the change is not led up to. It is sudden, and a kind of second embryonic period is established

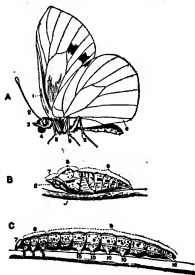

After Leuckart and Nitsche's *Wandtafeln*, by permission of T. G. Fisher & Co.

FIG. 2.—Three stages in the life-history of the cabbage butterfly, *Pieris brassicae*, L.

A. Imago (female), side view.

B. Pupa fixed by a cord across the middle of the body and by the tail.

C. Caterpillar.

- | | |
|---|--------------------|
| (1) Forewing; | (5) thoracic legs; |
| (2) antenna; | (6) hind wing; |
| (3) labial palpi; | (7) the head; |
| (4) first maxilla; | (8) the thorax; |
| (9) the abdomen, some of the segments of which in the caterpillar carry a pair of prolegs (10). | |

appear to arise in the embryo in which they develop, some of them from the epiblast and some from the hypoblast. They persist practically unchanged through larval life and become active as centres of growth in the pupa. The pupal stage in such a metamorphosis may be compared to a second embryonic stage in which the organs of the adult assume their final shape. In this kind of metamorphosis the larval organs are entirely got rid of in the pupal stage, during which the insect is as a rule incapable of locomotion and takes no food; and the new formation of organs—especially those of locomotion and alimentation—which is necessitated by the totally different habits of the larva and mature insect, is also accomplished at the same period, largely, no doubt, at the expense of the material afforded by the disrupted larval organs. The larva itself does not form any of these organs and carry them about during its active life, though it does possess the very minute centres of growth known as the imaginal disks which burst into activity after the larval life is over. It must not be supposed that in all insects in which the sexual animal has a different habitat from the young form, there is a metamorphosis of the kind just described. In the may-flies and dragon-flies, in which the larva is aquatic, the change is prepared for some time before the actual metamorphosis, the organs which are necessary for the aerial existence being gradually acquired during larval life. In such cases, the metamorphosis belongs to our first type and consists of the act by which the organs previously and gradually acquired suddenly become functional. We have now considered in detail two typical cases of metamorphosis. In the first the change is gradually led up to and the larva is burdened, in its later stages at least, with organs which are of no use to it and only become functional at the metamorphosis. In the other, the change is not led up to. It is sudden, and a kind of second embryonic period is established

to enable the important and far-reaching transformation to be accomplished. It is clear that the two kinds of metamorphosis

only differ in degree and that no line can be drawn between them.

In the Crustacea, as has already been pointed out, many authors apply the term metamorphosis to the whole larval development, which consists of a series of changes leading to the adult form. But this is in our opinion an incorrect use of the word. The typical larval development of a Crustacean consists of a series of small metamorphoses. At each moult new organs which have been developed since the preceding moult become manifest and some of them functional. For instance, the prawn *Penaeus* leaves the egg as a nauplius larva (fig. 3, A). It issues from the first moult as a metanauplius which has a forked tail, a beginning of the cephalo-thoracic shield, and a large helmet-shaped upper lip. It also possesses stump-like rudiments of the maxillae and two anterior pairs of maxillipeds. After the next moult it is known as a protozoaea (fig. 3, B), in which a cephalo-thoracic shield is well developed, the posterior part of the body is prolonged into a tail, in the anterior part of which the thoracic segments are obscurely indicated, and the four pairs of stump-like rudiments have become functional appendages (fig. 3, B (4), (5), (6), (7)). This passes into a later protozoaea stage (C) in which the rudiments of the compound eyes and of the abdominal segments are visible beneath the cuticle and in which certain functional changes (jointing, &c.) have appeared in the limbs. This is succeeded by the zoea stage (fig. 3, D), characterized by the stalked and functional condition of the eyes, the increased size of the abdominal segments, and the appearance of appendages on the sixth of them, the increase of size in the third pair of maxillipeds (8) which had appeared as small rudiments in the preceding stage, and the appearance of the five pairs of posterior thoracic limbs as small biramous appendages. The zoea stage is followed by the mysis stage (fig. 3, E) in which the thoracic feet are biramous, as in *Mysis*. From this the adult form proceeds. The transformation is more gradual than would be gathered from this short description, because moults

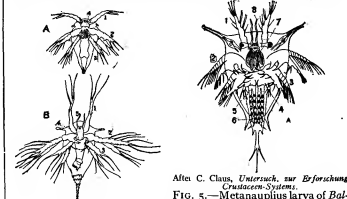

After C. Claus, *Untersuch. zur Erforschung Crustaceen-Systeme*.

After Spence Bate in *Annals and Magazine of Nat. History*, vol. 8, and series, 1851.

- FIG. 4.—Nauplius of *Balanus balanoides*.
- A. As just hatched;
 - B. After the first moult.
- | | |
|--|-----------------------------------|
| (1) first pair of nauplius appendages; | (1) first antenna; |
| (2) second " " | (2) second " " |
| (3) third " " | (3) mandibles; |
| (4) upper lip; | (4) rudiment of the maxilla; |
| (5) frontal sense organ. | (5) first pair of biramous limbs; |
| | (6) sixth " " |
| | (7) upper lip; |
| | (8) frontal sense organs. |

occur during the later stages from each of which the larva comes with some slight transformation.

In the life-history of a typical Cirripede there may be said to be two distinct metamorphoses, with gradual developmental stages taking place between them. The animal is hatched as a nauplius. This undergoes a series of moults during which increase in size and slight changes in form occur (fig. 4, A, B). At the last of them several organs characteristic of the second

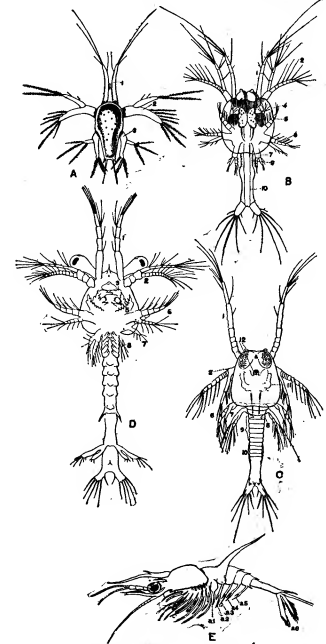

A and B after Fritz Müller in *Archiv für Naturgeschichte*, vol. xxix., 1863; C, D, and E after C. Claus, *Untersuch. zur Erforschung Crustaceen-Systeme*.

- FIG. 3.—Drawings showing various stages in the larval history of *Penaeus*.
- A. Nauplius larva, dorsal view, showing the three pairs of appendages and the simple median eye.
 - B. Protozoaea larva, dorsal view, the rudiments of the paired eyes are visible through the cuticle, by which the rudiments of the maxillae are still covered.
 - C. Older Protozoaea, dorsal view; the six posterior thoracic segments are distinct, but the five abdominal segments are still hidden beneath the skin.
 - D. Zoea larva, ventral view, with the rudiments of the thoracic limbs and the appendages of the sixth abdominal segment.
 - E. Mysis stage, side view; the thoracic and abdominal appendages have been developed.
- | | |
|-----------------------|--|
| (1) first antenna; | (9) thorax; |
| (2) second " " | (10) abdomen; |
| (3) mandible; " | (11) liver; |
| (4) first maxilla; | (12) frontal sense organ, just behind which are the compound eyes; |
| (5) second " " | (a1) to (a6) the six abdominal appendages. |
| (6) first maxilliped; | |
| (7) second " " | |
| (8) third " " | |

or *Cypris* stage are discernible [fig. 5 (5), (6)] beneath the cuticle. When this is moulted the free-swimming cypris larva is liberated with its six pairs of biramous thoracic legs, its bivalve shell, and its paired compound eyes (fig. 6). This is the first metamorphosis. After a certain period of free life the *Cypris* larva attaches itself by its anterior antennae to some foreign object and enters upon the pupal stage (fig. 7). During this the larva takes no food and ceases to move, and undergoes important changes of structure and form beneath the larval cuticle, which invests it like a pupal case. These changes lead to the

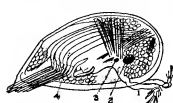

After C. Claus, *Schriften der Gesellsch. zur Beförd. der gesammten Naturwissen. zu Marburg.*

FIG. 5.—*Cypris* larva of *Lepas fascicularis*.

- (1) first antenna;
- (2) compound eye;
- (3) simple eye;
- (4) biramous appendages.

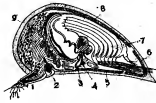

After C. Claus, *Untersuch. zur Erforschung Crustaceen-Systeme.*

FIG. 7.—Pupa of *Lepas pectinata* in optical section.

- (1) first antenna;
- (2) compound eye;
- (3) liver;
- (4) simple eye;
- (5) scutum;
- (6) biramous foot;
- (7) carina;
- (8) cement gland.

attainment of the adult form and structure. When they are completed the cuticle, including the shell-valves, is cast off and the young cirriped emerges. This is the second and final metamorphosis, which resembles in its main features the metamorphosis of the metazoous Insecta.

Metamorphosis occurs in most groups of the animal kingdom. It is generally found in attached organisms, for these nearly always have free-swimming larvae and the metamorphosis occurs when the change of habit is effected. For the details of the process the reader is referred to systematic works on zoology. Here only the most striking instances of it can be mentioned. It occurs in a remarkable form in some sponges, in which at the metamorphosis the larval epidermis, which acts as a locomotive organ, is said to become transformed into the collared flagellated cells of the canal system, the adult epidermis being a new formation. It occurs in the Polyzoa, and is, in some of these, characterized by an almost complete disruption of the larval organs and a subsequent new formation of the organs of the adult. The metamorphosis in such cases belongs to our second type, the new organs being new formations at the metamorphosis and not developed from rudiments which make their appearance in the earlier larval history. In *Phoronis* the metamorphosis of the larva (*Actinotrocha*), which occurs on fixation, is gradually led up to, but the mode of destruction of some of the larval organs is peculiar; the brain and sense organs of the larva pass into the stomach and are digested. In the Tunicata, in which fixation of the free larva is effected by the head, as in Cirripedia and some, if not all, Polyzoa, the metamorphosis occurs entirely after fixation as a rapid series of developmental changes which occur *ad hoc* and are not prepared for by preceding changes. In Amphioxus there is no metamorphosis though the larval changes are most remarkable and extensive, but the larval life is a long one and the development very gradual, the new organs coming into function as soon as they are formed.

In most Mollusca there is also a prolonged and important larval life, marked by very interesting stages of structure (trochophore, veliger, &c.), but it is not usual to speak of a metamorphosis for the changes are gradual, each organ developing with great rapidity and coming into function at once. In certain forms, however, a metamorphosis occurs, e.g. in the glochidium larva of *Anodonta*, which embeds itself in the skin of a fish and there metamorphoses into the adult.

(After J. Müller.)

FIG. 8.—A ventral view of a bipinnaria carrying the body of the young star-fish.

prepared for in the which ultimately lead radial symmetry. The metamorphosis belongs therefore to our first

type, but it is remarkable for the heavy burden of adult structures which the larva, in its later stages at least, carries about (fig. 8). The adult body is, in the main, fashioned out of the larval body, and it takes over most of the organs of the latter; but as a rule the adult mouth, oesophagus and anus are new formations, and the central nervous system of the larva when present shares the fate of the larval locomotory apparatus. In Asterooids and Crinoids the metamorphosis is accompanied by fixation to foreign objects, the fixation being effected as in Cirripedes by the preoral lobe.

In the Vertebrata a metamorphosis occurs in the lamprey and the Amphibia. The metamorphosis of the lamprey is peculiar. It lives for three or four years as a sexless larva, known as the ammocoete. It then quite rapidly (in three or four days) undergoes a series of changes and becomes converted into the adult. The metamorphosis affects the alimentary canal, the eyes, the respiratory apparatus and other organs, and especially the reproductive organs, which become mature. The adult lives for a few months only, spawning soon after the metamorphosis. This metamorphosis belongs to our second type, but there does not appear to be any resting stage during the few days in which it is effected. In the Amphibia the metamorphosis is fairly exemplified by that of the frog. In many fishes there is a considerable larval development, but this is perfectly gradual and there does not appear to be any thing of the nature of a metamorphosis.

In most cases of metamorphosis those organs of the larva, which are found also in the adult, persist through the transformation, undergoing merely the ordinary modifications of development. But it sometimes happens that such organs are completely destroyed and rebuilt during the metamorphosis. This is conspicuously the case in the metazoous Insecta, in some of which all the internal organs undergo disruption and are reformed. It happens also in those nemertine worms which develop by a larva; in these the larval epidermis is cast off, a new one having been formed. It is possible that the same phenomenon occurs in sponges. In most Echinoderms a similar phenomenon is observed with regard to the oesophagus and the mouth and anus. The probable explanation of this remarkable phenomenon would appear to be that in certain cases the larval organs become so highly specialized in connexion with the larval life that they are unable to undergo further change, new formation is therefore necessary. The phenomenon is one of considerable interest, for it is found in the case of the blastopore, in cases in which there is no metamorphosis, sometimes even in embryonic development. There can be little doubt that the mouth and anus are both genetically connected with the earlier blastopore and that the blastopore is homologous in most animals; and yet how seldom does the blastopore become transformed into the adult openings and how various is its fate. The hypothesis suggested above applies completely to this behaviour of the blastopore; that is to say, it is suggested that the primitive mouth or blastopore becomes, or has become in some vanished larval history, so highly specialized in connexion with larval needs that it is unable to give rise to both mouth and anus, and in some cases to either. (A. S. *)

METAPHOR (Gr. *μεταφορά*, transfer of sense, from *μεταφέρω*, to carry over), a figure of speech, which consists in the transference to one object of an attribute or name which strictly and literally is not applicable to it, but only figuratively and by analogy. It is thus in essence an emphatic comparison, which if expressed formally is a "simile" (Lat. *similis*, like); thus it is a metaphorical expression to speak of a ship ploughing her way through the waves, but a simile when it takes the form of "the ship, like a plough, moves," &c. The "simple" metaphor, such as the instance given, becomes the "continued" metaphor when the analogy or similitude is worked out in a series of phrases and expressions based on the primary metaphor; it is in such "continued metaphors" that the solecism of "mixed" metaphors is likely to occur.

METAPHYSICS, or **METAPHYSIC** (from Gr. *μετά*, after, *φυσικά*, things of nature, *φύσις*, i.e. the natural universe), the accepted name of one of the four great departments of philosophy (q.v.). The term was first applied to one of the treatises of Aristotle on the basis of the arrangement of the Aristotelian canon made by Andronicus of Rhodes, in which it was placed "after the physical treatises" with the description *τὰ μετὰ τὰ φυσικά*. The term was used not in the modern sense of above or transcending nature (a sense which *μετά* cannot bear), but simply to convey the idea that the treatise so-called comes "after" the physical treatises. It is therefore nothing more than a literary accident that the term has been applied to that department or discipline of philosophy which deals with first principles. Aristotle himself described the subject matter of the treatise as "First

* On the true order of the Aristotelian treatises see ARISTOTLE.

Philosophy" or "Theology," which deals with being as being (*Metaph. Γ. i.*, ἐστὶν ἐπιστήμη τις ἢ θεωρεῖ τὸ ὄν ἢ ὅν καὶ τὰ τοῦτ' ὑπάρχοντα καθ' αὐτὸ). From this phrase is derived the later term "Ontology" (*q.v.*). The misapprehension of the significance of *μετά* led to various mistaken uses of the term "metaphysics," e.g. for that which is concerned with the supernatural, not only by the schoolmen but even as late as 17th-century English writers, and within narrower limits the term has been dangerously ambiguous even in the hands of modern philosophers (see below). In the widest sense it may include both the "first philosophy" of Aristotle, and the theory of knowledge (in what sense can there be true knowledge?), i.e. both ontology and epistemology (*q.v.*), and this is perhaps the most convenient use of the term; Kant, on the other hand, would represent metaphysics as being "nothing more than the inventory of all that is given us by pure reason, systematically arranged" (i.e. epistemology). The earliest "metaphysicians" concerned themselves with the nature of being (ontology), seeking for the unity which they postulated behind the multiplicity of phenomena (see IONIAN SCHOOL OF PHILOSOPHY and articles on the separate thinkers); later thinkers tended to inquire rather into the nature of knowledge as the necessary pre-requisite of ontological investigation. The extent to which these two attitudes have been combined or separated is discussed in the ensuing article which deals with the various schools of modern metaphysics in relation to the principles of the Aristotelian "first philosophy."¹ (X)

1.—THE SCIENCE OF BEING

Side by side with psychology, the science of mind, and with logic, the science of reasoning, metaphysics is tending gradually to reassert its ancient Aristotelian position as the science of being in general. Not long ago, in England at all events, metaphysics was merged in psychology. But with the decline of dogmatic belief and the spread of religious doubt—as the special sciences also grow more general, and the natural sciences become more speculative about matter and force, evolution and teleology—men begin to wonder again about the nature and origin of things; just as it was the decay of polytheism in Greek religion and his own discoveries in natural science which impelled Aristotle to metaphysical questions. There is, however, a certain difference in the way of approaching things. Aristotle emphasized being as being, without always sufficiently asking whether the things whose existence he asserted are really knowable. We, on the contrary, mainly through the influence of Descartes, rather ask what are the things we know, and therefore, some more and some less, come to connect ontology with epistemology, and in consequence come to treat metaphysics in relation to psychology and logic, from which epistemology is an offshoot.

To this pressing question then—What is the world as we know it?—three kinds of definite answers are returned: those of materialism, idealism and realism, according to the emphasis laid by metaphysicians on body, on mind, or on both. *Metaphysical materialism* is the view that everything known is body or matter; but while according to ancient materialists soul is only another body, according to modern materialists mind without soul is only an attribute or function of body. *Metaphysical idealism* is the view that everything known is mind, or some mental state or other, which some idealists suppose to require a substantial soul, others not; while all agree that body has no different being apart from mind. *Metaphysical realism* is the intermediate view that everything known is either body or soul, neither of which alone exhausts the universe of being. Aristotle, the founder of metaphysics as a distinct science, was also the founder of metaphysical realism, and still remains its main authority. His view was that all things are substances, in the sense of distinct individuals, each of which has a being of its

own different from any other, whereas an attribute has only the being of its substance (*Met. Z 1-3; Post. An. i. 4*); that bodies in nature are obviously natural substances, and as obviously not the only kind of substance; and that there is supernatural substance, e.g. God, who is an eternal, perfect, living being, thinking, but without matter, and therefore not a body.

At the present day realism is despised on the ground that its differentiation of body and soul, natural and supernatural, ignores the unity of being. Indeed, in order to oppose this unity of being to the realistic duality, both materialists and idealists describe themselves as monists, and call realists dualists by way of disparagement. But we cannot classify metaphysics by the antithesis of monism and dualism without making confusion worse confounded. Not to mention that it has led to another variety, calling itself pluralism, it confuses materialism and idealism. Extremes meet; and those who believe only in body and those who believe only in mind, have an equal right to the equivocal term "monist." Moreover, there is no real opposition between monism and dualism, for there can very well be one kind of being, without being all body or all soul; and as a matter of fact, Aristotelian realism is both a monism of substance and a dualism of body and soul.

It is in any case unfair to decide questions by disparaging terms, and to argue as if the whole choice were between materialistic or idealistic monism, leaving realism out of court. In this case it would also hide the truth of things, which requires two different kinds of substance, body and soul. The strength of materialism consists in recognizing nature without explaining it away, its weakness in its utter inability to explain consciousness either in its nature or in its origin. On the other hand, it is the virtue of idealism to emphasize the fact of consciousness, but its vice to exaggerate it, with the consequence of resorting to every kind of paradox to deny the obvious and get rid of bodies. There are in reality two species of substances, or entirely distinct things, those which are impenetrably resisting, and those which are conscious substances; and it is impossible to reduce bodies and souls to one another, because resistance is incompatible with the attributes of spirit, and consciousness inexplicable by the attributes of body. So far true metaphysics is a dualism of body and soul. But this very dualism is also monism: both bodies and souls are substances, as Aristotle said; and we can go farther than Aristotle. Men are apt to dwell too much on the co-existence and too little on the inclusiveness of substances. The fact is that many substances are often in one; e.g. many bodies in the one body, and both body and soul in the one substance, of man. So far true metaphysics is a monism of substance, in the sense that all things are substances and that all substances, however different, are members of one substance, the whole universe of body and spirit. In this case metaphysics generally will have to recognize three monisms, a materialistic monism of body, an idealistic monism of soul, and a realistic monism of substance, which is also a dualism of substances. But a term so equivocal, leading to an antithesis so misleading as that between monism and dualism, can never represent the real difference between metaphysical schools. We shall return, then, to the clearer and more authoritative division, and proceed to discuss materialism, idealism and realism in their order.

2.—MATERIALISM

1. *Materialism Proper.*—Materialism in its modern sense is the view that all we know is body, of which mind is an attribute or function. Several causes, beginning towards the end of the 18th century, gradually led up to the materialism of Mole-schott, Vogt and Büchner, which flourished in the middle of the 19th century. The first cause was the rapid progress of natural science, e.g. the chemistry of Lavoisier, the zoology of Lamarck, the astronomy of Laplace and the geology of Lyell. These advances in natural science, which pointed to a unity and gradual evolution in nature, were accompanied by a growth in commerce, manufactures and industrialism; the same kind of spirit showed itself in the revolutionary upheaval of 1848, and in the materialistic publications which immediately followed, while these

¹The article is supplemented by e.g. IDEALISM; PRAGMATISM; RELATIVITY OF KNOWLEDGE, while separate discussions of ancient and medieval philosophers will be found in biographical articles and articles on the chief philosophical schools, e.g. SCHOLASTICISM; NEOPLATONISM.

publications have reacted on the industrial socialism of our own time. Meanwhile, philosophic forces to counteract materialism were weak. Realism was at a low ebb. Idealism was receding for the moment. Hegelianism had made itself unpopular, and its confusion of God, nature and man had led to differences within the school itself (see HEGEL).

These causes, scientific, industrial and philosophical, led to the domination of materialism in the middle of the 19th century in Germany, or rather to its revival; for in its main position, that matter and motion are everything and eternal, it was a repetition of the materialism of the 18th century in France. Thus Karl Christoph Vogt (*q.v.*) repeated the saying of the French physician Cabanis, "The brain is determined to thought as the stomach is to digestion, or the liver to the secretion of bile," in the form, "Thought stands in the same relation to the brain as the bile to the liver or the urine to the kidneys." But the new materialism was not mere repetition. J. Moleschott (1822-1893) made a diligent use of the science of his day in his *Kreislauf des Lebens* (1852). Starting from Lavoisier's discoveries, he held that life is metabolism, a perpetual circulation of matter from the inorganic to the organic world,

Moleschott. and back again, and he urged this metabolism against the hypothesis of vital force. Aristotle had imputed to all living beings a soul, though to plants only in the sense of a vegetative, not a sensitive, activity, and in Moleschott's time many scientific men still accepted some sort of vital principle, not exactly soul, yet over and above bodily forces in organisms. Moleschott, like Lotze, not only resisted the whole hypothesis of a vital principle, but also, on the basis of Lavoisier's discovery that respiration is combustion, argued that the heat so produced is the only force developed in the organism, and that matter therefore rules man. He put the whole materialistic view of the world into the following form: Without matter no force, without force no matter. L. Büchner (*q.v.*) himself said that he owed to Moleschott the first impulse to composing his important work *Kraft und Stoff* (1855), which became a kind of

Büchner. textbook of materialism. Passing from Moleschott to Lyell's view of the evolution of the earth's crust and later to Darwin's theory of natural selection and environment, he reached the general inference that, not God but evolution of matter, is the cause of the order of the world; that life is a combination of matter which in favourable circumstances is spontaneously generated; that there is no vital principle, because all forces, non-vital and vital, are movements; that movement and evolution proceed from life to consciousness; that it is foolish for man to believe that the earth was made for him, in the face of the difficulties he encounters in inhabiting it; that there is no God, no final cause, no immortality, no freedom, no substance of the soul; and that mind, like light or heat, electricity or magnetism, or any other physical fact, is a movement of matter. Sometimes he spoke of mind as an effect of matter; but, though his expressions may be careless, nothing is to be made of the difference, for he called it movement and effect indifferently in the same context. His definitely expressed view was that psychical activity is "nothing but a radiation through the cells of the grey substance of the brain of a motion set up by external stimuli."

E. Haeckel belongs to a slightly later time than the materialists hitherto mentioned. His book *Die Weiräthsel* (Eng. trans.

Haeckel. J. McCabe, *The Riddle of the Universe*) identifies substance with body. Starting like his predecessors with the indestructibility of matter, Haeckel makes more than they do of the conservation of energy, and merges the persistence of matter and energy in one universal law of substance, which, on the ground that body is subject to eternal transformation, is also the universal law of evolution. His strong point consists in inferring the fact of evolution of some sort from the consideration of the evidence of comparative anatomy, palaeontology and embryology. On the strength of the concision of arguments for evolution in the organic world, he carries back the process in the whole world, until he comes to a cosmology which recalls the rash hypotheses of the Presocratics.

He supposes that all organisms have developed from the simple cell, and that this has its origin by spontaneous generation, to explain which he propounds the "carbon-theory," that protoplasm comes from inorganic carbonates. He not only agrees with Laplace and Lyell about the evolution of the solar system, but also supposes that the affinities, pointed out by Lohse Meyer and Mendeloff, between groups of chemical elements prove an evolution of these elements from a primitive matter (*prothly*) consisting of homogeneous atoms. These, however, are not ultimate enough for him; he thinks that everything, ponderable and imponderable or ether, is evolved from a primitive substance, which condenses first into centres of condensation (*psynatoms*), and then into masses, which when they exceed the mean consistency become ponderables, and when they fall below it become imponderables. He holds Meyer and Mendeloff's substance is eternal and eternally subject to the law of substance; and God is the eternal force or energy of substance. What, then, is the origin of mind or soul? Haeckel answers that it has no origin, because sensation is an inherent property of all substance. He supposes that *aesthesis* and *tropesis*, as rudimentary sensation and will, are the very causes of condensation; that they belong to *psynatoms*, to ponderables and imponderables, to chemical atoms and molecules. Hence, when he returns to organisms, it does not surprise us that he assigns to ova and spermatozoa cell-souls, to the impregnated ovum germ-soul, to plants tissue-souls, to animals nerve-souls; or that he regards man's body and soul as born together in the impregnated ovum, and gradually evolved from the bodies and souls of lower animals. It appears to his imagination that the affinity of two atoms of hydrogen to one of oxygen, the attraction of the spermatozoa to the ovum, and the relative affinity of a pair of lovers are all alike due to sensation and will.

But has Haeckel solved the problems of mind? When he applies sensation and will to nature, and through plants to the lowest animals, he considers their sensation and will to be rudimentary and unconscious. Consciousness, according to his own admission, is not found even in all animals, although it is present not only in the highest vertebrates—men, mammals, birds—but also in ants, spiders, the higher crabs and molluscs. He holds indeed that, in accordance with the law of substance, consciousness must be evolved from unconsciousness with the development of sense organs and a central nervous organ. At the same time he admits, firstly, that to mark the barrier between unconscious and conscious is difficult; secondly, that it is impossible to trace the first beginning of consciousness in the lower animals; and, thirdly, that "however certain we are of the fact of this natural evolution of consciousness, we are, unfortunately, not yet in a position to enter more deeply into the question" (*Riddle of the Universe*, 191). Thus in presence of the problem which is the crux of materialism, the origin of consciousness, he first propounds a gratuitous hypothesis that everything has mind, and then gives up the origin of conscious mind after all. He is certain, however, that the law of substance somehow proves that conscious soul is a mere function of brain, that soul is a function of all substances, and that God is the force or energy, or soul or spirit, of nature. He, in fact, returns to a *cient hylazoism* (*q.v.*), which has tended to revive from time to time in the history of thought. He believes that mind and soul are inherent attributes of all bodies. Curiously enough, he supposes that by making mind a universal attribute of matter he has made his philosophy not materialism, but monism. It is really both: monistic, because it reduces substance to one kind; materialistic, because it identifies that one kind of substance with body or matter, and reduces mind to an attribute of matter. It makes no difference to attribute mind to all matter, so long as it is attributed as an attribute. It is at least as materialistic to say that unconscious mind is an attribute of nature as to say that conscious mind is an attribute of brain; and this is the position of Haeckel. Materialists seem to dread the word "materialism." Büchner also entreats us "to abandon the word 'materialism,' to which (it is not clear why) a certain scientific odium attaches, and substitute 'monism' for it" (*Last Words on Materialism*, 273). His reason, however, is different: it is that a philosophy, not of matter as such, but of the unity of force and matter, is not materialism. But if a philosophy makes force an attribute of matter only, as his does, it will recognize nothing but matter possessing force, and will therefore be materialism as well as monism, and in short materialistic monism. The point is that neither Büchner nor Haeckel could on their assumptions recognize any force but force of

body, or any mind but mind of body, or any distinct thing or substance except body. This is materialism.

2. *Materialistic Tendencies.*—Besides these direct instances of materialism, there are philosophers to whom the scientific tendencies of the age have given a materialistic tendency. In Germany, for example, Eugen Dühring (*q.v.*) was a realist, whose intention is to prove against Kant a knowledge of the thing in itself by attributing time, space and categories generally to the real world. But, under the influence of Trendelenburg's attempt to reconcile thought and being by assigning motion to both, his *Wirklichkeitsphilosophie*, in a similar effort after a unity of being, lands him in the contention that matter is absolute being, the support of all reality underlying all bodily and mental states. So Avenarius (*q.v.*) was no materialist, but only an empiricist anxious to reclaim man's natural view of the world from philosophic incrustations, yet when his *Empiriokriticismus* ends in nothing but environment, nervous system, and statements dependent on them, without soul, though within experience, he comes near to materialism, as Wundt has remarked. In France, again, positivism is not materialism, but rather the refusal to frame a metaphysical theory. Comte tells us that man first gets over theology, then over metaphysics, and finally rests in positivism. Yet in getting over theology he ceases to believe in God, and in getting over metaphysics he ceases to believe in soul. As Paul Janet truly remarked, positivism contains an unconscious metaphysics in rejecting final causes and an immaterial soul. Now, when in surrendering theology and metaphysics we have also to surrender God and the soul, we are not free from materialism. Positivism, however, shelters itself behind the vague word "phenomena." Lastly, in England we have not only an influence of positivism, but also, what is more important, the synthetic philosophy of Herbert Spencer.

Spencer. point of this philosophy is not materialism, but realism. The author himself says that it is transfigured realism—which is realism in asserting objective existence as separate from subjective existence, but anti-realism in denying that objective existence is to be known. In his *Principles of Psychology* he twice quotes his point that "what we are conscious of as properties of matter, even down to its weight and resistance, are but subjective affections produced by objective agencies which are unknown and unknowable." This then is his transfigured realism, which, as far as what is known goes, is idealism, but as far as what exists goes, realism—of a sort. His *First Principles*, his book on metaphysics, is founded on this same point, that what we know is phenomena produced by an unknown noumenal power. He himself identifies phenomenon, appearance, effect or impression produced on consciousness through any of the senses. He divides phenomena into impressions and ideas, vivid and faint, object and subject, non-ego and ego, outer and inner, physical and psychical, matter and spirit; all of which are expressions of the same antithesis among phenomena. He holds that all the time, space, motion, matter known to us are phenomena; and that force, the ultimate of ultimates, is, as known to us, a phenomenon, "an affection of consciousness." If so, then all we know is these phenomena, affections of consciousness, subjective affections, but produced by an unknown power. So far as this main point of transfigured realism is steadily maintained, it is a compound of idealism and realism, but not materialism. But it is not maintained, on the side either of phenomena or of noumena; and hence its tendency to materialism.

In the first place, the term "phenomenon" is ambiguous, sometimes meaning a conscious affection and sometimes any fact whatever. Spencer sets himself to find the laws of all phenomena. He finds that throughout the universe there is an unceasing redistribution of matter and motion, and that this redistribution constitutes evolution when there is a predominant integration of matter and dissipation of motion, and constitutes dissolution where there is a predominant absorption of motion and disintegration of matter. He supposes that evolution is primarily integration, from the incoherent to the coherent, exemplified in the solar nebula evolving into the solar system; secondly *differentiation*, from the more homogeneous to the more heterogeneous, exemplified by the solar system evolving into different bodies; thirdly *determination*, from the indefinite to the definite, exemplified by the

solar system with different bodies evolving into an order. He supposes that this evolution does not remain cosmic, but becomes organic. In accordance with Lamarck's hypothesis, he supposes an evolution of organisms by hereditary adaptation to the environment (which he considers necessary to natural selection), and even the possibility of an evolution of life, which, according to him, is the continuous adjustment of internal to external relations. Next, he supposes that mind obeys the same law of evolution, and exemplifies integration by generalization, differentiation by the development of the five senses, and determination by the development of the order of consciousness. He holds that we pass without break from the phenomena of bodily life to the phenomena of mental life, that consciousness arises in the course of the living being's adaptation to its environment, and that there is a continuous evolution from reflex action through instinct and memory up to reason. He throws out the brilliant suggestion that the experience of the race is in a sense inherited by the individual; which is true in the sense that animal organisms become hereditarily better adapted to perform mental operations, though no proof that any elements of knowledge become a priori.

Now, Spencer has clearly, though unconsciously, changed the meaning of the term "phenomenon" from subjective affection of consciousness to any fact of nature, in regarding all this evolution, cosmic, organic, inorganic, social, and aërial, as an evolution of phenomena. The greater part of the process is change in the facts of nature before consciousness; and in all that part, at all events, the phenomena evolved must mean physical facts which are not conscious affections, but, as they develop, are causes which gradually produce life and consciousness. Moreover, evolution is defined universally as an "integration of matter and dissipation of motion," and yet mental, social and moral developments are also called evolution, so that, in accordance with the definition, they are also integrations of matter and dissipations of motion. It is true that the author did not see that he was passing from transfigured realism into materialism. He thinks that he is always speaking of phenomena in the sense of subjective affections; and in spite of his definition, he half unconsciously changes the meaning of evolution from a change in matter and motion, first into a change in states of consciousness, then to a change in social institutions, and finally into a change in moral motives. He also admits himself that mental evolution exemplifies integration of matter and dissipation of motion only indirectly. But here he becomes hopelessly inconsistent, because he had already said, in defining it, that "evolution is an integration of matter and concomitant dissipation of motion" (*First Principles*, § 145). However, with all the author's disclaimers, the general effect left on the reader's mind is that throughout the universe there is an unceasing change of matter and motion, that evolution implies a change, and that a change in the phenomena in the sense of physical facts, is actually issued in life and consciousness, and ends with phenomena in the sense of subjective affections of consciousness.

In the second place, having declared the noumenal power, which causes phenomena, or conscious affections, to be unknowable, and having left anybody who pleased to make it a god and an object of religion, he proceeds to describe it as if it were known force, and known in two respects as persistent and as resistant force. He supposes that the law of evolution is deducible from the law of persistent force, and includes in force what is now called energy. Then having discussed force as something thoroughly material, and laying stress on its always resistance, he tells us that "the force of which we assert persistence is that Absolute Force of which we are indefinitely conscious as the necessary correlate of the force we know" (*First Principles*, § 62). Similarly, both in *First Principles* and in the *Principles of Psychology*, he assigns to us, in addition to our definite consciousness of our subjective affections, an indefinite consciousness of something out of consciousness, of something which resists, of objective existence. Thus it turns out that the objective agency, the noumenal power, the absolute force, declared unknown and unknowable, is known after all to exist, persist, resist or cause our subjective affections or phenomena, yet not to think or to will. Such a noumenon looks very like body or matter. Lastly, when a theory of the world supposes a noumenal power, a resistant and persistent force, which results in an evolution, defined as an integration of matter and a dissipation of motion, which having resulted in inorganic nature and organic nature, further results without break in consciousness, reason, society and morals, then such a theory will be construed as materialistically as that of Haeckel by the reader, whatever the intention of the author.

It may be urged in reply that the synthetic philosophy could be made consistent by transferring the knowable resistance and persistence of the unknowable noumenon to knowable phenomena on the one hand, and on the other hand by maintaining that all phenomena from the original nebula to the rise of consciousness are only "impressions produced on consciousness through any of the senses," but not as that case what will become of Spencer's theory of evolution? It will have asserted the evolution of man and his consciousness out of the phenomena of his consciousness. The truth is that his theory of evolution can be carried through the whole process without a break, only by giving the synthetic philosophy a materialistic interpretation, and by adhering consistently to

Spencer's own materialistic definition of evolution; otherwise there will be a break at least between life and mind. If everything knowable is an example of evolution, and evolution is by definition a transformation of matter and motion, then everything knowable is an example of a transformation of matter and motion. As an exponent of universal evolution Haeckel is more consistent than Spencer.

Huxley (1825-1895) developed views very like those of Spencer, and similarly materialistic without being materialism, because inconsistent. He regarded everything known as evolved from matter.

Huxley. "matter, and reduced consciousness to a mere collateral product ("epiphenomenon") of cerebral operations without any power of influencing them. Matter, according to him, impresses the afferent nervous system, this the brain, this the efferent nervous system, while consciousness remains a mere spectator. "In man, as in brutes," said he, "there is no proof that any state of consciousness is the cause of change in the nature of the matter of the organism"; so that "we are conscious automata." But, in spite of these materialistic tendencies, he followed Hume in reducing matter and everything knowable to phenomena of consciousness; and, supposing that nothing is knowable beyond phenomena, concluded that we can neither affirm nor deny that anything exists beyond, but ought to take up an attitude which the ancient sceptics called Apathia, but he dubbed by the new name of Agnosticism. Thus Huxley first reduced consciousness to a product of matter, and then matter to a phenomenon of consciousness. By combining materialism with idealism he made consciousness a product of itself. Tyndall (1820-

Tyndall. 1893), again, came still nearer to materialism, and yet avoided it. In his Belfast address (1874), while admitting that matter as understood by Democritus is insufficient, because atoms without sensation cannot be imagined to produce sensation, he contended, nevertheless, that matter properly understood is "the promise and potency of all terrestrial life." In thus endowing all matter with sensation like Haeckel he was not avoiding materialism. But in the very same address, as well as on other occasions, he did not identify mind with matter, but regarded them as concomitant.

All these materialistic tendencies seem to have one explanation. They emanate from scientific writers who rightly try to rise from science to metaphysics, but, as Bacon says, build a universal philosophy on a few experiments. The study of evolution, without considering how many conditions are required for "the integration of matter and the dissipation of motion" to begin, and the undoubted discoveries which have resulted from the study of inorganic and organic evolution, have led men to expect too much from this one law of Nature. This tendency especially prevails in biology, which is so far off the general principles of natural philosophy that its votaries are often ignorant of the real nature of body as matter and force. The close dependency of all mental operations on brain also tempts them to the conclusion that brain is not only an organ, but the whole organ of conscious mind.¹ It appears also that Darwin, having extended his theory of evolution as far as the rational and moral nature of man, in the *Descent of Man*, ended in his *Autobiography* by declaring his attitude to first and final causes to be that of an agnostic. Not that he was a materialist, and shortly before his death, in a conversation with Büchner, he maintained his agnosticism against his opponent's atheism. Still, his agnosticism meant that, though he did not assert that there is no God, he did assert that we cannot know whether there is or is not. To the evolutionary biologist brain is apt to appear to be the crowning object of knowledge. On the other hand, scientific men, such as Herschel, Maxwell and Stokes, who approach nature from mathematics and mechanics, and therefore from the universal laws of motion, have the opposite tendency, because they perceive that nature is not its own explanation. In order to exert force, or at all events that force of reciprocal pressure which we best understand, and on which, in impact, the third law of motion was founded, there are always at least two bodies, enduring, triply extended, mobile, each inert, mutually impenetrable or resistant, different yet similar; and in order to have produced any effect but equilibrium, some bodies must at some time have differed either in mass or in velocity, otherwise forces would only have neutralized one another. Why do bodies exist, with all these conditions, so similar yet different—that is, in so harmonious an order? Natural science has no answer: natural theology has an answer. This essence of bodies, this resemblance in difference, this prevailing

¹ Cf. H. Maudesley, *Lessons of Materialism* (1879).

order of Nature, is the deepest proof of God; and it cannot be the result of evolution, because it is the condition of natural force, and therefore of natural evolution. A second argument for God is the prevailing goodness or adaptation of Nature to the ends of conscious beings, which might conceivably be explained by Lamarckian evolution, but has not yet been so explained, and if it were, would not be inconsistent with a divine design in evolution. Further, the very existence of conscious beings is the best proof of the distinct or substantial being of the soul, existing in man with body, in God as pure spirit. It seems hopeless to expect that natural science, even with the aid of evolution, can explain by mere body the origin and nature of this fact of consciousness. If so, materialism is not the whole truth of metaphysics.

3.—THE RISE OF METAPHYSICAL IDEALISM

1. *Descartes to Leibnitz.*—Metaphysical arises from psychological idealism, and always retains more or less of an epistemological character. Psychological idealism assumes without proof that we perceive nothing but mental objects, and metaphysical idealism draws the logical but hypothetical conclusion that all we can know from these mental objects of sense is mental objects of knowledge. But at first this logical conclusion was not drawn. Descartes, the founder of psychological idealism, having proceeded from the conscious fact, *cogito ergo sum*, to the *non sequitur* that I am a soul, and all a soul can perceive is its ideas, nevertheless went on to the further illogical *Descartes*, conclusion that from these mental ideas I can (by the grace of God) infer things which are extended substances or bodies, as well as thinking substances or souls. He was a psychological idealist and a metaphysical realist. This illogicality could not last. Even the Cartesian school, as it came more and more to feel the difficulty of explaining the interaction of body and mind, and, indeed, any efficient causation whatever, gradually tended to the hypothesis that the real cause is God, who, on the occasion of changes in body, causes corresponding changes in mind, and vice versa. This occasionalism is not idealism, but its emphasis on the will of God gave it an idealistic tendency. Thereupon Spinoza advanced a pantheism which supposed that bodies and souls are not, as Descartes thought, different substances, but merely attributes—the one the extension and the other the thought of one substance, Nature or God. Taking the Aristotelian theory that a substance is a thing in *Spinoza*, itself, not in Aristotle's sense of any individual existing differently from anything else, but in the novel meaning of something existing alone, he concluded, logically enough from this mere misunderstanding, that there can be only one substance, and that, as no finite body or soul can exist alone, everything finite is merely a mode of one of the attributes of the one infinite substance which alone can exist by itself. Spinozism, however, though it tramples down the barrier between body and soul, is not yet metaphysical idealism, because it does not reduce extension to thought, but only says that the same substance is at once extended and thinking—a position more akin to materialism. At the same time Spinoza maintained a parallelism between extension and thinking so close as to say that the order of ideas is the same as the order of things, so that any mode of extension and the idea of it are the same thing expressed in two ways, under the attribute of extension and under the attribute of thought (see H. H. Joachim's *Study of the Ethics of Spinoza*, 1901, p. 72). It remained, however, for Schelling to convert this parallelism into identity by identifying motion with the intelligence of God, and so to transform the pantheism of Spinoza into pantheistic idealism. Leibnitz, again, having become equally dissatisfied with Cartesianism, Spinozism and the Epicurean realism of Gassendi, in the latter part of his life came still *Leibnitz*, nearer than Spinoza to metaphysical idealism in his monadology, or half-Pythagorean, half-Brunstic analysis of bodies into monads, or units, or simple substances, indivisible and unextended, but endowed with perception and appetite.

He gradually fell under the dominion of two false assumptions. On the one hand, essentially a mathematician, he supposed that

unity is indivisibility, whereas everything known to be one is merely undivided or individual, and that there must be simple because there are compound substances, although composition only requires simpler or relatively simple elements. On the other hand, under the influence of the mechanics of his day, which had hardly distinguished between inertia, or the inability of a body to change itself, and resistance or the ability of bodies to oppose one another, he concluded that, as inertia is passive, so is resistance, and refused to recognize that in collision the mutual resistance of moving bodies is a force, or active power, of changing their movements in opposite directions. From these two arbitrary hypotheses about corporeal motion, that it requires indivisibly simple elements, and that it offers only passive resistance, he concluded that behind bodies there must be units, or monads, which would be at once substantial, simple, indivisible and active. He further supposed that the monads are "incorporeal automata," not interacting like bodies, but each perceiving what was passing in it, either, and acting in consequence by appetite, or self-acting. Such mentally endowed substances might be called souls; but, as he distinguished between perception and apperception or consciousness, and considered that perceptions are often unconscious, he preferred to divide monads into unconscious entelechies of inorganic bodies, sentient souls of animals, and rational souls, or spirits, of men; while he further concluded that all these are derivative monads created by God, the monad of monads. All derivative monads, he allowed, are accompanied by bodies, which, however, are composed of other monads dominated by the central Monad. Finally, he explained the great Cartesian difficulty of the relation of body and mind by transforming the Spinozistic parallelism of extension and thought into a parallelism between the motions of bodies and the perceptions of their monads; motions always proceeding from motions, and perceptions from perceptions; bodies acting according to efficient causes, and souls according to final causes by appetite, and as if one influenced the other without actually doing so. Finally, he explained the concomitance of these two series, as well as that between the perceptions of different monads, by supposing a pre-established harmony ordained by the primitive monad, God.

Up to this point, then, Leibnitz opened one of the chief avenues to metaphysical idealism, the resolution of the material into the immaterial, the analysis of bodies into mental elements. His theory of bodies involved an idealistic analysis, neither into bodily atoms nor into mathematical units, but into mentally endowed simple substances. There remained, however, his theory of the nature of bodies; and here he hesitated between two alternatives. According to one alternative, which consistently flowed from the psychological idealism of Descartes, as well as from his own monadism, he suggested that bodies are real phenomena; phenomena, because they are aggregates of monads, which derive their unity only from appearing together to our perceptions; real phenomena well founded, because they result from real monads. In support of this view, he said that bodies are not substances, though *substantiata*; that their apparent motion and resistance are results of the passions of their monads; that their primary matter is nothing but passive power of their monads; that the series of efficient causes between them is merely phenomenal. According to this alternative, then, there is nothing but mental monads and mental phenomena; and Leibnitz is a metaphysical idealist. According to the other alternative, however, he suggested that at least organic bodies are compound or corporeal substances, which are not phenomena; but something realizing or rather substantializing phenomena, and not mere aggregates of monads, but something substantial beyond their monads, because an organic body, though composed of monads, has a real unity (*unio realis*). From this point of view he believed that the real unity of a body is a *vinculum substantiale*, which gives it its real continuity and is the principle of its actions; that its primary matter is its own principle of resistance; and that it has not only this passive, but also an active, power of its own. He suggested that this theory of the substantial unity of a body might explain transubstantiation, by supposing that, while the monads and phenomena of bread remain, the *vinculum substantiale* of the body of Christ is substituted. He feared also whether we can explain the mystery of the Incarnation, and other things, unless real bonds or unions are added to monads and phenomena. According to this alternative, these organic bodies are compound or corporeal substances, between monads and phenomena; and Leibnitz is a metaphysical realist. He was held to this belief in the substantiality of bodies by his Christianity, by the influence of

Aristotle, of scholasticism and of Cartesianism, as well as by his own mechanics. But the strange thing is that at the very end of his life and at the very same time, in 1714-1716, he was writing the idealistic alternative to Remond de Montmort and Dancourt, and the realistic alternative to Father des Bosses. He must have died in doubt. We cannot, therefore, agree with many recent idealists who regard Leibnitz as one of themselves, though it is true that, when stripped of its realism, his metaphysics easily passed into the metaphysical idealisms of Lotze and of Fechner. It is true, also, that on its idealistic side the philosophy of Leibnitz is the source of many current views of pansychism, of psychophysical parallelism as well as of the phenomenalism of bodies, and of the analysis of bodies into mental elements.

2. *Locke to Hume*.—Meanwhile in England, Locke, though differing from Descartes about the origin of ideas, followed him in the illogical combination of psychological idealism with metaphysical realism. He thought that we perceive nothing but ideas both of primary and of secondary qualities, and yet that somehow we are able to infer that, while our ideas of secondary qualities are not, those of primary qualities are, like the real qualities of external things. Berkeley saw the inconsistency of this position, and, in asserting that all we perceive and all we know is nothing but ideas in "mind, spirit, soul, or myself," has the merit of having made, as Paulsen remarks, "epistemological idealism the basis of metaphysical idealism." According to him, a body such as the sun is my idea, your idea, ideas of other minds, and always an idea of God's mind; and when we have sensible ideas of the sun, what causes them to arise in our different minds is no single physical substance, the sun, but the will of God's spirit. Hume saw that in making all the objects of perception ideas Berkeley had given as little reason for inferring substantial souls as substantial bodies. He therefore concluded that all we know from the data of psychological idealism is impressions or sensations, ideas, and associations of ideas, making us believe without proof in substances and causes, together with "a certain unknown, inexplicable something as the cause of our perceptions." We have here, in this sceptical idealism, the source of the characteristically English form of idealism still to be read in the writings of Mill and Spencer, and still the starting-point of more recent works, such as Pearson's *Grammar of Science* and James's *Principles of Psychology*.

3. *Kant and Fichte*.—Lastly, in Germany, partly influenced by Leibnitz and partly roused by Hume, Kant elaborated his transcendental or critical idealism, which if not, as he thought, the prolegomena to all future metaphysics, is still the starting-point of most metaphysical idealists. Kant. Kantism consists of four main positions, which it will be well to lay out, as follows:—

a. As to the origin of knowledge, Kant's position is that sense, outer and inner, affected by things in themselves, receives mere sensations or sensible ideas (*Vorstellungen*) as the matter which senses itself places in the a priori forms of space and time; that thereupon understanding, by means of the synthetic unity of apperception, "I think"—an act of spontaneity beyond sense, in all consciousness one and the same, and combining all my ideas as mine in one universal consciousness—and under a priori categories, or fundamental notions, such as substance and attribute, cause and effect, &c., unites groups of sensations or sensible ideas into objects and events, e.g. a house, one ball moving another; and that, accordingly, perception and experience, requiring both sense and understanding, are partly a posteriori and partly a priori, and constitute a knowledge of objects which, being sensations combined by synthetic unity under a priori forms, are more than mere sensations, but less than things in themselves. This first position is psychological idealism in a new form and supported by new reasons; for, if experience derives its matter from mental sensations and its form from mental synthesis of sensations, it can apprehend nothing but mental objects of sense, which, according to Kant, are sensible ideas having no existence outside our thought, not things in themselves; or phenomena, not noumena.

b. As to the known world, Kant's position was the logical deduction that from such phenomena of experience all we can know by logical reason is similar phenomena of actual or possible experience; and therefore that the known world, whether bodily or mental, is not a Cartesian world of bodies and souls, nor a Spinozistic world of one substance, nor a Leibnitzian world of monadic substances

created by God, but a world of sensations, such as Hume supposed, only combined, not by association, but by synthetic understanding into phenomenal objects of experience, which are phenomenal substances and causes—a world of phenomena not noumena. This second position is a new form of metaphysical idealism, containing the supposition, which lies at the foundation of later German philosophy, that since understanding shapes the objects out of sensations, and since nature, as we know it, consists of such objects, "understanding, though it does not make, shapes nature," as well as our knowledge. Known nature is a mental construction in part, according to Kant.

c. As to existence, Kant's position is the wholly illogical one that, though all known things are phenomena, there are things in themselves or noumena—things which are said to cause sensations of outer sense and to receive sensations of inner sense, though they are beyond the category of causality which is defined as one of the notions uniting phenomena; and things which are assumed to exist and have these causal attributes, though declared unknowable by any logical use of reason, because logical reason is limited by the mental matter and form of experience to phenomena; and all this according to Kant himself. This third position is a relic of ancient metaphysical realism; although it must be remembered that Kant does not go to the length of Descartes and Locke, who supposed that from mere ideas we could know bodies and souls, but suggests that beneath the phenomena of outer and inner sense the thing in itself may not be heterogeneous (*ungleichartig*). In this form we shall find the thing in itself revived by A. Richel.

d. As to the use of reason beyond knowledge, Kant's position is that, in spite of its logical inapplicability to transcendent phenomena, reason in its pure, or a priori use, contains necessary a priori "ideals" (*Ideen*), and practical reason, in order to account for moral responsibility, frames postulates of the existence of things in themselves, or noumena, corresponding to these "ideals"; postulates of a real free-will to practise morality, of a real immortality of soul to perfect it, and of a real God to crown it with happiness.

The fourth position is the coping-stone of Kant's metaphysics. It is quite inconsistent with its foundation and structure. Kant first deduced that from the experience of mental phenomena all logical use of reason is limited to mental phenomena, and then maintained that to explain moral responsibility practical reason postulates the existence of real noumena. But what is a postulate of practical reason to explain moral responsibility except a logical use of reason? Nevertheless, in his own mind Kant's whole speculative and practical philosophy was meant to form one system. In the preface to the second edition of the *Kritik* he says that it was necessary to limit speculative reason to a knowledge of phenomena, in order to allow practical reason to proceed from morality to the assumption of God, freedom, and immortality, existing beyond phenomena: "Ich musste also das Wissen aufheben, um zum Glauben Platz zu machen." He forgot that he had also limited all logical use of reason, and therefore of practical reason, to phenomena, and thereby undermined the rationality not only of knowledge, but also of faith.

Fichte now set himself in the *Wissenschaftslehre* (1794) to make transcendental idealism into a system of metaphysical idealism without Kant's inconsistencies and relics of realism.

Fichte. His point was that there are no things in themselves different from minds or acting on them; that man is no product of things; nor does his thinking arise from passive sensations caused by things; nor is the end of his existence attainable in a world of things; but that he is the absolute free activity constructing his own world, which is only his own determination, his self-imposed limit, and means to his duty which allies him with God. In order to prove this novel conclusion he started afresh from the Cartesian "I think" in the Kantian form of the synthetic unity of apperception acting by a priori categories; but instead of allowing, with all previous metaphysicians, that the Ego passively receives sensations from something different, and not contenting himself with Kant's view that the Ego, by synthetically combining the matter of sensations with a priori forms, partially constructs objects, and therefore Nature as we know it, he boldly asserted that the Ego, in its synthetic unity, entirely constructs things; that its act of spontaneity is not mere synthesis of passive sensations, but construction of sensations into an object within itself; and that therefore understanding makes as well as shapes Nature.

This construction, or self-determination, is what Fichte called *positing* (*setzen*). According to him, the Ego posits first itself

(thesis); secondly, the non-Ego, the other, opposite to itself (anti-thesis); and, thirdly, this non-Ego within itself (synthesis), so that all reality is in consciousness. But, he added, as the Ego is not conscious of this self-determining activity, but forgets itself, the non-Ego seems to be something independent, a foreign limit, a thing in itself *per se*. Hence it is, in fact, a theory of self-knowledge to show that the Ego posits the thing *per se* as only existing for itself, a *noumenon* in the sense of a product of its own thinking. Further, according to Fichte, on the one hand the Ego posits itself as determined through the non-Ego—no object, no subject; this is the principal fact about theoretical reason; on the other hand, the Ego posits itself as determining the non-Ego—no subject, no object; this is the principal fact about practical reason. Hence he united theoretical and practical reason, which Kant had separated, and both with will, which Kant had distinguished; for he held that the Ego, in positing the non-Ego, posits both its own limit and its own means to the end, duty, by its activity of thinking which requires will. The conclusion of his epistemology is that we start with ourselves positing subjective sensations—e.g. sweet, red—and refer them as accidents to matter in space, which, though mental, is objective, because its production is grounded on a law of all reason. The metaphysics resulting from this epistemology is that the so-called thing in itself is not a cause of our sensations, but a product of one's own thinking, a determination of the Ego, a thing known to the Ego which constructs it. Fichte thus transformed the transcendental idealism of Kant by identifying the thing with the object, and by interpreting noumenon, not in Kant's sense of something which speculative reason conceives and practical reason postulates which in accordance with the idea, but in the new meaning of a thought, or a logical reason. This change led to another. Kant had said that the synthetic unity "I think" is in all consciousness one and the same, meaning that I am always present to all my ideas. Fichte transformed this unity of the conscious self into a unity of all conscious selves, or a common consciousness; and this change enabled him to explain the unity of anything produced by the Ego by contending that it is not the different objects of different thinkers, but the one Ego or consciousness common to them all. According to Kant, the objective is valid for all consciousness; according to Fichte it is valid for one consciousness. Here he was for the first time grappling with a fundamental difficulty in metaphysical idealism which is absent from realism, namely, the difficulty of explaining the identity of a thing, e.g. the sun. As long as even the meagre realism of the Kantian thing in itself is maintained, the account of there being one-sun is simply that one thing causes different effects in different minds, and yet as only a thing in itself is converted into something mental, metaphysical idealism must either say that there are as many suns as minds, or that there is one mind and therefore one sun. The former was the alternative of Berkeley, the latter of Fichte.

Thus the complete metaphysical idealism of Fichte's *Wissenschaftslehre* formed out of the incomplete metaphysical idealism of Kant's *Kritik*, is the theory on its epistemological side that the Ego posits the non-Ego as a thing in itself, and yet as only a thing existing for it as its own noumenon, and on its metaphysical side that in consequence all reality is the Ego and its own determinations, which are objective, or valid for all, as determinations, not of you or of me, but of the consciousness common to all of us, the pure or absolute Ego. Lastly, Fichte called this system realism, in so far as it posits the thing in itself as another thing; idealism, in so far as it posits it as a noumenon which is a product of its own thinking; and on the whole as idealism or idealism.

God does not seem to find much place in the *Wissenschaftslehre*, where mankind is the absolute and nature mankind's product, and where God neither could be an absolute Ego which posits objects in the non-Ego to infinity without ever completing the process, nor could be even known to exist apart from the moral order which is man's destination. Hence in his *Philosophical Journal* in 1793 he wrote preface to a second part of Forberg's book on an essay of his own, in which he used the famous words: "The living moral order is God; we need no other God, and can comprehend no other." Having, however, in consequence, lost his professorship at Jena, he gradually altered his views, until at length he decided that God is not mere moral order, but also reason and will, yet without consciousness and personality; that not mankind but God is the absolute; that we are only its direct manifestations, free but finite spirits as destined by an absolute God. He wanted to believe in the absolute without sacrificing personality and freedom. God determines man, and man determines Nature: this is the final outcome of Fichte's pure idealism.

Fichte completed the process from psychological and epistemological to metaphysical idealism, which it has been necessary to

recall from its beginnings in France, England and Germany, in order to understand modern idealism. The assertion of absolute substance by Spinoza incited Schelling and Hegel. The analysis of bodies into immaterial elements by Leibnitz incited Lotze. The Spinozistic parallelism of extension and thought, and the Leibnizian parallelism of bodily motion and mental action, incited Schelling and Fechner. Berkeley and Hume produced the English idealism of Mill and Spencer, with their successors, and occasioned the German idealism of Kant. Kant's a priori synthesis of sensations into experience lies at the root of all German idealism. But Fichte was the most fertile of all. He carried metaphysical idealism to its height, by not only resolving the bodily into the mental, but also elevating the action of mind into absolute mental construction; not inferring things in themselves beyond, but originating things from within, mind itself. By changing the meaning of "noumenon" from the thing apprehended (*νοούμενον*) to the thought (*νόημα*), and in the hypothesis of a common consciousness, he started the view that a thing is not yours or my thought, but a common thought of all mankind, and led to the wider view of Schelling and Hegel that the world is an absolute thought of infinite mind. In making the essence of mind activity and construction, in destroying the separation of theoretical and practical reason, in asserting that mind thinks things as means to ends of the will, he prepared the way for Schopenhauer and other voluntarists. In making the essence of the Absolute not mere reason, but will, action and life, he anticipated Lotze. In reducing the thing in itself to a thought he projected the neo-Kantism of Lange and Cohen. In the doctrine—no object, no subject—no subject, no object—that is, in the utter identification of things with objects of subjects, he anticipated not only Schelling and Hegel, but also Schuppe and Wundt with their congeners. In expanding Kant's act of synthesis till it absorbed the inner sense and the innermost soul, he started the modern paradox that soul is not substance, but subject or activity, a paradox which has been gradually handed down from Schelling and Hegel to Fechner, and from Fechner to Paulsen and Wundt. Meanwhile, through holding with Kant that man is not God, but a free spirit, whose destiny it is to use his intelligence as a means to his duty, he is still the resort of many who vindicate man's independence, freedom, conscience, and power of using nature for his moral purposes, e.g. of Eucken and Münsterberg (*qq.v.*). Kant and Fichte together became the most potent philosophic influences on European thought in the 19th century, because their emphasis was on man. They made man believe in himself and his mission. They fostered liberty and reform, and even radicalism. They almost avenged man on the astronomers, who had shown that the world is not made for earth, and therefore not for man. Kant half asserted, and Fichte wholly, that Nature is man's own construction. The *Kritik* and the *Wissenschaftslehre* belonged to the revolutionary epoch of the "Rights of Man," and produced as great a revolution in thought as the French Revolution did in fact. Instead of the old belief that God made the world for man, philosophers began to fall into the pleasing dream, I am everything, and everything is I—and even I am God.

4.—NOUMENAL IDEALISM IN GERMANY

Noumenal idealism is the metaphysics of those who suppose that all known things are indeed mental, but not all are phenomenal in the Kantian sense, because a noumenon is knowable so long as by a noumenon we mean some mental being or other which we somehow can discover beyond phenomena. The noumenal idealists of Germany assumed, like all psychological idealists, the unproved hypothesis that there is no sense of body, but there is a sense of sensations; and they usually accepted Kant's point, that to get from such sensations to knowledge there is a synthesis contributing mental elements beyond the mental data of sense. They saw also the logic of Kant's deduction, that all we can know from such mental data and mental categories must also be mental. This was the starting-point of their metaphysical idealism. But they disagreed with Kant, and agreed with Fichte about things in themselves or noumena, and

contended that the mental things we know are not mere phenomena of sense, but noumena, precisely because noumena are as mental as phenomena, and therefore can be known from similar data: this was the central point of their noumenal idealism. They rightly revolted against the inconsistencies of Kant's third and fourth positions about the existence of unknown but postulated things in themselves, hidden from theoretical, but revealed to practical, reason. In a way they returned to the wider opinions of Aristotle, which had come down to Descartes and Locke, that reason in going beyond sense knows more things than phenomena; yet they would not hear of external bodies, or of bodies at all. No realists, they came nearer to Spinozistic pantheism and to Leibnizian monadism, but only on their idealistic side; for they would not allow that extension and body are different from thinking and mind. Their real founder was Fichte, on account of his definite reduction of the noumenal to a mental world. This was indeed the very point—the knowability of a noumenal mental world. At the same time it soon appeared that they could not agree among themselves when they came to ask what it is, but in attempting to define it seem to have gone through the whole gamut of mind. Schelling and Hegel thought it was infinite reason; Schopenhauer, unconscious will; Hartmann, unconscious intelligence and will; Lotze, the activity or life of the divine spirit; Fechner, followed by Paulsen, a world of spiritual actualities comprised in the one spiritual actuality, God, in whom we live and move and have our being.

1. Of these noumenal idealisms the earliest in time and the nearest to Fichte's philosophy was the panlogism, begun by Schelling (1775-1854), completed by his disciple Schelling, Hegel (1770-1831), and then modified by the master himself. Starting from Fichte's "Wissenschaftslehre," Schelling accepted the whole process of mental construction, and the deduction that noumena are knowable products of universal reason, the Absolute Ego. But from the first he was bolder than Fichte, and had no doubt that the Absolute is God. God, as he thought, is universal reason, and Nature a product of universal reason, a direct manifestation, not of man, but of God. How is this Absolute known? According to Schelling it is known by intellectual intuition. Kant had attributed to God, in distinction from man's understanding, an intellectual intuition of things. Fichte had attributed to man an intellectual intuition of himself as the Absolute Ego. Schelling attributes to man an intellectual intuition of the Absolute God; and as there is, according to him, but one universal reason, the common intelligence of God and man, this intellectual intuition at once gives man an immediate knowledge of God, and identifies man with God himself.

On Schelling's idealistic pantheism, or the hypothesis that there is nothing but one absolute reason identifying the opposites of subjectivity and objectivity, Hegel based his panlogism. But, while he fully recognized his indebtedness to his master, he differed from him profoundly in one fundamental respect. He rightly objected that the system was wanting in logical proof: He rightly, therefore, rejected the supposed intellectual intuition of the Absolute. He rightly contended that, if we are to know anything beyond sense, we must know it by a process of logical reason. But, unfortunately, he did not mean the logical inferences described in the *Organon* and the *Novum organum*. He meant a new "speculative" method, dialectic, founded on an assumption which he had already learnt from Schelling, namely, that things which are different but similar can have the same attribute, and therefore be also the same. With this powerful instrument of dialectic in hand, he attempted to show how absolute reason differentiates itself into subjective and objective, ideal and real, and yet is the identity of both—an identity of opposites, as Schelling had said. By the same dialectic Hegel was able to justify the gradual transformation of transcendental into noumenal idealism by Fichte and Schelling. If things different but similar have the same attributes, and are thereby the same, then in the first place the Kantian categories, though thoughts of mental origin and therefore confined to mind, are nevertheless applicable

to things, because things, though different from, are the same as, thoughts, and have the categories of thoughts; in the second place, the Fichtian Ego of mankind is not the Absolute Reason of God, and yet is the same Absolute Reason; in the third place, the Schellingian Nature is the "other" of Spirit, and yet, being a mere reflex of the Idea of Nature, is identical with Spirit; and as this Spirit is everywhere the same in God and men, Nature is also identical with our Spirit, or rather with the Infinite Spirit, or Absolute Reason, which alone exists. The crux of all metaphysical idealism is the difficulty of reconciling the unity of the object with the plurality of subjects. Hegel's assumption of identity in difference at once enabled him to deal with the whole difficulty by holding that different subjects are yet one subject, and any one object, e.g. the sun, is at once different from, and identical with, the one subject which is also many. By the rough magic of this modern Prospero the universe of being is not, and yet is, thought, idea, spirit, reason, God. So elastic a solution established a dominant Hegelian school, which is now practically extinct, in Germany, and from Germany spread Hegelianism to France, England, America, and, in fact, diffused it over the civilized world to such an extent that it is still a widespread fashion outside Germany to believe that the world of being is a world of thought.

The plain answer is to contest the whole assumption. Different things, however similar, have only similar attributes, and therefore are never the same. God created man in His own image, and the world in the image of the Divine Idea; but I am not God, and the transitory sun is not the same as God's eternal idea of it. The creatures, however like, are not the same as the Creator and His thoughts. Each is a distinct thing, as Aristotle said. Reality is not Reason. It is strange that the underlying assumption of panlogism was not at once contested in this plain way. Nevertheless, objection was soon taken to the unsatisfactoriness of the system reared upon it. Schelling himself, as soon as he saw his own formulae exposed in the logic or rather dialectic of his disciple, began to reconsider his philosophy of identity, and brought some powerful objections against both the conclusions and the method of Hegel. Schelling perceived that Hegel, in reducing everything to infinite mind, absorbed man's free but finite personality in God, and, in declaring that everything real is rational, failed to explain evil and sin: indeed, the English reader of T. H. Green's *Prolegomena to Ethics* can see how awkward is the Hegelian reason for "an spiritual principle" to different men's individual freedom of choice between good and evil. Again, Schelling urged that besides the rational element there must be something else; that there is in nature, as *natura naturans*, a blind impulse, a will without intelligence, which belongs to the existent; and that even God Himself as the Absolute cannot be pure thought, because in order to think He must have an existence which cannot be merely His thought of it, and therefore pure being is the prior condition of thought and spirit. Hence Schelling objected to the Hegelian dialectic on the ground that, although reason by itself can apprehend notions or essences, and even that of God, it cannot deduce a priori the existence of God or of Nature, or for the apprehension of which experience is required. He now distinguished two philosophies: negative philosophy starting from notions, and positive philosophy starting from being; the former a philosophy of conditions, the latter of causes, i.e. of existence. Hegel, he said, had only supplied the logic of negative philosophy; and it must be confessed that the most which could be extracted from the Hegelian dialectic would be some connexion of thoughts without proving any existence of corresponding things. Schelling was right; but he had too much affinity with Hegelian assumptions, e.g. the panlogistic confusion of the essences of things with the notions of reason, to construct a positive philosophy without falling into fresh mysticism, which failed to exorcise the effect of his earlier philosophy of identity in the growing materialism of the age.

2. Meanwhile, by the side of panlogism arose the pantheism of Schopenhauer (1788-1860). This new noumenal idealism

began, like the preceding, by combining psychol-
Schopenhauer. logical idealism with the transcendentalism of Kant and Fichte. In *Die Welt als Wille und Vorstellung* Schopenhauer accepted Kant's position that the world as phenomenal is idea (*Vorstellung*), but he added that the world as noumenal is will (*Wille*). He got the hint of a noumenal will from Kant; but in regarding the noumenal as knowable, because mental, as well as in the emphasis he laid on the activity of will, he resembled Fichte. His theory of the nature of will was his own, and arrived at from a voluntaristic psychology leading to a voluntaristic metaphysics of his own. His psychological

starting-point was the unproved assumption that the only force of which we are immediately aware is will; his metaphysical goal was the consistent conclusion that in that case the only force we can know, as the noumenal essence of which all else is phenomenal appearance, is will. But by this noumenal will he did not mean a divine will similar to our rational desire, a will in which an inference and desire of a desirable end and means produces our rational action. He meant an unintelligent, unconscious, restless, endless will. In considering the force of instinct in animals he was obliged to divest will of reason. When he found himself confronted with the blind forces of Nature he was obliged to divest irrational will of feeling. As he resolved one force after another into lower and lower grades of will he was obliged to divest will of all consciousness. In short, his metaphysics was founded on a misnomer, and simply consisted in calling unconscious force by the name of unconscious will (*Unbewusste Wille*). This abuse of language brought him back to Leibnitz. But, whereas Leibnitz imputed unconscious perception as well as unconscious appetite to monads, Schopenhauer supposed unconscious will to arise without perception, without feeling, without ideas, and to be the cause of ideas only in us. Hence he rejected the infinite intelligence supposed by Fichte, Schelling and Hegel against whom he urged that blind will produces intelligence, and only becomes conscious in us by using intelligence as a means to ends. He also rejected the optimism of Leibnitz and Hegel, and placed the most irrational of wills at the base of the worst possible of worlds (see further SCHOPENHAUER). This pessimistic pantheism gradually won its way, and procured exponents such as J. Frauenstädt, J. Bahnsen, and, more recently, P. Deussen. The accident of its pessimism attracted F. W. Nietzsche, who afterwards, passing from the philosophy of will to the theory of evolution, ended by imagining that the struggle of the will to live produces the survival of the fittest, that is, the right of the strongest and the will to exercise power, which by means of selection may hereafter issue in a new species of superior man—the *Uebermensch*. Finally, Schopenhauer's voluntarism has had a profound effect on psychology inside and outside Germany, and to a less degree produced attempts to deduce from voluntaristic psychology new systems of voluntaristic metaphysics, such as those of Paulsen and Wundt.

3. The first to modify the pure voluntarism of Schopenhauer was E. von Hartmann, who (*Die Philosophie des Unbewussten*, 1869, 1st ed.), advanced the view that the world is *Hartmann.* as noumenal is both unconscious intelligence and unconscious will, thus founding a panpneumatism which forms a sort of reconciliation of the panlogism of Hegel and the pantheism of Schopenhauer. In his tract entitled *Schelling's positive Philosophie als Einheit von Hegel und Schopenhauer* (1866) he further showed that, in his later philosophy, Schelling had already combined reason and will in the Absolute. Indeed, Fichte had previously characterized the life of the Absolute by reason and will without consciousness; and, before Fichte, Leibnitz had asserted that the elements of Nature are monads with unconscious perception and appetite. Hartmann has an affinity with all these predecessors, and with Spinoza, with whom he agrees that there is but one substance unaltered by the plurality of individuals which are only its modifications. Following, however, in the footsteps of Schelling, he idealizes the one extended and thinking substance into one mental being; but he thinks that its essence consists in unconscious intelligence and will, of which all individual intelligent wills are only activities. The merit of this fresh noumenal idealism consists in its correction of the one-sidedness of Schopenhauer: intelligence is necessary to will. But Hartmann's criticism does not go far enough. He ends by outdoing the paradox of Schopenhauer, concluding that Nature in itself is intelligent will, but unconscious, a sort of immanent unconscious God.

As with his master, his reasons for this view are derived, not from a direct proof that unconscious Nature has the mental attributes supposed, but from human psychology, and epistemology. Like Leibnitz, he proceeds from the fact that our perceptions are

sometimes conscious, sometimes unconscious, to the inconsequent conclusion, that there are beings with nothing but unconscious perceptions; and by a similar *non sequitur*, because there is the idea of an end in will, he argues that there must be an unconscious idea of an end in instinctive, in reflex, in all action. Again, in his *Grundproblem der Erkenntnistheorie* (1889) he uses without proof the hypothesis of psychological idealism, that we perceive, psychically, to infer with merely hypothetical consistency the conclusion of noumenal metaphysical idealism that all we can thereby know is psychical causes, or something transcendent, beyond phenomena indeed, yet not beyond mind. But, according to him, this transcendent is the unconscious (*Kraftvolles unbewusstes ideales Geschehen*). He calls this epistemology "transcendent realism"; it is really "transcendent idealism." On these foundations he builds the details of his idealistic metaphysics. (a) He identifies matter with mind by identifying atomic force with the striving of unconscious will after objects connected by unconscious intelligence, and by defining causality as logical necessity receiving actuality through will. (b) He contends that, when matter ascends to the evolution of organic life, the unconscious has a power, over and above its atomic volitions, of introducing a new element, and that in consequence the facts of variation, selection and inheritance, pointed out by Darwin, are merely means which the unconscious uses for its own ends in morphological development. (c) He explains the rise of consciousness by suggesting that, while it requires a certain condition, it consists in the emancipation of intelligence from will at the moment when in sensation the individual mind finds itself with an idea without will. Here follows his pessimism, like to, but differing from, that of his master. In his view consciousness begins with want, and pain preponderates over pleasure in every individual life, with no hope for the future, while the final end is not consciousness, but the painlessness of the unconscious (see PESSIMISM). But why exaggerate? The truth of Nature is force; the truth of will is rational desire; the truth of life is neither the optimism of Leibnitz and Hegel, nor the pessimism of Schopenhauer and Hartmann, but the moderation of Aristotle. Life is sweet, and most men have more pleasures than pains in their lives.

4. Lotze (1817-1881) elaborated a very different noumenal idealism, which perhaps we may express by the name "Pan-teleologism," to express its conclusion that the known

world beyond phenomena is neither absolute thought nor unconscious will, nor the unconscious at all, but the activity of God; causing in us the system of phenomenal appearances, which we call Nature, or bodies moving in time and space; but being in itself the system of the universal reciprocal actions of God's infinite spirit, animated by the design of the supreme good. The *Metaphysik* of Lotze in its latest form (1879) begins with a great truth: metaphysics must be the foundation of psychology. He saw that the theories of the origin of knowledge in idealistic epistemology are unsound. Like Aristotle, then, he proposed anew the question, What is being? Nevertheless he was too much a child of his age to keep things known steadily before him; having asked the metaphysical question he proceeded to find a psychological answer in a theory of sensation, which asserted the mere hypothesis that the being which we ascribe to things on the evidence of sensation consists in their being felt. He really accepted, like Kant, the hypothesis of a sense of sensations which led to the Kantian conclusion that the Nature we know in time and space is mere sensible appearances in us. Further, from an early period in his *Medizinische Psychologie* (1852) he reinforced the transcendental idealism of Kant by a general hypothesis of "local signs," containing the subordinate hypotheses, that we cannot directly perceive extension either within ourselves or without; that spatial bodies outside could not cause in us spatial images either in sight or in touch; but that besides the obvious data of sense, e.g. pressure, heat and colour, there must be other qualitative different excitations of different nerve-fibres, by means of which, as non-local signs of localities, the soul constructs in itself an image of extended space containing different places. This hypothesis of an acquired perception of a space mentally constructed by "local signs" supplied Lotze and many succeeding idealists, including Wundt, with a new argument for metaphysical idealism. Lotze concluded that we have no more reason for supposing an external space like space constructed out of our perceptions, than we have for supposing an external colour like perceived colour. Agreeing, then, with Kant that primary qualities are as mental as secondary, he agreed also with Kant that all the Nature we know as a system of bodies moving in time and space is

sensible phenomena. But while he was in fundamental agreement with the first two positions of Kant, he differed from the third; he did not believe that the causes of sensible phenomena can be unknown things in themselves. What then are they? In answering this question Lotze regarded Leibnitz as his guide. He accepted the Leibnitzian fallacy that unity is indivisibility, which led to the Leibnitzian analysis of material bodies into immaterial monads, indivisible and therefore unextended, and to the theory of monadic souls and entelechies. Indeed, from the time of Leibnitz such attempts either to analyse or to construct matter had become a fashion. Lotze agreed with Leibnitz that the things which cause phenomena are immaterial elements, but added that they are not simple substances, self-acting, as Leibnitz thought, or preserving themselves against disturbance, as Herbart thought, but are interacting modifications of the one substance of God.

In the first place, he resolved the doubt of Leibnitz about bodies by deciding entirely against his realistic alternative that an organic body is a *substantia realisans phaenomena*, and for his idealistic alternative that every body is a phenomenon and not a substance at all. Secondly, he accepted the Leibnitzian hypothesis of immaterial elements without accepting their self-action. He believed in reciprocal action; and the very essence of his metaphysics consists in sublimating the interaction of bodies into the interaction of immaterial elements, which produce effects on one another and on the soul as one of them. According to the mechanics of Newton, when two bodies collide each body makes the other move equally and oppositely; but it has become a convenient habit to express this concrete fact in abstract language by calling it the conservation of momentum, by talking of one body communicating its motion to the other; as if bodies exchanged motion as men do money. Now Lotze took this abstract language literally, and had no difficulty in showing that, as an attribute is not separated from its substance, this supposed communication of motion does not really take place: nothing passes. But instead of a turning to the concrete fact of the equivalence of momentum, by which each body moving makes the other move oppositely, he denied that bodies do reciprocally act on one another, and even that bodies as mutually resisting substances press one another apart in collision. Having thus rejected all bodily mechanism, he had to suppose that reciprocal action somehow takes place between immaterial elements. This brought him to another difference from Leibnitz as well as from Aristotle. According to Leibnitz, while each immaterial element is a monadic substance and self-acting secondary cause, God is the primary cause of all. According to Lotze, the connexion required by reciprocity requires also that the whole of every reciprocal action should take place within one substance; the immaterial elements act on one another merely as the modifications of that substance interacting within itself; and that one substance is God, who thus becomes not merely the primary but the sole cause, in scholastic language a *causa immensumens*, of agent of acts remaining within the agent's being. At this point, having rejected both the Newtonian mechanism of bodily substances and the Leibnitzian automatism of monadic substances, he flew to the Spinozistic unity of substance; except that, according to him, the one substance, God, is not extended at all, and is not merely thinking, but is a thinking, willing and acting spirit.

Lotze's metaphysics is thus distinguished from the theism of Newton and Leibnitz by its pantheism, and from the pantheism of Spinoza by its idealism. It is an idealistic pantheism, which is a denial of all bodily mechanism, a reduction of everything bodily to phenomena, and an assertion that all real action is the activity of God. At the same time it is a curious attempt to restore mechanism and reconcile it with teleology by using the word "mechanism" in a new meaning, according to which God performs His own reciprocal actions within Himself by uniform laws, which are also means to divine ends. It is also an attempt to reconcile this divine mechanism with freedom. In his *Metaphysik* (1879), as in his earlier *Mikrokosmos* (1856-1864), Lotze vindicated the contingency of freedom by assigning to God a miraculous power of unconditional commencement, whereby not only at the very beginning but in the course of nature there may be new beginnings, which are not effects of previous causes, though once started they produce effects according to law. Thus his pantheistic is also a teleological idealism, which in its emphasis on free activity and moral order recalls Leibnitz and Fichte, but in its emphasis on the infinity of God has more affinity to Spinoza, Schelling and Hegel. Hence his philosophy, like the Hegelian, continually tortments one with the difficulty that its sacrifice of the distinct being of

all individual substances to the universality of God entails the sacrifice of the individual personality of men. Our bodies were reduced by Lotze to the general ruck of phenomenal appearances. Our souls he tried his best to endow with a quasi-existence, arguing that the unity of consciousness requires an indivisible subject, which is distinct from the plurality of the body but interacting with it, is in a way a centre of independent activities, and is so far a substance, or rather able to produce the appearance of a substance. But at the end of his *Metaphysik*, from the conclusion that everything beyond phenomena is divine interaction, he drew the consistent corollary that individual souls are simply actions of the one genuine being. His final view was that certain actions of the divine substance are during consciousness gifted with knowledge of themselves as active centres, but during unconsciousness are non-existent. If so, we are not persons with a permanent being of our own distinct from that of God. But in a philosophy which reduces everything to phenomenal appearance except the self-interacting substance of God, there is no room for either the bodies or the souls of finite substances or human persons.

5. Fechner (1801-1887) affords a conspicuous instance of the idealistic tendency to mysticize nature in his Panpsychism, or that form of noumenal idealism which holds that the universe is a vast communion of spirits, souls of men, of animals, of plants, of earth and other planets, of the sun, all embraced as different members in the soul of the world, the highest spirit—God, in whom we live and move and have our being; that the bodily and the spiritual, or the physical and the psychical, are everywhere parallel processes which never meet to interact; but that the difference between them is only a difference between the outer and inner aspects of one identical psychophysical process; and yet that both sides are not equally real, because while psychical and physical are identical, the psychical is what a thing really is as seen from within, the physical is what it appears to be to a spectator outside; or spirit is the self-appearance of matter, matter the appearance of one spirit to another. Fechner's panpsychism has a certain affinity both to Stahl's animism and to the hylozoism of materialists such as Haeckel. But, while it differs from both in denying the reality of body, it differs from the former in extending conscious soul not only to plants, as Stahl did, but to all Nature; and it differs from the latter in the different consequences drawn by materialism and idealism from this universal animism. According to Haeckel, matter is the universal substance, spirit its universal attribute. According to Fechner, spirit is the universal reality, matter the universal appearance of spirit to spirit; and they are identical because spirit is the reality which appears. Hence Fechner describes himself as a twig fallen from Schelling's stem. Schelling's adherent Oken by his *Lehrbuch der Naturphilosophie* conveyed to his mind the life-long impression that God is the universe and Nature God's appearance. At the same time, while accepting the Schellingian parallelistic identity of all things in God, Fechner was restrained by his accurate knowledge of physics from the extravagant construction of Nature, which had failed in the hands of Schelling and Hegel. Besides, he was deeply impressed by the fact of man's personality and by the problem of his personal immortality, which brought him back through Schelling to Leibnitz, whose *Momologie* throughout maintains the plurality of monadic souls and the omnipresence of perception, sketches in a few sections (§§ 23, 78-81) a panpsychic parallelism, though without identity, between bodily motions and psychic perceptions, and, what is most remarkable, already uses the conservation of energy to argue that physical energy pursues its course in bodies without interacting with souls, and that motions produce motions, perceptions produce perceptions. Leibnitz thus influenced Fechner, as in other ways he influenced Lotze. Both, however, used this influence freely; and, whereas Lotze used the Leibnitzian argument from indivisibility to deduce indivisible elements and souls, Fechner used the Leibnitzian hypotheses of universal perception and parallelism of motions and perceptions, in the light of the Schellingian identification of physical and psychical, to evolve

a world-view (*Weltanschauung*) containing something which was neither Leibnitz nor Schelling.

Fechner's first point was his panpsychism. Emphasizing the many real analogies between physical and mental agency, but underlining the much stronger evidences that all the mental operations of men and animals require a nervous system, he flew to the paradox that soul is not limited to men and animals, but extends Panpsychism. to plants, to the earth and other planets, to the sun, to the world itself, of which, according to him, God is the world-soul. In this doctrine of universal animation he was like Leibnitz, yet very different. Whereas Leibnitz confined a large area of the world to wholly unconscious perceptions, and therefore preferred to call the souls of inorganic beings "Entelechies," Fechner extended consciousness to the whole world, and accordingly, whereas Leibnitz believed in a supramundane Creator, "au dessus du Monde" and "dans le Monde," Fechner, in the spirit of Schelling, identified God with the soul of the world. Fechner's second point was that, throughout the animated universe, physical processes accompany psychical processes without interaction. In this panpsychic parallelism he was again like Leibnitz, and he developed his predecessor's view, that the conservation of energy prevents interaction, into the supposition that alongside the physical there is a parallel psychical conservation of energy. Here, again, he went much further than Leibnitz, but along with Schelling, in identifying the physical and the psychical as one and the same process, in which the inner is the real and the outer the apparent. Fechner's third point carried him beyond all his predecessors, containing as it does the true originality of his "world-view." He advanced the ingenious suggestion that, as body is in body and all ultimately in the world-body, so soul is in soul and all ultimately in the world-soul. By this means he explained immortality and vindicated personality. His fourth point was connected with this inclusion of personal spirits in higher spirits and in the highest. It is his so-called "synchological view" of the soul. Herbert and Lotze, both deeply affected by the Leibnitzian hypothesis of indivisible monads, suppose that man's soul is seated at a central point in the brain; and Lotze supposed that this supposition is necessary to explain the unity of consciousness. Fechner's supposition was that the unity of consciousness belongs to the unity of the whole body; that the seat of the soul is the living body; that the soul changes its place as in different parts a process rises above the "threshold of consciousness"; and that soul is not substance but the single psychical life which has its physical manifestation in the single bodily life. Applying this "synchological view" to the supposed inclusion of soul in soul, he deduced the conclusion that, as here the nature of one's soul is, so the one's little body, so heretofore it will be, but in a greater body, so that the whole spirit unites the whole world by his omnipresence; and he pertinently asked, in opposition to the "punctual" view, whether God's soul is centred in a point. Lastly, the whole of this "world-view" was developed by Fechner in early life, under the influence of his religious training, and out of a pious desire to understand those main truths of Christianity which teach us that we are children of God, that this natural body will become a spiritual body, and that, though we are different individual members, we live and move and are in God: "In Deo vivimus, movemur, et sumus." It is important to notice that Fechner named this "world-view" in a little book, *Das Büchlein vom Leben nach dem Tode*, which he originally published in 1836 under the pseudonym of Dr Mises, but which he afterwards republished in his own name in 1866, and again in 1887, as a sketch of his *Weltanschauung*. Afterwards in *Nanna* (1848) he discussed the supposed souls of plants, and in *Zendaesta* (1851) the supposed souls of the earth and the rest of the world. Then in 1855 he published his *Atomlehre*, partly founded on his physics, but mainly on his metaphysics. Under the influence of Leibnitz, Bosovich, Kant and Herbart, he supposed that bodies are divisible into punctual atoms, which are not bodies, but centres of forces of attraction and repulsion; that impenetrability is a result of repulsive force; and that force itself is only law—taking as an instance that Newtonian force of attraction whose process we do not understand, and neglecting that Newtonian force of pressure and impact whose process we do understand from the collision of bodies already extended and resisting. But, in thus adapting to his own purposes the Leibnitzian analysis of material into immaterial, he drew his own conclusions according to his own metaphysics, which required that the supposed centres of force are not Leibnitzian "monads," nor Herbartian "reals," nor divine modifications such as Lotze afterwards supposed, but are elements of a system which in outer aspect is bodily and in inner aspect is spiritual, and obeying laws of spirit. At the same time his synchological view prevented him from saying that every atom has a soul, because according to him a soul always corresponds to a unity of a physical manifold. Thus his metaphysics is Leibnitzian, like that of Lotze, and yet is opposed to the most characteristic feature of monadology—the percipient indivisible monad.

In 1860 appeared Fechner's *Elemente der Psychophysik*, a work which deeply affected subsequent psychology, and almost revolutionized metaphysics of body and soul, and of physical and psychical relations generally. It becomes necessary, therefore, to determine

how far Fechner derived his psychophysics from experience, how far from fallacies of inference, from his romantic imagination and from his theosophic metaphysics, which indeed coloured his whole book on psychophysics. At the very outset he started with his previous metaphysical hypothesis of parallelistic identity without interaction. There is no complete right and left side of the circle, but the concave and convex sides of a circle, as inner and outer sides of the same process, which is psychical as viewed from within and physical as viewed from without. He also maintained throughout the book that physical and psychical energy do not interfere, but that the psychical is, like a mathematical quantity, a function of the physical, depending upon it, and vice versa, only in the sense that a constant relation according to law exists, such that we may conclude from one to the other, but not vice versa; he further maintained that the laws of psychophysics he meant the exact doctrine of the relations of dependency between physical and psychical. The name was new, but not the doctrine. From antiquity men had applied themselves to determine the relations between the physical stimuli and the so-called "quality" of sensations. But what was new was the application of this doctrine to the relations between the stimuli and the so-called "intensity" of sensations. He generalized Weber's law ($g \cdot x$) in the form that sensation generally increases in intensity as the stimulus increases by a constant fraction of the previous stimulus; or increases in an arithmetical progression as the stimulus increases in a geometrical ratio; or increases by addition of the same amount as the stimulus increases by the same multiple; or increases as the logarithm of the stimulus. There are then, at least within the limits of moderate sensations, concomitant variations between stimuli and sensations, not only in "quality," as in the intervals of sounds, which were understood long ago, but also in "intensity," and the latter of the latter is the substance of Weber's and Fechner's law. By the rules of induction from concomitant variations, we are logically bound to infer the realistic conclusion that outer physical stimuli cause inner sensations of sensible effects. But, unfortunately for Fechner, the very opposite conclusion followed from the presuppositions of his parallelistic metaphysics, and from the Leibnitzian view of the conservation of energy, which he was the first in our time to use in order to argue that a physical cause cannot produce a psychical effect, on the ground that physical energy must be exactly replaced by physical energy.

Having satisfied himself in what he called "outer psychophysics," that the stimulus causes only the nervous process and not sensation, he passed to what he called "inner psychophysics," or the theory of the relation between nervous and psychical processes. He rightly argued against the old theory that the continuity of nervous processes in the brain is interrupted by mental processes of thought and will: there is a nervous process for every mental process. But two questions arise. What is the relation between the nervous process and sensation? What causes sensation? The first question he answered from his imagination by supposing that, while the external world is stimulus of the nervous process, the nervous process is the immediate stimulus of the sensation, and that the sensation increases by a constant fraction of the previous stimulus in the nervous system, when Weber's law proves only that it increases by a constant fraction of the previous stimulus in the external world. The second question he answered from his parallelistic metaphysics by deducing that even within the organism there is only a constant dependency of sensation on nervous process without causation, because the nervous process is physical but the sensation psychical. This answer supposed that the whole physical process from the action of the external stimulus on the nervous system to the reaction of the organism on the external world is one series, while the conscious process beginning with sensation is only parallel and as it were left behind and dry. What then is the cause of the sensation of Huxley, it will be remembered, in similar circumstances, when he answered this question by degrading consciousness to an epiphenomenon, or by-product of the physical process. Fechner was saved from this absurdity, but only to fall into the greater absurdity of his own pansychism. Having long assumed that the whole world is animated throughout, and that there are always two parallel series, physical and psychical, he concluded that, while a physical stimulus is causing a physical nervous process, a psychical accompaniment of the stimulus is using, but not causing, a psychical sensation. This is the psychical accompaniment of the nervous process; and that, as the whole physical and the whole psychical series are the same, differing only as outer and inner, this identity holds both of stimulus and its psychical accompaniment and of nervous process and its accompanying sensation. Accordingly, he calls these and all other processes "psychophysical"; and as he recognized two parallel energies, physical and psychical, differing only as outer and inner accompaniments of the same energy, he called this "psychophysical energy." In such a philosophy all reality is "psychophysical." At the same time Fechner would not have us suppose that the two sides are equal; according to him, the psychical, being the psychophysical as viewed from within, is real, the physical, being the psychophysical viewed from without, is apparent; so in oneself, though nervous process and psychical process are the same, it is the psychical which is the reality of which the nervous is mere appearance; and so every further spirit is the reality, body the appearance of spirit to spirit. Where, he

supposed that one spirit is in another, and all in the highest spirit, God. By this means also he explained unconsciousness. In point of fact, many stimuli are beneath the "threshold" of a man's consciousness. Leibnitz, in the *Nouveaux Essais*, ii. 11, had also said that we have many "petites perceptions," of which we are unconscious, and had further suggested that a perception of which we are not conscious, is composed of a quantity of "petites perceptions," of which we are not, conscious. Proceeding on this suggestion, and misled by the mathematical expression which he had given to Weber's law, Fechner held that a conscious sensation, like its stimulus, consists of units, or elements, by summation and increments of which conscious sensations and their differences are produced; so that consciousness, according to this unnecessary assumption, emerges from an integration of unconscious shocks or tremors. But by the hypothesis of the inclusion of unconscious sensations, he further endeavored to hold that what is unconscious in one spirit is conscious in a higher spirit, while everything whatever is in the consciousness of the highest spirit of God, who is the whole of reality of which the spirits are parts, while the so-called physical world is merely outer appearance of one spirit to another.

Fechner first confused physics and metaphysics in psychophysics, and next proceeded to confuse them again in his work on evolution (*Lein's Ideen der Schöpfung und der Evolution der Organismen*, 1873). He perceived that Darwinism attributed too much to accident, and was also powerless to explain the origin of life and of consciousness. But his substitute was his own hypothesis of pansychism, from which he deduced a "cosmorganic" evolution from a "cosmorganic" or original condition of the world as a living organism into the inorganic, by the principle of tendency to stability. The world, as he thought, on its physical side, always was a living body, and on its psychical side God always was a conscious spirit; and, so far from life arising from the lifeless, and consciousness from unconsciousness, the life and consciousness of the whole world are the origin of the lifeless and the unconscious in parts of it, by a kind of secondary automatism, while we ourselves are developed from our own mother-earth by differentiation. By thus supposing a psychical basis to evolution, Fechner, anticipating Wundt, substituted a psychical development of organs for Darwinian accidental variation. The difficulty of such speculations is to prove that things apparently dead and mindless are living souls. Their interest to the metaphysician is their opposition to physics on the one hand and to theism on the other. Shall we resign our traditional belief that the greater part of the world is mere body, but that its general adaptability to conscious organisms proves its creation and government by God, and take to the new hypothesis, which, by a transfer of design from God to Nature, supposes that everything physical is alive, and conducts the physical impulses to its own? Fechner himself went even further, and together with design transferred God Himself to Nature. This is the subject of his last metaphysical work, *Die Tagesansicht gegenüber der Nachtansicht* (1879). The "day-view" (Fechner's) is the view that God is the psychophysical all-embracing being, the law and consciousness of the world. It resembles the views of Hegel and Lotze in its pantheistic tendency. But it does not, like theirs, sacrifice our personality; because, according to Fechner, the one divine consciousness includes us as a larger circle includes smaller circles. By this ingenious suggestion of the membership of one spirit in another, Fechner's "day-view" also puts Nature in a different position; neither with Hegel sublimating it to the thought of God's mind, nor with Lotze degrading it to the phenomena of our human minds, but identifying it with the outer appearance of one spirit to another spirit in the highest of spirits.

We may dwell on this curious metaphysics of Fechner because it contains the master-key to the philosophy of the present moment. When the later reaction to Kant arose against both Hegelianism and materialism, the nearly contemporary appearance of Fechner's *Psychophysics* began to attract experimental psychologists by its real as well as its apparent exactness, and both psychologists and metaphysicians by its novel way of putting the relations between the physical and the psychical in man and in the world. Fechner saw psychology deriving advantage from the methods, as well as the results, of his experiments, and in 1879 the first psychological laboratory was erected by Wundt at Leipzig. But he had also to endure countless objections to his mathematical statement of Weber's law, to his unnecessary assumption of units of sensation, and to his unjustifiable transfer of the law from physical to physiological stimuli of sensations, involving in his opinion his parallelistic view of body and mind. Among psychologists Helmholtz, Mach, Brentano, Hering, Delboeuf, were all more or less against him. Sigwart in his *Logic* has also opposed the parallelistic view itself; and James has criticized it from the point of view that the soul selects out of the possibilities of the brain means to its own ends. Nevertheless, largely under the influence of the exaggeration

of the conservation of energy, many psychologists—Wundt, Paulsen, Richl, Jodl, Ebbinghaus, Münsterberg, and in England Lewes, Clifford, Romanes, Stout—have accepted Fechner's psychophysical parallelism, as far at least as men and animals are concerned. Most stop here, but some go with Fechner to the full length of his metaphysical parallelism of the physical and psychical, as psychophysical, throughout the whole world. This influence extended from Germany to Denmark, where it was embraced by Höfding, and to England, where it was accepted by Romanes, and in a more qualified manner as "a working hypothesis" by Stout. But the most thorough and most eloquent of Fechner's metaphysical disciples was F. Paulsen (*q.v.*), who spread panpsychism far and wide in his *Einleitung in die Philosophie*.

Here reappear all the characteristic points of Fechner's "world-view"—the panpsychism, the universal parallelism with the identification of physical and psychical, the inclusion of spirit in spirit, the synecdochical view of spirit, and the final "day-view" that all reality is spirit, and body the appearance of spirit to spirit. But Paulsen tries to supply something wanting in Fechner. The originality of Paulsen consists in trying to supply an epistemological explanation of the metaphysics of Fechner, by reconciling him with Kant and Schopenhauer. He borrows from Kant's "rationalism" the hypothesis of a spontaneous activity of the subject with the deduction that knowledge begins from sense, but arises from understanding; and he accepts from Kant's metaphysical idealism the consequence that everything we perceive, experience and know about physical nature, and the bodies of which it consists, is phenomena, and not bodily things in themselves. But he has a different theory of human nature and soul, and so does not accept the Kantian conclusion that things in themselves, in the sense of things beyond phenomena, are all unknowable. On the contrary, his contention is that of Fechner—that all knowable things are inner psychical realities beneath outer physical appearances—the invisible symbolized by the visible. Kant, however, had no epistemology for such a contention, because according to him both outer and inner senses give mere appearance, from which we could not know either body in itself, or soul in itself. Parting, then, from Kant, Paulsen resorts to a paradox which he shares with Fechner and Wundt. He admits, indeed, Kant's hypothesis that by inner sense we are conscious only of mental states, but he contends that this very consciousness is a knowledge of a thing in itself. He agrees with Fechner and Wundt that there is no substantial soul, and that soul is nothing but the mental states, or rather their unity—thus identifying it with Kant's synthetic unity. On this assumption he deduces that in being conscious of our mental states we are conscious of soul not merely as it appears, but as it is in itself, and therefore can infer similar souls, other psychical unities, which are also things in themselves.

But what is the essence of this psychical reality which we thus immediately and mediately know? Here he appeals to Schopenhauer's doctrine that will of some sort is the fundamental fact of mental life. Taking, then, will to be the essential thing in itself of which we are conscious, he deduces that we can infer that the psychical things in themselves beyond ourselves are also essentially "wills." Combining with this the central dogma of Fechner that spirit extends throughout the world of bodily appearance, he concludes that the realities of the world are "wills," that bodies are mere appearances of "wills," and that there is one universal and all-embracing spirit which is "will." His ultimate metaphysics, then, is this: "Everything is spirit, and spirit is will." Will, as such, by "will" he does not mean the rational desire, which is its proper meaning, but inapplicable to Nature; nor unconscious irrational will, which is Schopenhauer's forced meaning; nor unconscious intelligent will, which is Hartmann's more correct meaning, though inapplicable to Nature. His "will" is instinct, impulsive feeling, a "will to live," not indeed unconscious, but often subconscious, without idea, without reasoning about ends and means, yet pursuing ends—in short, what he calls, after K. E. von Baer, *Zielstrebigkeit*. How persistent is ancient animism! Empedocles, Plato and Aristotle; Teleso, Bruno and Campanella; Leibnitz; the idealist Schopenhauer and Hartmann, Fechner and Paulsen; and the materialist Haecel—all have agreed in according some sort of appetition to Nature. So prone are men to exaggerate adaptation into aim! So prone are they to transfer to Nature the part played by the providence of God! (see Bacon, *De augmentis*, iii. 4, *sub fin.*).

Noumenal idealism is not dead in Germany. It died down for a time in the decline of Hegelianism and the rise of materialism. It has since revived. The pure idealism of Fichte is at the bottom of it all. The panlogism of Schelling and Hegel survives in its influence. So still more does the pantheism of Schopenhauer. The three most vital idealisms of this kind at the moment are the panpneumatism of Hartmann, combining Hegel with

Schopenhauer; the panteologism of Lotze, reviving Leibnitz; and the panpsychism of Paulsen, continuing Fechner, but with the addition of an epistemology combining Kant with Schopenhauer. All these systems of metaphysics, differ as they may, agree that things are known to exist beyond sensible phenomena, but yet are mental realities of some kind. Meanwhile, the natural substances of Aristotelian realism are regarded with common aversion.

5.—PHENOMENAL IDEALISM IN GERMANY

Phenomenal idealism is the metaphysics which deduces that, as we begin by perceiving nothing but mental phenomena of sense, so all we know at last from these data is also phenomena of sense, actual or possible. So far it is in general agreement not only with Hume, but also with Kant in his first two positions. But it follows Fichte in his revolt against the unknown thing in itself. On the other hand, as the speculative systems of noumenal idealism, starting from Fichte, succeeded one another, like ghosts who "come like shadows, so depart," without producing conviction, and often in flagrant opposition to the truths of natural science, and when, in consequence, a wave of materialism threatened to submerge mind altogether by reducing it to a function of matter, many philosophers began to despair of the ambitious attempts which had been made to prove that there is a whole world of mind beyond phenomena, as the noumenalists had supposed. Thus they were thrown back on the limits of human knowledge prescribed by Kant, but purged of the unknown thing in itself by Fichte. Phenomenal idealism is the Kantian contention that Nature, as known to science, is phenomena of experience. Unfortunately, the word "phenomenon" is equivocal (see *Mind*, xv. 309). Sometimes it is used for any positive fact, as distinguished from its cause. But sometimes also it means what appears, or can appear, to the senses, as distinguished from what does not appear, but can be inferred to exist. Now, Kant and his followers start from this second and narrower meaning, and usually narrow it still more by assuming that what appears to the senses is as mental as the sensation, being undistinguishable from it or from the idea of it, and that an appearance is a mental idea (*Vorstellung*) of sense; and then they conclude that we can know by inference nothing but such mental appearances, actual and possible, and therefore nothing beyond sensory experience. When, on the other hand, the objects of science are properly described as phenomena, what is meant is not this pittance of sensible appearances, but positive facts of all kinds, whether perceptible or imperceptible, whether capable of being experienced or of being inferred from, but beyond, experience, e.g. the farther side of the moon, which is known to exist only by inference. Hence the doctrine of Kant, that Nature as known to science is phenomena, means one thing in Kantism and another thing in science. In the former it means that Nature is mental phenomena, actual and possible, of sensory experience; in the latter it means that Nature is positive facts, either experienced or inferred. It is most important also to notice that Kantism denies, but science asserts, the logical power of reason to infer actual things beyond experience. But the phenomenal idealists have not, any more than Kant, noticed the ambiguity of the term "phenomenon"; they fancy that, in saying that all we know is phenomena in the Kantian sense of mental appearances, they are describing all the positive facts that science knows; and they follow Kant in supposing that there is no logical inference of actual things beyond experience.

1. *The Reaction to Kant.*—The reaction to Kant ("Zurück zu Kant") was begun by O. Liebmann in *Kant und die Epigonen* (1865). Immediately afterwards, in 1866, appeared Lange's *Geschichte des Materialismus*. In 1870 J. B. Meyer published his *Kants Psychologie*, and in 1871 H. Cohen his more important *Kants Theorie der Erfahrung*, which led Lange to modify his interpretation of Kant in the second edition of his own book, *Lange (q.v.)* by his *History of Materialism* has exercised a profound influence, which is due partly to its apparent success in answering materialism by Kantian arguments, and partly to

its ingenious attempt to give to Kantism itself a consistency, which, however, has only succeeded in producing a new philosophy of Neo-Kantism, differing from Kantism in modifying the a priori and rejecting the thing in itself. Lange to some extent modified the transcendentalism of Kant's theory of the origin of knowledge. A priori forms, according to Kant, are contributions of the mental powers of sense, understanding, and reason; but, according to Lange, they are rooted in "the physico-psychical organization." This modification was the beginning of a gradual lessening of the antithesis of a priori to a posteriori, until at last the a priori forms of Kant have been transmuted into "auxiliary conceptions," or "postulates of experience." But this modification made no difference to the Kantian and Neo-Kantian deduction from the epistemological to the metaphysical. Lange entirely agreed with Kant that a priori forms can have no validity beyond experience when he says: "Kant is at any rate so far justified as the principle of intuition in space and time a priori is in us, and it was a service to all time that he should in this first great example, show that what we possess a priori, just because it arises out of the disposition of our mind, beyond our experience has no longer any claim to validity" (*Hist. of Materialism*, trans. E. C. Thomas, ii. 203). Hence he deduced that whatever we know from sensations arranged in such a priori forms are objects of our own experience and mental phenomena. Hence also his answer to materialism. Science, says the materialist, proves that all known things are material phenomena. Yes, rejoins Lange, but Kant has proved that material are merely mental phenomena; so that the more the materialist proves his case the more surely he is playing into the hands of the idealist—an answer which would be complete if it did not turn on the equivocation of the word "phenomenon," which in science means any positive fact, and not a mere appearance, much less a mental appearance, to sense and sensory experience. Having, however, made a deduction, which is at all events consistent, that on Kantian assumptions all we know is mental phenomena, Lange proceeded to reduce the rest of Kantism to consistency. But his ardent love of consistency led him far away from Kant in the end; for he proceeded consistently from the assumption, that whatever we think beyond mental phenomena is ideal, to the logical conclusion that in practical matters our moral responsibility cannot prove the reality of a noumenal freedom, because, as on Kant's assumption we know ourselves from inner sense only as phenomena, we can prove only our phenomenal freedom. Lange thus transmuted inconsistent Kantism into a consistent Neo-Kantism, consisting of these reformed positions: (1) we start with sensations in a priori forms; (2) all things known from these data are mental phenomena of experience; (3) everything beyond is idea, without any corresponding reality being knowable. "The intelligible world," he concluded, "is a world of poetry." Our reflection is that there is a great difference between the essence and the consistency of Kant's philosophy. Its essence, as stated by Kant, was to reduce the logical use of reason to mental phenomena of experience in speculation, in order to extend the practical use of reason to the real noumena, or things in themselves, required for morality. Its consistency, as deduced by Lange, was to reduce all use of reason, speculative and practical, to its logical use of proceeding from the assumed mental data of outer and inner sense, arranged a priori, to mental phenomena of experience, beyond which we can conceive ideas but postulate nothing. As H. Vaihinger, himself a profound Kantian of the new school, says: "Critical scepticism is the proper result of the Kantian theory of knowledge."

There is only one Neo-Kantian way out of this dilemma, but it is to alter the original assumptions of Kant's psychological idealism. This is the alternative of A. Riehl, who in *Der psychologische Kriticismus* (1876, &c.) proposes the non-Kantian hypothesis that, though things in themselves are unknowable through reason alone, they are knowable by empirical intuition, and therefore also by empirical thought starting from intuition. Like all true followers of Kant, Riehl prefers epistemology to metaphysics; yet in reality he founds a metaphysics on epistemology, which he calls "critical realism," so far as it asserts a knowledge of things

beyond phenomena, and "critical monism," so far as it holds that these things are unlike both physical and psychical phenomena, but are nevertheless the common basis of both. He accepts the Kantian positions that unity of consciousness combines sensations by a priori synthesis, and that therefore all that natural science knows about matter moving in space is merely phenomena of outer sense; and he agrees with Kant that from these data we could not infer things in themselves by reason. But his point is that the very sensation of phenomena or appearances implies the things which appear. "Sensory knowledge," he says, "is the knowledge of the relations of things through the relations of the sensations of things." Further, holding that, "like every other perception, the perception of a human body immediately involves the existence of that body," and, like Fichte, believing in a "common consciousness," he concludes that the evidence of sense is verified by "common consciousness" of the external world as objective in the Kantian sense of universally valid. He interprets the external world to be the common basis of physical and psychical phenomena. He rightly relies on the numerous passages, neglected by Lange, in which Kant regards things in themselves as neither phenomena nor ideas, but things existing beyond both. But his main reliance is on the passage in the *Kritik*, where Kant, speaking of the Cartesian difficulty of communication between body and soul, suggests that, however body and soul appear to be different in the phenomena of outer and inner sense, what lies as thing in itself at the basis of the phenomena of both may perhaps be not so heterogeneous (*ungleichartig*) after all. Riehl elaborates this bare suggestion into the metaphysical theory that the single basis of physical and psychical phenomena is neither bodily nor mental, nor yet space and motion. In order to establish this paradox of "critical monism," he accepts to a certain extent the psychophysical philosophy of Fechner. He agrees with Fechner that physical process of nerve and psychical process of mind are really the same psychophysical process as appearing on the one hand to an observer and on the other hand to one's own consciousness; and that physical phenomena only produce physical phenomena, so that those materialists and realists are wrong who say that physical stimuli produce sensations. But whereas Fechner and Paulsen hold that all physical processes are universally accompanied by psychical processes which are the real causes of psychical sensations, Riehl rejects this paradox of universal parallelism in order to fall into the equally paradoxical hypothesis that something or other, which is neither physical nor psychical, causes both the physical phenomena of matter moving in space and the psychical phenomena of mind to arise in us as its common effects. In supposing a direct perception of such a nondescript thing, he shows to what straits idealists are driven in the endeavour to supplement Kant's limitation of knowledge to phenomena by some sort of knowledge of things.

2. *The Reaction to Hume.*—When the Neo-Kantians, led by Lange, had modified Kant's hypothesis of a priori forms, and retracted Kant's admission and postulation of things in themselves beyond phenomena and ideas, and that too without proceeding further in the direction of Fichte and the noumenal idealists, there was not enough left of Kant to distinguish him essentially from Hume. For what does it matter to metaphysics whether by association sensations suggest ideas, and so give rise to ideas of substance and causation a posteriori, or synthetic unity of consciousness combines sensations by a priori notions of substance and causation into objects which are merely mental phenomena of experience, when it is at once allowed by the followers of Hume and Kant alike that reason in any logical use has no power of inferring things beyond the experience of the reasoner? In either case, the effective power of inference, which makes us rational beings, is gone. Naturally then the reaction to Kant was followed by a second reaction to Hume, partly under the name of "Positivism," which has attracted a number of adherents, such as C. Goring (1841-1879), author of an incomplete *System der Kritischen Philosophie* (1874-1875) and E. Laas (*q.v.*), and partly under the name of the "physical phenomenology" of E. Mach.

Ernst Mach (*q.v.*) is a conspicuous instance of a confusion of physics and psychology ending in a scepticism like that of Hume. He tells us how from his youth he pursued physical and psychological studies, how at the age of fifteen he read Kant's *Prolegomena*, and later rejected the thing in itself, and came to the conclusion that the world with his ego is one mass of sensations. For a time, under the influence of Fechner's *Psychophysics*, he thought that Nature has two sides, a physical and a psychological, and added that all atoms have feeling. But in the progress of his physical work, which taught him, as he thought, to distinguish between what we see and what we

mentally supply, he soon passed from this noumenalism to a "universal physical phenomenology." It retains some relics of Fechner's influence; first, the theory of identity, according to which the difference between the physical and psychical is not a dualism, but everything is at once both; and secondly, the substitution of mathematical dependence for physical causality, except that, whereas Fechner only denied causality between physical and psychical, Mach rejects the entire distinction between causality and dependence. on the ground that "the law of causality simply asserts that the phenomena of Nature are dependent on one another." He comes near to Hume's substitution of succession of phenomena for real causality. He holds, like Hume, that nothing is real except our sensations and complexes of sensory elements; that the ego is not a definite, unalterable, sharply bounded unity, but its continuity alone is important; and that we know no real causes at all, much less real causes of our sensations; or, as he expresses it, bodies do not produce sensations, but complexes of sensations form bodies. If he has any originality, it consists in substituting for the association of ideas the "economy of thinking," by which he means that all theoretical conceptions of physics, such as atoms, molecules, energy, &c., are mere helps to facilitate our consideration of things. But he limits this power of mind beyond sensations to mere ideas, and like Hume, and also like Lange, holds at last that, though we may form ideas beyond sensations or phenomena, we cannot know things. If we ask how Mach arrived at this scepticism, which is contained in his well-known scientific work *Die Mechanik in ihrer Entwicklung* (1883; ed. 1908) as well as in his psychological work on the Analysis of Sensations (*Beiträge zur Analyse der Empfindungen*, 1886), we find two main causes, both psychological and epistemological; namely, his views on sense and on inference. In the first place, he displays in its most naked form the common but unproved idealistic paradox of a sense of sensations, according to which touch apprehends not pressure but a sensation of pressure, sight apprehends not colour but a sensation of colour, and there is no difference between the sensory operation and the sensible object apprehended by any sense, even within the sentient organism. Hence, according to him, sensations are not apprehensions of sensible objects (e.g. pressures felt) from which we infer similar objects beyond sense (e.g. similar pressures of outside things), but are the actual elements out of which everything known is made; as if sensations were like chemical elements. Within the limits of these supposed sensory elements he accords more than many psychologists do to sense; because, following the naturalists, Johannes Müller and Hering, he includes sensations of time and space, which, however, are not to be regarded as "pure intuitions" in the style of Kant. But here again he identifies time and space with the sensations of them (*Zeitempfindungen und Raumempfindungen*). On the assumption, then, that time and space are not objects, but systems, of sensations, he concludes that a body in time and space is "a relatively constant sum of touch-and-light-sensations, joined to the same time-and-space-sensations," that each man's own body is included in his sensations, and that to explain sensations by motions would only be to explain one set of sensations from another. In short, sensations are elements and bodies complexes of these elements. Secondly, his theory of inference contains the admission that we infer beyond sensations: he remarks that the space of the geometer is beyond space-sensations, and the time of the physicist does not coincide with time-sensations, because it uses measurements such as the rotation of the earth and the vibrations of the pendulum. But by inference beyond sense he does not mean a process of concluding from sensible things to similar things, e.g. from tangible pressures to other similar pressures in the external world. Inference, according to him, is merely mental completion of sensations; and this mental completion has two characteristics: it only forms ideas, and it proceeds by an "economy of thought." In the course of his learned studies on the history of mechanics he became deeply impressed with Galileo's appeals to simplicity as a test of truth, and converted what is at best only one characteristic of thinking

into its essence. According to him, whatever inferences we make, certain or uncertain, are mere economies of thought, adapting ideas to sensations, and filling out the gaps of experience by ideas; whatever we infer, whether bodies, or molecules, or atoms, or space of more than three dimensions, are all without distinction equally provisional conceptions, things of thought; and "bodies or things are compendious mental symbols for groups of sensations—symbols which do not exist outside thought." Moreover, he applies the same scepticism to cause and effect. "In Nature," says he, "there is no cause and no effect." He thinks that repetitions of similar conjunctions occur in Nature, the connexion of cause and effect only in abstraction. He refers to Hume as recognizing no causality but only a customary and habitual succession, but adds that Kant rightly recognizes that mere observation cannot teach the necessity of the conjunction. But in reality his theory is neither Hume's theory of association nor Kant's of an a priori notion of understanding under which a given case is subsumed. He thinks that there is a notion of understanding (*Verstandesbegriff*), under which every new experience is subsumed, but that it has been developed by former experience, instinctively, and by the development of the race, as part of the economy of thinking. "Cause and effect are therefore," he concludes, "thought-things of economical function (*Gedankendinge von ökonomischer Function*)." His philosophy, therefore, is that all known things are sensations and complexes of sensory elements, supplemented by an economy of thinking which cannot carry us beyond ideas to real things, or beyond relations of dependency to real causes.

It is important to understand that Mach had developed this economical view of thought in 1872, more than ten years before the appearance of his work on the history of mechanics. Kirchhoff, as he tells us in the preface, where he adds that at a later date similar views were expressed by Kirchhoff in his *Vorlesungen über mathematische Physik* (1874). Kirchhoff asserted that the whole object of mechanics is "to describe the motions occurring in Nature completely in the simplest manner." This view involves the denial of force as a cause, and the assertion that all we know about force is that the acceleration of one mass depends on that of another, as in mathematics a function depends on a variable; and that even Newton's third law of motion is merely a description of the fact that two material points determine in one another, without reciprocally causing, opposite accelerations. It is evident that Kirchhoff's descriptive is the same as Mach's economical view. "When I say," says Mach, "that a body A exerts a force on a body B, I mean that B, on coming into contraposition with A, is immediately affected by a certain acceleration with respect to A." In a word, Mach and Kirchhoff agree that force is not a cause, convert Newtonian reciprocal action into mere interdependency, and, in old terminology, reduce mechanics from a natural philosophy of causes to a natural history of mere facts. Now, Mach applies these preconceived opinions to "mechanics in its development," with the result that, though he shows much skill in mathematical mechanics, he misrepresents its development precisely at the critical point of the discovery of Newton's third law of motion.

The true order of discovery, however, was as follows:—

(a) Sir Christopher Wren made many experiments before the Royal Society, which were afterwards repeated in a corrected form by Sir Isaac Newton in the *Principia*, experimentally proving that bodies of ascertained comparative weights, when suspended and impelled against one another, forced one another back by impressing on one another opposite changes of velocity inversely as their weights and therefore masses; that is, by impressing on one another equal and opposite changes of momentum.

(b) Wallis showed that such bodies reduce one another to a joint mass with a common velocity equal to their joint momentum divided by their joint weights or masses. This result is easily deducible also from Wren's discovery. If m and m' are the masses, v and v' their initial velocities, and V the common velocity, then $m(v - V) = m'(V - v)$, therefore $mv + m'v' = (m + m')V$, and hence $(mv + m'v')/(m + m') = V$.

(c) Wren and Huygens further proved that the law of equal action and reaction, already experimentally established by the former, is deducible from the conservation of the velocity of the common centre of gravity, which is the same as the common velocity of the bodies, that is, deducible from the fact that their common centre

of gravity does not change its state of motion or rest by the actions of the bodies between themselves; and they further extended the law to bodies, *qua* elastic.

(d) Hence, first inductively and then deductively, the third law was originally discovered only as a law of collision or impact between bodies of ascertained weights and therefore masses, impressing on one another equal and opposite changes of momentum, and always reducing one another to a common velocity with common velocity to begin with, apart from the subsequent effects of elasticity.

(e) Newton in the *Principia*, repeating and correcting Wren's experiments on collision, and adding further instances from attractive forces of magnetism and gravity, induced the third law of motion as a general law of all forces.

This order of discovery shows that the third law was generalized from the experiments of Wren on bodies of ascertained comparative weights or masses, which are not material points or mass-points. It shows that the bodies impress on one another opposite changes of velocity inversely as their weights or masses; and that in doing so they always begin by reducing one another to a joint mass with a common velocity, whatever they may do afterwards in consequence of their elasticities. The two bodies therefore do not penetrate one another, but begin by acting on one another with a force precisely sufficient, instead of penetrating one another, to cause them to form a joint mass with a common velocity. Bodies then are triply extended substances, each occupying enough space to prevent mutual penetration, and by this force of mutual impenetrability or triple resistance cause one another to form a joint mass with a common velocity whenever they collide. Withdraw this foundation of bodies as inter-resisting forces causing one another in collision to form a joint mass with a common velocity but without penetration, and the evidence of the third law disappears; for in the case of attractive forces we know nothing of their *modus operandi* except by the analogy of the collision of inter-resisting bodies, which makes us believe that something similar, we know not what, takes place in gravity, magnetism, electricity, &c. Now, Mach, though he occasionally drops hints that the discovery of the law of collision came first, yet never explains the process of development from it to the third law of motion. On the contrary, he treats the law of collision with other laws as an application of the third law of motion, because it is now unfortunately so taught in books of mechanics. He has therefore lost sight of the truths that bodies are triply extended, mutually impenetrable substances, and by this force causes which reduce one another to a joint mass with a common velocity on collision, as for instance in the ballistic pendulum; that these forces are the ones we best understand; and that they are reciprocal causes of the common velocity of their joint mass, whatever happens afterwards. In the case of this one force we know far more than the interdependence supposed by Mach and Kirchhoff; we know bodies with impenetrable force causing one another to keep apart. It might have been expected that scepticism on this subject would not have had much effect. But the idealists are only too glad to get any excuse for denying bodily substances and causes; and, while Leibnitz supplied them with the fancied analysis of material into immaterial elements, and Hume with the reduction of bodies to assidages of sensations, Mach adds the additional argument that bodily forces are not causes at all. In Great Britain Mach's scepticism was welcomed by Karl Pearson to support an idealistic phenomenalism derived from Hume, and by Ward to support a noumenal idealism derived from Lotze. No real advance in metaphysics can take place, and natural science itself is in some danger, until the true history of the evidences of the laws of mechanical force is restored; and then it will soon appear that in the force of collision what we know is not material points determining one another's opposite accelerations, but bodies by force of impenetrable pressure causing one another to keep apart. Mechanics is a natural philosophy of causes.

3. *Dualism within Experience.*—Besides those philosophies which are reactions to Kant or to Hume, there are a number of other modern systems which start with the common hypothesis that knowledge is experience. The consequence is that whatever is true of experience they transfer to all knowledge. One of the characteristics of actual experience is that its object is, or has been, present to an experiencing subject; and of possible experience that it can be present. As a matter of fact, this characteristic differentiates experience from inference. By inference we know that things, such as the farther side of the moon, which neither are, nor have been, nor can be, present to an experiencing subject on the earth, nevertheless exist. But, on the hypothesis that knowledge contains no inferences beyond experience, it follows that all the objects of knowledge, being objects of experience, are, or have been, or can be, present to an experiencing subject. Hence it is common nowadays to hold that there is indeed a difference between knower and known, ego and non-ego, subject and object, but that they are inseparable; or that all known things are objects and subjects inseparably connected in

experience. This view, however, is held in different forms; and two opposite forms have arisen in Germany, "immanent philosophy" and "empirio-criticism," the former nearer to Kant, the latter to Hume.

Immanent Philosophy is the hypothesis that the world is not transcendent, but immanent in consciousness. Among the upholders of this view are Anton von Leclair, who expresses it in the formula—"Denken eines Seins = gedachtes *Immanent Philosophy*. Sein," and R. von Schubert-Soldern, who says that every fragment of the pretended transcendent world belongs to the immanent. But the best known representative of Immanent Philosophy is W. Schuppe, who, in his *Erkenntnistheoretische Logik* (1878), and in a shorter *Grundriss der Erkenntnistheorie und Logik* (1894) gives the view a wider scope by the contention that the real world is the common content or object of common consciousness, which, according to him, as according to Fichte, is one and the same in all individual men. Different individual consciousnesses plainly differ in having each its own content, in which Schuppe includes each individual's body as well as the rest of the things which come within the consciousness of each; but they also as plainly agree, e.g. in all admitting one sun. Now, the point of Schuppe is that, so far as they agree, individual consciousnesses are not merely similar, but are essentially one and the same. The sense of consciousness in different individuals is what he calls consciousness in general (*Bewusstsein überhaupt*). While in this identification he follows Fichte, in other respects he is more like Kant. He supposes that the conscious content is partly a posteriori, or consisting of given data of sense, and partly a priori, or consisting of categories of understanding, which, being valid for all objects, are contributed by the common consciousness. He differs, however, from Kant, not only because he will not allow that the given data are received from things in themselves, but also because, like Mach, he agrees with the naturalists that the data already contain a spatial determinacy and a temporal determinacy, which he regards as a posteriori elements of the given, not like Kant, as a priori forms of sense. He allows, in fact, no a priori forms except categories of the understanding, and these he reduces, considering that the most important are identity with difference and causality, which in his view are necessary to the judgments that the various data which make up a total impression (*Gesamteindruck*, *Totaldruck*) are each different from the others, though identical with the total impression, and causally connected in a notion of necessary sequence or coexistence. At the same time, true to the hypothesis of "immanence," he rigidly confines these categories to the given data, and altogether avoids the inconsistent tendency of Kant to transfer causality from a necessary relation between phenomena to a necessary relation between phenomena and things in themselves as their causes. Hence he strictly confines true judgment and knowledge to the consciousness of the identity or difference, and the causal relations of the given content of the common consciousness. From this epistemology he derives the metaphysical conclusion that the things we know are indeed independent of my consciousness and of yours taken individually, or, to use a new phrase, are "trans-subjective"; but, so far from being independent of the common consciousness, one and the same in all of us, they are simply its contents in the inseparable relation of subject and object. To the objection that there are objects, e.g. atoms, which are never given to any consciousness, he returns the familiar Kantian answer that, though unperceived, they are perceptible. The whole known world, then according to him, is the perceived and the perceptible content of common consciousness.

The empirio-criticism" of R. Avenarius (*g.r.*) is the hypothesis of the inseparability of subject and object, or, to use his own phraseology, of ego and environment, in purely empirical, or a posteriori form. It is like "immanent philosophy," but it is opposing experience to the transcendent; but it also opposes experience to the transcendental, or a priori. It opposes "pure experience" to "pure reason," while it agrees with Kant's limitation of knowledge to experience. Avenarius held a view of knowledge very like that of Mach's view of the economy of thinking in his philosophical treatise, *Philosophie als Denken der Welt gemäss dem Princip des kleinsten Kraftmasses. Prolegomena zu einer Kritik der reinen Erfahrung* (1876), he based his views on the principle of least action, contending that, as in Nature the force which produces a change is the least that can be, so in mind belief tends in the easiest direction. In illustration of this tendency, he pointed out that mind tends to assimilate a new impression to a previous content, and by generalization to bring as many impressions under as few general conceptions as possible, and succeeds so far as it generalizes from pure experience of the given. Nor is there any objection to this economical view of thought, as long as we remember what Avenarius and Mach forget, that the essence of thought is the least action neither more nor less than necessary to the point, which is the reality of things. Afterwards, in his *Kritik der reinen Erfahrung* (1888-1890), Avenarius aimed at giving a description of pure experience which he identified with the natural view of the world held by all unprejudiced persons. What, then, is this "pure experience"? "Every human individual," says he,

"originally accepts over against him an environment with manifold parts, other individuals making manifold statements, and what is stated in some way dependent upon the environment." Statements dependent upon the environment are what he means by pure experience. At first this starting-point looks like dualistic realism, but in reality the author only meant dualism within experience. By the environment he meant not a thing existing in itself, but only a counterpart (*Gegenbild*) of ourselves as central part (*Centralglied*). "We cannot," he adds, "think ourselves as central part away." He went so far as to assert that where one assumes that at some time there was no living being in the world, all one means is that there was besides oneself no other central part to whom one's counterparts might also be counterparts. The consequence is that all the world admitted into his philosophy is what he called the "empirio-critical essential co-ordination" (*empirio-kritische Prinzipialkoordination*), an inseparable correlation of central part and counterpart, of ego and environment. Within this essential co-ordination he distinguished three values: *R-values* of the environment as stimulus; *C-values* of the central nervous system; and *E-values* of human statements—the latter being characterized by that which at the time of its existence for the individual admits of being named, and including what we call sensations, &c., which depend indirectly on the environment and directly on the central nervous system, but are not, as the materialist supposes, in any way reducible to possessions of the brain or any other part of that system. This division of values brings us to the second point in his philosophy, his theory of what he called "vital series," by which he assayed to explain all life, action and thought. A vital series he supposed to be always a reaction of C against disturbance by R, consisting in first a vital difference, or diminution by R of the maintenance-value of C, and then the recovery by C of its maintenance-value, in accordance with the principle of least action. He further supposed that, while this independent vital series of C is sometimes of this simple kind, at other times it is complicated by the addition of a dependent vital series in E, by which, in his fondness for too general and far-fetched explanations, he endeavoured to explain conscious action and thought. (Thus, if a pain is an E-value directly dependent on a disturbance in C, and a pleasure another E-value directly dependent on a recovery of C, it will follow that a transition from pain to pleasure will be a vital series in E directly dependent on an independent vital series in C, recovering from a vital difference to its maintenance-maximum.) Lastly, supposing that all human processes can in this way be reduced to vital series in an essential co-ordination of oneself and environment, Avenarius held that this empirio-critical supposition, which according to him is also the natural view of pure experiences, contains no opposition of physical and psychical, of an outer physical and an inner psychical world—an opposition which seemed to him to be a division of the inseparable. He considered that the whole hypothesis that an outer physical thing causes a change in one's central nervous system, which again causes another change in one's inner psychical system or soul, is a departure from the natural view of the universe, and is due to what he called "introduction," or the hypothesis which enloses soul and its faculties in that which is to be reduced to vital series in an essential co-ordination of oneself and inner, gets into the difficulty of explaining how an outer physical stimulus can impart something into an inner psychical soul. He concluded therefore that, having disposed of this fallacy of introduction, we ought to return to the view of reality as an essential co-ordination of ego and environment, of central part and counterpart, with R-values, C-values and E-values.

It is curious that Avenarius should have brought forward this artificial hypothesis as the natural view of the world, without reflecting that on the one hand the majority of mankind believes that the environment (R) exists, has existed, and will exist, without being a counterpart of any living being as central part (C); and that on the other hand it is so far from being natural to man to believe that sensation and thought (E) are different from, and merely dependent on, his body (C), that throughout the Homeric poems, though soul is required for other purposes, all thinking as well as sensation is regarded as a purely bodily operation. It is indeed difficult to assign any rational place to the empirio-criticism of Avenarius. It is materialistic without being materialism; it is realistic without being realism. Its rejection of the whole relation of physical and psychical makes it almost too indefinite to classify among philosophical systems. But its main point is the essential co-ordination of the ego and environment as central part and counterpart. It is therefore nearly connected with "immanent philosophy." Schuppe, indeed, wrote an article in the *Vierteljahrsschrift* of Avenarius to prove their essential agreement. At the same time Schuppe's hypothesis of one common consciousness uniting the given *a priori* categories could hardly be accepted by Avenarius as pure experience, or as a natural view of the world. His "empirio-criticism" is idealistic dualism within experience in an a posteriori form, but with a tendency towards materialism.

4. *Voluntaristic Phenomenalism of Wundt.*—Wundt's metaphysics will form an appropriate conclusion of this sketch of German idealism, because his patient industry and eclectic spirit have fitted him to assimilate many of the views of his

predecessors. Wundt proves that all idealisms are in a way one. He starts as a phenomenalist from the hypothesis, which we have just described, that knowledge is experience containing subject and object in inseparable connexion, and has something in common with the premature attempt of Avenarius to develop the hypothesis of dualism in experience into a scientific philosophy comprehending the universe in the simplest possible manner. Again he agrees with the reaction both to Hume and to Kant in limiting knowledge to mental phenomena, and has affinities with Mach as well as with Lange. His main sympathies are with the Neo-Kantians, and especially with Lange in modifying the *a priori*, and in extending the power of reason beyond phenomena to an ideal world; and yet the cry of his phenomenism is not "back to Kant," but "beyond Kant." Though no nominalist, in many details he is with nominalists; with Fechner in psychophysics, in psychophysical parallelism, in the independence of the physical and the psychical chains of causality, in reducing physical and psychical to a difference of aspects, in substituting impulse for accident in organic evolution, and in wishing to impose a gradation of individual spiritual beings; with Schopenhauer and Hartmann in voluntarism; and even with Schelling and Hegel in their endeavour, albeit on an artificial method, to bring experience under notions, and to unite subject and object in one concrete reality. He has a special relation to Fichte in developing the Kantian activity of consciousness into will and substituting activity for substantiality as the essence of soul, as well as in breaking down the antithesis between phenomena and things in themselves. At the same time, in spite of his sympathy with the whole development of idealism since Kant, which leads him to reject the *thing-in-itself*, to modify *a priori*ism, and to stop at transcendent "ideals," without postulates of practical reason, he nevertheless has so much sympathy with Kant's *Kritik* as on its theories of sense and understanding to build up a system of phenomenism, according to which knowledge begins and ends with ideas, and finally on its theory of pure reason to accord to reason a power of logically forming an "ideal" of God as ground of the moral "ideal" of humanity—though without any power of logically inferring any corresponding reality. He constructs his system on the Kantian order—sense, understanding, reason—and exhibits most clearly the necessary consequence from psychological to metaphysical idealism. His philosophy is the best exposition of the method and argument of modern idealism—that we perceive the mental and, therefore, all we know and conceive is the mental.

Wundt founds his whole philosophy on four psychological positions: his phenomenalistic theory of unitary experience, his voluntarism, his actualistic theory of soul, and his psychological theory of parallelism. They are positions also which deeply affect, not only the psychological, but also the metaphysical idealisms of our time, in Germany, and in the whole civilized world.

i. His first position is his phenomenalistic theory of unitary experience. According to him, we begin with an experience of ideas, in which object and idea are originally identical (*Vorstellung-objekt*); we divide this unitary experience into its subjective and objective factors; and especially in natural science we so far abstract the objects as to believe them at last to be independent things; but it is the office of psychology to warn us against this popular dualism, and to teach us that there is only a duality of psychical and physical, which are divisible, not separable, factors of one and the same content of our immediate experience; and experience is our whole knowledge. His metaphysical deduction from this psychological view is that all we know is mental phenomena, "the whole outer world exists for us only in our ideas," and all that our reason can logically do beyond these phenomena is to frame transcendent "ideals."

ii. His second position is his voluntarism. He agrees with Schopenhauer that will is the fundamental form of the spiritual. He does not mean that will is the only mental operation; for he recognizes idea derived from sensation, and feeling, as well as will. Moreover, he contends that we can neither have idea without feeling and will, nor will without idea and feeling; that idea alone wants activity, and will alone wants content; that will is ideating and activity (*vorstellende Thätigkeit*), which always includes motives

and ends and consequently ideas. He is therefore a follower of Schopenhauer as corrected by Hartmann. Like these predecessors, and like his younger contemporary Paulsen, in calling will fundamental he includes impulse (*Trieb*). Accordingly he divides will into two species: on the one hand, simple volition, or impulse, which in his view requires as motive a feeling directed to an end, and, therefore an idea, e.g. the impulse of a bear arising from hunger and sight of prey; on the other hand, complex volition issuing in a voluntary act requiring decision (*Entscheidung*) or conscious adoption of a motive, with or without choice. Like other German voluntarists, he imputes "impulsive will" to the whole organic world. He follows Fechner closely in his answer to Darwin. If he is to be believed, at the bottom of all organic evolution organic impulses becoming habits produce structural changes, which are transmitted by heredity; and as an impulse thus gradually becomes secondarily automatic, the will passes to higher activities, which in their turn become secondarily automatic, and so on. As now he supposes feeling even in "impulsive will" to be directed to an end, he deduces the conclusion that in organic evolution the pursuit of final causes precedes and is the origin of mechanism. But at what a cost! He has endowed all the plants in the world with motives, feelings directed to an end, and ideas, all of which, according to him, are required for impulse! He apparently forgets that mere feelings often produce actions, as the one rich with pain and vexation, so, having the lowest impulses from a feeling of pain or pleasure? Wundt, however, having gone so far, there stops. It is not necessary for him to follow Schopenhauer, Hartmann and Fechner in endowing the material universe with will or any other mental operation, because his phenomenalism already reduces inorganic nature to mere objects of experiencing subjects. Wundt's voluntarism takes a new departure, in which, however, he was anticipated by the paradox of Descartes: that will is required to give assent to anything perceived (*Principia philosophiae*, t. 34). Wundt supposes not only that all organisms have outer will, the will to act, but also that all thinking is inner will—the will to think. Now there is a will to think, and Aristotle pointed out that thinking is in our power whenever one pleases, whereas sense depends on an external stimulus (*De anima*, ii. 5). There is also an impulse to think, e.g. from toothache. But it does not follow that thought is will, or even that there is no thinking without either impulse or will proper. The real source of thinking is evidence. Wundt, however, having proceeded to this point, does not stop. He next supposes that all thinking is willing. What is the source of this paradox? It is a confusion of willing with will, and activity with both. He supposes that all agency, and therefore the agency of thinking, is will. In detail, to express this supposed inner will of thinking, he borrows from Leibnitz and Kant the term "apperception," but in a sense of his own. Leibnitz, by way of distinction from unconscious perception, gave the name "apperception" to consciousness. Kant further insisted that this apperception, "I think," is an act of spontaneity distinct from every necessity regarding all my ideas as mine, and to combining them in a synthetic unity of apperception; which act Fichte afterwards developed into an active construction of all knowledge, requiring will directed to the end of duty. Wundt, in consequence, thinking with Kant that apperception is a spontaneous activity, and with Fichte that this activity requires will, and indeed that all activity is will, infers that apperception is inner will. Further, on his own account, he identifies apperception with the process of attention, and regards it as an act necessary to the general formation of compound ideas, to all association of ideas, to all imagination and understanding. According to him, then, attention, even involuntary attention, requires inner will; and all the functions imputed by Hume to association, as well as those imputed to understanding by Kant, require apperception, and therefore inner will. At the same time he does not suppose that they all require the same kind of will. In accordance with his previous division of outer will into impulsive and decisive, he divides the general will of apperception into the apperception of an active operation. Apperception, in general thus becomes activity of inner will, constituting the process of attention, passive in the form of impulsive will required for association, and active in the form of decisive will required for understanding and judgment. Now, beneath these confusing phrases the point to be regarded is that, in Wundt's opinion, though we can receive sensations, we cannot think at all beyond sense, without some will. This exaggeration of the real fact of the will to think ignores throughout the position of the man in the great world, and the agency of things which drive him to perceive to sense and from sense to thought. It is a substitution of will for evidence as ground of assent, and a neglect of our consciousness that we often believe against our will (e.g. that we must die), often without even an impulse to believe, often without taking any interest, or when taking interest in something else of no importance. "The Dean is dead (Pray, what is trumps?)." Yet many psychologists accept the universality of this will to believe, and among them James, who says that it is necessary to the ground of the intellect, and is built up of practical interests. "We should rather say 'far too much.'" Wundt, however, goes still farther. According to him, that which acts in all organisms, that which acts in all thinking, that which divides unitary experience into subject and object,

the source of self-consciousness, the unity of our mental life, "the most proper being of the individual subject is will." In short, his whole voluntarism means that, while the inorganic world is mere object, all organization is congealed will, and all thinking is apperceptive will. But it must be remembered that these conclusions are arrived at by confusing action, reaction, will, excitability, impulse, and rational desire, all under the one word "will," as well as by omitting the involuntary action of intelligence under the pressure of evidence. It may well be that impulsive feeling is the beginning of mind; but then the order of mind is feeling, sense, inference, will, which instead of first is last, and implies the others. To proceed, however, with voluntarism, Wundt, as we have seen, makes personality turn on will. He does not accept the universal voluntarism of Schopenhauer and Hartmann, but believes in individual will, and in greater or smaller degrees, the organic world. Similarly, he supposes our personal individual will is a collective will containing similar will-unities, and he thinks that this conclusion is proved by the continuance of actions in animals after parts of the brain have been removed. In a similar way he supposes our wills are included in the collective will of society. He does not, however, think with Schuppe that there is one common consciousness, but only that there is a collective consciousness and a collective will; not perceiving that then the will in this is not a mere will, but the experience of any member of the collection—would be only a collection of wills. Lastly, he believes that reason forms the "ideal" of God as world-will, though without proof of existence. On the whole, his voluntarism, though like that of Schopenhauer and Hartmann, is not the same; not Schopenhauer's, because the ideating will of Wundt's philosophy is not a universal irrational will; and not Hartmann's, because, although ideating will, according to Wundt's phenomenalism, is supposed to extend through the world of organisms, the whole inorganic world remains a mere object of unitary experience.

iii. His third position is his actualistic theory of soul, which he shares with Fichte, Hegel, Fechner and Paulsen. When Fichte had rejected the Kantian soul in itself and developed the Kantian activity of apperception, he considered that soul consists in constructive activity. Fechner added that the soul is the whole unitary spiritual process manifested in the whole unitary bodily process without being a substance. Wundt accepts Fichte's theory of the actualistic and feeling-synthetic view of the soul. Taking substance entirely in the sense of substance, he argues that there is no evidence of a substantial substrate beneath mental operations; that there is nothing except unitary experience consisting of ideas, feelings, volitions, and their unity of will; and that soul in short is not *substantia*, but *actus*. He does not see that this unity is only apparent, for men think not always, and will not always. Nor does he see that a man is conscious not of idea, feeling, will, experience, but of something conceiving, feeling, willing and experiencing, which he gradually begins to call himself, and that he is never conscious of doing all this "minding" without his body. If, then, these mental operations were merely actuality, they would be actuality of a man's bodily substance. In truth there is no sound answer to Materialism, except that, besides bodily substance, psychical substance is also necessary to explain how man performs mental actualities consciously (see case *Physical Realism*, ch. v.). Wundt, however, has satisfied himself, like Fechner, that there is no real opposition of body and soul, and concludes, in accordance with his own phenomenalism, that his body is only an object abstracted from his unitary experience, which is all that really is of him.

iv. Hence his fourth point is his psychological theory of parallelism of physical and psychical reduced to identity in unitary experience. Here his philosophy is Fechnerism phenomenalized. He accepts Fechner's extension of Weber's law of the external stimuli of sense, while judiciously remarking that "the physiological interpretation is entirely hypothetical." He accepts psychophysical parallelism in the sense that every psychical process has a physical accompaniment, every physiological function has a psychical meaning, but neither external stimulus nor physiological stimulus is cause of a psychical process, nor vice versa. Precisely like Fechner, he holds that there is a physical causality and energy and there is a psychical causality and energy, parallels which never meet. He uses this psychical causality to carry out his voluntarism into detail, regarding it as an agency of will directed to ends, causing association and understanding, and further acting on a principle which he calls the heterogeneity of ends; remarking very truly that each particular will is directed to particular ends, but that beyond these ends effects follow as unexpected consequences, and that this heterogeneity produces social effects which we call custom. But while thus sharply distinguishing the physical and the psychical in appearance, he follows Fechner in identifying them in reality; except that Fechner's identification is noumenal, Wundt's phenomenal. Wundt does not allow that we know beyond experience any ground of certainty, or that the will is being. He does not, therefore, allow that there is a universal series of physical and psychical parallels. According to his phenomenalism, the external stimulus and the physiological stimulus are both parallels of the same psychical process; the external body, as well as

my body, is merely an object abstracted from an idea of my experience; and what is really known in every case is a unitary experience; divisible, but not separable, into body and soul, physical and psychical factors of one and the same unitary experience. Wundt is confined by his starting-point to his deduction that what we know is mental phenomena, ideas regarded as objects and subjects of experience.

With these four positions in hand, Wundt's philosophy consecutively follows: beginning with psychology, he starts with psychical elements, sensations and feelings; but he asserts that these always exist in a psychical compound, from which they can be discovered only by analysis and abstraction; and his paradox that a pure sensation is an abstraction is repeated by W. James. Further, Wundt declares that the psychical compound of sensations, with which, according to him, we actually start, is not a complex sensation, but a compound idea; so that I am expected to believe that, when I hear the chord of D, I am not conscious of single sensations of D, F, A, and have only a compound idea of the chord—as if the hearing of music were merely a series of ideas. Wundt, however, has a reason for substituting compound idea for sensation: he accepts Lotze's hypothesis of local signs, and adds a hypothesis of temporal signs. He supposes that we have no sensations of space and time, as the nativists suppose, but that, while local signs give us spatial ideas, feelings of expectation are temporal signs giving us temporal ideas, and that these ideas enter into the psychical compound, which is our actual starting-point. It follows that every psychical compound into which temporal and spatial ideas enter must itself be an idea; and, as time at any rate accompanies all our sensations, it follows that every psychical compound of sensations, containing at least always temporal, if not also spatial, ideas, must be a compound idea, and not, as nativists suppose, Schuppe for instance, a compound sensation. The next question is, how compounded? Wundt's answer is that inner impulsive will, in the form of passive apperception, forms compound ideas by association; so that all these operations are necessary to the starting-point. He prefixes to the ordinary associations, which descend from Hume, an association which he calls fusion (*Verschmelzung*), and supposes that it is a fundamental process of fusing sensations with spatial and temporal ideas into a compound idea. But he also recognizes association by similarity; and, as an apperceptive process, it is, he says, more confined in sense of the word, and association by contiguity, or complication. Recognizing, then, three kinds of association in all, he supposes that they are the first processes, by which inner will, in the form of passive apperception, generates ideas from sense. So far his psychology is a further development of Hume's. But he does not agree with Hume that mind is nothing but sensations, ideas, and associations, but with Kant, that there are higher combinations. According to him, inner decisive will, rising to active apperception, proceeds to what he calls "apperceptive combinations" or *Apperceptionsverbindungen*—of simple combinations of relating and comparing, and then to complex combinations of synthesis and analysis in imagination and understanding; in consequence of which synthesis issues in an aggregate idea (*Gesamtvorstellung*), and then at last analysis, by dividing an aggregate idea into subject and predicate, forms a judgment (see further LOGIC). The main point of this theory is that, if it were true, we should be forever confined to a jumble of ideas. Wundt, indeed, is aware of the consequences. If judgment is an analysis of an aggregate idea into subject and predicate, it follows, as he says, that "as judgment is an *immediate*, so is inference a *mediate*, reference of members to an aggregate idea" (see further *Herbart's System der Philosophie*, 66, first ed.). He cannot allow any inference of things beyond ideas. His psychology poisons his logic.

In his logic, and especially in his epistemology, Wundt appears as a mediator between Hume and Kant, but with more leaning to the latter. While he regards association as lying at the basis of all knowledge, he does not think it sufficient, and objects to Hume that he does not account for necessity, nor for substance and causation as known in the sciences. He accepts on the whole the system of synthetic understanding which Kant superimposed on mere association. Yet he will not proceed to the length of Kant's transcendentalism. Between Hume's a posteriori and Kant's a priori hypothesis he proposes a *logical* theory of the origin of notions beyond experience. He explains that the arrangement of facts requires "general supplementary notions (*Hilfsbegriffe*), which are not contained in experience itself, but are gained by a process of logical treatment of this experience." Of these supplementary notions he holds that the most general is that of causality, coming from the necessity of thought that all our experiences shall be arranged according to ground and consequent. That sense only gives to experience coexistences and sequences of appearances, as Hume said, and Kant allowed is also Wundt's starting-point. How then do we arrive at causality? Not, says Wundt, by association, as Hume said, but by thinking; not, however, by a priori thinking, as Kant said, but by logical thinking, by applying the logical principle of ground and consequent (which Leibnitz had called the principle of sufficient reason) as a causal law to empirical appearances. Now, Wundt is aware that this is not always possible, for he holds that the logical principle of ground belongs generally to the connexion of thoughts, the causal law to

the combination of empirical appearances. Nevertheless he believes that, when we can apply measures to the combination of empirical appearances, then we can apply the logical principle as causal law to this combination, and say that one appearance is the cause of another, thus adding a notion of causality not contained in the actual observations, but specializing the general notion of causality. He quotes as an instance that Newton in this way added to the planetary appearances contained in Kepler's laws the gravitation of the planets to the sun, as a notion of causality not contained in the appearances, and thus discovered that gravitation is the cause of the appearances. But Newton had already discovered beforehand in the mechanics of terrestrial bodies that gravitation constantly causes similar facts on the earth, and did not derive that cause from any logical ground beyond experience, any more than he did the third law of motion. Wundt does not realize that, though we can often use a cause or real ground (*principium essendi*) as a logical ground (*principium cognoscendi*) for deducing effects, we can do so only when we have previously inferred from experience that that kind of cause does produce that kind of effect (see LOGIC). Otherwise, logical ground remains logical ground, as in any non-causal syllogism, such as the familiar one from "All men are mortal," which causes me to know that I shall die, without telling me the cause of death. Wundt, however, having satisfied himself of the power of mere logical thought beyond experience, goes on to further apply his hypothesis, and supposes that, in dealing with the physical world, logical thinking having added to experience the "supplementary notion" of causality as the connexion of appearances which vary together, adds also the "supplementary notion" of substance as the substratum of the connected appearances. But, using substance as he does always in the case of sense-experience, substratum beneath changing phenomena, and never in the Aristotelian sense of any distinct thing, he proceeds to make distinctions between the applications of causality and of substance. Even in the physical, he confines substance to matter, or what Aristotle would call material causes, thus makes its power to be merely passive, and limits substantial causality to potential energy, while he supposes that actual causality is a relation not of substances but of events. On this false abstraction Sigwart has made an excellent criticism in an appendix at the end of his *Logic*, where he remarks that we cannot isolate events from the substances of which they are attributes. Motions do not cause motions, nor one body moving causes another body to move: what we know is causal substances. Secondly, when Wundt comes to the psychical, he naturally infers from his narrow Kantian definition of substance that there is no proof of a substrate over and above all mental operations, and falsely thinks that he has proved that there is no substance mentally operating in the Aristotelian sense. Thirdly, on the grounds that logical thinking adds the notion of substance, as substrate, to experience of the physical, but not of the psychical, and that the most proper being of mind is will, he concludes that wills are not active substances, but sense-generating activities ("nicht thätige Substanzen sondern substanzerzeugende Thätigkeiten," *System*, 429).

What kind of metaphysics, then, follows from this compound of psychology and epistemology? As with Kant against Hume, so with Wundt against Mach and Avenarius, the world we know will contain something more than mere complexes of sensations, more than pure experience: with Wundt it will be a world of real causes and some substances, constituted partly by experience and partly by logical thinking, or active inner will. But as with Kant, so with Wundt, this world will be only the richer, not the wider, for these notions of understanding; because they are only contributed to the original experience, and, being mentally contributed, only the more surely confine knowledge to experience of mental phenomena. Hence, according to Wundt, the world we know is still unitary experience, distinguished, not separated, into subject and object, aggregates of ideas analysed by judgment and combined by inference, an object of idea elaborated into causes and substances by logical thinking, at most a world of our ideas composed out of our sensations, and arranged under our categories of our understanding by our inner wills, or a world of our ideating wills; but nothing else. It is Wundt's own statement of his solution of the epistemological problem "that on the one hand the whole outer world exists for us only in our ideas, and that on the other hand a consciousness without objects of idea is an empty abstraction which possesses no actuality" (*System*, 212-213). There remains his theory of reason. His pupil, Oswald Külpe (1862-), who bases his *Grundriss der Psychologie* on the hypothesis of unitary experience, says in his *Einleitung in die Philosophie* (1895; 4th ed. 1907) that Wundt in his *System* derives the right of metaphysics to transcend experience from similar procedure

within the limits of the special sciences. This is Wundt's view, but only in the sense that reason passes from ideas to "ideals," whether in the special sciences or in metaphysics. Reason, as in most modern psychologies and idealisms, is introduced by Wundt, after all sorts of operations, too late; and, when at length introduced, it is described as going beyond ideas and notions to "ideals" (*Ideen*), as an ideal continuation of series of thoughts beyond given experience—nothing more. Reason, according to Wundt, is like pure reason according to Kant; except that Wundt, receiving Kantism through Neo-Kantism, thinks that reason arrives at "ideals" not a priori, but by the logical process of ground and consequent, and, having abolished the thing in itself, will not follow Kant in his inconsequent passage from pure to practical reason in order to postulate a reality corresponding to "ideals" beyond experience. Wundt, in fact, agrees with Lange: that reason transcends experience of phenomena only to conceive "ideals." This being so, he finds in mathematics two kinds of transcendence—real, where the transcendent, though not actual in experience, can become partly so, e.g. the divisibility of magnitudes; imaginary, where it cannot, e.g. *n*-dimensions. He supposes in metaphysics the same transcendence in forming cosmological, psychological, and ontological "ideals." He supposes real as well as imaginary transcendence in cosmological "ideals"; the former as to the forms of space and time, the latter as to content, e.g. atoms. But he limits psychological and ontological "ideals" entirely to imaginary transcendence. The result is that he confines metaphysical transcendence to "a process into the imaginary" as regards the substantial and causal content of cosmological "ideals," and altogether as regards psychological and ontological "ideals." Thus, according to him, in the first place reason forms a cosmological "ideal" of a multitude of simple units related; secondly, it forms a psychological "ideal" of a multitude of wills, or substance-generating activities, which communicate with one another by ideas so that will causes ideas in will, while together they constitute a collective will, and it goes on to form the moral ideal of humanity (*das sittliche Menschheitsideal*); and, thirdly, it forms an ontological "ideal" of God as ground of this moral "ideal," and therewith of all being as means to this end, and an "ideal" of God as world-will, of which the world is development, and in which individual wills participate each in its sphere. "Herein," says Wundt, "consists the imperishable truth of the Kantian proposition that the moral order of the world is the single real proof of the existence of God" (*System*, 405; cf. 439). "Only," he adds, "the expression *proof* is here not admissible. Rational 'ideals' are in general not provable." As the same limit is applied by him to all transcendent rational "ideals," and especially to those which refer to the content of the notion of the world, and, like all psychological and ontological "ideals," belong to the imaginary transcendent, his conclusion is that reason, in transcending experience, logically conceives "ideals," but never logically infers corresponding realities.

The conclusion that reason in transcending experience can show no more than the necessity of "ideals" is the only conclusion which could follow from Wundt's phenomenalism in psychology, logic, and epistemology. If knowledge is experience of ideas distinguished by inner will of apperception into subject and object in inseparable connexion, if the starting-point is ideas, if judgment is analysis of an aggregate idea, if inference is a mediate reference of the members of an aggregate of ideas to one another, then, as Wundt says, all we can know, and all reason can logically infer from such data, is in our ideas, and consciousness without an object of idea is an abstraction; so that reason, in transcending experience, can show the necessity of ideas and "ideals," but infer no corresponding reality beyond, whether in nature, or in Man, or in God. Wundt, starting from a psychology of unitary experience, deduces a consistent metaphysics of no inference of things transcending experience throughout—or rather until he came to the very last sentence of his *System der Philosophie* (1889), where he suddenly passes from a necessity of "ideals" (*Ideen*), to a necessity of "faith"

(*Glauben*), without "knowledge" (*Wissen*). He forgets apparently that faith is a belief in things beyond ideas and ideals, which is impossible in his psychology of judgment and logic of inference. The fact is that his *System* may easily seem to prove more than it does. He describes it as idealism in the form of ideal realism, because it recognizes an ideating will requiring substance as substratum or matter for outer relations of phenomena. But when we look for the evidence of any such will beyond ourselves and our experience, we find Wundt offering nothing but an ontological "ideal" of reason, and a moral "ideal" requiring a religious "ideal," but without any power of inferring a corresponding reality. The *System* then ends with the necessity of an "ideal" of God as world-will, but provides no ground for the necessity of any belief whatever in the being of God, or indeed in any being at all beyond our own unitary experience.

Wundt, however, afterwards wrote an *Einleitung in die Philosophie* (1901; 4th ed., 1906), in which he speaks of realism in the form of ideal realism as the philosophy of the future. It is not to be idealism which resolves everything into spirit, but realism which gives the spiritual and the material each its own place in harmony with scientific consciousness. It is not to be dualistic but monistic realism, because matter is not separate from spirit. It is not to be materialistic but ideal realism, because the physical and the psychical are inseparable parallels inexplicable by one another. It is to be monistic ideal realism, like that of Fichte and Hegel; not, however, like theirs idealistic in method, a *Phantastisches Begriffsgebäude*, but realistic in method, a *Wissenschaftliche Philosophie*. It is to be ideal realism, as in the *System*. It is not to be a species of idealism, as in the *System*—but of realism. How are we to understand this change of front? We can only explain it by supposing that Wundt wishes to believe that, beyond the "ideal," there really is *proof* of a transcendent, ideating, substance-generating will of God; and that he is approaching the noumenal voluntarism of his younger contemporary Paulsen. But to make such a conversion from phenomenalism plausible, it is necessary to be silent about his whole psychology, logic, and epistemology, and the consequent limitation of knowledge to experience, and of reason to ideas and "ideals," without any power of inferring corresponding things.

What a pity it is that Wundt had committed himself by his psychology to phenomenalism, to unitary experience, and to the limitation of judgment and reason to ideas and ideals! For his phenomenalism prevents him from consistently saying the truth inferred by reason—that there is a world beyond experience, a world of Nature, and a will of God, real as well as ideal. To understand Wundt is to discover what a mess modern psychology has made to metaphysics. To understand phenomenal idealism in Germany is to discover what a narrow world is to be known from the transcendental idealism of Kant shorn of Kant's inconsistencies. To understand noumenal idealism in Germany and the rise of metaphysical idealism in modern times is to discover that psychological is the origin of all metaphysical idealism. If we perceive only what is mental, all that we know is only mental. But who has proved that psychological starting-point? Who has proved that, when I scented an odour in my nostrils, I apprehend not odour but a sensation of odour; and so for the other senses? Sensation, as Aristotle said, is not of itself: it is the apprehension of a sensible object in the organism. I perceive pressure, heat, colour, sound, flavour, odour, in my five senses. Having felt reciprocal pressures in touch, I infer similar pressures between myself and the external world.

6.—ENGLISH IDEALISM

1. *The Followers of Hume's Phenomenalism.*—Compared with the great systems of the Germans, English idealism in the 19th century shows but little originality. It has been largely borrowed either from previous English or from later German idealism, and what originality it has possessed has been mainly shown in that spirit of eclectic compromise which is so dear to the English mind. The predominant influence, on the whole,

has been the phenomenalism of Hume, with its slender store of sensations, ideas and associations, and its conclusion that all we know is sensations without any known thinkers or any other known things. This phenomenalism was developed by James Mill (1773-1836) and J. S. Mill (1806-1873), and has since been continued by A. Bain. It also became the basis of the philosophies of Huxley and of Spencer on their phenomenalistic side. It is true that Spencer's "transfigured realism" contains much that was not dreamt of by Hume. Spencer widens the empirical theory of the origin of knowledge by his brilliant hypothesis of inherited organized tendencies, which has influenced all later psychology and epistemology, and tends to a kind of compromise between Hume and Kant. He describes his belief in an unknowable absolute as "carrying a step farther the doctrine put into shape by Hamilton and Mansel." He develops this belief in an absolute in connexion with his own theory of evolution into something different both from the idealism of Hume and the realism of Hamilton, and rather falling under the head of materialism. Nevertheless, as he believes all the time that everything knowable throughout the whole world of evolution is phenomena in the sense of subjective affections of consciousness, and as he applies Hume's distinction of impressions and ideas as a distinction of vivid and faint states of consciousness to the distinction of ego and non-ego, spirit and matter, inner and outer phenomena, his philosophy of the world as knowable remains within the limits of phenomenalism. Nothing could be more like Hume than his final statement that what we are conscious of is subjective affections produced by objective agencies unknown and unknowable. The "anti-realism," which takes the lion's share in "transfigured realism," is simply a development of the phenomenalism of Hume. Hume was also at the bottom of the philosophies of G. H. Lewes, who held that there is nothing but feelings, and of W. K. Clifford. Nor is Hume yet dethroned, as we see from the works of Karl Pearson and of William James, who, though an American, has exercised a considerable influence on English thought. The most flourishing time of phenomenalism, however, was during the lifetime of J. S. Mill. It was counteracted to some extent by the study at the universities of the deductive logic of Aristotle and the inductive logic of Bacon, by parts of Mill's own logic, and by the natural realism of Reid, Stewart, and Hamilton, which met Hume's scepticism by asserting a direct perception of the external world. But natural realism, as finally interpreted by Hamilton, was too dogmatic, too unsystematic, and too confused with elements derived from Kantian idealism to withstand the brilliant criticism of Mill's *Examination of Sir William Hamilton's Philosophy* (1865), a work which for a time almost persuaded us that Nature as we know it from sensations is nothing but permanent possibilities of sensation, and oneself only a series of states of consciousness.

2. *The Influence of Kant and Hegel.*—Nevertheless, there have never been wanting more soaring spirits who, shocked at the narrowness of the popular phenomenalism of Hume, have tried to find a wider idealism. They have, as a rule, sought it in Germany. Before the beginning of the 19th century, Kant had made his way to England in a translation of some of his works, and in an account of the *Elements of the Critical Philosophy* by A. F. M. Willich, both published in 1798. After a period of struggle, the influence of Kant gradually extended, and, as we see in the writings of Coleridge and Carlyle, of Hamilton and Mansel, of Green and Caird, of Laurie, Martineau and others, has secured an authority over English thought almost equal to that of Hume (see IDEALISM). Both philosophers appeal to the English love of experience, and Kant had these advantages over Hume: that within the narrow circle of sensible phenomena his theory of understanding gave to experience a fuller content, and that beyond phenomena, however inconsistently, his theory of reason postulated the reality of God, freedom and immortality. Other and wiser German philosophies gradually followed that of Kant to England. Coleridge (1772-1834) not only called attention to Kant's distinction

between understanding and reason, but also introduced his countrymen to the noumenal idealism of Schelling. In the *Biographia Literaria* (1817) he says that in Schelling's *Naturphilosophie* and *System des transcendentalen Idealismus* he first found a general coincidence with much that he had toiled out for himself, and he repeated some of the main tenets of Schelling. Carlyle (1795-1881) laid more emphasis on Fichte. At the height of his career, when between 1840 and 1850 many of Fichte's works were being translated in the Catholic Series, he called attention to Fichte's later view that all earthly things are but as a vesture or appearance under which the Divine idea of the world is the reality. Extravagant as this noumenalism is, it was a healthy antidote to the phenomenalism of the day. Among other followers of German idealism were J. F. Ferrier (*q.v.*), who adopted the hypothesis of Schelling and Hegel that there is one absolute intelligence (see his *Lectures and Philosophical Remains*, 1866, i. 1-33; ii. 545-568), and J. Hutchison Stirling (*q.v.*). About the same time Benjamin Jowett (*q.v.*) had been studying the philosophy of Hegel; but, being a man endowed with much love of truth but with little belief in first principles, he was too wise to take for a principle Hegel's assumption that different things are the same. He had, however, sown seeds in the minds of two distinguished pupils, T. H. Green and E. Caird (*q.v.*). Both proceeded to take Hegelianism seriously, and between them spread a kind of Hegelian orthodoxy in metaphysics and in theology throughout Great Britain. Green (*Prolegomena to Ethics*, 1883) T. H. Green tried to effect a harmony of Kant and Hegel by proceeding from the epistemology of the former to the metaphysics of the latter. Taken for granted the Kantian hypothesis of a sense of sensations requiring synthesis by understanding, and the Kantian conclusion that Nature as known consists of phenomena united by categories as objects of experience, Green argued, in accordance with Kant's first position, that knowledge, in order to unite the manifold of sensations by relations into related phenomena, requires unifying intelligence, or what Kant called synthetic unity of apperception, which cannot itself be sensation, because it arranges sensations; and he argued, in accordance with Kant's second position, that therefore Nature itself as known requires unifying intelligence to constitute the relations of its phenomena, and to make it a connected world of experience. When Green said that "Nature is the system of related appearances, and related appearances are impossible apart from the action of an intelligence," he was speaking as a pure Kantian, who could be answered only by the Aristotelian position that Nature consists of related bodies beyond appearances, and by the realistic supposition that there is a tactical sense of related bodies, of the inter-resisting members of the organism, from which reason infers similar related bodies beyond sense. But now, whatever opinion we may have about Nature, at all events, as Green saw, it does not come into existence in the process by which this person or that begins to think. Nature is not my nature, nor your nature, but one. From this fact of unity of nature and of everything in Nature, combined with the two previous positions accepted, not from Nature, but from Kant, Green proceeded to argue, altogether beyond Kant, that Nature, being one, and also requiring unifying intelligence, requires one intelligence, an eternal intelligence, a single spiritual principle, prior to, and the condition of, our individual knowledge. According to him, therefore, Nature is one system of phenomena united by relations as objects of experience, one system of related appearances, one system of one eternal intelligence which reproduces itself in us. The "true account" of the world in his own words is "that the concrete whole, which may be described indifferently as an eternal intelligence realized in the related facts of the world, or as a system of related facts rendered possible by such an intelligence, partially and gradually reproduces itself in us, communicating piecemeal, but in inseparable correlation, understanding and the facts understood, experience and the experienced world." Nobody can mistake the Schellingian and Hegelian nature of this conclusion. It is the Hegelian view that the world is a system of absolute reason. But it is

not a Kantian view; and it is necessary to correct two confusions of Kant and Hegel, which have been imported with Hegelianism by Green and Caird. Ferrier was aware that in Kant's system "there is no common nature in all intelligence" (*Lectures*, ii. 568). Green, on the other hand, in deducing his own conclusion that the world is, or is a system of, one eternal intelligence, incautiously put it forward as "what may be called broadly the Kantian view" (*Prolegomena*, § 36), and added that he follows Kant "in maintaining that a single active conscious principle, by whatever name it be called, is necessary to constitute such a world, as the condition under which alone phenomena, i.e. appearances to consciousness, can be related to each other in a single universe" (§ 38). He admitted, however, that Kant also asserted, beyond this single universe of a single principle, a world of unknowable things in themselves, which is a Kantian not a Hegelian world. But Caird endeavoured to break down even this second barrier between Kant and Hegel. According to Caird, Kant "reduces the inaccessible thing in itself (which he at first speaks of as affecting our sensibility) to a noumenon which is projected by reason itself" (*Essays*, ii. 405); and in the Transcendental Dialectic, which forms the last part of Kant's *Kritik*, the noumenon becomes the object of an intuitive understanding "whose thought," says Caird, "is one with the existence of the objects it knows" (*ibid.* 412, 413). Kant, then, as interpreted by English Hegelians, already believed, before Hegel, that there is one intelligence common to all individuals, and that a noumenon is a thought of this common intelligence, "an ideal of reason"; so that Kant was trying to be a Hegelian, holding that the world has no being beyond the thoughts of one intelligence. But history repeats itself; and these same two interpretations of Kant had already been made in the lifetime of Kant by Fichte, in the two Introductions to the "Wissenschaftslehre," which he published in his *Philosophical Journal* in 1797. Now, the curious fact is, that Kant himself wrote a most indignant letter, dated 7th August 1799 (*Kant's Werke*, ed. Hartenstein, viii. 600-601), on purpose to repudiate all connexion with Fichte. Fichte's "Wissenschaftslehre," he said, is a completely untenable system, and a metaphysics of fruitless apices, in which he disclaimed any participation; his own *Kritik* he refused to regard as a pro-ædæutic to be construed by the Fichtian or any other standpoint, declaring that it is to be understood according to the letter; and he went so far as to assert that his own critical philosophy is so satisfactory to the reason, theoretical and practical, as to be incapable of improvement, and for all future ages indispensable for the highest ends of humanity. After this letter it cannot be doubted that Kant not only differed wholly from Fichte, both about the synthetic unity of apperception and about the thing in itself, but also is to be construed literally throughout. When he said that the act of consciousness "I think," is *in allem Bewusstsein ein und dasselbe*, he meant, as the whole context shows, not that it is one in all thinkers, but only that it accompanies all my other ideas and is one and the same in all my consciousness, while it is different in different thinkers. Though again in the Transcendental Dialectic he spoke of pure reason conceiving "ideals" of noumena, he did not mean that a noumenon is nothing but a thought arising only through thinking, or projected by reason, but meant that pure reason can only conceive the "ideal" while, over and above the "ideal" of pure reason, a noumenon is a real thing, a thing in itself, which is not indeed known, but whose existence is postulated by practical reason in the three instances of God, freedom, and immortality. Consequently, Kant's explanation of the unity of a thing is that there is always one thing in itself causing in us many phenomena, which as understood by us are objectively valid for all our consciousnesses. What Kant never said and what his whole philosophy prevented his saying, was that a single thing is a single thought of a single consciousness; either of men, as in Fichte's philosophy, or of God and man, as in Hegel's. The passage from Kant to Hegel attempted by Green, and the harmony of Kant and Hegel attempted by Green and Caird, are unhistorical, and have caused much confusion of

thought. The success, therefore, of the works of Green and Caird must stand or fall by their Hegelianism, which has indeed secured many adherents, partly metaphysical and partly theological. Among the former we may mention W. Wallace, the translator of most of Hegel's *Encyclopædie*, who had previously learnt Hegelianism from Ferrier; W. H. Fairbrother, who has written a faithful account of *The Philosophy of Thomas Hill Green* (1896); R. L. Nettleship, D. G. Ritchie, J. H. Muirhead, J. S. Mackenzie, and J. M. E. Taggart, who closes his acute *Studies in Hegelian Cosmology* (1901) with "the possibility of finding, above all knowledge and volition, one all-embracing unity, which is only not true, only not good, because all truth and all goodness are but distorted shadows of its absolute perfection—'das Unbegreifliche, weil es der Begriff selbst ist.'" There are still to be mentioned two English Hegelians, who have not confused Kant and Hegel as Green did: namely, Simon Somerville Laurie (1829-1909) and F. H. Bradley (b. 1846), fellow of Merton College, Oxford.

Laurie wrote *Metaphysica, nova et vetusta, a Return to Dualism*, by Sirie Novarum (London, 1884; 2nd ed., 1889). His attitude to Green is expressed towards the end of his book, where he says: "The more recent argument for God which resolves itself into the necessity of a self-distinguishing one basis to which nature as a mere system of relations must be referred, is simply the old argument of the necessity for a First Cause dressed up in new clothes. Not by any means an argument to be despised, but stopping short of the truth through an inadequate analytic of knowledge." His aim is to remedy this defect by psychology, under the conviction that a true metaphysics is at bottom psychology, and a true psychology fundamentally metaphysics. He gives us a psychology founded on a proposed distinction between "attention" and reason. His theory of "attention," by which he supposes that we become conscious of objects outside ourselves, is his "return to dualism," and is indeed so like natural realism as to suggest that, like Ferrier, he starts from Hamilton to end in Hegel. As, however, he does not suppose that we have a direct perception of something resisting the organism, such as Hamilton maintained, it becomes necessary to state exactly what he means by "attention." It is, according to him, something more than sensation, but less than perception; it is common to us with lower animals; dogs; its operation is analogous to the co-ordinating sensations into an aggregate which the subject carries back to space, and thereby has a consciousness of a total object outside itself, e.g. a stone or a stick, a man or a moon. He carries its operation before reason still farther, supposing that "attention" makes particular inferences about outside objects, and that a man, or a dog, through association "attunes" sequence and invariableness of succession, and, in fact, gets as far in the direction of causation as Hume thought it possible to go at all. Laurie's view is that a dog who has no higher faculty than "attention," can go no farther; but that a man goes farther by reason. He thinks that "attention" gives us consciousness of an object, but without knowledge, and that knowledge begins with reason. His theory of "attention" brings him into contact with the German idealists: he accepts from Kant the hypothesis of synthesis and a priori categories, from Fichte the hypothesis that will is necessary to reason, from Schelling and Hegel the hypothesis of universal reason, and of an identity between the cosmic reason and the reason of man, in which he agrees also with Green and Caird. But he has a peculiar view of the powers of reason; that (1) under the law of excluded middle it states alternatives, A or B or C or D; (2) under the law of contradiction it negates B, C, D; (3) under the law of sufficient reason it says "therefore"; and (4) under the law of identity it concludes, A is A. In working out this process he supposes that reason throws into consciousness a priori categories, synthetic predicates a priori, or, as he also calls them, "dialectic percepts." Of these the most important is cause, of which his theory, in short, is that by this a priori category and the process of reason we go on from sequence to consequence; first stating that an effect may be caused by several alternatives, then negating all but one, next concluding that this one as sufficient reason is cause, and finally attaining the necessity of the causal nexus by converting causality into identity, e.g. instead of "Fire burns wood," putting "Fire is comburent, wood is combustible." Lastly, while he agrees with Kant about a priori categories, he differs from Kant in his knowledge to be got out of them. Kant, applying them only to sensations, concluded that we can know nothing beyond by their means. But Laurie, applying them to "attentions" of objects outside, considers that, though they are "reason-born," yet they make us know the objects outside to which they are applied. This is the farthest point of his dualism, which suggests a realistic theory of knowledge, different in process from Hamilton's, but with the same result. Not so: Laurie is a Hegelian, using Kant's categories, as Hegel did, to argue that they are true not only of thoughts but of things; and for the same reason, that things and thoughts are the same. At first in his psychology he speaks of the "attention"

and the rational perception of an outside object. But in his metaphysics founded thereon he interprets the outside object to mean an object outside you and me, but not self-subsistent; not outside universal reason, but only "Beint reason." He quotes with approval Schelling's phrase, "Nature is visible Intelligence and Intelligence visible Nature." He agrees with Hegel that there are two fundamental identities, the identity of all reason, and the identity of all reason and all being. Hence he explains, what is a duality for us is only a "quasi-duality" from a universal standpoint. In fact, his dualism is not realism, but merely the distinction of subject and object within idealism. Laurie's metaphysics is an attempt to supply a psychological prolaudetic to Hegelian metaphysics.

Bradley's *Appearance and Reality* (1893) is a more original performance. It proceeds on the opposite method of making Bradley metaphysics independent of psychology. "Metaphysics," says he, "has no direct interest in the origin of ideas" (254), and "we have nothing to do here with the psychological origin of the perception" (35). This metaphysical method, which we have already seen attempted by Lotze, is the true method, for we know more about things than about the beginnings of our knowledge. Bradley is right to go straight to reality, and right also to inquire for the absolute, in order to take care that his metaphysical view is comprehensive enough to be true of the world as a whole. He is unconsciously returning to the metaphysics of Aristotle in spirit; yet he differs from it *toto coelo* in the letter. His starting-point is the view that things as ordinarily understood, and (we may add) as Aristotle understood them (though with important qualifications) are self-contradictory, and are therefore not reality but appearances. If they were really contradictory they would be non-existent. However, he illustrates their supposed contradictoriness by examples, such as one substance with many attributes, and motion from place to place in one time. But he fails to show that a substance is one and many in the same respect, and that motion requires a body to be in two places at the same moment of one time. There is no contradiction (as Aristotle said) between a man being determined by many attributes, as rational, six-foot-high, white, and a father, and yet being one whole substance distinct from any other, including his own son; nor is there any contradiction between his body being in bed at 8.15 and at breakfast at 8.45 within the same hour. Bradley's supposed contradictions are really mere differences. So far he reminds one of Herbart, who founded his "realistic" metaphysics on similar misunderstandings; except that, while Herbart concluded that the world consists of a number of simple "reals," each with a simple quality but unknown, Bradley concludes that reality is one absolute experience which harmonizes the supposed contradictions in an unknown manner. If his starting-point recalls Herbart his method of arriving at the absolute recalls Spinoza. In his Table of Contents, c. xiii., on the General Nature of Reality, he says, in true Spinozistic vein, "The Real is one substantially. Plurality of Reals is not possible." In the text he explains that, if there were a plurality of reals, they would have to be beings independent of each other, and yet, as a plurality related to each other—and this again seems to him to be a contradiction. Throughout the rest of the work he often repeats that a thing which is related cannot be an independent thing. Now, if "independent" means "existing alone" and unrelated the same thing could not be at once related and independent; and, taking substance as independent in that sense, Spinoza concluded that there could only be one substance. But this is not the sense in which a plurality of things would have to be independent in order to exist, or to be substances in the Aristotelian sense. "Independent" (*χωριστόν*), or "self-subsistent" (*καθ' αὐτό*) means "existing apart," i.e. existing differently: it does not mean "existing alone," solitary, unrelated. This existing apart is the only sense in which a plurality of things need be independent in order to be real, or in order to be substances; and it is a sense in which they can all be related to each other, as I am not you, but I am addressing you. There is no contradiction, then, though Bradley supposes one, between a thing being an individual, independent, self-subsistent substance, existing apart as a

distinct thing, and being also related to other things. Accordingly, the many things of this world are not self-discrepant, as Bradley says, but are distinct and relative substances, as Aristotle said. The argument, therefore, for one substance in Spinoza's *Ethics*, and for one absolute, the Real, which is one substantially, in Bradley's *Appearance and Reality*, breaks down, so far as it is designed to prove that there is only one substance, or only one Real. Bradley, however, having satisfied himself, like Spinoza, by an abuse of the word "independent," that "the finite is self-discrepant," goes on to ask what the one Real, the absolute, is; and, as he passed from Herbart to Spinoza, so now he passes from Spinoza to Kant. Spinoza answered realistically that the one substance is both extended and thinking. Bradley answers idealistically that the one Real is one absolute experience, because all we know is experience. "This absolute," says he, "is experience, because that is really what we mean when we predicate or speak of anything." But in order to identify the absolute with experience he is obliged, as he before abused the words "contradictory" and "independent," so now to abuse the word "experience." "Experience," says he, "may mean experience only direct, or indirect also. Direct experience I understand to be confined to the given simply, to the merely felt or presented. But indirect experience includes all fact that is constructed from the basis of the 'this' and the 'mine.' It is all that is taken to exist beyond the bare moment" (248). This is to substitute "indirect experience" for all inference, and to maintain that when, starting from any "direct experience," I infer the back of the moon, which is always turned away from me, I nevertheless have experience of it; nay, that it is experience. Having thus confused contradiction and difference, independence and solitariness, experience and inference, Bradley is able to deduce finally that reality is not different substances, experienced and inferred, as Aristotle thought it, but is one absolute super-personal experience, to which the so-called plurality of things, including all bodies, all souls, and even a personal God, is appearance—an appearance, as ordinarily understood, self-contradictory, but, as appearing to one spiritual reality, somehow reconciled. But how?

3. *Other German Influences.*—Brief reference only can be made to four other English idealists who have quarried in the rich mines of German idealism: G. H. Lewes, W. K. Clifford, G. J. Romanes and Karl Pearson. Lewes (q.v.), starting from the phenomenalism of Hume, fell under the spell of Kant and his successors, and produced a compromise between G.H.Lewes, Hume and Kant which recalls some of the latter German phenomenalisms which have been described (see his *Problems of Life and Mind*). Rejecting everything in the *Kritik* which savoured of the "metempirical," he yet sympathized so far with Hegel's noumenalism as to accept the identification of cause and effect, though he interpreted the hypothesis phenomenally by saying that cause and effect are two aspects of the same phenomenon. But his main sympathy was with Fechner, the gist of whose "inner psychophysics" he adopted, without, however, the hypothesis that what is conscious in us is conscious in the all-embracing spirit of God. His phenomenalism also compelled him to give a more modified adhesion to Fechner's "outer psychophysics." It will be remembered that Fechner regarded every composite body as the appearance of a spirit; so that when, for example, molecular motion of air is said to cause a sensation of sound in me, it is really a spirit appearing as air which causes the sensation in my spirit. This noumenalism would not do for Lewes, who says that air is a group of qualities, and qualities are feelings, and motion is a mode of feeling. What, then, could he make of the external stimulus? He was obliged by his phenomenalism to say that it is only one feeling causing another in me. He ingeniously suggested that the external agent is one feeling regarded objectively, and the internal effect another feeling regarded subjectively; "and therefore," to quote his own words, "to say that it is a molecular movement which produces a sensation of sound, is equivalent to saying that a sensation of sight produces a sensation of hearing." Accordingly,

his final conclusion is that "existence—the absolute—is known to us in feeling," and "the external changes are symbolized as motion, because that is the mode of feeling into which all others are translated when objectively considered: objective consideration being the attitude of *looking* at the phenomena, whereas subjective consideration is the attitude of any other sensible response." He does not say what happens when we use vision alone and still infer that an external stimulus causes the internal sensation. But his metaphysics is an interesting example of a phenomenalist, sympathizing with nominalists so different as Hegel and Fechner, and yet maintaining his phenomenism. In this feature the phenomenism of Lewes is the English parallel to the German phenomenism of Wundt. At the same time, and under the derivative influence of Wundt, rather than the more original inspiration of Fechner, W. K. Clifford (*q.v.*) was working out the hypothesis of psychophysical parallelism to a conclusion different from that of Lewes, and more allied to that of Leibnitz, the prime originator of all these hypotheses. Clifford *W. K.* advanced the hypothesis that the supposed un-*Clifford*. conscious units of feeling, or psychical atoms, are the "mind-stuff" out of which everything physical and psychical is composed, and are also things in themselves, such as Kant supposed when he threw out the hint that after all "the *Ding-an-sich* might be of the nature of mind" (see *Mind*, 1878, p. 67). As a matter of fact, this "mind-stuff" of Clifford is far more like the "petites perceptions" of Leibnitz, from which it is indirectly derived. This hypothesis Clifford connected with the hypothesis of psychophysical parallelism. He maintained that the physical and the psychical are two orders which are parallel without interference; that the physical or objective order is merely phenomena, or groups of feelings, or "objects," while the psychical or subjective order is both a stream of feelings of which we are conscious in ourselves, and similar streams which we infer beyond ourselves, or, as he came to call them, "ejects"; that, if we accept the doctrine of evolution at all, we must carry these ejective streams of feelings through the whole organic world and beyond it to the inorganic world, as a "quasimental fact"; that at bottom both orders, the physical phenomena and the psychical streams, are reducible to feelings; and that therefore there is no reason against supposing that they are made out of the same "mind-stuff," which is the thing-in-itself. The resemblance of this nominalist idealism to that of Fechner is unmistakable. The difference is that Clifford considers "mind-stuff" to be unconscious, and denies that there is any evidence of consciousness apart from a nervous system. He agrees with du Bois-Reymond in refusing to regard the universe as a vast brain animated by conscious mind. He disagrees with Fechner's hypothesis of a world-soul, the highest spirit, God, who embraces all psychophysical processes. Curiously enough, his follower G. J. Romanes (*q.v.*) took the one step needed to bring Cliffordism completely back to Fechnerism. In his Rede Lecture on *Mind and Motion* (1885), he said that Clifford's deduction, that the *G. J.* universe, although entirely composed of "mind-stuff," *Romanes* is itself mindless, did not follow from his premisses. Afterwards, when the lecture was published in *Mind and Motion and Monism* (1895), this work also contained a chapter on "The World as an Eject," in which Romanes again contended against Clifford that the world does admit of being regarded as an eject, that is, as a mind beyond one's own. At the same time, he refused to regard this "world-eject" as personal, because personality implies limitation. He concludes that the integrating principle of the whole—the Spirit, as it were, of the Universe—must be something akin to, but immeasurably superior to, the "psychism" of man. Nothing can be more curious than the way in which a school of English philosophers, which originally started from Hume, the most sceptical of phenomenologists, thus gradually passed over to Leibnitz and Fechner, the originators of pansychistic nominalism. The Spirit of the Universe contemplated by Romanes is identical with the World-soul contemplated by Fechner.

Karl Pearson (*The Grammar of Science*, 1892, 2nd enlarged ed., 1900), starting from Hume's phenomenal idealism, has developed

views closely allied to Mach's universal physical phenomenology. What Hume called repeated sequence Pearson calls "routine" of perceptions, and, like his master, holds that cause is an antecedent stage in a routine of perceptions; while he also acknowledges that his account of matter leads him very near to John Stuart Mill's definition of matter as "a permanent possibility of sensations." His views, in his chapter on the Laws of Motion, that the physicist forms a conceptional model of the universe by aid of corpuscles, that these corpuscles are only symbols for the component parts of perceptual bodies, and that force is a measure of motion, and not its cause, are the views of Mach. At the end of this chapter he says that the only published work from the perusal of which he received any help in working out his views in 1882 and 1884, was Mach's *Die Mechanik in ihrer Entwicklung* (1883). Mach had begun to put them forward in 1872, and Kirchhoff in 1874. But they may very well have been developed independently in Germany and in England from their common source in Hume. Their point is to stretch Hume's phenomenalism so as to embrace all science, by contending that mechanism is not at the bottom of phenomena, but is only the conceptual shorthand by aid of which men of science can briefly describe phenomena, and that all science is description and not explanation. These are the views of Mach and of Pearson, as we read them in the latter's Preface. Nor can we find any difference, except the minute shade that Pearson takes up a position of agnosticism between Clifford's assertion of "mind-stuff" and Mach's denial of things in themselves.

James Ward (*q.v.*), in *Naturalism and Agnosticism* (1899), starts from the same phenomenalist views of Mach and Kirchhoff about mechanics; he proceeds to the hypothesis *James Ward*. of duality within experience, which we have traced in the phenomenisms of Schuppe, Avenarius and Wundt, and to the hypothesis of one consciousness, which appears variously in the German idealisms, not of Kant, as Ward thinks, but of Fichte, Hegel and Schuppe; and somehow he manages to end with the nominalist conclusion that Nature is God's Spirit. Though this work evinces a thoroughly English love of compromise, yet it is not merely eclectic, but is animated throughout by the inspiration of his "old teacher, Lotze." Lotze, as we saw, rejected bodily mechanism, reduced known bodies to phenomena, and concluded that reality is the life of God. Ward on the whole follows this triple scheme, but modifies it by new arguments founded on later German phenomenism.

Under the first head he attacks mechanics precisely as Mach had done (see above); if this attack had been consistently carried out it would have carried him no further than Mach. Under the second head, according to Ward, as according to Wundt, knowledge is experience; we must start with the duality of subject and object, or perpetual reality, phenomenon, in the unity of experience, and not believe, as realists do, that either subject or object is distinct from this unity; moreover, experience requires "conation" because it is interesting objects that the subject attends; conation is required for all synthesis, associative and intellectual; thinking is doing; presentation, feeling, conation are one inseparable whole; and the unity of the subject is due to activity and not to a substratum. But, in opposition to Wundt and in common with Schuppe, he believes that experience is (1) experience of the individual, and (2) experience of the race, which is but an extension of individual experience, and is variously called, in the course of the discussion, universal, collective, conceptual, rational experience, consciousness in general, absolute consciousness, intelligence, and even, after Caird, "a perfect intelligence." He regards this universal experience as the result entirely of intersubjective intercourse, and concludes that its subject is not numerically distinct from the subject of individual experience, but is one and continuous with it, and that its conceptions depend on the perceptions of individual experience. He infers the corollary that universal experience contains the same duality of subjective and objective factors without dualism. He thinks that it is the origin of the categories of causality, which he refers to "conation" and substance, which he attributes to the interaction of active subjects with their environment and to their intercourse with each other. He applies universal experience, as Schuppe does, to explain the unity of the object, and its independence of individual but not of universal experience, holding that the one sun, and the whole world of intersubjective intercourse, or the "trans-subjective" is "not independent of the universal experience, but the object of that experience" (ii. 196-197). He applies universal experience

to explain how we come, falsely in his opinion, to believe that the object of experience is an independent thing; and he uses three arguments, which are respectively those of Schuppe, Avenarius and Wundt. He supposes first, that we falsely conclude from the sun being independent of each to being independent of all; secondly, that by "introjection" we falsely conclude that another's experience is in him and therefore one's own in oneself while the sun remains outside; and thirdly, that by "reification" of abstractions, natural science having abstracted the object and psychology the subject, each falsely believes that its own abstract, the sun or the subject, is an independent thing. What, then, could we know from this "duality in experience"? He hardly has a formal theory of inference, but implies throughout that it only transcends perceptions, and perceptual realities or phenomena, in order to conclude with ideas, not facts. When we combine his view of Nature under the first head that whatever is inferred in the natural sciences is ideas, with his view of knowledge under the second that knowledge is experience, and experience, individual or universal, is of duality of subject and object in the unity of experience, it follows that all we could know from the data would be one experience of the race, one subject consisting of individual subjects, and in Nature single objects in the unity of this universal experience; and beyond we should be able to form conceptions dependent on the perceptions of individual experience in the unity of universal experience: that is all. There can be no doubt that Mach, Schuppe and Wundt drew the right phenomenalist conclusions from such phenomenalist data. Not Ward who proceeds to a Natural Theology on the ground that "from a world of spirits to a Supreme Spirit is a possible step." He had definitely confined universal experience to the one experience of the race. But perhaps Caird's phrase "a perfect intelligence" has beguiled him into thinking that the one subject of universal experience is not mere mankind, but God Himself. Under the third head, however, his guide is Lotze. The argument may be shortly put as follows: As the Nature which is the object of mechanics and all natural sciences is not natural substances, but phenomena and ideas; as mass is not substance, and force is not activity; as activity is not in the physical but in the psychical world; as the laws of Nature are not facts but teleological conceptions, and Nature is teleological, as well as not mechanical but kinematical; as the category of causality is to be referred to "conation"; as, in short, "mind is active and matter inert," what then? One subject of universal experience, one with the subjects of individual experience, you would suppose, and that Nature as a whole is its one object. Not so, according to Ward; but "God as the living unity of all," and "no longer things, but the connecting conserving acts of the one Supreme. What, then, is the relation of God to the unity of universal experience, the experience of the race, which was under the second head the unity in duality of all knowledge? He does not say. But instead of any longer identifying the experience of the race and universal experience, he concludes his book by saying "our reason is confronted and determined by Agnosticism." This is his way of destroying Naturalism and Agnosticism.

4. *Personal Idealism*.—The various forms of idealism which have been described naturally led in England, even among idealists themselves, to a reaction against all systems which involve the denial of personality. English moral philosophy cannot long tolerate a metaphysics which by merging all minds in one would destroy personality, personal causation and moral responsibility, as James Martineau well said. A new school, therefore, arose of which the protagonist was Andrew Seth Pringle-Pattison (b. 1856; professor of logic and metaphysics at Edinburgh University from 1880) in his *Scottish Philosophy* (1885), and *Hegelianism and Personality* (1887).

"Each of us is a self," he says, and in another passage, "The real self is one and indivisible, and is unique in each individual. This is the unequivocal testimony of consciousness." What makes his vindication of conscious personality all the more interesting is that he has so much in common with the Hegelians; agreeing as he does with Hegel that self-consciousness is the highest fact, the ultimate category of thought through which alone the universe is intelligible, and an adequate account of the great fact of existence. He agrees also that there is no object without subject. It is difficult to see exactly where he begins to differ from Hegel; but at any rate he believes in different self-conscious persons; he does not accept the dialectical method, but believes in beginning from the personal experience of one's own self-consciousness; and, though that he is not very clear on the subject, he would have us see that a thing, such as the sun, is a different object in each person's consciousness. He is not a systematic thinker, but is too much affected by the eclectic notion of reconciling all philosophies. F. C. S. Schiller (b. 1864, fellow of Corpus Christi College, Oxford), in *Riddles of the Sphinx* (1891), is a more systematic thinker. He rejects the difference between matter and spirit. He agrees with Leibnitz in the analysis of the material into the immaterial, but with

Lotze in holding that the many immaterial elements coexist and interact. At the same time he differs from Lotze's conclusion that their union requires one absolute substance. Again, he thinks that substance is activity; differing from both Leibnitz and Lotze herein, and still more in not allowing the existence of the many beyond experience. Hence his personal or pluralistic idealism is the view that the world is a plurality of many coexisting and interacting centres of experience, while will is the most fundamental form of experience. In connexion with these views reference should be made to a work entitled *Personal Idealism, Philosophical Essays by Eight Members of the University of Oxford* (1902), edited by H. Sturt, and numbering Schiller, as well as G. F. Sturt, H. Rashdall and others among its contributors (cf. also H. Sturt, *Idola theatri*, 1908). They do not all agree with one another, or perhaps even with the title. Nevertheless, there is a common tendency in them, and in the university of Oxford, towards the belief that, to use the words of the editor, "We are free moral agents in a sense which cannot apply to what is merely natural." There is indeed much more activity of thought at Oxford than the world suspects. Mansel and Jowett, Green and Caird, Bradley and Bosanquet arose in quick succession, the predecessors of a generation which aims at a new metaphysics. The same sort of antithesis between the one and the many has appeared in the United States. Josiah Royce (b. 1855, professor of philosophy, Harvard) believes in the absolute like Green and Bradley, in "the unity of a single self-consciousness, which includes both our own and all finite conscious meanings in one final eternally present insight," as he says in *The World and the Individual* (1900; see also later works). G. T. Ladd (q.v.) also believes in "a larger all-inclusive self," and goes so far as the paradox that perfect personality is only reconcilable with one infinite being. While Royce is Hegelian, Ladd prefers Lotze, but both believe in one mind. William James (q.v.), on the other hand, in his psychological works shows that the tendency of recent psychology is to personality, interpreted idealistically; though without a very clear appreciation of what a person is, and personality means. By a curious coincidence, almost at the same time of the appearance of the *Essays on Personal Idealism*, an American writer, G. H. Howison, published *The Philosophy of Immanence, and other Essays illustrating the Metaphysical Theory of Personal Idealism* (1901). In fact there has been an increase of philosophical intercourse between English and American universities, which is a hopeful sign of progress.

The advent of personal idealism is a welcome protest against the confusion of God and man in one mind, and against the confusion of one man's mind with another's. The school undoubtedly tends towards realism. I am conscious only of myself as a person, and of my bodily signs. I know the existence of other human persons and minds only through their giving similar bodily signs. If the personal idealist consistently denies other bodies, then the bodily signs become, according to him, only part of his experience, which can prove only the existence of himself. To infer another mind he must infer another body, and the bodily environment including his and other bodies. Again, in being conscious of myself, I am not conscious of my mind in the abstract without my body. I cannot separate touching from my tactile organs, seeing from my eyes, or hearing from my ears. I cannot think my body away. Moreover, I am not conscious of my whole personal life at all. How do I know that I was born, though I cannot remember it, and that I shall die, though I am not now conscious of death? How do I know that I am the same person from birth to death? Not by my consciousness, but by knowing the bodies of others—of babies on the one hand, and of old men on the other hand. It is usual to say that the body has not enough unity to be part of the person: the objection is much more true of conscious mind. The truth is that not the unity of consciousness but the fact of its existence is the important point. The existence of my consciousness is my evidence for my soul. But it does not prove that I am nothing but soul. As a human person, I am body and soul; and the idealistic identification of the Ego with soul or mind, involving the corollary that my body belongs to the non-Ego and is no part of myself, is the *reductio ad absurdum* of idealism. Lastly, though the personal idealists are right in rejecting the hypothesis of one mind, they are too hasty in supposing that the hypothesis is useless for idealistic purposes. No idealism can explain how we all know one sun, except by supposing that we all have one mind. The difficulty of personal idealism, on the other hand, is to reconcile the unity of the thing with the plurality of thinkers. The unity of the sun can only be explained either idealistically

¹ For Dr Schiller's views, see further PRAGMATISM.

by supposing it to be one object of one mind, or realistically by supposing it to be one thing distinct from the many minds which think about it. The former alternative is false, the latter true. Personal idealism, therefore, must end in personal realism.

7.—REALISM

1. *Metaphysical and Psychological Realism.*—Realism is the view that some known things are bodily, and some are mental. At its best, it is the Aristotelian view that both are substances. The modern misunderstanding of "substance" has been a main cause of the confusion of modern thought. Aristotle meant by it any distinct thing; e.g. I, you, an animal, a plant, the earth, the moon, the sun, God. He calls each of these, as existing apart, a thing *per se* (*καθ' αὐτό*). It is true that, having divided a natural substance into form and matter, he called each element "substance." But these are not primary meanings; and matter, or supposed substratum, in particular, he says, is not actually substance (*Met. Z 3*) or is only potentially substance (*Met. H 1-2*). In modern times, Spinoza, by a mere mistake, changed the meaning of "substance" from "existing apart" to "existing alone," and consistently concluded that there is only one. Locke mistook it to mean "substratum," or support of qualities, and naturally concluded that it is unknown. Kant, taking it in the mistaken meaning of Locke, converted it into the a priori category of the permanent substrate beneath the changes of phenomena, and even went so far as to separate it from the thing in itself, as *substantia phenomenon* from *noumenon*. When it had thus lost every vestige of its true meaning, Kant's successors naturally began to speak of things as being distinct without being substances. Fichte began this by saying that ego is activity, and being is life. Hegel said that spirit is not substance but subject, which to Aristotle would have meant that it is not a distinct thing, yet is a distinct thing. Fechner, Wundt and Paulsen have fixed the conclusion in psychology that soul is not substance but unity of mental life; and Wundt concludes from the modern history of the term that substance or "substrate" is only a secondary conception to that of causality, and that, while there is a physical causality distinct from that of substance, psychical causality requires no substance at all.

The result of this confusion is that the moderns have no name at all for a distinct thing, and, being mere slaves of abstract terms, constantly speak of mere attributes, such as activity, life, will, actuality, unity of mental operations, as if they were distinct things. But an attribute, though real, is not a distinct reality, but only a determinant of a substance, and has no being of its own apart from the substance so determined; whereas a substance, determined by all its attributes, is different from everything else in the world. Though, for simplicity and universality of thought, even in science, we must use the abstraction of attributes, and, by the necessity and weakness of language, must signify what are not substances by nouns substantive, we must guard against the over-abstraction of believing that a thing exists as we abstract it. The point of true realism is Aristotle's point that the world consists of such distinct, though related, things, and therefore of substances, natural and supernatural. Again, the method of true realism is that of Aristotle, and consists in recognizing the independence of metaphysics. The contrary method is psychological metaphysics, which makes metaphysics dependent on psychology, on the ground that the origin of knowledge determines its limits. This is the method which, as we have seen, has led from psychological to metaphysical idealism, by the argument that what we begin by perceiving is mental, and, therefore, what we end by knowing is mental. Now, there is no principle of method superior to that of Aristotle—we must begin with what is known to us. The things best known to man are the things which he now knows as a man. About these known things there is some agreement: about the beginnings of knowledge there is nothing but controversy. We do not know enough about the origin of knowledge to determine its limits. Hence, to proceed from psychology to metaphysics is to proceed from the less to the more known; and the

paradoxes of psychological have caused those of metaphysical idealism.

The realist, then, ought to begin with metaphysics without psychological prejudices. He must ask what are known things, and especially what has been discovered in the sciences; in mechanics, in order to find the essence of bodies which is neglected by idealism; in mental science, in order to understand consciousness which is neglected by materialism. With the conviction that the only fair way of describing metaphysics has been to avoid putting forward one system, and even to pay most attention to the dominant idealism, we have nevertheless been driven occasionally to test opinions by this independent metaphysical method. The chief results we have found against idealism are that bodies have not been successfully analysed except into bodies, as real matter; and that bodies are known to exert reciprocal pressure in reducing one another to a joint mass with a common velocity by being mutually impenetrable, as real forces. The chief results we have found against materialism are that bodies evolving account neither for the origin of themselves, their nature, and their fundamental order of resemblance and difference, nor for the nature and origin of consciousness, nor even as yet for their becoming good for conscious beings. Hence we come to the realistic conclusions that among known substances some are bodies, others are souls; that man is body and soul; and that God is a pure soul or spirit. At the same time, while the independence of metaphysics leads us to metaphysical realism, this is not to deny the value of psychology, still less of logic. Besides the duty of determining what we know, there is the duty of determining how we know it. But in order to discharge it, a reform of psychology as well as of metaphysics is required. Two psychological errors, among many others, constantly meet us in the history of idealism—the arbitrary hypothesis of a sense of sensations, or of ideas, and the intolerable neglect of logical inference. Logical inference from sense is a process from sensible to insensible existence. The former error needs something deeper than a Kantian critique of reason, or an Avellanian criticism of experience; it needs a criticism of the senses. We want an answer to this question—What must we know by the senses in order to enable us to know what we infer by reason in the sciences? Without here aiming at exhaustiveness, we may bring forward against the dominant idealism a psychological theory of sense and reason. By touch I perceive one bodily member reciprocally pressing another in myself, e.g. lip pressing lip; by touch again I perceive one bodily member similarly pressing but not another member in myself, e.g. only one lip pressing; by inference from touch I infer that it is reciprocally pressing another body similar to my other bodily member, i.e. another body similar to my other lip. On this theory, then, founded on the conscious facts of double and single pressure in touch, and on the logic of inference, we have at once a reason for our knowledge of external bodies, and an explanation of the early appearance of that knowledge. The child has only to have its mother's nipple in its mouth in order to infer something very like the mutually pressing parts of its own mouth. Having thus begun by touch and tactile inference, we confirm and extend our inferences of bodies in Nature by using the rest of the senses. This is not to forget that the five senses are not our whole stock or to confine inference to body. We have also the inner sense of consciousness which is inexplicable by body alone. By combining, moreover, our knowledge of Nature with our consciousness of our own works, we can infer that Nature is a work of God. Next, finding that He gives signs of bodily works, but no signs of bodily organs, we can infer that God is a Spirit. Finally, returning to ourselves, we can conclude that, while the conscious in God is Spirit without Body, in us it is spirit with body. This final distinction between bodily and spiritual substances we owe to Descartes.

2. *The Undercurrent of Modern Realism.*—Coming after the long domination of Aristotelian realism, Descartes and Locke, though psychological idealists, were metaphysical realists. Their position was so illogical that it was easily turned into metaphysical idealism. But their psychological method and

idealism produced another mistake—the tendency to a modicum of realism, as much as seemed to this or that author to follow from psychological idealism. In Germany, since the victory of Kant over Wolff, realism has always been in difficulties, which we can appreciate when we reflect that the Germans by preference apply the term "realism" to the paradoxes of Herbart (1776-1841), who, in order to avoid supposed contradictions, supposed that bodies are not substances, but show (*Schein*), while "reals" are simple substances, each with a simple quality, and all preserving themselves against disturbance by one another, whether physically or psychologically, but not known to be either material or spiritual because we do not know the simple quality in which the nature of the real consists. There have indeed been other realisms in Germany. Trendelenburg (1802-1872), a formidable opponent of Hegel, tried to surmount Kant's transcendental idealism by supposing that motion, and therefore time, space and the categories, though a priori, are common to thought and being. Dühring, with a similar object, makes matter a common basis. While these realisms come dangerously near to materialism, that of the Roman Catholic A. Günther (1783-1863), "Cartesius correctus," erected too mystical an edifice on the psychological basis of Descartes to sustain a satisfactory realism. Yet Güntherism has produced a school, of which the most distinguished representative is the Old Catholic bishop in Bonn, Th. Weber, whose *Metaphysik*, completed in 1891, starting from the ego and the analysis of consciousness, aims at arriving at the distinction between spirit and nature, and at rising to the spirit of God the Creator. Other realistic systems are those of J. H. von Kirchmann (1802-1884), author, among other works, of *Die Philosophie des Wissens* (1864) and *Ueber die Principien des Realismus* (1875); Goswin Uphues (b. 1841; professor of philosophy at Halle), directed against the scepticism of Shute's *Discourse on Truth*; and Hermann Schwarz (born 1864), who completes the psychological view of Uphues that we can know objects as they are, by the metaphysical view that they can be as we know them. But German realism lacks critical power, and is little better than a weed overshadowed by the luxuriant forest of German idealism.

In France, the home of Cartesian realism, after the vicissitudes of sensationalism and materialism, which became connected in the French mind with the Revolution, the spirit of **French Realism**. Descartes revived in the 19th century in the spiritualistic realism of Victor Cousin. But Cousin's psychological method of proceeding from consciousness outwards, and the emphasis laid by him on spirit in comparison with body, prevented a real revival of realism. He essayed to answer Locke by Kant, and Kant by Reid, Maine de Biran and Schelling. From Reid he adopted the belief in an external world beyond sensation, from Biran the explanation of personality by will, from Schelling the identification of all reason in what he called "impersonal reason," which he supposed to be identical in God and man, to be subjective and objective, psychological and ontological. We start, according to him, from a psychological triplicity in consciousness, consisting of sensation, personal will and impersonal reason, which by a priori laws of causality and substance carries us to the ontological triplicity of oneself as ego willing, the non-ego as cause of sensation, and God as the absolute cause beneath these relative causes. So far this ontological triplicity is realism. But when we examine his theory of the non-ego, and find that it resolves matter into active force and this into animated activity, identifies law with reason, and calls God absolute substance, we see at once that this spiritual realism is not very far from idealism. About 1840, owing largely to the teaching of E. Saisset in the spiritualistic school, the influence of Descartes began to give way to that of Leibnitz. Leibnitz has been used both realistically and idealistically in France. He was taken literally by spiritual realists, e.g. by Paul Janet (*q.v.*). Janet accepted the traditional ontological triplicity—God, souls and bodies—and, in answer to Ravaisson, who called this realism "demi-spiritualisme," rejoined that he was content to accept the title. At the same time, like Cousin, his works show a tendency to understate body, tending as they do to the Leibnitzian analysis of the material into the immaterial, and to the supposition that

the unity of the body is only given by the soul. His emphasis is on spirit, and he goes so far as to admit that "no spiritualist is engaged to defend the existence of matter." The strength of Janet's position is his perception that the argument from final causes is in favour of an omnipresent rational will making matter a means to ends, and not in favour of an immanent mind of Nature working out her own ends.

The psychological metaphysics of Cousin and of Janet was, however, too flimsy a realism to withstand its passage into this very idealism of matter which has become the dominant French metaphysics. Etienne Vacherot (*q.v.*) deserted Descartes for Hegel. He accepted from Hegel "the real is rational" without the Hegelian method, for which he substituted conscious experience as a revelation of the divine. Matter he held to be mind at the minimum of its action, and evolution the "expansion de l'activité incessante de la cause finale." God, according to his latest view, is the absolute being at first cause and final end. "Let us leave," says he in deference to Janet, "the category of the ideal, which applies to nothing real or living." But the most noticeable passage in *Le Nouveau spiritualisme* (1884) is its contrast between the old and the new; where he says that the old spiritualism opposed spirit to matter, God to Nature, the new spiritualism places matter in spirit, Nature in God (p. 377). F. Ravaisson (see RAVAISSON-MOLLINÉ), in his *Rapport* (prepared for the Exhibition of 1867) on philosophy in France, gave a fresh impulse to the transition from spiritual realism to idealism, by developing the Aristotelian *poiesis* of matter and the Leibnitzian separation of monads into "l'amour" as the very being of things. Jules Lachelier (born 1832) agreed with Ravaisson that beauty is the last word of things, but, under the influence of Kant and his successors, put his idealism rather in the form that all is thought. A. Fouillée (*q.v.*) rightly objects that we must not thus impute thought and intention to Nature, and yet does not scruple to impute to it life, sensation and want. Starting from consciousness, he argues that all known things are phenomena of consciousness. Then, agreeing with evolutionism, that things are necessarily determined by forces, but with Leibnitz that body is merely passive, he infers that force, being active, is psychical, so that he describes as "idéoforce" and as "soul-vivure." In connection with the "idées directrices et organiques," supposed by the French physiologist Claude Bernard, and the universal will supposed by German voluntarists, Fouillée concludes that the world is a society of wills. Meanwhile, more under the influence of Kant, C. B. Renouvier (*q.v.*) has worked out an idealism which he calls "Néo-criticisme," rejecting the thing-in-itself, while limiting knowledge to phenomena constituted by a priori categories. Phenomena he identifies with "representations représentatives et représentées." But he takes the usual advantage of this most ambiguous of terms when he extends to freedom, God, freedom and immortality required by the moral law. In his later work, *La Nouvelle monadologie* (1899), he maintains that each monad is a simple substance, endowed with representation, which is consciousness in form, phenomenon in matter as represented. In order to explain free will, he supposes, contrarily to Fouillée, that the laws of phenomena are indeterminate, contingent and liable to exceptions. Here we trace the influence of Leibnitz and Lotze, which is still more marked in *La Contingence des lois de la nature* (1874), by E. Boutroux. Fouillée meets the mechanics of evolution by the argument that will to live determines its necessary laws. Boutroux by denying the necessity. His *point* is, that the world only appears to be phenomena governed by necessary laws, and is really a spontaneity which makes new beginnings, such as life and consciousness, tending to good. These examples are enough to show that the psychological metaphysics of spiritual realism has not been able to withstand the rise and progress of spiritual idealism in France.

In England, the land of Bacon and Locke, the realistic tendency has been more active, and is exhibited in Bacon's *Novum organum* and *De Augmentis scientiarum*, *English Realism*, as well as to a less degree in the Fourth Book of Locke's *Essay*. After the metaphysical idealism, begun by Berkeley, had eventuated in Hume's reduction of the objects of knowledge to sensations, ideas and associations, the Scottish school, applying the Baconian method to the study of mind, began to inquire once more for the evidences of our knowledge, and produced the natural or intuitive realism of T. Reid, Dugald Stewart and Sir William Hamilton, who, having been followed by H. L. Mansel, as well as by J. Veitch, H. Calderwood and J. M'Cosh, prolonged the existence of the school, in which we may venture to place L. T. Hobhouse and F. W. Bain, author of *The Realisation of the Possible* (1899), down to our own time.

Its main tenet, that we have an immediate perception of the external world, is roughly expressed in the following words of Reid: "I do perceive matter objectively—that is, something

which is extended and solid, which may be measured and weighed, is the immediate object of my touch and sight. And this object I take to be matter, and not an idea. And, though I have been taught by philosophers that what I immediately touch is an idea, and not matter, yet I have never been able to discover this by the most accurate attention to my own perceptions." No opposition to idealism could be more distinct. Reid, however, did not always express himself so distinctly. Moreover, he and his successors mixed up so many accidents with the essence of their reality that the whole system broke down under its own weight. Their psychology contained valuable points. It also contained much that was doubtful, and much that was ill-adapted to the metaphysics of realism. Yet they thought it the only avenue to metaphysics. It is full of appeals to common sense, and of principles of common sense, which Reid also called intuitive first principles, and self-evident truths. It is spoilt by Locke's hypothesis that we do not perceive things but qualities implying things. While it asserted a realism of individuals, it admitted a conceptualism of universals. Stewart also said that our knowledge of matter and mind is merely relative. Hamilton went still further; he tried to combine the *obj. of Reid* with the water of Kant; and converting the intuitive into the *a priori*, he found a further reason **Hamilton.** for the relativity of knowledge. "Our knowledge is relative," said he, "first, because existence is not cognizable absolutely and in itself, but only in special modes; second, because these modes thus relative to our faculties are presented to and known by the mind, only under modification, determined by these faculties themselves." Not only so, but in his review of Cousin ("Philosophy of the Unconditioned," in *Discussions*, pp. 12-15), he made conception the test of knowledge, argued that "the mind can conceive, and consequently can know, only the limited, and the conditionally limited," that "to think is to condition," that all we know either of mind or matter is "the phenomenal," that "we cannot in our highest generalizations rise above the finite," and concluded that we cannot conceive or know the unconditioned, yet must believe in its existence. Nevertheless, in spite of all this Kantism, he adhered to his natural realism. He vacillated a great deal about our mode of perceiving the external world; but his final view (edition of Reid's works, note D*) consisted in supposing that (1) sensation is an apprehension of secondary qualities purely as affections of the organism viewed as ego; (2) perception in general is an apprehension of primary qualities as relations of sensations in the organism viewed as non-ego; while (3) a special perception of a so-called "secundo-primæ" quality consists in "the consciousness of a resisting something external to our organism." Hamilton's views both on the absolute and on perception affected Mansel and Spencer. They were not, however, received without question even by his followers. H. Calderwood, in his *Philosophy of the Infinite* (1854), made the pertinent objection that, though thought, conception and knowledge are finite, the object of thought may be infinite. Hamilton, in fact, made the double mistake of limiting knowledge to what we can conceive, and confusing the determinate with the finite or limited. We never know anything except as determined by its attributes; but that would not prevent us from inferring something determined as unconditioned, whether infinite or absolute. J. McCosh again, in *The Prevailing Types of Philosophy: Can they logically reach reality?* (1891), rightly protests against Hamilton's combination of Scottish and German schools which will not coalesce, and exhorts the former "to throw away its crutches of impressions, instincts, suggestions, and common sense, and give the mind a power of seeing things directly." He has the merit of presenting natural or intuitive realism in its purity.

The common tenet of the whole school is that without inference we immediately perceive the external world, at all events as a resisting something external to our organism. But is it true? There are three reasons against it, and for the view that we perceive a sensible object within, and infer an external object without, the organism. In the first place, there are great differences between the sensible and the external object; they differ in secondary qualities in the case of all the senses; and even in the case of touch, heat felt within is different from the vibrating heat outside. Secondly, there are so-called "subjective sensations," without any external object as stimulus, most commonly in vision, but also in touch, which is liable to formation, or the feeling of creeping in the skin, and to horription, or the feeling of bristling in the hair; yet, even in "subjective sensations," we perceive something sensible, which, however, must be within, and not outside, the organism. Thirdly, the external world and the senses always act on one another by cause and effect and by pressure, although we only feel pressure by touch. Now, when the thing with which touch is in a state of reciprocal pressure is external, e.g. a table, we feel our organism pressed and pressing; we do not feel the table pressing and

pressed, but infer it. The Scottish School never realized that every sensation of the five senses is a perception of a sensible object in the bodily organism; and that touch is a perception, not only of single sensible pressure, but also of double sensible pressure, a perception of our bodily members sensibly pressing and pressed by one another, from which, on the recurrence of a single sensible pressure, we infer the pressure of an external thing for the first time. Intuitive Realism is to be replaced by Physical Realism.

3. *Reaction to Hypothetical Realism.*—The three evidences, which are fatal to intuitive realism, do not prove hypothetical realism, or the hypothesis that we perceive something mental, but infer something bodily. This illogical hypothesis, which consists of incautiously passing from the truth that the sensible object perceived is not external but within the organism to the *non-sequitur* that therefore it is within the mind, derived what little plausibility it ever possessed from three prejudices: the first, the scholastic dogma that the sensible object is a *species sensibilis*, or immaterial sensible form received from the external thing; the second, the Cartesian *a priori* argument that the soul as thinking thing can perceive nothing but its own ideas; the third, the common assumption of a sense of sensations. But notwithstanding its illogicality, its tendency to underrate Nature as inferred from such idealistic premises, and its certain transition into a consistent idealism, hypothetical realism has, with little excuse, revived among us in the writings of Shadworth Hodgson, James Martineau and A. J. Balfour. The cause of this anachronism has been the failure of intuitive realism and the domination of idealism, which makes short-sighted men suppose that at all events they must begin with the psychology and the psychological idealism of the day, in the false hope that on the sands of psychological idealism they may build a house of metaphysical realism.

Shadworth Holloway Hodgson (born 1832; hon. fellow of Corpus Christi College, Oxford), whose chief work is *The Metaphysics of Experience* (4 vols., 1898), believing **Hodgson.** that philosophy is an analysis of the contents of consciousness, or experience, and that this is metaphysics, begins, like Kant, with an analysis of experience. Like Kant, he supposes that experience is concerned with sensations, distinguishes matter and form in sense, identifies time and space, eternal time and infinite space, with the formal element, and substitutes 'synthesis of sensations of touch and sight for association and inference, as the origin of our knowing such a solid material object as a bell. Although he does not agree with Kant that either the formal element in sense or the synthesis of sensations is *a priori*, yet in very Kantian fashion, through not distinguishing between operation and object, he holds that, in synthetically combining sensations of touch and sight, we not only have a complex perception of a solid body, but also know this "object thought of" as itself the complex of these sensations objectified. Hence he concludes that "*mater* is the name for the sensation-elements derived from both senses, abstracting in thought, so far as possible, from the extension-elements of both" (i. 296).

Here you would expect him to stop, as the German Neo-Kantism of Lange stops, with the consistent conclusion that all we know of Nature from such data is these complexes of sensation-elements, or phenomena in the Kantian meaning. Not so; like Kant himself, Hodgson supposes something beyond; not, however, an unknown thing, in itself causing sensations, but a condition, or *sine qua non*, of their existence, without being a cause of their nature. In order to make this leap he supposes that we have beyond perceptions a conception of condition. His account of the origin of this conception is puzzling. (i. 380.) Whatever its origin may be, it could not, any more than a Kantian category of cause, justify us in concluding anything more than a relation of perceptions as conditions of one another, seeing that they were supposed to be the whole data, and matter itself to be "sensation-elements." But what he proceeds to suppose is that, having the conception, and finding that the complex of perceptions needs accounting for, we infer a real condition, e.g. the solid interior of a bell. What we know, however, of this condition, according to him, has two limits: on the one hand, it is the condition only of the existence of our perceptions; on the other hand, all we know of its nature is our perceptions. Matter thus, which had at first been defined as a complex of perceptions objectified, now turns

out to be a condition without which perceptions would not exist, but whose nature is known only as a complex of perceptions. Finally, according to him, having inferred matter as the condition of our perceptions, we are entitled to infer that the condition of the existence of matter is God, whose nature, however, can be inferred only by practical reason from conscience. He avers that this "metaphysic of experience" is not idealism, or the tenet that consciousness is the only reality. It is realism—but inconsequent and inadequate realism, something like that of Spencer; according, indeed, to more knowledge of the distinction between Nature as condition of sensations and God as condition of Nature; but very like in holding that all we know of natural forces is our perceptions. We know more, however, about a body, such as a bell, than either Spencer or Hodgson allows. We know, from the concomitant variations between its vibrations and our perceptions, that its vibrations are not mere conditions but real causes of our perceptions; and that those vibrations are not our perceptions, because we cannot perceive them, but are real attributes of the bell. It will be objected that they are merely possible perceptions. But as they really produce our real perceptions, they are themselves not merely possible, but real or actual. A possible cause could not actually produce an actual effect.

James Martineau (*q.v.*) in *A Study of Religion* (1888), like Shadworth Hodgson, started from Kant, and tried to found on *Martineau's* transcendental idealism "a return to dualism." If

there is one thing certain in the Kantian philosophy, it is its author's perception that what is contributed by mind must not be extended to things beyond mind. Hegel only extended a priori forms to things by resolving things into thoughts. Mill also protested "against adducing, as evidence of the truth of a fact in external nature, the disposition, however strong or however general, of the human mind to believe it." Yet Martineau adopted, as his view of the limits of human intelligence, that Kant was right in making space and time a priori forms of sense, but wrong in limiting them to sensations. But in order to make space a form of external things, Martineau had to take the external in space, by which Kant meant one sensation out of another, in the very different meaning of the self here and the not-self there. He facilitated this awkward transition by adding to Kant's a priori forms of space and time an "a priori form of alternative causality," or, as he also called it, "an intuition of causality involved in the elementary exercise of perception," which is the key to his whole philosophy. He supposed that this intuition of causality arises when will is resisted, and, further supposing that causality requires decision between alternatives, concluded that the intuition of will resisted is an intuition of will against will, mine against other (i. 65). To pass over its confusion of a priori and intuitive, there are two fatal objections to this view. In the first place, the intuition of causality does not require will at all, because we often perceive one bodily member pressing another involuntarily; a man suffering from lockjaw neither wills nor can avoid feeling the pressure of his upper and lower jaws against one another. Secondly, though causality requires alternatives in the material cause, e.g. wax may or may not be melted, the determination between them is not always a decision of will, but in physical causation depends on the efficient cause, e.g. the fire: as Aristotle says, when the active and passive powers approach, the one must act and the other suffer, and it is only in rational powers that will decides (*Met.* 5).

A. J. Balfour, in *The Foundations of Belief, being Notes Introductory to the Study of Theology* (1895), begins by maintaining

A. J. Balfour. that the evidence of the senses is not a foundation of belief, and then expects us to believe in Nature and in God. He revives the "Acatalepsia" of the New Academy. In Part II., ch. i., he makes three assumptions about the senses, and, without stopping to prove them, or even to make them consistent, deduces from them his thesis that the evidence of the senses is not a foundation of belief in Nature. He first assumes an immediate experience of a body, e.g. a green tree; and then deduces that the evidence of the senses proves now and then to be fallacious, because we may have an experience indistinguishable from that of a tree but incorrect; and further, that our perceptions are habitually mendacious, because all visual experiences are erroneous, as colour is a sensation while the thing consists of uncoloured particles. This argument from a pure assumption is a confusion of sense and

inference. In no case is the evidence of the senses fallacious or mendacious; the fallacy is in the inference.

He next assumes that we have no immediate experience of independent things—that sense perceives sensations, feelings, or ideas; while all else, e.g. a tree, is a matter of inference. On this quite new assumption of a sense of sensations he deduces that, from a perception of these mental facts, we could not infer material facts, e.g. a tree; so that again the evidence of the senses does not afford trustworthy knowledge of the material universe. His deduction is logical; but he has forgotten to prove the assumption, and now confuses sensory operation with sensible object. Vision does not perceive a sensation of colour; it perceives a visible picture, e.g. green, which is in the organism, but has never been proved to be a mental fact, or not to be a material fact. So touch perceives not a sensation of pressure, but a pressure which is a material fact in the organism. From a material pressure within we logically infer a material pressure outside. He thirdly assumes an appendix to the second assumption: he assumes that sense perceives mental sensations with succession but without causality, because no kind of cause is open to observation. On this assumption of a sense of sensations, but not of causality, he deduces that we could not from such data infer any particular kind of cause, or a bodily cause, e.g. a tree, or indeed any cause at all, or any event beyond perception, without assuming the principle of causation that Nature is uniform in cause and effect over great intervals of time and space. Nevertheless he gives absolutely no proof of the assumption that there is no sense of causality. There is none in the subsidiary senses, because none of them perceives the pressures exerted on them. But the primary sense of touch perceives one bodily member causing pressure on another, reciprocally, within the organism, from which we infer similar particular pressures caused between the organism and the external world; but without needing the supposed stupendous belief and assumption of the uniformity of Nature, which is altogether ignored in the inferences of the ordinary man. Finally, as touch perceives reciprocal pressure within, and tactile inference infers it without, touch is the primary evidence of the senses which is the foundation and logical ground of our belief in Nature as a system of pressing bodies. Balfour, however, having from unproved assumptions denied the evidence of the senses, and the rational power of using them to infer things beyond oneself, has to look out for other, and non-rational, foundations of belief. He finds them in the needs of man. According to him, we believe in Nature because it satisfies our material needs, and in God because he satisfies our spiritual needs. But bare need, e.g. a pang of hunger, is no cause of belief beyond itself; and desire, or need of something prospective, e.g. a desire of food, is effect, not cause, of a previous belief that there is such a thing, and of a present inference that it may again be realized. Moreover, when the belief or inference is uncertain, need even in the shape of desire is not in itself a foundation of belief in the thing desired: to need a dinner is not to believe in getting it; and, as Aristotle said, "there is a wish for impossibilities." It is fair, however, to add that Balfour has a further foundation for the belief in Nature, the survival of the fittest, by which those only would survive who possessed and could transmit the belief. But here he fails exactly as Darwin himself failed. Darwin said, given that organisms are fit, they will tend to survive; but he failed to show how they become fit. Balfour says, given that men believe in Nature, they will survive; but he fails to show how they come to believe in it. Inference from sense is the one condition of all belief in anything beyond oneself, whether it be Nature, or Authority, or God; and it is the one condition of all needs, which are not mere feelings, but desires of things. The result of undermining this sure foundation emerges in Balfour's attitude to the beliefs themselves. He holds that space, time, matter, motion, force, are all full of the insoluble contradictions supposed by Spencer; and that all our beliefs, in Nature and in God, stand on the same footing of approximations. Hence his really valuable arguments from Nature to God sink to the problematic form—there may be Nature; if so, there is God.

Such is the modern "Acatalepsia," which arises from denying the evidence of the senses, and from citing the transfigured realism of Spencer instead of the original realism of Aristotle, about whom Balfour speaks as follows: "It would be difficult, perhaps impossible, to sum up our debts to Aristotle. But assuredly they do not include a tenable theory of the universe."

4. *The Past and Future of Metaphysics.*—Aristotelian realism is the strong point of Roman Catholic philosophy. As interpreted by Thomas Aquinas, it is now in danger of becoming a dogma. In 1879 Pope Leo XIII. addressed to the bishops the *Encyclical aeterni patris*, which contained the words, "Sancti Thomae sapientiam restituitis et quam latissime propagetis." From the Roman Catholic point of view this reaction to "Thomism" was a timely protest against modern metaphysics. It was founded upon a feeling of uneasiness at a growing tendency among Roman Catholic writers not only to treat theology freely, but to corrupt it by paradoxes. One cannot but feel regret at seeing the Reformed Churches blown about by every wind of doctrine, and catching at straws now from Kant, now from Hegel, and now from Lotze, or at home from Green, Caird, Martineau, Balfour and Ward in succession, without ever having considered the basis of their faith; while the Roman Catholics are making every effort to ground a Universal Church on a sane system of metaphysics. However this may be, the power of the movement is visible enough from the spread of Thomism over the civilized world, and in England from the difference between the freer treatment of metaphysics by some Roman Catholic writers and that which has arisen under the immediate influence of Thomism. J. H. Newman (1801-1890), maintaining the authority of conscience and the probabilism of the understanding, concluded to the necessity of a higher authority in the primitive church. W. G. Ward was a philosophical critic of Mill. St. George Mivart, in *The Ground-work of Science* (1898), maintained the reality of an active causative power underlying Nature, and the dignity of human reason, from an independent point of view. On the other hand, more under the influence of the Thomist reaction, Thomas Harper published *The Metaphysics of the School* (1879, &c.), describing scholasticism, as it appears in the works of Aquinas; and *The Manuals of Catholic Philosophy*, edited by R. F. Clarke, include *General Metaphysics* (1890), by John Rickaby, who effectively criticizes Hegel by precise distinctions, which, though scholastic, did not deserve to be forgotten.

The Thomist reaction has had a good effect in the way of encouraging the study of Aristotelian philosophy in itself, and as modified by Aquinas. Nevertheless, the world cannot afford to surrender itself to Aristotle, or to Aquinas. Aristotle could not know enough, physically, about Nature to understand its matter, or its motions, or its forces; and consequently he fell into the error of supposing a primary matter with four contrary primary qualities, hot and cold, dry and moist, forming by their combinations four simple bodies, earth, water, air and fire, with natural rectilinear motions to or from the centre of the earth; to which he added a quintessence of ether composing the stars, with a natural circular motion round the earth. Metaphysically, he did not, indeed, as is often supposed, think the nature of substance to be matter and form, because in his view God is a substance, yet with no matter; but he did think that every natural substance or body is a concrete whole, composed of matter and form different from matter. He thought that besides proximate matter, or one body as matter of another, there is a primary formless matter beneath all bodies, capable of becoming all in turn, but itself potentially, not actually, substance. He thought not only that a form, or essence, is something different from, and at most conjoined with, matter in a concrete body, but also that in all the bodies of one kind, e.g. in all men, there is one undivided form or essence, e.g. rational animal, communicated from one member to another member of the kind, e.g. from father to son, by what we still call, though without any meaning, the propagation of the species. He thought, in consequence, that the *principium individuationis*, which differentiates two members of the kind, e.g. Socrates and Callias, is their one form or essence only as conjoined with different matters, e.g. different bones and flesh. He thought, moreover, that the one form of a kind is an original essence (*in se et per se*) which is uncreate; and in order to avoid the "separate forms" supposed by Plato, he concluded that the world of Nature must be eternal, in order that each original essence may from eternity always be in some individual or another of its kind. On this assumption of the

eternity of the world, God could not be a Creator. Aristotle thought that God is only prime mover, and that too only as the good for the sake of which Nature moves; so that God moves as motive. Psychologically, Aristotle applied his dualism of matter and form to explain the antithesis of body and soul, so that the soul is the form, or entelechy, of an organic body, and he applied the same dualism to explain sensation, which he supposed to be reception of the sensible form or essence, without the matter, of a body, e.g. of the form of white, without the matter, of a white stone. He thought that in the soul there is a productive intellect and a passive intellect, and that, when we rise from sense by induction, the productive causes the passive intellect to receive the universal form or essence, e.g. of all white things; and he thought that this productive intellect is our immortal faculty. Lastly, he thought that, while other operations have, intellect (*noûs*) has not, a bodily organ; and hence he became responsible for the fancy that there is a break in bodily continuity between sense and will, while intellect is working out a purely immaterial operation of soul, resulting from the former and tending to the latter. It is evident that a philosophy containing so many questionable opinions is not fit to be made into an authoritative orthodoxy in metaphysics.

Now these, on the whole, are the very opinions of Aquinas, except so far as they were clearly inconsistent with the Christian faith. Aquinas thought, as an article of faith, that the world began, and that God is its Creator. This involved a change of detail in the theory of essences and of universals generally. Aquinas thought that before the creation the one eternal essence of any kind was an abstract form, an idea in the intellect of God, like the form of a house in the mind of a builder, *ante rem*; that after the creation of any kind it is *in re*, as Aristotle supposed; and that, as we men think of it, it is *post rem*, as Aristotle also supposed. Of this view the part which was not Aristotle's, the state of "universalia ante rem," was due to the Neoplatonists, who interpreted the separate forms of Plato to be ideas in intellect, and handed down their interpretation through St. Augustine to the medieval Realists like Aquinas, who thus combined Neoplatonism with Aristotelianism. Hence too Aquinas opposed essence to existence much more than Aristotle did. Lastly, as a Christian, he supposed the whole soul to be immortal, and to form for itself a new body after death. But, with these modifications he accepted the general physics of Aristotle, the metaphysical dualism of matter and form, and the psychology founded upon it. The Thomism, therefore, of our day is wrong, from a metaphysical point of view, so far as it elevates Aristotelianism, seriously modified but not fundamentally corrected by Aquinas, into an authoritative orthodoxy in metaphysics.

Centuries elapsed after Aquinas before Galileo and his successors reformed natural science, and before Bacon destroyed the metaphysical dualism of matter and form by showing that a form in Nature is only a law of the action of matter, and that, as the action of a body is as individual as the body, the form is eternal only in thought (*ratione*). The psychology of Aristotle and Aquinas thus became impossible; for, if the form of a body is only a mode of matter, to call one's soul the form of one's body is to reduce it to only a mode of matter, and fall into materialism. Hence Descartes began the reform of psychology not only by the appeal to consciousness, "I think," but also by opposing body and soul, no longer as matter and form, but as different substances. These great improvements, due to the genius of Galileo, of Bacon, of Descartes, are the fresh beginnings of modern thought, from which we dare not turn back without falling into obscurantism. What, then, is the future of metaphysics? We must return not to the authority but to the study of Aristotle. The independence of metaphysics as the science of being, the principles of contradiction and excluded middle with their qualifications, the distinction without separation between substance and attributes, the definition of substance as a distinct individual thing, the discovery that the world consists of substances existing apart but related to one another, the distinction between material and efficient causes or matter and force, the recognition both of the natural and of the supernatural—all these and many other half-forgotten truths are the reasons why we must always begin with the study of Aristotle's *Metaphysics*. But their incompleteness shows that we must go forward from Aristotle to Bacon and modern science, and even pass through the anarchy of modern metaphysics, in the hope that in the future we may discover as complete an answer as possible to these two questions:—

1. What is the world of things we know?
2. How do we know it?

For authorities see the works quoted above, and the references in the articles on philosophers and philosophical subjects. (T. CA.)

METAPONTUM (Gr. *Μεταπόντιον*, mod. Metaponto), an ancient city of Magna Graecia situated on the Gulf of Tarentum, near the mouth of the river Bradanus, and distant about 24 m. from Tarentum and 14 m. from Heraclea. It was founded by an Achaean colony from Sybaris and Crotona about 700 B.C. Metapontum was one of the cities that played a conspicuous part in the troubles arising from the introduction of the Pythagorism into Magna Graecia, and it was there that Pythagoras died in 497 B.C. His tomb was still shown in the time of Cicero.

At the time of the Athenian expedition to Sicily (415 B.C.) Metapontum appears to have been an opulent and powerful city, whose alliance was courted by the Athenians; but it contented itself with a very trifling support. In 332 B.C., at the time of the expedition of Alexander, king of Epirus, into Italy, it was one of the first cities to enter into an alliance with him. The Second Punic War gave a fatal blow to its prosperity. After the battle of Cannae in 216 B.C. it was among the first cities in the south of Italy to declare in favour of Hannibal, and became for some years the headquarters of Hannibal. Hence, when the defeat of Hasdrubal at the Metaurus (207 B.C.) compelled him to abandon this part of Italy, the inhabitants of Metapontum abandoned their city, and followed him in his retreat.

From this time Metapontum sank; though it was still existing in the days of Cicero, Pausanias tells us that in his time nothing remained of it but a theatre and the circuit of the walls.

Metapontum has the remains of two temples, both of which seem to belong to the period 510-480 B.C. (Koldewey and Puchstein, *Die griechischen Tempel in Unteritalien und Sicilien*, Berlin, 1899, pp. 35-41). The so-called Chiesa di Sansone, which lay within the ancient town, and was probably dedicated to Apollo Lycius, was a peripteros measuring 186 by 92½ ft., of which only the foundations are left. The capitals were 3½ ft. in diameter. The temple was decorated with finely painted terra-cottas. Of the other temple, the so-called Tavole Palatine, which lay outside the area of the ancient city, and was a peripteros with 6 columns, 3½ ft. in diameter, in front and 12 ft. at the sides, 15 columns are standing, with the lower portion of the epistyle. It measured 105 ft. by 49 ft. without the steps. There are also traces of the town walls, which have served for the construction of farmhouses, of tombs, and of a harbour by the shore. Pliny speaks of a temple of Juno at Metapontum supported by columns of vine-wood (*Hist. nat.* xiv. 9). An archaic treasure-house dedicated at Olympia by the people of Metapontum has been discovered there. The railway station is the junction of the line from Battipaglia (and Naples) with that from Taranto to Reggio. (T. As.)

See M. Lacava, *Topografia e storia di Metaponto* (Naples, 1891).

METASOMATISM (Gr. *μετά*, change, *σώμα*, body), in petrology, a process of alteration of rocks by which their chemical composition is modified, new substances being introduced while those originally present are partly or wholly removed in solution. For example a limestone may be converted into a siliceous chert, a dolomite, an ironstone, or a mass of metalliferous ores by metasomatic alteration. The process is usually incomplete, greater or smaller portions of the original rock remaining. The agencies of metasomatism are in nearly all cases aqueous solutions; probably they were often at a high temperature, as metasomatic changes are especially liable to occur in the vicinity of igneous intrusions (laccolites, dikes and necks) where large quantities of water were given off by the volcanic magma at a time when it had solidified but was not yet cold. Metasomatism also usually goes on at some depth, so that we may readily believe that it is favoured by increase of pressure. On the other hand, there are many instances in which these processes cannot be shown to have taken place at temperatures or pressures above those which normally exist in the upper part of the earth's crust (e.g. dolomitization and silicification of many limestones). There are also cases of metasomatism in which steam and other vapours are supposed to have been operative; the temperatures were probably above the critical temperature of water. Changes of this sort are

described as pneumatolytic, being induced by gases (see PNEUMATOLYSIS).

By metasomatism new minerals replace the primitive ones; at the same time the original rock-structures may be completely obliterated. An igneous rock for example may be entirely replaced by crystalline massive quartz, a fossiliferous limestone by granular crystalline dolomite. It is equally common, however, to find that the structure of the original rock is preserved though its substance has been entirely altered. An oolitic limestone may become an oolitic ironstone or chert (see PETROLOGY, Pl. IV. fig. 5.) and casts of the fossils which the limestone contained may be formed of siderite or of chalcidolite. In this case the rock resembles a pseudomorph, which is the term applied to a mineral which has been entirely replaced by another mineral without losing its original crystalline form. As a result of metasomatism rocks usually become more crystalline, especially those which have been in large part built up of fossil organic remains; this is a consequence of the new substances having been deposited by purely inorganic processes from solution in water.

The chemical change is often complete, as when a limestone is replaced by chert or otherwise silicified, but it is probably more usually incomplete, part of the substance of the original rock having been retained though possibly in new mineral combinations. When a limestone is replaced by ironstone (e.g. carbonate of iron or siderite) part at least of the carbonic acid may be that of the limestone. A dolomite, formed from a limestone, contains more than one-half of its weight of carbonate of lime presumably derived from the limestone itself; yet in this case the mineral transformation may be perfect, as the dolomite retains none of the calcite of which the limestone was formed; it is all present as the double carbonate of lime and magnesia (or dolomite). When a granite is converted by emanations containing fluorine and boron into a quartz-tourmaline rock (schorl rock, *q.w.*) or a quartz mica rock (*greisen*, *q.n.*) it can be proved by analysis that there has been very little modification of the chemical composition of the original mass. This resembles paramorphism in minerals, in which one mineral is substituted for another having the same chemical composition (e.g. kyanite for andalusite).

The relations between metamorphism and metasomatism are very close; in fact some authors regard metasomatism as a variety of metamorphism. It is generally true, however, that in metamorphic changes there is little chemical alteration; sandstones pass into quartzites, clays into mica-schists and gneisses, limestones into marbles without any essential modification in chemical composition, for the original mineral new ones being substituted and new structures being produced at the same time. In metasomatism, on the other hand, chemical alteration is supposed by most geologists to be an essential feature; new minerals appear, but the original structures are sometimes retained.

The facility with which a rock undergoes metasomatism depends partly on its nature, and partly on the circumstances in which it is placed. Limestones, being readily soluble under natural conditions, are especially liable. The Cleveland iron ores of Yorkshire are ironstones replaced by siderite and limonite; the Whitehaven iron ores are metasomatic replacements of limestone by haematite. The former are of Mesozoic, the latter of Palaeozoic age, but both have been changed in very much the same way by percolating solutions containing salts of iron. In some cases limonite and magnetite are the principal ores. Often the changes have taken place very irregularly, along bedding planes, faults and fractures. An ironstone may in many places be traced laterally into a limestone, the amount of iron in the rock gradually diminishing. Some ironstones (Carboniferous, Jurassic, &c.) retain the oolitic structures of the original limestone; others show corals, shells and other calcareous fossils replaced by iron ores. When beds of shale or sandstone are intercalated among the ironstones they usually show little change, a fact which indicates that the ready solubility of the calcareous rocks was a dominating factor in determining the metasomatic deposits. It is believed that the Whitehaven iron ores may be derived from the ironstones of the Coal-Measures which once covered the limestone districts.

Dolomitization of limestones is even more common than replacement by iron ores. That it is going on at the present day is evident from the fact that cores obtained by boring in recent coral reefs have shown that these may be extensively dolomitized in their deeper parts, and that the limestones such as the Triassic of the Alps, the Carboniferous Limestone of England and the Cambrian

Limestone of Scotland are sometimes converted into dolomite over wide areas. There has been an introduction of magnesia, with sometimes a little silica and iron; the rock recrystallizes owing to the formation of small rhombohedra of dolomite; it frequently becomes porous and full of druse cavities, owing to the contraction in volume which takes place, and the fossils and other organic structures of the original rock disappear. The change proceeds outwards from fissures and bedding planes and spreads gradually through the mass of the limestone; often the transformation is complete and no unaltered rock remains. Silicification or the replacement of limestone by chalcedony, chert or quartz, is often exhibited on a large scale. The formation of flint nodules and chert bands is of this nature; the silica is not really an introduction from without, but is merely the material of the fine siliceous skeletons of sponges, radiolaria and other organisms, which at first were widely scattered through the limestone and at a later time were dissolved by percolating waters, percolated through the rock and were deposited in certain situations as bands, nodules and tabular masses of cryptocrystalline silica. In limestones extensive deposits of zinc ore may occur, usually calamine. These are important sources of the metal and there is little room for doubt that they have formed by a process of metasomatic replacement, e.g. Carthage, Raibl (in Carinthia) and Belgium. In many parts of western North America (Nevada, Arizona, &c.) great deposits of copper, lead and silver ores are worked in crystalline limestones. They are often highly silicified, and associated with them are intrusive igneous rocks such as granite, diorite, porphyry and diabase. The ones occur in the veins and shoots, but also in great masses replacing the limestone, and the geologists who have examined these mining districts are nearly unanimous as to the metasomatic nature of a large part of these deposits. Other rocks such as tuff, volcanic breccia, shale, porphyry and granite may also be impregnated with metalliciferous ores, but the largest ore bodies are found in the limestones. Secondary enrichment has often taken place on a considerable scale. The constant presence of igneous rocks indicates that they are connected with the introduction of the metals, and the deposits are often of such a kind as to show that post-volcanic discharges of magmatic gases and water have been the actual mineralizing agents. Bisbee, Clifton and the Globe district in Arizona, Flagstaff in Utah, and the Eureka district in Nevada are good examples of the deposits in question.

As indicated above, shales, sandstones and igneous rocks may be silicified and mineralized under suitable conditions. Rhyolites and rhyolitic tuffs are often impregnated with silica to such an extent that they become almost massive quartz, and the fluidal, porphyritic, spheroidal and other igneous structures of the original rock may be retained in the siliceous residuum. There are many examples of this in North Wales and the Pentland Hills. In andesites, serpentines and trachytes silicification is frequently found in circumstances indicating that the changes are not due to weathering but are the effect of post-volcanic emanations of heated waters. Silicified shales may accompany mineral deposits, e.g. in the Cornish tin mines the killas or grey slate may be converted into quartz and brown tourmaline and contains small quantities of tin stone. In the copper mines of Parys Mountain, Anglesey, formerly of great importance as producers of this metal, there are large areas of silicified slate and silicified porphyry. White mica, kaolin, gibberite, chlorite and epidote are frequently present in silicified igneous rocks. As a further instance of mineral deposition in metasomatized igneous rocks we may quote the Cripple Creek goldfield in Colorado, where syenites, latites, phonolites, breccias, &c., have been filled with pyrite, dolomite, fluorite, calaverite and other new minerals together with quartz.

Another type of metasomatic alteration is phosphatization. This is most common in limestones, and many of the most important bedded phosphates are of this origin. Trachytes and other igneous rocks are occasionally phosphatized. The source of the phosphate is for the most part the skeletons of animals, vertebrate bones and teeth, shells of certain brachiopods, trilobites and other organisms. Guano, the excreta of birds, is rich in phosphates and these are washed downwards by rain producing metasomatic changes in the underlying rocks. Phosphatized limestones are obtained in great quantities in Christmas Island, Sombroero, Curaçoa and other uninhabited limestone islands. (J. S. F.)

METASTASIO (1698-1782). Pietro Trapassi, the Italian poet who is better known by his assumed name of Metastasio, was born in Rome on the 13th of January 1698. His father, Felice Trapassi, a native of Assisi, came to Rome and took service in the Corsican regiment of the papal forces. He subsequently married a Bolognese woman, called Francesca Galasti, and established himself in business as a grocer in the Via dei Cappellari. Two sons and two daughters were the fruit of this marriage. The eldest son, Leopoldo, must be mentioned, since he played a part of some importance in the poet's life. Pietro, while quite a child, often held a crowd attentive in the streets while he recited impromptu verses on a given subject. It so

happened that, while he was thus engaged one evening in the year 1709, two men of distinction in Roman society stopped to listen to his declamation. These were Gian Vincenzo Gravina, famous for legal and literary erudition, famous no less for his dictatorship of the Arcadian Academy, and Lorenzini, a critic of some note. Gravina was at once attracted by the boy's poetical talent and charm of person, interested himself in the genius he had accidentally discovered, made Pietro his protégé, and in the course of a few weeks adopted him. Felice Trapassi was glad enough to give his son the chance of a good education and introduction into the world under auspices so favourable. Gravina helenized the boy's name Trapassi into Metastasio; and intended his adopted son to be a jurist like himself. He therefore made the boy learn Latin and begin the study of law. At the same time he cultivated his literary gifts, and displayed the youthful prodigy both at his own house and in the Roman coteries. Metastasio soon found himself competing with the most celebrated improvisatori of his time in Italy. Days spent in severe studies, evenings devoted to the task of improvising eighty stanzas at a single session, were fast ruining Pietro's health and overstraining his poetic faculty. At this juncture Gravina had to journey into Calabria on business. He took Metastasio with him, exhibited him in the literary circles of Naples, and then placed him under the care of his kinsman Gregorio Caroprese at a little place called Scalfà. In country air and the quiet of the southern seashore Metastasio's health revived. It was decreed by Gravina that he should never improvise again, but should be reserved for nobler efforts, when, having completed his education, he might enter into competition with the greatest poets.

Metastasio responded to his patron's wishes. At the age of twelve he translated the *Iliad* into octave stanzas; and two years later he composed a tragedy in the manner of Seneca upon a subject chosen from Trissino's *Italia liberata*—Gravina's favourite epic. It was called *Giustino*. Gravina had it printed in 1713; but the play is lifeless; and forty-two years afterwards we find Metastasio writing to his publisher, Calsabigi, that he would willingly suppress it. Caroprese died in 1714, leaving Gravina his heir; and in 1718 Gravina also died. Metastasio inherited house, plate, furniture and money, which amounted to 15,000 scudi, or about £4000. At a meeting of the Arcadian Academy, he recited an elegy on his patron, and then settled down, not it seems without real sorrow for his loss, to enjoy what was no inconsiderable fortune at that period. Metastasio was now twenty. During the last four years he had worn the costume of abbé, having taken the minor orders without which it was then useless to expect advancement in Rome. His romantic history, personal beauty, charming manners and distinguished talents made him fashionable. That before two years were out he had spent his money and increased his reputation for wit will surprise no one. He now very sensibly determined to quit a mode of life for which he was not born, and to apply himself seriously to the work of his profession. Accordingly he went to Naples, and entered the office of an eminent lawyer named Castagnola. It would appear that he articulated himself as clerk, for Castagnola exercised severe control over his time and energies. While slaving at the law, Metastasio in 1721 composed an epithalamium, and probably also his first musical serenade, *Endimione*, on the occasion of the marriage of his patroness the Princess Pinelli di Sangro to the Marchese Belmonte Pignatelli. But the event which fixed his destiny, was the following. In 1722 the birthday of the empress had to be celebrated with more than ordinary honours, and the viceroy applied to Metastasio to compose a serenade for the occasion. He accepted this invitation, but it was arranged that his authorship should be kept secret. Under these conditions Metastasio produced *Gli orti esperidi*. Set to music by Porpora, it won the most extraordinary applause. The great Roman prima donna, Marianna Bulgarelli, called La Romanina from her birthplace, who had played the part of Venus in this drama, spared no pains until she had discovered its author. La Romanina forthwith took possession of him, induced him to quit his

lawyer's office, and promised to secure for him fame and independence, if he would devote his talents to the musical drama. In La Romanina's house Metastasio became acquainted with the greatest composers of the day—with Porpora, from whom he took lessons in music; with Hasse, Pergolesi, Scarlatti, Vinci, Leo, Durante, Marcello, all of whom were destined in the future to set his plays to melody. Here too he studied the art of singing, and learned to appreciate the style of such men as Farinelli. Gifted himself with extraordinary facility in composition, and with a true poetic feeling, he found no difficulty in producing plays which, while beautiful in themselves, judged merely as works of literary art, became masterpieces as soon as their words were set to music, and rendered by the singers of the greatest school of vocal art the world has ever seen. Reading Metastasio in the study, it is impossible to do him justice. But the conventionality of all his plots, the absurdities of many of his situations, the violence he does to history in the persons of some leading characters, his "damnable iteration" of the theme of love in all its phases, are explained and justified by music.

Metastasio resided with La Romanina and her husband in Rome. The generous woman, moved by an affection half maternal half romantic, and by a true artist's admiration for so rare a talent, adopted him more passionately even than Gravina had done. She took the whole Trappasi family—father, mother, brother, sisters—into her own house. She fostered the poet's genius and pampered his caprices. Under her influence he wrote in rapid succession the *Didone abbandonata*, *Catone in Utica*, *Ezio*, *Alessandro nell'Indie*, *Semiramide riconosciuta*, *Siroe* and *Arlarrese*. These dramas were set to music by the chief composers of the day, and performed in the chief towns of Italy. But meanwhile La Romanina was growing older; she had ceased to sing in public; and the poet felt himself more and more dependent in an irksome sense upon her kindness. He gained 300 scudi (about £60) for each opera; this pay, though good, was precarious, and he longed for some fixed engagement. In September 1729 he received the offer of the post of court poet to the theatre at Vienna, with a stipend of 3000 florins. This he at once accepted. La Romanina unselfishly sped him on his way to glory. She took the charge of his family in Rome, and he set off for Austria.

In the early summer of 1730 Metastasio settled at Vienna in the house of a Spanish Neapolitan, Niccolò Martinez, where he resided until his death. This date marks a new period in his artistic activity. Between the years 1730 and 1740 his finest dramas, *Adriano*, *Demetrio*, *Issipile*, *Demofonte*, *Olimpiade*, *Clemenza di Tito*, *Achille in Sciro*, *Temistocle* and *Attilio Regolo*, were produced for the imperial theatre. Some of them had to be composed for special occasions, with almost incredible rapidity—the *Achille* in eighteen days, the *Ipermestra* in nine. Poet, composer, musical copyist and singer did their work together in frantic haste. Metastasio understood the technique of his peculiar art in its minutest details. The experience gained at Naples and Rome, quickened by the excitement of his new career at Vienna, enabled him almost instinctively, and as it were by inspiration, to hit the exact mark aimed at in the opera.

At Vienna Metastasio met with no marked social success. His plebeian birth excluded him from aristocratic circles. But, to make up in some measure for this comparative failure, he enjoyed the intimacy of a great lady, the Countess Althann, sister-in-law of his old patroness the Princess Belmonte Pignatelli. She had lost her husband, and had some while occupied the post of chief favourite to the emperor. Metastasio's liaison with her became so close that it was even believed they had been privately married. The even tenor of his existence was broken in the year 1734 by the one dark and tragic incident of his biography. It appears that La Romanina had at last got tired of his absence. Could not Metastasio get her an engagement at the court theatre? The poet at this juncture revealed his own essential feebleness of character. To La Romanina he owed almost everything as a man and as an artist. But he was ashamed of her and tired of her. He vowed she should not come to Vienna, and wrote dissuading her from the projected visit.

The tone of his letters alarmed and irritated her. It is probable that she set out from Rome, but died suddenly upon the road. All we know is that she left him her fortune after her husband's life interest in it had expired, and that Metastasio, overwhelmed with grief and remorse, immediately renounced the legacy. This disinterested act plunged the Bulgarelli-Metastasio household at Rome into confusion. La Romanina's widower married again. Leopoldo Trappasi, and his father and sister, were thrown upon their own resources.

As time advanced the life which Metastasio led at Vienna, together with the climate, told upon his health and spirits. From about the year 1745 onward he wrote but little, though the cantatas which belong to this period, and the canzone *Ecco quel fiero istante*, which he sent to his friend Farinelli, rank among the most popular of his productions. It was clear, as Vernon Lee has phrased it, that "what ailed him was mental and moral ennui." In 1755 the Countess Althann died, and Metastasio was more than ever reduced to the society which gathered round him in the bourgeois house of the Martinez. He sank rapidly into the habits of old age; and, though his life was prolonged till the year 1782, very little can be said about it. On the 12th of April he died, bequeathing his whole fortune of some 130,000 florins to the five children of his friend Martinez. He had survived all his Italian relatives.

During the long period of forty years in which Metastasio overlied his originality and creative powers his fame went on increasing. In his library he counted as many as forty editions of his own works. They had been translated into French, English, German, Spanish, even into modern Greek. They had been set to music over and over again by every composer of distinction, each opera receiving this honour in turn from several of the most illustrious men of Europe. They had been sung by the best virtuosi in every capital, and there was not a literary academy of note which had not conferred on him the honour of membership. Strangers of distinction passing through Vienna made a point of paying their respects to the old poet at his lodgings in the Kohlmarkt Gasse. But his poetry was intended for a certain style of music—for the music of omnipotent vocalists, of thaumaturgical sopranos. With the changes effected in the musical drama by Gluck and Mozart, with the development of orchestration and the rapid growth of the German manner, a new type of libretto came into request. Metastasio's plays fell into undeserved neglect, together with the music to which he had linked them. Farinelli, whom he styled "twin-brother," was the true exponent of his poetry; and, with the abolition of the class of singers to which Farinelli belonged, Metastasio's music suffered eclipse. It was indeed a just symbolic instinct which made the poet dub this unique soprano his twin-brother.

The musical drama for which Metastasio composed, and in working for which his genius found its proper sphere, has so wholly passed away that it is now difficult to assign his true place to the poet in Italian literary history. His inspiration was essentially emotional and lyrical. The chief dramatic situations are expressed by lyrics for two or three voices, embodying the several contending passions of the agents brought into conflict by the circumstances of the plot. The total result is not pure literature, but literature supremely fit for musical effect. Language in Metastasio's hands is exquisitely pure and limpid. Of the Italian poets, he professed a special admiration for Tasso and for Marini. But he avoided the conceits of the latter, and was no master over the refined richness of the former's diction. His own style reveals the improvisatore's facility. Of the Latin poets he studied Ovid with the greatest pleasure, and from this predilection some of his own literary qualities may be derived. For sweetness of versification, for limpidity of diction, for delicacy of sentiment, for romantic situations exquisitely rendered in the simplest style, and for a certain delicate beauty of imagery sometimes soaring to ideal sublimity, he deserves to be appreciated so long as the Italian language lasts.

There are numerous editions of Metastasio's works. That by Calsabigi (Paris, 1755, 9 vols. 8vo) published under his own superintendence, was the poet's favourite. Another of Turin (1757) and a

third of Paris (1780) deserve mention. The posthumous works were printed at Vienna, 1795. The collected editions of Genoa (1802) and Padua (1811) will probably be found most useful by the general student. An edition of the letters, by Cardacci, was published at Bologna in 1883. Metastasio's life was written by Aluigi (Assisi, 1783); by Charles Burney (London, 1796); and by others; but by far the most vivid sketch of his biography will be found in Vernon Lee's *Studies of the 18th Century in Italy* (London, 1880) a work which throws a flood of light upon the development of Italian dramatic music, and upon the place occupied by Metastasio in the artistic movement of the last century. (J. A. S.)

***METAURUS** (mod. *Metauro*; the form Maturaus is later, and is more frequent in inscriptions of the imperial period), a river of Italy, which flows into the sea a little south-east of Fanum Fortunae (mod. *Fano*). On its banks Hasdrubal, while marching to the aid of Hannibal in 207 B.C., was defeated and slain by the Roman army, this being the decisive battle of the Second Punic War. The exact site of the battle is uncertain; tradition places it between Fossombrone and the Furlo Pass, but it is probable that it occurred nearer the sea-coast.

METAXAS, ANDREAS (1786–1860), Greek politician, was born in the island of Cephalonia. During the latter part of the War of Independence (1824–1827) he accompanied Capo d'Istria to Greece, and was appointed by him minister of war. When Capo d'Istria was murdered in 1831 Metaxas became a member of the provisional government which held office till the accession of King Otho in 1833. During the minority of Otho he was named privy councillor and minister at Madrid and Lisbon. In 1840 he was recalled and appointed minister of war. In 1843–1844 he was president of the council of ministers, and he subsequently held the post of ambassador at Constantinople from 1850 to 1854. He died at Athens on the 19th of September 1860.

MÉTAYAGE SYSTEM, the cultivation of land for a proprietor by one who receives a proportion of the produce. The system has never existed in England and has no English name, but in certain provinces of Italy and France it was once almost universal, and is still very common. It is also not unusual in Portugal, in Greece, and in the countries bordering on the Danube. In Italy and France, respectively, it is called *mezzeria* and *métayage*, or halving—the halving, that is, of the produce of the soil between landowner and landholder. These expressions are not, however, to be understood in a more precise sense than that in which we sometimes talk of a larger and a smaller half. They merely signify that the produce is divisible in certain definite proportions, which must obviously vary with the varying fertility of the soil and other circumstances, and which do in practice vary so much that the landlord's share is sometimes as much as two-thirds, sometimes as little as one-third. Sometimes the landlord supplies all the stock, sometimes only part—the cattle and seed perhaps, while the farmer provides the implements; or perhaps only half the seed and half the cattle, the farmer finding the other halves—taxes too being paid wholly by one or the other, or jointly by both.

English writers were unanimous, until J. S. Mill adopted a different tone, in condemning the métayer system. They judged it by its appearance in France, where it has never won a very attractive aspect. Under the *ancien régime* not only were all direct taxes paid by the métayer, the noble landowner being exempt, but these taxes, being assessed according to the visible produce of the soil, operated as penalties upon all endeavours to augment its productivity. No wonder, then, if the métayer fancied that his interest lay less in exerting himself to augment the total to be divided between himself and his landlord, than in studying how to defraud the latter part of his rightful share; nor if he has not yet got rid of habits so acquired, especially when it is considered that he still is destitute of the fixity of tenure without which métayage cannot prosper. French métayers, in Arthur Young's time, were "removable at pleasure, and obliged to conform in all things to the will of their landlords," and so in general they are still. Yet even in France, although métayage and extreme rural poverty usually coincide, there are provinces where the contrary is the fact, as it is also in Italy. Indeed, to every tourist who has passed through the plains of

Lombardy with his eyes open, the knowledge that métayage has for ages been there the prevailing form of tenure ought to suffice for the triumphant vindication of métayage in the abstract. An explanation of the contrasts presented by métayage in different regions is not far to seek. Métayage, in order to be in any measure worthy of commendation, must be a genuine partnership, one in which there is no sleeping partner, but in the affairs of which the landlord, as well as the tenant, takes an active part. Wherever this applies, the results of métayage appear to be as eminently satisfactory, as they are decidedly the reverse wherever the landlord holds himself aloof.

In France there is also a system termed *métayage par groupes*, which consists in letting a considerable farm, not to one métayer, but to an association of several, who work together for the general good, under the supervision either of the landlord himself, or of his bailiff. This arrangement gets over the difficulty of finding tenants possessed of capital enough for any but very small farms.

See further the section *Agriculture* in the articles FRANCE, GREECE, ITALY, &c.; and consult J. Cruveilhier, *Étude sur le métayage* (Paris, 1894).

METCALF, WILLARD LEROY (1858–), American artist, was born at Lowell, Massachusetts, on the 1st of July 1858. He was a pupil of the Boston Normal Art School, of the Boston Art Museum School, and of the Académie Julien, Paris. After early figure-painting and illustration, he became prominent as a landscape painter. He was one of the "Ten American Painters" who in 1897 seceded from the Society of American Artists. For some years he was an instructor in the Woman's Art School, Cooper Union, New York, and in the Art Students' League, New York. In 1893 he became a member of the American Water Colour Society, New York.

METCALFE, CHARLES THEOPHILUS METCALFE, BARON (1785–1846), Indian and colonial administrator, was born at Calcutta on the 30th of January 1785; he was the second son of Thomas Theophilus Metcalfe, then a major in the Bengal army, who afterwards became a director of the East India Company, and was created a baronet in 1802. Having been educated at Eton, he in 1800 sailed for India as a writer in the service of the Company. After studying Oriental languages as the first student at Lord Wellesley's College of Fort William, he, at the age of nineteen, was appointed political assistant to General Lake, who was then conducting the final campaign of the Mahratta war against Holkar. In 1808 he was selected by Lord Minto for the responsible post of envoy to the court of Ranjit Singh at Lahore; here, on the 25th of April 1809, he concluded the important treaty securing the independence of the Sikh states between the Sutlej and the Jumna. Four years afterwards he was made resident at Delhi, and in 1819 he received from Lord Hastings the appointment of secretary in the secret and political department. From 1820 to 1825 Sir Charles (who succeeded his brother in the baronetcy in 1822) was resident at the court of the nizam, and afterwards was summoned in an emergency to his former post at Delhi. In 1827 he obtained a seat in the supreme council, and in March 1835, after he had acted as the first governor of the proposed new presidency of Agra, he provisionally succeeded Lord William Bentinck in the governor-generalship. During his brief tenure of office (it lasted only for one year) he carried out several important measures, including that for the liberation of the press, which, while almost universally popular, complicated his relations with the directors at home to such an extent that he resigned the service of the Company in 1838. In the following year he was appointed by the Melbourne administration to the governorship of Jamaica, where the difficulties created by the recent passing of the Negro Emancipation Act had called for a high degree of tact and ability. Sir Charles Metcalfe's success in this delicate position was very marked, but unfortunately his health compelled his resignation and return to England in 1842. Six months afterwards he was appointed by the Peel ministry to the governor-generalship of Canada, and his success in carrying out the policy of the home government was rewarded with a

perage shortly after his return in 1845. He died at Malshanger, near Basingstoke, on the 5th of September 1846.

See J. W. Kaye's *Life and Correspondence of Charles Lord Metcalfe* (London, 1854).

METELLUS, the name of a distinguished family of the *Cæcilian* (plebeian) gens in ancient Rome. The following are the most important:—

1. **LUCIUS CÆCILIUS METELLUS**, general during the first Punic War. Consul in 251 B.C., he was sent to Sicily, and gained a decisive victory over Hasdrubal, who, trusting to his numerically superior forces and the alarm inspired by his elephants, ventured to attack him. Metellus's victory was in great measure due to a panic caused amongst the elephants by his clever manoeuvring. A number of these animals were sent in specially constructed rafts to adorn his triumph, and from this time the elephant frequently occurs as a device on the coins of the Metelli. In 241, when the temple of Vesta was destroyed by fire, Metellus succeeded in bringing out the Palladium uninjured, but lost his eyesight. As a reward, he was granted permission to ride to the senate-house in a carriage, a privilege hitherto unheard of. But the story of his blindness is doubtful, since it is hardly consistent with his appointment as dictator in 224 "for the purpose of holding the comitia," nor is any mention made of it in the extract [Pliny, *Nat. Hist.* vii. 43 (45)] from the funeral oration pronounced over him by his son.

2. **QUINTUS CÆCILIUS METELLUS**, son of (1), became consul in 206 as a reward for his services at the Metaurus. In 205 he was dictator for holding the comitia; in 201 one of the commissioners for dividing the public land in Samnium and Apulia amongst the Roman veterans; in 186 he conducted an embassy to Macedonia, afterwards proceeding to Peloponnesus to investigate the quarrel between Sparta and the Achæans. He is the Metellus who caused the poet Naevius (*q.v.*) to be imprisoned and exiled for having attacked him on the stage.

3. **LUCIUS CÆCILIUS METELLUS**, possibly son of (1), when the disastrous news of the battle of Cannæ (216) reached Rome, proposed to a number of young nobles that they should leave Italy and offer their services to some foreign ruler, but they were prevented by the threats of the younger Scipio from carrying out their purpose. For this offence, when quaestor two years later, he was degraded by the censors from his tribe to the class of *aerarii*. Nevertheless, he was elected one of the tribunes for the following year, but his attempt to call the censors to account for their action proved unsuccessful in the face of the opposition of his colleague.

4. **QUINTUS CÆCILIUS METELLUS MACEDONICUS** (d. 115 B.C.), praetor 148 B.C., defeated the usurper Andronicus (*q.v.*) in Macedonia and forced him to surrender. Under his superintendence the country was made a Roman province. In 146, he attacked the Achæans to avenge an insult offered to a Roman embassy at Corinth. He gained decided successes over them at Scarpheia and Chaeronea, but was superseded by L. Mummius. On his return to Italy he received the honour of a triumph and the title of *Macedonicus*. Consul in 143, he reduced the Celtiberians in northern Spain to obedience. In 131, when censor with Q. Pompeius (they were the first two plebeian censors), he proposed that all citizens should be compelled to marry. He expelled a number of senators, one of whom, the tribune C. Atinius Labeo, proposed that he should be hurled from the Tarpeian rock; his life was only saved through the intervention of another tribune. He was an opponent of the Gracchi, although not averse from moderate reform. He was a strict disciplinarian, a good general, and a type of the ancient Roman both in public and private life. He erected a splendid colonnade in the Campus Martius, and two temples dedicated to Jupiter Stator and Juno.

5. **QUINTUS CÆCILIUS METELLUS NUMIDICUS**, consul 109, and commander in the Jugurthine War. He defeated Jugurtha (*q.v.*) by the river Muthul, and after a difficult march through the desert took his stronghold, Thala. Marius, however, who had been intriguing for the command, accused Metellus of protracting the war, and received the consulship for 107 with the province

of Numidia. Metellus received a splendid triumph and the title of *Numidicus*. Saturninus, whom, as a censor he tried to remove from the senate, passed in 100 an agrarian law, inserting a provision that all senators should swear to it within five days. All complied but Metellus, who retired to Asia. After Saturninus was killed he returned, and died (probably in 91). He was a man of the highest integrity, a strict and efficient general, and one of the chief leaders of the aristocratic party. He was a man of education and learning, and Cicero speaks highly of him as an orator.

6. **QUINTUS CÆCILIUS METELLUS PIUS**, so called from his efforts to bring about the recall of his father Numidicus from exile. He was one of the commanders in the Social War, and defeated Q. Pompeius Silo, the Marsian leader (88). Sulla, on his departure for Asia, gave him proconsular command over south Italy. When Marius returned to Italy and joined Cinna, the soldiers, who had no confidence in the consul Gnaeus Octavius, wished Metellus to take command, but he refused. The soldiers deserted in large numbers, and considering it impossible to defend Rome, Metellus retired to Africa and afterwards to Liguria, resuming his former proconsular command on Sulla's return. In the war against Marius he gained several important successes, and after his victory over C. Norbanus at Faventia (82) he subdued the whole of upper Italy. Consul in 80 with Sulla, he went to Spain next year against Sertorius, who pressed him hard till the arrival of Pompey in 76. Next year Metellus defeated Sertorius's lieutenant Hirtuleius at Italica and Segovia, and joining Pompey rescued him from the consequences of a check at Sucro. From this time Sertorius grew weaker till his murder in 72. In 71 Metellus returned to Rome and triumphed. He became pontifex maximus, and died probably at the end of 64. He was an upright man, of moderate ability.

7. **QUINTUS CÆCILIUS METELLUS CELER**, legate of Pompey in Asia 65 B.C., praetor 63. He was despatched to cut off the retreat of Catiline to the north by blocking the passes, and in 62 went into the province of Cisalpine Gaul with the title of proconsul, although he did not become consul till 60. A strong supporter of the optimates and an enemy of Pompey, he strenuously opposed the agrarian law brought forward by the tribune Lucius Flavius, to provide for Pompey's veterans, and stood firm even though imprisoned; the law had to be given up. He also tried, though fruitlessly, to obstruct Caesar's agrarian law in 59. He died suddenly in the same year—it was usually supposed from poison administered by his wife Clodia.

8. **QUINTUS CÆCILIUS METELLUS NEPOS**, son of a Metellus of the same name, so called because he was the grandson of (4). He was legate to Pompey in the war against the Mediterranean pirates (67), and took part in the Syrian campaign. In 63 he returned to Rome, to assist Pompey in carrying out his plans. He violently attacked Cicero, and refused to allow him to deliver the customary speech on laying down office as consul; he even threatened to impeach him for having executed Roman citizens (referring to the Catilinarian conspirators) without a trial. In 62 his proposal that Pompey should be summoned to Italy to restore order was bitterly opposed by Cato, and on the day set down for the bill a fight took place in the forum. Metellus fled to Pompey, but soon returned with him to Rome. In 60, when praetor, he proposed a law for the abolition of the *rectigalia* in Italy. In 57 he was consul, but offered no opposition to the return of Cicero from exile. In 56 he was governor of Hither Spain, where he was engaged in hostilities against the Vaccaei with indifferent success. He appears to have died in Rome in the following year. He was a mere creature of Pompey.

9. **QUINTUS CÆCILIUS METELLUS PIUS SCIPIO**, son of P. Scipio Nasica, was adopted by (6). He was accused of bribery in 60 B.C., and defended by Cicero, to whom he had rendered valuable assistance during the Catilinarian conspiracy. In August 52, he became consul through the influence of Pompey, who had married his daughter Cornelia. In 49 he proposed that Caesar should disband his army within a definite time, under pain of being declared an enemy of the state. After the outbreak of the civil war, the province of Syria was assigned to

him, and he was about to plunder the temple of Artemis at Ephesus when he was recalled by Pompey. He commanded the centre at Pharsalus, and afterwards went to Africa, where by Cato's influence he received the command. In 46 he was defeated at Thapsus; while endeavouring to escape to Spain he fell into the hands of P. Sittius, and put himself to death. His connexion with two great families gave him importance, but he was selfish and licentious, wanting in personal courage, and his violence drove many from his party.

10. QUINTUS CAECILIUS METELLUS, surnamed *Creticus*, Roman general. Consul in 60 B.C., he was appointed to the command of the war against Crete, the headquarters of the pirates of the Mediterranean. Its subjugation proceeded slowly but surely until 67, when Pompey claimed the control of affairs in virtue of the powers conferred upon him by the Gabinian law. Thereupon the Cretans, who had been treated with great harshness by Metellus, offered to surrender to Pompey, who enjoyed a reputation for leniency towards the conquered. Pompey accepted the offer and sent instructions to Metellus to suspend operations. Metellus refused and completed the conquest of the island, which was annexed to Cyrene and became a Roman province. On Metellus's return to Rome the partisans of Pompey succeeded in keeping him out of a triumph until after the Catilinarian conspiracy, when he made his entry into the city and received the name *Creticus* in honour of his achievements. Metellus naturally joined the senatorial party in their opposition to Pompey, and had the satisfaction of preventing the ratification of what he had done in Asia. He was one of a commission of three sent (60) to investigate the state of affairs in Gaul, where disturbances were apprehended. He appears to have been alive in 54, but nothing further is known of him.

On the family of the Metelli generally, see M. Wende, *De Caeciliis Metellis*, i. (Bonn, 1875), for its history up to the time of the Gracchi the new edition by P. Gröbe of Drumann's *Geschichte Roms*, ii.; and the article s.v. "Caecilius" by F. Münzer in Pauly-Wissowa's *Realencyclopädie der classischen Altertumswissenschaft*, iii. pt. I (1897).

METEMPSYCHOSIS (*Gr. μετεψυχωσις*), or TRANSMIGRATION OF THE SOUL, the doctrine that at death the soul passes into another living creature, man, animal, or even plant. This doctrine, famous in antiquity and still held as a religious tenet by certain sects of the civilized world, has its roots far back in primitive culture. It is developed out of three universal savage beliefs: (1) that man has a soul, connected in some vague way with the breath, which can be separated from his material body, temporarily in sleep, permanently at death; (2) that animals and even plants have souls, and are possessed to a large extent of human powers and passions; (3) that souls can be transferred from one organism to another. Innumerable examples might be mentioned of the notion that a new-born child is the reincarnation of someone departed, as in Tibet the soul of the Dalai-Lama is supposed to pass into an infant born nine months after his decease. Transmigration of human souls into non-human bodies is implied in totemism (*q.v.*), for, as Professor Frazer says, "it is an article of faith that as the dan sprang from the totem, so each clansman at death reassumes the totem form." All these savage notions are to be regarded as presuppositions of metempsychosis, rather than identified with that doctrine itself as a reasoned theory.

Till full investigation of Egyptian records put us in possession of the facts, it was supposed that the Egyptians believed in metempsychosis, and Herodotus (ii. 123) explicitly credits them with it. We now know that he was wrong. All that they believed was that certain privileged souls might in the other world be able to assume certain forms at pleasure, those of a sparrow-hawk, lily, &c. Herodotus misunderstood the Egyptians to hold beliefs identical with those which were current in his day in Greece. In India, on the contrary, the doctrine was thoroughly established from ancient times; not from the most ancient, as it is not in the Vedas; but onwards from the Upanishads. In them it is used for moral retribution: he who kills a Brahman is, after a long progress through dreadful hells, to be reborn as a dog, pig, ass, camel, &c. This we always find in metempsychosis as a reasoned theory. It is formed by combina-

tion of two sets of ideas which belong to different planes of culture: the ideas of judgment and punishment after death elaborated in a relatively cultured society by a priestly class are combined with ideas, like that of totem-transmigration, proper to a savage society. In India we may explain the whole phenomenon as an infusion of the lower beliefs of the non-Aryan conquered races into the higher religious system of their Aryan conquerors. In later Hinduism metempsychosis reached a monstrous development; according to Monier-Williams it was believed that there were 8,400,000 forms of existence through which all souls were liable to pass before returning to their source in the Deity. Buddhism appeared as a reaction against all this, and sought by a subtle modification to harmonize the theory with its own pessimistic view of the world. According to Buddhism there is no soul, and consequently no metempsychosis in the strict sense. Something, however, is transmitted, *i.e.* Karma (character), which passes from individual to individual, till in the perfectly righteous man the will to live is extinguished and that particular chain of lives is brought to an end.

We do not know exactly how the doctrine of metempsychosis arose in Greece; it cannot, as was once supposed, have been borrowed from Egypt and is not likely to have come from India. It is easiest to assume that savage ideas which had never been extinguished were utilized for religious and philosophic purposes. The Orphic religion, which held it, first appeared in Thrace upon the semi-barbarous north-eastern frontier. Orpheus, its legendary founder, is said to have taught that "soul and body are united by a compact unequally binding on either; the soul is divine, immortal and aspires to freedom, while the body holds it in fetters as a prisoner. Death dissolves this compact, but only to re-imprison the liberated soul after a short time: for the wheel of birth revolves inexorably. Thus the soul continues its journey, alternating between a separate unrestrained existence and fresh reincarnation, round the wide circle of necessity, as the companion of many bodies of men and animals. To these unfortunate prisoners Orpheus proclaims the message of liberation, that they stand in need of the grace of redeeming gods and of Dionysus in particular, and calls them to turn to God by ascetic piety of life and self-purification: the purer their lives the higher will be their next reincarnation, until the soul has completed the spiral ascent of destiny to live for ever as God from whom it comes." Such was the teaching of Orphism which appeared in Greece about the 6th century B.C., organized itself into private and public mysteries at Eleusis and elsewhere, and produced a copious literature.

The earliest Greek thinker with whom metempsychosis is connected is Pherecydes; but Pythagoras, who is said to have been his pupil, is its first famous philosophic exponent. Pythagoras probably neither invented the doctrine nor imported it from Egypt, but made his reputation by bringing Orphic doctrine from North-Eastern Hellas to Magna Graecia and by instituting societies for its diffusion.

The real weight and importance of metempsychosis is due to its adoption by Plato. Had he not embodied it in some of his greatest works it would be merely a matter of curious investigation for the anthropologist and student of folk-lore. In the eschatological myth which closes the *Republic* he tells the story how Er, the son of Armenius, miraculously returned to life on the twelfth day after death and recounted the secrets of the other world. After death, he said, he went with others to the place of Judgment and saw the souls returning from heaven and from purgatory, and proceeded with them to a place where they chose new lives, human and animal. "He saw the soul of Orpheus changing into a swan, Thamyras becoming a nightingale, musical birds choosing to be men, the soul of Atalanta choosing the honours of an athlete. Men were seen passing into animals and wild and tame animals changing into each other." After their choice the souls drank of Lethe and then shot away like stars to their birth. There are myths and theories to the same effect in other dialogues, the *Phaedrus*, *Meno*, *Phaedo*, *Timaeus* and *Lysis*. In Plato's view the number of souls was fixed;

of August, the radiant having a daily motion of about 1° R.A. to E.N.E. The Lyrids also vary in the position of their radiant, but the Orionids form a stationary position from about the 9th to the 24th of October. A large proportion of the ordinary feeble showers also appear to be stationary.

Solid bodies (chiefly stone or stone and iron) enter the atmosphere from without at all conceivable angles and at a velocity of about 26 m. per second, while the earth's orbital velocity is about 18½ m. per second. In thus rapidly penetrating the air heat is generated, the meteor becomes incandescent, and the phenomena of the streak or train is produced. Before the object can pierce the dense lower strata of air its material is usually exhausted, but on rare occasions it withstands the fiery ordeal, and fragments of the original mass fall upon the earth.

Multitudes of meteors infest space. On a clear moonless night one person may count eight or ten shooting stars in an hour. But there are more than twice as many visible in the early morning hours as in the evenings, and during the last half of the year there are also more than twice as many visible as during the first half. It is computed that twenty millions of meteors enter the atmosphere every day and would be visible to unassisted vision in the absence of sunlight, moonlight and clouds, while if telescopic meteors are included the number will be increased twentyfold. Ordinary meteors, in the region of the earth's orbit, appear to be separated by intervals of about 250 m. In special showers, however, they are much closer. In the rich display of the 12th of November 1833, the average distance of the particles was computed as about 15 m., in that of the 27th of November 1885 as about 20 m., and in that of the 27th of November 1872 as about 35 m.

The meteors, whatever their dimensions, must have motions around the sun in obedience to the law of gravitation in the same manner as planets and comets—that is, in conic sections of which the sun is always at one focus. The great variety in the apparent motions of meteors proves that they are not directed from the plane of the ecliptic; hence their orbits are not like the orbits of planets and short-period comets, which are little inclined, but like the orbits of parabolic comets, which often have great inclinations.

Historical records supply the following dates of abundant meteoric displays:—

902, Oct. 13.	1101, Oct. 17.	1602, Oct. 28.	1833, Nov. 13.
931, Oct. 14.	1202, Oct. 19.	1698, Nov. 9.	1866, Nov. 14.
934, Oct. 14.	1366, Oct. 23.	1799, Nov. 12.	1867, Nov. 14.
1002, Oct. 15.	1533, Oct. 25.	1832, Nov. 13.	1868, Nov. 14.

These showers occurred at intervals of about one-third of a century, while the day moved along the calendar at the rate of one month in a thousand years. The change of style is, however, responsible for a part of the alteration in date. The explanation of these recurring phenomena is that a great cloud or distended stream of meteors revolves around the sun in a period of 33½ years, and that one portion of the elliptical orbit intersects that of the earth. As the meteors have been numerous visible in five or six successive years it follows they must be pretty densely distributed along a considerable arc of their orbit. It also follows that, as some of the meteors are seen annually, they must be scattered around the whole orbit. Travelling at the rate of 26 m. per second, they encounter the earth moving 18½ m. per second in an opposite direction, so that the apparent velocity of the meteors is about 44 m. per second. They radiate from a point within the Sickle of Leo and are termed Leonids. In 1867 the remarkable discovery was made that Tempel's comet (1866 : L) revolved in an orbit identical with that of the Leonids. That the comet and meteors have a close physical association seems certain. The disintegrated and widely dispersed material of the comet forms the meteors which embellish our skies on mid-November nights.

Fine meteoric showers occurred in 1798 (Dec. 7), 1838 (Dec. 7), 1872 (Nov. 27), 1885 (Nov. 27), 1892 (Nov. 23) and 1899 (Nov. 23 and 24), and the dates indicate an average period of 6.7 years for fifteen returns. The meteors move very slowly,

as they have to overtake the earth, and their apparent velocity is only about 9 m. per second. They are directed from a point in the sky near the star γ Andromedæ. Biela's comet of 1826, which had a period of 6.7 years, presented a significant resemblance of orbit with that of the meteors, but the comet has not been seen since 1852 and has probably been resolved into the meteoric stream of Andromedids.

Rich annual displays of meteors have often been remarked on about the 10th of August, directed from Perseus, but they do not appear to have exhibited periodical maxima of great strength. They are probably dispersed pretty evenly along a very extended ellipse agreeing closely in its elements with comet 1862 : III. But the times of revolution are doubtful; the probable period of the comet is 121 years and that of the meteors 10½ years. This shower of Perseids is notable for its long duration in the months of July and August and for its moving radiant.

There was a brilliant exhibition of meteors on the 20th of April 1803, and in other years meteors have been very abundant on about the 19th to the 21st of April, shooting from a radiant a few degrees south-west of α Lyrae. The display is apparently an annual one, though with considerable differences in intensity, and the cycle of its more abundant returns has not yet been determined. A comet which appeared in 1861 had a very suggestive agreement of orbit when compared with that of the meteors, and the period computed for it was 41.5 years.

Apart from the instances alluded to there seem few coincidences between the orbital elements of comets and meteors. Halley's comet conforms very well, however, with a meteoric shower directed from Aquarius early in May. But there are really few comets which pass sufficiently near the earth to give rise to a meteoric shower. Of 80 comets seen during the 20 years ending 1803, Professor Herschel found that only two, viz. Denning's comet of 1881 and Finlay's of 1886, approached comparatively near to the earth's path, the former within 3,000,000 m. and the latter within 4,600,000 m.

Radiants of Principal Showers.—The following is a list of the chief radiant points visible during the year:—

Date.	Radiant R.A. Dec.	Date.	Radiant R.A. Dec.
Jan. 2-3	230° +53°	July-Sept.	47° +43°
Feb. 10-15	75° +41°	Sept. 5-15	62° +37°
March 1-4	166° + 4°	Sept. 3-22	74° +41°
March 24	161° +58°	Oct. 2	230° +52°
April 19-22	271° +33°	Oct. 4	310° +79°
April-May	193° +58°	Oct. 15-24	92° +15°
May 1-6	338° - 2°	Oct. 20-25	100° +13°
May 15-18	231° +27°	Oct. 30-Nov. 1	43° +22°
May-July	252° -21°	Nov. 2	58° + 9°
June 13	310° +61°	Nov. 14-16	151° +22°
July 15-19	314° +48°	Nov. 16-28	154° +40°
July 28-30	339° -11°	Nov. 20-23	63° +22°
Aug. 9-13	45° +57°	Nov. 17-23	25° +43°
Aug. 10-15	290° +53°	Dec. 4	162° +58°
Aug. 21-25	291° +60°	Dec. 9-12	108° +33°

Many meteors exhibit the green line of magnesium as a principal constituent. Professor N. von Konkoly remarked in the fireball of 1873 (July 26) the lines of magnesium and sodium. Other lines in the red and green have been detected and found by comparison with the lines of marsh gas. Bright meteors often emit the bluish-white light suggestive of burning magnesium. In addition to magnesium and sodium the lines of potassium, lithium and also the carbon flutings exhibited in cometary spectra, have been seen.

Meteor observation has depended upon rough and hurried eye estimates in past years, but the importance of attaining greater accuracy by means of photography has been recognized. At several American observatories, and at Vienna, fairly successful attempts were made in November 1898 to photograph a sufficient number of meteor-trails to derive the Leonid radiant, and the mean position was at R.A. 151° 33' Dec. + 22° 12'. But the materials obtained were few, the shower having proved inconspicuous. The photographic method appears to have practically failed during recent years, since there has

been no brilliant display upon which to test its capacity. Really large meteors can be satisfactorily photographed, but small ones leave no impression on the plates.

Meteors look larger than they are, from the glare and flaming effect due to their momentary combustion. The finer meteors on entering the air only weigh a few hundred or, at most, a few thousand pounds, while the smallest shooting stars visible to the eye may probably be equal in size to coarse grains of sand, and still be large enough to evolve all the light presented by them. (W. F. D.)

METEORA, a group of monasteries in Thessaly, in the northern side of the Peneius valley, not quite 20 m. N.E. of Trikkala, and near the village of Kalabaka (the ancient Aeginium, medieval Stagou or Stagi). From the Cambrian chain two masses of rock are thrust southward into the plain, surmounted by isolated columns from 85 to 300 ft. high, "some like gigantic tusks, some like sugar-loaves, and some like vast stalagmites," but all consisting of iron-grey or reddish-brown conglomerate of gneiss, mica-slate, syenite and greenstone. The monasteries stand on the summit of these pinnacles; they are accessible only by aid of rope and net worked by a windlass from the top, or by a series of almost perpendicular ladders climbing the cliff. In the case of St Stephen's, the peak on which it is built does not rise higher than the ground behind, from which it is separated by a deep, narrow chasm, spanned by a drawbridge. Owing to the confined area, the buildings are closely packed together; but each monastery contains beside the monks' cells and water-cisterns, at least one church and a refectory, and some also a library. At one time they were fourteen in number, but now not more than four (the Great Monastery, Holy Trinity, St Barlaam's and St Stephen's) are inhabited by more than two or three monks. The present church of the Great Monastery was erected, according to Leake's reading of the local inscription, in 1388 (Björnsthål, the Swedish traveller, had given 1371), and it is one of the largest and handsomest in Greece. A number of the manuscripts from these monasteries have now been brought to the National Library at Athens: Aeginium is described by Livy as a strong place, and is frequently mentioned during the Roman wars; and Stagou appears from time to time in Byzantine writers.

See W. M. Leake, *Northern Greece* (4 vols., London, 1835); Professor Kriegk in *Zeitschr. f. allg. Erdk.* (Berlin, 1858); H. F. Tozer, *Researches in the Highlands of Turkey* (1869); L. Heuzey and H. Daumet, *Mission archéologique de Macédoine* (Paris, 1876), where there is a map of the monasteries and their surroundings; *Guide-Joanne; Grèce*, vol. ii. (Paris, 1891).

METEORITE, a mass of mineral matter which has reached the earth's surface from outer space. Observation teaches that the fall of a meteorite is often preceded by the flight of a fireball (see METEOR) through the sky, and by one or more loud detonations. It was inferred by Chladni (1794) that the fireball and the detonations result from the quick passage of the meteorite through the earth's atmosphere.

The fall of stones from the sky, though not credited by scientific men till the end of the 18th century, had been again and again placed on record. One of the most famous of meteorites fell in Phrygia and was worshipped there for many generations under the name of Cybele, the mother of the gods. After an oracle had declared that possession of the stone would secure to the Romans a continual increase of prosperity, it was demanded by them from King Attalus about the year 204 B.C., and taken with great ceremony to Rome. It is described by the historian as "a black stone, in the figure of a cone, circular below and ending in an apex above." Plutarch relates the fall of a stone in Thrace about 470 B.C., during the time of Pindar, and according to Pliny the stone was still preserved in his day, 500 years afterwards. Both Diana of the Ephesians "which fell down from Jupiter," and the image of Venus at Cyprus, appear to have been conical or pyramidal stones. One of the holiest relics of the Moslems is preserved at Mecca, built into a corner of the Kaaba; its history goes back far beyond the 7th century; the description of it given to Dr Pertsch suggests that the stone had fallen from the sky. The oldest existing meteorite of which

the fall is known to have been observed is that which fell at Ensisheim in Elsass on the 10th of November 1492. It was seen to strike the ground and was immediately dug out; it had penetrated to a depth of 5 ft. and was found to weigh 260 lb. It was long suspended by a chain from the roof of the parish church, and is now kept in the Rathhaus of the town.

It was not till scientific men gave credence to the reports of the fall of heavy bodies from the sky that steps were taken for the formation of meteorite collections. The British Museum (Natural History) at South Kensington now contains specimens belonging to 566 distinct falls; of these falls 325 have been actually observed; the remaining specimens are inferred to have come from outer space, because their characters are similar to those of the masses which have been seen to fall. Of these meteorites the following twelve have fallen within the British Isles:—

	Place.	Date.
In England.	Wold Cottage, Thwing, Yorkshire	Dec. 13, 1795.
	Launton, Oxfordshire	Feb. 15, 1830.
	Aldsworth, Gloucestershire	Aug. 4, 1835.
	Rotton, Shropshire	April 20, 1876.
	Middlesbrough, Yorkshire	March 4, 1881.
In Scotland.	High Possil, Glasgow	April 5, 1804.
	Perth	May 17, 1830.
In Ireland.	Moorestown, Tipperary	Aug. 1810.
	Adare, Limerick	Sept. 10, 1813.
	Killetter, Tyrone	April 29, 1844.
	Dundrum, Tipperary	Aug. 12, 1865.
	Crumlin, Antrim	Sept. 13, 1902.

Meteorite falls are independent of thunderstorms and all other terrestrial circumstances; they occur at all hours of the day and night, and at all seasons of the year; they favour no particular latitudes. The number of stones which reach the ground from one fireball is very variable. In each of the two Yorkshire falls only one stone was found; the Guernsey County meteorite yielded 30; at Toulouse, as many as 350 are estimated to have fallen; at Hesse, over 500; at Knyahinya, more than 1000; at L'Aigle, from 1000 to 2000; at both Pultusk and Mocs no fewer than 100,000 are estimated to have reached the earth's surface. The largest single mass seen to fall is one of those which came down at Knyahinya, Hungary, in 1866, and weighed 547 lb; but far larger masses, inferred from their characters to be meteorites, have been met with. The larger of the Cranbourne masses, now in the British Museum (Natural History), before rusting weighed 3½ tons; the largest of the masses brought by Lieut. Peary from western Greenland weighs 367 tons. A mass found at Bacubirito in Mexico is 13 ft. long, 6 ft. wide and 5 ft. thick, and is estimated to weigh 50 tons.

From observations of the path and time of flight of the luminous meteor it is calculated that meteorites enter the earth's atmosphere with absolute velocities ranging from 10 to 45 m. a second; but the speed of a meteorite after the whole of the resisting atmosphere has been traversed is extremely small and comparable with that of an ordinary falling body. According to Professor A. S. Herschel's experiments, the meteorite which fell at Middlesbrough must have struck the ground with a velocity of only 412 ft. a second. In the case of the Hesse fall, several stones fell on the ice, which was only a few inches thick, and rebounded without breaking the ice or being broken themselves. The depth to which a meteorite penetrates depends on the speed, form, weight and density of the meteorite and on the nature of the ground. At Stannern a meteoric stone weighing 2 lb entered to a depth of only 4 in.; the large Knyahinya stone already mentioned made a hole 11 ft. deep.

The area of the earth's surface occupied by towns and villages being comparatively small, the probability of a shower of stones falling within a town is extremely minute; the likelihood of a living creature being struck is still more remote. The first Yorkshire stone, that of Wold Cottage, struck the ground only 10 yds. from a labourer; the second, that of Middlesbrough, fell on the railroad only 40 yds. away from some platelayers at

work; a stone completely buried itself in the highway at Kaba; one fell between two carters on the road at Charsonville, throwing the ground up to a height of 6 ft.; the Tourinnes-la-Grosse meteorite broke the pavement and was broken itself; the Krähengberg stone fell within a few paces of a little girl; the Angers stone fell close to a lady standing in her garden; the Braunau mass went through the roof of a cottage; at Macao, in Brazil, where there was a shower of stones, some oxen are said to have been killed; at Nedagolla, in India, a man was so near that he was stunned by the shock; while at Mhow, also in India, a man was killed in 1827 by a stone which is a true meteorite, and is represented by fragments in museum collections.

Though the surface of a meteoric stone becomes very hot during the early part of the flight through the air, it is cooled again during the later and slower part of the flight. Meteorites are generally found to be warm to the touch if immediately dug out; at the moment of their impact they are not hot enough to char woody fibre on which they chance to fall, nor is the surface then soft, for terrestrial matter with which the surface comes into contact makes no impression upon the meteorite. Where many stones fall at the same time they are generally distributed over a large area elongated in the direction of the flight of the luminous meteor, and the largest stones generally travel farthest. At Hesse, for instance, the stones were distributed over an area of 10 m. long and 3 m. broad.

Meteorites are almost invariably found to be completely covered with a thin crust such as would be caused by intense heating of the material for a short time; its thinness shows the slight depth to which the heat has had time to penetrate. They are presumably cold and invisible when they enter the earth's atmosphere, and become heated and visible during their passage through the air; doubtless the greater part of the superficial material flicks off as the result of the sudden heating and is left behind floating in the air as the trail of the meteor. The crust varies in aspect with the mineral composition of the meteorite; it is generally black; it is in most cases dull but is sometimes lustrous; more rarely it is dark-grey in colour. Each stone of a shower is in general completely covered with crust; but occasionally, as in the case of the Butsura fall, stones found some miles apart fit each other closely and the fitting surfaces are uncrusted, showing that a meteorite may break up during a late and cool stage of the flight through the atmosphere. A meteorite is generally covered with pittings which have been compared in size and form to thumbmarks; the pittings are probably caused by the unequal conductivity, fusibility and fragility of the superficial material. As picked up, complete and covered with crust, meteorites are always irregularly-shaped fragments, such as would be obtained on breaking up a rock presenting no regularity of structure.

About one-third, and those the most common, of the chemical elements at present recognized as constituents of the earth's crust have been met with in meteorites; no new chemical element has been discovered. The most frequent or plentiful in their occurrence are: aluminium, calcium, carbon, iron, magnesium, nickel, oxygen, phosphorus, silicon and sulphur; while less frequently or in smaller quantities are found antimony, arsenic, chlorine, chromium, cobalt, copper, hydrogen, lithium, manganese, nitrogen, potassium, sodium, strontium, tin, titanium, vanadium. The existence of minute traces of several other elements has been announced; of these special mention may be made of gallium, gold, iridium, lead, platinum and silver. Iron occurs chiefly in combination with nickel, and phosphorus almost always in combination with both nickel and iron (schreibersite); carbon occurs both as indistinctly crystallized diamorph and as graphitic carbon, the latter generally being amorphous, but occasionally having the forms of cubic crystals (cliftonite); free phosphorus has been found in one meteorite; free sulphur has also been observed, but may have resulted from the decomposition of a sulphide since the fall of the stone.

Of the mineral constituents of meteorites, the following are by many mineralogists regarded as still unrepresented among native

terrestrial products: *cliftonite*, a cubic form of graphitic carbon; *phosphorus*; various alloys of nickel and iron; *moissanite*, silicide of carbon; *cohenite*, carbide of iron and nickel (corresponding to cementite, carbide of iron, found in artificial iron); *schreibersite*, phosphide of iron and nickel; *troilite*, protosulphide of iron; *oldhamite*, sulphide of calcium; *osbornite*, oxysulphide of calcium and titanium or zirconium; *daubréfite*, sulphide of iron and chromium; *lawrencite*, protochloride of iron; *asmanite*, a species of silica; *maskelynite*, a singly refractive mineral with the chemical composition of labradorite; *weinbergerite*, a silicate intermediate in chemical composition to pyroxene and nepheline.

Of these troilite is perhaps identical with some varieties of terrestrial pyrrhotite; asmanite has characters which approach very closely to those of terrestrial tridymite; maskelynite, according to one view, is the result of fusion of labradorite, according to another view, is an independent species chemically related to leucite. Other compounds are present corresponding to the following terrestrial minerals: olivine and forsterite; enstatite and bronzite; diopside and augite; anorthite, labradorite and oligoclase; magnetite and chromite; pyrites; pyrrhotite; brunnerite. Quartz (silica), the most common of terrestrial minerals, is absent from the stony meteorites; but from the Toluca meteoric iron microscopic crystals have been obtained of which some have certain resemblances to quartz, and others to zircon. Free silica is present in the Breitenbach meteorite but as asmanite. In addition to the above there are several compounds or mixtures of which the nature has not yet been satisfactorily ascertained.

Meteorites are conveniently distributed into three classes, which pass more or less gradually into each other: the first (siderites or meteoric irons) includes all those which consist mainly of metallic iron alloyed with nickel; only nine of them have been actually seen to fall; the second (siderolites) includes those in which metallic iron (alloyed with nickel) and stony matter are present in large proportion; few of them have been seen to fall; those of the third class (aerolites or meteoric stones) consist almost entirely of stony matter; nearly all have been seen to fall.

In the meteoric iron the iron generally varies from 80 to 95% and the nickel from 6 to 10%; the latter is generally alloyed with the iron, and several alloys or mixtures have been distinguished by special names (kamacite, taenite, plesseite). Troilite is frequently present as plates, veins or large nodules, sometimes surrounded by graphite; schreibersite is almost always present, and occasionally also daubréfite. The compositeness and the structure of meteoric iron are well shown by the figures generally called into existence when a polished surface is etched by means of acids or bromine-water; they are due to the inequality of the etching action on thick and thin plates of various constituents, the plates being composed chiefly of two nickel-iron materials (kamacite and taenite). A third nickel-iron material (plesseite) fills up the spaces formed by the intersection of the joint plates of kamacite and taenite; it is probably not an independent substance but an intimate intergrowth of kamacite and taenite. The figures were first observed in 1808 and are generally termed "Widmanstätten figures" in honour of their discoverer; the plates which give rise to them are parallel to the faces of the regular octahedron, and such masses have therefore an octahedral structure. A small number of the remaining masses have cubic cleavage; instead of Widmanstätten figures they yield fine linear furrows when etched; the furrows were found by Neumann in 1848 to have directions such as would result from twinning of the cube about an octahedral face; they are known as "Neumann lines." For meteoric irons of cubic structure the percentage of nickel is lower than 6 or 7; for those of octahedral structure it is higher than 6 or 7; the plates of kamacite are thinner, and the structure therefore finer the higher the percentage of that metal. A considerable number of meteoric irons, however, show no crystalline structure at all, and have percentages of nickel both below and above; it has been suggested that each of these masses may once have had crystalline structure and that it has disappeared as a result of prolonged heating throughout the mass while the meteorite has been passing near a star.

An investigation of the changes of the magnetic permeability of the Sacramento meteoric iron with changing temperature led Dr S. W. J. Smith to infer that the magnetic behaviour can only be explained by imagining the meteorite to consist

largely of plates of nickel-iron containing about 7% of nickel (kamacite), separated from each other by thin plates of a nickel-iron constituent (taenite), containing about 27% of nickel and having different thermomagnetic characters from those of kamacite; he suggests, however, that taenite is not a definite chemical compound but a eutectic mixture of kamacite and a nickel-iron compound containing not less than 37% of nickel.

About eleven out of every twelve of the known meteoric stones belong to a division to which Rose gave the name "chondritic" (*χόνδρος*, a grain); they present a very fine-grained but crystalline matrix or paste, consisting of olivine and enstatite or bronzite, with more or less nickel-iron, troilite, chromite, augite and triclinic feldspar; through this paste are disseminated round chondrules of various sizes and generally with the same mineral composition as the matrix; in some cases the chondrules consist wholly or in great part of glass. Some meteorites consist almost solely of chondrules; others contain only few; in some cases the chondrules are easily separable from the surrounding material. In mineral composition chondritic meteorites approximate more or less to terrestrial herzolites.

A few meteorites belonging to the chondritic division are remarkable as containing carbon in combination with hydrogen and oxygen; those of Alais and Cold Bokkeveld are good examples.

The remaining meteoric stones are without chondrules and contain little or no nickel-iron; of these the following may be mentioned as illustrative of the varieties of mineral composition: *Juvinas*, consisting essentially of anorthite and augite; *Petersburg*, of anorthite, augite and olivine, with a little chromite and nickel-iron (both Juvinas and Petersburg may be compared to terrestrial basalt); *Shergholly*, chiefly of augite and maskelynite; *Angra dos Reis*, almost wholly of olivine, but olivine is present in small proportion; *Buste*, of diopside, enstatite and a little triclinic feldspar, with some nickel-iron, oldhamite and osbornite; *Bishopville*, of enstatite and triclinic feldspar, with occasional augite, nickel-iron, troilite and chromite; *Roda*, of olivine and bronzite; and *Chassigny*, consisting of olivine with enclosed chromite, and thus mineralogically identical with terrestrial dunite.

Almost all meteoric stones appear to be made up of irregular angular fragments, and some of them bear a close resemblance to volcanic tuffs. In the large group of chondritic stones, chondrules or spherules, some of which can only be seen under the microscope while others reach the size of a walnut, are embedded in a matrix apparently made up of minute splinters such as might result from the fracture of the chondrules themselves. In fact, until recently it was thought by some mineralogists that the chondrules owe their form, not to crystallization, but to friction, and that the matrix was actually produced by the wearing down of the chondrules through frequent collision with each other as oscillating components of a comet or during repeated ejection from a volcanic vent of some small celestial body. Chondrules have been observed, however, presenting forms and crystalline surfaces incompatible with such a mode of formation, and others have been described which exhibit features resulting from mutual interference during their growth. The chondritic structure is different from anything which has yet been observed in terrestrial rocks, and the chondrules are distinct in character from those observed in perlite and obsidian. It is now generally believed that the structural features of meteoric stones are the result of hurried crystallization.

No organized matter has been found in meteorites and they have brought us, therefore, no evidence of the existence of living beings outside our own world.

AUTHORITIES.—The literature consists chiefly of memoirs dispersed through the journals of scientific societies. The following separate works may be consulted: A. Brezina, *Die Meteoriten-Sammlung d. k.-k. min. Hofkabinets in Wien* (Vienna, 1896); A. Brezina u. E. Cohen, *Die Struktur und die Zusammensetzung der Meteoriten* (Stuttgart, 1886-1887); P. S. Bigot de Meogues, *Mémoire historique et physique sur les chutes de pierres* (Orléans, 1812); Chladni, *Ueber den Ursprung der von Pallas gefundenen und anderer ihr ähnlicher Eisenmassen* (Riga, 1794), and *Ueber Feuer-Meteorite, und über die mit denselben herabgefallenen Massen* (Vienna, 1819); E. Cohen, *Meteoritenkunde* (Stuttgart, 1894-1905); L. Fletcher, *An Introduction to the Study of Meteorites*, 10th ed. (London, 1908);

E. King, *Remarks concerning Stones said to have fallen from the Clouds both in these Days and in Ancient Times* (London, 1796); S. Meunier, *Mémoires* (Paris, 1884); C. Rammelsberg, *Die chemische Natur der Meteoriten* (Berlin, 1870-1879); G. Rose, *Beschreibung und Eintheilung der Meteoriten* (Berlin, 1864); G. Tschernak, *Die mikroskopische Beschaffenheit der Meteoriten* (Stuttgart, 1883-1885); E. A. Wülfing, *Die Meteoriten in Sammlungen und ihre Literatur* (Lüdingen, 1897).

METEOROLOGY (Gr. *μετέωρα*, and *λόγος*, i.e. the science of things in the air), the modern study of all the phenomena of the atmosphere of gases, vapours and dust that surrounds the earth and extends to that unknown outer surface which marks the beginning of the so-called interstellar space. These phenomena may be studied either individually or collectively. The collective study has to do with statistics and general average conditions, sometimes called normal values, and is generally known as *Climatology* (see CLIMATE, where the whole subject of regional climatology is dealt with). The study of the individual items may be either descriptive, explanatory, physical or theoretical. Physical meteorology is again subdivided according as we consider either the changes that depend upon the motions of masses of air or those that depend upon the motions of the gaseous molecules; the former belong to hydrodynamics, and the latter are mostly comprised under thermodynamics, optics and electricity.

History.—The historical development of meteorology from the most ancient times is well presented by the quotations from classic authors compiled by Julius Ludwig Ideler (*Meteorologia veterum graecorum et romanorum*, Berlin, 1832). We owe to the Arabian philosophers some slight advance on the knowledge of the Greeks and Romans; especially as to the optical phenomena of the atmosphere. The *Meteorologia* of Aristotle (see Zeller, *Phil. der Griechen*) accords entirely with the *Philosophics* of Thomas Aquinas, the poetic songs of the troubadours, and the writings of Dante (see Kuhn's *Treatment of Nature in Dante's Divina Commedia*; London, 1897). Dante's work completed the passage from the ancient mythological treatment of nature to the more rational recognition of one creator and lawgiver that pervades modern science. The progress of meteorology has been coincident with the progress of physics and chemistry in general, as is shown by considering the works of Alhazen (1050) on twilight, Vitellio (1250) on the rainbow, Galileo (1607) on the thermometer and on the laws of inertia, on attractions and on the weight of the air, Torricelli (1642) on the barometer, Boyle (1659) on the elastic pressure of the air in all directions, Newton (1673) on optics; Cavendish (1760), elastic pressure of aqueous vapour; Black (1752), separation of carbonic acid gas from ordinary air; Rutherford (1772), separation of nitrogen; Priestley and Scheele (1775) and Cavendish (1777), separation of oxygen; Lavoisier (1783), general establishment of the character of the atmosphere as a simple mixture of gases and vapour; De Saussure's measurement of relative humidity by the accurate hair hygrometer (1780), Dalton's measurement of vapour tension at various temperatures (1800), Regnault's and Magnus's revision of Dalton's tension of water vapour (1840), Marvins's and Julhins's measurements of tension of ice vapour (1891), and the isolation of argon by Rayleigh and Ramsay (1894).

Theoretical meteorology has been, and always must be, wholly dependent on our knowledge of thermodynamics and on mathematical methods of dealing with the forces that produce the motions within the atmosphere. Progress has been due to the most eminent mathematicians at the following approximate dates: Sir Isaac Newton (1670), Leonhard Euler (1736), Pierre Simon Laplace (1780), Jean Baptiste Joseph Fourier (1815), Simon Denis Poisson (1815), Sir George Gabriel Stokes (1851), Hermann von Helmholtz (1857), Lord Kelvin (1860), C. A. Bjerknes (1868), V. Bjerknes (1906), and to their many distinguished followers.

The earliest systematic daily record of local weather phenomena that has survived is that kept by William Merle, rector of Driby, during seven years 1331-1338: the manuscript is preserved in the Digby MS., Merton College, Oxford, and

was published in facsimile by George G. Symons in 1891. Doubtless many similar monastic diaries have been lost to us. In 1653 Ferdinand II. of Tuscany organized a local system of stations and daily records which extended over and beyond northern Italy. This was the first fairly complete meteorological system in Europe. The records kept during the years 1655-1670 at the Cloister Angelus near Florence were reduced by Libri, professor of mathematics at Pisa, and published in 1830.

The history of meteorology is marked by the production of comprehensive treatises embodying the current state of our knowledge. Such were Louis Cotte's *Traité de météorologie* (Paris, 1774) and his *Mémoires sur la météorologie, supplément au traité* (1788); Ludwig Kämtz's *Lehrbuch der Meteorologie* (Halle, 1831-1836) and his *Vorlesungen* (1840); French 1842, English 1845); Sir John Herschel's *Meteorology* (London, 1849); the splendid series of memoirs by H. W. Brandes in Geher's *Physikalisches Wörterbuch* (Leipzig, 1820-1840); E. E. F. W. Schmid's *Grundriss der Meteorologie* (Leipzig, 1864); Ferrel's *Recent Advances in Meteorology* (Washington, 1885); the great works of Julius Hann, as summarized in his *Handbuch der Klimatologie* (1883; 2nd ed., Stuttgart, 1897; vol. i. English 1903) and his *Lehrbuch der Meteorologie* (Leipzig, 1901, 2nd ed. 1906); the extensive studies of J. E. Woeikoff (Voeikoff), as presented in his *Klima der Erde* (Russien 1883, German 1885) and his *Meteorologie* (Russian 1904).

The development of this science has been greatly stimulated by the regular publication of special periodicals such as the *Zeitschrift* of the Austrian Meteorological Society, 1866-1885, vol. 21 appearing with vol. 3 of the *Meteorologische Zeitschrift* of the German Meteorological Society in 1886, and since that date this journal has been jointly maintained by the two societies. The analogous journals of the Royal Meteorological Society, London, 1850 to date, the Scottish Meteorological Society, 1860 to date, the Meteorological Society of France, 1838 to date, the Italian Meteorological Society, and the American Meteorological Journal, 1885-1895, have all played important parts in the history of meteorology. On the other hand, the *Annals* of the Central Meteorological Office at Paris, the *Archiv* of the Deutsche Seewarte at Hamburg, the *Annals* and the *Repertorium* of the Central Physical Observatory at St Petersburg, the *Annales* of the Central Meteorological Office at Rome, *Bulletin of International Simultaneous Met. Obs.* and the *Monthly Weather Review* of the Weather Bureau at Washington, the *Abhandlungen* of the Royal Prussian Meteorological Institute at Berlin, the *Meteorological Papers* of the Meteorological Office, London, and the transactions of numerous scientific societies, have represented the important official contributions of the respective national governments to technical meteorology.

The recent international union for aerial exploration by kites and balloons has given rise to two important publications, i.e. the *Veröffentlichungen* of the International Commission for Scientific Aerostatics (Strassburg, 1905, et seq.), devoted to records of observations, and the *Beiträge zur Physik der freien Atmosphäre* (Strassburg, 1904, et seq.), devoted to research.

The necessity of studying the atmosphere as a unit and of securing uniform accuracy in the observations has led to the formation of a permanent International Meteorological Commission (of which in 1909 the secretary was Professor Dr G. Hellmann of Berlin, and the president Dr W. N. Shaw of London). Under its directions conferences and general congresses have been held, beginning with that of 1872 at Leipzig. Its *International Tables*, *Atlas of Clouds*, *Code of Instructions*, and *Forms for Climatological Publications* illustrate the activity and usefulness of this committee.

Modern meteorology has been developed along two lines of study, based respectively on maps of monthly and annual averages and on daily weather maps. The latter study seems to have been begun by H. W. Brandes in Leipzig, who first, about 1820, compiled maps for 1783 from the data collected in the *Ephemerides mannheimensis*, and subsequently published maps of the European storms of 1820 and 1821. Simultaneously with Brandes we find William C. Redfield in New York

compiling a chart of the hurricane of 1821, which was published in 1831, and was the first of many memoirs by him on hurricanes that completely established their rotary and progressive motion. Soon after this Piddington and Sir William Reid began their great works on the storms of the Orient. About 1825 James Pollard Espy, in Philadelphia, began the publication of his views as to the motive power of thunderstorms and tornadoes, and in 1842 was appointed "meteorologist to the U.S. government" and assigned to work in the office of the surgeon-general of the army, where he prepared daily weather maps that were published in his four successive "Reports." In 1848 the three American leaders united in letters to Professor Joseph Henry, secretary of the Smithsonian Institution, urging that the telegraph be used for collecting data for daily maps and weather predictions. Favourable action was taken in 1849, the Smithsonian maps began to be compiled about 1851 and were displayed in public from 1853 onwards. Meanwhile in England James Glaisher, with the help of the daily press, carried out similar work, publishing his first map in 1851 as soon as daily weather maps of sufficient extent could be promptly prepared by the help of the telegraph. The destructive storm of the 14th of November 1854, in the Crimea gave U. J. J. Le Verrier, at Paris, an opportunity to propose the proper action, and his proposals were immediately adopted by the secretary of war, Marshal Vaillant. On the 17th of February 1855 the emperor ordered the director-general of government telegraph lines to co-operate completely with Le Verrier in the organization of a bureau of telegraphic meteorology. The international daily bulletin of the Paris Observatory began to be printed in regular form on the 1st of January 1858, and the daily map of isobars was added to the text in the autumn of 1863. The further development of this bulletin, the inclusion of British and ocean reports in 1861, the addition of special storm warnings in 1863, the publication of the *Atlas des mouvements généraux* covering the Atlantic in 1865, the study of local thunderstorms by Hippolyte Marié-Davy, Sonrel, Fron, Peslin, in France, and the work of Fitzroy, Buys-Ballot, Buchan, Glaisher and Thomson in Great Britain, parallel the analogous works of the American students of meteorology and form the beginnings of our modern dynamic meteorology.

The details of the historical development of this subject are well given by Hugo Hildebrand-Hildebrandson and Léon Teisserenc de Bort in their joint work, *Les Bases de la météorologie dynamique* (Paris, 1898-1907). The technical material has been given by Hann in his *Lehrbuch*. Many of the original memoirs have been reproduced by Brillouin in his *Mémoires originaux* (Paris, 1900), and in Cleveland Abbe's *Mechanics of the Earth's Atmosphere* (vol. i., 1891; vol. ii., 1900).

The publication of daily weather charts and forecasts is now carried on by all civilized nations. The list of government bureaux and their publications is given in Bartholomew's *Atlas* (vol. iii., London, 1899). Special establishments for the exploration of the upper atmospheric conditions are maintained at Paris, Berlin, Copenhagen, St Petersburg, Washington and Strassburg.

The general problems of climatology (1900) are best presented in the *Handbook* of Dr Julius Hann (2nd ed., Stuttgart, 1897). The general distribution of temperature, winds and pressure over the whole globe was first given by Buchan in charts published by the Royal Society of Edinburgh in 1868, and again greatly revised and improved in the volume of the *Challenger* reports devoted to meteorology. The most complete atlas of meteorology is Buchan and Herberston's vol. iii. of Bartholomew's *Atlas* (London, 1899). Extensive works of a more special character have been published by the London Meteorological Office, and the Deutsche Seewarte for the Atlantic, Pacific and Indian Oceans. Daily charts of atmospheric conditions of the whole northern hemisphere were published by the U.S. Weather Bureau from 1875 to 1883 inclusive, with monthly charts, the latter were continued through 1889. The physical problems of meteorology were discussed in Ferrel's *Recent Advances in Meteorology* (Washington, 1885). Mathematical papers on this subject will be found in the author's collection known as *The Mechanics of the Earth's Atmosphere*; the memoirs by Helmholtz and Von Bezold contained in this collection have been made the basis of a most important work by Brillouin (Paris, 1898), entitled *Vents contigus et nuages*. A general summary of our knowledge of the mechanics and physics of the atmosphere is contained in the *Report on the International Cloud Work*, by F. H. Bigelow (Washington, 1900). The extensive *Lehrbuch* (Leipzig, 1901; 2nd ed., 1906) by Dr Julius Hann is an authoritative work. The optical

phenomena of the atmosphere are well treated by E. Mascart in his *Traité d'optique* (Paris, 1801-1898), and by J. M. Penner, *Meteorologische Optik* (1904-1907). Of minor treatises especially adapted to collegiate courses of study we may mention those by Sprung (Berlin, 1885); W. Ferrel (New York, 1890); Angot (Paris, 1898); W. M. Davis, (Boston, 1893); Waldo (New York, 1898); Van Bebbler (Stuttgart, 1890); Moore (London, 1893); T. Russell (New York), 1895. The brilliant volume by Svante Arrhenius, *Kosmische Physik* (Leipzig, 1900) contains sections on Spectroscopy, in which the new hydrodynamic methods of Bjerknes are developed.

I.—FUNDAMENTAL PHYSICAL DATA

There can be no proper study of meteorology without a consideration of the various physical properties of the atmospheric gases and vapours, each of which plays an independent part, and yet also reacts upon its neighbours.

Atmospheric air is a mixture of nitrogen, oxygen, aqueous vapour, carbonic acid gas (carbon dioxide), ammonia, argon, neon, helium, with slight traces of free hydrogen and hydro-carbons. The proportions in which these gases are present are quite constant, except that the percentage of aqueous vapour is subject to large variations. In an atmosphere that is saturated at the temperature of 90° F., as may occur in such a climate as that of Calcutta, the water may be 2½% of the whole weight of any given volume of air. When this aqueous vapour is entirely abstracted, the remaining dry gas is found to have a very uniform constitution in all regions and at all altitudes where examination has been carried out. In this so-called dry atmosphere the relative weights are about as follows: Oxygen, 23.16; nitrogen and argon, 76.77; carbonic acid, 0.04; ammonia and all other gases, less than 0.01 in the lower half of the atmosphere but probably in larger percentages at great altitudes. Of still greater rarity are the highly volatile gases, argon (*q.v.*), neon, krypton and helium (*q.v.*).

Outer Limit.—These exceedingly volatile components of the atmosphere cannot apparently be held down to the earth by the attraction of gravitation, but are continually diffusing through the atmosphere outwards into interstellar space, and possibly also from that region back into the atmosphere. There are doubtless other volatile gases filling interstellar space and occasionally entering into the atmosphere of the various stars as well as into our own; possibly the hydrogen and hydro-carbons that escape from the earth into the lower atmosphere ascend to regions inaccessible to man and slowly diffuse into the outer space. The laws of diffusion show that for each gas there is an altitude at which as many molecules diffuse inwards as outwards in a unit of time. This condition defines the outer limit of each particular gaseous atmosphere, so that we must not imagine the atmosphere of the earth to have any general boundary. The only intimation we have as to the presence of gases far above the surface of the globe come from the phenomena of the Aurora, the refraction of light, the morning and evening twilight, and especially from the shooting stars which suddenly become luminous when they pass into what we call our atmosphere. (See C. C. Twombly, "On Luminous Meteor Trails" and "On Movements of the Atmosphere at Very Great Heights," *Monthly Weather Review*, Sept. 1907.)

Such observations are supposed to show that there is an appreciable quantity of gas at the height of 100 m., where it may have a density of a millionth part of that which prevails at the earth's surface. Such matter is not a gas in the ordinary use of that term, but is a collection of particles moving independently of each other under those influences that emanate from sun and earth, which we call radiant energy. According to Strömberg this radiant energy is that of electrons from the sun, and their movements in the magnetic field surrounding the earth give rise to our auroral phenomena.

According to Professor E. W. Morley, of Cleveland, Ohio, the relative proportions of oxygen and nitrogen vary slightly at the surface of the earth according as the areas of high pressure and low pressure alternately pass over the point of observation; his remarkably exact work seems to show a possible variation of a small fraction of 1%, and he suggests that the air descending within the areas of high pressure is probably slightly poorer in oxygen. The proportion of carbonic acid gas varies appreciably with the exposure of the region to the wind, increasing in proportion to the amount of the shelter; it is greater over the land than over the sea, and it also slightly increases by night-time as compared with day, and in the summer and winter as compared with the spring and autumn months. During the year 1896 Professor S. Arrhenius in the *Phil. Mag.*, and in 1899 Professor T. C. Chamberlain in the *Amer. Geol. Jour.*, published memoirs in which they argued that a variation of several per cent. in the proportion of carbonic acid gas is quite consistent with the existence of animal and vegetable life and may explain the variations of climate during glacial periods. But the weight absorbed by the air of this gas for solar radiations is too small (C. G. Abbot, 1903) to

support this argument. The question whether free ozone exists in the atmosphere is still debated, but there seems to be no satisfactory evidence of its presence, except possibly for a few minutes in the neighbourhood of, and immediately after, a discharge of lightning. The general proportions of the principal gases up to considerable altitudes can be calculated with close approximation by assuming a quiescent atmosphere and the ordinary laws of diffusion and elastic pressure; on the other hand, actual observations show that the rapid convection going on in the atmosphere changes these proportions and brings about a fairly uniform percentage of oxygen, nitrogen and carbonic acid gas up to a height of 10 m.

Aqueous Vapours.—The distribution of aqueous vapour is controlled by temperature quite as much as by convection and has very little to do with diffusion; the law of its distribution in altitude has been well expressed by Hann by the simple formula: $\log e = \log e_0 - h/6517$ where h is the height expressed in metres and e and e_0 are the vapour pressures at the upper station and sea-level respectively. Hann's formula applies especially to observations made on mountains, but by Süring, *Wissenschaftliche Luftfahrten*, III. (Berlin, 1900) has deduced from balloon observations the following formula for the free air over Europe—

$$\log e = \log e_0 - h(1 + h/20000)/6000.$$

He has also computed the specific moisture of the atmosphere or the mixing ratio, or the number of grams of moisture mixed with 1 kilogram of dry air for which he finds the formula

$$\log m = \log m_0 - h(1 + 3h/40)/9000.$$

The relative humidity varies with altitude so irregularly that it cannot be expressed by any simple formula. The computed values of e and m are as given in the following table:—

Altitude Metres. <i>h.</i>	Relative Vapour Pressure. <i>e/e₀</i>	Relative Specific Moisture. <i>m/m₀</i>
0	1000	1000
1000	665	759
2000	431	551
3000	266	392
4000	158	264
5000	91	171
6000	50	108
7000	27	65
8000	14	38

In addition to the gases and vapours in the atmosphere, the motes of dust and the aqueous particles that constitute cloud, fog and haze are also important. As all these float in the air, slowly descending, but resisted by the viscosity of the atmosphere, their whole weight is added to the atmosphere and becomes a part of the barometric record. When the air is cooled to the dew-point and condensation of the vapour begins, it takes place first upon the atoms of dust as nuclei; consequently, air that is free from dust is scarcely to be found except within a mass of cloud or fog.

Mass.—According to a calculation published in the *U.S. Monthly Weather Review* for February 1899, the total mass of the atmosphere is 111,125,000 of the mass of the earth itself but, according to Professor R. S. Woodward (see *Science* for Jan. 1900), celestial dynamics shows that there may possibly be a gaseous envelope whose weight is not felt at the earth's surface, since it is held in dynamic equilibrium above the atmosphere; the mass of this outer atmosphere cannot exceed $\frac{1}{250}$ th of the mass of the earth, and is probably far less, if indeed it be at all appreciable.

Conductivity.—Dry air is a poor conductor of heat, its coefficient of conduction being expressed by the formula: $0.000568(1 + 0.00190l)$ where the temperature (l) is expressed in centigrade degrees. This formula states the fact that a plate of air 1 centimetre thick can conduct through its substance for every square centimetre of its area, in one second of time, when the difference of temperature between two faces of the plate is 1° C., enough heat to warm 1 gram of water 0.000568° C., or 1 gram of air 0.000230° C., or a cubic centimetre of air 0.1850° C., if that air is at the standard density for 760 millimetres of pressure and 0° C. The figure 0.1850° C. is the thermometric coefficient as distinguished from the first or calorimetric coefficient (0.000568° C.), and shows what great effect on the air itself its poor conductivity may have.

Diathermancy.—Dry air is extremely diathermanous or transparent to the transmission of radiant heat. For the whole moist atmosphere the general coefficient of transmission increases as the waves become longer; and for a zenithal sun it is about 0.4 at the violet end of the spectrum and about 0.8 at the red. By specific absorption many specific wave-lengths are entirely cut off by the vapours and gases, so that in general the atmosphere may appear to be more transparent to the short wave-lengths or violet end of the spectrum, but this is not really so. When the zenithal sun's rays fall upon a station whose barometric pressure is 760 mm., then only from 50 to 80% of the total heat reaches the earth's surface, and thus the general coefficient of transmission for the thinness of one atmosphere is usually estimated at about 60%. Of course where the rays are more oblique, or when haze, dust or cloud interfere, the transmission

is still further diminished. In general one half of the heat received from the sun by the illuminated terrestrial hemisphere is absorbed by the clearest atmosphere, leaving the other half to reach the surface of the ground, provided there be no intercepting clouds. The thermal conditions actually observed at the immediate surface of the globe during hazy and cloudy weather are therefore of minor importance in the mechanism of the whole atmosphere, as compared with the influence of the heat retained within its mass.

The transmission of solar radiation through the earth's atmosphere is the fundamental problem of meteorology, and has been the subject of many studies, beginning with J. H. Lambert and P. Bouguer. The pyrheliometer of C. S. M. Pouillet gave us our first idea of the thermal equivalent of solar radiation outside of our atmosphere or the so-called "solar constant," the value of which has been variously placed at from 2 to 4 calories per sq. cm. per minute. At present the weight of the argument is in favour of 2.1, with a fair presumption that both the intensity and the quality of the solar radiation as it strikes the upper layers of our atmosphere are slightly variable. It is also likely that this "constant" does not represent the sun proper, but the remaining energy after the sunbeam has sifted through masses of matter between the sun and our upper atmosphere, so that it may thus come to have appreciable variations.

The coefficients of absorption for specific wave-lengths were first determined by L. E. Jewell, of Johns Hopkins University, for numerous vapour lines in 1892 (see *W. B. Balliett*, No. 16). In 1904 C. G. Abbot published a table based on heliograph work at Washington showing the coefficient of atmospheric transmission for solar rays passing through a unit mass of air—namely, from the zenith to the ground. He showed that this coefficient increased with the wavelength; hence any change in the quality of the solar radiation will affect the general coefficient of transmission. The following table gives his averages for the respective wave-lengths, as deduced from ten clear days in 1901-1902 and nine clear days in 1903:—

Wave Length. microns	Coefficient of Atmospheric Transmission (Abbot).		
	1901-1902.	1903.	Mean by Weights.
0.40 violet	—	0.484	—
0.45	—	0.557	—
0.50	0.765	0.627	0.700
0.60	0.769	0.692	0.730
0.70	0.857	0.753	0.808
0.80 red	0.897	0.797	0.847
0.90	0.910	0.825	0.856
1.00	0.921	0.847	0.884
1.20	0.933	0.874	0.903
1.60	0.930	0.909	0.920
2.00	0.950	0.912	0.919

Any variation in the energy that the atmosphere receives from the sun will have a corresponding influence on meteorological phenomena. Such variations were simultaneously announced in 1903 by Charles Dufour in Switzerland and H. H. Kimball in Washington (*Monthly Weather Review*, May 1903); the latter was then conducting a series of observations with Angström's electric compensation pyrheliometer, and his conclusions have been confirmed by the work of L. Gorczyński at Prague (1901-1906) and C. G. Abbot at Washington. Kimball's pyrheliometric work on this problem is still being continued; but meanwhile Abbot and Fowle from their bolometric observations at the Smithsonian Astrophysical Observatory have deduced preliminary values of the observed total energy, or the solar constant, for numerous dates when the sky was very clear, as follows (see *Smithsonian Misc. Coll.*, xlv. 78 and xlvii. 403, 1905):—

Date.	Abbot. Calories.	Fowle. Calories.
1902 Oct. 9	2.19	2.19
" " 15	2.19	—
" " 22	2.16	—
1903 Feb. 19	2.28	2.27
" " 19	2.25	—
" March 3	2.26	—
" " 25	2.27	2.23
" " 26	2.10	—
" " 26	2.07	2.09
" April 17	1.99	2.18
" " 28	2.27	—
" " 29	1.97	1.96
" July 7	—	2.14
" Oct. 14	—	1.96
" Dec. 7	—	1.94
" " 23	—	1.99
1904 Jan. 27	—	2.02
" Feb. 11	—	2.26
" May 28	—	2.09
" Oct. 5	—	2.32
" Nov. 16	—	1.98

If the relative accuracy of these figures is 1%, as estimated by Abbot, then they demonstrate irregular fluctuations of 5%. But different observers and localities vary so much that Abbot estimates the reliability of the mean value, 2.12, to be about 10%. The causes of this variation apparently lie above our lower atmosphere and move slowly eastward from day to day, and as the variability is comparable with that of other atmospheric data, therefore conservative meteorologists at present confine their attention to the explanation of terrestrial phenomena under the assumption of a constant solar radiation. The large local changes of weather and climate are not due to changes in the sun, but to the mechanical and thermodynamic interactions of earth and ocean and atmosphere. Excellent illustrations of this principle are found in the studies of Blanford, Eliot and Walker on the monsoons of India, of Sieger (1892) on the contrasts of temperature between Europe and North America, of Hann (1904) on the anomalies of weather in Iceland, of Meinardus (1906) on periodical variations of the icebergs near Iceland.

The absorption of solar radiation by the atmosphere is apparently explained by the laws of diffuse reflection, selective diffusion and fluorescence in accordance with which each atom and molecule and particle becomes a new centre for the diffusion in all directions of the energy represented by some specific wave-length. The specific influences of carbon dioxide and water vapour are less than those of the liquid particles (and of cloud and rains) and of the great mass of oxygen.

Specific Heat.—The capacity of dry air for heat varies according as the heat increases the volume of the air expanding under constant pressure, or the pressure of the air confined in constant volume. The specific heat under constant pressure is about 1.4025 times the specific heat under constant volume. The numerical value of the specific heat under constant pressure is about 0.2375—that is to say, that number of gram-calories, or units of heat, is required to change the temperature of 1 gram of air by 1° C. This coefficient holds good, strictly speaking, between the temperatures —30° and +10° C., and there is a very slight diminution for higher temperatures up to 200°. The specific heat of moist air is larger than that of dry air, and is given by the expression $C_p'' = (0.2375 + 0.4805 x)$ where x is the number of kilograms of vapour associated with 1 kilogram of dry air. As x does not exceed 0.030 (or 30 grams) the value of C_p'' may increase up to 0.2519. The latent heat evolved in the condensation of this moisture is a matter of great importance in the formation of cloud and rain.

Radiating Power.—The radiating power of clean dry air is so small that it cannot be measured quantitatively, but the spectroscopic and bolometer demonstrate its existence. The coefficient of radiation of the moisture diffused in the atmosphere is combined with that of the particles of dust and cloud, and is nearly equal to that of an equal surface of lamp-black. From the normal diurnal change in temperature at high and low stations, it should be possible to determine the general coefficient of atmospheric radiation for the average condition of the air in so far as this is not obscured by the influence of the winds. This was first done by J. Maurer in 1885, who obtained a result in calories that may be expressed as follows: the total radiation in twenty-four hours of a unit mass of average dusty and moist air towards an enclosure whose temperature is 1° lower is sufficient to lower the temperature of the radiating air by 3.31° C. in twenty-four hours. This very small quantity was confirmed by the studies of Trabert, published in 1892, who found that 1 gram of air at 278° absolute temperature radiates 0.1655 calories per minute toward a black surface at the absolute zero. The direct observations of C. C. Hutchins on dry dusty air, as published in 1890, gave a much larger value—evidently too large. Slight changes in water, vapour and carbon dioxide affect the radiation greatly. The investigation of this subject prosecuted by Professor F. W. Very at the Allegheny Observatory, and published as "Bulletin G" of the U.S. Weather Bureau, shows the character and amount of the radiation of several gases, and especially the details of the process going on under normal conditions in the atmosphere.

Density.—The absolute density or mass of a cubic centimetre of dry air at the standard pressure, 760 millimetres, and temperature 0° C., is 0.00129305 grams; that of a cubic metre is 1.29305 kilograms; that of a cubic foot is 0.08071 lb avoirdupois. The variations of this density with pressure, temperature, moisture and gravity are given in the Smithsonian meteorological tables, and give rise to all the movements of the atmosphere; they are, therefore, of fundamental importance to dynamic meteorology.

Expansion.—The air expands with heat, and the expansion of aqueous vapour is so nearly the same as that of dry air that the same coefficient may be used for the complex atmosphere itself. The change of volume may be expressed in centigrade degrees by the formula $V_1 V_2 = V_1 (1 + 0.0003665 t)$, or in Fahrenheit degrees $V_1 V_2 = V_1 (1 + 0.000237 t)$.

Elasticity.—The air is compressed nearly in proportion to the pressure that confines it. The pressure, temperature and volume of the ideal gas are connected by the equation $p v = RT$, where T is the absolute temperature or 273° plus the centigrade temperature ρ is the barometric pressure in millimetres and v the volume of a unit mass of gas, or the reciprocal of the density of the gas. The constant R is 29.272 for dry atmospheric air when the centimetre,

the gram, the second and the centigrade degrees are adopted as units of measure, and differs for each gas. For aqueous vapour in a gaseous state and not near the point of condensation R has the value 47.061. For ordinary air in which x is the mass of the aqueous vapour that is mixed with the unit mass of dry air, the above equation becomes $p = (29.272 + 47.061x) T$. This equation is sometimes known as the equation of condensation peculiar to the gaseous state, and may also be properly called the equation of elasticity or the elastic equation for gases, as expressing the fact that the elastic pressure p depends upon the temperature and the volume. The more exact equations given by Van der Waals, Clausius, Thiesen, are not needed by us for the pressures that occur in meteorology.

Diffusion.—In comparison with the convective actions of the winds, it may be said that it is difficult for aqueous vapour to diffuse in the air. In fact, the distribution of moisture is carried on principally by the horizontal convection due to the wind and the vertical convection due to ascending and descending currents. Diffusion proper, however, comes into play in the first moments of the process of evaporation. The coefficient of diffusion for aqueous vapour from a pure water surface into the atmosphere is 0.18 according to Stefan, or 0.1980 according to Winkelmann; that is to say, for a unit surface of 1 sq. centimetre, and a unit gradient of vapour pressure of one atmosphere per centimetre, as we proceed from the water surface into the still dry air, at the standard pressure and temperature, and quantity of moisture diffused is 0.1980 grams per second. This coefficient increases with the temperature, and is 0.2822 at 49.5° C. But the gradient of vapour pressure, and therefore rate of diffusion, diminishes very rapidly at a small distance from the free surface of the water, so that the most important condition facilitating evaporation is the action of the wind.

Viscosity.—When the atmosphere is in motion each layer is a drag upon the adjacent one that moves a little faster than it does. This drag is the so-called molecular or internal friction or viscosity. The coefficient of viscosity in gases increases with the absolute temperature, and its value is given by an equation like the following: $0.000248 (1 + 0.001665t)^{1/2}$, which is the formula given by Carl Barus (*Ann. Phys.*, 1889, xxxvi.). This expression implies that for air whose temperature is the absolute zero there is no viscosity, but that at a temperature (t) of 0° C., or 273° on the absolute scale, a force of 0.000248 grams is required in order to push or pull a layer of air 1 centimetre square past another layer distant from it by 1 centimetre at a uniform rate of 1 centimetre per second.

Friction.—The general motions of the atmosphere are opposed by the viscosity of the air as a resisting force, but this is an exceedingly feeble resistance as compared with the obstacles encountered on the earth's surface and the inertia of the rising and falling masses of warm and cold air. The coefficient of friction used in meteorology is deduced from the observations of the winds and results essentially not from viscosity, but from the resistances of all kinds to which the motion of the atmosphere is subjected. The greater part of these resistances consists essentially in a dissipation of the energy of the moving masses by their division into smaller masses which penetrate the quiet air in all directions. The loss of energy due to this process and the conversion of kinetic into potential energy or pressure, if it must be called friction, should perhaps be called convective friction, or, more properly, convective resistance.

The coefficient of resistance for the free air was determined by Mohn and Ferrel by the following considerations. When the winds, temperatures and barometric pressures are steady for a considerable time, as in the trade winds, monsoons and stationary cyclones, it is the barometric gradient that overcomes the resistances, while the resulting wind is deflected to the right (in the northern hemisphere) by the influence of the centrifugal force of the diurnal rotation (ω) of the earth. The wind, therefore, makes a constant angle (α) with the direction of the gradient (G). There is also a slight centrifugal force to be considered if the winds are circulating with velocity v and radius (r) about a storm centre, but neglecting this we have approximately for the latitude

$$G \sin \alpha = 2\omega v \sin \phi, G \cos \alpha = v\omega,$$

where (α) is the coefficient connecting the wind-velocity (v) with the component of the gradient pressure in the direction of the wind. These relations give $\kappa = 2v \sin \phi / \tan \alpha$. The values of α and v are read off from the map of winds and isotherms at sea level give us the data for computing the coefficients for oceanic and continental surfaces respectively, expressed in the same units as those used for G and v . The extreme values of this coefficient of friction were found by Guldberg and Mohn to be 0.00002 for the free ocean and 0.00012 for the irregular surface of the land. For Norwegian land stations the Mohn found $\phi = 61^\circ$, $\alpha = 56.5^\circ$, $v = 0.000845$. For the center of North America Elias Loomis found $\phi = 37.5^\circ$, $\alpha = 42.2^\circ$, $\kappa = 0.000803$.

Gravity.—The weight of the atmosphere depends primarily upon the action of gravity, which gives a downward pressure to every particle. Owing to the elastic compressibility of the air, this downward pressure is converted at once into an elastic pressure

in all directions. The force of gravity varies with the latitude and the altitude, and in any exact work its variations must be taken into account. Its value is well represented by the formula due to Helmert, $g = 980.6 (1 - 0.0026 \cos 2\phi) \times (1 - fh)$, where ϕ represents the latitude of the station and h the altitude. The coefficient f is small and has a different value according as the station is raised above the earth's surface by a continent, as, for instance, on a mountain top, or by the ocean, as on a ship sailing over the sea, or in the free air, as in a balloon. Its different values are sufficiently well known for meteorological needs, and are utilized most discreetly in the elaborate discussion of the hypsometric formula published by Angot in 1899 in the memoirs of the Central Meteorological Bureau of France.

Temperature at Sea-Level.—The temperature of the air at the surfaces of the earth and ocean and throughout the atmosphere is the fundamental element of dynamic meteorology. It is best exhibited by means of isotherms or lines of equal temperature drawn on charts of the globe for a series of level surfaces at or above sea-level. It can also be expressed analytically by spherical harmonic functions, as was first done by Schösch. The normal distribution of atmospheric temperature for each month of the year over the whole globe was first given by Buchan in his charts of 1868 and of 1888 (see also the U.S. Weather Bureau "Bulletin A," of 1893, and Buchan's edition of Bartholomew's *Physical Atlas*, London, 1899). The temperatures, as thus charted, have been corrected so as to represent a uniform special set of years and the conditions at sea-level, in order to constitute a homogeneous system. The actual temperature near the ground at any altitude on a continent or island may be obtained from these charts by subtracting each one hundred metres of elevation of the ground above sea-level, or 1° F. for 350 ft. This reduction, however, applies specifically to temperatures observed near the surface of the ground, and cannot be used with any confidence to determine the temperature of points in the free air at any distance above the land or ocean. On all such charts the reader will notice the high temperatures near the ground in the interior of each of the continents in the summer season and the low temperatures in the winter season. In February the average temperatures in the northern hemisphere are not lower near the North Pole, but in the interior of Siberia and New America. In the southern hemisphere they are at the same time highest in Australia, Africa and South America. In August the average temperatures are unexpectedly high in the interior of Asia and North America, but low in Australia and Africa.

Temperature at Upper Levels.—The vertical distribution of temperature and moisture in the free air must be studied in detail in order to understand both the general and the special systems of circulation that characterize the earth's atmosphere. Many observations on mountains and in balloons were made during the 19th century in order to ascertain the facts with regard to the decrease of temperature as we ascend in the atmosphere, but it is now recognized that these observations were largely affected by local influences due to the insufficient ventilation of the thermometers and the nearness of the ground and the balloon. Strenuous efforts are being directed to the elimination of these disturbing elements, and to the continuous recording of the temperature of the free air by means of delicate thermographs carried up to great heights by small free "sounding balloons," and to lesser heights by means of kites. Many international balloon ascents have been made since 1890, and a large amount of information has been secured.

The development of the kite as a means of ascent in the atmosphere, in October, 1893, at the World's Columbian Congress at Chicago, when Professor M. W. Harrington ordered Professor C. F. Marvin of the Weather Bureau to take up the development of the Hargrave or box kite for meteorological work. At that time W. A. Eddy of Bayonne, New Jersey, was applying his "Malay" kite to raising and displaying heavy objects, and in August 1894 (at the suggestion of Professor Cleveland Abbe) he visited the private observatory of A. L. Rotch at Blue Hill and demonstrated the value of his Malay kite for aerial research. The first work done at this observatory with crude apparatus was rapidly improved upon, while at the same time Professor Marvin of the Weather Bureau was developing the Hargrave kite and auxiliary apparatus, which he brought up to the point of maximum efficiency and trustworthiness. When he reported his apparatus as ready to be used by the Weather Bureau on a large scale, Professor Willis L. Moore, as the successor of Professor Harrington, ordered its actual use at seventeen kite stations in July 1898. This was the first attempt to prepare isotherms for a special hour over a large area at some high level, such as 1 m., in the free air. Daily meteorological charts were prepared for the region covered by these observations; and it became necessary to discontinue them, and the work was done by the Weather Bureau in this line of work until the inauguration of kite work at Mount Weather in 1906. Meanwhile a special method for the reduction and study of such observations was devised by Bjerknes and Sandstrom, and was published in the *Trans. American Philosophical Society* (Philadelphia, 1906). The general average results as to temperature gradients were compiled by Dr H. C. Frankenberg and published in the United States Weather Bureau "Bulletin F.", from 1906.

were deduced the following tables, published in the *Monthly Weather Review*:—

Mean Temperature Gradients in degrees Fahrenheit per 1000 ft. from the ground up to the respective altitudes.

Stations.	1000 ft.	1500 ft.	2000 ft.	3000 ft.	4000 ft.	5000 ft.	6000 ft.
Washington, D.C.	5.6	4.4	4.0	3.5	3.2	3.0	3.1
Cairo, Ill.	9.7	6.6	6.0	4.9	4.7	4.3	—
Cincinnati, O.	13.0	6.3	6.9	5.8	5.6	4.7	4.2
Fort Smith, Ark.	7.2	7.0	6.7	5.8	3.8	—	—
Knoxville, Tenn.	8.4	6.2	6.6	5.4	5.0	—	—
Memphis, Tenn.	7.8	6.8	5.0	4.8	3.7	3.5	—
Springfield, Ill.	7.6	5.7	5.1	4.4	4.0	3.7	3.6
Cleveland, O.	5.7	4.1	3.6	3.5	4.1	4.1	4.3
Duluth, Minn.	5.2	4.8	4.6	4.6	4.3	3.8	4.6
Lansing, Mich.	7.5	6.0	4.7	4.1	3.9	3.8	—
Sault Ste Marie, Mich.	6.6	6.2	5.2	4.5	3.9	3.0	—
Dodge, Kans.	6.3	5.2	4.8	3.7	3.1	3.2	3.2
Dubuque, Iowa	6.9	5.9	4.6	3.5	3.2	3.3	—
North Platte, Neb.	6.8	6.5	5.9	5.2	4.4	4.7	5.4
Omaha, Neb.	—	5.4	4.9	3.6	3.2	3.5	3.8
Pierre, S. Dak.	5.9	5.1	4.8	4.3	3.7	4.4	4.0
Topeka, Kans.	7.4	6.2	4.9	4.0	3.8	3.9	4.5
Average	7.4	5.8	5.2	4.4	4.0	3.8	4.1

Stations	Altitude.		Temperature.	
	Feet.	Gradient.	° F.	° F.
Washington	210	—3.00	—	—15.2
Cairo	315	—4.30	—	—25.6
Cincinnati	940	—5.15	—	—27.5
Fort Smith	527	—5.00	—	—21.5
Knoxville	996	—3.50	—	—17.3
Memphis	685	—3.85	—	—17.7
Springfield	704	—4.10	—	—18.8
Cleveland	1197	—4.30	—	—17.6
Duluth	869	—3.85	—	—17.0
Lansing	722	—3.45	—	—15.7
Sault Ste Marie	2473	—4.10	—	—11.6
Dodge	894	—3.30	—	—14.5
Dubuque	2811	—5.40	—	—13.3
North Platte	1241	—3.20	—	—12.9
Omaha	1595	—3.90	—	—14.4
Pierre	972	—3.83	—	—16.5

In this table the second column gives the altitude of the ground at the reel on which the kite wire was wound. The third column shows the average gradient in degrees Fahrenheit per 1000 ft. between the reel at the respective stations, and a uniform altitude 5280 ft. above sea-level. The fourth column shows the total reduction to be applied to the temperature at the reel in order to obtain the temperature at the 1 m. level above sea. These gradients and reductions are based upon observations made only during the six warm months from May to October 1898.

The kite-work at the Blue Hill Observatory has been published in full in the successive Annals of the Harvard College Observatory, beginning with 1897, vol. xiii. It has been discussed especially by H. H. Clayton with reference to special meteorological phenomena, such as areas of high and low pressure, fair and cloudy weather, the winds and their velocities at different elevations, insolation, radiation, &c., and has served as a stimulus and model for European meteorologists. Kite-work has also been successfully prosecuted at Trappes, Hamburg, Berlin, St Petersburg, and many other European stations. The highest flights that have been attained have been about 8000 metres.

The great work of L. Teisserenc de Bort began with 1897, when he founded his private observatory at Trappes near Paris devoted to the problems of dynamic meteorology. His results are published in full in the *Memoirs of the Central Meteorological Bureau of France for 1897 and subsequent years*. Beginning with the sounding balloons devised by Hermite, he subsequently added kite work as supplementary to these. In the *Comptes rendus* (1904), he gives the mean temperatures as they result from five years of work, 1899-1903, at Trappes. Out of 581 ascensions of sounding balloons there were 141 that attained 14 km. or more, and the following table gives the average temperatures recorded in these ascensions. It will be seen that there is a slow decrease in temperature up to 2 km.; a rapid decrease thence up to 10 km.; and a slow decrease, almost a stationary temperature, between

11 and 14 km.; this is the "thermal zone" as discovered and so called by him.

Altitude.	Winter.		Spring.		Summer.		Autumn.	
	Dec., Jan., Feb.	Mar., Apr., May.	June, July, Aug.	Sept., Oct., Nov.	° C.	° C.	° C.	° C.
Ground	+ 1.9	+ 5.1	+ 13.0	+ 7.5				
0.5	+ 1.4	+ 4.7	+ 13.6	+ 7.7				
1.0	— 0.2	+ 2.4	+ 11.8	+ 6.1				
1.5	— 0.2	+ 0.1	9.7	+ 4.0				
2.0	— 1.4	— 2.1	7.3	+ 2.2				
2.5	— 3.0	— 4.3	5.0	+ 0.4				
3.0	— 6.0	— 6.4	2.1	— 1.7				
3.5	— 8.7	— 9.2	+ 0.2	— 2.7				
4.0	— 10.9	— 12.3	— 2.7	— 6.5				
4.5	— 14.2	— 15.2	— 5.3	— 9.3				
5.0	— 17.0	— 18.5	— 8.3	— 12.4				
6.0	— 23.7	— 25.2	— 14.8	— 18.7				
7.0	— 31.5	— 32.0	— 21.7	— 25.8				
8.0	— 39.0	— 39.0	— 29.3	— 33.5				
9.0	— 46.9	— 46.7	— 38.0	— 41.4				
10.0	— 54.6	— 52.7	— 45.3	— 48.3				
11.0	— 57.9	— 53.6	50.3	— 54.4				
12.0	— 57.9	— 53.1	51.7	— 57.1				
13.0	— 56.9	— 52.2	52.5	— 57.1				
14.0	— 55.5	— 52.5	— 51.3	— 57.1				

It is evident that the annual average vertical gradient of temperature over Paris is between 4° and 6° C. per 1000 metres of ascent in the free air, agreeing closely with the value 5° per 1000 metres, which has come into extensive use since the year 1890, on the recommendation and authority of Hann, for the reduction of land observations to sea-level. The winter gradients are less than those for summer, possibly owing to the influence of the condensation into cloud and rain during the winter season in France; the same value may not result from observations in the United States, where the clouds and precipitation of winter do not so greatly exceed those of summer. The work at Trappes is therefore not necessarily representative of the general average of the northern hemisphere, but belongs to a coastal region in which during the summer time, at great heights, the air is cooler than in the winter time, since during the latter season there is an extensive flow of warm south winds from the ocean over the cold east winds from the land. Sounding balloons have also been used elsewhere with great success. The greatest heights attained by them have been 25,989 metres at Uccle, Belgium, on the 5th of September 1907, and 25,800 metres at Strassburg, August 1905.

The most extensive meteorological explorations of the free atmosphere have been those accomplished in Germany by Richard Assmann and Arthur Berson, beginning (1887) in co-operation with the German Verein for the Promotion of Aeronautics and the Aeronautical Section of the German Army, afterwards under the auspices of the Prussian Meteorological Office, but later as a wholly independent institution at Lindenberg. All the details of the work during 1887-1889 and the scientific results of seventy balloon voyages were published in three large volumes, *Wissenschaftliche Luftschifffahrten* (Berlin, 1900). The work done at Tegel at the Aeronautical Observatory of the Berlin Meteorological Office, the 1st of October 1899 to April 1905, was published in three volumes of *Ergebnisse*. But the location at Tegel had to be given up and

Annual Temperatures and Wind.

Altitude.	Tegel, 1903.		Tegel, 1904.		Lindenberg, 1905.		Lindenberg, 1905.	
	Days.	° C.	Days.	° C.	Days.	° C.	Days.	Metres per sec.
Ground	365	9.2	366	9.1	365	8.5	365	4.65
500 m.	363	6.7	364	6.5	365	6.2	362	8.85
1,000 "	344	4.3	361	4.2	352	4.0	356	8.65
1,500 "	252	2.0	279	2.2	294	2.6	306	8.55
2,000 "	170	0.0	186	— 0.2	242	0.5	257	9.5
2,500 "	98	— 1.8	132	— 1.7	179	— 1.1	195	10.0
3,000 "	55	— 3.9	79	— 3.6	119	— 2.8	127	10.7

a new independent establishment, the "Royal Prussian Aeronautical Observatory," was founded at Lindenberg, under the direction of Dr Assmann, who has published the results of his work in annual volumes of the *Ergebnisse* of that institution, considering it as a continuation of the work done at Berlin and Tegel. In addition to these elaborate official publications various summaries have been published, the most instructive of which is the chart embodying daily observations with corresponding isotherms at all attainable altitudes, published monthly since January 1903 in *Das Wetter*. The growth of this aerial work and the reliability of the results may be inferred from a statement of the number of ascensions made each year: 1899, 6; 1900, 39; 1901, 169; 1902, 261; 1903, 481; 1904, 513. This large number, combined with 581 voyages of Teisserenc de Bort at Trappes and many others made in England,

Holland and Russia, amounting in all to over 2000, enabled Assmann to compute the monthly and annual means of temperature and wind velocity for each altitude; the German results are given in table at foot of page 269.

The results of these numerous ascents, during these six years, have also been grouped into monthly means that have a reliability proportionate to the number of days on which observations were obtained at a given level, and we are now able to speak of the annual and even of the diurnal periodicity of temperature at different altitudes in the free air with considerable confidence.

Some of the most important conclusions to be drawn from the best recent work were published by Hann either in special memoirs or in his *Lehrbuch*, from which we take the following table. The actual temperatures given in this table have only local importance, but the differences or the vertical gradients doubtless hold good over a large portion of Europe if not of the world.

Temperature in Free Air over Europe 1800-1904.

Altitude. Km.	Annual Averages.				International.		All countries combined.
	Berlin. 15 Ascents.	International. 130 Ascents.	Mountain balloons. 36 Ascents.	Trappes. 581 Ascents.	Feb.	Aug.	
	°C.	°C.	°C.	°C.	°C.	°C.	
0	—	8.3	—	—	+ 0.3	+ 18.2	—
1	+ 5.4	6.0	+ 5.5	+ 5.3	+ 1.3	+ 15.1	—
2	+ 0.5	1.7	+ 0.3	+ 0.7	- 3.6	+ 10.2	5.0
3	- 5.0	- 3.3	- 4.4	- 4.0	- 8.7	+ 4.8	- 4.0
4	- 10.3	- 9.0	- 10.3	- 9.4	- 14.7	+ 1.0	- 9.2
5	- 16.6	- 15.3	- 16.5	- 15.4	- 21.9	- 7.1	- 15.4
6	- 24.2	- 22.1	- 23.0	- 21.9	- 28.9	- 13.3	- 22.0
7	- 30.2	- 29.1	- 30.2	- 29.0	- 36.1	- 19.5	- 29.0
8	- 37.4	- 36.2	- 37.0	- 36.2	- 43.7	- 27.1	- 36.2
9	- 46.4	- 43.0	—	- 43.5	- 50.1	- 33.8	- 43.2
10	—	- 49.0	—	- 49.3	- 55.4	- 39.5	- 49.2

The differences of temperature between any layer and those above it and below it, or the vertical gradients at each level go through annual periodical changes quite analogous to those derived from mountain observations; the most rapid falls of temperature, or the largest vertical gradients in the free air occur on the following dates over Europe:—

Altitude.	Over Germany.	Over Trappes.
1, 2, 3 km.	May, June	May 15
3, 4, 5	March	Feb. 15
5, 6, 7	April	Jan. 27
7, 8, 9	July	July 28
9, 10, 11	—	Sept. 14

The values above given as deduced from 141 high ascensions at Trappes show that between 11 and 14 km. there was no appreciable diminution of temperature, in other words, the air is warmer than could be expected and therefore has a higher potential temperature. This fact was first confirmed by the Berlin ascensions, and is now recognized as well-nigh universal. The altitude of the base of this warm stratum is about 12 km. in areas of high pressure and 10 km. in areas of low pressure. It is higher as we approach the tropics and above ordinary balloon work near the equator if indeed it exists there. At first this unexpected warmth was considered as possibly a matter of error in the meteorographs, but this idea is now abandoned. Assmann suggested that the altitude is that of

Month.	Average temperature gradient per 100 metres.		Altitude (metres).	Total Fall of Temperature from Ground upward.			
	Altitudes.			October to March.		April to September.	
	From 0 to 1000 metres.	From 1000 to 2000 metres.		Cloudiness 0-7.	Cloudiness 8-10.	Cloudiness 0-7.	Cloudiness 8-10.
January.	°C.	°C.	2000	°C.	°C.	°C.	°C.
February	0.11	0.58	1800	8.24	7.63	5.33	14.18
March	0.39	0.30	1600	7.22	6.60	14.20	12.97
April	0.33	0.40	1400	6.28	6.04	13.01	11.75
May	0.73	0.48	1200	5.35	5.15	10.97	10.59
June	0.90	0.66	1000	4.48	4.35	10.32	9.32
July	0.99	0.72	800	3.62	3.52	9.13	7.96
August	0.96	0.67	600	2.20	2.82	7.55	6.65
September	0.86	0.62	400	1.54	2.33	5.77	5.23
October	0.77	0.58	200	0.65	1.85	3.88	3.63
November	0.57	0.43	0	0.35	1.05	1.88	1.76
December	0.36	0.53	—	0.00	0.00	0.00	0.00
Year	0.61	0.53	—	—	—	—	—

the highest cirrus, from which Cleveland Abbe inferred that it had something to do with the absorption of the solar and terrestrial heat by dissolving cirri. But the most plausible explanation is that published simultaneously in September 1908 by W. J. Humphreys of Washington, and Ernest Gold of London.

The daily diagrams in *Das Wetter* show that both the irregular and the periodic and the geographic variations of temperature in the upper strata are unexpectedly large, almost as large as at the earth's surface, so that the uniform temperature of space that was formerly supposed to prevail in the upper air must be looked for, if at all, far above the level to which sounding balloons have as yet attained. It is evident that both horizontal and vertical convection currents of great importance really occur at these great altitudes. These upper currents cannot be due to any very local influence at the earth's surface, but only to the interchange of the air over the oceans and continents or between the polar and equatorial regions. They constitute the important feature of the so-called general circulation of the atmosphere, which we have hitherto mistakenly thought of as confined to lower levels; their general direction is from west to east over all parts of the globe as far as yet known, showing that they are controlled by the rotation of the earth. It is likely that masses of air having special temperature conditions or clouds of vapour dust such as came from Krakatoa, may be carried in these high currents around the globe perhaps several times before being dissipated.

The average eastward movement or the west wind at 3 km. above Germany is 10.7 m. per sec. or 1° of longitude (at 45° latitude) 2.4 minutes, or such as to describe the whole circumference of this small circle in 10.5 days. At the equator above the calm belt the velocity westward or the east wind as given by Krakatoa volcanic-dust phenomena was 34.5 m. per sec., on 30° of a great circle daily, or around the equator in 12.5 days, while its poleward movement was only 1° per day or 1.3 metre per second. The average motion 45° the storm centres moving westward in northern tropical and equatorial regions but eastward in the north temperate zone is at the rate of one circumference or a small circle at latitude 45° in 19 days. Observations of the cloud movements gave Professor Bigelow the following results for the United States:—

Altitude.	Moving eastward.	Moving westward.
10.0 km.	36 m. p.s.	2.0 m. p.s.
7.5	35	2.0
5.0	26	1.5
3.0	20	1.0
1.0	8	0.5
0	4	—

Evidently, therefore, the great west wind (that James H. Coffin deduced from his work on the winds of the northern hemisphere and that William Ferrel deduced from his theoretical studies) represents with its gentle movement poleward a factor of fundamental importance. We must consider all our meteorological phenomena except at the equator as existing beneath and controlled, if not

caused, by this general deep swift upper current of air that began as an ascending east wind above the calm equatorial air but speedily overflew as west wind settling down to the sea-level in the temperate and polar regions as great areas of high pressure and dry clear cool weather containing air on its return passage to the equator. The upper air is thrown easily into great billows, and wherever it rises the warm equatorial wind flows in beneath it, but when it descends we have blizzards and dry clear weather. It is a covering for the lower strata of air, it flows over them in standing waves and sometimes mixes with them at the surface of contact. It receives daily accessions from below and gives out corresponding accessions to the lower strata, by a process of overturning such as has been studied theoretically by Margules and Bigelow.

At the fifth conference of the International Committee on Scientific Aeronautics (Milan, October 1906) Rykatchev presented the results of his work during 1904 and 1905 at Pavlovsk, near St Petersburg, from which we select the results for these two years given in table at foot of page 270.

Many inversions occur during January below 1000 metres. The decrease is more rapid in summer than in winter and in clear weather than in cloudy, but of course these observations did not extend above the upper level of the cumulus cloud layer. A general survey of the existing state of knowledge of the upper atmosphere is given in the Report of the British Association for 1910.

Distribution of Aqueous Vapour.—The distribution of aqueous vapour is best shown by lines of equal dew-point or vapour tension, though for some purposes lines of equal relative humidity are convenient. The dew-point lines are not usually shown on charts, partly because the lines of vapour pressure are approximately parallel to the lines of mean temperature of the air, and partly because the observations are of very unequal accuracy in different portions of the globe. In general we may concede, any isotherm as agreeing with the dew-point line for dew-points a few degrees lower than the temperature of the air. The distribution of moisture is quite irregular both in a horizontal and in a vertical direction. On charts of the world we may draw lines based on actual observations to represent equal degrees of relative humidity, or equal dew-points and vapour pressures; but as regards the distribution of moisture in a vertical direction we are, in the absence of specific observations, generally forced to assume that the vapour pressure at any altitude h follows the average law first deduced from a limited number of observations by Hann, and expressed by the logarithmic equation, $\log e = \log e_0 - h/6517$, which is quite analogous to the elementary hypsometric formula, $\log p = \log p_0 - h/18400$. Therefore, in general, the ratio between the pressure of the vapour and the pressure of the atmosphere at any altitude is represented by the approximate formula, $\log \{e/p\} = \log e_0/p_0 - h/10091$. Of course these relations can only represent average or normal conditions, which may be departed from very widely at any moment; they have, however, been found to agree remarkably with all observations which have as yet been published. The average results are given in the following table, which is abbreviated from one published by Hann, but with the addition of the work done by the U.S. Weather Bureau, as reduced by Dr Frankenberg in 1899. The vapour constituent of the atmosphere is not distributed according to the law of gaseous diffusion, but, like temperature and the ratio between oxygen and nitrogen, is controlled by other laws prescribed by the winds and currents, namely—convection.

Diminution of the Relative Vapour Pressure with Altitude.

Authority.	1500 ft.	2000 ft.	3000 ft.	4000 ft.	5000 ft.	6000 ft.	7000 ft.	8000 ft.	No. Obs.
Kites (U.S.W.B.)	0.82	0.78	0.70	0.61	0.52	0.49	0.39	0.44	1123
Balloons (Hammon.)	0.97	0.96	0.87	0.68	0.44	0.59	—	—	4
Balloons (Hazen.)	0.89	0.83	0.80	0.78	0.67	0.46	0.44	—	2
Balloons (Hann.)	0.84	0.80	0.66	0.61	0.50	0.54	0.41	0.37	15
Mountains (Hann.)	0.83	0.81	0.80	0.66	0.61	0.58	0.55	0.47	6
Computed by Hann.	0.85	0.81	0.72	0.65	0.58	0.52	0.47	0.42	—

Note.—The vapour pressure at any altitude is supposed to be expressed as a fraction of that observed at the ground. When the altitudes are given in ft. Hann's formula becomes $\log e/e_0 = h/29539$.

From 78 high balloon voyages in Germany, 1887-1899, Süring deduced the average vapour pressure in millimetres as found in

Diminution of Pressure of Aqueous Vapour in the Free Air.

Alt.	km. 0.5	km. 1.0	km. 1.5	km. 2.0	km. 2.5	km. 3.0	km. 3.5	km. 4.0	km. 4.5	km. 5.0	km. 6.0	km. 7.0	km. 8.0
Süring.	0.83	0.68	0.51	0.41	0.34	0.26	0.20	0.17	0.14	0.11	0.054	0.028	0.013
Hann.	0.83	0.70	0.58	0.48	0.40	0.34	0.28	0.23	0.19	0.16	—	—	—

the first line of the table at foot of this page (see *Wissenschaftliche Luftfahrten*, Bd. III., and Hann, *Lehrbuch*, 1906, p. 169). The observations on mountains gave Hann the pressures in the second line. Süring's figures result from the use of Assmann's ventilated psychrometer and are therefore very reliable.

The vapour pressure in mm. in free air over Europe is best given by Süring's formula

$$\log e_s = \log e_0 - \frac{h}{6} \left(1 + \frac{h}{20} \right)$$

where the altitude is to be expressed in kilometres. From this formula we derive the "specific moisture" or the mass of vapour contained in a kilogram of moist air as given in the following table whose numbers do not appreciably differ from "the mixing ratio" or the quantity of moisture associated with a kilogram of dry air. The relative humidities vary irregularly depending on convection currents, but in clear weather when descending currents prevail they have been observed in America and over Berlin as shown in the third and fourth columns of the following table:—

Observed Specific Moisture and Relative Humidity.

Alt. Km.	Specific moisture.	Relative Humidity.	
		U.S.A.	Berlin.
0.0	1.00	%	%
0.5	—	65	77
1.0	0.76	65	71
1.5	0.65	59	62
2.0	0.55	59	57
2.5	0.47	45	58
3.0	0.39	—	55
3.5	—	—	49
4.0	0.26	—	53
4.5	—	—	54
5.0	0.17	—	—
5.5	0.11	—	—
5.7	0.07	—	—
5.8	0.04	—	—

The total amount of vapour in the atmosphere, according to Hann's formula, is between one-fourth and one-fifth of the amount required by Dalton's hypothesis, as is illustrated by the following table taken from an article by Cleveland Abbe in the Smithsonian Report for 1888, p. 410:—

Total Vapour in a Vertical Column that is saturated at its base.

Altitude. Feet.	Relative Tension - e/e ₀ .	Actual Weight Gr. per Cubic Foot.								Total Vapour in the Columns expressed as Inches of Rain.
		80° F.	70° F.	60° F.	50° F.	80° F.	70° F.	60° F.	50° F.	
0	1.000	10.95	7.99	5.76	4.09	0.00	0.00	0.00	0.00	0.0
6000	0.524	5.75	4.19	3.02	2.14	1.3	1.0	0.7	0.5	0.8
12,000	0.275	3.01	2.20	1.58	1.12	1.1	1.5	1.1	0.8	—
18,000	0.144	1.58	1.15	0.83	0.59	2.5	1.8	1.3	0.9	—
24,000	0.075	0.82	0.62	0.43	0.31	2.7	2.0	1.4	1.0	—
30,000	0.040	0.43	0.32	0.23	0.16	2.8	2.1	1.5	1.1	—

A heavy rainfall results from the precipitation of only a small percentage of the water contained in the fresh supplies of air brought by the wind; if all moisture were abstracted from the atmosphere it could only affect the barometer throughout the equatorial regions by 2.8/13.6 inches, or about two-tenths of an inch, while at the polar regions the diminution would be much less than one-tenth. Evidently, therefore, it is idle to argue that the fall of pressure in an extensive storm is to be considered as the simple result of the condensation of the vapour into rain.

Barometric Pressure.—The horizontal distribution of barometric pressure over the earth's surface is shown by the *isobars*, or lines of equal pressure at sea-level; it can also be expressed by a system of complex spherical harmonics. As the indications of the mercurial barometer must vary with the variation of apparent gravity, whereas those of the aneroid barometer do not, it has been agreed by the International Meteorological Conventions that for scientific purposes all atmospheric pressures, when expressed as barometric readings, must be reduced to one standard value of gravity, namely, its value at sea-level and at 45° of latitude. In this latitude its value is such as to give in one second an acceleration of 980.8 centimetres, or 32.2 English ft. per second. The effect of the variation of apparent gravity with latitude is therefore to make the mercurial barometer read too high, between 45° and the equator, and too low, between 45° and the pole. The gravity-correction to be applied to any mercurial barometric-reading at or near sea-level, in order to get the atmospheric pressure in

standard units, should be given on the edge of a meteorological chart, unless the isobars shown thereon already contain this correction. On such charts it will be perceived that the barometric pressure at sea-level is by no means uniform over the earth's surface, and daily weather charts show very great fluctuations in this respect, the lowest pressures being storm centres and the highest pressures areas of clear cool dry weather. But even the normal average charts show high pressure over the continents in the winter and low pressure over the oceans, these conditions being reversed in the summer time; moreover, Schouff (*Pogg. Ann.*, 1832) first demonstrated that the average pressure in the neighbourhood of the equator is slightly less than under either tropic, and that there is a still more remarkable diminution of pressure from either tropic towards its pole. The exact statement of these variations of pressure with latitude was subsequently worked out very precisely by Ferrel, and forms the basis of his explanation of the general circulation of the earth's atmosphere and its influence on the barometer. The series of monthly charts for the whole globe, compiled by Buchan and published by the Royal Society of Edinburgh in 1868, as well as Buchan's later and more perfect charts in the meteorology of the "Challenger" Expedition, Edinburgh, 1889, and in Bartholomew's *Atlas*, first revealed clearly the fact that the distinct areas of high and low pressure which are located over the continents and the oceans vary during the year in a fairly regular manner, so that the pressure is higher over the continents in the winter season and lower in the summer season, the amount of the change depending principally upon the size of the continent. A part of this annual variation in pressure is undoubtedly induced by the methods of observation; for if the data of the lower stations are reduced up to the level of 10,000 or 15,000 ft., we sometimes find the barometric conditions quite reversed. These annual changes are intimately connected as cause and effect with the annual changes of temperature, moisture and wind; it is quite erroneous to say that the observed charted pressures control the winds; there is a reaction going on between the wind and the barometric gradient, the resistance and rotation of the earth's surface, such that the true relation between these factors is a complex but fundamental problem in the mechanics of the atmosphere.

The vertical distribution of the air masses as deduced from observation shows a rate of diminution with increasing altitude very closely but not entirely accordant with the laws of static equilibrium, as first elaborated by Laplace in his hypsometric formula. The departures from this law of static equilibrium are sufficient to show that, if our atmosphere is really in a state of equilibrium, it must be a matter of dynamics and not of statics. The general average relation of the density of the air to the altitude and temperature, and the total pressure of the superincumbent atmosphere, are shown in the accompanying diagram (fig. 1), which is taken from a reduction on a scale of 1000 feet to the statute mile, published in the *U.S. Monthly Weather Review* for July 1897. The diminution of pressure with altitude, as shown in this diagram for average conditions, but not for the temporary conditions that continually occur, follows a logarithmic law, and can undoubtedly be extended upwards for the normal atmosphere only to a height of 20 or 30 m., owing to our uncertainty as to the actual conditions in the upper portions of the atmosphere. This diagram is based upon the assumption that the atmosphere is in a state of convective equilibrium such that the ascending and descending masses expand and contract as they ascend and descend from up to the descending nearly but not quite in accordance with the adiabatic law of the change of temperature in pure gases.

The departure of atmospheric temperatures from the strictly adiabatic law, as shown by Cottier, is undoubtedly due largely to the heat absorbed by and radiated from moist or hazy or dusty air. In 1890, Abbe showed that a very moderate rate of radiation from the atmosphere suffices to explain the coolness of slowly descending air. The absorption by the atmosphere of radiations from the earth and sun, or the balance between warming by absorption and cooling by radiation, is the basis of the arguments of W. J. Humphreys (*Astrophysics*, Jan. 1909), and E. Gold (*Proc. Roy. Soc.*, 1908, lxxxiii., 45 A.), explaining the existence of the "thermal layer."

The direct evaluation of this radiation and absorption has been attempted by many. The genuine law $a(p-p)$ is adopted by Gold as closely representing nature, whence it follows that (1) the adiabatic rate of cooling in convection currents must cease at a height corresponding to one-half of the barometric pressure at sea-level; (2) an isothermal layer must exist at the level where the absorption of solar radiation equals that of terrestrial and atmospheric radiation; (3) within this thermal layer vertical convection is difficult or impossible; (4) above this region the vertical temperature gradient must depend essentially on radiation and is less than that needed for convective equilibrium; (5) below this level the atmospheric radiation exceeds the atmospheric absorption and vertical currents can only be kept up by the convection of heat or aqueous vapour from the earth's surface to the adjacent layer of the air.

Limit of the Atmosphere.—The limiting height of the atmosphere must be at some unknown elevation above 20 m. where the temperature falls to absolute zero. But the uncertainty of the various hypotheses as to the physical properties of the upper atmosphere

forbids us to entertain any positive ideas on this subject at the present time. If we define the outer limit of the atmosphere as that point at which the diffusion of gases inwards just balances the diffusion outwards, then this limit must be determined not by the hypsometric formula, but by the properties of gases at low temperatures and pressures under conditions as yet uninvestigated by physicists.

Cloudiness.—It is evident that the clouds (g, p) are formed from clear transparent air by the condensation of the invisible moisture therein into numerous minute particles of water, ice or snow. Notwithstanding their transparency, these individual globules and crystals, when collected in large masses, disperse the solar rays by reflection to such an extent that direct light from the sun is unable to penetrate fog or cloud, and partial darkness results. In a general survey of the atmosphere the geographical distribution of the amount of cloudy sky is important. When the solar heat falls upon the surface of the cloud it is so absorbed and reflected that, on the one hand, scarcely any penetrates to the ground beneath, while on the other hand the upper surface of the cloud becomes unduly heated. Even if this upper surface is completely evaporated, it may continually be renewed from below, and, moreover, the evaporated moisture mixing with the air renders it very much lighter specifically than it would otherwise be. Hence the upper surface of the cloud represents the surface of the ground and of the ocean; the air in contact with it acquires a higher temperature and greater buoyancy, while the ground and air beneath it remain colder than they would be in sunshine. The average cloudiness over the globe is therefore intimately related to the density and circulation of the atmosphere; it was first charted in general terms by L. Teisserenc de Bort of Paris, about 1886. The manifold modifications of the clouds impress one with the conviction that, when properly understood and interpreted, they will reveal to us the most important features of the processes going on in the atmosphere. The sailor and sailor can correctly judge of the weather several hours in advance by a casual glance at the clouds, what may not the professional meteorologist hope to do by a more careful study? Acting on this idea, in 1868 Abbe asked from all of his correspondent observers full details as to the quantity, kind and direction of motion of each layer of clouds; these were telegraphed daily for publication in the *Weather Bulletin of the Cincinnati Observatory*, and for use in the weather predictions made at that time. Since January 1872 similar data have been regularly telegraphed for the use of the U.S. Weather Bureau in preparation for a special cloud atlas that were compiled thrice daily have not been published, owing to the expense. These data were also published in full in the *Bulletin of the International Simultaneous Meteorological Observations* for the whole northern hemisphere during the years 1875-1884. Abbe's work on the U.S. Eclipse Expedition to the West Coast of Africa in 1889-1890 was wholly devoted to the determination of the height and motions of the clouds by the use of his special form of the marine nephoscope. The use of such a nephoscope is to be strongly recommended, as it gives the navigator a means of determining the bearing of a storm centre at sea by studying the lower clouds, better than he can possibly do by the observation of the winds alone. The importance of cloud study has been especially emphasized by the International Meteorological Committee, which arranged for a complete year of systematic cloud-work by national weather bureaus and individual observatories throughout the world from May 1896 to June 1897. In this connexion H. H. Clayton of Blue Hill Observatory published a very comprehensive report on cloud forms in 1906. The complete report by Professor F. H. Bigelow on the work done by the U.S. Weather Bureau forms a part of the annual *Report on Cloud-work*, and constitutes a remarkable addition to our knowledge of the subject. Some preliminary account of this work was published in the *American Journal of Science* for December 1899.

Although all the international cloud-work of 1896-1897 has now been published in full by the individual institutions, as in the case of the International Polar Research Work of 1883, yet a comprehensive study of the results still remains to be made. Some of these have, however, been brought together in Mohn's discussion of the observations by Nansen during the voyage of the "Fram" and also in Hanford and Bigelow's *Report on Cloud-work*. The mean altitudes of cirrus and strato-cumulus clouds resulted as follows.

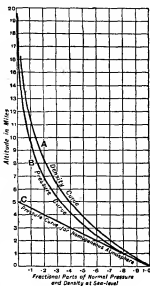

FIG. 1.

Place.	Latitude.	Cirrus.		St. cu.		Highest Cirrus.	Lowest Cirrus.
		kil.	mil.	kil.	mil.		
Cape Thorsden.	78-5	7-3	2-5	—	—	—	—
Boskoop, 1838-1842.	70	8-3	1-3	11-8	5-5	—	—
Storlien.	63-5	8-3	1-8	—	—	—	—
Upsala, 1884-1885.	60	8-9	2-3	—	—	13-4	3-6
1896-1897.	60	8-2	1-8	—	—	—	—
Pavlosk.	60	8-8	1-9	11-7	4-7	—	—
Danzig.	54-5	10-0	2-2	—	—	—	—
Irksutsk.	52-3	10-9	2-3	—	—	—	—
Blue Hill, 1890-1891.	42-5	9-0	3-2	—	—	—	—
Potsdam, summer.	52	9-1	2-2	—	—	—	—
winter.	52	8-1	1-4	—	—	—	—
Blue Hill, summer.	42-5	9-5	1-2	—	—	—	—
winter.	42-5	8-6	1-6	15-0	5-4	—	—
Toronto, summer.	43-6	10-9	2-0	—	—	—	—
winter.	43-6	10-0	1-5	—	—	—	—
Washington, summer.	39	10-4	2-9	16-5	5-0	—	—
winter.	39	9-5	2-4	—	—	—	—
Allahabad.	25-5	12-4	3-5	—	—	—	—
Manila.	15	10-9	2-0	18-0	4-0	—	—

The annual average velocity of hourly movement in metres per second without regard to direction may be summarized as follows:—

	100-2000.		2-1000.		5-8000.		8-10,000.		10-12,000.		12-14,000.	
	m.	m.	m.	m.	m.	m.	m.	m.	m.	m.	m.	m.
Boskoop . . .	6-5	7-3	12-5	15-4	19-0	24-4	—	—	—	—	—	—
Upsala . . .	9-1	8-7	16-0	20-4	26-6	—	—	—	—	—	—	—
Potsdam . . .	9-3	10-3	16-9	20-8	25-4	—	—	—	—	—	—	—
Blue Hill . . .	9-8	14-2	17-1	34-3	34-2	(33)	—	—	—	—	—	—
Toronto . . .	9-4	17-1	18-4	32-0	30-8	28-8	—	—	—	—	—	—
Washington ¹	(8-6)	14-6	17-3	20-3	25-8	(28-3)	26-8	—	—	—	—	—
Allahabad . . .	3-4	6-4	13-0	17-6	22-2	20-7	34-0	—	—	—	—	—
Manila . . .	5-5	7-1	6-5	8-0	13-6	13-0	13-4	—	—	—	—	—

The movements of the upper clouds are more rapid in winter than in summer at these northern stations, but among the median and lower clouds a retardation takes place apparently due to the ascending currents that form rain and snow. Above 8000 metres at Upsala the average velocity in winter exceeds 30 metres per second, whereas in summer it is 20; at Toronto and Blue Hill the absolute velocities are larger but in the same ratio. In the United States the maximum velocities from the west attain 100 metres per second and over 80 or 70 metres per second are not rare, but in Europe the corresponding figures are 70, 60, 50. (See also CLOUD.)

II.—METEOROLOGICAL APPARATUS AND METHODS

The observational basis of meteorology is the frequent and, if possible, continuous record of the temperature, moisture and barometric pressure at different altitudes in the free atmosphere, the direction and velocity of the wind, the rain and snow-fall, and the kind, amount and motion of the clouds. For Europe these data have been furnished with more or less accuracy and continuity by thousands of observers ever since 1653, when Ferdinand II., grand duke of Tuscany, organized a system of daily observations in Italy under the general supervision of Luigi Antinori. During the 19th century great efforts were made to obtain equally full records from all parts of the land and ocean, and thousands of navigators were added to the great corps of observers. Other matters have also been investigated, the most important being the intensity of radiation from the earth at night-time and from the sun by day-time, the optical phenomena of the sky, the amount of dust in the air, the electrical condition and the chemical constitution of the atmosphere. Although all the instruments used belong to the category of physical apparatus, yet certain points must be considered as peculiar to their use in connexion with meteorology.

Thermometer.—In using the thermometer to determine the temperature of the free air it is necessary to consider not merely its intrinsic accuracy as compared with the standard gas thermometer of the International Bureau of Weights and Measures at Paris, but especially its sluggishness, the influence of noxious radiations, the gradual change of its zero point with time, and the influence of atmospheric pressure.

¹ [We have here inserted the Washington data as interpolated from the figures given by Hann, *Lehrbuch*, 1906, p. 282.]

Sensitiveness.—The thermometer indicates the temperature of the outside surface of its own bulb only when the whole mass of the instrument has a uniform temperature. Assuming that by appropriate convection we can keep the surface of the thermometer at the temperature of the air, we have still to remember that ordinarily this itself is perpetually changing both in rapid oscillations of several degrees and in diurnal periods of many degrees, while the thermometer itself, owing to its thermal inertia, always lags behind the changes in the temperature of its own surface. On the other hand, radiant heat passes easily through the air, strikes the thermometer, and raises its temperature quite independently of the influence of the air whose temperature we wish to measure. The internal sluggishness or the sensitiveness of the thermometer is usually different for rising and for falling temperatures, and is measured by a coefficient which must be determined experimentally for each instrument by observing the rate at which its indications change when it is plunged into a well-stirred bath of water whose temperature is either higher or lower than its own. This coefficient indicates the rate per minute at which the readings change when the temperature of the surface of the bulb is one degree warmer or colder than the temperature of the bath. Such coefficients usually vary between $\frac{1}{10}$ of a degree Centigrade for sluggish thermometers, and one or two degrees for very sensitive thermometers. Suppose, for instance, that the coefficient is one-half degree, then when the rate of change in the temperature of the air is one degree per minute this is exactly the same as the rate of change which the thermometer indicates, though when its own temperature is two degrees different from that of the air; consequently, the thermometer will lag behind the air temperature to that extent and by the corresponding amount of time, assuming that the air itself flows fast enough to keep the surface of the bulb at the air temperature. When the air temperature ceases to rise or fall, and begins to change at the same rate in the opposite direction, the thermometer will fail to record the true maximum or minimum temperature by an appreciable error depending upon the rapidity of the change, and will follow the new temperature changes with the same lag. For example, in the case just quoted, if a rising temperature suddenly changes to a falling temperature, the error of the thermometer at the maximum temperature will be two degrees, and yet the thermometer may be absolutely correct as compared with the standard when it is allowed five or ten minutes' time to overcome the sluggishness. It is very difficult to obtain the temperature of the free air at any moment within $\frac{1}{10}$ of a degree Centigrade, owing to the sluggishness of all ordinary thermometers and the perpetual variations in the temperatures of the atmospheric currents.

Radiation.—When a thermometer bulb is immersed in a bath of liquid all radiant heat is cut off, but when hung in the open air it is subject to a perpetual interchange of radiations between itself and all its surroundings; consequently its own temperature has only an indirect connexion with that of the air adjacent to it. One of the most difficult problems of meteorology is so to expose a thermometer as to cut off noxious radiations and get the true temperature of the atmosphere at a specific place and time. The following are a few of the many methods that have been adopted to secure this end: Melloni put the naked glass bulbs within open sheltering caps of perforated silver paper. Flaugergues used a protection consisting of a simple vertical cylinder of two sheets of silver paper enclosing a thin layer of non-conducting substance, like cotton or wool. The influence of radiation upon a thermometer depends upon the radiating and absorbing powers of its own surface; a roughened surface of lamp-black radiates and absorbs perfectly; one of chalk powder does nearly as well; glass much more imperfectly; while a polished silver surface reflects with ease, but radiates and absorbs with the greatest difficulty. Fourier proposed to use two ordinary thermometer sides by plain glass and the other of blackened glass; the difference of these would indicate the effect of radiation at any moment; but instead of plain glass he should have used polished silver. His method was quite independently devised and used by Abbe in 1865 and 1866 at Poulkova, where the thermometers were placed within a very light shelter of oiled paper. In order to use this method successfully, both the black and the silvered thermometers should be whirled side by side inside the thermometer shelters (see *Bulletin of the Philosophical Society of Washington* for 1893). Various forms of open lattice-work and louvre screens have been devised and used by Glaisher, Kupffer, Stevenson, Stowe, Dove, Renou, Joseph Henry and others, in all of which the wind is supposed to blow freely through the screens, while the latter cut off the greater part of the direct sunshine and other obnoxious radiations by day, and also prevent obnoxious radiation from the thermometer to the sky by night. The Italian physicist Belli first proposed a special artificial ventilation drawing the fresh air from the outside and making it flow rapidly over the thermometer. Even before his day de Saussure, Espy, Arago and Bravais whirled the thermometers either by a small whirling machine or by attaching it to a string and swivel and whirling it like a sling. When this whirling is done in a shady place excellent results are obtained. Renou and Craig placed the thermometer in a thin metallic enclosure or shelter, and whirled the latter. Will established the thermometer

in a fixed louver shelter, but by means of a ventilating apparatus drew currents of fresh air from below into the shelter, where they circulated rapidly and passed out. In Germany, since 1885, Dr Assmann has developed the apparatus known as the ventilated psychrometer, in which the dry-bulb thermometer is placed within a double shelter of thin metallic tubing, and the air is drawn in rapidly by means of a small ventilating fan. In the observations made by Abbe on the cruise of the "Pensacola" to the West Coast of Africa, the dry- and wet-bulb thermometers were enclosed within bamboo tubes and rapidly whirled. The inside of the wet-bulb tube was kept wet, so that its surface, being cooled by evaporation, could not radiate injuriously to the thermometer. In the system of exposure adopted by the U.S. Weather Bureau the dry and wet bulbs are whirled by a special apparatus fixed within the louvered shelter, which is about $\frac{3}{4}$ ft. cube, and is placed far enough above the ground or building to ensure free exposure to the wind. In using the whirling and ventilating methods it is customary to take a reading after whirling one minute, and a second reading at the end of the second minute, and so on until no appreciable changes are shown in the thermometer. Of course in perfectly calm weather these methods can only give the temperature of the air for the exact locality of the thermometer. On the other hand, when a strong wind is blowing the indicated temperature is an average that represents the long narrow stream of air that has blown past the thermometer during the few minutes that are necessary in order that its bulb may obtain approximately the temperature of the air.

Change of Zero.—All thermometers having glass bulbs, especially those of cylindrical shape, are sensitive to changes of atmospheric pressure. The freezing-point determined under a normal atmospheric pressure of 30 in., or at sea-level, stands higher on the glass tube than if it had been determined under a lower pressure on a mountain top. Therefore delicate thermometers, when transported to great heights, or even during the very low pressure of a storm centre, read too low and need a correction for pressure. The zero-point also changes with time and with the method of treatment that the bulb has received as to temperature. Owing to the slow adjustment of the molecules of the glass bulb to the state of stable equilibrium, their relations among themselves are disturbed whenever the bulb is freshly heated, and at this time the freezing-point is temporarily depressed to an amount nearly proportional to the heating. The normal method of treatment consists in first determining the boiling-point of the thermometer, and, after a few minutes, the freezing-point. If this method is uniformly followed the two fiducial points will stay in permanent relation to each other. A thermometer that has been used for many years by a faithful meteorological observer has almost inevitably been going through a steady series of changes; in the course of ten years its freezing-point may have risen by 1° or 3° F., and, moreover, it changes by fully a tenth of a degree between summer and winter. The only way to completely eliminate this source of error from meteorological work is to discard the mercurial thermometer altogether; but instead of adopting that course, the use is generally recommended of thermometers whose bulbs are made of a special glass, upon which heating and cooling have comparatively very little influence. Any argument as to secular changes in the temperature of the atmosphere is likely to be greatly weakened by the unknown influence of this source of error, as well as by changes in the methods of exposure and in the hours of observation.

Barometer.—The barometer (*g.v.*) indicates the elastic pressure prevailing in gas or liquid at the surface of the mercury in the open tube or cistern, provided that the fluid at that point is in a state of quiet relative to the mercury.

Any motion of the air will have an influence upon the reading quite independently of the prevailing elastic pressure. The pressure within a mass of gas at any point is the summation of the effects due to the motions of the myriad molecules of the gas at that point; it is the kinetic energy of the molecules striking against each other and the sides of the enclosure, which in this case is the surface of the mercury in the cistern of the instrument. If the barometer moves with respect to the general mass of the gas there is a change in the pressure on the mercurial surface, although there may be none in the general mass of the free gas, and a barometer giving correctly the pressure of the air at rest within a room will give a different indication if the instrument or the air is set in rapid motion so that the air strikes violently against it. If the barometer moves with the air it will indicate the elastic pressure within the air. When the wind blows against an obstacle the air pressure is increased slightly on the windward side and diminished on the leeward side. It is thus obvious that in determining the pressure within the free atmosphere the exposure of the barometer must be carefully considered. The influence of a gale of wind is to raise the elastic pressure within a room whose window faces to the windward, but to lower the pressure if the window faces to the leeward. The influence of the draught up chimney, produced by the wind blowing over its summit, is to lower the pressure within the room. The maximum effect of the wind in raising the pressure is given by the formula, $P - P_0 = 0.0000383 \times V^2$, where the pressure is given

in inches and the velocity in miles per hour. This amounts to about one-tenth of an inch in a 50-m. wind, and to nearly four-tenths in a 100-m. wind. The diminution by a leeward window or a draught up chimney is usually less than this amount. This alteration in pressure, due to the local effect of wind, does not belong to the free atmosphere but to the method of exposure of the barometer, and can be eliminated only by methods first described by Abbe in 1832; it is a very different matter from the general diminution of pressure in the atmosphere produced by the movement of the wind over a rotating earth and by the centrifugal force within a vortex. The latter is an atmospheric phenomenon, independent of instruments and locality, which in hurricanes and tornadoes may amount to several inches of the mercurial column. It is, however, quite common to find in the continuous records of pressure during a hurricane evidence of the fact that the low pressure due to the hurricane and the special diminution due to the exposure of the barometer are combined together, so that when the calm centre of a hurricane passes over a station the pressure temporarily rises by the amount due to the sudden stoppage of the wind and the local exposure effect.

The other sources of error that give rise to discrepancies in meteorological work relate to the temperature of the instrument, the sluggishness of the movement of the mercury, and the inevitable large secular changes in the correction for capillarity, due principally to the changes in the condition of the surfaces of the glass and the mercury, especially those that are exposed to the open air. The international comparisons of barometers show that discrepancies exist between the best normals or standards, and that ordinary barometers must always be compared with such standards at the temperatures and pressures for which they are to be used.

Anemometer.—The wind is measured either by means of its pressure against any obstacle or by revolving apparatus that gives some idea of the velocity of its movement. The pressure is supposed to interest the engineer and navigator, but the velocity is the fundamental meteorological datum; in fact, the pressure of the wind varies with the nature of the obstacle, the method of exposure, the density of the air, and even the mass of rain carried along with it.

Pressure anemometers date from the pendulous tablet devised by Sir Christopher Wren about 1667, and such pressure plates continue to be used in an improved form by Russian observers. The normal pressure plates are used at a few English and Continental stations. The windmill anemometers devised by Schöber and Woltmann were modified by Combes and Casella so as to make an exceedingly delicate instrument for laboratory use; another modification by Richard is extensively used by French observers. In the early part of the 19th century Edgeworth devised and Robinson perfected a windmill system in which hemispherical cups revolved around a vertical axis, and these have come into general use in both Europe and America. Many studies have been made of the exact ratio between the velocity of the wind and the rotations of the Robinson anemometer. The factor 3 is usually adopted and incorporated into the mechanism of the apparatus, but in ordinary circumstances this factor is entirely too large, and the recorded velocities are therefore too large. The whirling cups do not revolve with any simple relation to the velocity of the wind, even when this is perfectly steady. The relation varies with the dimensions of the cups and arms and the speed of the wind, but especially with the steadiness or gustiness of the wind. The exact ratio must always be determined experimentally for each specific type of instrument; in most instruments in actual use the factor for steady winds varies between 2.5 and 2.7. When the wind is gusty the moment of inertia of the moving parts of the instrument necessitates an appreciable correction; thus, when the gust is at its height the revolving parts receive an impetus that lasts after the gust has gone down, so that the actual velocity of the cups is too high. For this reason, also, comparisons and studies of anemometers made in the irregular natural winds of a free air are unsatisfactory. For the average natural and gusty winds at Washington, D.C., and on Mount Washington, N.H., and the small type of Robinson's anemometer used in the U.S. Weather Bureau Service, Professor C. F. Marvin deduced the table (*g.v.* p. 275) for reduction from recorded to true velocity. This table involves the moment of inertia of the revolving parts of the instrument and the gustiness of the wind, at Washington, and will therefore, of course, not apply strictly to other types of instruments or winds, for which special studies must be made.

About 1842 a committee of the American Academy of Arts and Sciences experimentally determined, for a large variety of chimney caps, or cowls, or hoods, the amount of suction that produces the draught up a chimney, and shortly afterwards a similar committee made a similar investigation at Philadelphia (see *Proc. Amer. Acad.* i. 307, and *Journal of Franklin Institute*). The latter investigation showed that the open end of the chimney, acting as an obstacle in the wind, is covered by a layer of air moving more rapidly than the free air at a little distance, and that therefore between this layer and the aperture of the chimney there is a space

within which barometric pressure is less than in the neighbouring free air. The draught up the chimney is due to the pressure of the air at the lower end or fireplace pushing up the flue into this region of low pressure, quite as much as it is due to the buoyancy of the heated air within the flue. From such experiments as these there has been developed the vertical suction-tube anemometer, as devised by Fletcher in 1867, re-invented by Hagemann in 1876, and introduced into England by Dines. In his *Meteorological Apparatus*

Marvin's Table for the Reduction of Velocities, given by the small-sized Robinson's Anemometer in gusty winds.

Indicated Velocity	True Velocity.										
	Miles.	0	1	2	3	4	5	6	7	8	9
0	—	—	—	—	—	—	—	—	—	—	—
10	9.6	10.4	11.3	12.1	12.9	13.8	14.6	15.4	16.2	17.0	8.7
20	17.8	18.6	19.4	20.2	21.0	21.8	22.6	23.4	24.2	24.9	9.0
30	25.7	26.5	27.5	28.2	28.8	29.6	30.3	31.1	31.8	32.6	9.6
40	33.3	34.1	34.8	35.6	36.3	37.1	37.8	38.5	39.3	40.0	10.0
50	40.8	41.5	42.2	43.0	43.7	44.4	45.1	45.9	46.6	47.3	10.5
60	48.0	48.7	49.4	50.2	50.9	51.6	52.3	53.0	53.8	54.5	11.0
70	55.2	55.9	56.6	57.3	58.0	58.7	59.4	60.1	60.8	61.5	11.5
80	62.2	62.9	63.6	64.3	65.0	65.8	66.4	67.1	67.8	68.5	12.0
90	69.2	—	—	—	—	—	—	—	—	—	—

and Methods (Washington, 1887) Abbe gives the theory of this class of anemometers and develops the following additional forms: Two vertical tubes, whose apertures are respectively directed to the windward and the leeward, and within which are two independent barometers, give the means of determining the barometric pressure plus the wind pressure and minus the wind pressure respectively, so that both the velocity of the wind and the true barometric pressure can be determined. If instead of a simple opening at the top of the tube we place there horizontally the contracted Venturi's tube, we obtain a maximum wind effect, which gives an accurate measure of the wind velocity, and is the form recommended by Borden as an improvement on the form of Abbe. In anemometers of this class the inertia of the moving parts is reduced to a minimum, and the measurement of rapid changes in velocity and of the maximum intensity of gusts becomes feasible. On the other hand, these researches have shown how to expose a barometer so that it shall be free from the dynamic or wind effect even in a gale. It has only to be placed within a room or box that is connected with the free air by a tube that ends in a pair of parallel plane plates. When the wind blows past the end of this tube it flows between these plates in steady linear motion, and can produce no disturbance of pressure at the mouth of the tube if the plates are at a suitable distance apart. This condition of stable flow, as contrasted with permanent flow, was first defined by Sir William Thomson (Lord Kelvin) (see *Phil. Mag.*, Sept. 1887). Such a pair of small circular plates can easily be applied to a tube screwed into the air-hole at the back of any aneroid barometer, and thus render it independent of the influence of the wind.

As to the exposure of the anemometer, no uniform rules have as yet been adopted. Since the wind is subject to exceedingly great disturbances by the obstacles near the ground, an observer who estimates the force of the wind by noticing all that goes on over a large region about him has some advantage over an instrument that can only record the wind prevailing at one spot. The practice of the U.S. Weather Bureau has been to insist upon the perfectly free exposure of all anemometers as high as can possibly be attained above buildings, trees and hills; but, of course, in such cases they give records for an elevated point and not for the ground. These are therefore not decidedly appropriate for use in local climatological studies, but are those needed for general dynamic meteorology, and proper for comparison with the isobars and the movements of the clouds shown on the daily weather map.

Hygrometer.—Moisture floats in the atmosphere either as invisible vapour or as visible haze, mist and cloud. The presence of the latter generally assures us that the air is fully saturated. The total amount of both visible and invisible vapour contained in a unit volume of cloud or mist is directly determined by the Schwachhofer or Svenson hygrometer, or it may be ascertained by warming a definite portion of the air and fog and measuring the tension of the vapour by Edelman's apparatus. Both these methods, however, are in practice open to many sources of error. If only invisible aqueous vapour is present we may determine its amount by several methods: (a) the chemical method, by absorbing and weighing it; (b) the dew-point method, by cooling the air down to the temperature where condensation begins; (c) Edelman's method, by absorbing the moisture chemically and measuring the change in vapour

tension; (d) by adding vapour until the air is saturated, and measuring either the increased tension or the quantity of evaporation; (e) the psychrometric method, by determining the temperature of evaporation.

The wet-bulb thermometer, which is the essential feature of the last method, was used by Baumé in 1758 and de Saussure in 1787, but merely giving an index of the dryness of the air. The correct theory of its action was elaborated by many early investigators: Ivory, 1822; August, 1825; Apjohn, 1834; Belli, 1838; Regnault, 1845. From the last date until recent years no important progress was made in our knowledge of the subject, and it was supposed that the psychrometer was necessarily crude and unsatisfactory; but in its modern form it has become an instrument of much greater precision, probably quite as trustworthy as the dew-point apparatus or other method of determining atmospheric moisture. In order to secure this accuracy the two bulbs must be of the same size, style and sensitiveness; the wet bulb must be covered with thin muslin saturated with pure water; both thermometers must be whirled or ventilated rapidly, but at the definite prearranged rate for which the tables of reduction have been computed; and, finally, both thermometers must be carefully sheltered against obnoxious radiations. In order to attain these conditions European observers tend to adopt Assmann's ventilated psychrometer, but American observers adopt Arago's whirled psychrometer, set up within an ordinary shelter. In either method the dew-point should be determined with an accuracy of one-tenth degree C. or two-tenths F. As a crude approximation, we may assume that the temperature of the dew-point is below the temperature of the wet bulb as far as that is below the dry bulb. A greater accuracy can be attained by the use of Ferrel's or Marvin's psychrometric tables or Grossman's formula. But the vapour tension over ice and over water as measured by Marvin and by Juhlin must be carefully distinguished and allowed for. The Smithsonian Meteorological Tables (ed. of 1908) and the new psychrometric tables by Bjerkeland for temperatures below freezing (Christiani, 1907) represent the present condition of our knowledge of this subject. Glaisher deduced empirically from a large mass of observations certain factors for computing the dew-point, but these do not represent the accuracy that can be attained with the whirled psychrometer, nor are they thoroughly satisfactory when used with Regnault's tables and the stationary psychrometer. Especially should their use be discarded when the wet bulb is greatly depressed below the dry bulb at the atmosphere correspondingly dry. For occasional use at stations, and for the use of explorers and explorers, nothing can exceed the convenience and accuracy of the sling psychrometer, especially if the bulbs are protected from radiation by a slight covering of non-conducting material, or even metal, as was done by Craig in 1866-1869 for the stations of the U.S. Army Surgeon-General. The hair hygrometer gives directly the relative humidity or the ratio between the moisture in the air and that which it would contain if saturated. The very best forms perform very well for a time, and are strongly recommended by Ferrel, and must be used in self-recording apparatus for balloons and kites; they are standardized by comparison with the ventilated psychrometer, which itself must be dependent on the standard dew-point apparatus.

Rain and Snow Gauge.—The simple instrument for catching and measuring the quantity of rain, snow or hail that falls upon a definite horizontal area consists essentially of a vertical cylinder and the measuring apparatus. The receiving mouth of the cylinder is usually terminated by a cone or funnel, so that the water running down through the funnel and stored in the cylinder is protected from evaporation or other loss. The cylinder is firmly attached to the ground or building, so that the mouth is held permanently at a definite altitude.

The sources of error in its use are the spattering into it from the ground or neighbouring objects, and the loss due to the fact that when the wind blows against the side of the cylinder it produces eddies and currents that carry away drops that would otherwise fall into the mouth, and even carries out of the cylinder drops that have fallen into it. As a consequence all the ordinary rain-gauges catch and measure too little rainfall. The deficit increases with the strength of the wind and the smallness or lightness of the raindrops and snowflakes. If we assume that the correct rainfall is given by a gauge whose mouth is flush with the level of the ground, and that the wind blows against it at a certain angle, then, on the average of many years, and numerous observations with ordinary rain-gauges in western Europe, and for the average character of the rain in that region and the average strength of the attending winds, the deficit of rain caught by a rain-gauge whose mouth is 1 metre above the ground is 6% of the proper amount; if its elevation is 1 ft. above ground, the deficit will be 3%. This deficit increases as the gauges are higher above the ground in proportion approximately to the square root of the altitude, proving that they are fully exposed to the increase of wind that prevails at those altitudes. It is evident that even for

altitudes of 5 or 10 ft. the records become appreciably discrepant from those obtained at the surface of the ground. The following table shows in the last column the observed ratio between the catches of gauges at various altitudes and those of the respective standards at the level of the ground. Unfortunately, there are no records of the force of the wind to go with these measurements; but we know that in general, and on the average of many years, corresponding with those here tabulated, the velocity of the wind increases very nearly as the square root of the altitude. Although this deficit with increasing altitude has been fully recognized for a century, yet no effort has been made until recent years to make a proper correction or to eliminate this influence of the wind at the mouth of the gauge. Professor Joseph Henry, about 1850, recommended to the observers of the Smithsonian Institution the use of the "pit-gauge." About 1858 he recommended a so-called shielded gauge, namely—a simple cylindrical gauge 2 in. in diameter, having a wide horizontal sheet of metal like the rim of an inverted hat soldered to it. This would undoubtedly diminish the obnoxious currents of air around the mouth of the gauge, but the suggestion seems to have been overlooked by meteorologists. In 1878 Prof. F. E. Nipher of St. Louis, Missouri, constructed a much more efficient shield, consisting of an umbrelliform screen of wire-cloth having about sixty-four inches to the square inch. This shield seems to have completely annulled the splashing, and to have broken up the eddies and currents of wind. With Nipher's shielded gauges at different altitudes, or in different situations at the same altitude, the rain catch becomes very nearly uniform; but the shield is not especially good for snow, which piles up on the wire screen. Since 1885 numerous comparative observations have been made in Europe with the Nipher gauge, and with the "protected gauge" devised by Boerstein, who sought to prevent injurious eddies about the mouth of the gauge by erecting around it at a distance of 2 or 5 ft. an open board fence with its top a little higher than the mouth of the gauge. The boards or slats are not close together, but apparently afford as good a protection as the shield of Professor Nipher, and give good results with both snow and rain.

Altitude and Relative Catch of Rain.

Situation and Size of Gauge.	Years of Record.	Altitude.		Relative Catch.
		Metres.	%	
Calne, 5-in. and 8-in.	4	1	100	
Calne, 5-in. and 8-in.	3	2	96	
Rotherham, 5-in.	8	1	86	
St Petersburg: Central Physical Observatory, 10-in.	10	4	85	
		5	85	
		6	84	
London: Westminster Abbey	1	9.1	77	
Emden	2	11	72	
St Petersburg: Central Physical Observatory	1	13	68	
York: Museum	3	13	87	
Calcutta: Alipore Observatory	7	15	87	
Woodside: Walton-on-Thames	1	15	73	
Philadelphia: Frankford Arsenal	3	16	95	
Sheerness: Waterworks	3	21	52	
Whitehaven: St James's Church	10	24	66	
St Petersburg: Central Physical Observatory	10	25	59	
Paris: Astronomical Observatory	40	27	81	
Dublin: Monkstown	6	27	64	
Oxford: Radcliffe Observatory	8	34	59	
Copenhagen: Observatory	4	36	67	
London: Westminster Abbey	1	46	52	
Chester: Leadworks	2	49	61	
Wolverhampton: Waterworks	3	63	59	
York Minster	3	65	60	
Boston: St Botolph's Church	2	75	47	

In general it is now conceded by several high authorities that the measured rainfall must be corrected for the influence of the wind at the gauge, if the latter is not annulled by Nipher's or Boerstein's methods. A practicable method of measuring and allowing for the influence of the wind, without introducing any very hazardous hypothesis, was explained by Abbe in 1888 (see *Symon's Meteorological Magazine* for 1889, or the *U.S. Monthly Weather Review* for 1899). This method consists simply in establishing near each other several similar gauges at different heights above the ground, but in otherwise similar circumstances. On the assumption that for small elevations the diminution of the wind, like that of the rainfall, is very nearly in proportion to the square root of the altitude, the difference between the records for two different altitudes may be made the basis of a calculation which gives the correction to be applied to the record of the lower gauge,

in order to obtain the rainfall that would have been caught if there were no wind. It is only when the catch of the gauge has been properly corrected for the effect of the wind on the gauge that we obtain numbers that are proper to serve for the purpose of determining the variation of the rainfall with altitude and locality, the influence of forests and the periodical changes of climate. Methods of measuring dew, frost, hail, sleet, *glacets* and other forms of precipitation still remain to be devised; each of these has its thermodynamic importance and must eventually enter into our calculations.

It has been common to consider that the rain-gauge cannot be properly used on ships at sea, owing to the rolling and pitching of the vessel and the interference of masts and rigging; but if gauges are mounted on gimbals, so as to be as steady as the ordinary instruments of coast and the records of great importance. Experimental work of this sort was done by Mohr, and afterwards in 1882 by Professor Frank Waldo; but the most extensive inquiry has been that of Mr. W. G. Black (see *Journal Manchester Geographical Society*, 1898, vol. xiv.), which satisfactorily demonstrates the practicability and importance of the marine rain-gauge.

Evaporometer.—The moisture in the atmosphere comes from the surface of the earth or ocean by evaporation, a process which goes on continually, replacing the moisture that is precipitated as rain, hail, snow and dew, and maintaining the total quantity of the moisture in the atmosphere at a very uniform figure. The rate of evaporation depends on the temperature, the dryness, and the velocity of the wind. It is not so important to meteorologists to know where the moisture comes from as to know its amount in the atmosphere, and in fact no method has yet been devised for determining how much moisture is given up by any specific portion of the earth, or ocean, or forest. Our evaporimeters measure the quantity of moisture given off by a specific surface of water, but it is so difficult to maintain this water under conditions the same as obtain in nature that no conclusions can be safely deduced as to the actual evaporation from natural surfaces. The proper meteorological use of these evaporimeters is, as integrating hygrometers, to give the average humidity of the air, the psychrometer giving the conditions prevailing at any moment.

Among the many forms of evaporimeter the most convenient is that devised by Piche, which may be so constructed as to be exceedingly accurate. The Piche evaporimeter consists essentially of a glass tube, whose upper end is closed hermetically, whereas the lower end is covered by a horizontal disk of bibulous paper, which is kept wet by absorption from the water in the tube. As the water evaporates its descent in the tube is observed, whence the volume evaporated in a unit of time becomes known. So long as the paper remains clean, and the water is pure, the records of the instrument depend entirely upon the evaporating surface, the dryness of the air, and the velocity of the wind. Careful comparisons between the Piche and the various forms of absolute evaporimeters were made by Professor Thomas Russell, and the results were published in the *U.S. Monthly Weather Review* for September 1888, pp. 235-239. By placing the Piche apparatus upon a large whirling machine he was able to show the effect of the wind upon the amount of evaporation. This important datum enabled him to explain the great differences recorded by the apparatus established at eighteen Weather Bureau stations. Based upon these results, he prepared a table of relative evaporation within thermometer shelters at all stations. The actual evaporations from ground and water in the sunshine may run parallel to these, but cannot be accurately computed. It is probable that Professor Russell's computations are smaller than the evaporations from shallow bodies of water in the sunshine, but larger than for deep bodies, like the great lakes, and for running rivers. Recent elaborate studies of evaporation have been undertaken in Egypt and in South Africa—perhaps the most interesting case occurs in southern California. Here the Colorado river, having broken through its bounds, emptied itself into a great natural depression and formed the so-called "Salton Sea," about 80 m. long, 20 wide and 100 ft. deep, before it could be brought under control. This sea is now isolated, and will, it is hoped, dry up in eight or ten years. Meanwhile the U.S. Weather Bureau has established a large number of evaporation stations in and around it, and has begun the study not only of the relation between evaporation, wind and temperature, but of the eventual disposition of this evaporation throughout the atmosphere in the neighbourhood of the sea (see the Reports of Professor F. H. Bigelow in *U.S. Monthly Weather Review*, 1907-1909, as also the elaborate bibliography of evaporation in the same volumes). Although the influence of the evaporation on local climate is scarcely appreciable to our hygrometric apparatus, yet it is said to be so in the development and ripening and drying of the dates raised on the U. S. Government "Experimental date farm" a few miles north-east of the Salton Sea.

Nephoscope.—The direction and apparent velocity of the motion of a cloud are best observed by means of the nephoscope, which has now become a necessary item in the outfit of any first-class meteorological station. Among the various forms of this instrument are the nephoscope of Formioni, the marine nephoscope of Fineman, the simple mirror with attachments used by Clayton, the cloud camera of Vettin, and the alt-azimuths of Mohn and Lettry. The most perfect form for use on land is that devised by Professor Marvin in 1866 for the U.S. Weather Bureau stations (see fig. 2); while the most convenient for use at sea is that devised and used

at so great a distance from him that their record is not supposed to belong to his locality. As the cloudiness—or its reciprocal, the sunshine—is supposed to be the most important item in agricultural climatology, and is certainly very important for dynamic meteorology, it is usually considered desirable to obtain more complete records than are given by only one or two specified hours of observation. To this end apparatus for recording sunshine, or, rather, the effect of cloudiness, is widely adopted. At least three forms are worth describing as being extensively used.

The *Jordan photographic sunshine recorder* consists of a cylinder enclosing the sheet of paper, the sun's rays penetrate through a small aperture, and describe a path from sunrise to sunset, which appears on this sheet after it has been properly washed with the fixing solution. Any interruption in this path, due to cloudiness or haze, is of course clearly shown, and gives at once the means of estimating what percentage of the day was clear and what cloudy. The modified form of the instrument devised by Professor Marvin has been used for many years at about forty Weather Bureau stations, but the original construction is still employed by other observers throughout the world. The *Stokes compass recorder* consists of a globe of glass acting as a burning-glass. A sheet of pasteboard or a block of wood at the rear receives the record, and the extent of the charring gives a crude measure of the percentage of full or strong sunshine. Many of these instruments are used at stations in Great Britain and the British colonies. The *Marvin thermometric sunshine recorder* consists of a thermometer tube, having a black bulb at the lower end and a bright bulb at the other. The excess of temperature in the black bulb causes a thread of mercury to move upwards, and for a certain standard difference of temperature of about 5° F., such as would be produced by the sun shining through a very thin cloud or haze, a record is made by an electric current on a revolving drum, and simply shows when during the day sunshine of a certain intensity prevailed, or was prevented by cloudiness. D. T. Maring, in the *U.S. Monthly Weather Review* for 1897, described an ingenious combination of the thermometer and the photographic register of cloudiness which is worthy of further development. It gives both the quantity of cloudiness and intensity of the sunshine on some arbitrary relative scale.

The intensity of the sunshine, as sometimes employed in general agricultural studies, is crudely shown by Violle's conjugate bulbs, which are thin copper balls about 3 in. in diameter, one of them being blackened on the outside and the other glazed. When exposed to the sunshine the difference in temperature of the two bulbs increases with the intensity of the sunshine, but as the difference is dependent to a considerable extent on the wind, the Violle bulbs have not found wide application. The Arago-Davy actinometer, or bright and black bulbs *in vacuo*, constitutes a decided improvement upon the Violle bulbs, in that the vacuum space surrounding the thermometer diminishes the effect of the wind. The physical theory involved in the use of the Arago-Davy actinometer was fully developed by Ferrel, and he was able to determine the coefficient of absorption of the earth's atmosphere and other data, thereby showing that this apparatus has considerable pretensions to accuracy. In using it as contemplated by Arago and Davy and by Professor Ferrel, we read simply the stationary temperature attained by the bright and black thermometers at any moment, whereas the best method in actinometry consists in alternately shading and exposing any appropriate apparatus, so as to determine the effect of the solar radiation in one minute, or some shorter unit of time; this method of using the Arago-Davy actinometer was earnestly recommended by Abbe in 1883, and in fact tried at that time; but the apparatus and records were unfortunately burned up. This so-called dynamic, as distinguished from the static, method was first applied by Pouillet in 1838 in using his pyrheliometer, which was the first apparatus and method that gave approximate measures of the radiant heat received from the sun. In order to improve upon Pouillet's work more delicate apparatus has been constructed, but the fundamental methods remain the same. Thus Ångström has applied both Langley's bolometer and his own still more sensitive thermoelectric couple and balance method; Violle uses his absolute actinometer, consisting of a most delicate thermometer within a polished metal sphere, whose temperature is kept uniform by the flow of water; while Crova, with a thermometer within an enclosure of uniform temperature, claims to have attained an accuracy of one part in a thousand. Chwolson has reviewed the whole subject of actinometry, and has shown the greater delicacy of his own apparatus consisting of two thin plates alternately exposed to and shielded from sunshine, whose differences of temperature are measured by electric methods.

As none of the absolute methods for determining the solar radiation in units of heat lend themselves to continuous registration, it is important to call attention to the possibility of accomplishing this by chemical methods. The best of these appears to be that devised by Marchand, by the use of a device which he calls the Phot-antiputimer. In this the action of the sunlight upon a solution of ferric-oxalate and chloride of iron liberates carbonic acid

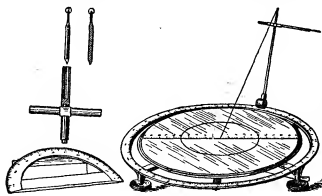

FIG. 2.—Marvin's Nephoscope.

in 1889 by Professor Abbe on the cruise of the U.S. ship "Pensacola" to the west coast of Africa, but first described in the report of the International Meteorological Congress held at Chicago in August 1893.

The construction of this instrument is shown in figs. 3, 4, 5. In using it the observer looks down upon a horizontal mirror and observes the reflection of the cloud. By moving his eye he brings any cloudy point into coincidence with the reflection of a small fixed spherical knob K above the mirror, and keeps the images of the knob and the cloud coincident as they pass from the centre of the mirror to its edge. This line of motion shows the azimuth of the horizontal component of the cloud's motion. The course of the vessel is shown by the compass card and lubber line AF seen below the mirror. The apparent angular velocity of the cloud, as it would be if the cloud started from the zenith, is obtained by counting the seconds that elapse between its passage from the centre to the edge, or to a small circle inscribed within the edge. With Marvin's nephoscope two observers a short distance apart may easily determine the apparent altitude, and azimuth, and motion of any cloud, whence its true altitude and velocity may be computed. But when the observer uses Abbe's marine nephoscope on a vessel which is itself in motion he observes the result of his own motion and that of the cloud. If his vessel is under his control, so that he may change its velocity or direction at will, he easily determines this resultant for two different courses, and obtains data by which he is enabled to calculate the real altitude and velocity of the cloud in terms of his own velocity. As the marine nephoscope can be used on a wagon moving rapidly over a smooth road, or in a small boat on a smooth pond, almost as well as on a larger sea-going vessel, it becomes an instrument of universal application for cloud study. It is also equally convenient for observing the positions of auroras, halos, meteors, and other special phenomena. For the international work undertaken during the year 1898 the photographic camera established upon an alt-azimuth mounting, or the so-called photogram-meter, was especially developed. In this apparatus photographs of the clouds are taken simultaneously at two or more stations, and in each case the centre of the photographic plate has its altitude and azimuth determined. From this centre one can measure on the plate the additional angles required in order to fix the altitude and azimuth of any point that is photographed, and thus the dimensions of the whole visible cloud and its internal or differential motions can be determined, as well as its general motion. During the years 1896-1898 about twenty stations were occupied throughout the world for the purpose of determining accurately the altitudes and motions of every layer of cloud.

Sunshine Recorder.—The ordinary meteorological record specifies the proportion of sky that appears to be covered with cloud, or the so-called cloudiness, usually expressed in tenths. The observer generally confines his attention to that portion of the sky within sixty degrees of the zenith, and ignores the lower zone, since the clouds that are found therein are often

gas, the amount of which can be measured either continuously or every hour; but in its present form the apparatus is affected by several serious sources of error.

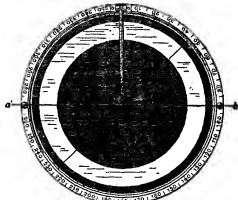

FIG. 3.—Abbe's Marine Nephoscope. Horizontal Projection of Mirror.

The electric compensation pyrheliometer, as invented by Knut Angström (*Ann. Phys.*, 1899), offers a simple method of determining accurately the quantity of radiant energy. He employs two blackened platinum surfaces, one of which receives the radiations to

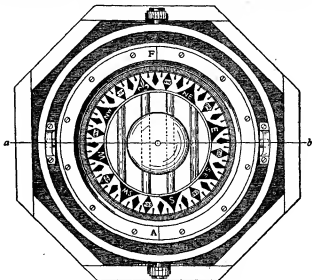

FIG. 4.—Abbe's Marine Nephoscope. Horizontal Projection of Compass.

be measured, while the other is heated by an electric current. The difference of temperature between the two disks is determined by a thermocouple, and they are supposed to receive and lose the same amount of energy when their temperatures are the same. A Hefner

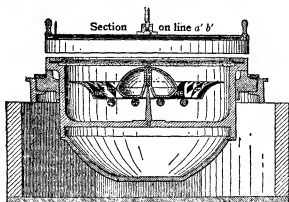

FIG. 5.—Abbe's Marine Nephoscope. Vertical Section.

lamp is used as an intermediate standard source of radiation, and alternate observations on any other source of radiant heat give the means of determining their relation to each other. By means of such instruments Angström secured simultaneous observations

on the intensity of the solar radiation at two points, respectively, 360 and 3352 metres above sea-level, and determined the amount of heat absorbed by the intermediate atmosphere. An accuracy of 1-1000 appears to be attainable, and this apparatus is now being widely used. The records of 1901-1905 have already given rise to the belief that there is a variation in our insolation that may eventually be traced back to the sun's atmosphere.

Meteorograph.—The numerous forms of apparatus designed to keep frequent or continuous register of the prevailing pressure, temperature, moisture, wind, rainfall, sunshine, evaporation, and other phenomena are instruments that belong peculiarly to meteorology as distinguished from laboratory physics. Such apparatus may be broadly divided into several classes according as the records are obtained by the help of photography, or electricity, or by direct mechanical action. The prevailing tendency at present is in favour of apparatus in which the work of the recording pen is done by a falling weight, whose action is timed and limited by the making and breaking of electric currents by the meteorological apparatus proper. The most serious defect in such instruments, even when kept in good working order, is a want of sensitiveness commensurate with the desired openness of scale. It is very important that a fraction of a minute of time should be as recognizable as one-tenth of a degree of temperature; one thousandth of an inch of barometric pressure, and velocities of one hundred miles per hour, as well as rapid changes in all these elements, must be measurable. But instruments whose scales are large enough to record all these quantities are usually so sluggish as regards time that the comparison of the records is very unsatisfactory. In order to study the relationships between temporary and fleeting phenomena, it is necessary that all instruments should record upon the same sheet of paper, so that the same time-scale will answer for all.

The instruments that respond most nearly to the general needs of meteorology are the various forms of meteorographs devised by Wild for use at St Petersburg, by Sprung and Fuess for use at Hamburg and Berlin, and by Marvin for Washington. The photographic systems for pressure and temperature introduced many years ago at stations in Great Britain and the British colonies are not quite adequate to present needs. The portable apparatus manufactured by Richard Frères at Paris is in use at a very large number of land stations and on the ocean, and by giving special care to regular control-observations of time, pressure and temperature, important results may be obtained; but in general the time-scales are too small, and the unknown sources of error too uncertain, to warrant implicit reliance upon the records.

Polarimeter.—The brightness and blueness of the sky light, and especially its polarization, have been observed with increasing interest, as it seems possible from these elements to ascertain something with regard to the condition and amount of the moisture of the air. With a simple Nicol's prism held in the hand and turned slowly about the axis of vision one can quickly recognize the fact that the sky light is polarized, and that the polarization is largely due to the air or dust lying between us and the clouds in the distant horizon. Arago, with a more delicate form of polariscope, determined the existence of a so-called neutral region near the sun. Babinet located a neutral point or zone about as far from the anti-sun as was Arago's from the sun itself. Brewster discovered a neutral point near the sun and horizon, disappearing when the sun is more than 15° above the horizon. Finally, Brewster explored the sky sufficiently to draw lines of equal polarization, which he published in Johnston's *Physical Atlas*, and which were confirmed by Zantedeschi in 1849. Since those days far more delicate work has been done—first by Bosanquet of Oxford, afterwards by Prof. E. C. Pickering of Harvard University and Prof. A. W. Wright of Yale University. A later contribution to the subject is by Jensen (see *Met. Zeit.* for Oct.-Dec. 1899), who has observed the brightness as well as the polarization, and thus completed the data necessary for testing the various physical theories that have been proposed for the explanation of this phenomenon. We owe to Tyndall the discovery that when a beam of white light penetrates a mass of fine aqueous mist the latter sends off at right angles a delicate blue light, which is almost wholly polarized in a plane at right angles to the plane

of reflection. As the particles of mist grow larger, the blue light becomes whiter and the polarization disappears. The original vapour particles are undoubtedly so small as to be comparable in size with a fraction of the wave-length of ordinary light, and Rayleigh was able to show that molecular as well as minute particles must have a power of selection, and that the diffused sky light comes to us by selective reflection. On this basis we should expect that in the driest air at great heights, where the temperature is low and condensation has but just begun, and the dust particles are rare, there would occur the smallest aqueous particles reflecting light of the feeblest intensity but the largest percentage of polarization. Rayleigh has shown that it is quite possible that the molecules of oxygen and nitrogen constituting the atmosphere may also exercise a diffuse selective reflection, and contribute to the brightness and polarization that are mainly due to aqueous vapours. (See SKY.)

We thus see the theoretical importance of adding photometry and polarimetry to the work of a meteorological observatory. The apparatus to be used in this connexion will vary somewhat with the exact character of the observations to be made. The most extensive researches that have yet been carried out in this line with a meteorological application in view are those of Jensen, Crova, Cornu, Pickering, Kimball, Nichols, and especially Rubenson, who in fact recommended that polarimetry and photometry should go hand in hand. In order to measure the position of the plane of polarization the Arago polariscope may be used, but, in order to measure the percentage of polarized light, Mascart's modification of the Savart is better. In order to measure the general brightness of a spot in the sky, Jensen has used a slight modification of the Weber photometer, and in fact Weber himself has applied the same method to the measurement of the daylight. The complete work of Jensen was published in the *Schriften* of the Scientific Association of Schleswig-Holstein in 1899, and, like the memoir published by Rubenson in 1863, it gives the meteorological conditions in full as a basis for the investigation of the connexion between sky light and the moisture in the atmosphere. In his work during 1906-1909 with Angström's pyrheliometer Mr A. H. Kimball of Washington has advantageously used the Pickering polarimeter, and has shown that the transparency of the air and the polarization of light go hand in hand.

Cyanometer.—The cyanometer devised by Arago to measure the blueness of the sky consisted of an arbitrary scale of blues on a strip of porcelain, with which one could compare the blue of the sky. This comparison, however, is open to many subjective errors. A more satisfactory apparatus is Zollner's photometer, or some equivalent, in which a patch of white surface is illuminated by any particular tint or combination that may be desired. In fact, Maxwell's colour-box admits of ready application to the analysis of sky light, and reveals at once the proportions of red, yellow, and blue that may be contained therein.

Dust-counter.—The importance of observing the dustiness of the atmosphere has been especially realized since the invention and use of various forms of apparatus for counting the number of particles of dust in a small volume of air. These inventions are due to Mr John Aitken, of Edinburgh.

The latest form of his apparatus is the very convenient "pocket dust-counter." In this the air contained in a small receiver is rendered dustless by repeated expansions; the cooling due to expansion forces the vapour to condense upon the dust, which, becoming heavy, falls to the bottom, so that in a short time all is removed. A small stop-cock is now turned, so as to allow a definite small quantity of air to enter and mix with the dustless air in the receiver. The dusty and the dustless airs are now thoroughly mixed, and again the whole quantity within the receiver is expanded, and the dust nuclei fall down by the condensation of vapour upon them. Assuming that every particle of dust is represented by a minute droplet of water, we have but to count the latter; this is easily done by causing all the drops to fall upon a polished plate of black glass, which is divided into small squares by fine lines ruled with a diamond point. Usually each of these squares represents a small fraction of a cubic centimetre of air; thus in one case the number of fog particles averaged 2.6 per square millimetre of the glass plate, and, as the multiplying factor was 100, this corresponded to 260 particles of dust in a cubic centimetre of air. The cleanest air has been found in the West Highlands of Scotland, where 16 particles per cubic centimetre was once recorded as the minimum, while 7600 was the maximum. On the Rigi Kulm, in Switzerland, the cleanest air gave 210, and the dustiest 16,500. On comparing the records of the dust-counter with the record of the apparent state of the air,

Mr Aitken found that 500 particles per cubic centimetre corresponded to clear air, and 1900 to a thick haze in which distant mountain tops were hidden. In the cities the particles of soot and effluvia of all kinds act as dust, and both in London and Paris the numbers ran as high as 80, 116, 150 and 210 thousand per cubic centimetre.

Electrical Apparatus.—The electrical phenomena of the atmosphere undoubtedly belong to meteorology, and yet the methods of observation have been so unsatisfactory and the difficulty of interpreting the results has been so baffling that regular observations in electricity are only carried out at a very few meteorological institutions. A general summary of our knowledge of the subject was prepared by J. Elster and H. Geitel for the International Congress held at Chicago in 1893, but since that date the methods and apparatus of observation have received important modifications.

In general the water-dropping collector of Lord Kelvin, arranged for continuous record by Mascart, continues to be the best apparatus for continuous observation at any locality, and a portable form of this same apparatus is used by explorers and in special series of local observations. In order to explore the upper air the kite continues to be used, as was done by A. J. McAdie for the Weather Bureau in 1885 and by Weber at Kiel in 1889. The difference of potential between the upper and lower end of a long vertical wire hanging from a balloon has been measured up to considerable altitudes by Elster and Tuma. In general it is known that negative electricity must be present in the upper strata just as it is in the earth, while the intervening layer of air is positively electrified. The explanation of the origin of this condition of affairs is given in the recent researches of Sir J. J. Thomson (*Phil. Mag.*, Dec. 1899), and his interpretation

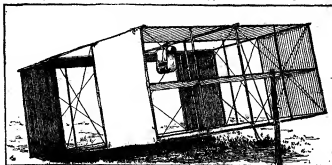

FIG. 6.—Marvín-Hargrave Kite, with Meteorograph in position.

is almost identical with that now recognized by Elster (see *Terrestrial Magnetism*, Jan. 1900, iv. 213). According to these results, if positive and negative ions exist in the upper strata and are carried up with the ascending masses of moist air, then the condensation of the moisture must begin first on the negative ions, which are brought down eventually to the earth's surface; thus the earth receives its negative charge from the atmosphere, leaving a positive charge or an excess of positive ions in the middle air. (See G. C. Simpson, "Atmospheric Electricity," *Monthly Weather Review*, Jan. 1906, p. 16.)

The observations of atmospheric electricity consist essentially in determining the amount and character of the difference of potential between two points not very far distant from each other, as, for instance, the end of the pipe from which the water-drops are discharged, and the nearest point of the earth or buildings resting on the earth. The record may have only an extremely local value, thus the investigations of Professor John Trowbridge of Harvard University, made in conjunction with the U.S. Weather Bureau in 1882-1885, show that the differences vary so much with the winds, the time of day, and the situation of the water-dropper that the mere comparison of records gives no correct idea of the general electrical relationships. It has been suggested that possibly daily telegrams of electric conditions and daily maps of equipotential curves over the North American continent would be of help in the forecasting of storms, but it is shown to be useless to attempt any such system until some uniform normal exposure can be devised. Indeed it has not yet been shown that atmospheric electricity is of importance in dynamic meteorology. (See ATMOSPHERIC ELECTRICITY.)

Aerial Research.—The exploration of the upper atmosphere is to be regarded as the most important field of research at the present time; the kite and the balloon enable observers and apparatus to be carried to considerable heights, though by no means so far as is desirable. The kite was first used in meteorological work by Alexander Wilson at or near Glasgow in 1749, and has since then been frequently used by English observers. It was used in 1867 by Abbe in studying the winds under a thundercloud, and in 1877 in

studying the depth of the ocean breeze on the coast of New Jersey, but the later revival of interest in the subject

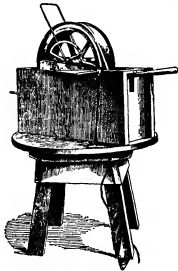

FIG. 7.—Marvin Kite Reel for hand power.

dates from the work done in England in 1882 by E. D. Archibald, who used the kite to carry up anemometers to very considerable heights, and thereby determined the relative movement of the air in the free atmosphere. In 1883 Alexander McAulie used the kite in his studies of atmospheric electricity, Professor Cleveland Abbe proposed to use it for a complete exploration as to temperature, moisture and wind, but W. A. Eddy of New York first forced its varied capabilities upon public attention, and accepted the suggestion of Professor Cleveland Abbe to employ it for meteorological work. Having flown his kites at the Blue Hill Observatory, and having carried up with them the self-registering apparatus devised by Mr Ferguson, Eddy left the further prosecution of this work to Mr Rotch, who has made this a prominent feature of the work at his observatory, having carried up meteorographs to the height of 15,000 feet by means of a series of kites flying in tandem. The officials of the U. S. Weather Bureau have developed the admirable cellular kite, invented by Hargrave of Australia, and Professor Marvin's works on the theory and construction of this form are well known.

The general appearance of the Marvin or Weather Bureau kite, his reel and other apparatus that go with it, and his meteorograph, are shown in Figs. 6, 7, 8. The size ordinarily used carries about 68 sq. ft. of supporting surface of muslin tightly stretched on a light wooden frame. The line, made of the best steel piano-wire, is wound and unwound from a reel which keeps an automatic record

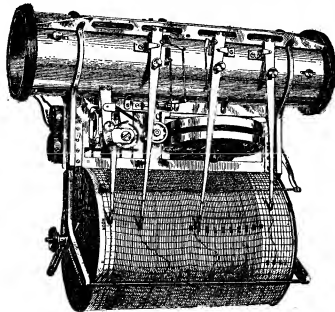

FIG. 8.—Marvin Kite Meteorograph.

of the intensity and direction of the pull. The reeling in and out may be done by hand, but ordinarily demands a small gas-engine. The observer at the reel makes frequent records of the temperature, pressure and wind, the apparent angular elevation of the kite, and the length of wire that is played out. At the kite itself the Marvin meteorograph keeps a continuous record of the pressure, tempera-

ture, humidity and velocity of the wind. The meteorograph, with its aluminum case, weighs about two pounds, and is so securely lashed behind the front cell of the kite that no accident has ever happened to one, although the kites sometimes break loose and settle to the ground in a broken country many miles away from the reel. On four occasions the line has been completely destroyed by slight discharges of lightning; but in no case has the kite, the observer, or the reel been injured thereby. Of course, such lightning is preceded by numerous rapidly increasing sparks of electricity from the lower end of the wire, which warn the observer of danger. During the six months from May to October 1898, seventeen kite stations were maintained by the U. S. Weather Bureau in the region of the lakes, the Upper Mississippi and the Lower Missouri valleys, in order to obtain data for the more thorough study of atmospheric conditions over this particular part of the country. During these months 1217 ascents were made, and as no great height was attempted they were mostly under 7000 or 8000 feet. There was thus obtained a large amount of information relating to the air within a mile of the earth's surface. The general gradients of temperature, which were promptly deduced and published by H. C. Frankenfield in 1899 in a bulletin of the Weather Bureau, gave for the first time in the history of meteorology trustworthy observations of air temperatures in the free atmosphere in numbers sufficient to indicate the normal condition of the air.

The kite and meteorograph have now been adopted for use by all meteorologists. The highest flight seems to be that of the 3rd of October 1907, at Mt. Weather in Virginia, when 23,110 ft. above sea-level or 21,385 ft. above the reel was attained by the use of 37,300 ft. of wire and 8 kites tandem.

The balloon was used for the scientific exploration of the atmosphere quite freely during the 19th century. The first important voyages were those of Gay-Lussac and Biot at Paris in August and September of 1804. The next important ascent was that of Bixio and Barral in 1850 at Paris. The most remarkable high ascents have been those of James Glaisher, and of September 1862, and Berson at Berlin in 1880; on both of these occasions the aeronauts attained altitudes of from 30,000 to 35,000 feet. Systematic ascents at many points in Europe simultaneously on pre-arranged dates were made during the years 1895-1899, and led to the development of a general international system of ascension on pre-arranged days of the year that is now a very important feature in the study of the atmosphere.

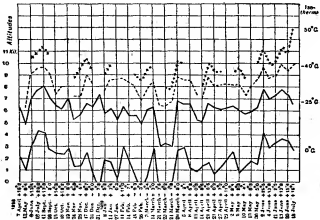

FIG. 9.—Chart of Isotherms in Free Air above Trappes.

This diagram shows the height at which the isotherms of 0° , -25° , -40° , -50° C. were encountered on the respective dates. Below the ground-line are given both the dates and the temperatures of the air observed at the ground when the balloon started on each ascent. The isotherms of -40° and -50° are not given for certain ascents, because in these the balloon did not rise high enough to encounter those temperatures.

Owing to the great risk of human life in these high ascents and especially to the fact that we desire records from still greater heights, efforts have been made to devise self-recording apparatus that may be sent up alone to the greatest heights attainable by free hydrogen balloons carrying the least possible amount of ballast. The pioneer in this new field of work was Léon Teisserenc de Bort of Paris. As these ascensions are made with great velocity, and therefore as nearly vertical as possible, he called them "soundings," because of their analogy to the mariner's usage at sea, and his balloon is called a "sounding balloon." The balloons of silk collapse, those of india-rubber explode, and descend about as rapidly as they ascended,

Such balloon soundings have been made not only individually, but by pre-arranged system, simultaneously in combination with the ascent of free-manned balloons above referred to; and at some places kites have been simultaneously used in order to obtain records for the lower atmosphere. The first experiments in simultaneous work were made in 1866 and 1867, when ascents were made at eight or more points in France, Germany and Russia. These experiments and the discussions to which they gave rise have emphasized the importance of increasing the sensitiveness of the self-recording apparatus, and as far as practicable the rapidity of the ventilation of the thermometers, and of providing more perfect protection against radiation from the sun or to the sky. It is believed that accurate records may be attained up to at least 30,000 metres, but as yet only 26,000 has been attained, and the records brought back are still under considerable criticism on account of instrumental defects. In general the wind that supports a kite also furnishes sufficient ventilation for the thermometer; but in the case of the sounding balloon, which as soon as its rapid rate of ascent diminishes floats along horizontally in the full sunshine, a strong artificial ventilation must be provided. Moreover, the sluggishness of the best thermometers is such that during the rapid rise the records of temperature that are being made at any moment really belong to some altitude considerably below the balloon, and a most critical interpretation of the records is required. Notwithstanding all criticisms, however, the balloon has still all the advantages in showing the existence of a region above the 10,000-metre level, where temperatures cease to diminish rapidly, and may even become stationary.

III.—PHYSICAL AND THEORETICAL METEOROLOGY

The ultimate aim of those who are devoted to any branch of science is to penetrate beyond the phenomena observed on the surface to their ultimate causes, and to reduce the whole complex of observations and empirical rules based upon limited experiences to a simple deductive system of mechanics in which the phenomena observed shall be shown to flow naturally from the few simple laws that underlie the structure of the universe. A correct "theoria" or physical and logical argumentation deducing from primary laws all the phenomena constitutes the noblest achievement of man in science. It is by such works that Newton and Laplace distinguished themselves in astronomy. The development of the true physical and mechanical theories of atmospheric phenomena has made great progress, but is still inferior in completeness to astronomical work, owing to the great complexity of the meteorological problems. The optical and the thermal phenomena have been very satisfactorily elucidated, the electrical phenomena promise to become clear, but the phenomena of motion or aerodynamics have only been elucidated to a limited extent. We must, however, introduce the reader to some of the works that have been published on the subject, in the hope that thereby he will himself be persuaded to further study and stimulated to contribute to our knowledge.

Between the years 1853 and 1861 Professor William Ferrel published in *Gould's Astronomical Journal*, *Runkle's Mathematical Monthly*, and the *American Journal of Science* several treatises on the motions of solids and fluids relative to the earth's surface. His work resulted in the elucidation of the problems of the atmosphere, and in ingenious ways, applicable approximately to such complex cases, and analytically equivalent to the arithmetical method of quadratures or the graphic methods of Goursat, deduced important relations between the density of the air, the barometric pressure, and the attending winds. His essays seemed to show that it might be possible to treat the complex problems of meteorology logically and deductively by analytical, numerical and graphic processes, and his memoirs were the first in which observed average meteorological conditions were properly co-ordinated with the fundamental formulæ of mechanics. A beautiful memoir on the steady motions of the atmosphere was published in 1868 in the *Astronomische Nachrichten* by Professor Adolph Germain, and is now printed in vol. ii. of Abbe's *Metaphysics of the Earth's Atmosphere*. Espy's, Coffin's, Henry's and Ferrel's ideas were made the basis of the system of daily weather predictions published by the present writer in 1869 in the *Daily Weather Bulletin* of the Cincinnati Observatory. Subsequently this work was taken up by the government, and greatly enlarged during 1871-1891 by the chief signal officers of the army, and after 1891 by the chiefs of the U.S. Weather Bureau. Ferrel's writings first attracted the attention of European meteorologists in consequence of reviews published by Hann in the *Zeitschrift für die Österreichische Meteorologische Society* in January 1878, but especially after it had been reprinted in a convenient form by the U.S. Signal Office as "Bulletin No. VIII." In 1881 Ferrel, after finishing his works on the tides for the U.S. Coast and Geodetic Survey, began a new and extensive series of meteorological contributions, three of which were published by the U.S. Coast Survey and the rest by the Signal Office. Stimulated by the urgent needs

of the modern weather bureaus throughout the world, and by the beauty of the mathematical problems presented, numerous mathematicians have lately taken up the study of the earth's atmosphere, so that the literature of the subject is now far more extensive than is generally supposed, including memoirs by Helmholtz, Kelvin, Bjerknes and other famous men.

In addition to the purely mechanical problems, the numerous physical problems have also been carefully treated, both experimentally and mathematically. The problems of radiation have been elucidated by Langley, Hutchins, Angström, Paschen, Violle, Maurer, Crova, Chwolson, Very, Homin, Tamura, Trabort and Coblenz. The thermodynamic problems have been especially developed by Kelvin, Hertz, von Bezold, Ferrel, Brillouin, Neuhoff, Bigelow and Margules. The physical problems involved in the formation of rain-drops have been studied by an optical method by Carl Barus, and with brilliant success, from an electrical point of view, by C. T. R. Wilson and Sir J. J. Thomson at the Cavendish Laboratory, Cambridge, England.

In a complete study of the mechanics of the earth's atmosphere we naturally begin by expressing in simple analytic formulæ all the various conditions and laws according to which every particle of the air must move. Some of these conditions are local, depending upon the resistances at various points of the earth's surface; others are of the nature of discontinuous functions, as, for instance, when the ascent of moist air above a certain altitude gives rise to condensation and clouds, to the evolution of latent heat, to the precipitation of rain, to the shading of the air and the ground below the clouds, and to the sudden interception of all the solar heat at the upper surface of the cloud. It seems, therefore, incredible that the problems of the atmosphere can ever be resolved by purely analytical methods; there must be devised combinations of numerical and graphical, and possibly even mechanical methods to reproduce the conditions and give us special solutions adapted to particular cases. But even these special methods can only be perfected in proportion as we attain approximate solutions of the simpler problems, and it is in this preliminary work that a good beginning has already been made.

The present state of theoretical physical and mechanical meteorology cannot be fully presented in non-technical English text. It is necessary to employ algebraic formulæ, or numerical tables, or graphic diagrams, the former being certainly the least cumbersome and the most generally available. The uniform system of notation devised by Professor F. H. Bigelow, and a very complete summary of the formulæ of physical meteorology expressing the results of many recent students will be found in chapters x. and xi. of his Report on the International Cloud Observations, published as vol. ii. of the annual report of the chief of the U.S. Weather Bureau for 1898-1899.

The fundamental laws to which the atmosphere is subject are as follows:—

A. The Equation of Elastic Pressure.—The pressure shown and measured by the barometer is an elastic pressure acting in all directions equally at the point where it is measured. By virtue of this elastic pressure a unit volume of air will expand in all directions if not rigidly enclosed, but will cool in so doing. On the other hand, if forcibly compressed within smaller dimensions, it will become denser. For a given temperature and volume, a unit volume of air of a prescribed chemical constitution will have a prescribed definite weight. The general relations between absolute temperature, pressure and volume are expressed by the formula

$$pv = RT \quad (1)$$

where T expresses the absolute temperature, p the elastic pressure, v the volume, and R is a constant which differs for each gas, being 29.2713 for ordinary pure dry air and 47.066 for pure aqueous vapour, if we use as fundamental units the kilogram, metre and centigrade degree. This equation is sometimes called the law of Boyle and Charles, or of Gay-Lussac and Mariotte, and it is also known as the equation of condition for true gases, meaning thereby that it expresses the fact that the ideal gas would change its volume in proportion to its absolute temperature and inversely in proportion to its elastic pressure. All gases depart from this law, in proportion as they approach the vaporous condition on the one hand, which is brought about by great pressure and low temperature, or the ultra-gaseous condition on the other hand, which obtains under high temperatures and low pressures. The more accurate law of Van der Waals would complicate our problems too much.

In place of the absolute temperature T we may substitute the expression $273 + t$ or $X(1 + \alpha t)$, where α is the coefficient of volume expansion of the gas for a unit degree of temperature = 0.00367 and t is the temperature expressed on the centigrade scale.

B. Hypsometric Conditions.—The pressure of the atmosphere at any place depends primarily on the weight of the superincumbent mass of air, and therefore diminishes as we ascend to greater heights. If the air is in motion, that and other considerations come in to affect the pressure; but if the air is quiet relative to the earth's

surface, then the pressure at any altitude is expressed by the so-called barometric or hypsometric formula

$$p = \int_{h_0}^h -\sigma g dh \quad (2)$$

where σ is the density and g the apparent gravity for each layer of air whose vertical thickness is dh . The integral of this formula depends upon the vertical distribution of temperature, and moisture, and gravity; but under the usual possible assumptions as to these vertical gradients, the following formula was deduced by Laplace and is generally known as his hypsometric formula:—

$$h - h_0 = 18400(1 + 0.00367t) \left(1 + 0.378 \frac{e}{p}\right) (1 + 0.0026 \cos 2\phi) \left(1 + \frac{h+h_0}{637019}\right) (1 + 0.00157) \log \frac{p_0}{p} \quad (2a)$$

In this formula t is the average temperature, e the average vapour tension of the layer of air, p the barometric pressure at the top of the layer, p_0 the pressure at the bottom, ϕ the latitude of the station, h the elevation above sea-level of the lower limit of the stratum, and h_0 that of the upper limit. The modifications which this formula needs in order to adapt it to other hypotheses representing more nearly the actual distribution of temperature, moisture and gravity, have been elaborately investigated by Angot in a memoir published in 1899 in Part I. of the Memoirs of the Central Meteorological Bureau of France for the year 1896. Angot, Hergesell and Rychakoff have also shown that for hypsometric work of any pretensions to accuracy it is simplest and best to use Laplace's formula for successive thin strata of air, and add together the individual results, rather than attempt a more complex single formula for the whole stratum; yet the latter seems to be essential for work in aerodynamics.

C. Thermodynamic Relations.—The temperature of the air is due to the quantity of molecular energy that is present in the form of heat, but usually there is also present a quantity of molecular energy that is spoken of as latent heat. This latent heat is said to do internal work, such as melting ice or boiling water, while the sensible heat does external work, such as expanding and pushing in all directions. These molecular energies can be transformed into each other over and over again without appreciable loss, and this power of transformation is expressed by the various equations of thermodynamics, of which the fundamental one for our purpose is

$$dQ = C_v dt + A p dv = C_p dt + ART dv/p \quad (3)$$

This equation expresses the fact that when a quantity of heat measured in calories, dQ , is added to or taken from a mass of dry air, there may result both a change of temperature, dt , corresponding to one portion of the heat, $C_p dt$, and a quantity of external work corresponding to the remaining portion of the heat ($A p dv$). It usually happens that the quantity of heat in a given mass of air does not remain the same for any length of time; it is diminished by radiation or is increased by absorption, and certain quantity is lost when rain, snow or hail drops down from the air, while a quantity is added to the atmosphere when moisture evaporates and mixes with the dry air as invisible vapour, even the passage of rain-drops down through a lower layer alters the thermal conditions appreciably. The changes due to increase and diminution of moisture are usually small as compared with the great gain due to absorption and convection of solar heat or with the loss by radiation. If these losses and gains are to be taken account of, then the quantity dQ in the above equation is finite and important. On the other hand, in some cases atmospheric processes go on so rapidly under such peculiar circumstances—for instance in the interior of a cloud—that the change in the quantity of heat may be considered as temporarily negligible. In these cases dQ is zero; the changes in temperature balance the changes in external work, and the thermal process is said to be adiabatic.

D. The Condition of Continuity.—When a mass of liquid or gas goes through several motions and changes without being disrupted or otherwise broken into smaller portions, and without the formation of either local condensations into solid or liquid masses or of bubbles and vacuous spaces in its interior, and when all the changes that go on proceed by gradual continuous processes as to time, then the mass of the fluid is subject to the law of continuity as to mass, and the motion of the fluid is continuous as to velocity. These conditions are assumed in elementary hydrodynamics, and are implied in the process of integration, and in the equation of continuity

$$\frac{\partial \rho}{\partial t} + \frac{\partial(\rho u)}{\partial x} + \frac{\partial(\rho v)}{\partial y} + \frac{\partial(\rho w)}{\partial z} = 0 \quad (4)$$

where ρ is the density, t is the time and ∂ the ordinary symbol for partial differentiation. But the fact is that meteorologists have to deal entirely with discontinuous external forces, such as insolation ceasing at sunset and renewed daily; radiations of heat changing abruptly with land and ocean and cloudiness and snow covering; discontinuous boundary conditions and resistances at the earth's surface altering at every change from mountains to plains; discontinuous masses changing with additions and abstractions of moisture, rain and snow—all which lead to discontinuous vortex motions and overturnings and rearrangements of the atmospheric strata. The only factors that are continuous for any length of time

or extent of area are the rotation of the earth and the attraction of gravitation. In the presence of such difficulties as these we must at present confine ourselves to the solution of very special local definite problems or to the general statistical problems of our atmosphere.

E. Conditions as to Energy and Motion.—When the total quantity of heat, both latent and sensible, remains constant or changes in a continuous manner, and when the motions are continuous, the mechanical and thermal processes are expressible by ordinary differentials and integrals. Motions of fluids involve both energy and inertia, and are subject to conditions expressed by the following equations of hydrodynamics:—

a. Equations of energy. Let the kinetic energy be T , the potential energy V , the intrinsic energy W ; l , m , n , be cosines of the angle between the pressure p , and S the inwardly directed normal to the boundary surface. Then will

$$\frac{\partial(T + V + W)}{\partial t} = \int \int (lu + mv + nw) dS. \quad (5)$$

b. Equations of acceleration and inertia. Let P be the potential of the external forces acting on a unit mass of the atmosphere; μ , be the coefficient of viscosity or internal friction. Then will

$$\left. \begin{aligned} -\frac{\partial P}{\partial x} - \frac{1}{\rho} \frac{\partial p}{\partial x} &= \frac{\partial u}{\partial t} + u \frac{\partial u}{\partial x} + v \frac{\partial u}{\partial y} + w \frac{\partial u}{\partial z} \\ &\quad - \mu \left[\frac{\partial^2 u}{\partial x^2} + \frac{\partial^2 u}{\partial y^2} + \frac{\partial^2 u}{\partial z^2} \right] \\ -\frac{\partial P}{\partial y} - \frac{1}{\rho} \frac{\partial p}{\partial y} &= \frac{\partial v}{\partial t} + u \frac{\partial v}{\partial x} + v \frac{\partial v}{\partial y} + w \frac{\partial v}{\partial z} \\ &\quad - \mu \left[\frac{\partial^2 v}{\partial x^2} + \frac{\partial^2 v}{\partial y^2} + \frac{\partial^2 v}{\partial z^2} \right] \\ -\frac{\partial P}{\partial z} - \frac{1}{\rho} \frac{\partial p}{\partial z} &= \frac{\partial w}{\partial t} + u \frac{\partial w}{\partial x} + v \frac{\partial w}{\partial y} + w \frac{\partial w}{\partial z} \\ &\quad - \mu \left[\frac{\partial^2 w}{\partial x^2} + \frac{\partial^2 w}{\partial y^2} + \frac{\partial^2 w}{\partial z^2} \right] \end{aligned} \right\} (6)$$

Approximate Assumptions and Solutions.—After introducing into the preceding system of fundamental equations (1-6) the actual conditions as accurately as they are known relative to gravity, solar radiation, the rotation of the earth, the viscosity of the air, its mass or inertia, its absorption and radiation of heat, its variable content of moisture, the precipitation of rain and cloud, the mutual inter-conversions of latent and sensible heat, a special difficulty occurs when we attempt to integrate these equations, because we have still to express analytically the initial conditions of the atmosphere as to pressure and temperature, and its boundary conditions as between the rough earth surface on its lower side and the unknown outward surface on its upper side. As the true earth's surface cannot be represented by any simple algebraic formula, it is customary to assume that it is a uniform sphere, neglecting at least partially, if not wholly, the spheroidal shape. We may first assume that there is no friction between the earth and the air, but must afterwards make allowance for its influence. Thirdly, we assume that the action of the earth's surface to heat the air and to throw moisture by evaporation into the atmosphere is perfectly uniform. Finally, in many cases we go so far as to assume that the atmosphere is an incompressible rare liquid having a uniform density and a uniform depth of about 8000 metres, corresponding to the average standard density of dry air under a pressure of 760 millimetres and a temperature of 0°C . Even under these simplifications the analytic difficulties have been too great to admit of rigorous solutions, except in a few of the simplest cases.

The treatment of atmospheric problems by Ferrel was followed by an equally ingenious mathematical treatment by Professors Guldberg and Mohn, of Christiania, in two papers published by them in 1876 and 1880 respectively. These authors, like Ferrel, treat isolated portions of the atmosphere and obtain special solutions, which, however, have not the generality that mathematically is demanded in a rigorous and general discussion of the atmosphere movements. Elegant mathematical solutions of our problems were first given in 1828 by Oberbeck, of the university of Halle, in the *Ann. Phys.* xvii. 1282. But even Oberbeck's solutions are obtained under various simplifying assumptions that restrict their satisfactory application to the daily weather conditions. Oberbeck's first memoir treats of the mechanics of stationary cyclonic movements. Assuming that the isobars are concentric circles, and that in the outer portion of a cyclone the air has only horizontal movements, while in the inner portion it has only vertical movements, he solves his system of equations for the inner and outer regions of the cyclone separately. He shows that in general the pressure increases on all sides outwards from the centre; the gradient also increases from the centre outwards to the limit of the inner region, whence it diminishes in the outer region and at a great distance becomes inappreciable. In both regions the paths of the wind are curved lines, logarithmic spirals, which cut the isobars or the radial gradient everywhere at the same angle; therefore the movement of the air can be considered as a spiral inflow from all sides towards the centre. But the angle between the wind and the gradient follows different laws in the outer and inner regions, depending in the former on the rotation of the

earth and the friction, but in the latter also on the intensity of the ascending current of air. In passing from the outer to the inner surface the wind experiences a sudden change of angle, so that the directions of the winds are not continuous, although the movement and the barometric pressures are assumed to be continuous. This latter peculiarity does not occur in nature, and is undoubtedly an analytical result peculiar to Oberbeck's method of treating the fundamental equations.

An improvement in the mathematical analysis was introduced by Dr F. Pockels of Göttingen in a memoir published in the *Met. Zeit.*, 1893, pp. 9-19. He deduces equations showing the continuous changes of temperature, pressure, gradient, wind direction, and velocity from the centre of the cyclone to the outer edge of the anti-cyclone, or, more properly, the peri-cyclone; these, therefore, may reasonably be supposed to have their counterparts in nature. Such mathematical solutions, however, are based upon the assumption that we are dealing with a comparatively small portion of the earth's surface, which may be considered as a plane having a uniform diurnal rotation and a uniform coefficient of friction. Moreover, the movements in the cyclones and anti-cyclones are assumed to be steady and permanent by reason of the perfect balance of all the forces involved therein. Of course these conditions are not exactly fulfilled, but in general Pockels shows that his theoretical results agree fairly well with the observed conditions as to wind and pressure. He computes the actual distribution of these elements under the assumption that the centre of the anti-cyclone is at latitude 55.5; and that the coefficient of friction is 0.0008, whereas viscosity proper would amount only to 0.0001. An elegant mathematical representation of these studies in cyclonic motion is given by W. Wien, *Lehrbuch der Hydrodynamik* (Leipzig, 1900).

Notwithstanding the fact that these difficult mathematical investigations still lead us to unsatisfactory results, they are yet eminently instructive as showing the methods of interaction of the various forces involved in the motions of the atmosphere. We must therefore mention the interesting attack made by Oberbeck upon the problem of the general circulation of the atmosphere. His memoir on this subject was published in the *Sitzungsberichte* of the Academy of Sciences at Berlin in 1888. The fundamental assumption in this memoir implies that there is a general and simple system of circulation between the equatorial and the polar regions, but the eventual solution of the problem leads Oberbeck to two independent systems of winds, an upper and a lower, without any well-defined connexion at the polar and equatorial ends of these two currents, so that after all they are not rigorously re-entrant. Among the hypotheses introduced in the course of his mathematical work, the most important, and perhaps the one most open to objection, is that the temperature throughout the atmosphere in both the upper and lower strata can be represented by the equation $T = A + B(1 - 3 \cos^2 \theta)$. Undoubtedly this equation represents observations in the lower strata near the surface of the earth, but the constants that enter into it, if not the form itself, must be changed for the upper strata. The solution arrived at by Oberbeck gives the following equations representing the components of the movement of the atmosphere toward the zenith V , toward the north N , and toward the east O —

$$\begin{aligned} V &= C(1 - 3 \cos^2 \theta) \sin \theta \\ N &= G \cos \theta \sin \theta \phi \\ O &= D[\sin \theta(1 - 3 \cos^2 \theta) \phi + 6 \cos^2 \theta \psi]. \end{aligned}$$

In accordance with these equations he deduces the general circulation of the atmosphere as follows: In the lower current the air flows from the polar regions eastward until it reaches the parallel of 30° or 40° ; it then turns directly towards the equator, and eventually westward, until at the equator it becomes a strong east wind (or a so-called west current). In the upper layer the movement begins as an east wind, turns rapidly to the north at latitude 20° or 30° , and then becomes a strong west wind (or north-easterly wind) in the northern hemisphere, but a north-west wind (and south-easterly current) in the southern hemisphere. Of course in the higher strata of air the currents must diminish in strength. In a second paper in the same year, 1888, Oberbeck determines the distribution of pressure over the earth's surface as far as it is consistent with his system of temperatures and winds. His general equation shows that as we depart from the equator the pressure must depend upon the square and the fourth power of the cosine of the polar distance or the sine of the latitude, and in this respect harmonizes with Ferrel's work in 1878, although more general in its bearings. By comparing his formulae with the observed mean pressure in different latitudes, Oberbeck obtains the general angular velocity of the air relative to the earth, i.e. $0.0202(\sin^2 \phi - 0.0836)$, which is quite small and is a maximum (4.6 metres per second) at latitude $S. 56^\circ 27'$. H. Hildebrandsson (1906) showed that observations do reveal an east wind prevailing above the equatorial belt of calms.

Contemporary with Oberbeck's admirable memoirs are those by Professor Diro Kitao, of the university of Tôkyô, who, as a student of the mathematical theory, has become an expert in the modern treatment of hydrodynamic problems. In three memoirs published by the Agricultural College of the university of Tôkyô in the German language in the years 1887, 1889 and 1895, he develops with great patience many of the minutiae of the movement of the earth's atmosphere and cyclonic storms. The assumptions under which

he conducts his investigations do not depart from nature quite so far as those adopted by other mathematicians. Like Ferrel, he adheres as closely as possible to the results of physical and meteorological observations; and although, like all pure mathematicians, he considers Ferrel as having departed too far from rigorous mathematical methods, yet he also unites with them in acknowledging that the results attained by Ferrel harmonize with the meteorology of nature.

The fact is that the solution of the hydrodynamic equations is not single, but multiplex. Every system of initial and boundary conditions must give a solution appropriate and peculiar to itself. The actual atmosphere presents us with the solution or solutions peculiar to the conditions that prevail on the earth. Entirely different conditions prevail on Jupiter and Saturn, Venus and Mars, and even on the earth in January and July, and therefore a wholly new series of solutions belongs to each case and to each planet of the solar system. It matters not whether we attempt to resolve our equations by introducing terrestrial conditions expressed by means of analytical algebraic formulae, and integrate the equations that result, or whether we adopt a graphic process for the representation of observed atmospheric conditions and integrate by arithmetical, geometrical or mechanical processes. In all cases we must come to the same result, namely, our resulting expressions for the distribution of pressure and wind will agree with observations just as closely as our original equations represented the actual temperatures, resistances and other attending conditions.

The last portion of Kitao's third memoir gives some attention to the interaction of two cyclonic systems upon each other when they are not too far apart in the atmosphere, and shows how the influence of one system can be expressed by the addition of a certain linear function to the equations representing the motions of the other. He even gives the basis for the further study of the extension of cyclonic storms into higher latitudes where conditions are so different from those within the tropics. Finally, he suggests in general terms how the resistances of the earth's surface, in connexion with the internal friction or viscosity of the air, are to be taken into consideration, and shows what conditions must underlie his own solutions may, and in fact must, very closely represent the actual atmosphere.

The General Circulation of the Atmosphere.—If the meteorologist had a sufficient number of observations of the motions of the air to represent both the upper and lower currents, he would long since have been able to present a satisfactory scheme showing the average movement of the atmosphere at every point of its course, and the paths of the particles of air as they flow from the poles to the equator and return, but hitherto we have been somewhat misled by being forced to rely upon the observed movements of clouds. This motion has been called the general circulation of the atmosphere; it would be a complex matter even if the surface of the earth were homogeneous and without special elevations, but the actual problem is far different. Something like this general circulation is ordinarily said to be shown by the monthly and annual charts of pressure, winds and temperature, such as were first prepared and published by Buchan in 1868, and afterwards in Bartholomew's *Physical Atlas* of 1899. We must not, however, imagine that such charts of averages can possibly give us the true path of any small unit mass of air. The real path is a complex curve, not re-entrant, never described twice over, and would not be so even if we had an ideal atmosphere and globe. It is a compound of vertical and undulatory movements in three dimensions of space, variable as to time, which cannot properly be combined into one average.

The average temperatures, winds and pressures presented on these charts suggest hypothetical problems to the student's mind quite different from the real problems in the mechanics of the atmosphere. Problems that may, in fact, be impossible of solution, whereas the real problems of the atmosphere are more or less of a momentary condition presented on any chart of simultaneous observations constitutes the real, natural and important problems of meteorology. The efforts of mathematicians and physicists have been devoted to the ideal conditions because of their apparent simplicity, whereas the practical problems offered by the daily weather chart are now so easily accessible that attention must be turned towards them. The most extensive system of homogeneous observations appropriate to the study of the dynamics of the atmosphere is that shown in the *Daily Bulletin of International Simultaneous Observations*, published by the U.S. Signal Service in the years 1875-1884, with monthly and annual summaries, and a general summary in "Bulletin A," published by the U.S. Weather Bureau in 1893. The study of these daily charts for ten years shows how the general circulation of the atmosphere differs from the simple problems presented in the idealized solutions based on monthly and annual averages. The presence of a great and a small continent, and a great and small ocean, and especially of the moisture, with its consequent cloud and rain, must enter into the study of the problem of the general circulation. The most prominent features of the observed circulation of the atmosphere are the trade winds, the north-easterly in the northern tropics and south-easterly in the southern tropics, the system of westerly winds between the trade-wind region, namely, north-westerly in the north temperate and south-westerly in the south temperate zone, and again the system

of upper winds shown by the higher clouds, namely, south-westerly in the northern hemisphere and north-westerly in the southern.

Halley in 1680, and Hadley in 1735, gave erroneous or imperfect explanations of the mechanical principles that bring about these winds. As some errors in regard to this subject are still current, it is necessary to say that it is erroneous to teach that atmospheric air weighs less on being heated, or by reason of the infusion of moisture, and that therefore the barometer falls. The addition of more moisture must increase its weight as a whole, hence being imponderable, cannot directly affect its weight either way. We are liable to disseminate error by the careless use of the word "lighter," since it means both a diminution in absolute weight and a diminution in relative weight or specific gravity. Heat and moisture may diminish the specific gravity of a given mass of air by increasing its volume, or of a given volume by diminishing its mass, but neither of them can of themselves affect the pressure shown by the barometer so far as that is due to the weight of the atmosphere. It is not proper to say that by warming the air, thereby diminishing its specific gravity and causing it to rise, so that colder air flows in to take its place, we thereby diminish the barometric pressure. It is easily seen in the expression $p = RT/v$, which, as we have before said, is the law of elasticity, T and v may so vary as to counterbalance each other, and allow the pressure p to remain the same. Within any given room or other enclosure hot air may rise on one side, flow over to the opposite, cool and return, and the circulation be kept up indefinitely without any necessary change in pressure. The problem of the relation between wind and pressure in the free atmosphere is a complicated one, and involves the consideration of the inertia of the mass of air in motion, both round the earth around its axis. The air is so extremely mobile that it moves quickly in response to slight differences in pressure that cannot be detected by ordinary barometric measurement. The gradients or differences of pressure that are shown on meteorological charts are not directly, but only very indirectly, due to buoyancy, as caused by heat and moisture. The pressure gradients, so-called, are not merely the prime causes of the winds, but are equally and essentially the results of the winds. They are primarily due to the fact that the atmosphere rapidly acquires a superimposed motion around the earth's axis, while at the same time it may be circulating about a storm centre. Inappreciable differences of pressure start the winds in motion, and the air moves towards the region of low pressure, just as in the pneumatic despatch tubes the flow of air towards the low pressure carries the packages along. But in the free air, where there are less important resistances to be overcome, the freedom of motion is greater than in these pneumatic tubes. No sooner is the atmosphere thus set in motion by pressure from all sides towards the central low pressure than it rapidly acquires a spiral or circular motion, and the superimposed motion in the northern hemisphere a decided diminution of velocity on the left hand side of the wind, and an equally rapid increase on the right hand side. The gradient of pressure in the direction of the wind overcomes resistances, but the gradient of pressure, perpendicular to the direction of the wind, is far greater than that in the direction of the wind, and is that which produces the areas of decided low pressures that appear as storm centres on the daily weather map. Therefore, in general, the wind cuts across the charted isobars in oblique directions and at angles which are nearly 90° for the feeble winds far removed from the centres, but which in the atmosphere are the most violent winds near the low centre. The winds acquire this spiral circulation for two reasons—(a) all straight line, gusts or jets in fluids, subject to any form of resistance, necessarily break up into rotating spirals whenever the velocity exceeds a certain limit, because the resistances deprive some particles of the fluid of a little more of their original velocity and energy than the other particles near by them, and thus the whole series is drawn away from linear into curvilinear paths; (b) in addition to their rectilinear motions the particles of air have a rapid circular motion in common with the atmosphere diurnally around the earth's axis. Therefore every particle of moving air comes under the influence of a set of forces depending on its own rate of motion relative to the earth's surface and its position relative thereto. If the particles are moving eastward, viz. in the same direction as the earth's diurnal rotation, then the result is as though the atmosphere were rotating more rapidly than does the earth at present; consequently the particles of wind push toward the equator as though the atmosphere were trying to adopt a more flattened spheroidal figure corresponding to its greater velocity of rotation. If the particles are moving westward, on the other hand, it is as though the atmosphere were revolving less rapidly than the earth, and as though the flattened spheroid of revolution due to the present rate of rotation were more decidedly flattened than need be; consequently the particles of air push towards the poles. If the winds blow toward either pole, then their initial moment of inertia about the earth's axis, due to the initial radius and the eastward movement of the air, must be retained; consequently, as the air advances into higher latitudes and to smaller circles of diurnal rotation its velocity must increase, and it must carry the particles to the east of their initial meridians. If the wind blows toward its initial meridian, its moment of inertia must be applied to a larger radius, and its velocity correspondingly diminished, so that it is left behind or falls away somewhat to the

west. "The reasoning of those who in attempting to explain the trade winds assume that the atmosphere in moving toward or from the equator has a tendency to retain the same original linear velocity is erroneous" (Ferrel's *Movements of Fluids*, 1859). In general the winds tend to retain their moments of inertia, and in the northern hemisphere must necessarily always be deflected continuously toward the right hand. The exact amount of this deflection was first distinctly stated by Poisson, as applied to the movements of projectiles; it was also announced by Traill and Neuberger in 1843, but was first applied to the atmosphere by Ferrel, who deduced its meteorological consequences. This law is not to be confounded with that of Buys Ballot, who in 1861 deduced from his observations in Holland the rule that the gradient of pressure between two stations for any day would be followed in twenty-four hours by a wind perpendicular to that gradient, and having the lower pressure on the left hand. Buys Ballot's law was in the nature of a rule for prediction, and was modified by Buchan 1868, who enunciated the following: "The wind blows towards the regions of low pressure, but is inclined to the gradient at an angle which is less than 90° ." In this form Buchan's law was an improvement upon the laws current among cyclonologists, who had assumed that, in a rough way, the wind blew in circles around the low centre, and was therefore sensibly at right angles to the gradient. It ought, however, to be said that Redfield throughout the whole course of his studies, from 1831 to 1857, never gave adherence to this view, and in fact for the severer portions of hurricanes determined the average inclination of the movements of the lower clouds at New York City to be about 7° inwards as compared with the truly circular theory. Nevertheless his explaining mechanically the reason why the winds do not blow either radially or circularly, and gives the means for determining their inclination to the isobars in all portions of the cyclone and for various degrees of resistance by the earth's surface. The general proposition that the barometric gradients on the weather map are not those that cause the wind, but are, properly speaking, the result of the combined action of the wind, the rotation of the earth, and the resistances at the earth's surface, as first explained by Ferrel, seems to have been neglected by meteorologists until brought to their attention repeatedly by Professor Abbe between 1869 and 1875, and especially by Professor Hann in a review of Ferrel's work in *Monat. Met.*, 1874. The independent observations of Sprung, Koepfer, Finger, and especially Guldberg and Mohn, confirm in general the correctness of Ferrel's law.

It is quite erroneous to imagine that the low pressures in storm areas and in the polar regions, and especially the belt of low pressure at the equator are due simply to the diminution of the density and weight of the air by the action of its warmth or its moisture, or to the abundant rainfall as relieving the atmosphere of the weight of water. It has been clearly shown that none of these operations can directly affect the barometric pressure to any appreciable extent, but that the high and low pressure areas we see them on the weather map owe their existence entirely to the mechanical interaction of the diurnal rotation of the earth and the motions of the atmosphere. The demonstration of this point by Ferrel in 1857 is considered to have opened the way for modern progress in theoretical meteorology.

Both Espy and Hann have abundantly shown that the formation and downfall of rain do not produce any low barometric pressure unless they produce a whirling action of the wind—that, in fact, the latent heat evolved by the condensation of vapour into rain may so warm up the cloud as to produce a temporary rise in pressure even though the high and low pressure areas are not produced by the sudden expansion of the cloud. [The details of the thermodynamics of this operation have been elucidated by Wm. von Bezold.] The force with which the wind presses to the right or tends to be deflected in that direction is $2n v \sin \phi$, while the curvature of the path of the wind is measured by its radius of curvature which is $v/2n \sin \phi$, where v is the velocity of the wind, n is the equatorial velocity of the earth's rotation, and ϕ is the latitude. It will be seen from this that there is no deflection at the equator; therefore, as Ferrel stated, there is no tendency to the formation of great whirlwinds at the equator, hence hurricanes and typhoons are rarely found within 10° of the equator.

Ferrel frequently speaks of an anti-cyclone, whereby he means the area of high pressure just outside of a strong cyclonic whirl; the expression peri-cyclone would have been more appropriate and is sometimes substituted. The term *anti-cyclone*, as first introduced by Galton in 1863, is applied to a system of winds blowing out from a central area of high pressure, and this is the common usage of the term in modern meteorology. The term cyclone among meteorologists and throughout English literature, except only a few cases in the United States, is equivalent to the older usage of whirlwind, and it is unfortunate that misunderstandings of this arising from local usages in America apply the word cyclone to what has for centuries been called a tornado. The mechanical principles discussed by Ferrel led him to an algebraic relation between the barometric gradient G , the wind velocity v , the radius of curvature of the isobar r , and the inclination i between the wind and the isobar, which is

¹ *Recherche sur le mouvement des projectiles dans l'air en ayant égard à l'influence du mouvement diurne de la terre*; dated 1837, printed Paris, 1839.

expressed by the following formula for the pressures that prevail at sea-level:—

$$G = (2\pi \sin \phi + \cos \phi) r^2 \sec \delta [1/83,000,000].$$

A popular exposition of this and other results of Ferrel's work is given by Archibald in *Nature* (May 4, 1882), and still better in Ferrel's *Treatise on the Winds* (New York, 1889, and later editions).

The charts of mean annual pressure, temperature and wind above referred to show certain broad features that embrace the whole system of atmospheric circulation, viz. the low pressures at the equator and the poles, the high pressures under the tropics, the trade winds below and the anti-trades above, with comparative calms under the belts of equatorial low pressure and tropical high pressure. The first effort of the mathematician was to explain how these mean average conditions depend upon each other, and to devise a system of general circulation of the wind consistent with the pressures, resistances and densities. But, as we have already said, such a system may be very far from that presented by the real atmosphere, and little by little we are being led to a different view of the question of the general circulation. The earlier students of storms generally accepted one of two views as to the cause of whirlwinds. They were either (1) formed mechanically between two principal currents of air flowing past each other, the so-called polar and equatorial currents; or (2) they were due to the ascent of buoyant air while the heavier air flowed in beneath, the whirling motion being communicated by the influence of the rotation of the earth, or by the greater resistances on one side than on the other. In order to explain why hurricanes and typhoons exist continuously for many days, or even weeks, it is necessary that there should be a source of energy to maintain a continued buoyancy and rising current at the centre, and this was supposed to be fully provided for by Espy's proof of the liberation of latent heat consequent on the formation of cloud and rain. At this latter consideration Abbe in 1871 added an important element of the sun's heat intercepted at the upper surface of the cloud. To this stage of the investigation the whirlwind is but an incident in the general circulation of the atmosphere, but further consideration shows that it ought rather to be regarded as an essential portion of that circulation, and that when temperature gradients and density gradients exceed a certain limit the formation of great whirlwinds is inevitable. Therefore an atmosphere containing several whirlwinds is just as truly a system of general circulation in the one case as an atmosphere without a whirlwind is in the other. The formation of rain, the evolution of latent heat, and even the absorption of heat at the upper surface of the cloud really constitute a normal general circulation in this special case. We may therefore consider a system of vortices, which is a system of discontinuous motions, as the most natural solution of the equations of motion—but the mathematical treatment of this form of motion has not yet been sufficiently well developed, for the discontinuity relates not only to the motion but to the thermal conditions and the interchange of vapour and water.

In 1890 Professor Hann published a careful analysis of the actual temperature conditions prevailing over an extensive area of high pressure in Europe, and showed that the temperatures of the upper strata in both high and low areas, namely, in anti-cyclones and cyclones are often directly contrary to those supposed to prevail by Espy and Ferrel. This study necessitated a more careful examination into the radiation of heat from the dust and moisture of the atmosphere, and Professor Abbe seems to have shown that in areas of high pressure and clear weather a very slow descending movement throughout each horizontal layer gives time for a radiation of heat that explains the anomalies of temperature, but the dynamic phenomena still remained unexplained. On the other hand, von Helmholtz in several memoirs of 1888-1891 showed that waves or billows may be formed in the atmosphere of great extent at the dividing surface between upper and lower strata moving in different directions and with different velocities. Under specific conditions these billows may become like the breakers and caps of waves of the ocean when driven by the wind. The hypothesis that these aerial breakers correspond to our troughs of low pressure and the storms experienced in the lower atmosphere seemed very plausible. As the billows are formed between upper and lower air currents of great extent, which themselves represent a large portion of the horizontal circulation between the poles and the equator, it results that if von Helmholtz's suggestion and Hann's hypothesis are correct then all general storms must be considered as essentially a part of the general circulation rather than as caused by the vertical circulation over any locality. It must occur to everyone to adopt the intermediate view that, on the one hand, the local vertical circulation, with its clouds, rain, hail and snow, and evolution of latent heat, and, on the other hand the waves and whirls in the general circulation, mutually contribute toward our storms and fair weather. It only remains to allot to each its proper importance in any special case.

Undoubtedly aerial billows, and the clouds that must frequently accompany them, exist everywhere in the earth's atmosphere. Perhaps their extent and importance are not properly appreciated. A voyage around the Atlantic Ocean in 1889-1890, made by Professor Abbe, specifically to study cloud phenomena, revealed many remarkable cases, such as the cumulus rolls that extend in a

remarkably symmetrical series from the island of Ascension westwards for 100 m. in the south-easterly trades, or the delicate fields of cirro-cumuli that extend from the islands of Santa Lucia and Barbados for 200 m. eastwards under favourable conditions. The mixtures and vorticeous motions going on within aerial billows to form these clouds have been interpreted by Brilouin. In the further elucidation of the mechanism of storms Hann showed that every study of observational material confirms the conclusion that the descent of denser cool dry air is as important as the ascent of warm moist air, and that although the evolution of latent heat within the clouds of a storm may explain the local cloud phenomena, yet it will not explain the storm as a whole. The first "norther or blizzard" that was charted at Washington in November 1871 was at once seen to be a case of the underflow of a thin layer of cold dry air descending from high altitudes above Canada on the eastern slope of the Rocky Mountains, but driven southward by an excess of centrifugal energy added to a moderate barocentric gradient. It was seen that in such grand overturnings the descent of masses implies energy communicated by the action of gravity, but the whole mechanics of this process was not clear until the publication by Margules of his memoir *Über die Energie der Stürme* (Vienna, 1905), which will be referred to hereafter.

Mathematics have, almost without exception, assumed a so-called steady condition in the motion of the atmosphere in order to achieve a successful integration of the general equations of motion. The restrictions within which Helmholtz and others have worked, and the limits within which their results are to be accepted, have been analysed by Dr E. Herrmann in a memoir of which a translation is published in the bulletin of the American Mathematical Society for June 1896. Of course Herrmann's own investigation is also based upon certain simplifying hypotheses, such as the absence of outside disturbing forces and of viscosity and friction, a homogeneous ellipsoidal surface, and a uniform initial temperature and rate of revolution corresponding to an initial state of equilibrium. If now the initial static equilibrium be disturbed by introducing a different distribution of temperature, viz. one that varies with altitude and latitude, but is uniform in longitude along any circle of latitude, then the first question is whether the atmosphere can settle down to a new state of static equilibrium. Herrmann shows that in general it cannot do so, but that the new state and the future states can only be those of motion and dynamic equilibrium. If, however, there be no external forces acting on the atmosphere, then in one case static equilibrium relative to the earth can occur, namely, when the new temperatures are so distributed in the atmosphere as to satisfy the equation

$$\int \rho^2 r^2 \omega dV = M,$$

in addition to the ordinary equations of elasticity, inertia and continuity previously given, and to those representing the boundary conditions, M being the total amount of inertia of the atmosphere relative to the axis of rotation. In general, the movements in the atmosphere must consist not only of an interchange between the poles and the equator, but also of east and west motions, and there must therefore be a different rate of diurnal rotation for each stratum.

The second step in this inquiry is, Can these movements become perfectly steady with this unvarying or steady distribution of temperature? In other words, Can the temperature and the movements be so adjusted to each other that each shall remain invariable within any given zone of latitude? The reply to this is, that if they are to become thus adjusted they must satisfy a certain differential equation, which itself shows that steady motions and stationary temperatures cannot exist if there be any north or south component. Apart from the fact that Herrmann assumes no friction, it may be seen that he has proved that steady motions and stationary pressure cannot exist in the atmosphere over a homogeneous spherical surface, and presumably the same result would follow of a rotating globe for the irregular surface of the actual globe. The motions of the real atmosphere must therefore consist of irregular and periodic oscillations and discontinuous whirls and rolls superimposed upon more uniform, regular progressions, but never repeating themselves. Consequently, the conclusions deduced by those who have assumed that steady conditions are possible must depart more or less from meteorological observations. There is a general impression that the belt of low pressure at the equator and the low areas at the poles and the high pressures under the tropics are pseudo-stationary, and really represent what would be steady conditions if we had an ideal smooth globe; but Herrmann's researches show that the unsteadiness observed to attach to these areas under existing conditions would also attach to them under ideal conditions. They really have and must have irregular motions, and we, by taking annual averages, obtain an ideal annual distribution of pressure, temperature and wind that does not represent any specific dynamic problem. The averages represent what is considered proper in climatology, but are, in a proper and misleading sense, from a dynamic point of view, and have no logical mechanical connexion with each other.

Closely connected with this study of steady motions under a constant supply and steady distribution of solar heat comes the further question as to what regular variations in atmospheric pressure and wind can be produced by regular seasonal variations

in the heat received from the sun; for instance, what variation in the earth's atmosphere corresponds to the periodic variations of the solar spots. The general current of Helmholtz's investigations shows that no periodic change in the earth's atmosphere can be maintained for any length of time by a given periodic influence outside of the atmosphere. On the other hand, it is barely possible that wave and vortex phenomena on the sun's surface may have the same character as regular disturbances in the earth's atmosphere, so that there may be a parallelism without any direct connexion between the two.

An important paper on the application of hydrodynamics to the atmosphere is that by Professor V. Bjerknes, of Stockholm, Sweden, which was read in September 1899 at Munich, and is now published in an English translation in the *U.S. Monthly Weather Review*, Oct. 1900 ("On the Dynamic Principle of Circulatory Movements in the Atmosphere"). In this memoir Bjerknes applies certain fundamental theorems in fluid motion by Helmholtz, Kelvin and Silberstein, and others of his own discovery to the atmospheric circulation. He simplifies the hydrodynamic conceptions by dealing with density directly instead of temperature and pressure, and uses charts of "isosteres," or lines of equal density, very much as was proposed by Abbe in 1889 in his *Preparatory Studies*, where he utilized lines of equal buoyancy or "isostaths," and such as Ekholm published in 1891 as "isodenses" and which were called "isopyks" by Müller-Hauensfeld. Bjerknes has thus made it practicable to apply hydrodynamic principles in a simple manner without the necessity of typically integrating the equations, at least for many ordinary cases. He also gives an important criterion by which we may judge in any given case between the physical theory, according to which cyclones are perpetually renewed, and the mechanical theory, according to which they are simply carried along in the general atmospheric current. Bjerknes's paper is illustrated by another one due to Mr Sandström, of Stockholm, who has applied these methods to a storm of September 1898 in the United States.¹ The further development of Bjerknes's methods promises a decided advance in theoretical and practical meteorology. His profound lectures at Columbia University in New York and in Washington in December 1905 aroused such an interest that the Carnegie Institution at once assigned the funds needed to enable him to complete and publish the applications to meteorology of the methods of analysis given in detail in Bjerknes's *Vorlesungen* (Leipzig, i. 1900, ii. 1902), and in his *Recherche sur les champs de force hydrodynamiques* (Stockholm), *Acta Mathematica* (Oct. 1905). In his lectures of 1905 at Columbia University Bjerknes treats the atmosphere as a continuous hydrodynamic field of aerial solenoids and forces acting on them to which vector analysis can be applied, as was done by Heaviside for electric and magnetic problems. Every material point is a small spherical mass of air free to extend or contract with pressure, temperature or moisture; free to rotate about each of three movable axes passing through its centre and to move along and revolve about three fixed axes through the centre of the earth. These numerous degrees of freedom are easily expressed in Bjerknes's notation and by his typical equations of motion. The density at any point is recognized as the fundamental "dimension" controlling inertia and movement. The observed atmospheric condition at any moment is shown by a series of *isostere* surfaces intersecting potential surfaces of equal gravity and thus forming a continuous mass of unit solenoids. This field becomes either an electric, magnetic or hydrodynamic field according to the interpretation assigned to the notations—in either case the analytical processes are identical. The analogies or homologies of these three sets of phenomena are complete throughout, and those of one field elucidate or illustrate those of the two other fields. This is the outcome of the study of such analogies begun by Euler, Helmholtz, and extensively furthered by the Maxwell and Kelvin, but especially by C. A. Bjerknes. The homologies or analogies by V. Bjerknes are given at p. 122 of his *Recherche* (1905), and include the following six triads:—

I.	Hydrodynamics	velocity of unit mass
	Magnetics	magnetic induction
II.	Electrics	electric induction
	Hydrodynamics	intensity of the field
III.	Magnetics	" " "
	Electrics	" " "
IV.	Hydrodynamics	velocity of energy
	Magnetics	intrinsic magnetic polarization
V.	Electrics	" electric "
	Hydrodynamics	velocity of expansion per unit volume
VI.	Magnetics	density of the true magnetic mass
	Electrics	" " " " " electric "
VII.	Hydrodynamics	density of the dynamic vortex "
	Magnetics	" " " " " steady magnetic current
VIII.	Electrics	" " " " " magnetic "
	Hydrodynamics	specific volume
IX.	Magnetics	magnetic permeability
	Electrics	dielectric constant

¹ "On the Construction of Isobaric Charts for High Levels in the Earth's Atmosphere and their Dynamic Significance," *Trans. Am. Phil. Soc.* (1906).

which have been slightly rectified by Dr G. H. Ling, *Am. Jour. Math.* (1908). In the application of Bjerknes's methods of study to the daily weather map Sandström draws special maps to represent the solenoids and the forces. Barometric pressures are reduced from the observing stations not only down to sea-level but up to other level surfaces of gravity. The differences between these level surfaces represent the work done in raising a unit mass from one level to the next, and the earth's atmosphere is treated as a *Treatise on Dynamic Meteorology and Hydrography*, Washington, 1908).

The Diurnal and Semi-diurnal Periodicities in Barometric Pressure.—For a long time attempts were made to explain the periodic variations of the barometer by a consideration of static conditions, but it is now evident that this problem, like that of the circulation of the atmosphere, is a question of aerodynamics. A most extensive series of researches into the character of the phenomena from an observational point of view has been made by Hann, who gave a summary of our knowledge of the subject in the *Met. Zeit.* for 1898, translated by R. H. Scott in the *Quart. Jour. Roy. Met. Soc.* (Jan. 1899) (see also an important addition by Hann and Trabert in the *Met. Zeit.*, Nov. 1899), and the summary of his results as given in his *Lehrbuch*, 1896). Hann has shown that at the earth's surface three regular periodic variations are established by observation, viz. the diurnal, semi-diurnal and ter-diurnal. On the higher mountains these variations change their character with altitude. (1) At the equator the diurnal variation is represented by the formula $0.30 \sin \pi$ (sin $5^{\circ} + \pi$), where π is the local hour angle of the sun. In higher latitudes either north or south the coefficient A_1 of $0.30 \sin \pi$ diminishes with altitude and the phase angle varies generally growing larger. It is therefore evident that this diurnal oscillation depends directly on the hour angle of the sun, and probably, therefore, principally on the amount of heat and vapour received by the atmosphere from the ocean and the ground at any locality and season of the year. It is apparently but little affected by the wind, but somewhat by altitude above sea; the amplitude diminishes to zero at a certain elevation, and then reappears and increases with the opposite sign; the phase angle does not change. (2) Superimposed upon this diurnal oscillation is a larger semi-diurnal one, which goes through its maximum and minimum phases twice in the course of a civil day. The amplitude of this variation is largest in equatorial regions, and is expressed by the formula $A_2 = (0.988 \sin \pi - 0.473 \sin \frac{1}{2} \pi) \cos \frac{1}{2} \pi$ as given by Hann, or $A_2 = (0.92 \sin \pi - 0.535 \sin \frac{1}{2} \pi) \cos \frac{1}{2} \pi$ as revised by Trabert. This amplitude also may be considered as variable along each zone of latitude having a maximum value on certain central local meridians. The times at which the semi-diurnal phases of maximum and minimum occur are subject to laws different from those for the diurnal period. Within the tropics the phase angle is 47° at the equator, and is 47° and hence it seems to be the same over the whole globe, so that the phase does not depend clearly upon the hour angle of the sun or on the local time. The amplitudes appear to depend on the excess of land in the northern hemisphere as compared with the water and cloud of the southern hemisphere. The amplitude also varies during the year, being greatest at perihelion and least at aphelion. Hann suggests that this is an indirect effect of the sun's heat on the earth, as the northern hemisphere is hotter when the earth is in aphelion than is the southern hemisphere when the earth is in perihelion, owing to the preponderance of land in the north and water in the south. (3) The ter-diurnal oscillation has the approximate value shown by the formula $0.04 \sin \pi$ (sin $355^{\circ} + 3\pi$). The phase angle is sensibly the same everywhere, and the amplitude varies slightly with the latitude. Both phase and amplitude have a pronounced annual period which is as remarkable as that of the semi-diurnal oscillation; the maximum amplitude occurs in January in the northern hemisphere, and in July in the southern.

The physics of the atmosphere has not yet been explored so exhaustively as to explain fully the character of the atmospheric variations, but neither have we as yet any necessity for appealing to some unknown cosmic action as a possible cause of their existence. The action of the solar heat upon the illuminated hemisphere, and the many consequences that result therefrom, may be expected to explain the barometric periods. The variations of sunshine and cloud must inevitably produce periodic variations of temperature, moisture, pressure and motion, whose exact laws we have not as yet fathomed. Among the many methods of action that have been studied or suggested in connexion with the barometry variations the most important of all the so-called tidal waves of pressure due to temperature. Laplace applied his investigations on the tides to the gravitational tide of the ocean, and when he passed to the corresponding solar and lunar gravitational tides of the atmosphere he was able to show that they must be inappreciable, unless, indeed, certain remarkable relations existed between the circumference of the earth and the depth of the atmosphere. As these relations do not exist, it is generally conceded as certain that the gravitational tides, both diurnal and semi-diurnal, cannot exceed a few thousandths of an inch of barometric pressure. On the other hand, the enormous mass of matter in the solar system enables us to investigate the action of the sun's heat in producing a wave of pressure that has been called a presurral tide, due to the expansion of the lower layer of air on the illuminated half of the globe. The laws that must govern these presurral tides have been investigated by Kelvin, Rayleigh (*Phil.*

Mag., Feb. 1890), and especially by Margules (*Vienna Sitz. Ber.* 1890-1893). The two latter have shown the truth of a proposition enunciated by Kelvin in 1882, without demonstration, to the effect that the free oscillation produced by a relatively small amount of tide-producing force will have an amplitude that is larger for the half-day term than for the whole-day term. They therefore explain the diurnal and semi-diurnal variations of the barometric pressure as simple pressure tides or waves of expansion, originally produced by solar heat, but magnified by the resonance between forced and free waves in an atmosphere and on a globe having the specific dimensions of our own. The analytical processes by which Laplace and Kelvin arrived at this special solution of the tidal equation were objected to by Airy and Ferrel, but the matter has been, as we think, most fully cleared up by Dr G. H. Ling, in a memoir published in the *Annals of Mathematics* in 1896. He seems to have shown that, although a literally correct result was attained by Laplace in his first investigation, yet his methods as presented in the *Mécanique céleste* were in fault from a rigorous analytical point of view. The process by which a diurnal temperature wave produces a semi-diurnal pressure oscillation, as explained by Rayleigh and Margules, may be stated as follows: The diurnal temperature wave having a twenty-four hour period, generates first a diurnal pressure wave, which is essentially a forced and small oscillation. The natural period of the free waves in the atmosphere agrees much more nearly with twelve than with twenty-four hours. In so far as the forced and the free waves reinforce each other, the semi-diurnal waves are reinforced far more than the other, so that a very small semi-diurnal term in the temperature oscillations will produce a pressure oscillation two or three times as large as the same term would in the diurnal period. These reinforcements, however, depend upon the elastic pressure within the atmosphere, just as does the velocity of sound. If the prevailing barometric pressures were slightly increased, the adjustment of the two waves of pressure of pressure and temperature wave of temperature could be so perfect that the barometric wave would increase to an indefinite extent. For the actual temperatures the periodicity of the free wave is about thirteen hours, or somewhat longer than the forced wave of temperature, so that the barometric oscillation does not become excessive. It would seem that we have here a suggestion to the effect that if in past geological ages the average temperature at any time has been about 268° C. on the absolute scale, then the pressure waves could have been so large as to produce remarkable and perhaps disastrous consequences, involving the loss of a portion of the atmosphere. A modification of this idea of adjustment has been proposed by Dr Jaerisch, of Hamburg (*Met. Zeit.*, 1907), but the general truth of the Kelvin-Margules-Rayleigh theorem still abides.

The Thermodynamics of a Moist Atmosphere.—The preceding section deals with an incompressible gas, and therefore with simple, pure hydrodynamics. If now we introduce the conception of an atmosphere of compressible gas, whose density increases with altitude, so that rising and falling currents change their temperatures by reason of the expansion and compression of the masses of air, we take the first step in the combination of thermodynamic and hydrodynamic conditions. If we next introduce moisture, and take precipitation into consideration, we pass to the difficult problem of clouds, which correspond more nearly to those which actually occur in meteorology. This combination has been elucidated by the works of Espy and Ferrel in America, Kelvin in England, Hann and Margules in Austria, but especially by Hertz, Helmholtz, and von Bezold in Germany, and by Brillouin in France. A general review of the subject will be found in Professor Bigelow's report on the cloud work of the U.S. Weather Bureau and his subsequent memoirs "On the Thermodynamics of the Atmosphere" (*Monthly Weather Review*, 1906-1909).

The proper treatment of this subject began with the memoir of Kelvin on convective equilibrium (see *Trans. Manchester Phil. Soc.*, 1861). The most convenient method of dealing approximately with the problems is graphic and numerical rather than analytical, and in this field the pioneer work was done by Hertz, who published his diagram for adiabatic changes in the atmosphere in the *Met. Zeit.* in 1884. He considers the adiabatic changes of a kilogram of mixed air and aqueous vapour, the proportional weights of each being λ and μ respectively. In a subsequent elaborate treatment of the same subject by von Bezold in four memoirs published during 1889 and 1899, the formulae and methods are arranged so as to deal easily with the ordinary cases of nature which are not adiabatic; he therefore prepares diagrams and tables to illustrate the changes going on in a unit mass of dry air to which has been added a small quantity of aqueous vapour, which, of course, may vary to any extent. Both Hertz and von Bezold consider separately four stages or conditions of atmosphere: (A) The dry stage, where aqueous vapour to a limited extent only is mixed with the dry air. (B) The rain stage, where both saturated vapour and liquid particles are simultaneously present. (C) The hail stage, where saturated aqueous vapour, and water, and ice are all three present. (D) The snow stage, where ice vapour and snow itself, or crystals of ice, are present. The expressions aqueous vapour and ice vapour do not occur in Hertz's article, but are now necessary, since Marvin, Fischer and Juhlin have been able to show that vapour from water and vapour from ice exert different elastic pressures, and must therefore represent different modifications of

liquid water. According to Hertz, we may easily follow this mass of moist air as it rises in the atmosphere, if by expansion it cools adiabatically so as to go successively through the four preceding stages. For a few thousand feet it remains dry air. It then becomes cloudy and enters the second stage. Next it rises higher until the cloudy particles begin to freeze into snow, sleet or hail, which characterizes the third stage. When the water has frozen and the cloud has ascended higher, it contains only ice particles and the vapour of ice, a condition which characterizes the fourth or snow stage. If in this condition we give it plenty of time the precipitated ice or snow may settle down, and the cloudy air, becoming clear, return to the first stage; but the ordinary process in nature is a circulation by which both the cloud and the air descend together slowly, warming up as they descend, so that eventually the mixture returns to the first stage at some level lower than the clouds, though higher than the starting-point.

The exact study of the ordinary non-adiabatic process can be carried out by the help of Professor Bigelow's tables, and especially by the very ingenious tables published by Neuhoff (Berlin, 1900), but the approximate adiabatic study is so helpful that in fig. 10 we have traced a few lines from Hertz's diagram sufficient to illustrate its use and convenience. The reader will perceive a horizontal line at the base representing sea-level; near the middle of this line is zero centigrade; as we ascend above this base into the upper regions of the air we come under lower pressures, which are shown by the figures on the left-hand side.

The scale of pressures is logarithmic, and the corresponding altitude would be on equal parts. The temperature and pressure at any height in the atmosphere are shown by this diagram. If the air be saturated at a given temperature, then the unit volume can contain only a definite number of grams of water, and this condition is represented by a set of moisture lines, indicated by the dashed lines showing the temperature and pressure under which 5, 10 or 20 grams of water may be contained in the saturated air. Let us now suppose that we are following the behaviour of a kilogram mass of air rising from near sea-level, where it has a pressure of 750 millimetres, a temperature of 27° C., and a relative humidity of 50%. A pointer pressing down upon the diagram at 750 millimetres and 27° C. will represent this initial condition. A line drawn through that point parallel to the moisture lines will show that if this air were saturated it would contain about 22 grams of water; but inasmuch as the relative humidity is only 50%, therefore it actually contains only 11 grams of water, and an additional moisture line may be drawn for this amount. If now the mass rises and cools by expansion, the relation between pressure and temperature will be shown by the line α . When this line intersects the inclined moisture line for 11 grams of water we know that the rising mass has cooled to saturation, and this occurs when the pressure is about 640 millimetres and the temperature 13.2° C. By further rise and expansion a steady condensation continues, but by reason of the latent heat evolved the rate of cooling is diminished and follows the line β . The condensed vapour or cloud particles are here supposed to be carried up with the cooling air, and at the temperature of freezing or zero degrees centigrade is soon attached—as the diagram shows—when the pressure is about 472 millimetres. At this point the special evolution of latent heat of freezing comes into play; and although the air rises higher and more moisture is condensed, the temperature does not fall because the water already converted into vapour and now becoming ice is giving out latent heat sufficient to counteract the cooling due to expansion. This illustration from Hertz's diagram therefore shows that the curve for cooling temperature coincides with the vertical line γ for freezing, and is represented on the diagram by the short piece $\beta\gamma$.

By this expansion due to ascent the volume is increased while the temperature is not changed; therefore, the quantity of aqueous vapour has increased. When the ascending mass has reached the level where the pressure is 463 millimetres it has also reached the moisture line that represents this increase in aqueous vapour. As this shows that the aqueous particles have now all been frozen, and as the air is now continuously rising, while its temperature is always below freezing-point, therefore at levels above this point the vapour that condenses from the air is supposed to pass directly over into the condition of solid ice. Therefore from this point onwards the falling temperatures follow along the line $\gamma\delta$, and continue along it indefinitely. From these considerations it follows that the clouds above the altitude of freezing temperatures are essentially snow crystals, and if the air rises slowly there may be time for the water and ice to settle down towards the ground; in this case the quantity

After Hertz.
FIG. 10.—Diagram for Graphic Method of following Adiabatic Changes.

temperature, a mixture accompanied by condensation always descends when the surface of separation is unstable; moreover, the adiabatic compression rapidly evaporates the mixture.

In the last three chapters of his memoir, Brillouin applies these principles and other details to almost every observed variety of mixtures due to the pressure of one current of air against another. Fig. 11, prepared for the U.S. Monthly Weather Review (Oct.

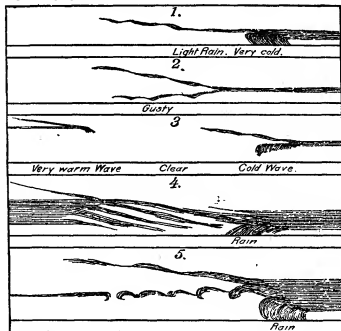

After Brillouin.

FIG. 11.—Diagram illustrating Clouds due to Mixture.

1897), gives five of the cases elucidated by Brillouin. In each of these the left-hand side of the diagram is the polar side, the air being cold above and the wind from the east, while the right-hand side is the equatorial side, the air being warm above and the wind from the west. The reader will see that in each case, depending on the relative temperatures and winds, layers of cloud are formed of marked individuality. As none of these clouds appear in the *International Cloud Atlas* or the various systems of notation for clouds, one is all the more impressed with the importance of their study and the success with which Brillouin has opened up the way for future investigators. "We have no longer to do with personal and local experience, but with an analytical description of a small number of characteristics easy to comprehend and applicable at every locality throughout the globe."

From a thermodynamic point of view the most important study is that published by Margules, *Ueber die Energie der Stürme* (Vienna, 1905). This work considers only the total energy and its adiabatic transformations within a mass of air constituting a closed system. Truly adiabatic changes in closed systems do not occur within any special portion of the earth's atmosphere, neither can our entire atmosphere be considered as one such system—but Margules' results are approximately applicable to many observed cases and complete the demonstration of the general truth that we must not confine our studies to the simpler cases treated by Espy, Rey, Sohneke, Peslin, Ferrel, Mohn. All imaginable combinations of conditions exist in our atmosphere, and a method must be found to treat the whole subject comprehensively and rigorously.

The three equations of energy on which Margules bases his work are:—

$$\begin{aligned} R + \delta(K + P) + \delta A &= 0 \\ \delta I - \delta A &= Q \\ R + \delta(K + P) + \delta I &= Q \end{aligned}$$

where R=energy lost by friction or converted into heat; K=kinetic energy due to velocity of moving masses; P=potential energy due to location and gravity and pressure heat; A=work done by internal forces when air is expanding or contracting; I=internal energy due to the existing pressure and temperature; Q=quantity of heat or thermal energy added or lost during any operation and which is zero during adiabatic processes only.

These equations are applied to cases in which masses of air of different temperatures and moistures are superposed and then left free to assume stable equilibrium. It results in every case that there is no free energy developed. Any condensation of moisture by expansion

is counterbalanced by redistribution of potential energy and by the work done in the interchange of locations. The idea that barometric pressure gradients make the storm-winds is seen to be erroneous and the primary importance of gravity gradients is brought to light. "The source of a storm is to be sought only in the potential energy of position and in the velocity of ascent and descent, although these are generally lost sight of owing to the great horizontal and small vertical dimensions of the storm areas. The horizontal distribution of pressure seems to be a forced transformation within the storm areas at the boundary surface of the earth, by reason of which a small part of the mass of air acquires a greater velocity than it could by ascending in the coldest or sinking in the warmest part of the storm areas. But here we come to problems that cannot be solved by considering the energy only."

This latter quotation emphasizes the necessity of returning to the equations of motion. The thermodynamics and hydrodynamics of the atmosphere must be studied in intimate connexion—they can no longer be studied separately. Apparently we may expect this next step to be taken in the above-mentioned work promised by V. Bjerknes, but meanwhile Professor F. H. Bigelow has successfully attacked some features of the problem in his "Studies on the Thermodynamics of the Atmosphere" (Monthly Weather Review, Jan.-Dec. 1906). In ch. iii. of his studies (*Monthly Weather Review*, March 1906) Bigelow establishes a thermodynamic formula applicable to non-adiabatic processes by introducing a factor n so that the pressure (P) and absolute temperature (T) are connected by the formula

$$\frac{P}{T} = \left(\frac{1}{T_0}\right)^{n(\alpha-1)}$$

In our fig. 1 above given, Cortier has assumed $n=1.2$, but as the values we have now been computed for all altitudes from the observations given by balloons and kites, and have a very general importance and interest, we copy them from Bigelow's Table 16 as below:—

The existence of such large values of n shows the great extent to which non-adiabatic processes enter into atmospheric physics. Heat is being radiated, absorbed, transferred and transformed on all occasions and at all altitudes. Knowing thus the thermodynamic structure of areas of high and low pressure we find the modifications needed in the energy formula for non-adiabatic processes—and Bigelow applies the resulting formula most satisfactorily to a famous waterspout of the 19th of August 1896 over Nantucket Sound, for which many photographs and measurements are available. The thermodynamic study of this waterspout being thus accomplished, it was followed by a combined thermodynamic study of all

Altitudes.	Values of n between successive levels.						All.
	America.		Europe.		Both A. and E.		
	Winter.	Summer.	Winter.	Summer.	Winter.	Summer.	
kil.							
16-14	3.04	2.82	3.04	3.59	3.04	3.20	3.12
14-12	4.39	2.82	4.39	3.04	4.39	2.93	3.66
12-10	2.08	1.72	2.08	1.64	2.08	1.68	1.88
10-9	1.52	1.47	1.52	1.41	1.52	1.44	1.48
9-8	1.39	1.41	1.41	1.32	1.40	1.36	1.38
8-7	1.41	1.52	1.41	1.41	1.41	1.46	1.44
7-6	1.45	1.67	1.41	1.52	1.43	1.66	1.52
6-5	1.52	1.52	1.41	1.62	1.46	1.57	1.52
5-4	1.79	1.41	1.67	1.70	1.73	1.56	1.64
4-3	1.97	1.32	1.79	1.94	1.88	1.63	1.76
3-2	2.10	1.65	2.01	2.30	2.06	1.98	2.02
2-1	3.52	1.83	2.24	1.67	2.88	1.75	2.32
1-0	2.30	1.83	2.47	1.64	2.38	1.74	2.06

storms (*Monthly Weather Review*, November 1907-March 1909) with considerable success.

We have thus passed in review the steady progress of mathematical physicists in their efforts to unravel the complex dynamics of our atmosphere. The profound importance of this subject to governmental weather bureaus, and through them to the whole civilized world, stimulates diligent effort to overcome the inherent difficulties of the problems. An elaborate system of study and laboratory experimentation leading up to research in meteorology has been devised by Cleveand Abbe, culminating in experiments on models of the atmosphere as a whole by which to elucidate both the local and the general circulations on globes whose orography and distribution of land and water is as irregular as that of the earth.

The Formation of Rain.—Not only has dynamic meteorology made the progress delineated in the previous sections, but one of the most important questions in molecular physics is in process of being cleared up. The study of atmospheric nuclei and condensation and the formation of clouds in their relation to daily meteorological work began with the appointment of Dr Carl Barus in 1891 as physicist to the U.S. Weather Bureau, and his work has been laboriously continued and extended in his laboratory at Providence, Rhode Island. The formation of rain, from a physical point of view,

is the ultimate step in the formation of cloud. The cloud consists, like fog, of extremely small particles, so light that they float indefinitely in the air; rain and snow represent those particles that have grown to be too large and heavy to be any longer sustained by the air—that is to say, their rate of fall through the air is greater than the ascending component of the upward air current. The particles, by whatever means formed out of the lighter particles, that constitute a cloud has not yet been satisfactorily explained. It is probable that either one of several processes contributes to bring about this result, and that in some cases all of these conspire together. The following paragraphs represent the hypotheses that have marked the gradual progress of our knowledge:—

A. Cloud particles may be driven together by the motions imparted to them by the wind, and may thus mechanically unite into larger ones, which, as they grow, may more rapidly, overtake the smaller ones, and grow into rain-drops.

B. The particles on the upper boundary of a cloud may at night-time, or in the shade, cool more decidedly than their neighbours below them, either by radiation or by mixture; then the air in their immediate vicinity becomes correspondingly cold, the particles and their envelopes of cold air sink more rapidly, overtaking, and therefore uniting, with other particles until the large rain-drops are formed.

C. Some cloud particles may be supposed to be electrified positively and other negatively, causing them to attract each other, and run together into larger ones, or, again, some may be neutral and others charged, which may also bring about attraction and union.

D. When any violent agitation of the air, such as the sound waves due to thunder, or cannonading, or other explosions, sets the particles in motion, they may be driven together until brought into contact, and united into larger drops.

E. The air—or, properly speaking, the vapour—between cloudy particles—that is to say, within fog cloud, is generally in a state of supersaturation; but if it is steadily rising to higher altitudes, thereby expanding and cooling, the supersaturation must increase steadily until it reaches a degree at which the molecular strain gives way, and a sudden violent condensation takes place, in which process both the vapour and the cloud particles within a comparatively large sphere are instantaneously gathered into a large drop. The electricity that may be developed in this process may give rise to the lightning flash, instead of the reverse process described in the preceding paragraphs (C and D).

F. However plausible the preceding five hypotheses have seemed to be, it must be confessed that no one has ever yet observed precipitation actually formed by these processes. The laborious observations of C. T. R. Wilson of Cambridge, England, probably give us our first correct idea as to the molecular processes involved in the formation of rain. After having followed up the methods inaugurated by Aitken in showing the particles of dust floating in the air, no matter of what nature they may be composed, become by preference the nuclei upon which the moisture begins to condense when air is cooled by expansion, Wilson then showed that in absolutely dustless air, having therefore no nuclei to facilitate condensation, the latter could only occur when the air is cooled to a much greater extent than in the case of the presence of dust; in fact, dustless air requires to be expanded more than dusty air in the ratio of 4 to 3, or 1½ times more. The amount of this larger expansion may vary somewhat with the temperature, the moisture and the gases. More remarkable still, he showed that dustless air, having no visible or probable nuclei, acquired such nuclei when a beam of ultra-violet light, or of the röntgen rays, or the uranium radiation, or of ordinary sunlight (which possibly contains all of these radiations), was allowed to pass through the moist air in his experimental tube. In other words, these rays produce a change in the mixed gas and vapour similar to the formation of nuclei, and condensation of aqueous vapour takes place upon the visible nuclei as readily as upon the invisible dust nuclei. Further, the presence of certain metals within the experimental tube also produces nuclei; but the amount of expansion, and therefore of cooling, required to produce condensation upon these metallic nuclei is rather larger than in the case of dust nuclei. The nuclei thrown into the experimental tube by the discharge of electricity from a pointed metal wire produced very dense fogs by means of expansions slightly exceeding those required for ordinary dust. Finally, Wilson has shown that when a quantity of dust particles are electrified negatively their tendency to condense vapour upon themselves as nuclei is much greater than when they are electrified positively, and he suggests that the descent of the rain-drops to the ground, carrying negative electricity from the atmosphere to the earth, may perhaps explain the negative charge of the earth and the positive electricity of the atmosphere.

At this point we come into contact with the views developed by J. J. Thomson as to the nature of electricity and the presence of negative and positive nuclei in the atmosphere. According to him "The molecules made up of what chemists call atoms must be still further subdivided, and the atoms must be conceived as made up of corpuscles; the mass of a corpuscle is the same as the mass of the negative ion in a gas at low pressure. In the normal atom this assemblage of corpuscles forms a system which is electrical and neutral. Though the individual corpuscles behave like negative ions yet when they are assembled in a neutral atom the negative effect is balanced by something which causes the space through which

the corpuscles are freed to act as if it had a charge of positive electricity equal in amount to the sum of the negative charges on the corpuscles. I regard electrification of a gas as due to the splitting up of some of the atoms of the gas, resulting in the detachment of a corpuscle from such atoms. The detached corpuscles behave like negative ions, each carrying a constant negative charge which we shall call the unit charge, while the part of the atom left behind behaves like a positive ion with the units positively charged but with a mass that is large compared with that of the negative ion. In a case of the ionization of the gas by röntgen or uranium rays, the evidence seems to be in favour of the view that not more than one corpuscle can be detached from any one atom. Now the ions by virtue of their negative charges act as nuclei around which drops of water condense when moist dust-free gas is suddenly expanded." C. T. R. Wilson has shown that this requires a considerably greater expansion to produce a cloud in dust-free air on positive ions than on negative ones, when the ions are produced by röntgen rays." It would therefore appear that the moist atmosphere above us may, through the action of sunlight or the lightning flash as well as by other means, become ionized. The negative ions attract moisture to themselves more readily than the positive; they grow to be larger drops, and descending to the earth with their negative charges give it negative electricity, while the atmosphere is left essentially either positive or neutral. (See also ATMOSPHERIC ELECTRICITY.)

IV.—COSMICAL METEOROLOGY

Under this title have been included all possible, plausible or imaginary relations between the earth's atmosphere and interplanetary space or the heavenly bodies. The diffusion to and fro at the outer limit of the atmosphere, the bombardment by ions from the sun, the explanation of auroral lights and of magnetic storms, the influence of shooting stars and comet tails, the relation of the zodiacal light and the Gegenschein to the atmosphere, the parallelisms between terrestrial phenomena and the variations of the solar spots and protuberances, the origin of long or short climatic periods, the cause of special widespread cold days, the existence of lunar or solar gravitation tides analogous to oceanic tides, the influence of slow changes in the earth's orbit or the earth's axis of rotation—all are grouped under cosmical meteorology.

But, in the writer's judgment these matters, while curious and interesting, have no appreciable bearing on the current important questions of atmospheric mechanics. There seem to be many widespread delusions and mistakes in regard to these problems, analogous to the popular errors in regard to astrology, and it is hardly necessary to do more than allude to them here. The leading meteorologists have relegated such questions to the care of theoretical astronomers and physicists until our knowledge is more firmly established. Undoubtedly the earth does come under other influences than that of the radiation from the sun; but in the present stage of dynamic meteorology we consider only this latter, and, assuming it to be constant as regards quantity and quality, we find the variable selective absorptions and reflections within our own atmosphere, and its complex internal mechanism afford us a bewildering maze of problems such that so long as these are unsolved it would be folly to spend time on those.

V.—METEOROLOGICAL ORGANIZATIONS

During the latter half of the 19th century the prosecution of work in meteorology gradually passed out of the hands of individuals into the control of large national organizations. This was the natural result of the discovery that, by the spread of the electric telegraph and ocean cables, it had become possible to compile daily weather-maps for large portions of the globe and make predictions of the weather and the storms for a day, or two in advance, of sufficient accuracy to be of the greatest importance to the material interests of civilized nations. The development of wireless telegraphy since 1900 has even made it possible for isolated ships at sea to exchange weather telegrams, compile daily maps and study surrounding storms. One by one every civilized nation has established either a weather bureau or a meteorological office, or a bureau of hydrography and marine meteorology, or an elaborate establishment for aerial explorations according as its special interests demanded. These governmental bureaux usually pursue both climatology and theoretical meteorology in addition to their daily practical

work of telegraphy, forecasting, and publication of charts. Although, of course, in most cases, the so-called practical work absorbs the greater part of the labour and the funds, yet everywhere it is recognized that research and the development of a correct theory of the motions of the atmosphere are essential to any important progress in the art of forecasting. Among other important general works in which the official weather bureaus have united, we may enumerate the International Meteorological Congresses, of which the first was held in 1853 at Brussels, the second in 1873 at Vienna, and others more frequently since that date; the establishment of an International Committee, to which questions of general interest are referred; the organization of a systematic exploration of the polar regions in the years 1882 and 1883; the general extension of the meteorological services to include terrestrial magnetism as an essential part of the physics of the globe; the systematic exploration of the upper atmosphere by means of kites and balloons; and the universal co-operation with the U.S. Weather Bureau in the contribution of simultaneous data for its international bulletin and its daily map of the whole northern hemisphere. The hydrographic offices and marine bureaus of the principal commercial nations have united so far as practicable in the daily charting of the weather, but have especially developed the study of the climatology of the ocean, not only along the lines laid down by Maury and the Brussels Conference of 1853, but also with particular reference to the tracks of storm centres and the laws of storms on the ocean. The condition of these governmental organizations was discussed in the annual address of the Hon. F. Campbell Bayard, delivered before the Royal Meteorological Society of London in January 1899, and in the text accompanying Bartholomew's *Physical Atlas*, vol. iii.

The development of meteorology, in both its scientific and its practical aspects, is intimately dependent upon the progress of our knowledge of physics, and its study offers innumerable problems that can be solved only by proper combinations of mathematical theory and laboratory experimentation. The professors in colleges and universities who have hitherto lectured on this subject have not failed to develop some features of dynamic meteorology, although most of their attention has been given to climatology. In fact, many of them have been engrossed in the study of general problems in molecular physics, and could give meteorology only a small part of their attention. The early textbooks on meteorology were frequently mere chapters or sections of general treatises on physics or chemistry. The few prominent early cases of university professorships devoted to meteorology are those of the eminent Professor Heinrich Wilhelm Dove at Berlin, Professor Adolphe Quételet at Brussels and Professor Ludwig Friedrich Kaemtz at Halle and Dorpat. In modern times we may point to Professor Wilhelm von Bezold and George Hellmann at Berlin, Professor Julius Hann at Vienna and Gratz, Professor Josef Maria Pernter at Linz and Vienna, Professor Alexander Woeikof at St Petersburg, Professors Hugo Hildebrand-Hildebrandsson at Upsala, Henrik Mohn at Christiania, Elias Loomis at New Haven, Connecticut, W. M. Davis and R. de C. Ward at Cambridge, Massachusetts, Alfred Angot and Marcel Brillouin at Paris, Hugo Hergesell at Strassburg, Arthur Schuster at Manchester, Peter Polis at Bonn, and Richard Börnstein at the School of Agriculture in Berlin. With these exceptions the great universities of the world have as yet given but little special encouragement to meteorology; it has even been stated that there is no great demand for higher education on the subject. On the other hand, the existence of thousands of voluntary observers, the profound interest in the weather actually taken by every individual, and the numerous schemes for utilizing our very limited knowledge of the subject through the activities of the large weather bureaus of the world demonstrate that there is a demand for knowledge perhaps even higher than the universities can offer. It would be very creditable to a nation or to a wealthy patron of science if there should be established meteorological laboratories in connexion with important universities, at which not only instruction but especially investigation might be pursued, as is

done at the magnificent astronomical observatories that are so numerous throughout the world. Every atmospheric phenomenon can be materially elucidated by exact laboratory experiments and measurements. Theory can be confronted with facts; and the student can become an original investigator in meteorology.

The great difficulties inherent to meteorology should stimulate the devotion of the highest talent to the progress of this branch of science. The practical value of weather predictions justifies the expenditure of money and labour in order to improve them in every detail.

BIBLIOGRAPHY.—Those who desire recent additions to our knowledge should consult first Hann's *Lehrbuch der Meteorologie* (2nd ed., Leipzig, 1906) as being a systematic encyclopaedia. Of equal importance is the *Meteorologische Zeitschrift* (Berlin and Vienna, 1866 to date). The *Atlas of Meteorology* (Bartholomew, 1900), the *Quarterly Journal of the Royal Meteorological Society* (London) and the *Monthly Weather Review* (Washington) are the works most convenient to English readers and abound with references to current literature. The *Physical Review Science Abstracts* and the *Fortschritte der Physik* contain short notices of all important memoirs and will serve to direct the student's attention toward any special topic that may interest him. (C. A.)

METER, ELECTRIC. In the public supply of electric energy for lighting and power it is necessary to provide for the measurement of the electric energy or quantity by devices which are called electric meters. Those in use may be classified in several ways: (i) according to the kind of electric supply they are fitted to measure, e.g. whether continuous current or alternating current, and if the latter, whether monophase or polyphase; (ii) according to whether they record intermittently or continuously; (iii) according to the principle of their action, whether mechanical or electrolytic; (iv) according to the nature of the measurement, whether quantity or energy meters. The last subdivision is fundamental. Meters intended to measure electric energy (which is really the subject of the sale and purchase) are called *joule meters*, or generally *wait-hour meters*. Meters intended to measure electric quantity are called *coulomb meters* and also *ampere-hour meters*; they are employed for the measurement of public electric supply on the assumption that the electromotive force or pressure is constant. Most of the practical meters in use at the present time may be classified under the following five heads: electrolytic meters, motor meters, clock meters, intermittent registering meters and induction meters.

Electrolytic Meters are exclusively ampere-hour meters, measuring electric quantity directly and electric energy only indirectly, on the assumption that the pressure of the supply is constant. The first electrolytic house meter in connexion with public electric supply was described by St. George Lane-Fox. He was followed by F. J. Sprague and T. A. Edison, the last-named inventor elaborating a type of meter which he employed in connexion with his system of electric lighting in its early days. The Edison electric meter, like those of Sprague and Lane-Fox, was based upon the principle that when an electric current flows through an electrolyte, such as sulphate of copper or sulphate of zinc, the electrodes being plates of copper or zinc, metal is dissolved off one plate (the anode) and deposited on the other plate (the cathode). It consisted of a glass vessel, containing a solution of sulphate of zinc, in which were placed two plates of pure amalgamated zinc. These plates were connected by means of a german-silver shunt, their size and the distance between them being so adjusted that about $\frac{1}{1000}$ part of the current passing through the meter travelled through the electrolytic cell and $\frac{999}{1000}$ of the current passed through the shunt. Before being placed in the cells the zinc plates were weighed. The shunted volt-meter was then inserted in series with the electric supply, means leading to the house or building taking electric energy, and the current which passed dissolved the zinc from one plate and deposited it upon the other, so that after a certain interval of time had elapsed the altered weight of the plates enabled the quantity of electricity to be determined from the known fact that an electric current of one ampere, flowing for one hour, removes 1.2133 grammes of zinc from a solution of sulphate of zinc. Hence the quantity in ampere-hours passing through the electrolytic cell being known and the fraction of the whole quantity taken by the cell being known, the quantity supplied to the house was determined. To prevent temperature from affecting the shunt ratio, Edison joined in series with the electrolytic cell a copper coil the resistance of which increased with a rise of temperature by the same amount that the electrolyte decreased. Owing to the cost and trouble of weighing a large number of zinc plates, this type of meter fell into disuse.

A more modern type of electrolytic meter is that due to C. O. Bastian.¹ The whole current supplied to the house flows through an electrolytic cell consisting of a glass tube containing two platinum electrodes; the electrolyte is dilute sulphuric acid covered with a thin layer of oil to prevent evaporation. As the current flows it decomposes the liquid and liberates oxygen and hydrogen gases, which escape. The quantity of electricity which is passed is estimated by the diminution in the volume of the liquid. A third electrolytic meter of the shunt-voltmeter type is that of A. Westcott. In this meter the electrolyte is a solution of mercurous nitrate which is completely enclosed in a glass tube of a particular form, having a mercury anode and a platinum or carbon cathode. The current is determined by measuring the volume of the mercury delivered at the cathode. In the Long-Schattner electrolytic meter a solution of sulphate of copper is electrolyzed.

Motor Meters.—Amongst motor meters one well-known type belonging to the ampere-hour species is that of S. Z. Ferranti, who introduced it in 1883. It consists of an electromagnet within the iron core of which is a flat disk-like cavity containing mercury, the ends of the cavity being stamped with grooves. The main disk of mercury is therefore traversed perpendicularly by lines of magnetic force when the magnet is excited. The current to be measured is passed through the coils of the electromagnet, then enters the mercury disk at the centre, flows through it radially in all directions, and emerges at the periphery. The mass of mercury is thus set in motion owing to the tendency of a conductor conveying an electric current to move transversely across lines of magnetic force; it becomes in fact the armature of a simple form of dynamo, and rotates with a speed which increases with the strength of the current. The roughness of the surface of the cavity serves to retard it. The rotation of the mercury is caused by means of a mass of a small vane of platinum wire immersed in it, the shaft of this vane being connected by an endless screw with a counting mechanism. The core of the electromagnet is worked at a point far below magnetic saturation (see MAGNETISM); hence the field is nearly proportional to the square of the current, and the resistance offered to the rotating mercury by the friction against the sides of the cavity is nearly proportional to the square of the speed. It follows that the number of the revolutions the mercury makes in a given time is proportional to the quantity of electricity which is passed through the meter.

In order to overcome the friction of the counting train, Ferranti ingeniously gave to the core of the electromagnet a certain amount of permanent magnetism. Another well-known motor meter, working on a somewhat similar principle, is that of Chamberlain and Hookham. In its improved form this meter consists of a single horseshoe permanent magnet formed of tungsten-steel having a strong and constant field. Two air-gaps are made in this field parallel to each other. In one of these a copper disk, called the brake disk, revolves, and in the other a copper armature disk. The latter is slit radially, and the magnetic field is so arranged that it perforates each half of the disk in opposite directions. The armature is immersed in a shallow vessel filled with mercury, which is insulated from the vessel and the armature, except at the ends of the copper strips. The current to be measured passes transversely across the disk and causes it to revolve in the magnetic field; at the same time the copper brake, geared on the same shaft, revolves in the field and has local or eddy currents produced in it which retard its action. The principle of the meter is to make the breaking and driving action so strong that the friction of the train becomes immaterial in comparison. This meter is an ampere-hour meter and applicable only to continuous current circuits. Another form of motor meter which is much used is that of the Weston type, which is the work of a small dynamo having an armature and field magnet without any iron core. The armature carries on its shaft a commutator made of silver slips, and the current is fed into the armature by means of brushes of silver wire. The current to be measured passes through the fixed field-coils, whilst through the armature passes a shunt current obtained by connecting the brushes across the supply mains through a constant resistance. The driving force is balanced against a retarding force produced by the rotation of a copper disk fixed on the armature shaft, which rotates between the poles of a permanent magnet. Induced eddy currents are thus created in the copper disk, and the reaction of these magnets on the disk offers a resistance to the rotation of the disk. Hence when a current is passed through the meter, the armature rotates and increases its speed until the driving force is balanced against the retarding force due to the eddy currents in the copper brake disk. In these circumstances the number of rotations made by the armature in a given time is proportional to the product of the strength of the current flowing through the armature and that flowing through the field-coils, the former being the current to be measured. Hence the meter is a watt-hour meter and measures electric energy. In order to overcome the friction of the train the field-coils are geared to an auxiliary shunt coil which supplies a driving force sufficient to overcome the friction of the counting train. This last is geared to the shaft of the armature by an endless screw, and the number of revolutions of the armature is reckoned by the counting-dials, which are

so arranged as to indicate the consumption in Board-of-Trade units (1 Board-of-Trade unit = 1000 watt-hours). A modification of the above meter with some mechanical improvements has been devised by S. Evershed.²

Clock Meters.—Among clock meters the best known is that of H. Aron, which is based upon a principle described by W. E. Ayrton and J. Perry in 1882. It can be constructed to be either an ampere-hour meter or a watt-hour meter, but is usually the latter. Its principle is as follows: Suppose there are two pendulum clocks, one having an ordinary pendulum and the other having a pendulum consisting of a fine coil of wire through which a current is passed proportional to the potential difference of the supply mains—in other words, a shunt current. Below this pendulum let there be placed another coil through which passes the current to be measured; then when currents pass through these coils the pendulum of the second clock will be either accelerated or retarded relatively to the other clock, since the action of gravity is supplemented by that of an electric attraction or repulsion between the coils. Hence the second clock will gain or lose on the other. The two clock motions may be geared to a single counting mechanism which records the difference in the rates of going of the two clocks. If the difference of the number of oscillations made by the two pendulums in a given time is small compared to the number made by either of them separately, then it is easy to show that the power given to the circuit is measured by the gain or loss of one clock over the other in a given time, and can therefore be indicated on a counting mechanism or registering dials. By the use of a permanent magnet instead of a shunt coil as the bob of one pendulum, the meter can be made up as an ampere-hour meter. In this form it has the advantage that it can be used for either continuous or alternating currents.

Registering Meters.—Amongst some of the ampere-meter or watt-meter registers the current or power passing into the house; and a clock motion electrically driven is made to take readings of the ampere-meter or watt-meter at definite intervals—say, every five minutes—and to add up these readings upon a set of registered dials. The arrangement therefore integrates the ampere-hours or watt-hours. These meters, of which one well-known form is that of Johnson and Phillips, have the disadvantage of being unsuited for the measurement of electric supply in those cases in which it is irregular or intermittent—as in a theatre or hotel.

Induction Meters. are applicable only in the case of alternating current supply. The most important of the various forms is the Westinghouse-Shallenberger. It consists of a disk of aluminium, the axis of which is geared to a counting mechanism and which runs between the poles of permanent magnets that create eddy currents in it and therefore exert a retarding force. In proximity to the upper side of the disk is placed a coil of wire having an iron core, which is a shunt coil, the ends of the coil being connected to the terminals of the supply mains. Under the disk are two other coils which are placed in series with the supply. When these last coils are traversed by an alternating current they induce local or eddy currents in the disk. The current in the shunt coils lags so degrees behind the impressed electromotive force of the circuit to be measured; hence if the main current is in step with the potential difference of the terminals of the supply mains, which is the case when the supply is given wholly to electric lamps, then the field due to the main coil differs from that due to the shunt coil by 90 degrees. Since the eddy currents induced in the disk are 90 degrees in phase behind the inducing field, the eddy currents produced by the main coil are in step with the magnetic field due to the shunt coil, and hence the disk is driven round by the revolution due to the action of the shunt coil upon the eddy currents in the disk. Hence the disk will be accelerated until the driving force is balanced by the retarding force due to the induced currents created in the disk by the permanent magnets. When this is the case, the number of revolutions of the meter in a given time is a measure of the watt-hours or energy which is passed through the meter. The counting mechanism and dials may be so arranged as to indicate this energy directly in watt-hours. The meter is made up also in a form suitable for use with two or three fixed electric currents. (See ELECTRODYNAMICS.)

Requirements of a good House Meter.—A gas meter which has an error of 1% in favour of the customer or 3% in favour of the customer is not passed for use. An electric meter should therefore have approximately the same accuracy. As a matter of fact, it is difficult to rely upon most electric meters to register correctly to less than 4% even between quarter-load and full load. Out of nearly 700 current motor meters of various makes tested at Munich in 1902, only 319 had an error of less than 4%, whilst 259 had errors varying from 4% to 10%. If possible, however, the departures from absolute accuracy should not be more than 2% at quarter-load, nor more than 3% at a full load. The accuracy of a meter is tested by drawing calibration curves showing the percentage departure from absolute accuracy in its reading for various decimal fractions of full load. Such a test is made by determining with an accurate ammeter or watt-meter the current or power supplied to a circuit for a period measured by a good clock and comparing with this the actual reading of the meter

¹ See *Electrician*, 41, 112, and *Journ. Inst. Elec. Eng.* (London, 1898), 27, 547.

² See *Journ. Inst. Elec. Eng. Lond.* (1899), 29, 743.

during the same time. A common source of trouble is the short circuiting of the shunt coils owing to the shellacoted cotton covering of the wire becoming moist.

A good meter should start with a current which is not more than 2% of its full load current. With a supply pressure of 200 volts a 5 c.p. carbon filament lamp takes only 0.1 ampere; hence unless a meter will begin to register with $\frac{1}{10}$ ampere it will fail to record the current consumed by a single small incandescent lamp. In a large supply system such failure would mean a serious loss of revenue. The resistance of the meter coils causes a fall in voltage down the series coil which reduces the supply pressure to the consumer. On the other hand the resistance of the shunt coil absorbs energy which generally varies from 1 to 3 watts and is a loss either to the consumer or to the supply company, according to the manner in which the shunt coil is connected. In those meters which are compounded—that is, have a shunt coil wound on the field magnets to compensate for the friction of the train—it is important to notice whether the meter will operate or continue operating when there is no current in the series coil, since a meter which "runs on the shunt" runs up a debt against the consumer for which it gives no corresponding advantage.

Generally speaking, the price of the meter is a subordinate consideration. Since the revenue-earning power of a supply station depends entirely upon its meters, inaccuracy in meter record is a serious matter. The cost of measuring current by the aid of a meter is made up of three parts: (1) the prime cost of the meter, which varies from £2 to £6 for an ordinary 25-light house electric meter; (2) the capital value of the energy absorbed in it, which if the cost of the energy is taken at 2d. per Board-of-Trade unit, with interest and depreciation at 6%, may amount to £1.50 per customer; and (3) the annual working costs for repairs, and also the wages of the staff of meter men, who take the required monthly or quarterly readings. In the case of small and irregular consumers, such as the inhabitants of model dwellings and flats inhabited chiefly by working-class tenants, coin-in-the-slot meters are most employed. The customer cannot obtain current for electric lighting until he has placed in a slit a certain coin—say, a shilling—entitling him to a certain number of Board-of-Trade units—say, 2 or 4, as the case may be. In the Long-Schattner electrolytic meter, the insertion of the coin depresses a copper plate or plates into an electrolytic cell containing a solution of sulphate of copper; the passage of the current dissolves the copper off one of the plates, the loss in weight being determined by the quantity of the electricity passed. As soon as the plate has lost a certain amount of weight corresponding to the value of the electric energy represented by the coin, the plate rises out of the liquid and cuts off the current.

AUTHORITIES.—H. G. Solomon, *Electricity Meters* (London, 1906); C. H. W. Gerhardt, *Electricity Meters: their Construction and Management* (London, 1906); L. C. Reed, *American Meter Practice* (New York, 1904); J. A. Fleming, *A Handbook for the Electrical Laboratory and Testing Room* (London, 1904); T. P. Wilmshurst, "Electricity Meters," *Electrician* (1897), 39, 409; G. W. D. Ricks, "On the Variation of the Constants of Electricity Supply Meters, with Temperature and Current," *Electrician* (1897), 39, 573.

METHODISM, a term¹ denoting the religious organizations which trace their origin to the evangelistic teaching of John Wesley. The name "Methodist" was given in derision to those Oxford students who in company with the Wesleys used to meet together for spiritual fellowship; and later on when John Wesley had organized his followers into "societies" the name was applied to them in the same spirit. It was however accepted by him, and in official documents he usually styles them "the people called Methodists." The fact that standards of Methodist doctrine are laid down as consisting of "Mr Wesley's Notes on the New Testament and the 1st Series of his Sermons" (fifty-three in number), might seem to indicate a departure from existing systems, but it was not so. He fully accepted the recognized teaching of the Church of England, and publicly appealed to the Prayer Book and the Thirty-nine Articles in justification of the doctrines he preached. Methodism began in a revival of personal religion, and it professed to have but one aim, viz. "to spread Scriptural holiness over the land." Its doctrines were in no sense new. It was the zeal with which they were taught, the clear distinction which they drew between the profession of godliness and the enjoyment of its power—added to the emphasis they laid upon the immediate influence of the Holy Spirit on the consciousness

¹ "Methodism" is derived from "method" (Gr. *metabole*), a rule. A "methodist" is one who follows a "method," the term being applied not only to the Wesleyan body, but earlier to the Amyraldists, and in the 17th century to certain Roman Catholic apologetes.

of the Christian—which attracted attention, gave them distinction, and even aroused ridicule and opposition. Wesley and his helpers, finding the Anglican churches closed against them, took to preaching in the open air; and this method is still followed, more or less, in the aggressive evangelistic work of all the Methodist Churches. As followers rapidly increased they were compelled to hold their own Sunday services, and this naturally led them to appoint as preachers godly laymen possessing the gift of exhortation. These followed their ordinary avocations on week-days, but on Sundays preached to congregations in their own immediate neighbourhood, and hence were called *local preachers* as distinguished from *travelling preachers*. The extent to which the employment of the local preacher is characteristic of Methodism may be seen from the fact that in the United Kingdom while there are only about 5000 Methodist ministers, there are more than 18,000 congregations; some 13,000 congregations, chiefly in the villages, are dependent on local preachers.

In the organization adopted to foster spiritual life the very characteristic "Class-meetings for Christian fellowship" take a prominent place. Membership in the church depends solely upon being enrolled as a member of one of these meetings for Christian fellowship, and thus placing oneself under pastoral oversight.

The *Wesleyan Methodists* now represent the original body as founded by John Wesley in Great Britain and Ireland; but in America those who looked upon him as their founder adopted the episcopal mode of Church government after the War of Independence, and have since that time been known as *Episcopal Methodists* (see below). It should be noted that the *Welsh Calvinistic Methodists* are only slightly connected with the original body. They were indirectly the outcome of the evangelistic efforts of Howell Harris and Rowlands. Their work received the sympathy of Wesley and liberal financial help from the Countess of Huntingdon (see CALVINISTIC METHODISTS). For a time Whitefield was leader, and we find a reference to the "Whitefieldian and Wesleyan Methodists" in the Supplement to the *Gentleman's Magazine* for 1747, p. 619. The theological views of these teachers proved quite incompatible with the Arminianism of Wesley, and a definite breach between them and him took place in 1770. The *Welsh Calvinistic Methodists* are now a branch of the Presbyterian Church. Other divisions have been formed at various times by secessions from the Wesleyan Methodists (see separate articles). They are: Methodist New Connexion (founded 1797-1798); Bible Christians (1815); United Methodist Free Churches² (about 1836); Primitive Methodists (founded 1807-1810); Independent Methodist Churches (about 1806); Wesleyan Reform Union (1850, reorganized 1859). These bodies have separated solely on matters of Church government and not on points of doctrine. The *Primitive Methodists in Ireland* were a small body who in 1817 seceded because they wished to maintain that close connexion with the Church of England which existed at the time of Wesley's death, but in 1878 they rejoined the parent body. Methodism has always been aggressive, and her children on emigrating have taken with them their evangelistic methods. (For the American branches see below.)

The statistics given in the following table (not including Junior Society Classes) are from the Minutes of the Conference of the Wesleyan Methodist Church for 1909. At the death of Wesley the figures were: 313 preachers, 119 circuits and mission stations, and 76,968 members. In the United States: 97 circuits, 198 preachers and 43,265 members.

In 1837 the membership in Great Britain and Ireland was 318,716; in foreign mission stations, 66,007; in Upper Canada, 14,000; while the American Conferences had charge of 650,678 members. Total for the world: 1,049,401, with 4478 ministers.

Three Oecumenical Conferences have been held—two at City Road, London, in 1881 and 1901, and one at Washington in 1891. The statistics presented at the last showed that the Church during the preceding decade had gained about a million members and three million adherents. At the same time there has been a steadily

² These first three were joined in 1907 under the name of the United Methodist Church.

growing feeling in favour of union. Canada and Australasia led the way, for in these countries the Methodist Church was undivided, and the sentiment was greatly strengthened by the formation in the United Kingdom of the United Methodist Church in 1907.

See *A New History of Methodism*, ed. W. J. Townsend, H. B. Workman, George Eayrs (2 vols., London, 1909). (J. A. V.)

local and travelling preachers, and the organization of local societies with class leaders, stewards and trustees. The intention was to make American Methodism a facsimile of that in England, subject to Wesley and the British Conference—a society and not a Church. Pilmoor and others objected to Asbury's strict

Denomination.	Ministers.	Lay Preachers.	Church Members and Probationers.	Sunday Schools.	Officers and Teachers.	Sunday Scholars.	Churches, &c.
Wesleyan Methodists:—							
Great Britain	2,454	19,826	520,868	7,589	132,186	987,953	8,606 ¹
Ireland	246	621	29,531	353	2,557	25,099	414 ²
Foreign Missions	617	4,965	143,467	1,754	7,651	91,113	3,502
French Conference	35	89	1,675	70 ³	142	1,996	127
South African Conference	253	5,797	117,146	788	2,893	39,329	3,930
Primitive Methodists	1,178	16,158	212,168	4,155	59,557	465,531	5,148
United Methodist Church	891	6,183	186,905	2,404	43,169	323,675	3,188
Wesleyan Reform Union	21	527	8,489	181	2,762	22,312	196
Independent Methodist Churches	424	—	9,442	153	3,041	27,219	156
Australasian Methodist Church	975	4,576	150,751	3,973	24,322	231,553	6,418
United States:—							
Methodist Episcopal ⁴	19,421	147,743	3,376,888	34,619	361,667	3,068,248	29,765
Union American Methodist Episcopal	138	—	18,500	—	—	—	255
African Methodist Episcopal	6,070	15,885	850,000	—	—	—	6,815
African Union Methodist Protestant	200	750	2,000	350	900	2,770	125
African Methodist Episcopal Zion	3,912	15,320	578,310	2,034	14,404	122,457	3,241
Methodist Protestant	1,521	11,335	183,894	2,034	16,680	126,031	2,242
Wesleyan Methodist	524	—	19,064	465	—	18,344	598
Methodist Episcopal (South)	6,978	4,800	1,673,892	14,892	111,137	1,084,238	15,496
Congregational Methodist	415	—	24,000	—	—	—	425
Congregational Methodist (coloured)	5	—	319	—	—	—	5
New Congregational Methodist	238	—	4,022	—	—	—	417
Zion Union Apostolic	30	—	2,346	—	—	—	52
Coloured Methodist Episcopal	2,673	2,786	219,739	4,007	7,098	79,876	2,619
Primitive Methodist	72	138	7,013	108	—	11,754	104
Free Methodist	1,126	1,299	31,435	1,175	7,376	40,660	1,117
Independent Methodist	8	—	2,569	—	—	—	15
Evangelistic Missionary	92	27	5,014	—	—	1,200	47
Canadian Methodist Church	2,384	3,809	329,904	3,556	35,323	305,649	3,789
Japan Methodist Church ⁵	47	35	4,083	121	544	11,136	28
Totals	52,978	105,669	8,715,434	84,781	833,409	7,089,023	98,820

METHODISM IN THE UNITED STATES

There are in the United States sixteen distinct Methodist denominations, all agreeing essentially in doctrine. John Wesley had been conducting his United Societies for more than twenty years before the movement took root in North America.

A.—*Episcopal Methodist Churches.*

Philip Embury (1720-1775), a Wesleyan local preacher, emigrated in 1760 from Limerick to New York. Robert Strawbridge (?-1781), a local preacher and native of Ireland, settled in Maryland. In 1766 Embury was stimulated by his relative, Mrs Barbara Heck, to begin Methodist preaching, and a society was soon formed, which grew rapidly. Embury was reinforced by the arrival of Thomas Webb (1724-1796), an English local preacher and a captain in the British army. Webb and Thomas Taylor, a layman of superior ability, appealed to Wesley to send over missionaries, and the 26th annual British Conference, held in 1768, sent to the society in New York £50 and furnished passage money for two missionaries, Richard Boardman and Joseph Pilmoor (1730-1825). Three years later Francis Asbury was sent over, and was made assistant superintendent. Meanwhile Strawbridge had been preaching with success in Maryland and in Virginia.

These "advance agents" of this spiritual propaganda brought with them Wesley's Arminian Theology. They brought also "the means of grace" on which Wesley placed the greatest stress; such as personal testimony in private and public, class and prayer meetings, watch-nights, love-feasts, the direct and fervent preaching of the Gospel and the singing of Wesleyan hymns, carried on by means of circuits and stations, exhortors,

discipline, and Wesley, hearing of the disagreement, in 1773 appointed Thomas Rankin (c. 1738-1810) superintendent of the entire work of Methodism in America.

The First American Conference.—The first American Conference was held in 1773, and consisted of ten preachers, all of whom were born in England or Ireland. Asbury came to America to remain permanently; but Rankin, unable to identify himself with its people, to take the test oaths required in the Revolution, or to sympathize with the colonies, returned to England, as did all the English preachers except Asbury. By May 1776 there were 24 preachers and 491 members; but in the first year of the Revolution there was a loss of 7 preachers and nearly 1000 members. The next year saw extensive revivals, in sections removed from the seat of war, which added more than 2600 to the number of members.

The preachers in the South determined upon administration of the sacraments, and a committee was chosen whose members ordained themselves and others. The Northern preachers opposed this step and for several years the Connection was on the verge of disruption. An agreement was finally made to suspend the administration until Wesley's desires and judgment could be ascertained. He perceived that the society would disintegrate unless effective measures were speedily taken, and, aided by two presbyters of the Church of England, early in 1784 he ordained Thomas Coke (1747-1814), already a presbyter of that Church, as superintendent. He likewise ordained two of his lay preachers as deacons and elders, to accompany Coke, whom Wesley sent to America as his commissioner to establish, for the Methodist Society, a system of Church government, which should include the administration of Baptism and of the Lord's Supper. Coke

above. The 1908 returns are: Bulgaria, 546 members; Denmark, 3771; Finland and St Petersburg, 1367; France, 221; Italy, 3669; North Germany, 12,886; Norway, 6054; South Germany, 11,808; Sweden, 15,430; Switzerland, 9419.

⁵ Western Conference only.

¹ Seating accommodation, 2,374,425.

² Other preaching places, 1561. ³ Sunday and Thursday Schools.

⁴ Methodism is also represented in several European countries by Conferences and Missions affiliated to the Methodist Episcopal Church of America, and their membership is included in the figures given

was furnished by Wesley with a document setting forth the grounds on which he had taken this step. Wesley also appointed Thomas Coke and Francis Asbury "to be joint superintendents over our brethren in North America." Soon after Coke and his companions arrived they met Asbury and fifteen preachers, and a special conference was called, which opened on the 24th of December 1784, in the suburbs of Baltimore, Maryland. This convention organized itself into a Methodist Episcopal Church, in which the liturgy sent by Wesley should be read, and the sacraments should be administered by superintendents, elders and deacons, these elders and deacons to be ordained by a presbytery using the episcopal form. Coke and Asbury were unanimously elected superintendents, Coke, aided by his clerical companions from England, ordaining Asbury as deacon and elder and formally consecrating him a general superintendent. Several elders were ordained. This convention adopted the first Discipline of the Methodist Episcopal Church. It adopted the existing doctrinal standards, consisting chiefly of Wesley's Sermons and his Notes on the New Testament; also twenty-five of the Articles of Religion of the Church of England, modified so as to eradicate all trace of High Church ritualism, Anglican or Roman, and the distinctive doctrines of Calvinism.

The Church thus established began its ecclesiastical career with 18,000 members, 104 travelling preachers, about the same number of local preachers, and more than 200 licensed exhortors. There were 60 chapels and 800 regular preaching places.

The energy of Asbury, and the position of Coke in the Church of England, his wealth, culture, and preaching power, greatly reinforced the efforts of the preachers. The administration of the sacraments brought peace; and many who would not unite with the "Society" asked admission to the Church. Within five years the number of preachers swelled to 227, and the members to 45,949 (white) and 11,682 (coloured).

To bind the whole body the existing method required the concurrence of each Annual Conference with every proposition. This was inconvenient and occasioned much loss of time; therefore a General Conference was established to meet once in four years. The first was held in 1792, and therein arose a sharp conflict. James O'Kelly (1735-1826), a Presiding Elder in control of a large district, proposed that, when the list of appointments was read in the Conference, if any preacher was not pleased with his assignment he might appeal to the Conference. The motion being lost, O'Kelly and several other preachers seceded. The Conference in 1804 limited the power of the Bishops by forbidding them to appoint any pastor for more than two consecutive years in charge of the same church. As all "travelling preachers" were eligible, without election, to seats in General Conferences, widespread dissatisfaction prevailed among the distant Conferences. The era of the steamboat and the railway not having arrived, it was possible for two Annual Conferences, adjacent to the seat of the General Conference, to out-vote all others combined. This led to a demand for the substitution of a delegated General Conference, which was conceded by the Conference of 1808 to take effect four years later. The office then known as the Presiding Eldership had become powerful: Bishops appointed the pastors to churches, Presiding Elders to districts; but it was the purpose of the majority to transfer to the Annual Conferences the power of appointing Presiding Elders. The change, though discussed for many years, has not been accomplished.

Several issues had been settled; but one, that of slavery, had to be faced. The storm burst on the Conference of 1844. Bishop James Osgood Andrew (1794-1871), a native of the South, had, by inheritance and marriage, become a slaveholder. After debates of many days, he was requested "to desist from the exercise of the office of Bishop while this impediment remained." The Southern members declared that the infliction of such a stigma upon Bishop Andrew would make it impossible for them to maintain the influence of Methodism in the South, and a tentative plan of separation was adopted by the Conference by an almost unanimous vote. The result was that the Methodist Episcopal Church was bisected, and when the General Conference

of 1848 convened it represented 780 travelling preachers and 532,290 members fewer than it had numbered four years before.

After the Civil War the increase in membership was noteworthy. The quadrennial Conference of 1868 represented 222,687 members more than its predecessor; of this gain 117,326 were in the Southern States. In 1872 lay representatives were admitted, the Constitution having been amended so as to make it legal. It was not, however, an equal representation, for though ministerial Conferences were represented according to their number, in no circumstances could there be more than two lay representatives from one Annual Conference. Not till 1900 were lay and clerical representation equalized. In 1864 the time limit of pastorates was lengthened to three years, and in 1888 to five years. This limit was taken off in 1900, and pastors can be reappointed at the will of the Bishop.

Five women presented credentials as lay delegates in 1888. Their eligibility was questioned; and they were denied admission. For the next four General Conferences the struggle for the admission of women recurred. In 1900-1904 a general revision of the Constitution took place, and the words "lay members" were substituted for "laymen" in that part of the Constitution which deals with the eligibility of delegates to the General Conference.

The General Conference has power to make rules and regulations for the Church, subject only to restrictions which protect the Standards of Doctrine, the General Rules, the disposition of the property of the Book Concern and its income, the income of the Chartered Fund, and the right of ministers to trial before a jury of their peers, an appeal, and similar rights of the laity. By a two-thirds vote of a General Conference, and two-thirds votes of the members of the Annual Conference, and of the members of the Lay Electoral Conferences, present and voting, what is said in these "Restrictive Rules" can be altered or repealed, except that which deals with the Articles of Religion and "the present existing and established Standards of Doctrine." In the Annual Conferences the Bishop is the sole interpreter of law, subject to appeal to the General Conference. When presiding in the General Conference, a Bishop has no authority to decide questions of law, but may decide questions of order subject to an appeal to the body. The district superintendent visits each charge several times annually, presiding in the Quarterly Conference, the highest local authority in the Church, and he is expected to conserve the unity of the denomination and a regard for laws enacted by the supreme body. In the absence of a Bishop the district superintendent represents him, and may transfer any ministers within the bounds of his district.

Connexional Institutions.—The Book Concern, established in 1789, publishes the necessary devotional books of the Church, such as hymnal, discipline, theological works, religious experience, and numerous magazines and papers.

The Board of Foreign Missions carries on extensive operations in China, Japan, Korea, India and Malaysia, Italy, South America and Mexico. It assists the Methodist Churches organized in Norway, Sweden, Denmark, Finland, Germany and Switzerland, and has recently established missions in Russia and France.

The Board of Home Missions and Church Extension supplies the foreign peoples domiciled in the United States with ministers of their own tongue. It assists all English-speaking churches in need of help, and secures, by gifts and time loans, the erection of churches wherever needed. Invaluable coadjutors of these Boards are the Women's Foreign Missionary and the Women's Home Missionary societies.

The Board of Education, with the aid of a University Senate, assists young people to obtain education, and raises the standard of seminaries, colleges and universities. The Church, in the United States, supports 54 colleges and universities and 10 theological seminaries. The Freedmen's Aid Society is devoted to the educational needs of the negro race in the United States, in which work it has been very successful.

The Sunday School Union, Epworth League, Methodist Brotherhood, hospitals, homes for the aged, deaconess homes and children's institutions are maintained by an increasing army of workers.

The whole number of ministers (exclusive of foreign missions) in 1907, was 17,694; churches, 27,691; communicants, 2,984,261.

The Methodist Episcopal Church South.—After the adjournment of the General Conference of 1844, the representatives of thirteen Conferences covering the states holding slaves appeared to their constituents to determine what should be done to prevent Methodism in the South from being deprived of its influence over the whites and of the privilege, till then fully accorded, of preaching the Gospel and teaching its precepts to slaves. In 1845 a representative Convention was called; this body, with the approval and participation of Bishop Andrew, organized the Methodist Episcopal Church South. At its first General Conference, in 1846, the senior Bishop of the Methodist Episcopal Church, Joshua Soule (1781-1867), offered himself to the Church, which accepted him in his episcopal capacity. William Capers (1790-1855) and Robert Paine (1799-1882) were elected to the Episcopacy. The Church thus founded began with 460,000 members, of which 2972 were Indians, 124,961 coloured, and 1519 travelling ministers.

A difficulty arose on the division of the property of the Book Concerns, which the Methodist Episcopal Church maintained involved a change in the Constitution. A vote to authorize the division failed, and the Methodist Episcopal Church South, hopeless of relief, brought two suits, one against the Book Concern in New York, and the other against the Book Concern in Cincinnati. The former was decided in favour of the Methodist Episcopal Church South, and the latter in favour of the Methodist Episcopal Church. In the latter case an appeal was taken by the Methodist Episcopal Church South to the Supreme Court of the United States, which body unanimously decided that the Methodist Episcopal Church South was an integral part of the Methodist Episcopal Church which owned the Book Concerns, and ordered that the Southern Church should receive a proportionate part of the property of both Book Concerns. The amount ordered by the Court was in due time received.

The membership of the Church in 1860 was more than three-quarters of a million; but the Church was doomed to feel the force of the destructive elements of the Civil War. In April 1862 New Orleans was in possession of the Federal Government, rendering it impossible to hold the General Conference due at that time and place.

At the close of the war the Missionary Society of the Church was \$60,000 in debt, the Publishing House practically in ruins, and of the more than 200,000 coloured members in 1860 there remained fewer than 50,000. The Conference of 1866 convened in New Orleans. Radical changes in polity were effected. Attendance upon class meetings, which, from the origin of the Church had been obligatory, was made voluntary, and the rule was repealed which required a probation of six months before admission into full membership. The time limit on the continuation of pastorates was extended from two to four years. The most radical change was the introduction into the General Conference of a number of lay representatives equal to the number of clerical, and the admission into each Annual Conference of four lay delegates for each Presiding Elder's district.

The coloured people, with the consent of the Church, withdrew in 1870, and formed a new Church called the Coloured Methodist Episcopal Church.

The most striking denominational effort in its history was the maintenance of the solvency of the Publishing House, which was seized by the Federal Troops, and used as a United States printing office; with the damage done, and debts incurred in rebuilding, after a fire, interest, &c., the liabilities were \$35,000, with debts \$125,000 in excess of assets. The concern was declared insolvent; but the necessary funds were forthcoming, and the honour of the Church was maintained.

Education has received unceasing attention. The titles to 175 institutions are held by the Church, and the list of colleges and their character is a credit to the denomination. The most important is Vanderbilt University, at Nashville, Tennessee, founded in 1872, and largely endowed by members of the family whose name it bears. The chief foreign missions are in China, Mexico, Brazil, Japan, Korea and Cuba. Its mission in Japan and the mission of the Methodist Episcopal Church and the Methodist Church of

Canada were united in 1907 in a new organization entitled the Methodist Church of Japan. A distinguishing feature of this church is a practical veto power possessed by the bishops, to be exercised when the conference adopts any measure which in their opinion is unconstitutional. They have the right to present written objections and should the General Conference, by two-thirds vote adhere to its action, the proposal is sent down to the Annual Conference for ratification; otherwise it is void. Fraternal relations between the two great Episcopal Methodist Churches were fully established in 1876, and have broadened in spirit and scope from that time.

The Methodist Episcopal Church South in 1907 had 6774 ministers, 16,156 churches and 1,631,379 communicants.

The African Methodist Episcopal Church.—This body originated in strained relations between the white and coloured Methodists of Philadelphia, Pennsylvania, the result of which was, that the coloured people organized themselves, in 1816, into an independent body. They adopted as their standards the doctrines of the Methodist Episcopal Church, and, with a few modifications, its form of government. The Church steadily prospered, but for several years not proportionately in the department of education. Daniel Alexander Payne (1811-1893), who had studied in the Gettysburg Theological Seminary, led a reform, which involved a marked elevation of the qualifications for ministers, and from that time the body has constantly risen in public estimation. One of its peculiarities is that the bishops are members of the General Conference. It sustains Wilberforce University (at Wilberforce, Ohio) and other educational institutions, and has missions in Africa, South America, the West Indies and Hawaii. Notable orators have risen up among its members, who have added greatly to the respect felt for their race and Church. The African Methodist Episcopal Church, the largest Christian denomination consisting wholly of the Negro race, in 1907 comprised 6190 ministers, 5321 churches, and 842,023 communicants.

The African Methodist Episcopal Zion Church.—Some of the coloured people in the city of New York, "feeling themselves oppressed by caste prejudice, and suffering the deprivation of Church privileges permitted to others," organized among themselves, in 1796, and in the year 1800 built a church and named it Zion. For twenty years the Methodist Episcopal Church supplied this church with pastors. Then the members inducted three white ministers to ordain as elders three of their brethren, already deacons. Since they had Methodist precedents for such ordination, these proceeded to ordain others, and established churches in Philadelphia and New Hampshire. The elder conference one of their number a bishop. As late as 1863 the Church had only 92 ministers and 5000 members, but in twelve years it doubled its membership more than five times. In this Church the sexes are equally eligible to all positions. Its educational operations at first were failures, but gradually became successful. Its foreign missions were made a separate department in 1884. This Church had, in 1907, 3871 ministers, 3206 churches and 573,107 communicants.

The Coloured Methodist Episcopal Church.—In 1866 the General Conference of the Methodist Episcopal Church South authorized the bishops to organize its coloured members into an independent ecclesiastical body if it should appear that they desired it. The bishops formed a number of Annual Conferences, consisting wholly of coloured preachers, and in 1870 these Conferences requested the appointment of five commissioners of the Caucasian part of the Church to meet five of their own number to create an independent Church. Two Bishops of the Methodist Episcopal Church South presided, and ordained to the Episcopacy two coloured elders, selected by the eight coloured conferences. The coloured people by vote named the organization the Coloured Methodist Episcopal Church.

The Union American Methodist Episcopal Church agrees in doctrines and usages with other Methodist bodies. It is divided into Conferences and elects its Bishops for life. It had in 1907, 18,500 members, 138 ministers and 255 churches.

B.—Non-Episcopal Methodist Churches.

The Methodist Protestant Church.—In 1821 ministers and laymen of the Methodist Episcopal Church began to criticize its polity, and when their utterances became aggressive the adherents to the regular order replied with equal vigour. During the General Conference of 1824, held in Baltimore, a Convention of "Reformers" met, and established a periodical entitled *The Mutual Rights of the Ministers and Members of the Methodist Episcopal Church*, and made arrangements to organize Union Societies. Travelling and local ministers and laymen were expelled for schism and spreading incendiary publications. Prior to the Conference those expelled, and their sympathizers, formed themselves into a society named "Associate Methodist Reformers." These sent memorials to the General Conference of 1828, and issued addresses to the public. After a powerful and painful discussion, the appeals of the expelled members of

Conferences were rejected. The controversy centred upon lay representation, the episcopacy and the presiding eldership.

A General Convention was held on the 2nd of November 1830, a Constitution was adopted, and a new organization was established, styled the Methodist Protestant Church. Within eight years it had accumulated 50,000 members, the majority of whom were in the South and bordering states. The Methodist Protestant Church has a presbyterial form of government, the powers being in the Conference. There is no episcopal office or General Superintendent; each Annual Conference elects its own chairman. Its General Conference meets once in four years. Ministers and laymen equal in number are elected by the Annual Conferences, in a ratio of one delegate for 1000 members. The General Conference of the Methodist Episcopal Church of 1908 sent delegates to the Conference of the Methodist Protestant Church, making overtures toward an organic union, but formal negotiations have not been instituted. This Church had, in 1907, 1551 ministers, 2242 churches and 183,804 communicants.

The Wesleyan Methodist Connection or Church of America.—In the Methodist Episcopal Church slavery was always a cause of contention. In 1842 certain Methodist abolitionists conferred as to the wisdom of seceding. Among the leaders were Orange Scott (1800-1847), Jotham Horton and Le Roy Sunderland (1802-1885) and in a paper, which they had established, known as *The True Wesleyan*, they announced their withdrawal from the Church, and issued a call for a convention of all like-minded, which met on the 31st of May 1843, at Utica, New York, and founded the Wesleyan Methodist Connection or Church of America. The enterprise started with 6000 laymen and 22 travelling ministers of the Methodist Episcopal Church, and nearly as many more from the Methodist Protestant Church and other small bodies of Methodist antecedents. Its General Conference has an equal number of ministers and laymen. In less than eighteen months this body had gained in members 250%; but as the Methodist Episcopal Church had purged itself from slavery in 1844, and slavery itself was abolished in 1862, a large number of ministers and thousands of communicants, connected with this body, returned to the Methodist Episcopal Church. It had in 1907 539 ministers, 609 churches and 18,587 communicants.

The Congregational Methodists originated in Georgia in 1852; but in polity they are not strictly Congregational. Appeals from the decision of the Lower Church may be taken to a District Conference, to the State Conference, and ultimately to the General Conference. This Church had, in 1907, chiefly in Southern states, 24,000 members, 415 ministers and 425 churches.

The Free Methodist Church.—This body was organized in August 1860, and was the result of ten years of agitation. A number of ministers and members within the bounds of the Genesee Conference, in Western New York, in 1850, began to deplore and denounce the decline of spirituality in the Methodist Episcopal Church. The Rev. B. T. Roberts, the ablest among them, was reprimanded by the Bishop presiding in the Annual Conference, and next year he was expelled. Similar proceedings were taken against others, who appealed to the General Conference of 1860, but their expulsion was confirmed. It was the purpose of the founders to conserve the usage and the spirit of primitive Methodism. The government of the Church is simple, in all but the Episcopacy and its adjuncts resembling that of the Church whence it sprang. The Free Methodist Church had, in 1907, 1032 ministers, 1106 churches, and 31,376 communicants.

Minor Methodist Churches.—*The Primitive Methodist Church*, as it exists in the United States, came from England. In 1907 it reported 7913 communicants. *The Independent Methodists* are composed of congregations in Maryland, Tennessee and the District of Columbia. They had less than 3000 members in 1907. *The Evangelist Missionary Church* had taken 3000 ministers and members in Ohio, who in 1886 withdrew from the African Methodist Episcopal Zion Church. They had in 1907 about 5000 members. *The New Congregational Methodists* in 1881 withdrew from the Methodist Episcopal Church South, in Georgia. They had 4022 members in 1907. *The African Union Methodist Protestant Church* dates from 1816, and differed from the African Methodist Episcopal Church in opposing itinerancy, "paid ministers," and episcopacy. In 1907 it had 3867 members in eight states. *The Zion Union Apostolic Church* was organized in 1860, in Virginia. It was reported in 1890 to have 2346 communicants, and shows no gain at the present time.

BIBLIOGRAPHY.—Gross Alexander, *History of the Methodist Episcopal Church, South* (New York, 1804), being vol. xi. of the "American Church History Series"; John Atkinson, *Centennial*

History of American Methodism (New York, 1884); Francis Asbury, *Journal* (3 vols., New York, 1852); Nathan Bangs, *A History of the Methodist Episcopal Church from its Origin in 1776 to the General Conference of 1840* (4 vols., New York, 1839-1842); Henry B. Bascom, *Methodism and Slavery* (Nashville); A. H. Bassett, *History of the Methodist Protestant Church* (Pittsburg, 1878, revised, 1882, 1887); Thomas E. Bond, *Economy of Methodism, Illustrated and Defended*; J. M. Buckley, *History of Methodism in the United States* (1807); H. K. Carroll, *Religious Forces of the United States* (New York, 2nd ed., 1896); David W. Clark, *Life and Times of Elias Hacking* (New York, 1895); Daniel Dorchester, *Christianity in the United States* (New York, 1895); Edward J. Drinkhouse, *History of Methodist Reform* (2 vols., Baltimore, 1899); Robert Emory, *History of the Discipline of the Methodist Episcopal Church* (New York, 1843); William L. Harris, *Constitutional Powers of the General Conference* (1860); J. W. Hood, *One Hundred Years of the African Methodist Episcopal Zion Church* (New York, 1895); Jesse Lee, *A Short History of the Methodists in the United States of America* (Baltimore, 1810); John Linnam, *History of the Rise and Progress of Methodism in America* (1859); Alexander McCaine, *History and Ministry of Methodist Episcopacy* (Baltimore, 1829); Holland N. McTycire, *A History of Methodism* (Nashville, 1884); Joel Martin, *The Wesleyan Manual, or History of Wesleyan Methodism* (Syracuse, N. Y., 1880); Lucius C. Matlack, *Anti-Slavery Struggle and Triumph of the Methodist Episcopal Church* (New York, 1881); Stephen M. Merrill, *A Digest of Methodist Law* (New York, revised ed., 1888); Thomas D. Neely, *A History of the Origin and Development of the Governing Conference in Methodism* (New York, 1892); id. *The Evolution of Episcopacy and Organic Methodism* (New York, 1888); Robert Payne, *Life and Times of William McKendree* (2 vols., Nashville, 1866; revised, 1874); Daniel A. Payne, *History of the African Methodist Episcopal Church* (1891); James Porter, *Comprehensive History of Methodism* (New York, 1891); A. J. Redford, *History of the Organization of the Methodist Episcopal Church South* (Nashville, 1871); J. M. Reid, *Missions and Missionary Society of the Methodist Episcopal Church* (New York, 1895), revised by J. T. Gracey; David Sherman, *History of the Revisions of the Discipline of the Methodist Episcopal Church* (New York, 3rd ed., 1890); Abel Stevens, *History of Methodism* (3 vols., New York, 1858); id. *History of the Methodist Episcopal Church* (4 vols., New York, 1864); id. *The Centenary of American Methodism* (New York, 1866); John J. Tigert, *A Constitutional History of American Episcopal Methodism* (Nashville, 1894); J. B. Wakeley, *Lost Chapters Recovered from the Early History of American Methodism* (New York, 1858); Thomas Ware, *Sketches and Journals of Thomas American Methodist Churches. And the Proceedings of the Centenary Methodist Conference* (1884); of the First Ecumenical Conference (1881); of the second Ecumenical Conference (1891); and of the third Ecumenical Conference (1901). (J. M. Bv.)

METHODIST NEW CONNEXION, a Protestant Nonconformist Church, formed in 1797 by secession from the Wesleyan Methodists, and merged in 1907 into the United Methodist Church (*q.v.*). The secession was led by Alexander Kilham (*q.v.*), and resulted from a dispute regarding the position and rights of the laity, Kilham and his party desiring more power for the members of the Church and less for the ministers. In its conferences ministers and laymen were of equal number, the laymen being chosen by the circuits and in some cases by "guardian representatives" elected for life by conference. Otherwise the doctrines and order of the Connexion were the same as those of the Wesleyans. At the time of the union with the Bible Christians and the United Methodist Free Church in 1907 the Methodist New Connexion had some 250 ministers and 45,000 members.

METHODIUS (c. 825-885), the apostle of the Slavs, was a native of Thessalonica, probably by nationality a Graeco-Slav. His father's name was Leo, and his family was socially distinguished; Methodius himself had already attained high official rank in the government of Macedonia before he determined to become a monk. His younger brother Constantine (better known as Cyril, the name he adopted at Rome shortly before his death) was a friend of Photius, and had earned the surname "the Philosopher" in Constantinople before he withdrew to monastic life. Constantine about 860 had been sent by the emperor Michael III. to the Khazars, a Tatar people living north-east of the Black Sea, in response to their request for a Christian teacher, but had not remained long among them; after his return to within the limits of the empire, his brother and he worked among the Bulgarians of Thrace and Moesia, baptizing their king Bogoris in 861. About 863, at the invitation of Rastislav, king of "Great Moravia," who desired the Christianization of his subjects, but

at the same time that they should be independent of the Germans, the two brothers went to his capital (its site is unknown), and, besides establishing a seminary for the education of priests, successfully occupied themselves in preaching in the vernacular and in diffusing their translations of Scripture lessons and liturgical offices. Some conflict with the German priests, who used the Latin liturgy, led to their visiting Pope Nicholas I., who had just been engaged in his still extant correspondence with the newly converted Bulgarian king; his death (in 867) occurred before their arrival, but they were kindly received by his successor Hadrian II. Constantine died in Rome (in 869), but Methodius, after satisfying the pope of his orthodoxy and obedience, went back to his labours in "Moravia" as archbishop of Sirmia (Sirmium) in Pannonia. His province appears to have been, roughly speaking, co-extensive with the basins of the Raab, Drave and Save, and thus to have included parts of what had previously belonged to the provinces of Salzburg and Passau. In 871 complaints on this account were made at Rome, nominally on behalf of the archbishop of Salzburg, but really in the interests of the German king and his Germanizing ally Swatopluk, Rastislav's successor; they were not, however, immediately successful. In 879, however, Methodius was again summoned to Rome by Pope John VIII., after having declined to give up the practice of celebrating mass in the Slavonic tongue; but, owing to the peculiar delicacy of the relations of Rome with Constantinople, and with the young church of Bulgaria, the pope, contrary to all expectation, ultimately decided in favour of a Slavonic liturgy, and sent Methodius (880) back to his diocese with a suffragan bishop of Neitra, and with a letter of recommendation to Swatopluk. This suffragan, a German named Wiching, unfortunately proved the reverse of helpful to his metropolitan, and through his agency, especially after the death of John VIII. in 882, the closing years of the life of Methodius were embittered by continual ecclesiastical disputes, in the course of which he is said to have laid Swatopluk and his supporters under the ban, and the realm under interdict. The most trustworthy tradition says that Methodius died at Hardisc on the March, on the 6th of April 885. He was buried at Welehrad (probably Stuhlweissenburg).

The Greek Church commemorates St Cyril on February 14 and St Methodius on May 11; in the Roman Church both are commemorated on March 9. Their canonization (by Leo XIII. in 1881) is noteworthy, in view of the fact that Gregory VII. and several other popes condemned them as Arians. After the death of Methodius much of his work was undone; his successor Gosrad, a Slav, was expelled, with all the Slav priests, and the Latin language and liturgy supplanted the vernacular. On the 5th of July 1863 a millennial celebration of the two brother apostles was held by the people of Bohemia and Moravia.

See Schafarik's *Slawische Aelterthümer*; L. K. Götz, *Geschichte der Slawenapostel Konstantin und Methodius* (Gotha, 1897); N. Bonwetsch, *Cyrill und Methodius, die Lehrer der Slawen* (Erlangen, 1885), and art. in Hauck-Herzog's *Realencyclopädie für prot. Theol.* iv. 384, where the literature is cited; G. F. Maclear, *Conversion of the Slaves* (London, 1879).

METHUEN, BARON OF. The English title of Baron Methuen of Corsham (Wilts) was created in 1838 for Paul Methuen (1779-1849), who had been a Tory member of parliament for Wilts from 1812 to 1819, and then sat as a Whig for North Wilts from 1833 to 1838. His father, Paul Methuen, was the cousin and heir of the wealthy Sir Paul Methuen (1672-1757), a well-known politician, courtier, diplomatist and patron of art and literature, who was the son of John Methuen (c. 1650-1706), Lord Chancellor of Ireland (1697-1703) and ambassador to Portugal. It was the last-named who in 1703 negotiated the famous "Methuen Treaty," which, in return for the admission of English woollens into Portugal, granted differential duties favouring the importation of Portuguese wines into England to the disadvantage of French, and thus displaced the drinking of Burgundy by that of port. He and his son were both buried in Westminster Abbey. The 1st baron was succeeded in the title by his son Frederick Henry Paul Methuen (1818-1891), and the latter by his son Paul, 3rd baron (b. 1845), a distinguished soldier, who became a major-general in 1890, and general officer

commanding-in-chief in South Africa in 1907. The 3rd baron joined the Scots Guards in 1864, served in the Ashanti War of 1874 and the Egyptian War of 1882, and commanded Methuen's Horse in Bechuanaaland in 1884-85, and the first division of the 1st Army Corps in the South African War of 1899-1902. (See TRANSVAAL.)

METHUSALAH, in the Old Testament, the seventh in descent from Adam, and father of Lamech. According to Genesis v. 21 he lived 969 years (see BIBLE: *Old Testament*, § 5, "Chronology"). The name itself has been much discussed. Holzinger interprets it as "man of the javelin": Hommel prefers "man of Selah," Selah being the Hebraized form of the Babylonian Sarrau (*i.e.* the god Sin), and identifies it with the Ἀμμήσολος of Berossus. The form Methushael, used by the author of Gen. iv. 18 and by some commentators preferred for Gen. v. 21, is variously explained as meaning "man of El" (Ball), or as a transcription (Sayce) of the Babylonian Mutu-ša-ili (possibly, "man of the goddess").

METHVEN, a village and parish of Perthshire, Scotland, 7½ m. W. by N. of Perth by the Caledonian Railway. Pop. of parish (1901), 1699. Only an aisle remains of the collegiate church founded in 1433 by Walter Stewart, earl of Atholl (d. 1437). One mile east of the village, Methven Castle, dating partly from 1680, occupies a fine situation in a park in which stands the Pepperwell oak, 18 ft. in circumference. At Dronach Haugh near the banks of the Almond, which bounds the parish on the N., the earl of Pembroke defeated Robert Bruce in 1306. At Lynedoch, his estate on the Almond, Thomas Graham (1748-1843), the Peninsular general, afterwards Lord Lynedoch, carried on many experiments in farming and stock-breeding. He formerly owned Balgowan House, about 3 m. south-west of Methven, where many years after his death the proprietor discovered, during certain alterations, the portrait of Lord Lynedoch's wife, the Hon. Mrs Graham (a daughter of the 9th Lord Cathcart), one of Gainsborough's masterpieces, now in the National Gallery in Edinburgh; 4½ m. north-west of Methven, occupying a beautiful position in Glenalmond, is Trinity College, a public school on the English model, the first of its kind in Scotland, founded in 1841 through the efforts of W. E. Gladstone, J. R. Hope-Scott, Dean Ramsay and others, and opened in 1847. In 1851 Charles Wordsworth, the first warden, afterwards bishop of St Andrews, added the chapel. At Tibbermore, or Tippermuir, about 3 m. south-east of Methven, Montrose won the first of a series of battles over the Covenanters on the 1st of September 1644.

METHYL ALCOHOL (CH₃OH), the simplest aliphatic alcohol; an impure form is known in commerce as wood-spirit, being produced in the destructive distillation of wood. The name methyl, from Gr. μῆθρ, wine, ἄλν, wood, explains its origin. Discovered by Boyle in 1661, it was first carefully studied by Dumas and Péligot in 1831; its synthesis from its elements (through methane and methyl chloride) was effected by Berthelot in 1858. It is manufactured by distilling wood in iron retorts at about 500° C., when an aqueous distillate, containing methyl alcohol, acetone, acetic acid and methyl acetic ester, is obtained. This is neutralized with lime and redistilled in order to remove the acetic acid. The distillate is treated with anhydrous calcium chloride, the crystalline compound formed with the alcohol being separated and decomposed by redistilling with water. The aqueous product is then dehydrated with potash or lime. To obtain it perfectly pure the crude alcohol is combined with oxalic, benzoic or acetic acid, and the resulting ester separated, purified, and finally decomposed with potash. Methyl alcohol is also obtained in the dry distillation of molasses. The amount of methyl alcohol present in wood spirit is determined by converting it into methyl iodide by acting with phosphorus iodide; and the acetone by converting it into iodoform by boiling with an alkaline solution of iodine in potassium iodide; ethyl alcohol is detected by giving acetylene on heating with concentrated sulphuric acid, methyl alcohol, under the same circumstances, giving methyl ether.

Pure methyl alcohol is a colourless mobile liquid, boiling at

66°–67°, and having a specific gravity of 0.8142 at 0° C. It has a burning taste, and generally a spirituous odour, but when absolutely pure it is said to be odourless. It mixes in all proportions with water, alcohol and ether. Its compound with calcium chloride has the formula $\text{CaCl}_2 \cdot 4\text{CH}_3\text{OH}$, and with barium oxide $\text{BaO} \cdot 2\text{CH}_3\text{OH}$. Oxidation gives formaldehyde, formic acid and carbonic acid; chlorine and bromine react, but less readily than with ethyl alcohol. The chief industrial applications are for making denatured alcohol (*g.r.*), and as a solvent, e.g. in varnish manufacture; it is also used for a fuel; a purer product is extensively used in the colour and fine chemical industries.

Methyl chloride CH_3Cl , is a gas, boiling at -23° , obtained by chlorinating methane, or better, from methyl alcohol; wood spirit is treated with salt and sulphuric acid, or hydrochloric acid gas conducted into the boiling spirit in the presence of zinc chloride, the evolved gas being washed with potash and dried by sulphuric acid. It is also prepared by heating trimethylamine hydrochloride. Alcohol dissolves 35 volumes and water 4. *Methyl bromide* is a liquid, specific gravity 1.73, boiling point 13° ; *methyl iodide* has a specific gravity of 2.19, and boils at 43° .

METICULOUS (through Fr. *meticuleux*, from Lat. *meticulosus*, timid, cautious; *metus*, fear), a term meaning pedantically or excessively careful of details, over-scrupulous, laying too much stress on minutiae.

METOCHITA, THEODORE [THEODOROS METOCHITES], a Byzantine author, man of learning and statesman, who flourished during the reign of Andronicus II. Palaeologus (1282–1328). After the deposition of his patron by Andronicus III., Metochita was deprived of his office of great logothete (chancellor) and sent into exile. He was soon recalled, but retired from political life to a convent, where he died in 1332. He was a man of very great learning, only surpassed by Ptolemy and Michael Pselus. His pupil Nicephorus Gregoras, who delivered his funeral oration, calls him a "living library."

Only a few of his numerous works have been preserved. The best known is *Ἐπιτομὴ τῶν κατὰ τὸν συνέτακτον ἡρωϊκῶν, Μικτελλεῖα Φιλοσοφικὰ καὶ ἱστορικὰ* (ed. C. Müller and T. Kieckhefer, 1821) containing some 120 sayings, for a list of them see Fabricius, *Bibliotheca graeca* (ed. Hartes), s. 417; in these he chiefly made use of Synecius. Of his rhetorical pieces two have been published by C. N. Sathas in *Μεταφραστικὴ Βιβλιοθήκη* (1872), and two poems on religious subjects by M. Treu (1895). The poems, dealing mainly with contemporary and personal matters, are written in hexameter, not in the usual "political" verse. Metochita was also the author of works on philosophical and astronomical subjects.

METONIC CYCLE, in chronology, a period of 19 years during which there are 235 lunations, so called because discovered by Meton. Computation from modern data shows that 235 lunations are 6939 days, 16.5 hours; and 19 solar years, 6939 days, 14.5 hours. The relation between integral numbers of months and years expressed by Meton's rule therefore deviates only two hours from the truth. Since 19 Julian years make 6939 days, 18 hours, the relation errs by only 1.5 hour when the Julian year is taken. Meton was an Athenian astronomer (fl. 432 B.C.).

METONYMY (Gr. *μετωνυμία*, change of name, from *μετά* denoting change, and *ὄνομα*, name), a figure of speech, in which the name of one thing is changed for that of another, to which it is related by association of ideas, as having close relationship to one another. Thus "sceptre," "throne," "crown," are used for royal power or authority, "hearth and home" is used for "country," &c.

"Synecdoche" (Gr. *συνεκδοχή*, from *συνεκδέχεσθαι*, to join in receiving) is a rhetorical figure similar to metonymy, in which the part is used for the whole or vice versa, thus "hands" is used for the members of the crew of a vessel; a regiment of infantry is said to number so many "bayonets," &c.

METOPÉ (Gr. *μετώπη*, a middle space), a term in architecture for the square recess between the triglyphs in a Doric frieze, which is sometimes filled with sculpture.

METRE (*μετρική*, sc. *τέχνη*, from Gr. *μέτρον*, measure), in prosody, the harmonious and regulated disposition of syllables into verse. Metrical form is distinguished from prose by the uniformity of corresponding lines in relation to the number of syllables and the similarity of final sound (rhyme or

assonance), by the repetition of certain letters at regular intervals (in alliterative measure), or merely by the regular succession of ups and downs of intonation. In ancient classic poetry the measure which creates the metrical form consists only of this last quantitative element, which is rhythm.

For the rules and divisions of the various metrical systems, see **VERSE**. For the restricted use of "metre" as a unit of measurement, see **METRIC SYSTEM** below.

METRIC SYSTEM (adapted from Gr. *μέτρον*, measure), that system of weights and measures of which the metre is the fundamental unit. The theory of the system is that the metre is a $\frac{1}{10000000}$ part of a quadrant of the earth through Paris; the litre or unit of volume is a cube of $\frac{1}{10}$ metre side; the gramme or unit of weight is (nominally) $\frac{1}{10000}$ of the weight of a litre of water at 4° C. The idea of adopting scientific measurements had been suggested as early as the 17th century, particularly by the astronomer Jean Picard (1602–1682), who proposed to take as a unit the length of a pendulum beating one second at sea-level, at a latitude of 45° . These suggestions took practical shape by a decree of the National Assembly in 1790 appointing a committee to consider the suitability of adopting either the length of the seconds pendulum, a fraction of the length of the equator or a fraction of the quadrant of the terrestrial meridian. The committee decided in favour of the latter and a commission was appointed to measure the arc of the meridian between Dunkirk and Mont Jany, near Barcelona. Another commission was also appointed to draw up a system of weights and measures based on the length of the metre and to fix the nomenclature, which on the report of the commission was established in 1795. It was not until 1799 that the report on the length of the metre was made. This was followed by the law of the 10th of December 1799 fixing definitely the value of the metre and of the kilogramme, or weight of a litre of water, and the new system became compulsory in 1801. It was found necessary however to pass an act in 1837, forbidding as and from the 1st of January 1840, under severe penalties, the use of any other weights and measures than those established by the laws of 1795 and 1799. The metric system is now obligatory in Argentina, Austria-Hungary, Belgium, Brazil, Chile, France, Germany, Greece, Italy, Mexico, Netherlands, Norway, Peru, Portugal, Rumania, Servia, Spain, Sweden, Switzerland. Its use is legalized in Egypt, Great Britain, Japan, Russia, Turkey and the United States. In 1875 there was constituted at Paris the International Bureau of Weights and Measures, which is managed by an international committee. The object of the Bureau is to make and provide prototypes of the metre and kilogramme, for the various subscribing countries.

In England action has frequently been taken both by individuals and by associations of commercial men for the purpose of endeavouring to make the metric system compulsory. A Decimal Association was formed in 1854, but did not make very much headway. A bill was introduced into parliament in 1864 to make the metric system compulsory for certain purposes, but owing to government objections a permissive bill was substituted and subsequently became law as the Metric Act 1864. It was, however, repealed by the Weights and Measures Act 1878. In 1871 another bill for compulsory adoption was rejected by the House of Commons on the second reading by a majority of five. In 1893 a representative delegation of business men pressed its adoption on the chancellor of the exchequer (Sir W. V. Harcourt), but he declined. But in 1897 a statute was passed, the Weights and Measures (Metric System) Act, which legalized the use in trade of the metric system, and abolished the penalty for using or having in one's possession a weight or measure of that system.

See also **DECIMAL COINAGE** and **WEIGHTS** and **MEASURES**.

METROLES, a Greek philosopher of the Cynic school, was a contemporary of Crates, under whose persuasion he deserted the views of Theophrastus. It was his sister, Hipparchia, whose romantic attachment to Crates is a fascinating sidelight on the almost truculent asceticism of the Cynics. He was a man of peculiar strength of character, and esteemed the joys of life so low that he was deterred from an early suicide only by the influence of Crates. His philosophical views, which were identical with those of Crates (*g.r.*), he expounded by precept and example with great success, and had among his pupils

Menippus of Sinope. Having weighed the probable pains and pleasures of approaching old age, he decided that life had nothing left for which he greatly cared, and drowned himself. He is said to have written several works, which he afterwards burnt. Of one, entitled *Xpeia*, Diogenes preserves a single line (vi. 6).

METRODORUS, the name of five philosophers.

1. **METRODORUS** of Athens was a philosopher and painter who flourished in the 2nd century B.C. It chanced that Paulus Aemilius, visiting Athens on his return from his victory over Perseus in 168 B.C., asked for a tutor for his children and a painter to glorify his triumph. The inhabitants suggested Metrodorus as capable of discharging both duties, and it is recorded that Aemilius was entirely satisfied (see Pliny, *Nat. Hist.* xxv. 135).

2. **METRODORUS** of Chios was an important member of the Atomistic school. A pupil of Nessus, or, as some accounts prefer, of Democritus himself, he was a complete sceptic. He accepted the Democritean theory of atoms and void and the plurality of worlds, but held a theory of his own that the stars are formed from day to day by the moisture in the air under the heat of the sun. His radical scepticism is seen in the first sentence of his *Περὶ φῶτος*, quoted by Cicero in the *Academicus* ii. 23 § 73. He says, "We know nothing, no, not even whether we know or not!" and maintains that everything is to each person only what it appears to him to be. Metrodorus is especially interesting as the teacher of Anaxarchus, the friend of Pyrrho, and, therefore, as the connecting link between atomism proper and the later scepticism. It cannot be decided whether a work entitled the *Τροαϊκά* quoted by Athenæus (iv. 184 a) is by this, or another, Metrodorus. The same difficulty is found in the case of the *Περὶ ἰστροπίας* referred to by the scholiast on Apollonius.

3. **METRODORUS** of Lampsacus was the disciple and intimate friend of Epicurus, and is described by Cicero (*de Fin.* i. 28. 92) as "almost a second Epicurus." He died in 277 B.C. at the age of fifty-three, seven years before his master, who adopted his children and in his will commended them to the care of his pupils. The wife of Metrodorus was Leontion, herself, like many other women of the time, a member of the Epicurean society. Athenæus (vii. 279 F.) quotes from the words of Metrodorus showing that he was in entire agreement with Epicurus, and was, if possible, even more dogmatic in his doctrine of pleasure. He censures his brother, Timocrates, who, though professedly Epicurean, maintained the existence of pleasures other than those of the body.

4. Another **METRODORUS** of Lampsacus was a pupil of Anaxagoras, and one of the earliest to attempt to interpret Homer allegorically. He explained not only the gods but also the heroes Agamemnon, Achilles, Hector, as representing primary elements and natural phenomena.

5. **METRODORUS** of Stratonice was a pupil, first of Apollodorus, and later of Carneades. He flourished about 110 B.C., and is reputed to have been an orator of great power. His defection from the Epicurean school is almost unique. It is explained by Cicero as being due to his theory that the scepticism of Carneades was merely a means of attacking the Stoics on their own ground. Metrodorus held that Carneades was in reality a loyal follower of Plato.

METRONOME (Gr. *μέτρον*, measure, and *νόμος*, law), an instrument for denoting the speed at which a musical composition is to be performed. Its invention is generally, but falsely, ascribed to Johann Nepomuk Maelzel, a native of Ratisbon (1772-1838). It consists of a pendulum swung on a pivot; below the pivot is a fixed weight, and above it is a sliding weight that regulates the velocity of the oscillations by the greater or less distance from the pivot to which it is adjusted. The silent metronome is impelled by the touch, and ceases to beat when this impulse dies; it has a scale of numbers marked on the pendulum, and the upper part of the sliding weight is placed under that number which is to indicate the quickness of a stated note, as M.M. (Maelzel's Metronome) $\rho = 60$, or $\rho = 72$, or $\rho = 108$, or the like. The number 60 implies a second of time for each single

oscillation of the pendulum—numbers lower than this denoting slower, and higher numbers quicker beats. The scale at first extended from 50 to 160, but now ranges from 40 to 208. A more complicated metronome is impelled by clock-work, makes a ticking sound at each beat, and continues its action till the works run down; a still more intricate machine has also a bell which is struck at the first of any number of beats willed by the person who regulates it, and so signifies the accent as well as the time.

The earliest instrument of the kind, a weighted pendulum of variable length, is described in a paper by Etienne, Loulié (Paris, 1696; Amsterdam, 1698). Attempts were also made by Enbrayg (1732) and Gabory (1771). Harrison, who gained the prize awarded by the English government for his chronometer, published a description of an instrument for the purpose in 1775. Davaux (1784), Pelletier, Abel Burja (1790) and Weiske (also 1790) described their various experiments for measuring musical time. In 1813 Gottfried Weber, the composer, theorist and essayist, proposed a weighted ribbon graduated by inches or smaller divisions, which might be lengthened or shortened at any time, and which would infallibly oscillate at the same speed so long as the instrument lasted. Stöckel and Zmeskal produced each an instrument; and Maelzel made some slight modification of that by the former, about the end of 1812, which he announced as a new invention of his own, and exhibited from city to city on the Continent. It was, as nearly as can be ascertained, in 1812 that Winkel, a mechanician of Amsterdam, devised a plan for reducing the inconvenient length of all existing instruments, on the principle of the double pendulum, rocking on both sides of a centre and balanced by a fixed and a variable weight. He spent three years in completing it, and it is described and commended in the *Report of the Netherlands Academy of Sciences* (Aug. 14, 1815). Maelzel thereupon went to Amsterdam, saw Winkel and inspected his invention, and, recognizing its great superiority to what he called his own, offered to buy all right and title to it. Winkel refused, and so Maelzel constructed a copy of the instrument, to which he added nothing but the scale of numbers, took this copy to Paris, obtained a patent for it, and in 1816 established there, in his own name, a manufactory for metronomes. When the impostor revisited Amsterdam, the inventor instituted proceedings against him for his piracy, and the Academy of Sciences decided in Winkel's favour, declaring that the graduated scale was the only point in which the instrument of Maelzel differed from his. Maelzel's scale was needlessly and arbitrarily complicated, proceeding by twos from 40 to 60, by threes from 60 to 72, by fours from 72 to 120, by sixes from 120 to 144 and by eights from 144 to 208. Dr. Croch constructed a time measurer, and Henry Smart (the violinist, father of the composer of the same name) made another in 1821, both before that received as Maelzel's was known in England. In 1882 James Mitchell, a Scotsman, made an ingenious amplification of the Maelzel clock-work, reducing to mechanical demonstration what formerly rested wholly on the feeling of the performer.

Although "Maelzel's metronome" has universal acceptance, the silent metronome and still more Weber's graduated ribbon are greatly to be preferred, for the clock-work of the other is liable to be out of order, and needs a necessity of regulation which is almost impossible; for instance, when Sir George Smart had to mark the traditional times of the several pieces in the Dettingen Te Deum, he tested them by twelve metronomes, no two of which beat together. The value of the machine is exaggerated, for no living performer could execute a piece in unvaried time throughout, and no student could practise under the tyranny of its beat; and conductors of music, nay, composers themselves, will conduct the same piece slightly slower or quicker on different occasions, according to the circumstances of performance.

METROPOLIS (Gr. *μήτηρ*, mother, *πόλις*, city), properly a mother-city, and so the name of the parent state from which colonies were founded in ancient Greece (see GREECE, sect. *History, Ancient*). The word was used in post-classical Latin for the chief city of a province, the seat of the government, and in particular ecclesiastically for the seat or see of a metropolitan bishop (see METROPOLITAN). It is thus used now for the capital of a country, which contains the various official buildings of the administrative departments, the Houses of Parliament, &c. In the case of London, the term "metropolitan" is sometimes applied to the whole area including the "City of London," e.g. "Metropolitan Asylums Board"; and sometimes, as in "Metropolitan Police," excludes the City, which has its own police force (see LONDON).

METROPOLITAN (Lat. *metropolitanus*, Gr. *μητροπολίτης*), in the Christian church, the title of a bishop who has the oversight over bishops of subordinate sees. In the Western church

the metropolitan is practically the same as the archbishop (*q.v.*); in the Eastern church he ranks above the archbishop, but below the patriarch (*q.v.*). Metropolitans first appear in the East in the 4th century as presiding over a province (*provincia* or *επαρχία*), and their see is fixed in the principal town (*μυροπόλις*) of the province, which remains the normal custom both in East and West. In Africa, however, the metropolitan jurisdiction was exercised by the senior bishop (*primas, primae sedis episcopus, senex*) for the time being, a custom which prevailed for a time also in Spain. Thus, too, in the Scottish Episcopal Church and the Protestant Episcopal Church of America there are no metropolitans, the *primas* being the bishop.

METSU, GABRIEL (1630-1667), Dutch painter, was the son of Jacob Metsu, who lived most of his days at Leiden, where he was three times married. The last of these marriages was celebrated in 1625, and Jacomma Garnijers, herself the widow of a painter, gave birth to Gabriel in 1630. According to Houbraken Metsu was taught by Gerard Dow, though his early works do not lend colour to this assertion. It is certain, however, that he was influenced in turn by Jan Steen, Rembrandt, and Hals. Metsu was registered among the first members of the painters' corporation at Leiden; and the books of the guild also tell us that he remained a member in 1649. In 1650 he ceased to subscribe, and works bearing his name and the date of 1653 give countenance to the belief that he had then settled at Amsterdam, where he probably continued his studies under Rembrandt. One of his earliest pictures is the "Lazarus" at the Strassburg Museum, painted under the influence of Jan Steen. Under the influence of Rembrandt he produced the "Woman taken in Adultery," a large picture with the date of 1653 in the Louvre. To the same period belong the "Departure of Hagar," formerly in the Thoré collection, and the "Widow's Mite" at the Schwerin Gallery. But he probably observed that sacred art was ill suited to his temper, or he found the field too strongly occupied, and turned to other subjects for which he was better fitted. That at one time he was deeply impressed by the vivacity and bold technique of Frans Hals can be gathered from Lord Lonsdale's picture of "Women at a Fishmonger's Shop." What Metsu undertook and carried out from the first with surprising success was the low life of the market and tavern, contrasted, with wonderful versatility, by incidents of high life and the drawing-room. In no single instance do the artistic lessons of Rembrandt appear to have been lost upon him. The same principles of light and shade which had marked his schoolwork in the "Woman taken in Adultery" were applied to subjects of quite a different kind. A group in a drawing-room, a series of groups in the marketplace, or a single figure in the gloom of a tavern or parlour, was treated with the utmost felicity by fit concentration and gradation of light, a warm flush of tone pervading every part, and, with that, the study of texture in stuffs was carried as far as it had been by Ter Borch or Dow, if not with the finish or the *brio* of De Hooch.

Metsu went to Amsterdam before 1655, married in 1658, and became a citizen of that city in 1659. One of the best pictures of Metsu's manhood is the "Market-place of Amsterdam," at the Louvre, respecting which it is difficult to distribute praise in fair proportions, so excellent are the various parts, the characteristic movement and action of the dramatic personae, the selection of faces, the expression and the gesture, and the texture of the things depicted. Equally fine, though earlier, are the "Sportsman" (dated 1661) and the "Tavern" (also 1661) at the Hague and Dresden Museums, and the "Game-Dealer's Shop," also at Dresden, with the painter's signature and 1662. Among the five examples of the painter at the Wallace Collection, including "The Tabby Cat," "The Sleeping Sportsman," which cost Lord Hertford £3000, is an admirable example technically considered. Among his finest representations of home life are the "Repast" at the Hermitage in St Petersburg; the "Mother nursing her Sick Child" of the Steengracht Gallery at the Hague; the "Amateur Musicians" at the Hague Gallery; the "Duet" and the "Music Lesson" at the National Gallery, and many more examples at nearly all the leading European galleries.

METTERNICH-WINNEBURG, CLEMENS WENZEL LOTHAR, PRINCE (1773-1859), Austrian statesman and diplomatist, was born at Coblenz on the 15th of May 1773. His father, Count Franz Georg Karl von Metternich-Winneburg zu Beilstein¹ (d. 1818), was a diplomatist who had passed from the service of the archbishop-elect of Trier to that of the court of Vienna; his mother was Countess Maria Beatrix Aloisia von Kageneck. At the time of Clemens Metternich's birth, and for some time subsequently, his father was Austrian ambassador to the courts of the three Rhenish electors, and the boy was thus from the first brought up under the influence of the tone and ideas which flourished in the small German courts that lay within the sphere of influence of the France of the *ancien régime*. In 1788 he went to the university of Strassburg, where he studied German constitutional law; but the outbreak of the French Revolution caused him to leave after two years. Metternich was a witness of the excesses of the mob in Strassburg, and he ascribed his life-long hatred of political innovation to these early experiences of the victory of liberal ideas. In 1790, by way of striking contrast, he was deputed by the Catholic bench of the Westphalian college of counts to act as their master of the ceremonies at the coronation of the Emperor Leopold II. at Frankfurt, a function which he again performed at the coronation of Francis II. in 1792. The intervening time he spent at Mainz, attending the university and frequenting the court of the archbishop-elect, where his impressions of the Revolution were strengthened by his intercourse with the French *émigrés* who had made it their centre. The outbreak of the revolutionary war drove him from Mainz, and he went to Brussels, where he found employment in the chancery of his father, at that time Austrian minister to the government of the Netherlands. Here, in August 1794, he issued his first publication, a pamphlet in which he denounced the "shallow pates" of the old diplomacy and argued that the only way to combat the French revolutionary armies was by a *levée en masse* of the populations on the frontier of France—singular views for the statesman who was destined to be the last great representative of the old diplomacy and the greater part of whose life was to be spent in combating the national enthusiasms by which the revolutionary power of France was ultimately overthrown.

After a long stay in England, where he made the acquaintance of the prince of Wales (afterwards George IV.), Metternich went to Vienna; and on the 27th of September 1795 he married at Austerlitz the Countess Eleonore von Kaunitz, a grand-daughter of that Austrian chancellor who in many respects was his prototype. This alliance not only brought him great estates in Austria, but introduced him into the most exalted circles of Viennese society. Here he was well qualified to hold his own by reason of his handsome presence, the exquisite courtesy of his address and a certain reputation for gallantry. He was far, however, from being a mere carpet diplomatist. His interests were many and varied, and he found time for the serious study of natural science and medicine. In December 1797 he was chosen by the Westphalian counts as their representative at the congress of Rastadt, where he remained till 1799. This was his first experience of the great world of practical politics and especially of those rough diplomatists of the Revolution of whom in his letters he has left so vivid a description. In January 1801 he was appointed Austrian envoy to the elector of Saxony. His two years' stay at the court of Dresden was mainly useful to him by bringing him into touch with the many Russian and Polish families of importance; his serious diplomatic career did not begin till his appointment, in November 1803, as ambassador at Berlin. His instructions at the outset were to

¹ The family of Metternich, originally established in the county of Jülich, can trace its descent to the middle of the 14th century. In 1637 they received from the archbishop of Trier the countships of Winneburg and Beilstein. These were confiscated in 1803, and the lands of the suppressed abbey of Ochsenhausen, with the title of prince of the Empire, were granted by the emperor as compensation. The new principality was "mediatized" in 1806 in favour of Württemberg; but in virtue of their short tenure of it the descendants of Prince Metternich enjoy the privileges of mediatized princes.

prevent Prussia from joining the alliance of Russia and Great Britain against the French Republic and to make himself agreeable to the representative of France; but shortly afterwards his part was exactly reversed, owing to the shifting of political forces which led to the war of the third coalition, and he laboured to secure the adhesion of Prussia to the alliance of Austria, Russia and Great Britain against Napoleon. His diplomacy was not successful; for though Prussia ultimately signed the treaty of the 5th of November 1805 with Austria and Russia, the influence of the emperor Alexander and the wound given to her pride by Napoleon's contemptuous violation of her territory had more to do with Prussia's decision than Metternich's veiled threats. His reward was the grand cross of the order of St Stephen and the appointment of ambassador at St Petersburg; but his commission to make himself agreeable to the French ambassador at Berlin was carried out to such excellent effect that, as a result of M. Laforest's reports, Napoleon requested that he might be appointed to represent Austria at the Tuileries, and in August 1806 Metternich took up his residence as ambassador in Paris.

This was the beginning of his ever growing influence in European affairs. Established in the diplomatic character of an "honourable spy" in the very centre of Napoleon's power, he used his exceptional gifts of fascination not only to become a *persona grata* at the Tuileries, but to establish relations with those elements in the society of the empire which were already intriguing against Napoleon's power. His intimacy with Talleyrand and with Caroline Murat, Napoleon's sister, was destined to produce notable results later. Though on the look-out, however, for any chance of weakening the French emperor's power, Metternich was not at first sanguine of success, for he believed Napoleon to be invincible. For Austria the best policy seemed to him to be to temporize; he was willing, therefore, to co-operate with France in the agreement made between Napoleon and Alexander I. of Russia at Tilsit for the partition of the Ottoman Empire; failing the success of the efforts of Austrian diplomacy to break the Franco-Russian alliance, this would at least secure for the Habsburg monarchy a share of the spoils. With the postponement of Napoleon's Oriental schemes, however, the situation was once more changed. During the summer of 1808 Metternich had reason to suspect fresh designs of the French emperor against Austria, and his suspicions appeared to be confirmed when, during an interview on the 15th of August, Napoleon indulged in one of his violent tirades, denouncing Count Stadion's action in strengthening the Austrian armaments. In November Metternich was at Vienna, urging the Austrian government to an early declaration of war—for which the moment seemed to him opportune owing to the French losses in Spain, of which he had received exaggerated reports. On the 1st of January 1809 he was back in Paris, but no longer as a *persona grata*. At the outbreak of the war he was placed under arrest, in retaliation for the action of the Austrian government in interning two members of the French embassy in Hungary; and in June, on Napoleon's capture of Vienna, he was conducted there under military guard. In July he was exchanged at Komárom for the French diplomatists, and he was present with the emperor Francis at the battle of Wagram. At a council held on the 7th of July it was decided, on Metternich's initiative, to open negotiations for peace; next day Stadion tendered his resignation, which was provisionally accepted. Stadion was sent as diplomatic adviser to the headquarters of the archduke Charles, while Metternich took his place at the emperor's side. On the 4th of August Metternich was named minister of state, and soon afterwards was sent with Count Nugent to the peace conference at Altenburg, where Chamagny attended as Napoleon's representative. The conference, however, dragged on without result, and the emperor Francis decided to open negotiations with Napoleon direct. Count Bubna was accordingly sent to Schönbrunn; the result was the French ultimatum which issued in the treaty of Schönbrunn (Vienna), signed by Prince Liechtenstein on behalf of the emperor Francis on the 14th of October 1809. With the negotiation and signature of this humiliating

instrument Metternich therefore had nothing to do, though on the 8th of October he had been definitely appointed minister for foreign affairs, an office he was destined to hold for nearly forty years.

The position of the new minister was no easy one. By the treaty of Schönbrunn Austria was reduced to the position of a second-rate power, and by secret articles undertook during the continuance of the maritime war to limit her force of all arms to 150,000 men, and to dismiss from her service all officers or civil officers born in the territories of ancient France, Piedmont or the former Venetian republic. Weak as she had become, the menace of the future seemed even more disquieting. To the south she was divided from the French dominions by the Save; to the west and north the vassal states of France, traditionally her enemies, lay along the frontier; to the east was Russia, which as the reward for her alliance with Napoleon had received a portion of East Galicia as her share of the spoils, and to all appearance was firmly established in the Danubian principalities. Austria seemed hopelessly cut off by Napoleon from any chance of re-asserting her traditional preponderance in Germany, by Russia from any prospect of obtaining compensation at the expense of the Ottoman Empire. One false move on the part of those who guided its destinies, and the Habsburg monarchy might easily have ceased to exist altogether.

The saving factor in the situation was the improbability of the alliance between Napoleon and Alexander continuing, and the immediate task of Metternich was to hasten its dissolution, while securing Austria's safety in the East by bringing about the end of the Russo-Turkish War. It was a task of extreme delicacy; for any revelation of its true tendency might have thrown the emperor Alexander into the arms of France and plunged Austria into an unequal struggle for life and death with Russia on the banks of the Danube. Metternich was helped by the rapid development of the causes of disagreement between the French and Russian emperors. Early in 1810 Europe was full of contradictory rumours of war between France and Russia, of a marriage of Napoleon with a Russian grand duchess. Then suddenly came Napoleon's formal request for the hand of the Austrian archduchess Marie Louise. A proposal so nicely calculated to forward Metternich's plans was suspected of being due to his inspiration; certainly it was his influence that decided the emperor Francis to agree to an alliance which could not but be distasteful to him and was resented as a crowning humiliation by the proud aristocrats of Vienna.

On the 13th of March 1810 Metternich left Vienna for Paris in company with the archduchess. His object was to use so favourable an occasion for obtaining the abrogation of some of the more onerous articles of the treaty of Schönbrunn, and for coming to some arrangement whereby the serious inconvenience caused in Austria by Napoleon's coercion of the pope might be obviated. His diplomacy, however, met with but slight success. His efforts to persuade Pius VII. to purchase a measure of liberty of action by concessions to Napoleon broke down on the gentle old man's refusal to traffic with his principles. From Napoleon he extracted a lame apology for the execution of Andreas Hofer, the reversal of a few sequestrations and, as a crowning grace, the abrogation of the article of the Schönbrunn treaty limiting Austrian armaments. In the matter of restoring the access of Austria to the Adriatic, Napoleon would make no concession; his answer to Metternich's representations was only a commercial treaty which failed to obtain ratification at Vienna. Anything further, e.g. an exchange of the Illyrian provinces for Galicia, must depend on the attitude of Austria in the forthcoming Russian war which, in an interview of the 20th of September, Napoleon declared to be now inevitable.

On the 10th of October Metternich was back in Vienna, where his presence was urgently needed. The policy of a Franco-Austrian *entente* was popular with the public and the army, resentful of the treacherous attitude of Russia in the late war, but in the powerful circles of the court it had scarce an adherent. Prince Metternich himself, who had acted as foreign secretary during his son's absence, favoured an understanding with Russia,

and was even believed to be intriguing to retain the portfolio of foreign affairs, which would have meant the victory of the Russian party. On the other hand, the French party were clamouring for the speedy conclusion of a definite alliance with Napoleon. By an admirably clear *exposé* of the situation Metternich won over the emperor Francis to that middle course, the policy of armed abstention, which was to be the basic principle of his diplomatic action during the crisis of the coming years. An alliance with Russia, he argued, would be worse than useless; Austria would at any time obtain better terms from the tsar's growing needs. An alliance with France would be one with "a power whose exclusive object is the destruction of the old order of things, which has hitherto found its defence in Austria." Alone of European Powers Austria still had the possibility of choice; let her work for the preservation of peace and at the same time remain free, should war break out, to make her own terms. It would little serve Austria's interests to become the ally of Russia, merely to serve as a barrier behind which the emperor Alexander could carry out his designs on Turkey in safety. In an interview with Count Shuvalov, the Russian agent, Metternich roundly declared that the maintenance of the integrity of Turkey was for Austria the question of supreme interest.

With the approach of the Russo-French War the situation became increasingly difficult. The partisans of a Russian alliance remained powerful and clamorous; but Metternich did not share the doubts as to the outcome of Napoleon's invasion of Russia, which he believed would leave Austria, if she remained neutral, isolated amid a huge European confederation. To him the only safe course seemed to be to offer the French emperor substantial assistance, stipulating for some *quid pro quo* in the settlement to follow the war. The emperor Francis shared this view; and on the 14th of March a treaty of alliance was signed by which Austria agreed to support the French army with an army corps of 30,000 men operating from Galicia. This treaty was ratified at Vienna on the 25th of March, the day of Napoleon's passage of the Niemen. It was characteristic of Metternich's diplomacy that the Austrian generals in Galicia were ordered to act only on the defensive, and that the court of St Petersburg was informed that Austria would only take part in the war as a principal should Russia force her to do so.

This cautious attitude was soon justified by the astounding developments of the Moscow campaign. When the full extent of the catastrophe that had overwhelmed Napoleon's army became known, Metternich realized the advantageous position in which Austria lay for exploiting the changed situation. His first idea was that France should commission Austria to mediate a peace in Russia and in England (Despatch of Otto, November 20); but, as affairs developed, this was replaced by the policy of temporizing until Austria should be in a position to intervene with decisive effect. Napoleon's demand that Austria should raise her contingent from 30,000 to 100,000 men was, indeed, from Metternich's point of view doubly opportune: for it enabled him quietly to assume that the treaty of the 14th of March, which stipulated only for an "alliance limitée," had been abrogated by Napoleon's own act; that Austria had reverted to a position of neutrality; and that, should she take part in the war, it would no longer be in a subordinate character but as a principal. "Le passage de la neutralité à la guerre," said Metternich to the emperor Francis, "ne sera possible que par la médiation armée"; which meant in effect that Austria required time to complete her armaments. To gain this time was, during the weeks that followed, the object of his diplomacy. For this purpose he encouraged Napoleon to believe that Austria was prepared for a settlement on terms very favourable to the French emperor; with the result that Napoleon, though he would not hear of a "mediation," not only consented to, but pressed for, Austrian "intervention" (*entremise*). But Metternich had made up his mind that the only chance of an effective restoration of the Habsburg influence in Europe lay in using this opportunity for destroying or limiting Napoleon's power,

and he had already opened negotiations with the allied courts, with a view to enforcing a common agreement as to a basis of peace, when the indecisive battle of Lützen (May 2) gave him the opportunity of making his policy of mediation effective. Count Stadion was now sent to the emperor Alexander to lay before him the terms on which Austria was prepared to mediate; he was also to "agree to the bases of an active military co-operation on our part, in the event of the non-success of our efforts on behalf of peace." On the 20th of March Napoleon gained another indecisive victory at Bautzen, which still further strengthened Metternich's position; for Napoleon allowed himself to be persuaded into signing the ill-omened armistice of Pleiswitz (Poischwitz), on the 4th of June, and to become entangled in the insincere negotiations of the congress of Prague. Austria thus had time to complete her armaments. Meanwhile, on the 14th and 15th of June, were signed at Reichenbach the treaties of alliance between Great Britain, Russia and Prussia, by which the signatory Powers agreed neither to negotiate nor to conclude treaty or truce with Napoleon except by common consent. In an interview with the emperor Alexander, Metternich now presented the terms which he proposed to offer to Napoleon, and on this basis a treaty between Austria, Russia and Prussia was agreed to, Austria contracting to put 150,000 men into the field, should Napoleon reject the ultimatum, and not to make peace without the consent of Russia and Prussia—which in effect involved that of Great Britain also.

Before this second treaty of Reichenbach was signed (June 27), Metternich went on Maret's invitation to Dresden, where on the 26th he had the famous interview with Napoleon. The whole scene was on his part a masterpiece of Machiavellian diplomacy. The terms he offered to the emperor were so favourable that he has been denounced by every Prussian historian since as the enemy of Germany; while French historians have enlarged on Napoleon's infatuation in rejecting them. In spite of the fact that the draft of the treaty of Reichenbach was in his pocket, he posed as the impartial "mediator," with a leaning in favour of Napoleon, assuring the emperor "on his honour as a German count" that Austria was still "free from all engagements," which was true only in so far as the treaty was not signed till the next day. Metternich's object was, in fact, only to gain an extension of the armistice till the 10th of August, on which date Schwarzenberg had declared that he would be ready to take the offensive. As for the terms offered to Napoleon his acceptance of them need not hamper the plans of the Allies; for the consent of Great Britain would have to be obtained, and, moreover, Napoleon was sure before long to provide an excuse for a fresh breach; his rejection of them, on the other hand, would be a blow to his waning popularity in France. The interview was long and stormy; Napoleon struggled vainly in the toils; in his excitement he dropped his hat, which the imperturbable Metternich did not condescend to pick up; "Napoleon," he records in his *Memoirs*, "seemed to me small." Metternich, however, gained his immediate point; the armistice was extended to the 10th of August. At midnight on that date, Napoleon not having come to terms, Metternich gave orders for the lighting of the beacons that signalled to the Austrian army in Silesia the outbreak of the war.

Napoleon's victory at Dresden (Aug. 26 and 27) for the moment brought discord into the counsels of the Allies and threatened the ruin of Metternich and his plans; but the successive defeats of Vandamme at Kulm (Aug. 28), of Macdonald at Katzbach (Aug. 29) and Oudinot at Grossbeeren (Aug. 30) completely altered the aspect of affairs; and on the 9th of September Metternich signed at Töplitz a treaty with Russia which committed Austria yet more closely to the policy of the Allies. Then followed the battle of Leipzig (Oct. 16-18) and the advance of the Allies into France. The diplomatic situation throughout the campaign was, from the Austrian point of view, one of extreme delicacy. The necessity of curbing the power of Napoleon and rendering him for ever incapable of again upsetting the balance of Europe was practically the only object Austria had in common with her allies. She did not

share the implacable resentment with which Great Britain pursued Napoleon; she watched with alarm the development of the ambitions of Alexander I., which threatened to substitute a Russian for a French supremacy in Europe; she was far from sympathizing with the noisy enthusiasm of the patriots of the War of Liberation for a united Germany, in which the traditional influence of the Habsburgs would be balanced or overshadowed by that of Prussia. Metternich had no wish to see the husband of Marie Louise ousted in favour of the Bourbons, who had little reason to be grateful to Austria; still less did he desire to see on the throne of France Alexander's protégé Bernadotte, whose name was being whispered in the Paris salons as the destined saviour of his native country. But if Napoleon was to remain sovereign of France, it must be not by his own force, but by grace of his father-in-law, and hedged round with limitations which would have made him little more than the lieutenant of the Habsburg monarchy. This was the secret of the moderate terms of accommodation ostentatiously offered by Metternich to Napoleon at various stages of the campaign. From Frankfort he sent, through General de Saint-Aignan, a diplomatist on whose indiscretion he could rely, an informal offer of peace on the basis of France's "natural frontier," the Rhine, the Alps and the Pyrenees. The famous manifesto of Frankfort, issued on behalf of the Allies (Dec. 4, 1813), contained no such offer of acceptable terms; but Metternich's object was attained; for Napoleon refused to be drawn into the trap, and the French people cursed the emperor's infatuation in refusing a settlement which, from what had leaked out of Saint-Aignan's mission, they believed would have satisfied the legitimate ambitions of France. On the other hand, Metternich did his best to oppose a too rapid advance of the allied forces on Paris, which would have played into the hands of Russia and Prussia; and it was to his initiative that the conferences of Châtillon were due. Only when the breakdown of the negotiations made it clear that Napoleon had seen through his plans, and preferred the chances of war to the certainty of ruin or of surviving only as the puppet of Austria, did Metternich join with Castlereagh in pressing upon the tsar the necessity for restoring the Bourbons. On the 1st of March 1814, he set his hand to the treaty of Chaumont, of which the immediate object was the restoration and preservation of the old dynasty in a France reduced to her "legitimate frontier." In other respects, however, the treaty was a triumph for Metternich; for it laid down that at the final settlement Germany was to be reconstituted as a confederation of sovereign states, and it also did much to temper the fear of a Russian dictatorship by consecrating the principle of that concerted action of the Great Powers, in affairs of international interest, which after Napoleon's fall was to govern the European system. On the 10th of April Metternich arrived at Paris, ten days after its occupation by the Allies. He was now at the height of his reputation; on the 20th of October 1813, two days after Leipzig, he had been created an hereditary prince of the Austrian Empire; he now received from the emperor Francis a unique honour: the right to quarter the arms of the house of Austria-Lorraine with those of Metternich. At the same time (April 21) the countship of Daruvár was bestowed upon him. On the 30th of May Metternich set his signature to the treaty of Paris, and immediately afterwards accompanied the emperor Alexander and King Frederick William on a visit to England. On the 18th of July he was back in Vienna, where the great congress was to meet in the autumn. The dignity of a Hungarian magnate was bestowed upon him before it assembled.

At the congress Metternich's charm of manner and great social gifts gave him much personal influence; the ease and versatility with which he handled intricate diplomatic questions, too, excited admiration; at the same time he was blamed for his leaning to intrigue and *finesse* and for a certain calculated disingenuousness which led to an open breach with the emperor Alexander, who roundly called him a liar. In the difficult questions of Poland and Saxony the honest and conciliatory attitude of Castlereagh was of more avail in reaching an accept-

able settlement than all Metternich's cleverness. If in the Italian and German questions, however, Austria's views triumphed, this was due to the foresight displayed in Metternich's diplomacy during the campaigns and to the address with which he handled the questions at issue at the congress. The complacency of Hardenberg had allowed Austria alone to negotiate with the states of the Confederation of the Rhine with a view to detaching them from Napoleon; and he had used this opportunity to render impossible the idea of a united Germany. On the 8th of October 1813 he had signed with Bavaria the treaty of Ried, which in the event of the liberation of Germany guaranteed to Bavaria a sovereign and independent status. This instrument, which was reinforced by a secret treaty signed at Paris on the 3rd of June 1814, served as a model for similar agreements with other courts; and the principle involved was, as mentioned above, included in the treaty of Chaumont. Thus all the unionist ideals, represented at the congress by Stein, were sterilized from the outset; and the Act of Confederation embodied in the Final Act of Vienna gave to Germany exactly the form desired by Metternich as best calculated to perpetuate Austrian preponderance (see GERMANY: *History*). The same was true of the settlement of Italy. The question here was complicated by the treaty of alliance signed by Metternich with Murat as the price of his treason to Napoleon. But Metternich from the first had known that the treaty was but a temporary expedient; that Great Britain would never recognize "the person at the head of the government of Naples"; and that sooner or later Murat himself would afford excuse enough for tearing the treaty up. Not Murat's dream of an Italy united under his own rule, but the traditional Austrian policy of possession in the north and preponderance throughout the Peninsula was Metternich's goal, and this he secured at the congress. Murat, in view of Austria's engagements, was suffered to survive for the time being; he himself shattered the alliance during the Hundred Days; and the Bourbons returned to Naples, pledged by a secret agreement to attune their policy to that of Vienna (see NAPLES: *History*).

Metternich, then, emerged from the congress of Vienna confirmed in the confidence of his sovereign, and therefore supreme in Germany and in Italy. To him had been due the marvellous recovery of the Habsburg monarchy; in spite of Gentz's lament that in the latter stages of the campaign of 1814 "Europe" had been substituted for "Austria" in his diplomacy, Metternich had acted throughout first and foremost in the interests of Austria, as he was bound to do. This, too, gives the key to his policy after 1815, the policy of using the European concert, established by the treaty of Chaumont and the Paris treaty of the 20th of November 1815, as an instrument for ensuring the "stability" of Europe by suppressing any "revolutionary" manifestations by which the settlement made at Vienna might be endangered.

After the campaign of Waterloo and Napoleon's second downfall Metternich was again in Paris, where he co-operated with the emperor Alexander and Castlereagh in securing tolerable terms of peace for France. A few days after the signing of the two treaties of the 20th of November 1815, he left Paris for Milan, where he met the crown prince Louis of Bavaria and Baron von Rechberg, with whom he came to terms on certain outstanding questions between Austria and Bavaria, terms embodied in the treaty of Munich of the 14th of April 1816. During his visit to Italy, which he repeated in 1816 and 1817, Metternich could not but be impressed with the general signs of discontent with Austrian rule. Neither was he blind to the true causes of this discontent: the atrophy of the administration owing to its rigid centralization at Vienna, and the policy of enforcing Germanism on the Italians by a ruthless police system. He made half-hearted proposals for removing something of both these grievances; but his terror of revolution from below made him fearful of reforms from above. While therefore in Prussia king and ministers were labouring hard to remodel and consolidate the monarchy, Metternich did next to nothing to reform the most obvious abuses of the Austrian Empire. Yet the fault

was not wholly, or mainly, his. Sir Robert Gordon,¹ in a letter to Castlereagh (dated Florence, July 11, 1819), gives the true reason for this attitude: "How much is it to be desired that the superior talents of Prince Metternich were more occupied with the revision and improvement of the administration of affairs in his own country. He is too enlightened not to perceive its most palpable defect. . . . He might have courage to sacrifice himself for the institution of effective remedies, but he fears that the confiding benignity of his Sovereign might afterwards be dissuaded from the just and vigorous application of them." (F.O. Austria. Gordon. Jan.-Dec., 1819.) Metternich's power, after all, was limited by the goodwill of his master, the emperor Francis, and Francis trusted him precisely because he seemed to share his own fanatical hatred of all change. It is this fact that seems to explain Metternich's feverish anxiety to justify his obscurantist attitude to himself and to the world. It suited him to ascribe the general discontent, of which the causes were not obscure, to the wanton agitation of the "sects," and his agents all over Europe earned their pay by supplying him with plentiful proof of the correctness of his contention. The result was well summed up in another letter of Gordon to Castlereagh (ibid. No. 26, Florence, July 12, 1819). "Nothing," he writes, "can surpass Prince Metternich's activity in collecting facts and information upon the inward feelings of the people; with a habit of making these researches he has acquired a taste for them. . . . The secrecy with which this task is indulged leads him to attach too great importance to his discoveries. Phantoms are conjured up and magnified in the dark, which probably if exposed to light would sink into insignificance; and his informers naturally exaggerate their reports, aware that their profit is to be commensurate with the display of their phantasmagoria." The judgment is instructive, coming as it does from a diplomatist in intimate touch with Metternich and in general sympathy with his views.

There was, none the less, method in this madness. Behind the agitations of the "sects" loomed the figures of the emperor Alexander and of his confidant Capo d'Istria, "the Coryphaeus of Liberalism," whose agents, official or unofficial, were intriguing in every country in Europe, and not least in Italy. The factor, then, that determined Metternich's attitude was not so much a dread of revolutions in themselves as of revolutions exploited by the "Jacobin" tsar to establish his own preponderance in Europe. Metternich's object, then, in respect of the revolutionary agitations, was twofold: he wished to impress Alexander with the peril of this imperial coquetting with democratic forces; he wished to convince the "sects" that they could not rely on the tsar's support. He succeeded in both these objects during the period from the congress of Aix-la-Chapelle in 1818 to that of Verona in 1822. (See ALEXANDER I. OF RUSSIA; EUROPE: *History*.)

On his way to the congress of Aix, Metternich spent a few days at Frankfurt, where his presence was sufficient to settle the difficult question of the constitution of the federal forces. It was a signal triumph. "You can have no idea of the effect produced by my appearance at the diet," he wrote exultingly to his wife, "I have become a species of moral power in Germany and, perhaps, even in Europe" (*Mem.* iv. 64). This self-complacency was characteristic of the man; but, if we accept his view of "morality," the boast scarce seems exaggerated. In the main questions debated at Aix, indeed, it was Castlereagh's influence rather than that of Metternich which prevailed; the abolition of the supervision of French affairs by the committee of ambassadors was, for instance, carried against his opinion. But it was at Aix that Metternich was not only reconciled with Alexander, but laid the foundations of that personal influence over the tsar that was to bear notable fruit later; from Aix, too, where he arrived at a complete understanding with King Frederick William III. and the Prussian ministers, dates his preponderant influence in German affairs.

The outlook in Europe at the beginning of 1819 seemed to
¹ Sir Robert Gordon (1791-1847), brother of the 4th earl of Aberdeen, was between 1815 and 1821 associated with Wellington as minister plenipotentiary at Vienna.

Metternich particularly gloomy. In France the ministry of Decazes was, in his opinion, under the inspiration of the Russian ambassador Pozzo di Borgo, heading straight for a new revolution; in Italy Russian agents were openly carrying on a Liberal propaganda; Germany, and notably the Prussian bureaucracy, was honeycombed with revolutionary ideas. Then came the news of the murder of Kotzebue (March 23). Metternich was in Italy at the time; but he determined at once to take advantage of this senseless crime to carry his views in the matter of muzzling the Liberal agitation in Germany. In the summer he met King Frederick William and Prince Hardenberg at Töplitz; a conference that resulted in the indefinite postponement of the Prussian constitution and in a secret agreement (Aug. 1) on the proposals to be laid before a conference of German ministers to be held at Carlsbad in the same month. The result of this were the famous Carlsbad Decrees (*q.v.*), by which liberty of speech and of the press was abolished throughout Germany. The Vienna conferences that followed in November and issued in the Final Act of the 15th of May 1820, was not so complete a triumph for Metternich; but his diplomacy, none the less, had succeeded in riveting on Germany the yoke of the Austrian system, which it was to bear with but partial and temporary relaxations for nearly thirty years (see GERMANY: *History*).

The year 1820 was marked by critical events which drew Metternich's attention once more from the affairs of Germany to those of Europe at large. The revolution in Spain, with which Austria had no immediate concern, interested him little; but his attitude towards it is characteristic and illuminating. The emperor Alexander for whom the idea of the confederation of Europe was an article of faith, proposed a European intervention and offered to march a Russian army through northern Italy into Spain. Metternich, to whom the remedy seemed far worse than the disease, covered his dissent from this proposal with a great display of principle. "The ills of Spain were 'material,' those of Europe at large 'moral', and the European Alliance was there to deal with moral, not material, troubles. The revolution that followed in Naples, however, necessitated a different attitude. Strictly speaking, it concerned Austria alone; but Metternich was anxious to range Alexander openly against Italian Liberalism, and he therefore consented to the question being laid before a congress to be assembled at Troppau. The congresses of Troppau (1820) and Laibach (1821) are dealt with elsewhere (see EUROPE: *History*; ITALY: *History*, and the articles *s.v.*). For Metternich they represented a signal triumph. Not only did he complete his ascendancy over the emperor Alexander; but he openly committed all the Powers to an approval of the Austrian system in Italy, a success that outweighed his failure to win over Great Britain to the general principle of intervention enunciated in the Troppau Protocol. His attempt, however, to crown his system in Italy by setting up a central committee on the model of the Mainz commission was defeated at the congress of Verona (1822) by the opposition of the Italian princes headed by the pope and the grand duke of Tuscany.

The sort of moral dictatorship which Metternich had acquired on the continent was shattered by the developments of the Eastern Question. At first, indeed, the peril of a Russian attack on Turkey had drawn Austria and Great Britain closer together, and in a meeting at Hanover in October 1821 Metternich and Castlereagh had come to an understanding as to using the Holy Alliance to prevent Alexander from acting independently of the concert. But Metternich's hope that the Greek revolt would burn itself out "beyond the pale of civilization" was belied by events; and even before Castlereagh's death it was clear that Great Britain would have sooner or later to adopt a policy of intervention opposed to all Metternich's ideas. The breach was hastened by the accession to office of George Canning, who hated Metternich and all his ways. At Verona in 1822 the withdrawal of Great Britain from the system of the continental Allies was proclaimed to all the world; in March 1823 Canning recognized the Greek flag. This opened up the whole Eastern Question in the precise form that Metternich had sought to

avoid; for the action of Great Britain involved a move on the part of Russia, jealous of her prestige in the Levant, and thus led ultimately to a rearrangement of the relations of the Powers which, so far as the affairs of the Ottoman empire were concerned, left Austria isolated. It is impossible here even to outline Metternich's diplomacy during the eleven years between the outbreak of the Greek revolt and the signature of the treaty of London (1832) by which the kingdom of Greece was established. The principles that guided it are, however, sufficiently simple. In common with Great Britain he desired to maintain the integrity of the Ottoman Empire as a barrier against Russian domination in the Balkan peninsula; he wished also to avert a Russo-Turkish war, not only for the above reason, but also because this would involve the breakdown of the system by which he hoped to curb the revolutionary forces in the West. He therefore attempted, and for a while successfully, to persuade the tsar that the Greeks were only "expedient rebels against legitimate authority." But, when this expedient failed, he was the first to suggest the complete independence of Greece, which seemed to him less dangerous to Austrian interests than a tributary principality on the model of Moldavia and Wallachia. In the end his attitude was one of abstention and protest, since he rightly considered that the action of the Powers which culminated in the treaty of London was fatal to the doctrine of legitimacy, on which his system was based.

The Greek question was not finally settled when the outbreak of the revolutions of 1830 threatened the overthrow of the whole structure of 1815 in the West. Events which seemed to involve the complete ruin of Metternich's system gave it in effect, however, a new lease of life. Austria, isolated by the events in the East, was once more brought into touch with Russia by a crisis that concerned both Powers equally. On the receipt of the news of the July revolution in Paris Metternich hastened to meet Count Nesselrode at Carlsbad; and, though the Russian statesman refused to commit himself to the idea of an immediate reconstitution of a league of the three autocratic Powers, a common basis of action was agreed upon, and the foundations were laid for that cordial understanding that ripened in the meeting of Münchengrätz three years later. Meanwhile, though his language was still "European," Metternich's attitude towards the revolutions was wholly Austrian. He preached the sacred duty of intervention, but he refused to intervene, save where the interests of the Habsburg monarchy were directly concerned. He was even the first to recognize the revolutionary government of Louis Philippe (Sept. 8); he answered the appeal of the king of Holland for help with an ironical reference to the geographical situation of Austria; he did not even interfere with the revolutions in Germany and Poland. But when in Italy revolts broke out that threatened the Austrian hegemony, he acted with promptitude and decision, in spite of the threatening attitude of France; in the spring of 1831 Austrian bayonets restored order in Parma, Modena and the Papal States. Yet even here Metternich showed an unwonted moderation: not only did he soon withdraw the Austrian troops from Ancona, but he took the initiative in impressing on the papal government the urgent necessity for drastic reform. This attitude was, indeed, mainly determined by the uncertainty as to the relations of the three autocratic courts on whose co-operation the effectiveness of a policy of repression ultimately depended; and Metternich's next work was to attempt to re-cement the broken alliance. With Prussia he had little difficulty; the timidity of King Frederick William III. had increased with years and the events of 1830, and the Prussian and Austrian governments came to complete understanding on a common policy in Germany. Its first fruits were the additional articles appended by the Federal Diet (June 28, 1832) to the Vienna Final Act, by which the control of the diet over the state legislatures was increased. As for Russia, Count Nesselrode at first maintained the reticent attitude he had adopted at Carlsbad; but finally, in 1833, Metternich met the emperor Nicholas I. himself at Münchengrätz and by adroit flattery won him over to his views. The Berlin convention of the 15th of October 1833, which reaffirmed

the divine right of intervention, was a fresh triumph for Metternich's diplomacy. This had been rendered possible by the change in Russia's attitude towards the Turkish question after 1829, which made a co-operation of Austria and Russia possible in the East (see MEHEMET ALI); and in its turn it made possible the maintenance for a while longer of the Austrian system in Germany.

The convention of Berlin marked the last conspicuous intervention of Metternich in the general affairs of Europe. "The Holy Alliance of the East," as Palmerston called it, served the immediate purpose of securing "stability" in the countries immediately subject to the Powers composing it; it made no attempt at more than "moral" intervention in questions, e.g. that of Spain, that lay beyond its own sphere of influence; and the development of the Eastern Question, leading to the rapprochement between Russia and Great Britain, though Austria joined the Quadruple Alliance of 1840, tended to loosen the cordial ties between the courts of Vienna and St. Petersburg. The Straits Convention of 1841, by which France was formally readmitted to the concert, was due largely to Metternich's initiative; so, too, was the ill-judged effort of the continental Powers in 1847 to interfere in favour of the *Sonderbund* in Switzerland. But, on the whole, the growing crisis within the Habsburg monarchy itself was sufficient to deter Metternich from foreign adventures. So long as the emperor Francis lived all question of reform was impossible, and when he died, in 1835, the rusty machinery of the Austrian administration was too completely out of gear to be set right by anything short of a complete reconstruction, to which Metternich was too old to set his hand, even had he had the inclination to do so. He was too experienced not to realize the sickness of the state, but he was content to veil it from himself and to attempt to veil it from others. The world was not deceived; but it was not until the Vienna mob, in 1848, was thundering at the door of his cabinet that Metternich himself realized the truth to which he had tried to blind himself. With his fall his system also fell; and his flight from Vienna was the signal for the revolutions by which in 1848 all the countries under Habsburg influence were convulsed.

The resignation of Prince Metternich, handed in on the 13th of March 1848, was accepted by the emperor on the 18th, and the prince and his family at once left for England. Here he lived in great retirement, at Brighton and London, until October 1849, when he went to Brussels. In May 1851 he went to his estate of Johannesberg, where he was visited by King Frederick William IV. and Bismarck; in September he returned to Vienna. The events of 1848 had not shaken his self-complacency; they seemed to him rather to confirm the soundness of his own political principles, which would have scotched the evil betimes had not the weakness of others allowed the forces of disorder to gather strength. But though, in his own opinion, triumphantly vindicated, he did not again take office; he maintained, none the less, as a critic and adviser no mean influence on the counsels of the Austrian court, though it was contrary to his advice that Austria signed the treaty of the 2nd of December 1854 with France and Great Britain. He lived to see the beginning of the struggle of France and Italy against Austria, dying on the 11th of June 1859.

Probably no statesman of all time has, in his own day, been more becalmed with praise and bespattered with abuse than Metternich. By one side he was revered as the infallible oracle of diplomatic inspiration, by the other he was loathed and despised as the very incarnation of the spirit of obscurantism and oppression. The victories of democracy brought the latter view into fashion, and to the Liberal historians of the latter part of the 19th century the name of Metternich was synonymous with that of a system in which they could recognize nothing but a senseless opposition to the forces of enlightenment. A juster estimate of the man and his work has, however, become possible as the age has moved farther away from the smoke of controversy. On the whole, history has tended to endorse the sane judgment on Metternich pronounced by Castlereagh when

he was first brought into diplomatic contact with him. Writing from Chaumont to Lord Liverpool, on the 26th of February 1814, he said: "Austria both in army and government is a timid Power. Her minister is constitutionally temporizing—he is charged with more faults than belong to him, but he has his full share, mixed up, however, with considerable means for carrying forward the machine, more than any other person I have met with at Head Quarters" (F. O. 2 France, *From Lord Castlereagh*). This gives the key to Metternich's character and policy: Austria was a timid Power, and Metternich was an Austrian minister. His policy of "stability," so necessary for the Habsburg monarchy, at least secured a long period of peace for Europe at large. Europe, her strength renewed, passed a severe judgment on the statesman who acted on the assumption that what the generality of people wanted was peace, not liberty; and justly, in so far as his pessimism led him to convert what might have been legitimate as a temporary counsel of expediency into an immutable principle. But, as Demelitsch points out, it will be time for *Austrians* to condemn him when Austria shall have survived half a century of constitutional experiment under the dual monarchy.

Of the technique of diplomacy Metternich was a master. His despatches are models of diplomatic style. If they have any fault, it is that they are often over-elaborate, the work of a man who evidently loves diplomacy for its own sake and glories in the fine turn of a phrase. In this respect they are comparable to those of Canning, who modelled himself upon Chateaubriand; they are in vivid contrast to the crabbed businesslike letters of Castlereagh. Metternich almost invariably begins his despatches and his reports with a broad discussion of the principles involved in the case in point, and argues from these down to the facts. In this again he is in sharp contrast with Castlereagh, who, with characteristic British practical sense, politely sweeps the principles aside and prefers to argue upward from the facts. Yet Metternich's phrase-making was often the result of astute calculation. His diplomatic genius was never so well displayed as in disguising perilous issues in phrases that soothed even when they did not convince; and, like Gladstone after him, when the occasion demanded it, he was master of the art of appearing to say much when in fact he said nothing. When he wished to make his meaning plain, no one could do so more clearly; when he wished to be reticent, no reticence could have been more pleasingly eloquent.

In private life Metternich was a kind, if not always faithful, husband and a good father, devoted to his children, of whom he had the misfortune to lose several before his death. He was three times married. His second wife, Baroness Antonie von Leykam, Countess von Beilstein, died in 1820; his third wife, Melanie, Countess Zichy-Ferraris, died on the 3rd of March 1854. Of his sons three survived him: Richard Clemens Lothar (1829-1895), his son by his second marriage, who was Austrian ambassador in Paris from 1859 to 1871; Prince Paul (1834-1906), and Prince Lothar (1837-1904), his sons by his third marriage. His grandson Prince Clemens (b. 1866), son of Prince Paul, married in 1905 Isabella de Silva Carvajal, daughter of the marquis de Santa Cruz.

BIBLIOGRAPHY.—A vast mass of unpublished material for the life of Prince Metternich exists in public and private archives; to some of those in the F. O. Records references are given in the bibliography to chap. 1. of vol. x. of the *Cambridge Mod. Hist.* Of published documents the most important are in the collection *Aus Metternichs nachgelassenen Papieren* (8 vols., 1880-1884), edited by his son, Prince Richard Metternich. There is a complete French translation issued contemporaneously, and an English version, of which only five volumes (down to 1835) have been published, under the title *Memoirs, &c.* (London, 1880-1882). These *Memoirs*, especially the autobiographical parts, must be read with considerable reserve; even the official letters and documents, which are their most valuable contents, have been to a certain extent "edited." See also Count Anton Prokesch-Osten (the younger) *Aus dem Nachlass von Prokesch-Osten* (2 vols., Vienna, 1881); the writings and correspondence of Friedrich von Gentz (*q.v.*), especially as collected under the title *Oesterreichs Theilnahme an den Befreiungskriegen*; Wilhelm Oncken, *Oesterreich und Preussen im Befreiungskriege (1876-1879)*; A. Beer, *Zehn Jahre oesterreichischer Politik, 1801-1810 (1877)*; *Die Finanzen Oesterreichs* (1883); *Die orientalische Politik*

Oesterreichs seit 1774 (1883); T. T. de Martens, *Recueil des traités, &c.*, vols. iii. and iv.; Thiers, *Hist. du consulat et de l'empire*, which was frequently commended by Metternich himself as giving an accurate account of his policy, a statement, however, controverted by Albert Sorel, whose *L'Europe et la révolution française*, gives a detailed and masterly account of Metternich's share in the overthrow of Napoleon. Fedor von Demelitsch's *Fürst Metternich und seine österreichische Politik*, vol. i., to 1812 (Munich, 1898), is an elaborate and useful analysis of Metternich's foreign policy, based on a large mass of unpublished archives. The best short biography of Metternich is that by A. Beer in *Der neue Plutarch* (1877), vol. v.; but both this and Colonel G. B. Mallison's *Life of Metternich* (London, 1888) were written before the publication of the important works of Demelitsch and Sorel. (W. A. P.)

METZ, a town, first-class fortress and episcopal see of Germany, in the imperial province of Alsace-Lorraine, capital of (German) Lorraine, on the Moselle, 99 m. N.W. of Strassburg by rail, and at the radiation of lines to Luxemburg, Coblenz and Novéant, on the French frontier (10½ m. W.). Pop. (1905), 60,396. The general appearance of the town is quaint and irregular, but there are several handsome modern streets. The Moselle, which is here joined by the Seille, flows through it in several arms, and is crossed by fourteen bridges. In the south-west corner of the town is the esplanade, with an equestrian statue of the emperor William I., and monuments to Prince Frederick Charles and Marshal Ney, commanding a fine view of the "pays messin," a fertile plain lying to the south. Of the ten city gates the most interesting are the Porte d'Allemagne, or Deutsche Tor, on the east, a castellated structure erected in 1445 and still bearing traces of the siege by Charles V.; the Porte Serpenoise, or Römer Tor, on the south, and the Porte Française, or Französische Tor, on the west. Among its ecclesiastical edifices (nine Roman Catholic and four Protestant churches) the most noteworthy is the Roman Catholic cathedral, with huge pointed windows, slender columns and numerous flying buttresses, which, begun in the 13th century and consecrated in 1546, belongs to the period of the decadence of the Gothic style. The Gothic churches of St Vincent and St Eucharius, and the handsome Protestant garrison church, completed in 1881, also deserve mention. Among secular buildings the most important are the town-hall, the palace of justice, the theatre, the governor's house, and the various buildings for military purposes. The public library contains 40,000 volumes, including an extensive collection of works relating to the history of Lorraine. In the same building is the museum, which contains a picture gallery, a numismatic cabinet, and a collection of specimens of natural history. Metz also possesses several learned societies, charitable institutions and schools, and a military academy. The cemetery of Chambière contains the graves of 7200 French soldiers who died here in 1870. The chief industries are tanning and the manufacture of weapons, shoes, cloth, hats and artificial flowers. There is a trade in wine, beer, wood and minerals.

As a fortress, Metz has always been of the highest importance, and throughout history down to 1870 it had never succumbed to an enemy, thus earning for itself the name of *La pucelle*. It now ranks with Strassburg as one of the two great bulwarks of the west frontier of Germany. The original town walls were replaced by ramparts in 1550, and the citadel was built a few years later. By 1674 the works had been reconstructed by Vauban. Under Napoleon III. the fortress was strengthened by a circle of detached forts, which, after 1870, were modified and completed by the Germans, who treated the fortress as the principal pivot of offensive operations against France. The plans in FORTIFICATION AND SIEGE-CRAFT (fig. 43) show Metz as it was about 1900; in the years following a new outer chain of defences was constructed, which extends as far as Thionville on the north side and has its centre in front of Metz on the Gravelotte battlefield. The old enceinte (which includes Cormontaigne's forts—Moselle and Bellevroix) is doomed to demolition, and has in part been already removed. The garrison, chiefly composed of the XVI. Army Corps, numbers about 25,000. (See GERMANY: Army.)

History.—Metz, the Roman *Mediodurum*, was the chief town of the *Mediomatrici*, and was also called by the Romans

Mediomatrica, a name from which the present form has been derived by contraction. Caesar describes it as one of the oldest and most important towns in Gaul. The Romans, recognizing its strategic importance, fortified it, and supplied it with water by an imposing aqueduct, the remains of which still exist. Under the Roman emperors Metz was connected by military roads with Toul, Langres, Lyons, Strassburg, Verdun, Reims and Trier. Christianity was introduced in the 3rd century of our era. In the middle of the 5th century the town was plundered by the Huns under Attila; subsequently it came into possession of the Franks, and was made the capital of Austrasia. On the partition of the Carolingian realms in 843 Metz fell to the share of the emperor Lothair I. as the capital of Lorraine. Its bishops, whose creation reaches back to the 4th century, now began to be very powerful. Metz acquired the privileges of a free imperial town in the 13th century, and soon attained great commercial prosperity. Having adopted the reformed doctrines in 1552 and 1553, it fell into the hands of the French through treachery, and was heroically and successfully defended against Charles V. by Francis duke of Guise. It now sank to the level of a French provincial town, and its population dwindled from 60,000 to about 22,000. At the peace of Westphalia in 1648 Metz, with Toul and Verdun, was formally ceded to France, in whose possession it remained for upwards of two centuries. The battles of August 1870, and the investment and capture of the army of Metz which followed, are described below. By the peace of Frankfurt on the 10th of May 1871 Metz was again united to the German Empire.

See Westphal, *Geschichte der Stadt Metz* (1875-1877); Georg Lang, *Metz und seine Umgebungen* (1883), *Die Statistisch-topographischen Handbuch für Lothringen*; Albers, *Geschichte der Stadt Metz* (Metz, 1902); G. A. Prost, *Études sur l'histoire de Metz* (1897); and Tauber, *Die Schlachtfelder von Metz* (Berlin, 1902). (See also FRANCO-GERMAN WAR: *Bibliography*.)

BATTLES AROUND METZ, IN THE FRANCO-GERMAN WAR, 1870

1. *Colombey-Borny* (August 14).—The French army under Marshal Bazaine was in and about Metz. The German I. and II. armies, on the march from the Saar, were heading for the Moselle between Metz and Pont-à-Mousson, and on the morning of the 14th of August the German I. Army (I., VII., and VIII. Corps, under General v. Steinmetz) lay on and east of the French, with outposts well to the front, watching the French camps east of Metz, which were little more than 1 m. to the front. Steinmetz had received from headquarters overnight instructions that on the 14th of August the I. Army would maintain the positions occupied during the 13th, and merely passed on these orders to his corps commanders. In Metz, meanwhile, Bazaine had decided to retreat, and during the morning orders to that effect reached his corps commanders, who commenced preparations for their execution. The 2nd Corps (Frossard) and 6th (Canrobert) began to retire about midday, the 3rd (Leboucq), and 4th (Ladmiraull) and Imperial Guard (Bourbaki) were to follow. These preparations being observed, the German outposts got under arms. General von der Goltz, in command of the VII. Corps (7 battalions, 4 squadrons, 2 batteries) hearing from a passing officer that the I. Corps on his right was preparing to attack, and noting personally signs of retreat in the enemy's lines, determined at 3 p.m. to advance his whole command to the ridge between Colombey and Borny (which was still occupied by French outposts), in order to clear up the situation. The ridge was captured with little resistance, but the sound of the firing at once set all the neighbouring troops in motion, and fortunately so, for the French had immediately retaliated on von der Goltz's audacious attack. Between 4 and 6 p.m. there was continuous heavy fighting on the front from Borny to Méy, as both sides brought fresh troops into the field. The convex slopes falling from the Prussian position towards Metz gave plenty of cover to the French, and the setting sun shone full in the faces of the Prussian artillerymen. Thus the Prussian infantry encountered unusually obstinate resistance and the troops engaged rapidly slipped from all superior control. The above front was held by the French 3rd Corps. Shortly before 6.30 the 4th Corps (Ladmi-

raull) suddenly began to deploy on the high ground to the north-west beyond Méy, thus threatening the right flank of the Prussian I. Corps (General v. Manteuffel). To meet this danger Manteuffel was compelled to direct his corps artillery and reserves, which were now rapidly coming up, away from the hard-pressed centre towards the oncoming infantry masses of Ladmiraull. These, with the sun now almost at their backs, were shooting better than usual, and Manteuffel was compelled to call on the VIII. Corps for assistance, which its commander, under positive orders from Steinmetz, refused to give. Meanwhile Steinmetz had been sending peremptory orders to the battlefield to stop the battle, but neither of the corps commanders was able to enforce them. Fortunately for the Prussians, Bazaine had issued similar orders to his subordinates, who, having their men better in hand, were able to obey; and as night began to close in the French broke off the action and retired under the guns of the Metz forts, convinced that at last they had "broken the spell" of German success.

Finding that, in spite of his orders, the firing at the front continued increasing in intensity, Steinmetz at length rode to the front himself. Meeting Manteuffel near the Brasserie of Noisseville, he overwhelmed him with reproaches, and at the crisis of this scene the bands struck up "*Heil dir im Siegeskranz*!" In this action the Germans brought 30,500 rifles and 150 guns on to the battlefield only out of more than 100,000 with 300 guns which could have been engaged before darkness. Bazaine actually deployed 50,700 rifles and 206 guns to oppose them. He might, however, had he been so minded, have struck with his whole army—nearly three times this force, and, judging from the course events actually took, we can have little doubt as to the result of such a blow. The losses on either side were in killed and wounded—French about 3600, Germans about 4800.

The chain of causation in this action is particularly worthy of attention: A young reserve officer, seeing some troops of the I. Corps standing to arms, reported to von der Goltz that the corps was standing to arms and about to attack. Von der Goltz thereupon decided to go forward and discover what was actually going on, and this action unchained the whole battle power of all the troops within call. When, on the following morning, Steinmetz reported von der Goltz and the commander of the I. Corps for disobedience, the king thanked Manteuffel warmly for the part he had played, and then turned to the young brigadier who had disobeyed orders and congratulated him on having twice distinguished himself in the first fortnight of the war.

2. *The Battle of Vionville—Mars-la-Tour* (August 16).—On the following day (15th) the II. German Army approached the Moselle above and below Pont-à-Mousson, with a view to overtaking and heading off Bazaine in his presumed retreat to the Meuse (see FRANCO-GERMAN WAR). So far, however, from being ahead of the Germans on the road to Verdun, the French were actually, late in the afternoon of the 15th of August, bivouacked on the plateau of Rezonville, and there their outposts were placed, not where they could see the surrounding country, but at the regulation distances of 600 to 1000 paces from the bivouacs. Friendly inhabitants kept Bazaine well informed as to the magnitude of the danger threatening him from the south, and a special telegram from Paris, the true origin of which has never been traced, led him to believe that the I. German Army was crossing the Moselle near Thionville and about to descend on him from the north. This telegram might have exercised the most prejudicial influence on the course of the battle had not Ladmiraull (4th Corps), nearer to the seat of the imaginary danger, taken upon himself to disregard the warning transmitted to him by headquarters. At daybreak on the 16th, no Prussians being reported in sight by the outposts, the troops began nonchalantly to prepare for the resumption of the march.

On the Prussian side, von Alvensleben's Corps (III.) shortly after daybreak was moving north-westward from the Moselle in two columns, on the right the 5th division, via Gorze and Flavigny on Vionville, on the left the 6th division with corps artillery by Arnville on Mars-la-Tour, von Alvensleben himself riding

a little in advance between the two. The 6th cavalry division was ordered to precede the right column and scout towards Rezonville. No one was aware of the dangerous proximity of the French army.

About 9 a.m. the 5th cavalry division, reinforced by two horse artillery batteries (flank guard of the X. Corps from Thiancourt), and accompanied by von Caprivi (chief of staff, X. Corps, and afterwards chancellor of the German Empire), were trotting up the western slopes of the ridge which runs between Tronville and Vionville. Reaching its summit they

from Gorze towards Vionville, whence he could overlook the whole country to the north and west, had met von Rheinbaben (commanding the 5th cavalry division) and had seen the surprise of the French camps. The sound of the heavy firing coming from the eastward convinced him of what had been gradually dawning on him—that with barely 30,000 men he was in the presence of the whole French army, whose attitude at this moment sufficiently indicated their determination to fight.

In a few moments his decision was taken. Calling on the X. Corps, away to the south-westward, for support, he determined

METZ BATTLEFIELDS (Western)



suddenly found themselves in face of at least 40,000 French troops, which were not under arms, but busied with miscellaneous camp duties. The temptation proved too great for the artillery, who promptly fired into the midst of the cavalry camp (Forton's division) which lay nearest to them. The momentary result was a wild panic, especially among the horses; but this panic gave the alarm to the infantry all along the road, and these (Frossard's 2nd Corps) at once stood to arms and moved forward, deployed for attack—one division to the west, another division, from Rezonville, to the south. The latter almost at once encountered the heads of the 6th cavalry division, at that moment just clearing the defile leading up to the Rezonville plateau from Gorze. The Prussian cavalry promptly bore away to cover to the westward, and reported what they had seen to superior authority, but not to the advanced guard of the 5th infantry division, which, emerging in its turn from the defile, ran right against the deployed French infantry moving to meet them. So sudden was the collision that the Prussian advanced guard battery had to fire case to clear its own front.

Meanwhile von Alvensleben himself, riding on the field track

to screen his own weakness by a vigorous attack. By universal consent this is approved as the boldest resolution arrived at by an independent commander throughout the war. Orders were forthwith despatched to the 6th infantry division, at that moment between Puxieux and Tronville, to wheel in to their right and attack, and, their movement being still hidden from the enemy, these troops were formally drawn up for action and sent forward as a whole. The French meanwhile had occupied Vionville and Flavigny, and other troops were moving down the slopes from Rezonville to their support, but the united onset of this whole German division overbore all resistance, and the French began to retire eastward, suffering terribly from the shell fire of the Prussian batteries.

Marshal Bazaine had meanwhile arrived on the scene, and ordering forward fresh troops to relieve (not to reinforce) those already engaged, he rode forward with a horse artillery battery to watch the operations. The retreating French troops belonged to Frossard's command, and as they were in considerable confusion Frossard called on du Preuil's brigade of the imperial guard cavalry to charge. He gave no objective, and when the

brigadier pointed out that the enemy was still beyond the striking radius of his horses, Frossard reiterated the order, which was obeyed to the letter.

The result was disastrous. The Prussians, having seen the cavalry whilst yet at a distance, ceased firing, formed their skirmishers into groups, and the closed supports standing in deployed lines, two deep, shattered the cavalry with volleys and file-firing, as with blown and exhausted horses they endeavoured to close with their adversaries. When in addition two hussar regiments struck them in flank they were driven back in wild disorder upon Rezonville. In the dust and confusion of the charge a group of the hussars approached Bazaine and his horse artillery battery, and almost carried off the marshal.

Alvensleben, mistaking the withdrawal of the French for the beginning of a retreat, had meanwhile sent orders to the 6th cavalry division to charge in pursuit towards Rezonville; but before it could reach the field the French relieving troops had forced their way through the stragglers and showed such a bold front to the Prussian horsemen that an attack held no promise of success, more especially since they had lost their intervals in

ascended the gentle incline which still hid them from their enemy.

Arrived at the summit, Bredow sounded "line to the front," but at that moment a storm of French bullets swept down on them, and the men, no longer to be restrained, dashed forward, before the line could be completed, almost due east against long lines of infantry and artillery which they now saw for the first time about 1200 yards in front of them.

This distance was covered at the fullest extended speed of the horses, and reaching the infantry they swept over them "like hounds over a fence"—in the words of an eyewitness. So sudden had been their onset that very few were hit until the infantry had been passed; then the latter, recovering from the shock, turned and fired into the cavalry from behind, whilst a whole fresh division of French horsemen charged them in flank. After a desperate mêlée of some minutes, the rally was sounded, and the survivors of the charge, breaking their way a second time through the French infantry, eventually reached the shelter of their own lines, having lost rather more than half their numbers, but having saved the situation momentarily for their own army. Again there was a lull in the operations.

Meanwhile, unknown to Alvensleben, a fresh storm was brewing on his left rear.

Ladmiraal, commanding the French 4th Corps had seen, during the afternoon of the 15th, the terrible crowd and confusion prevailing in the defiles leading to Gravelotte, and resolved to disobey his orders and to move direct from his bivouacs by the road from Woippy to St Privat, disregarding altogether the alleged danger from the Prussians supposed to be advancing from Thionville. Thus, about noon on the 16th he reached the high ground between St Privat and Amanvillers, and still without instructions he determined to direct his corps on Bruville and Doncourt, whence he could judge from the drift of the smoke-clouds whether he could fall on the Prussian left.

Much time was lost owing to the heat of the day and the fatigue of the troops, but shortly after 3 p.m. he reached a position north of the Tronville cotes whence his guns could fire into the left rear of the long line of Prussian guns (6th division and corps artillery) on the heights above Vionville and Flavigny. Their fire threw the latter into serious confusion and he had already decided to attack with his nearest division (de Cisse) in the direction of the steeple of Vionville, when his attention was caught by the outbreak of heavy firing in the cotes below him, and the entry of fresh Prussian guns into action.

This diversion was brought about by the arrival of the corps artillery of the X. Corps and of the 40th brigade, which latter had been at once ordered into the Tronville cotes to check portions of Tixier's division of the French 3rd Corps, which under cover of these cotes had gradually worked round the Prussian flank. Seeing then that the troops before him could hold their own, Ladmiraal continued his preparations for his counter-stroke, and Cisse's division had begun to move into its prescribed alignment, facing towards Vionville, when the sudden apparition of a closed mass of Prussian troops detaching itself from the low dust-cloud of a slow-moving infantry column, and forming to the south of Mars-la-Tour, again arrested his attention. Unanimously he and his staff agreed that this fresh enemy could only be the advanced guard of a large Prussian force, possibly, it was suggested, of the crown prince's army, from Alsace and Nancy, and a fresh delay arose while the situation was investigated. Actually this body consisted only of the 38th brigade (von Wedell), forming part of the X. Corps. It had no knowledge of the state of affairs on the battlefield, or in the direction of Bruville, though Prussian cavalry had been observing the approach of Ladmiraal's corps for some hours. It was now ordered to deploy and to co-operate with the 40th brigade in an attack on the Tronville cotes. This meanwhile had been delivered, and had more or less failed.

The deployment completed, about 4 p.m. the 38th brigade began its advance on the north-west corner of the Tronville cotes, this direction taking them diagonally across the front



their advance and had no room for a proper deployment. To steady the young soldiers, the cavalry commander (Carl von Schmidt) halted his men, made them correct their intervals and dressing as in peace, though under a heavy fire from the French infantry, and then withdrew them behind the cover of the nearest hill at a walk.

The threat of the charge had, however, induced caution on the French side, and for about two hours there was a lull in the fighting, which the Prussians utilized on their right in bringing up reinforcements through the Bois des Ognons. On their left, however, no fresh troops were as yet available, and on being informed, about 2.30 p.m., that French cavalry seemed to be about to charge the exhausted 6th division, Alvensleben ordered Bredow's cavalry brigade to charge, and if necessary to sacrifice itself, to save the infantry. Bredow's command (six squadrons of the 16th Uvans and 7th Cuirassiers) was at that moment drawn up under cover about half a mile west of Vionville, and from its position could see nothing of the events in progress on the battlefield. Nettled by the form in which the order was conveyed to him, Bredow drew his sword and ordered his trumpeter to sound the "trot," the brigade moving off in line of squadron columns at close interval in the direction in which they happened at the moment to be facing. Near Vionville they took ground to their left, opening to full intervals as they did so, and then

of Cisse's division, still out of their sight but moving due south. Hardly had they stepped off when Cisse's first line, catching sight of them, opened a devastating fire upon their left flank, and to meet this fresh danger the Prussians endeavoured to change front half-left whilst still on the move. Without pausing to fire, the men raced onward, but the French striking their outer wing rolled up the whole line in succession, the actual collision occurring in and near the Bruville ravine, a deep-cut natural trench which, starting from the Tronville copses, here intersects the plateau from west to east. Against the weight of French numbers, nearly three to one, the Prussians were unable to stand, and presently they broke and drifted backwards, completely routed. Then the 1st Guard Dragoons (since known as Queen Victoria's regiment), after a brilliant manoeuvre under heavy fire, to get into the best position for delivering a charge, rode down the whole French line of pursuers from left to right, and by their heroic self-sacrifice relieved the remnants of the infantry from further pursuit.

This was the scene which for the moment held the attention of Prince Frederick Charles when at length he reached the battlefield from Pont-à-Mousson. All along the rest of the line the Prussians were still holding their own, and on the extreme right fresh troops from the IX. Corps were streaming up through the woods against the French left wing. But on the left there was every sign of incipient disaster, and to avert this only the cavalry were at hand. Sending, therefore, hasty orders to the 5th and 6th cavalry divisions to concentrate to the west of Mars-la-Tour, the prince ordered them from there to sweep round on the right rear of the French army. The same idea had, however, occurred to Ladmirault, and he had called on the two nearest French cavalry divisions to put it into execution, and as the Prussians began to reach the plateau west of Mars-la-Tour and the Yron brook from the south, the French were deploying across it some two thousand yards to the north.

Then followed a duel—the one great cavalry duel of the war—between upwards of two thousand horsemen a side. But it was delivered by both sides in a series of regimental charges, and in result was singularly indecisive. For about half an hour great crowds of riders, hidden by dense clouds of dust, drifted aimlessly about the plain, till at length the charge of a single squadron of the Oldenburg Dragoons (who had joined in on their own initiative) delivered on the outer French flank, brought the whole mass into motion north-eastward, and, both sides sounding the rally, the engagement gradually ceased.

It was now about 7 p.m. and night was coming on. Seeing the dust-clouds drifting away northward, and noting the lethargy which seemed to have settled over the whole French line, Prince Frederick Charles decided to assert his own independent will to conquer by a final assault along his whole front. Guns, cavalry, infantry, everything that could still stand were to take part in it. Weary as they all were, his indomitable will put fresh life into the whole army. With drums beating and colours flying, every unit within call went forward for the final effort. It was almost dark when the Prussians approached the French position between Rezonville and the woods to the northward, and the troops soon lost direction in the smoke and became involved in the direst confusion; the firing again blazed out for a few moments, only to die away as utter exhaustion at length put an end to the Prussian advance. Then the wearied troops, for the most part, lay down and slept in the positions they had reached.

Thus closed the hardest fought battle of the Franco-German War. From 9 a.m. to 3 p.m. only 23,700 rifles, 8100 sabres and 126 guns had been brought into action by the Germans against 59,100 rifles, 6700 sabres, and 300 guns on the French side, and even at the close of the day the former had only deployed 47,100 rifles, 8300 sabres and 222 guns against 83,000 rifles, 8000 sabres and 432 guns including 24 mitrailleuses. The chief characteristic of the day's fighting was the terrible effectiveness of the Prussian artillery, which was handled in masses and not, as on the French side, by batteries. The manoeuvring power of the latter attracted the admiration of the Germans, but arriving singly on the field they were generally reduced to silence

in a few minutes. Deprived of their support, not all the gallantry of the French infantry could avail anything. Again and again, particularly on their left wing, they chased the German infantry before them, but the moment the retreat of the latter downhill uncovered the pursuing French to the Prussian guns, a tornado of shells shattered their order and compelled them to retreat. Though the cavalry were freely engaged, the training of both was so far beneath the standard of the present day that the most that can be credited to them in respect of results is that they from time to time averted imminent disaster, but failed altogether to achieve such a decision as was well within their potential capacities.

3. *Gravelotte—St Privat (August 18).*—The position on to which the French army fell back from the field of Vionville is formed by a ridge some six miles long running from Rozerieulles almost due north to Roncourt, a little village overhanging the steep and wooded banks of the Orne, and connected with the general plateau between the Meuse and Moselle by a gentle saddle running from about Amanvillers nearly due west through the Bois de la Cusse towards Doncourt. North of this saddle the slopes show a slight concavity, but are passable by troops of all arms in close order. To the south the rivulet of the Mance soon forms a formidable obstacle as its bed cuts its way through the sandstone. Scrub and woods with dense undergrowth line both its banks, and, except by the great chaussée from Metz to Verdun, access to the French side becomes impossible to troops in ordered bodies.

It does not appear that the position had been systematically examined, or apportioned to the several corps in accordance with any predetermined plan. The army merely swung backwards, pivoting on its left wing, the corps preserving their relative order as it had been on the 16th, with the exception that the Imperial Guard was withdrawn to the spur on which Fort Plappeville stands, and the 6th Corps (Marshal Canrobert) crossed the line of march of the 3rd and 4th Corps in order to gain St Privat la Montagne. No lines of march were assigned to the several units, consequently the confusion became so great that though the distance to be traversed in no case exceeded six miles, only the right wing and centre reached their destinations as night was falling. Many of them had so little idea of the general situation that they actually placed outposts to the north and east, whilst the whole of the enemy's army lay to the south and west. No attempt was made to entrench the position systematically, but on the left the 2nd and 3rd Corps made some disconnected shelter trenches and gun-pits, while the 4th Corps in the centre began to improve available cover about an hour before the battle began, and the 6th corps on the right, not yet having received any entrenching tools, could do no more than improvise a few loopholes in the walls of the villages of St Privat and Roncourt with such tools as the sappers could obtain from the inhabitants.

Fortunately for the French the Germans were too exhausted by the battle of the 16th to attempt to interfere with these movements. At daybreak on the morning of the 18th the royal headquarters (which now for the first time arrived at the front) still had no certain knowledge as to whether the French main army was in retreat—covered by the force which they could see on the high ground north of the Metz road—or whether they had taken up a position in order to fight.

Hence the orders issued overnight on the presumption that the main force of the French was retreating to the north and west were allowed to stand, and the whole II. Army (Prince Frederick Charles) moved off in échelon from left to right, the I. army under Steinmetz, consisting for the day of the I., II. and VII. Corps, being left in observation of the troops visible on their front and of the garrison of Metz itself. The I. Corps was kept back beyond the Moselle on the east side of Metz, the II. was not due to arrive at Rezonville before 4 p.m., hence the VII. only was immediately available if the enemy counter-attacked. But Steinmetz had not ordered, nor had von Zastrow, the corps commander, undertaken, any preparations to meet an emergency. About 10 a.m. the corps had reached the following positions:

VIII. Corps, Rezonville; XI. near St Marcel; Guard approaching Roncourt; XII. towards Jarny; the III. and X., which had been so heavily engaged on the 16th, still in their bivouacs preparing to move. The cavalry of the Saxons had established the fact that the French had not retreated northward, but though scouts from the Guard had already seen the enemy on the heights of St Privat, this information had not yet reached headquarters, nor had it been transmitted to the IX. Corps, which it most closely concerned.

Shortly after 10 a.m. Moltke, still under the impression that the French right extended no further than La Folie (2 m. north of the Metz road), determined to attack with the IX. and VIII. Corps whilst the Guard executed a turning movement via Habonville against the French right. The IX. Corps was to engage, but not to push its attack home until the Guard could co-operate. The XII. Corps was left to its own devices, but fortunately the crown prince of Saxony, who commanded it, had ridden forward and, seeing the French in force towards Roncourt, had issued orders which in the event proved decisive.

In pursuance of his instructions von Manstein, commanding the IX. Corps, set his two divisions in motion towards La Folie and the Bois de la Cusse, and advanced to reconnoitre the French position. From the eastern edge of the above-named copses he suddenly descried the camp of a whole French Corps (the 4th), evidently ignorant of their danger, on the slopes trending westward from Amanvillers. Unmindful of the experience of the 16th, he decided to execute an artillery surprise on a grand scale, and sent orders to his corps artillery to come into action on the long spur overlooking the French camps from the westward. At noon, just as the French infantry were falling in for midday roll-call, sufficient guns were in position, and suddenly opened fire. But the effect was disappointing. The French infantry ran to their arms, piled along the front of their positions, and moved forward to attack, covering their advance by a hail of bullets. Simultaneously the French artillery also took up the challenge, and from the heights near St Privat the 6th Corps, whose presence had been unsuspected by the Prussians, joined in the fight.

In a few minutes the batteries on the extreme Prussian left were completely overwhelmed, and suddenly dense lines of French skirmishers emerged from a fold in the ground upon their flank and front, and the gunners were compelled to resort to case-shot, so imminent was their danger. But at this critical moment the leading companies of the Hessian infantry arrived, re-established the equilibrium (though not before four Prussian batteries had been temporarily overrun by the enemy), and a most obstinate fight ensued.

Prince Frederick Charles now rode forward to a point north-east of Vernéville, whence the southern boundary of St Privat could be seen. But the northern side of the village and the country towards Roncourt was hidden from his view by the high poplars bordering the Metz-Bricy road. Seeing the Hessians hard pressed, he now brought forward the 2nd division of the Guard to their assistance, sending in the 3rd brigade immediately, and holding the 4th brigade in reserve. The 1st division, warned by their own scouts that French troops were in St Marie, deployed to attack this village, and were assigned in their endeavour by a brigade of Saxons detached by the crown prince of Saxony, who from his position could see behind the poplar screen that limited the view of the commander-in-chief. Hence he was already aware that the French position extended to Roncourt at least, and had despatched a whole division down the valley of the Orne to outflank them. No news of this movement, however, appears to have reached Prince Frederick Charles.

The French troops in St Marie were only an outpost of the 6th corps, and seeing themselves outnumbered, they withdrew about 2.30, the Prussians rushing the village immediately afterwards. Considerable confusion arose from the convergence of these three brigades upon one village, and more than an hour passed before the troops could be disentangled and massed for further operations. The leaders of the two Guard brigades, still ignorant of the extent of the French position, rallied their

men on the main bodies of their commands (which had not been engaged) and then lay down facing exactly as they had done when brought forward to the attack. Thus the 1st brigade lay, facing about east-south-east, south of the chaussée and some five hundred yards west of the village. The 2nd brigade lay south-west of the village about three hundred yards away from it and facing nearly north-east.

The Saxons were on the left rear of the 1st brigade, but took longer to recover themselves than the Guards. With the Hessians and the IX. Corps the action still dragged; the 3rd brigade of the Guards had become involved in the fight, and notwithstanding the arrival of the corps artillery of the III. Corps in the centre the situation was still critical. From the south also came the thunder of guns and no encouraging news from that quarter had as yet reached the prince's headquarters.

About 4.30 p.m. the prince therefore had to consider how long it would take to obtain a decision. To postpone it till the morrow seemed undesirable: to achieve it before nightfall was only possible at the cost of immediate effort.

He therefore decided to assault St Privat with all the Guards available, and called up the III., X. and Saxons to assist them.

The 4th brigade of the Guards now received their orders to attack Jérusalem (a hamlet a little south of St Privat), and the 1st division was ordered to assault St Privat itself.

Von Pape, commanding the latter division, pointed out that no artillery force adequate to prepare the way for him was as yet on the ground, and that the Saxons were still long way to the rear. But his orders were imperative, and the 4th brigade was already moving off and had to be supported at any cost. Actually all available batteries had already been sent for and were trotting forward from every quarter towards the objective. He accordingly transmitted his orders, and the 2nd brigade was the first to attempt their execution. It had to wheel half-right in mass to bring it in the required direction, and then to advance till its rear was clear of the obstruction formed by the gardens of St Marie. By the time (5.30) it had sufficiently cleared this village it became apparent that the 4th brigade in its extension for attack would overlap the front assigned to the 2nd, hence a further (half-left) wheel, still in mass, had to be undertaken before room for deployment could be obtained. Almost as the commands were given, the French suddenly opened an overwhelming long-range fire and their bullets swept like hail through the crowded mass of the German troops. Nevertheless the wheel was effected, the fresh direction taken, the troops extended for attack, and then the whole brigade dashed towards the houses assigned them as their objective. Meanwhile the 1st brigade had moved round the north of the village and carried out its extension without serious hindrance. But emerging from the hollow running north from St Marie, they came under a heavy fire not only from St Privat but also from Roncourt, which latter village they now saw for the first time. Instinctively a portion of their line worked to the left to face this new menace, and the front thus became dangerously extended. They were, however, now abreast of the 2nd brigade, and the whole line raced forward to reach the effective range of their very inferior weapons, which were about equal at 200 yds. to the French rifle at 600. But the losses of the 2nd brigade, particularly in officers, had been too heavy, and the rush died out whilst still 500 yds. from the two villages.

It was now about 6 p.m. and a long pause ensued, while the 220 guns, which by degrees had unlimbered behind them, brought St Privat and Roncourt under fire. About 7 p.m. the Saxon turning-movement took effect; their infantry from the Orne valley attacked Roncourt from the north, and about 7.15 the village was carried.

Neither Prince Frederick Charles nor the troops in the fighting-line could see what had taken place; but the former seeing other Saxons moving towards Montois and the masses of the III. and X. Corps approaching, whilst the rain of shells into St Privat exceeded anything hitherto seen on any battlefield, decided to call on the whole of his force to attack. He was in

the act of issuing his orders when a psychological wave swept through the fighting-line, and the men rose and rushed the village at the point of the bayonet. It was now about eight o'clock, and the light was rapidly failing.

The French artillery had already evaded the coming blow, and had changed position, "right back," to cover the flank of the rest of the army, and the Prussian and Saxon artillery trotting forward conformed to this new front, their shells sweeping the ground for 2000 yds. to the south of Amanvillers. The confusion in and around St Privat, where troops from four several corps were all intermingled, became so extreme that no further infantry-advance could be attempted; so under cover of the fierce artillery duel the remnants of the unfortunate 6th corps drifted away towards Metz down the many ravines leading into the river valley. The "annihilation" of the Guard at St Privat has become historic. Yet, heavy as were the losses of the 1st Guard division they were not excessive compared to those previously endured. In round numbers one-third of their effectives had fallen—most of them in the first great rush forward at 5.30 p.m.; but actually they had been more or less under fire since about 2 p.m., and many were hit by French shells plunging into the turmoil about St Privat from 8 to 10 p.m. But the legend cannot be justified when the facts are compared with the slaughter of the Seven Years' War, of Napoleon's battles, the Crimea, and the American Civil War, or with the horrible punishment of von Wedell's brigade (38th) only two days before.

It is now time to return to the southern theatre of the battlefield, where an entirely independent engagement had been raging all the afternoon. Von Goeben with the VIII. Corps was standing massed about Rezonville when von Manstein's guns opposite Amanvillers suddenly made themselves heard. Wheeling his corps to face the French to the eastward he immediately sent forward his artillery and prepared to support his comrade. Von Zastrow with the VII. Corps followed his example. Both corps took as their primary objective the farms of St Hubert and Point du Jour, standing just above the defile made by the Verdun-Metz road where it climbs out of the Mance ravine towards the French position. About 3.30 p.m. St Hubert was carried by a confused mass of some 49 companies, and von Steinmetz, believing the main French position to have been pierced, ordered the 4th cavalry division to cross the ravine by the chaussée and pursue. Simultaneously von Zastrow, under the same impression, had ordered his corps artillery to advance by the same road, and von Goeben, thinking his troops in front required support, had sent forward an infantry brigade by the same line of road.

Presently all these columns converged upon the defile and a hopeless entanglement ensued. Three batteries succeeded in struggling through the mass, and, in coming into action, their left resting on St Hubert. But the remainder of the troops had to be withdrawn, and confusion breaking out in their rear, exposed to all the random bullets and shells of the French, a panic ensued, thousands of men breaking away and flying in wildest confusion through Gravelotte towards the west. Hardly had they melted away when the French made a most brilliant counter-attack from their main position between the farms of Leipzig and Moscow. This was stopped almost entirely by the Prussian artillery fire; but the news of its coming spread through the stragglers in the ravine south of the great road, and a wave of panic again swept through the mass, many thousands bolting right upon the front of their own batteries, thus masking their fire at the most critical moment, and something like a crisis in the battle arose. Fortunately the II. Corps was now rapidly approaching (about 6 p.m.), and the king, against Moltke's advice, now ordered von Steinmetz (to whom the II. Corps had been allotted for the day) to attack again with all his forces. Meanwhile a third panic broke out which delayed the preliminary movements and it was now growing dark in the ravine. At length the II. Corps, together with all of the VII. that could be collected, moved down into the valley. Just as the leading German troops were approaching

St Hubert the French again began to fire, their bullets plunging down among the fresh arrivals, who knowing nothing of what had taken place about St Hubert (where the remnant of their own infantry were still offering a desperate resistance) opened fire into the backs of their own men, and a fourth panic began which soon spread to the stragglers crowding the Mance ravine. Fortunately, by the superb gallantry of some of the company officers and men, the new arrivals were induced to recognize their mistake, and by degrees about 10 p.m. the whole of the II. Corps succeeded in reaching the plateau between St Hubert and Point du Jour, where the débris of the VII. and VIII. Corps had gathered. But in the darkness and confusion no forward movement against the French (only 400 yds. to their front) could be initiated, therefore the whole mass passed the night where they stood until daylight disclosed that the French had retreated.

Meanwhile the king, Moltke, and Bismarck, had ridden back behind Gravelotte where they passed two hours of intense anxiety. From the flash of the rifles, it was clear that the French main position was still intact, and as every body of troops within thirty-six hours' call had been engaged there seemed little prospect of renewing the struggle next morning. No news too had come in from Prince Frederick Charles. Ultimately about midnight the welcome tidings of the capture of St Privat arrived, and all anxiety was at an end.

4. *The Investment of Metz (Aug. 19-Oct. 14).*—During the night following the battle of Gravelotte the French army withdrew within the line of the forts round Metz. The 6th Corps only was severely shaken, the 4th (the best in the whole army), though it had fought hard twice within forty-eight hours, losing nearly 30% of its strength, was still well in hand, and the 3rd, 2nd and Imperial Guards were almost intact. A fresh issue of ammunition and food was all the men needed to make them a thoroughly efficient fighting force comprising some 100,000 troops capable, with a resolute leader and an efficient staff, of crossing over to the right bank of the Moselle, overrunning the I. German Corps, the only one in their direct path, and then fighting their way across the communications of the II. and III. German Armies until they regained touch with the French railways to the south-west about Troyes.

The mere fact of the effort being made would have given the battle of Gravelotte the moral effect of a victory, and the reaction in the German ranks from the feeling of over-confidence, which had mastered them after the early successes of Spicheren and Woerth, must have had most far-reaching consequences.

Bazaine, however, withdrew entirely under cover of the forts, and set about the reorganization of his troops in the most leisurely manner. The Metz forts, though neither sufficiently armed nor even completely finished in some cases, were nevertheless, with their deep ditches and self-protecting bastion trace, far too formidable for any field army to attempt without the aid of a siege train of some 200 guns, which for the moment were not available. Of this fact the Germans were well aware, and hence they decided from the first to reduce the place by hunger, calculating that with the extra 150,000 men thrown back upon the fortress, its food supplies could not last very long. On the morning of the 19th the German army was far too exhausted for further efforts. Except the I. Corps, which had been summoned overnight from its position about Courcelles towards the battlefield of Gravelotte and had almost reached the Moselle before this move could be counterordered, the remainder kept their places of the previous night, only following the French retreat with a screen of outposts. They were sufficiently occupied in collecting the wounded and clearing up the confusion resulting from an accumulation of trains and transport in the defiles of Gorze and about Novéant. No eastward movement could have taken place that day. In the course of the afternoon of the 19th the royal headquarters, creating a new army under the crown prince of Saxony (Guard, IV. and XII. (Saxons) Corps) for field operations towards the Meuse, assigned the remainder of the II. Army, and the whole

of the I., to Prince Frederick Charles as commander-in-chief of the army of investment.¹ This brought the strength of his command up to eight corps, numbering some 220,000 men; an enormous mass to feed in a district swept bare of supplies by the operations of the preceding week, and with only one railway line, terminating at Courcelles, to depend upon.

For the moment the chief care of the Prince was to guard against an attempt of the French army to break out to the westward. The I. Army Corps with Kummer's Landwehr division (which arrived during the night of the 19th-20th of August) were to occupy a position to cover the rail head at Courcelles-Rémilly, and the remainder were disposed in the following order: The X. Corps was on the north, with a bridge head at Haucourt-sur-Moselle, the II., VIII. and VII. along the eastern slopes overlooking the Moselle valley, the latter having also a fortified bridge head at Ars-sur-Moselle. The III. and IX. were cantoned almost on the battlefield of the 18th, between Caure Farm and Roncourt, ready to move off to the left and support the X. Corps in the event of an attempt on the part of the French to break out towards Thionville.

The positions were fortified with a light outpost line, behind which was drawn a main position on which every art of the engineer was expended. Ample arrangements were made for obtaining and circulating intelligence, and all lateral communications were improved and supplemented to the utmost. A light field-railway from Rémilly to Pont à Mousson (14 m.) was also put in hand, but progress on this was very slow. The water-supply of the town was promptly interrupted, but the river water was quite drinkable.

Meanwhile, the French in Metz had been diligently at work. There was no real deficiency of ammunition and stores in the fortress, and provisions for forty days were reported in hand. Bazaine was still in communication with the outside world, though return messages came in sparingly. On the afternoon of the 25th he decided to break out to the northward by the right bank of the river, and orders to this effect were duly issued. Many delays arose in their execution, and it was not till 2 p.m. on the 26th that the troops were formed up ready for action. But at the last moment the marshal wavered. Calling a council of war on the heights of Fort St Julien, he asked the opinion of his subordinates, who were unanimously against the proposed sortie, principally because the artillery "had only ammunition enough for a single battle!" Besides, the Germans had long since become aware of the movement in progress, and all chance of surprise was past. It was also raining very heavily. Accordingly the scheme was abandoned.

On the 20th of August Bazaine received a despatch, dated the 27th, from MacMahon, according to which his army should have been at Stenay on the Meuse and farther to the south by the 30th. The marshal accordingly determined to renew the attempt of the 26th, and orders—almost a repetition of those of the previous occasion—were issued.

At this moment (Aug. 31) the positions of von Manteuffel's command (I. Corps and 3rd Landwehr division) were most dangerously extended, and a surprise at daybreak might have had far-reaching results. But the habit of excessive bugling and band-playing betrayed the French design even before daybreak. Not until 1.30 p.m. was the concentration completed, and Bazaine again assembled his commanding officers to give them their final instructions. This time he adhered to his decision, and about 4 p.m. the attack opened (battle of Servigny or Noisseville); but his opportunity had been allowed to slip, and though his first onset overwhelmed the German outposts, their main line held good, and masses of guns unlimbering over a front of some 4 m. rendered all further attempts to break the German cordon abortive. Firing only ceased as darkness fell, and next morning the fighting was again renewed. But the whole French army was disheartened. It was obvious that what they had failed to do by surprise was hopeless now that twenty-four hours had been given in which the Germans

¹Steinmetz was shortly afterwards relieved of his command and returned to Germany.

could make counter-preparations. Therefore about noon a general retirement under the guns of the forts took place, and the last serious hope of the French army had vanished. Some 120,000 men with 528 guns had been engaged against 60,000 Germans with 222 guns, and had been beaten off with a loss of 3500 men. The Germans had lost about 3000.

The investment now resumed its regular course. The Germans, secure in the strength of their position on the left bank of the Moselle, drew more troops over to the right, and added to their defences and communications. The idea was even mooted of damming up the river near Haucourt, and thus flooding out the whole of the civil population of Metz; but expert civil engineers, who were sent for from Germany, reported against the proposal.

As time wore on the conditions in Metz and the surrounding camps became deplorable. The hospitals and private houses had been crowded with wounded from the first, and now, owing to the persistent wet weather, smallpox and dysentery became epidemic. Towards the close of September rations had to be reduced, and the troops began slaughtering the cavalry horses for food. Probably to cheer the men by a semblance of activity, Marshal Bazaine attempted a sortie on a large scale on the 1st of October in the direction of Ladorchamps, and fighting continued into the 2nd, but without prospect of success, and the profound depression following on defeat sent up the sick list rapidly. One other sortie towards Noisseville followed on the 7th, the alleged reason for which was the hope of obtaining provisions in the neighbouring villages. But it was beaten off with the utmost ease by the investing troops, who were well fed and cared for; and as by this time even the gun-teams had followed the cavalry horses to the slaughter-house, the French army as an army—*i.e.* a combination of the three arms—had ceased to exist. On the recognition of this fact negotiations for the capitulation of Metz were begun on the 13th of October, and on the 14th the Army of the Rhine surrendered. Had it held out even forty-eight hours longer events before Paris and Orleans might have taken a different turn.

The investment of Metz had lasted 54 days, and the death-roll of the civil population had risen to 3587 against 1200 in the corresponding period of a normal year. The army itself had only lost from sickness 2600 men, or barely 2% of its full effective. (F. N. M.)

MEUDON, a town of northern France, in the department of Seine-et-Oise, 6 m. E. of Versailles by rail and about 2½ m. S.W. of Paris. Pop. (1906), 9597. The remains of a castle (17th century) burned during the siege of Paris in 1871 have since been adapted as an observatory. Its terrace commands a fine view of Paris. The handsome Galliera Institutions, on the hill of Fleury, were founded by the duchess of Galliera for the reception of aged persons and orphans. The buildings were completed in 1885, at a cost of £560,000. The town has a monument of Rabelais, who was curé there in 1553, and manufactures munitions of war for the artillery, and in the neighbouring park of Chalais is the Government military ballooning establishment. In the 16th century the cardinal, Charles of Lorraine, built at Meudon a magnificent chateau, which was destroyed in 1803. The present remains belong to a building erected by the dauphin, son of Louis XIV. The wood of Meudon lies for the most part to the west of the town.

MEULEN, ANTONY FRANCIS VAN DER (1634-1690), Flemish painter, born in Brussels, was called to Paris about 1666 by Colbert, at the instance of Le Brun, to fill the post of battle painter to Louis XIV. His paintings during the campaigns of Flanders (1667) so delighted Louis that from that date Van der Meulen was ordered to accompany him in all his expeditions. In 1673 he was received into the French Academy, attained the grade of councillor in 1681, and died full of honours in Paris in 1690. He is best represented by the series of twenty-three paintings, mostly executed for Louis XIV., now in the Louvre. The show that he always retained his Flemish predilections in point of colour, although his style was modified by that of the French school.

MEUNIER, CONSTANTIN (1831-1905), Belgian painter and sculptor, was born at Etterbeek, Brussels. His first exhibit was a plaster sketch, "The Garland," at the Brussels Salon in 1851. Soon afterwards, on the advice of the painter Charles de Groux, he abandoned the chisel for the brush. His first important painting, "The Salle St Roch" (1857), was followed by a series of paintings including "A Trappist Funeral" (1860), "Trappists Ploughing" (1863), in collaboration with Alfred Verwée, "Divine Service at the Monastery of La Trappe" (1871) and episodes of the Peasants' War (1878). About 1880 he was commissioned to illustrate those parts of Camille Lemonnier's description of Belgium in *Le Tour du monde* which referred to miners and factory-workers, and produced "In the Factory," "Smithery at Cockerill's," "Melting Steel at the Factory at Seraing" (1882), "Returning from the Pit," and "The Broken Crucible" (1884). In 1882 he was employed by the government to copy Pedro Campana's "Descent from the Cross" at Seville, and in Spain he painted such characteristic pictures as "The Café Concert," "Procession on Good Friday," and "The Tobacco Factory at Seville" (Brussels Gallery). On his return to Belgium he was appointed professor at the Louvain Academy of Fine Arts. In 1885 he returned to statuary and produced "The Puddler," "The Hammerer" (1886), "Firebrand" (1889, Brussels Gallery), "Ecce Homo" (1891), "The Old Mine-Horse" (1891), "The Mower" (1892), "The Glebe" (1892), the monument to Father Damien at Louvain (1893), "Puddler at the Furnace" (1893), the scheme of decoration for the Botanic Garden at Brussels in collaboration with the sculptor Charles van der Stappen (1893), "The Horse at the Pond," in the square in the north-east quarter of Brussels, and two unfinished works, the "Monument to Labour" and the Zola monument, in collaboration with the French sculptor Charpentier. The "Monument to Labour," which was acquired by the State for the Brussels Gallery, comprises four stone bas-reliefs, "Industry," "The Mine," "Harvest," and the "Harbour"; four bronze statues, "The Sower," "The Smith," "The Miner," and the "Ancestor"; and a bronze group, "Maternity." Meunier died at Brussels on the 4th of April 1905.

MEURICE, FRANÇOIS PAUL (1818-1905), French dramatist, was born in Paris on the 7th of February 1818. In 1848 he became the editor of the *Événement*, founded by Victor Hugo, and in 1869 he was one of the promoters of the *Rappel*, a journal on similar lines. He was the literary executor of Victor Hugo, and edited his works (1880-1885). In collaboration with Auguste Vacquerie and Théophile Gautier, he produced *Falstaff* (1842), a play in imitation of Shakespeare, and in 1843 an imitation of the *Antigone*; and with Alexandre Dumas a *Hamlet* (1847). He also wrote *Benvenuto Cellini* (1852), *Schamyl* (1854), *Srrensdé* (1893), and dramatic versions of *Les Misérables* (1878), *Notre Dame de Paris* (1876), *Quatre-vingt-treize* (1881). He died on the 12th of December 1905.

MEURSIUS [JOHANNES VAN MEURS] (1570-1630), Dutch classical scholar and antiquary, was born at Loosduinen, near the Hague. He was extremely precocious, and at the age of sixteen produced a commentary on the *Cassandra* of Lycophron. In 1610 he was appointed professor of Greek and history at Leiden, and in the following year historiographer to the states-general. In consequence of the disturbed state of his country he welcomed the offer (1625) of Christian IV. of Denmark to become professor of history and politics at Sorø, in Zealand, combined with the office of historiographer royal. He died at Sorø on the 20th of September 1630. Meursius was the author of classical editions and treatises, many of which are printed in J. F. Gronovius's *Thesaurus antiquitatum graecarum*. Their lack of arrangement detracts from their value, but they are a storehouse of information, and Meursius does not deserve the epithets of "pedant" and "ignoramus" which Scaliger applied to him. Meursius also wrote on the troubles in the Netherlands and the history of Denmark.

Complete edition of his works by J. Lami (1741-1763). See Van der Aa's *Biographisch Woordenboek der Nederlanden* (1869), and J. E. Sandys, *Hist. of Class. Scholarship* (1908), ii. 311.

MEURTHE-ET-MOSELLE, a department of north-eastern France, formed in 1871 out of those parts of the old departments of Meurthe and Moselle which continued French. Before 1790 it belonged to Lorraine, or to one or other of the bishoprics of Toul, Metz and Verdun. Pop. (1906), 517,508. Area 2038 sq. m. It is bounded E. by Lorraine, N. by Belgium and the grand-duchy of Luxemburg, W. by the department of Meuse, and S. by that of Vosges. Meurthe-et-Moselle is of a hilly character, the highest elevation, the Grand Rougimont (2041 ft.), being in the Vosges. The valley of the Moselle runs through it from south to north. Extensive forests, the chief of which is the Forest of Haye, are found in the south-western region. Only a small part of the drainage of Meurthe-et-Moselle flows into the Meuse, by far the greater part reaching the Rhine by way of the Moselle. The principal affluents of the Moselle are the Madon and the Orne on the left, and on the right, besides the Meurthe, the Seille, which in one part of its course forms the boundary of Alsace-Lorraine. The principal tributary of the Meuse within the department is the Chiers. Climatologically Meurthe-et-Moselle belongs to the Vosgian region, and has hot summers and severe winters. Its mean annual temperature is between 48° and 49° F., being 2° lower than that of Paris (which has the same latitude). The annual rainfall averages between 28 and 32 in. The department possesses much fertile land, the chief crops being cereals and potatoes, together with clover, mangel-wurzels, tobacco, hops and beet-root. The vine is also cultivated, its best products being those of the Toul district. The most common fruit trees are the pear, the apple, the walnut, the cherry and the plum. Of forest trees the oak and the wych-elm are most frequent in the west of the department, the beech and the fir in the Vosges. The French school of forestry has its seat at Nancy. The salt-workings (the chief of which lie between Nancy and St Nicolas), and the iron-mines (round Nancy and Longwy) of Meurthe-et-Moselle are the most productive in France. Other important industries are the manufacture of boots and shoes, straw and felt hats, pottery, and tanning and brewing (at Tantonville). Cotton and wool spinning, and the manufacture of cotton goods, hosiery, embroidery, chemicals (at Dombasle, close to Nancy), soap, tobacco, matches, crystal (at Baccarat, which has a population of 5617), mirrors (Crey), glass, army clothing and paper may also be mentioned. The department is served by the Eastern railway, the chief line being that from Paris to Strassburg through Nancy. The main waterway is formed by the canal between the Marne and the Rhine. This canal communicates with the Moselle, which is navigable from Frouard downwards, and with the Eastern canal, which unites the Meuse and the Moselle with the Saône and the Rhone. The department constitutes the diocese of Nancy, has its court of appeal at Nancy, and forms a part of the district of the VI. army corps (Châlons-sur-Marne), and of the académie (educational division) of Nancy. There are 4 arrondissements (Nancy, Briey, Lunéville and Toul), 29 cantons and 598 communes. The principal towns of the department are Nancy, the capital, Lunéville, Toul, Longwy, Pont-à-Mousson and St Nicolas. Other places of interest are Prény, with ruins of an important stronghold (12th and 13th centuries) of the dukes of Lorraine; and Vaudémont, seat of a famous county, with ruins of a stronghold of the 12th and 14th centuries.

MEUSE (Flem. *Maes*, Du. *Maas*), a river rising at Pouilly, in the department of Haute Marne, France. After passing through a great part of Belgium and Holland it flows into the Waal channel of the Rhine at Fort Loevenstein. A few miles below Gorinchem the Meuse, or Waal as it is then called, divides into two branches. The northern flows almost due west, and joins the Lek (Rhine) above Rotterdam, and enters the North Sea at the Hook of Holland. Ocean-going steamers for Rotterdam use, however, the New Waterway (*Nieuwe Waterweg*), a little north of the Meuse. The southern branch turns south, crosses the marsh of Biesbosch by the canalized channel of New Merwede, enters the Hollandsch Diep, and reaches the sea by the arms called Haringvliet and Krammer.

The length of the Meuse is nearly 560 m., of which 360 are navigable, and probably its traffic is only exceeded by that of the Rhine. Near Bazelles it disappears under ground for a distance of over 3 m. The Chiers, the Semois, the Lesse, the Sambre, the Ourthe and the Roer are its most important tributaries. In Belgium it is canalized between Liège and Vise, and the Dutch are engaged on the same operation below Maestricht. The principal towns on the Meuse are: in France, Verdun, Sédan, Mézières and Givet; in Belgium, Dinant, Namur, Huy, Liège and Masey; in Holland, Maestricht, Roermond, Venlo, Dordrecht and Rotterdam.

MEUSE, a department of north-eastern France, formed out of a part of Lorraine (portions of the Three Bishoprics, and the Barrois and Clermontais) and Champagne. Pop. (1906), 280,220. Area, 2409 sq. m. It is bounded N. by Belgium and the department of Ardennes, E. by that of Meurthe-et-Moselle, S. by those of Vosges and Haute-Marne, and W. by those of Marne and Ardennes. About one-half belongs to the basin of the river Meuse, which is enclosed on the west by the wooded region of Argonne, on the east by the hills known as the Côtes de Meuse. On the north-east it is watered by the Orne, a tributary of the Moselle, and the Chiers, which runs by Montmédy to join the Meuse. The other half sends its waters to the Seine by the Aire, a tributary of the Aisne, both of which take their rise here, and by the Ornain, an affluent of the Saulx, the two last being tributary to the Marne. The highest elevation (1388 ft.) occurs to the south-west, on the line of the ridge which separates the basin of the Meuse from that of the Seine. The heights gradually sink from south to north, but seldom fall below 1000 ft. The hills of the Argonne similarly sink rapidly down to the valley of the Saulx, where the lowest level of the department (377 ft.) is reached. Its winters are less severe than those of the Vosges, but it is not so temperate as the Seine region. The average annual rainfall is about 30 in. The chief crops of the department are wheat, oats, rye, barley, clover, potatoes and mangel-wurzels. The vine is cultivated to some extent, the best growths being those of Bar. The forests, occupying more than a quarter of the area, are principally of oak, and are rich in game, as are the rivers in fish. Basket-making is prosecuted in the Argonne. The mineral wealth of the department includes good freestone (Euville, Lérerville). It has iron and steel works, wire-works, and manufactories of files, hardware and edge tools. Ligny-en-Barrois (pop. 4879) manufactures scientific instruments. There are cotton-spinning, wool-weaving, and hemp, flax and jute factories, saw-mills, carriage works, leather manufactures, glassworks, paper-mills, distilleries and flour-mills. The department is served by the Eastern railway, the principal lines being that from Paris to Strassburg through Bar-le-Duc and Commercy, that from Paris to Metz through Verdun, and the branch line of the Meuse valley. The chief waterways are the canal connecting the Marne with the Rhine and the Eastern canal along the Meuse valley; the two together have a length of 145 miles. Ecclesiastically the department forms the diocese of Verdun; it has its court of appeal at Nancy, and constitutes part of the district of the army corps of Châlons-sur-Marne, and of the educational division of Nancy. There are 4 arrondissements—Bar-le-Duc, Commercy, Montmédy and Verdun—28 cantons and 586 communes. The principal places in the department are Bar-le-Duc, the capital, Commercy, Verdun and St Mihiel, which receive separate treatment. Other places of interest are Avioth, which has a church of the 14th and 15th centuries with a beautiful chapel of the 15th century adjoining it, and Rembercourt-aux-Pots with a fine church of the 15th century.

MEUSE-LINE, the chain of French forts closing the passages of the Meuse between Verdun and Toul. The total length of the line is 31 m., and the forts *d'arrêt* are disposed along the right bank. The forts are: between Verdun and St Mihiel, Génicourt and Troyon; near St Mihiel, Les Paroches (left bank) and Camp des Romains; and near Commercy—Liouville St Agnant, Gironville and Jouy-sous-les-Côtes. Above the circle of the Toul defences there are barrier forts on the Upper Meuse

at Pagny (la-Blanche-Côte) and near Neufchâteau; but these last are practically in second line, and between Toul and Épinal the frontier districts are designedly left open. At Épinal the "Moselle-Line" begins. These lines form part of the defensive scheme adopted by France in 1873-1875. Their general design is that of the French fort illustrated in FORTIFICATION AND SIEGECRAFT, fig. 43, though they are varied in accordance with the site.

MEVANIA (mod. *Bevagna*), an ancient town of Umbria, on the river Clitumnus and on the Via Flaminia, 8 m. W.S.W. of Forum Flaminii, and 5 m. W. of Fulginium (Foligno), 738 ft. above sea-level. There are remains of a temple near the north gate, and of an amphitheatre built into the modern houses. The walls, which have disappeared, were, according to Pliny (*Hist. Nat.* xxxv. 173), built of unbaked bricks. In 310 B.C. the consul Fabius broke the Umbrian forces here; but otherwise it is not mentioned until the 1st century A.D. In 69 the army of Vitellius awaited here the advance of Vespasian. Its pastures near the river and its white oxen are mentioned by Propertius, whose family belonged to Assisium (mod. Assisi) and after him by Silius Italicus, Lucan and Statius. The town was a *municipium*. The churches of S. Michele Arcangelo and S. Nicolo are Romanesque buildings of the 12th century.

MEW. (1) An imitative word, also spelled *miaou*, representing the cry of a cat or of sea-birds. The name mew, usually sea-mew, as applied to the *Larus canus*, or common sea-gull, is, according to Skeat, also imitative. As the name of the sea-bird it appears in Du. *meeuw*, Ger. *Möwe*, and other languages. (2) (Through Fr. *muer*, from Lat. *mutare*, to change), a term originally applied in French to the moulting of a hawk or falcon, and then to the caging of the bird during that period; thus "to mew up" has come to mean to confine. The English word chiefly survives in the plural form mews, applied to a stable-yard, coach-houses, stalls for horses, and living accommodation, found in narrow streets in large towns. This use was due to the Royal Mews at Charing Cross, where the royal hawks were kept from 1377 to 1537, when the building became the royal stables.

MEWS, PETER (1610-1706), English royalist and divine, was born at Caundle Purse in Dorset on the 25th of March 1619, and was educated at the Merchant Taylors' school, and at St John's College, Oxford, of which he was scholar and fellow. When the Civil War broke out in 1642 he joined the Royalist army, and, having been made a captain, was taken prisoner at Naseby; but he was soon released and in 1648 sought refuge in Holland. He became friendly with Charles I.'s secretary, Sir Edward Nicholas, and being skilful at disguising himself was very useful to the Royalists during the rule of Oliver Cromwell, undertaking two journeys to Scotland in 1653. Before this Mews had been ordained. Taking the degree of D.C.L. and regaining his fellowship at Oxford after the Restoration, he became archdeacon of Huntingdon, vicar of St Mary's, Reading, and chaplain to the king; then, having obtained two other livings, he was made canon of Windsor, canon of St David's, and archdeacon of Berkshire. In 1667, when at Breda arranging peace between England and Holland, he was chosen president of St John's College, Oxford, in succession to his father-in-law, Dr Richard Baylie, afterwards becoming vice-chancellor of the university and dean of Rochester. Appointed bishop of Bath and Wells in 1672, Mews resigned his presidency in 1673, and in 1684 he was elected bishop of Winchester, a position which this "old, honest cavalier," as Thomas Hearne calls him, filled until his death on the 9th of November 1706. The bishop is buried in Winchester cathedral. Mews lent his carriage horses to pull the cannon at a critical moment during the battle of Sedgemoor, where he was wounded whilst accompanying the royal army. He was, however, in sympathy with the seven bishops, and was only prevented by illness from attending their meeting; and as visitor of Magdalen College, Oxford, he supported the fellows in their resistance to James II., admitted their nominee, John Hough, to the presidency, and restored the ejected fellows in October 1688.

He took the oaths to William and Mary in 1689. In the absence of Compton, bishop of London, Mews took the chief part at the consecration of Tillotson as archbishop of Canterbury in 1691.

See S. H. Cassan, *Lives of the Bishops of Winchester* (1827); and the *Nicholas Papers*, edited by G. F. Warner (1886-1897).

MEXBOROUGH, an urban district in the West Riding of Yorkshire, England, on the Don, 11 m. N.E. of Sheffield on the Great Central and Midland railways. Pop. (1891), 7734; (1901), 10,430. The Don affords water communication with the Humber. The church of St John the Baptist has Early English portions. The large industrial population is mainly employed in glass, pottery and iron works, and in the neighbouring stone-quarries. The Castle Hill is crowned with some fine earthworks of uncertain date.

MEXICO (Span. *Méjico*, or *Mexico*), officially styled *Estados Unidos Mexicanos* and *República Mexicana*, a federal republic of North America extending from the United States of America southward to Guatemala and British Honduras, and lying between the Pacific Ocean on the west and the Gulf of Mexico and Caribbean Sea on the east. Its northern boundary line was fixed by the Guadalupe-Hidalgo treaty of 1848 and the Gadsden treaty of 1853; it follows the Rio Grande del Norte from its mouth north-westward to lat. $31^{\circ} 47' N.$, thence on that parallel W. 100 m., thence S. to lat. $31^{\circ} 20' N.$, thence due W. to the 11th meridian, thence in a straight line (nearly W.N.W.) to a point on the Colorado river 20 m. below the mouth of the Gila river, thence northward to the mouth of the Gila, and thence, nearly due W., along the old line between Upper and Lower California to a point on the Pacific coast one marine league S. of the southernmost point of San Diego Bay; this line has a total length of 1810 m., of which the Rio Grande comprises 1136 and the land route 674 m. The boundary line with Guatemala, for a long time in dispute, was fixed by the treaties of 1882 and 1895. It is an arbitrary line and follows only two natural lines of demarcation—the Suateh river from the Pacific coast to its source, and the Chixoy and Usumacinta rivers from near the 16th parallel N.W. to a point on the latter 25 kilometres, S. of Tenosique (Tabasco). Between these rivers the boundary line is determined by the peaks of Tacaná, Buenavista and Ixbul, and from the Usumacinta eastward it follows two parallels of latitude, one on the point of departure from that river, and the other, the longer, on that of $19^{\circ} 40'$ to the British Honduras frontier. The boundary with British Honduras was determined by a treaty of 1803 and is formed in great part by the Hondo river down to the head of Chetumal Bay, and thence through that bay to the Boca Bacalar Chica—the channel separating Yucatán from Ambergris Cay. Geographically, Mexico extends from $14^{\circ} 30' 42''$ (the mouth of the Suateh) to $32^{\circ} 42' N.$ lat., and from $86^{\circ} 46' 08''$ to $117^{\circ} 07' 31'' W.$ long. Approximately its greatest length from N.W. to S.E. is 1900 m., its greatest width 750 m., and its least width a little short of 140 m. In outline it is sometimes compared to a huge cornucopia with its small end curving S.E. and N. The interior curve formed by the Gulf of Mexico is comparatively regular and has a coast-line of about 1400 m. The Caribbean coast-line is about 327 m. long, exclusive of indentations. The outer curve facing the Pacific is less regular, is deeply broken by the Gulf of California, and has a coast-line of 4574 m., including that of the Gulf. The peninsula of Lower California (*q.v.*) lies parallel with the mainland coast and extends southward to about $22^{\circ} 52' N.$ lat., a distance of nearly 760 m. The area of Mexico is commonly given by English authorities as 767,005 sq. m., by German statisticians as 1,987,201 sq. kilom. (767,290 sq. m.), and by H. H. Bancroft, who quotes official figures, as 1,962,899 sq. kilom. (757,907 sq. m.).

Physiography.—The surface features consist of an immense elevated plateau with a chain of mountains on its eastern and western margins, which extends from the United States frontier southward to the Isthmus of Tehuantepec; a fringe of lowlands (*tierras calientes*) between the plateau and coast on either side; a detached, roughly mountainous section in the south-east, which belongs to the Central American Plateau, and a low sandy plain

covering the greater part of the Isthmus of Yucatán. The peninsula of Lower California is traversed from north to south by a chain of barren mountains which covers the greater part of its surface. The slopes are precipitous on the east coast, but on the west they break down in hills and terraces to the Pacific. This range may be considered a southward continuation of the Californian Sierra Nevada. The great plateau of Mexico is very largely of volcanic origin. Its superstructure consists of igneous rocks of all descriptions with which the original valleys between its marginal ranges have been filled by volcanic action. The remains of transverse and other ranges are to be seen in the isolated ridges and peaks which rise above the level of the table-land, in some cases forming well-defined basins; otherwise the surface is singularly uniform in character and level. The two noteworthy depressions in its surface, the Valley of Mexico and Bolsón de Mapimí, once contained large bodies of water, of which only small lakes and marshy lagoons now remain. The highest part of this great plateau is to be found in the states of Mexico and Puebla, where the general elevation is about 8000 ft. Southward the slope is broken into small basins and terraces by transverse ranges, and is comparatively abrupt. Northward the slope is gentle, and is broken by several transverse ridges. At Ciudad Juárez (adjoining El Paso, Texas), on the northern frontier, the elevation is 3600 ft., which shows a slope of only $\frac{1}{4}$ ft. to the mile. Less is definitely known of the elevated regions of Chiapas, on the border of Guatemala, which are separated from the great Mexican Plateau by the low Isthmus of Tehuantepec (718 ft. at the highest point of the transisthmian railway), but the general elevation is much lower, and they are broken by wooded sierras, and eroded by water-courses.

The mountain ranges which form part of the great Mexican Plateau consist of two marginal chains known as the Sierra Madre Occidental, on the west, the Sierra Madre Oriental, on the east, and a broken, weakly-defined chain of transverse ranges and ridges between the 18th and 20th parallels known as the Cordillera de Anáhuac. All these chains are known locally under diverse names. The Sierra Madre Occidental consists of several parallel ranges in the north, where a broad belt of country is covered with a labyrinth of ridges and valleys. The most easterly of these is known as the Sierra Tarahumana and Sierra de Durango, and the most westerly as the Sierra del Nazareno, Sierra Yaqui and Sierra Fuerte. These converge in southern Sinaloa and Durango to form the Sierra de Nayarit. Near the 20th parallel the great chain again divides, the eastern part crossing the southern end of the plateau, and the western, or Sierra Madre del Sur, following the shore line closely to Tehuantepec. The Sierra Madre Occidental has but few noteworthy elevations, its culminating points being the Nevado de Colima (14,363 ft.) and Volcán de Colima (12,750 ft.) in the state of Jalisco. In the Sierra de Nayarit the Cerro Sinaloa rises to an elevation of 11,119 ft. above the sea, and in the extreme south-eastern end to 10,302 ft. These sierras lying near the coast have an imposing appearance from the lowlands, but when seen from the plateau their general elevation is so dwarfed as to render them comparatively inconspicuous. The Sierra Madre Oriental consists of a broken chain of ranges extending along the eastern margin of the plateau from the great bend in the Rio Grande south-eastward to about the 19th parallel. In the north these ranges are low and offer no great impediment to railroad building. South of Tampico, however, the peaks are concentrated in a single lofty range. This range extends southward along the coast to the state of Veracruz (state) and includes the snow-capped cone of Orizaba or Citlatépetl (18,209 ft.), and the Cofre de Perote, or Nanchampapetl (13,419 ft.). The eastern slopes are abrupt and difficult, and are a serious impediment to communication with the coast. Rising from the open plateau half way between this range and the city of Mexico is the isolated cone of Malinche, or Malintzin (14,636 ft.). Crossing the highest part of the Mexican Plateau is a broken series of ranges, which form the water-parting between its northern and southern slopes. To a part of these ranges has been given the name *Ci Cordillera de Anáhuac*, but there is no true cordillera northward to Mexico. In a general sense these ranges may be considered part of the eastern branch of the Sierra Madre Occidental, which turns eastward on the 20th parallel and crosses the plateau in a south by east direction. Southward the plateau is traversed by many low ranges and breaks down in terraces, forming one of the most fertile and attractive parts of the republic. Close to the capital are the Sierra de Ajusco, whose highest point is 13,078 ft. above sea-level, the Nevado de Toluca (15,168 ft.), in a range which separates the valleys of Mexico and Toluca, the Monte de las Cruces, and that volcanic, snow-capped range, running northward at right angles to the axis of the other ranges, whose culminating points, some 20 m. south-east of the city, are the gigantic, snow-clad volcanoes of Popocatepetl (Smoking Mountain) and Ixtaccihuatl (White Woman). Both of them are extinct and Popocatepetl no longer smokes. Their elevations, according to the Comisión Geográfica Exploradora, are 17,888 and 17,343 ft. respectively, that of Ixtaccihuatl being the highest of its three crests. This part of Mexico is highly volcanic in character, the transverse ridge just described having a large number of extinct volcanoes and at least three (Colima, Jorullo and Guatuzaco) that are either active or semi-active. Colima was in a state of eruption as late as 1909,

Jorullo (4262 ft.) is said to date from 1759, when its cone was formed, and Cebrucos (7100 ft.) in the territory of Tepic, shows occasional signs of activity. Near the coast in the state of Vera Cruz is San Martin, or Tuxtla (9708 ft.), which has been quiescent since its violent eruption of the 2nd of March 1793. Orizaba is sometimes included among the semi-active volcanoes, but this is a mistake. It has been quiescent since 1566, and is now completely extinct. Earthquakes are common throughout the greater part of the Republic, especially on the western coast. They are most violent from San Blas southward to the Guatemala frontier, and some of the Spanish towns on or near this coast have suffered severely. Chilpancingo, in Guerrero, was badly shattered in 1902, and in 1907, and in 1909 was reduced to a mass of ruins. The earthquake shocks of the 30th and 31st of July 1909 were unusually severe throughout southern Mexico, reducing Acapulco and Chilpancingo to ruins and shaking the city of Mexico severely. In Acapulco a tidal wave followed the shock. Slight shocks, or *temblores*, are of almost daily occurrence. According to Humboldt's theory there is a deep rent in the earth's crust about the 19th parallel through which at different periods the underground fires have broken at various points between

the largest of this class, and has the town and port of Cármen at its western extremity. On the northern coast of Yucatán is the small, inhabited island of Holbox or Holboy, and on the eastern coast the islands of Mujeres, Cancun and Cozumel, of which the first and last have a considerable population and good ports. On the Pacific coast there are a number of islands off the rocky shores of Lower California and in the Gulf of California—most of them barren and uninhabitable like the adjacent coast. The largest of these, some of them inhabited, are: Guadalupe—about 75 m. west of the coast on the 29th parallel, which is fertile and stocked with cattle; Cerros, off Viscaino Bay, and Santa Margarita, which partly shelters Magdalena Bay, on the Pacific side; and Angel de la Guardia, Tiburón, San Marcos, Cármen, Monserrate, Santa Catalina, Santa Cruz, San José, Espíritu Santo and Cerralvo in the Gulf. Lying off San Blas in the broad entrance to the Gulf are the Tres Marias, and directly west of Colima, to which it belongs, is the scattered volcanic group of Revillagigedo.

The peculiar surface formation of Mexico—a high plateau shut in by mountain barriers, and a narrow lowland region between it and the coast—does not permit the development of large river

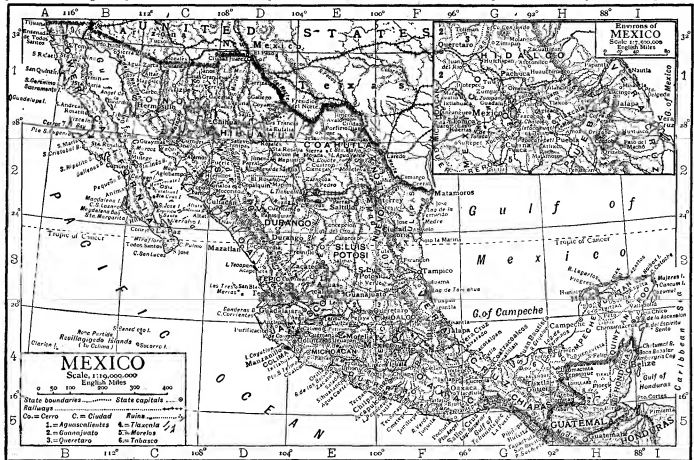

the Gulf of Mexico and the Revillagigedo Islands. "Only on the supposition that these volcanoes, which are on the surface connected by a skeleton of volcanic rocks, are also united under the surface by a chain of volcanic elements in continual activity, may we account for the earthquakes which in the direction mentioned cause the American continent, from the Gulf of Mexico to the Pacific Ocean, to oscillate at the same time" (*Engelstein*, p. 37).

The lowland or *tierra caliente* region, which lies between the sierras and coast on both sides of Mexico, consists of a sandy zone of varying width along the shore-line, which is practically a tide-water plain broken by inland channels and lagoons, and a higher belt of land rising to an elevation of about 3000 ft. and formed in great part by the debris of the neighbouring mountain slopes. On the Pacific side there are places where the mountain spurs extend down to the coast, but in general this lowland region ranges from 30 to 40 m. in width, except in southern Vera Cruz, Tabasco, Campeche and Yucatán, where it extends farther into the interior. The talus zone of this region, especially at elevations of 1000 to 3000 ft., is noted for its great fertility and the luxuriance of its vegetation.

There are no large islands on the coast of Mexico, and most of the smaller ones are unimportant. Many of those that fringe the Gulf coast are sand-keys, or parts of a new coast formation. They are commonly barren and uninhabitable. The Isla del Cármen, which partly shuts in the Laguna de Términos (Campeche), is one of

basins. Add to this the light rainfall on the plateau and a lack of forests, and we have conditions which make large rivers impossible. The hydrography of Mexico, therefore, is of the simplest description—a number of small streams flowing from the plateau or mountain slopes eastward to the Gulf of Mexico and westward to the Pacific. Most of these are little more than mountain torrents, but one has a course exceeding 500 m., and few have navigable channels. The principal watershed is formed by the sierras of the state of Mexico, from which streams flow north-east to the Gulf of Mexico, north-west to the Pacific and south-west to the same coast below its great eastward curve. The Rio Grande del Norte, or Rio Bravo, on the northern frontier, is practically an American river, as it rises in American territory and receives very little water from the Mexican side. Its larger Mexican tributaries are the Rio de los Conchos, Salado and Pesqueria. Of the Suchiate and Honda, which form part of Mexico's southern boundary, the first is a short, impetuous mountain torrent flowing into the Pacific, and the other a sluggish lowland stream rising in north-eastern Guatemala and flowing north-east through a heavily forested region to Chetumal Bay. The peninsula of Yucatán has no rivers, and that of Lower California only a few insignificant streams in the north. This is due to the porosity of the soil in the former, and the very limited rainfall in the latter. The largest rivers of Mexico are: the Rio Grande de Santiago, called the Lerma above Lake Chapala, rising in the state of Mexico and flowing westward across Guanajuato, Jalisco and

Tepic to the Pacific coast, with a total length of 540 m., celebrated for its deep canyons and waterfalls; the Rio de las Balsas, or Mescala, which rises in Tlaxcala and flows south and west to the Pacific with a course of 426 m.; the Yaqui, which rises in western Chihuahua and, after breaking through the northern ranges of the Sierra Madre Occidental, flows south-westerly across Sonora to the Gulf of California, with a length of 390 m.; the Grijalva, also called the Chiapas on its upper course, which has its sources in the state of Chiapas and flows north-west and north across Tabasco to the Gulf of Mexico with a total length of 350 m.; the Usumacinta, which rises in southern Chihuahua and, after breaking through the sierras, flows south-west across Sinaloa to the Gulf of California, with a course of 340 m.; the Usumacinta, which is formed by the confluence of the Chixoy and Pasión on the east frontier of Chiapas, and flows north-west across Tabasco to the Grijalva, with a course of 330 m.; and the Pánuco, which has its source in the north-west of the state of Mexico and flows north-eastward to the Gulf of Mexico. The rivers of the Pacific coast have no navigable channels worth mentioning, but many on the Gulf coast are navigable for considerable distances. The more important of these are in Tabasco—the Grijalva, navigable for about 90 m., and the Usumacinta, for about 270 m. The country about the Laguna de Términos is low and flat, and is traversed in all directions by deep, sluggish streams. Many of the rivers crossing the lowlands bordering the Gulf have short navigable channels, the most important of which is the Pánuco and its tributaries. The Rio Grande is navigable for small vessels up to Matamoros (31 m.), and for smaller craft 65 m. farther. Nearly all the Gulf coast rivers, however, are obstructed by bars owing to the quantity of silt brought down from the sierras and the prevailing winds and currents of the coast.

The lakes of Mexico are small and few in number. They may be divided into two classes, those of the plateau region which occupy lacustrine depressions and receive the drainage of the surrounding country; and the tide-water lagoons of the coast formed by the building up of new sand beaches across the indentations in the coast-line. Of the former, the best known are the lakes of the Valley of Mexico—Texcoco, Chalco, Xochimilco, Zumpango, Xaltocán and San Cristóbal—which are probably the remains of a lake once occupying the whole valley. They receive considerable surface drainage, but are slowly diminishing in area. Some of them, like the latter, will eventually disappear. The Texcoco, has an area of about 11½ sq. m. (30 sq. kilom.), but it covered a much larger area at the time of the Spanish conquest. Its surroundings are bleak and sterile and its waters brackish and polluted with the drainage of the neighbouring city for nearly four centuries. The other lakes are wholly different in character and surroundings, especially Chalco and Xochimilco. Texcoco is now connected with the new drainage works of the capital and is no longer a menace to its population through inundations and pestilential fevers. Another group of lakes is to be found in the Laguna Colorado of south-western Coahuila, where the Tlaxiá, Matran, Parras and others occupy a large lacustrine depression and receive the waters of the Nazas and Aguanaul rivers from the south-west (Durango). The size of this isolated drainage basin is very large, the Nazas River alone having a length of about 370 m. The great Mapimí desert of western Coahuila is another lacustrine depression, but only marshy lagoons remain. In eastern Coahuila, near Monclova, are the Agua Verde and Santa María lakes, and in eastern Chihuahua there is a similar group. The largest and most attractive of the plateau lakes is Chapala, in the state of Jalisco, about 80 m. long by 10-35 m. wide, which receives the waters of the Sierra Madre Occidental. The Pacific through the Santiago. On the lower terraces of Michoacán are Patzcuaro and Cuicatzen lakes, and elsewhere among the sierras are numerous other small bodies of water. Among the tide-water lagoons, of which there are many along the Gulf coast, the best known are the Laguna de Términos in Campeche, Tamiahua in Vera Cruz, Madre (130 m. long), Pesquerías (21 m. long) and Chairel (near Tampico) in Tamaulipas. All these lagoons are navigable, and those of northern Vera Cruz and Tamaulipas, when connected and improved, will afford a safe inland route for some hundreds of miles along the coast. The north coast of Yucatán is remarkable for the extensive banks built up by the Gulf current from 5 to 7 m. from the shore-line. Inside the present sandy coast is a peculiar tide-water channel called the Rio Lagartos, which follows almost the whole northern shore, with occasional openings or bocas, connecting with the open sea. It is apparently of the same character as the lagoons of Tamaulipas. There are a number of these lagoons on the Pacific coast—such as Superior and Inferior near Salina Cruz, Papacayo, near Acapulco, Cayutlan, near Manzanillo, and Tecapan in Tepic—but they are usually shallow, sometimes swampy, and have no value for commerce.

There is a marked difference between the Gulf and Pacific coast-lines of Mexico in regard to their minor indentations and harbours. The south-west part of the Gulf of Mexico is called the Gulf of Campeche (Campechy), but no distinction is necessary. This coast has no bays of importance, its rivers are obstructed by sandbars, and it has only one natural harbour—that of Cármen and the Laguna de Términos, which has sufficient depth for the larger classes of vessels and is sheltered by the islands of Cármen and

Puerto Real. Of the principal ports on this coast, Matamoros, Tampico, Tuxpan, Coatzacoalcos and Frontera are on rivers, which are obstructed by bars. Tampico and Coatzacoalcos, however, have been improved by breakwaters or jetties, and the deepening of the Channels across the bars, into safe and commodious harbours. Vera Cruz is an open anchorage inside a series of reefs which afford no protection to vessels from the "northers." A breakwater has remedied this defect and Vera Cruz is no longer considered a dangerous port. Tampico has a small artificial harbour, which is so silted up that vessels drawing 9 ft. must anchor 1 m. outside and larger vessels still farther away. Progreso, Yucatán, has only an open roadstead, and large vessels cannot approach its landing-place nearer than 6 m. On the east coast of Yucatán there are two deep, well-sheltered bays, Ascension and Espíritu Santo, which afford good anchorages, and at the north end of the island of Cozumel the bay of Santa María offers an excellent harbour. The Pacific coast has several deep and well-sheltered bays; but they are separated from the interior by the rough and difficult ranges of the Sierra Madre Occidental. There are two large indentations of the coast—the Gulfs of Tehuantepec and California. The former is opposite the Gulf of Campeche, and possesses no distinguishing characteristic. The Gulf of California, on the other hand, penetrates the continent for a distance of 730 m., from south-east to north-west, with a maximum breadth of 190 m. Its area is usually restricted to the waters north of the latitude of Cape San Lucas, but it should be extended to the outer waters enclosed by a line from Cape San Lucas to Cape Corrientes. Its upper waters are not much navigated because of the aridity of its coasts, but there are two or three important ports towards the south. The Gulf of California has considerable lands, most of them near the peninsular coast, and several deep, well-protected bays—those of La Paz and Santa Inés in Lower California, Guaymas in Sonora, Agioabampo, Topolobampo and Altata Salinas in Sinaloa. On the Pacific coast of Lower California are the Ensenada de Todos Santos and the bays of San Quentin, Viscaíno and Magdalena. The principal bays on the mainland coast are Olas Atlas, which is the harbour of Mazatlán, San Blas, Banderas, Manzanillo, Acapulco, Salina Cruz and Tonala. Several of these are being improved.

Geology.—By far the greater part of Mexico is covered by deposits of Cretaceous and later date, the pre-Cretaceous rocks occurring only in comparatively small and isolated patches. At the southern extremity of the great table-land, however, in the state of Puebla, there is a considerable mass of crystalline rocks which is believed to be of Archaean age. Similar rocks occur also in Chiapas, Oaxaca, Guerrero and elsewhere; but owing to the absence of any early fossiliferous deposits, the age of these rocks is very uncertain. Silurian and Devonian fossils have been reported at one or two localities, but for the present the observations are open to doubt. The earliest fossiliferous beds which have been proved to exist in Mexico belong to the Carboniferous system. They are found on the borders of Guatemala and consist of limestones and dolomites with *Productus*.

The Mesozoic beds are of greater importance. The Triassic and Jurassic systems are met with only in scattered patches. The former consists of sandstones and clays, and the fossils found in them are chiefly plants, including *Gangamopteris* and *Macrotaeniopteris*, two characteristic genera of the Indian Gondwana system. The Jurassic beds are marls, sandstones and limestones, which contain marine fossils. The Cretaceous rocks take a far larger share in the formation of the country. They form the greater part of the Sierra Madre Oriental and also cover most of the central plateau. They contain many fossils, including Hippurites and Ammonites. The sedimentary deposits of the Tertiary era do not occupy a very wide area. They occur, however, along the coasts, where they are marine, and also on the central plateau, where they are of lacustrine origin. But by far the most important of the Tertiary rocks are the volcanic lavas, agglomerates and ashes, which cover so much of the country. It is in the western half of Mexico that they are most fully developed, but towards the southern extremity of the plateau they spread nearly to the eastern coast. The eruptions are said to have begun with the ejection of syenites, diorites and diabases which probably took place at the close of the Cretaceous or the beginning of the Eocene period. In the Miocene period andesites of various kinds were erupted, while at the close of the Pliocene began the great eruptions of basalt which reached their maximum in Quaternary times and continue to the present day. (P. L.A.)

Climate.—Mexico stretches across 17 parallels of latitude, with the Tropic of Cancer crossing her territory about midway. This implies tropical and sub-tropical conditions. The relief of the land and the varying degrees of rainfall and vegetation, however, serve to modify these conditions in many important particulars. The elevation and extent of the great central plateau, which penetrates

¹ See J. G. Aguilera, *Sinopsis de geología mexicana*; "Bosquejo geológico de México," segunda parte, Bol. inst. geol., Mexico, Nos. 4-6 (1897), pp. 180-270, with map—a summary of this paper will be found in *Science Progress*, new series (1897), vol. i, pp. 609-615. See also the *Liwet-guide* of the Tenth Cong. Geol. Interior. (1906).

deeply into the tropical half of the country, carry with them temperate and sub-tropical conditions over much the greater part of the republic. Above the plateau rise the marginal sierras, while a few isolated peaks in the region of perpetual snow give to Mexico a considerable area of cold temperate and a trace of arctic conditions. Descending to the lowlands on either side of the plateau, the temperature rises steadily until the upper limit of the tropical region, called *tierras calientes*, is reached, where the climate is hot, humid and unhealthy, as elsewhere in the forested coastal plains of tropical America.

The *tierras calientes* (hot lands) of Mexico include the two coastal zones, the Isthmus of Tehuantepec, the states of Tabasco, Campeche, and part of Chiapas, the peninsula of Yucatán and a part of eastern Oaxaca. The mean temperature ranges from 77° to 82° F., seldom falling below 60°, but often rising to 105°, and in the sultry districts of Vera Cruz, Guaymas and Acapulco to and even above 110°. The rainfall is heavy in the south, except Yucatán, but diminishes gradually toward the north, until on the Pacific and Gulf of California coasts it almost disappears. These lowland districts are densely forested in the south, except Yucatán, and the large areas are covered with streams, swamps and lagoons, and abound with noxious insects, pestilential fevers and dysentery. On both coasts yellow fever epidemics appear at frequent intervals. The great fertility of these regions and the marvellous wealth of their forests are irresistible attractions to industrial and commercial enterprise, but their unhealthiness restricts development and is a bar to any satisfactory increase in population. The heavy rainfall on the Gulf coast, however, which reaches a maximum of 90 to 100 in. in the Huatusco district of Vera Cruz, causes the flooding of large areas of lowlands, and will make improvement very difficult. The peninsula of Yucatán, whose general level does not rise above 100 to 200 ft., consists almost wholly of an open, dry, calcareous plain. The temperature ranges from 66° to 89°, but the heat is tempered by the cool sea-breezes which sweep unobstructed across its plains. The rainfall is abundant in the rainy season, but in the long dry season it is extremely rare. In the wet season the rain is quickly absorbed by the dry, porous soil; consequently there are no rivers and no lakes except near the forested region of the south-east. These exceptional conditions give to Yucatán a moderately hot, dry, and comparatively healthful climate. Another hot, dry climate is that of the *tierras calientes* of Sonora. The coast is extremely arid, and would be uninhabitable were it not for the proximity of the Sierra Madre, where a little rainfall is experienced, and for the numerous rivers that cross the arid belt between the mountains and the sea. The maximum temperatures in this region are 98° at Hermosillo and 119° at Guaymas.

To a large extent the climate of Mexico is determined by vertical zones. According to H. H. Bancroft (*Resources of Mexico*, pp. 3-4), the *tierras calientes*, which include a coastal zone 30 to 40 m. wide and the low-lying states already mentioned, rise from sea-level to an elevation of 3280 ft. The *tierra templada*, or sub-tropical zone, rises to an elevation of 5577 ft., and comprises "the greater portions of Coahuila, Nueva León, San Luis Potosí, nearly half of Tamaulipas, a small part of Vera Cruz, nearly the whole of Chiapas, nearly all of Oaxaca, a large portion of Guerrero, Jalisco, Sinaloa and Sonora," together with small parts of the inland states of Puebla, Mexico, Morelos and Michoacán. The mean annual temperature is about 75°. Above this is the *tierra fría*, which ranges from 5577 to 8200 ft., and includes all the higher portions of the Mexican plateau, and which corresponds to the temperate regions of Central United States where frosts are very rarely experienced. Even here the high sun temperatures give a sub-tropical character to the *tierra fría*. Mountains above the *tierra fría* of the whole republic up to all, are the older climates of the temperate zone, suitable for cereals, grazing and forest industries, and, farther up, the isolated peaks which rise into the regions of snow and ice.

Speaking generally, the four seasons are clearly marked north of lat. 28° N. only. South of that parallel they merge in the *estación de las aguas*, or rainy season, from May to October, and the *estación seca*, or dry season, which prevails for the rest of the year. The rains generally begin on the east coast and gradually move northwards. The windward slopes of the Sierra Madre Oriental receive the greater part of the rainfall, and the winter portions of the moisture pass over the northern plateau without further precipitation. On the Pacific coast the belt of clouds, known as the northern horse latitudes, crosses the northern parts of Lower California and Sonora, which accounts for their extreme aridity. The southern terraces of the plateau have no high mountain barriers between them and the moist winds of the Caribbean, and they too receive an abundant rainfall in the wet season, especially during the prevalence of heavy "northers" on the Gulf coast. The precipitation varies widely, that of the western side of the northern plateau (Chihuahua and Durango) being about 39 in., that of the Valley of Mexico about 60 in., and that of the whole republic up to 1 in. Low droughts are common in many parts of the country, and on the barren surfaces of the plateau the rains drain away rapidly, leaving but slight beneficial results.

Flora and Fauna.—The types of animal and vegetable life found in Mexico belong, in a general sense, to those of the northern temper-

ate region, and those of the tropical regions of Central and South America. The great central plateau and its bordering lowlands form an intermediate territory in which these dissimilar types are found side by side, the tropical species extending northward along the coast to the United States, while the northern species have found their way to the southern limits of the plateau. The jaguar and puma have found their way into the United States, while the wolf, coyote, bear and beaver have gone far southward on the plateau, and the buffalo was once found in large numbers on its more favoured northern plains. This intermingling of types does not apply to south-eastern Mexico, where animal life is represented by many of the genera and species found in the forested lowlands of the great Amazon basin.

Aside from its origin, the fauna of Mexico includes at least five species of monkey, the jaguar, puma, ocelot (*Felis pardalis*), wolf, coyote, lynx, badger, otter (*Lutra felina*), beaver, muskrat, bear, raccoon (*Procyon*), coati (*Nasua*), tapir, two species of peccary (*Dicotyles torquatus* and *D. labialis*), skunk (*Mephitis*, *Spilogale* and *Conopys*), marten, several species of opossum (including a pigmy species of the Tres Marias islands), sloth, two species of ant-bear (*Myrmecophaga tetradactyla* and *Cyclothorus didactylus*), armadillo (*Dasyurus novemcinctus*), a small arboreal porcupine (*Syntheres mexicanus*), the kinkajou (*Cercopithecus caudivolutus*), three species of deer—the white-tailed *Caracus toltecus*, the little black-faced brocket, *Coassus rufinus*, which is also found in Brazil, and the Sonora deer (*Odocoileus couesi*)—the Mexican bighorn (*Ovis mexicanus*) of Chihuahua, at least two species of hare (*Lepus calotis* and *L. palustris*), rabbits, black, gray, red and ground squirrels, gophers, and many small rodents. Alligators and crocodiles are numerous in the lagoons and rivers of the coast and the iguana is to be found everywhere throughout the tropical lands, the large black *Ctenosaura acanthinurus* being partly arboreal in habit when full grown. Mexico is a paradise of lizards, which are noted for their diversity in form as well as for their remarkable colouration. Frogs and toads are represented by scores of species, some of which, e.g. the tree-frogs (*Hylidæ*), are extremely interesting. The ophidians are also very numerous, ranging from the comparatively harmless boa-constrictor to the deadly "palanca" or "fer de lance" (*Lachesis lanceolatus*) and rattlesnake (*Crotalus*), of which there are several species. In southern Mexico (in 1902 and 1904 Hans Gadow collected specimens of 44 different kinds of snakes, which he estimated to be 90 per cent. of the species known in the country visited. The arboreal life of the tropical forests has developed the tree-climbing habit among snakes as well as among frogs and toads, and also the habit of mimicry, their colour being in harmony with the foliage or bark of the trees which form their "hunting-grounds." Bats are numerous, both in species and individuals. The sanguinary vampire (*Desmodus rufus*) has an extensive range through the *tierras calientes* and *tierras templadas* of the southern states. The coasts of Mexico, together with their accessible lagoons and rivers, afford innumerable breeding-places for turtles, which include the large green and tortoise-shell species, in some places the capture of the latter is the source of a considerable export trade in tortoise-shell. The coast of Lower California is a favourite resort for the fur-bearing seal, and pearl oysters find a congenial habitat in the south waters of the Gulf. There are some good fishing-grounds on the coasts, but fishing as an organized industry does not exist. The inland waters, with the exception of Lake Chapala, have comparatively few species, but the government has introduced carp, brook-trout and salmon-trout.

The avifauna of Mexico includes most of the species of the tropical and temperate regions of America—such as parrots (chiefly the yellow-crowned *Aratinga canicularis*, parakeets *Cyanocitta stelleri*, macaws *Art macao* and *A. militaris*), toucans, trogons, herons, cormorants, spoonbills, boat-bills (*Cancroma*), ducks, pelicans, cormorants, bitterns, stilts, sandpipers, curlews, grackles, kingfishers, motmots, "Chachalacas" (*Oriolida poliocephala*), woodpeckers, jays, cuckoos, "garter-pateros" (*Crotaphaga sulcirostris*), the ingenious weaver-bird (*Cassicus*), and another species (*Cassicus*), whose curiously woven, sack-like nests are suspended from the slender limbs of trees, and sometimes even from telegraph-wires, scarlet-crested fly-catchers (*Muscivora mexicana*), tanagers, mocking-birds (called "zenzontl"), turkeys, partridge, quail (*Colinus*, *Lophortyx*, *Callipepla* and *Cyrtonyx*), doves, pigeons, and caracaras (*Myadestes occidentalis*), flycatchers, falcons, crows, and turkey-buzzards (both the red-faced "aura" of North America and the black-faced "zopilote" of the tropics), which are the scavengers of the country. The most numerous, perhaps, are the humming-birds, of which there are many genera and species, each one distinct in form and colour. They are called "huitzilín" (spikelet) by the Aztecs, and "colibrí," "chupaflores" and "chupa-miel" (flower- or honey-sucker), and "pájaro-mosca" (fly-bird) by the Spanish-speaking Mexicans. These descriptive names are highly poetic, as also that of the Portuguese, "beija-flor" (flower-kisser); but the humming-bird is an insectivorous, not a nectar-feeding bird, and its flowers are not its source of honey. Mexico is credited with a great variety of song-birds, but these are to be found chiefly in the partly-forested country of the *tierras templadas* and *tierras frías*. Her chief distinction, however, is in birds of varied and gorgeous feathering. The wonderful plumage of the "quetzal" (*Trogon resplendens*) was, it is said, reserved

by the Aztec rulers for their own exclusive use. Of the indigenous birds, the turkey has been fully domesticated, and the musk-duck and "chachalaca" are easily reared. Sea-fowl are most numerous on the coasts of Lower California, where certain islands in the arid belt are frequented at night by countless numbers of them. It should be added that many of the migrating birds of North America pass the winter in Mexico.

The insect fauna of Mexico covers a very wide range of genera and species which like the other forms of animal life, is largely made up of migratory types. No complete study has ever been made of this fauna, but much has been, and is being done by the U.S. Biological Survey and Plant Industry Bureau. To the traveller, the most conspicuous among the Mexican insects, perhaps, are the butterflies, beetles, ants and the myriads of mosquitoes, midges, fleas and chinchas. Among the mosquitoes, which are extraordinarily numerous in some of the hot lowland districts, are the species contrasted with the spread of malarial and yellow fevers. The midges are even more numerous than the mosquitoes. In pleasing contrast to such pests are the butterflies of all sizes and colours, beetles of an inconceivable variety of size, shape and colouration, and ants of widely dissimilar appearance and habits. An interesting species of the last is the leaf-cutting ant (*Eciton*) which lives in large underground colonies and feeds upon a fungus produced by leaf-cuttings stored in subterranean passages to promote fermentation. These ants will strip a tree in a few hours and are very destructive to fruit plantations. Some of the native trees have developed ingenious methods of defence, one of which is that of attracting the colonies of another species to drive away the marauders. Most destructive, also, are the termites or white ants, whose ravages are to be seen in the crumbling woodwork and furniture of all habitations in the hot zones. Some species build their nests in trees—great globular masses sometimes three feet in diameter, supported on the larger branches, and connected with the ground by covered passages on the outside of the tree. These insects are blind and avoid the light. Bees find a highly congenial habitat in Mexico, and some honey is exported. Spiders are also represented by a large number of genera and species, the most dreaded being the venomous "tarantula" and the savage "mygale."

Five countries, if any, can present so great a diversity in plant life as Mexico. This is due not only to its geographical position and its vertical climatic zones, which give it a range from tropical to arctic types, but also to its peculiar combination of humid and arid conditions in which we find an extensive barren table-land interposed between two tropical forested coastal zones. These widely divergent conditions give to Mexico a flora that includes the genera and species characteristic of all the zones of plant life. The western extremity is the tropical jungle of the lowland coastal plains with its rare cabinet-woods, dye-woods, lianas and palms; the semi-tropical and temperate mountain slopes where oak forests are to be found and wheat supplants cotton and sugar-cane; and above these the region of pine forests and pasture lands. Then, there are the mangrove-fringed coasts and the dripping wooded slopes where rare orchids thrive, and above these, on the inland side of the sierra, a treeless, sun-scorched table-land where only the cactus, yucca, and other coarse vegetation of the desert can thrive without irrigation.

For convenience of description, the flora of Mexico may be divided into four great divisions: that of the comparatively barren plateau and the arid coast regions, the humid *tierras calientes*, the intermediate *tierras templadas* and *tierras frías*, and the higher regions of the sierras. The line of demarcation cannot be very sharply drawn, as the zones everywhere overlap each other and local climatic conditions greatly modify plant types. In general, the aspect of the great central plateau north of the Anáhuac sierras is that of a dusty, treeless plain, here and there a few natural vegetation to be seen—ragged yucca trees, many species of agaves and cactus, scrubby mesquite bushes, sage bushes and occasional clumps of coarse grasses. The rainy season completely changes the appearance of these plains, new grass appears, and wheat and Indian corn are cultivated. The rains do not last long, however, and sometimes fail altogether. The most common plants of the Mexican plateau are the agaves, yuccas and cacti, each of which is represented by a number of species. The first is chiefly known in the south by the "magueys," from which the national drinks "pulque" and "mescal" are extracted. There is some confusion in the specific names of these agaves; the "pulque"-producing plant is usually described as the *Agave americana*, though *A. atrovirens* and several others are also credited with the product. The mescal-producing magueys have a thinner leaf and are not cultivated, with the exception of the species producing the "tequila" mescal. The chief value of the agaves, however, is in their fibres, of which a great variety is produced. The principal plateau agaves producing fibre are the *A. techuquila* and *A. lophantha* and *A. uvulata* of the Jaumave Valley, Tamaulipas, which furnish what may be termed the "textile" fibre of the plateau. The fibre of the plateau of Mexico is credited by Mr. E. W. Nelson to the *A. vivipara*, which is found chiefly in the warmer and lower elevations of the Pacific slope. There are many other fibre-producing agaves, including some of those from which pulque is derived. The cactus is unquestionably the characteristic plant of Mexico. About one

thousand species have been described, a very large percentage of which are to be found on the Mexican plateau.

Explorations by botanists of the United States Department of Agriculture have been made in many localities, in Jalisco, Zacatecas, Michoacán and Tamaulipas, but many years must elapse before the whole ground can be covered. In central and southern Mexico the mountain slopes are forested up to 12,500 to 13,500 ft., juniper bushes reaching to 14,000 ft. The forests are composed of several species of evergreen and deciduous oaks, "oymale" (*Abies rayana*), the arbutus or strawberry tree, the long-leaved *Pinus loophylla* and the short-leaved "oote" or *Pinus montezumae* and the alder, with an undergrowth of elder (*Sambucus mexicana*), broom and shrubby heath. In the Southern Sierra Madre, the "oymale" and "oote" pine are the giants of the forest, sometimes rising to a height of 100 ft. Oaks are to be found over a wide area and at lower elevations of the sub-tropical zone as well. They are represented by a number of species, and are called "roble" and "encina" by the natives.

In the intermediate zones between the higher sierras and the *tierras calientes* the flora is very largely composed of species characteristic of the bordering hot and cold regions. Oaks are everywhere common and the "oote" pine on the Gulf coast is found as far down as 6300 ft. In southern Mexico the pine is found at even lower elevations where the tropical growth has been destroyed by cultivation and fire. The lower slopes of the sierras, especially those of southern Mexico, are well forested and include an immense number of species. The most common families on the eastern slopes are those of the precipitous mountains, the magnolias, crotons, mimosas, acacias, myrtles, oaks, plane-trees and bamboos. Palms are common, the chestnut abounds in many places, the cacti are almost as numerous as on the open plateau. On the southern slopes of the Ajusco and other sierras considerable forests of the "ahuehuate" or cypress (*Taxodium distichum*) are to be found. The "higuera" or castor-oil plant (*Ricinus communis*) is widely distributed throughout the plateau and the open plains of the lower zones. In some localities the characteristic types of the two climatic extremes, the palm and the pine, are to be found growing side by side.

No brief description can adequately portray the marvellous variety and magnificence of the flora of the *tierras calientes*. Its forests are not composed of one or a few dominating species, as in the cold temperate zone, but of countless genera and species closely interwoven together—a confused mass of giant trees, lianas and epiphytes struggling to reach the sunlight. This struggle for existence has completely changed the habits of some plants, turning the palm and the cactus into climbers, and even some normal species into epiphytes. Among the most important and conspicuous trees of these tropical forests are mahogany, rosewood, Spanish cedar (*Cedrela*), cassias, ceibas (*Bombax*), rubber (*Castilloa*), palms of many species including the oil-producing *Atalea* of Manzanillo and *Acrocomia* of Acapulco, guayacan (*Guaiacum*), logwood (*Haematoxylon campechianum*), brazilwood (*H. broussonetii*) which should not be confounded with the Brazilian *Caesalpinia*, palo blanco (*Lysiloma candida*), the cascalote and divi-divi trees (*Caesalpinia Calacalo* and *C. coriaria*), the "zapote chico" (*Achras zapota*) from which chicle is extracted, "zapote prieto" (*Diospyros ebenaster*), wild fig, myrtles, bamboos and many of the types already mentioned in connexion with the sub-tropical zone. Of the 114 species of trees and cabinet-woods, 17 of oil-bearing plants, and over 60 of medicinal plants and dyewoods indigenous to Mexico, by far the larger part are represented in the *tierras calientes*. Among the well-known forest products of this zone are arnotto, jalap, ipocuanha, sarsaparilla, rubber, orchids and a great variety of gums.

Of the economic plants and products of Mexico, the list is surprisingly long and interesting. The cereals, fruits and vegetables of Europe have been introduced and some of them have done well. Wheat is widely cultivated and a considerable part of the population depend upon it for their bread. Indian corn, which is believed to have had its origin in Mexico, also provides food for a large part of the population. "Tunas" or cactus fruit, red peppers, "zapotes" (the fruit of various trees), "arrayan" (*Myrtus arayan*), "ciruelas" or Mexican plums (*Spondias*), guavas, "huamuchil" (*Pithecolobium dulce*), tamarinds, aguacates (*Persea gratissima*), bananas, plantains, pineapples, grapes, oranges, lemons, limes, granadillas, chirimoyas, melons (*Melanes americana*), coco-nuts, cactus, mangoes, olives, gourds and melons, are among the fruits of the country, and wheat, Indian corn, beans, yams, sweet potatoes, onions and "tomatoes" (*Physalis*) are among its better-known food products. The food of the common people is chiefly made up of Indian corn, beans, red peppers and "tomatoes." There are about 50 known species of beans (*Phaseolus*) in Mexico and Central America, and probably a dozen species of red peppers (*Capiscum*) which are used both in seasoning and in making chili sauce. The "tomato" or "tomate" mentioned, is the fruit of the *Physalis toscarpa*, sometimes called the "strawberry" of the Mexican ground-cherry, which is used with red peppers to make chili. The common potato (*Solanum tuberosum*), of which wild varieties are found, is not commonly used as a vegetable, but as a flavouring for soups and other dishes. Among other economic plants are the fibre-producing agaves, the best known of which is the *A. rigida*

var. *elongata* which produces the "henequen" fibre, or sisal hemp, of Yucatán, silk or tree-cotton (*Ceiba caseriata*), sugar-cane, cotton (*Gossypium*), indigo and "canaigre" (*Rumex hymenosepalus*) whose root contains a large percentage of tannin.

Mexico has suffered much from the reckless destruction of her forests, not only for industrial purposes but through the careless burning of grassy areas. The denuded mountain slopes and plateaus of southern Mexico are due to the pre-historic inhabitants who cleared away the tropical forest for their Indian corn fields, and then left them to the erosive action of the tropical rains and subsequent occupation by coarse grasses. Fire was generally used in clearing these lands, with the result that their arboreal vegetation was ultimately killed and their fertility destroyed. In the valleys of some of these denuded slopes oak and pine are succeeding the tropical species where fires have given them a chance to get a good foothold.

Population.—According to the census of 1900 the population of Mexico numbered 13,607,250, of which less than one-fifth (19%) were classed as whites, 38% as Indians, and 43% as mixed bloods. There were 57,507 foreign residents, including a few Chinese and Filipinos. Since then the Japanese have acquired an industrial footing in Mexico. Under the constitution of 1824 all race distinctions are abolished, and these diverse ethnic elements are nominally free and equal. For many years, however, the Indians remained in subjection and took no part in the political activities of their native country. Since about 1866, spurred on by the consciousness that one of their own race, Benito Juárez, had risen to the highest positions in the gift of the country, they have taken greater interest in public affairs and are already making their influence felt. In southern Mexico the Zapotecs furnish schoolmasters for the village schools. Peonage, however, is still prevalent on many of the larger estates, and serious cruelties are sometimes reported. The government itself must be held partly responsible, as for the transportation of the mountain-bred Yaquis to the low, tropical plains of Yucatán (see Herman Whitaker's *The Planter*, 1909), but the influence of three and a half centuries of slavery and peonage cannot be shaken off in a generation.

According to Humboldt, the census of 1810 gave a total population of 6,122,354, of which the whites had 18%, the mestizos 22% and the Indians 60%. The census of 1895 increased the whites to 22%, which was apparently an error, the mixed bloods to 47%, and reduced the Indians to 31%. It is probable that the returns have never been accurate in regard to the mixed bloods and Indians, but it is the general conclusion that the Indians have been decreasing in number, while the mixed bloods have been increasing. Neglect of their children, unsanitary habits and surroundings, tribal intermarriage and peonage are the principal causes of the decreasing Indian population. Recent observers, however, deny the assertion that the Indians are now decreasing in number except where local conditions are exceptionally unfavourable. The death rate among their children is estimated at an average of not less than 50%, which in families of five and six children, on an average, permits only a very small natural increase. The larger part of the population is to be found in the southern half of the republic, owing to the arid conditions prevailing in the north. The unhealthfulness of the coastal plains prevents their being thickly populated, although Vera Cruz and some other states return a large population. The most favourable regions are those of the *tierras templadas*, especially on the southern slopes of the great central plateau which were thickly populated in pre-historic times.

The dissimilar races that compose the population of Mexico have not been sufficiently fused to give a representative type, which, it may be assumed, will ultimately be that of the *mestizos*. Mexico was conquered by a small body of Spanish adventurers, whose success in despoiling the natives attracted thither a large number of their own people. The discovery of rich deposits of gold and silver, together with the coveted commercial products of the country, created an urgent demand for labourers and led to the enslavement of the natives. To protect these adventurers and to secure for itself the largest possible share in these new sources of wealth, the Spanish crown forbade the admission of foreigners into these colonies, and then harassed

them with commercial and industrial restrictions, burdened them with taxes, strangled them with monopolies and even refused to permit the free emigration thither of Spaniards. Out of such adverse conditions has developed the present population of Mexico. It was not till after the middle of the 19th century that a long and desperate resistance to foreign intervention under the leadership of Benito Juárez infused new life into the masses and initiated the creation of a new nationality. Then came the long, firm rule of Porfirio Díaz, who first broke up the organizations of bandits that infested the country, and then sought to raise Mexico from the state of discredit and disorganization into which it had fallen. Suspicion and jealousy of the foreigner is disappearing, and habits of industry are displacing the indolence and lawlessness that were once universally prevalent.

The white race is of Spanish descent and has the characteristics common to other Spanish-American creoles. Their political record previous to the presidency of Porfirio Díaz was one of incessant revolutionary strife, in which the idle, unsettled half-breeds took no unwilling part. The Indian element in the population is made up of several distinct races—the Aztec or Mexican, Misteça-Zapoteca, Maya or Yucateco, Otomí or Otlomí, and in smaller number the Totonac, Tarasco, Apache, Matlazingo, Chontal, Mixe, Zoque, Guaiuro, Opata-Pima, Tappiulapa, Seri and Huavi. As the tendency among separated tribes of the same race is to develop dialects and as habit and customs tend still further to differentiate them, it may be that some of these smaller families are branches of the others. In 1864 Don Manuel Orozco y Berra found no fewer than 51 distinct languages and 69 dialects among the Indian inhabitants of Mexico, to which he added 62 extinct idioms—making a total of 182 idioms, each representing a distinct tribe. Thirty-five of these languages, with 69 dialects, he succeeded in classifying under 11 linguistic families. A later investigator, Don Francisco Belmar (*Lenguas indígenas de México*, Mexico, 1905), has been able to reduce these numerous idioms to a very few groups. None of them were written except through the use of ideographs, in the making of which the Aztecs used colours with much skill, while the Mayas used an abbreviated form, or symbols.

The Aztecs, who called themselves Mejica or Mexicans after they had established themselves on the high table-land of Mexico, belong to a very large family or group of tribes speaking a common idiom called Nahuá or Nahoá. These Nahuá-speaking tribes were called the Nahuatlaca, and compose a little more than one-fourth of the present Indian population. They inhabit the western Sierra Madre region from Sinaloa southward to Chiapas, the higher plateau states, which region was the centre of their empire when Cortés conquered them, and parts of Vera Cruz, Tabasco, Oaxaca, Morelos, Aguascalientes and San Luis Potosí. They were energetic and warlike and evidently had not reached the zenith of their power when Cortés came. They had been preceded on the same plateau by the Chichimecs, possibly of the same race, who were conquered by the Aztecs sometime in the 15th century after a supposed occupation of the territory about 400 years. The characteristic civilization of prehistoric Mexico, however, antedates both of these periods.

An Aboriginal race called the Toltecs is said to have occupied Vera Cruz and Tabasco and to have extended its empire westward on the plateau to and perhaps beyond the present capital. They were the builders of the pyramids of Cholula and Teotihuacan, near the city of Mexico, and of Papaná, Huatusco and Tuzapan, in Vera Cruz. One of their towns was Tollan (now Tula) 50 m. north of the national capital, and it is not improbable that the people of Cholula, Texcoco and Tlaxcala at the time of the Spanish invasion were occupying the sites of older Toltec towns. There has been much discussion in regard to the origin of the Toltecs, some assuming that they were a distinct race, and others that they belonged to the Nahuatlaca. Another and perhaps a better supposition is that they belonged to the Maya group, and represented a much earlier civilization than that of the builders of Palenque, Quirigua and Copan. Confirmatory

evidence of this is to be found, not only in the character of their constructions, but in the circumstance that a tribe closely akin to the Mayas (the Huastecos) still occupies a retired mountain valley of Vera Cruz, entirely separated from their kinsmen of the south, and that a dialect of the Maya language is still spoken in northern Vera Cruz. There is evidence to show that the Aztecs adopted the civilization of the Toltecs, including their religion (Quetzalcoatl being a god of the Toltecs and Mayas), calendar and architecture. Perhaps the most remarkable of the Mexican races are the Mayas, or Maya-Quiché group, which inhabit the Yucatán peninsula, Campeche and parts of Tabasco, Chiapas, and the neighbouring states of Central America (*q.v.*). The remarkable ruins of Palenque, Uxmal, Chichenitza, Lorillard, Ixinché, Tikal, Copan and Quirigua, with their carved stonework and astonishing architectural conceptions, show that they had attained a high degree of civilization. They were agriculturists, lived in large, well-built towns, cultivated the mountain sides by means of terraces, and had developed what must have been an efficient form of government.

The Mixtecas, or Mixtecas, and Zapotecas, who occupy the southern slopes of the central plateau, especially Puebla, Morelos, Oaxaca and Guerrero, form another distinct race, whose traditional history goes back to the period when the structures now known as Mitla, Monte Alban, Xochicalco and Zaachila were built. Their prehistoric civilization appears to have been not inferior to that of the Mayas. They were an energetic people, were never subdued by the Aztecs, and are now recovering from their long subjection to Spanish enslavement more rapidly than any other indigenous race. The Otomis comprise a large number of tribes occupying the plateau north of the Anáhuac sierras. They are a hardy people, and are the least civilized of the four principal native races.

The Totonacs inhabit northern Vera Cruz and speak a language related to that of the Mayas; the Tarascos form a small group living in Michoacán; the Matlazingos, or Matlaltzincas, live near the Tarascos, the savage Apaches, a nomadic group of tribes ranging from Durango northward into the United States; the Opatá-Pima group, inhabiting the western plateau region from Sonora and Chihuahua south to Guadalajara, is sometimes classed as a branch of the Nahuatlaca; the Seris, a very small family of savages, occupy Tiburon Island and the adjacent mainland of Sonora; and the Guaicuicos, or Yumas, are to be found in the northern part of the peninsula of Lower California. In southern Mexico, the Chontales, Tapijulapas, Mixes and Zoques inhabit small districts among and near the Zapotecas, the first being considered by Belmar a branch of that family. The Huavis inhabit four small villages among the lagoons on the southern shore of Tehuantepec and have been classed by Belmar as belonging to the Maya stock. The census of 1895 gave these Indian races an aggregate population of nearly 4,000,000, of which nearly 3,450,000 belonged to the first four groups. Three of these four had made important progress toward civilization. Some of the others had likewise made notable progress, among which were the Tarascos, Totonacs and Zoques.

The builders of Casas Grandes (*q.v.*), in Chihuahua, evidently belonged to the Pueblo tribes of Arizona and New Mexico. As for the builders of Quemada, in Zacatecas, nothing positive is known. The ruins apparently are of an earlier period than those of Mitla and Xochicalco, and have no inscriptions and architectural decorations, but the use of dressed stone in the walls, rather than adobe, warrants the conclusion that they belonged to the civilization of southern Mexico.

From the records made at the time of the Spanish conquest, and from the antiquities found in the abandoned cities of prehistoric Mexico, it is certain that the Indians lived in substantial houses, sometimes using dressed stone, inscriptions and ornamental carvings on the more pretentious edifices; they cultivated the soil, rudely perhaps, and produced enough to make it possible to live in large towns; they made woven fabrics for dress and hangings, using colours in their manufacture; they were skilful in making and ornamenting pottery, in making gold and silver ornaments, and in featherwork; they used the fibres that Nature lavishly provided

in weaving baskets, hangings, mats, screens and various household utensils. Copper was known to them, and it is possible that they knew how to make cutting instruments from it, but they generally used stone axes, hammers and picks, and their most dangerous weapon was a war-club into which chips of volcanic glass were set. Many of these primitive arts are still to be found in the more secluded districts, and perhaps the best work in pottery moulding in Mexico to-day is that of uneducated Indian artists.

Of the half-breed element which has become so important a part of the Mexican population, no safe estimate can be made. Education, industrial occupation, commercial training and political responsibility are apparently working a transformation in a class that was once known chiefly for indolence and criminal instincts, and many of the leaders of modern Mexico have sprung from this race. Settled government, settled habits, remunerative employment and opportunities for the improvement of their condition are developing in them the virtues of the two parent races. Brigandage was formerly so common that travel without an armed escort was extremely dangerous; under President Diaz, however, not only has such lawlessness been repressed but the brigands themselves have been given regular employment as rural guards under the government. This class is also furnishing the small traders of the towns, overseers on the plantations and public works, petty officials, and to some extent the teachers and professional men of the provincial towns.

Political Divisions.—The republic of Mexico is politically divided into 27 states, one federal district, and three territories. The states are generally subdivided into *distritos* (districts) or *partidos*, and these into *municipios* (municipalities) which correspond to the townships of the American system. The state of Nuevo León, however, is divided into *municipios* only, while some other states use entirely different titles for the divisions, the larger being described as *departamentos*, *cantons* and *municipios*, and the smaller as *partidos*, *directorios* and *seccionarios rurales*. The Federal District consists of thirteen municipalities. The territory of Lower California is divided into two large districts, northern and southern, and the latter into *partidos* and *municipios*—the larger divisions practically forming two distinct territories.

The states and territories, with their areas, capitals and populations, are as follows:—

Name.	Area, sq. m.	Pop. 1900.	Capital.	Pop. 1900.
Agascalientes .	2,950	102,416	Agascalientes .	35,052
Campeche .	18,087	86,542	Campeche .	17,109
Chiapas .	27,222	360,799	Tuxtla Gutierrez	9,395
Chihuahua .	87,802	267,784	Chihuahua .	30,405
Coahuila .	63,569	292,633	Saltillo .	30,405
Colima .	2,272	65,115	Colima .	20,698
Durango .	38,009	370,294	Durango .	31,092
Guanajuato .	11,370	1,061,724	Guanajuato .	41,486
Guerrero .	24,996	479,205	Chilpancingo	7,497
Hidalgo .	8,917	605,051	Pachuca .	37,487
Jalisco .	31,846	1,153,891	Guadalajara .	101,208
Mexico .	9,247	934,463	Toluca .	25,940
Michoacán .	22,874	935,808	Morelia .	37,278
Morelos .	2,773	106,115	Cuernavaca .	9,584
Nuevo León .	23,592	327,337	Monterrey .	62,266
Oaxaca .	35,382	948,633	Oaxaca .	35,049
Puebla .	12,204	1,021,133	Puebla .	93,152
Querétaro .	3,556	323,389	Querétaro .	33,152
San Luis Potosí .	25,316	575,432	San Luis Potosí .	61,019
Sinaloa .	33,671	296,701	Culiacán .	10,380
Sonora .	76,900	221,682	Hermosillo .	10,613
Tabasco .	10,072	159,334	San Juan Bautista	10,543
Tamaulipas .	32,128	218,948	Ciudad Victoria .	10,086
Tlaxcala .	1,595	172,315	Tlaxcala .	27,185
Vera Cruz .	29,201	981,030	Jalapa .	29,488
Yucatán .	35,203	369,150	Mérida .	43,630
Zacatecas .	24,757	402,960	Zacatecas .	32,866
District Federal	493	541,516	Mexico .	344,721
Territories:—				
Baja California	58,328	47,624	La Paz	5,046
Topic .	11,275	150,098	Topic	15,488
Quintana Roo .	—	—	Santa Cruz de Bravo .	276
Islands	1,420	—		

The area and population of Yucatán include those of the territory of Quintana Roo, which formed part of that state at the time of the census.

Baja, or Lower California, is divided into two districts for administrative convenience. The Distrito del Norte is credited with a population of 7583 and has its capital at Ensenada (pop. 1026); the Distrito del Sur has a population of 40,041 and has its capital at La Paz.

Tepec was detached from the north-west part of Jalisco and organized as a territory in 1889.

Quintana Roo was detached from the state of Yucatán in 1902 and received a territorial government.

The principal cities of Mexico, other than the capitals above mentioned, are as follows, the populations being those of 1900 except when otherwise stated: Acapulco (pop. 4932), a famous port on the Pacific coast in Guerrero, which was built by the earthquake of 1909; Carmen, or Laguna de Términos (about 6000), a thriving commercial town and port on the Gulf coast in Campeche; Celaya (25,565), a railway centre and manufacturing town of Guanajuato; Ciudad Guzman, or Zapotlán (about 17,500), an interesting old town of Jalisco; Cholula (about 9000), an ancient native town of Puebla, widely known for its great pyramid; Comitán (9316), the commercial centre of Chiapas; Córdoba (7974 in 1895), a picturesque Spanish town in the sierras of Vera Cruz; Cuautla (6096), the centre of a rich sugar-producing district of Morelos; Guaymas (8648), a flourishing port of Sonora on the Gulf of California; León (62,623), the largest city in Guanajuato and distinguished for its commercial activity, manufactures and wealth; Linares (20,690), the second city of Nuevo León in size and importance; Matamoros (8347), a prominent commercial centre and river port of Tamaulipas; Mazatlán (17,852), the foremost Mexican port on the Pacific coast; Orizaba (32,894), a city of Vera Cruz famous for its delightful climate and picturesque surroundings; Parral (14,748), a well-known mining centre of southern Chihuahua; San Cristobal (about 16,000), once capital of Chiapas and rich in historical associations; Tampico (16,313), a Gulf port and railway terminus of Tamaulipas; Tehuantepec (10,386), the largest town on the Tehuantepec railway in Oaxaca; Vera Cruz (29,164), the oldest and best known Gulf port of Mexico.

Communications.—Railways began in Mexico with a line of four kilometres between the capital and Guadalupe, which was finished in 1854 and afterwards became a part of the Ferrocarril Mexicano. The latter dates from 1857, when a concession was granted for the construction of a railway from the city of Mexico to Vera Cruz. The French invasion of 1862 found only 10 m. in operation outside of Vera Cruz and military needs led to its immediate extension to Paso del Macho, at the foot of the sierras, about 35 m. At the same time the English company holding the concession extended the Guadalupe line to Puebla. Nothing more was accomplished until after the death of Maximilian, and with a liberal subsidy from the Mexican government the Ferrocarril Mexicano was pushed to its completion in 1873. It is celebrated because of the difficulties overcome on the precipitous eastern slopes of the Sierra Madre, the beauties of the mountain scenery through which it passes, and the rapid transition from the hot, humid coastal plain to the cool, arid plateau, 7924 ft. above the sea at Boca del Monte. The railway extends 263 m. between Vera Cruz and Mexico City, to which 58 m. were added in branches from Apizaco to Puebla, and from Ometusco to Pachuca. The line was capitalized at \$46,000,000 and has paid a good profit on the investment. The period of active railway construction, however, did not begin until 1878, during the first term of President Porfirio Diaz. In 1874 a concession was granted for a line from the port of Progreso to Mérida (221 m.), and in 1878 four concessions were added under which 806 m. were constructed. The principal of these four concessions was the Ferrocarril Interoceánico running from Vera Cruz to Mexico City and across the republic toward Acapulco. In 1880 concessions were granted to the F.C. Occidental, F.C. Central Mexicano, F.C. Nacional Mexicano and three others of less importance, aggregating nearly 3500 m. The first three of these have become important factors in the development of Mexico. The first runs southward from the capital to Oaxaca through the rich sub-tropical states of Puebla and Oaxaca, and the other two run northward from the same point to the American frontier. These lines, popularly called the Mexican Central and Mexican National, have their northern termini at Ciudad Juárez and Laredo on the Rio Grande and connect with American trunk lines at El Paso and Laredo. These two great lines were merged in 1908, with an aggregate capital of \$46,000,000 Mexican money, of which the Mexican government holds \$23,004,580, or a controlling interest. Important branches of these lines extend to Tampico on the Gulf coast, to Manzanillo on the Pacific coast, and westward and southward into Michoacán and Guerrero, with a coast terminus at or near Acapulco. The next important line is the F.C. Internacional Mexicano, running from Ciudad Porfirio Diaz, on the Rio Grande, south-westward across the plateau to Arango, and is to be extended to Mazatlán, on the Pacific coast. This line was built with American capital and without a subsidy. Another line built with American capital and in connexion with American railway interests extends southward from Nogales, on the northern frontier, to Hermosillo, Guaymas and Mazatlán; it is to be extended to Guadalajara and possibly to other points in southern

Mexico. Monterrey is connected with Tampico by a Belgian line known as the F.C. de Monterrey al Golfo Mexicano, and the capital is to have direct connexion with the Pacific, other than the F.C. Interoceánico, by a line through Cuernavaca and Iguala to the coast. Indirectly the capital has a Pacific coast connexion by way of Cordoba and the F.C. Vera Cruz al Pacifico to a junction with the Tehuantepec line. One of the most important railways in Mexico is the F.C. Nacional Interoceánico de Tehuantepec, also called the Tehuantepec National, and the Mexican Isthmus railway, which is 192 m. long and was formally opened in 1907. This line crosses the Isthmus of Tehuantepec from Coatzacoalcos (officially Puerto Mexico) on the Gulf coast to Salina Cruz on the Pacific coast, and has been under construction many years. The railway was first completed in 1894, but light and defective construction, together with lack of shipping facilities at its terminal points, rendered it useless. To correct these defects the line was completely rebuilt and terminal ports constructed. In 1909 the ports were ready to receive large ocean steamships, and regular traffic was begun, including cargoes of Hawaiian sugar for New York. The highest point on the line (Chivela Pass) is 735 ft. above sea-level. The railway has been built by the Mexican government as a transcontinental route for international commerce. Its final construction together with that of its two ports were executed by S. Pearson & Sons, Ltd., of London, who also undertook the working of the line when open. It was estimated in 1907 that the total cost of the railway and its completion would be about \$13,000,000. The line is connected at the Gulf of Santa Lucracia (109 m. from Salina Cruz) with the Vera Cruz and Pacific railway which gives an all-rail connexion with Vera Cruz and Mexico City, the distance between the latter and Salina Cruz being 520 m. According to the President's Message of April 1909, there were 14,857 m. of railway in operation, of which 11,851 m. belonged to or were controlled by the government. It is the evident policy of the Mexican government to prevent the absorption of its railways by private monopolies, and this is effected by state ownership of a controlling share in most of the trunk lines.

Mexico is well provided with tramway lines in its larger cities. A British consular report for 1904 stated that Mexico City and Torreon only were using electric traction, but that Guadalajara, Monterrey, Aguascalientes, Lagos, Colima, Vera Cruz and San Luis Potosí would soon be using it. No official reports are available. The telegraph lines had an aggregate length of 35,980 m. at the end of 1907, of which 33,000 m. belonged to the national government. The President reports an addition of 1626 m. in 1908. Wireless telegraph was represented in 1908 by a connexion between Mazatlán and Lower California, which was in successful operation. Telephone lines were in use in all the large cities and in connexion with the large industrial enterprises and estates, beside which the government had 500 m. of its own in 1908.

Commerce.—In 1905 the mercantile marine of Mexico comprised 13 steamers, of 13,199 tons, and 29 sailing vessels, of 8451 tons. The ocean-carrying trade was almost wholly in the hands of foreigners, the government wisely refraining from an attempt to develop an occupation for which its citizens had no natural aptitude. The coastwise trade is principally under the Mexican flag, but the steamers are owned abroad. An official publication entitled "Mexico: Yesterday and To-day, 1876-1904," states that while the number of steamers engaged in the foreign trade increased from 841 to 969 in the 17 years from 1886 to 1903, the number of Mexican steamers decreased from 55 to 4. For the year 1906-1907 the entries of vessels from foreign ports numbered 1697, of 3,282,125 tons, and the clearances were 1669, of 3,257,932 tons. Subventions are paid for foreign steamships to the principal ports, the total expenditure in 1907-1908 being £42,876. The ports are served by a large number of foreign steamship companies, which give direct communication with the principal ports of the United States, Europe, and the west coast of South America, and the initiation of a Japanese line in 1908 also brings Mexico into direct communication with the far East. The larger ports for foreign trade are Vera Cruz, Tampico, Progreso, Carmen and Coatzacoalcos on the Gulf coast, and Guaymas, La Paz, Mazatlán, Manzanillo, San Blas, Acapulco and Salina Cruz on the Pacific coast. Some of these—Vera Cruz, Tampico, Coatzacoalcos, Salina Cruz, Manzanillo and Mazatlán—have been greatly improved with costly port works. Among the smaller ports, some of which are open to foreign trade, are Matamoros, Tampán, Alvarado, Tlacotalán, Progreso, Campeche and the island of Mujeres (coast of Yucatán), on the Gulf side, and Ensenada, Altata, Santa Rosalia and Soconusco on the Pacific.

The foreign trade has shown a steady increase during the period of industrial development, to which better means of transport have been an invaluable aid. In 1906-1907 the imports were valued at \$111,234,968 U.S. gold, and the exports at \$123,512,969, of which very nearly one half consisted of precious metals. According to an official report issued early in 1909 there had been a heavy decrease in both imports and exports, the former being returned at \$36,195,469 and the latter at \$54,300,896 for the six months ending the 31st of December 1908. This rapid development and overtrading were given as reasons for this decrease in imports and exports. Canada, the former in many cases for the protection of national industries. The imports largely consist of railway material, industrial machinery,

cotton, woollen and linen textiles and yarns for national factories, hardware, furniture, building material, mining supplies, drugs and chemicals, wines and spirits, wheat, Indian corn, paper and military supplies and equipment. The exports include gold, silver, copper, coffee, henequén or sisal, ixtle and other fibres, cabinet woods, chicle, rubber and other forest products, hides and skins, chickpeas, tobacco and sugar.

Agriculture.—The agricultural resources of Mexico are large and unutilized. They comprise some of the cereals and other food products of the temperate zone, and most of the leading products of the tropics. Agriculture, however, received slight attention, owing to the early development of the mining industries. An indirect result of the industrial development of Mexico, which began during the last quarter of the 19th century, has been an increased interest in agriculture, and especially in undertakings requiring large investments of capital, such as coffee, sugar and rubber plantations. A large part of the country is too arid for agriculture, and even with irrigation the water supply is sufficient for only a small part of the dry area. This region has, for the most part, a temperate climate, and produces wheat, barley, Indian corn and forage crops. Long droughts often destroy the wheat and Indian corn and compel their importation in large quantities to supply the people with food. This uncertainty in the wheat crop extends to the southern limits of the higher plateau, and is a serious obstacle to the increased production of this cereal. Indian corn, also, is a comparatively uncertain product on the plateau, and for the same reason. As it is a staple food with the poorer classes, the deficiency is made up through importation. These drawbacks tend to restrict agriculture on the plateau to limited areas, and in the country people are, in general, extremely poor and badly nourished. A comparatively new product in this region is that of canaigre, which is grown for the tannin found in its root. It is a native of the arid regions and is now cultivated with success. The district about Parras, in southern Coahuila, produces grapes, which are principally used in the manufacture of wine and brandy. An important product of the plateau and of the open districts of the *tierras calientes*, growing in the most arid places, is the "nopál" or prickly pear cactus (*Opuntia ficus indica*). Its fruit, called "tuna" by the natives, is refreshing and wholesome, and is eaten in the state in which it grows. In the *tierras calientes* of Mexico, however, better conditions prevail. A fertile soil, abundant rainfall and high temperatures have covered these mountain slopes and lowland plains with a wealth of vegetation. The problem for the agriculturist here is not irrigation, but drainage and keeping down spontaneous growths. In these regions, sugar, tobacco, indigo, cacao, rice, sweet potatoes, alfalfa, beans and cassava are produced, and Indian corn yields two and three crops a year. Fruits also are plentiful, both wild and cultivated. Among them are the banana, plantain, tuna, chicle pepper, olive, coco-nut, orange, lemon, lime, mango, guava, peach, apple, pear, plum, (wild and cultivated), fig, ahuatec (*Persea gratissima*), chiricunuya (*Anona cherimolia*), papaya, gourd, melon, guava, ciruela (plum), and the several "zapote" fruits, including "chico zapote" from the *Achras zapota*, which produces the "chicla" or chicle-gum of commerce, "zapote blanco" from the *Casimiroa edulis*, "zapote-baracho" ("or amarillo") from the *Lucuma salicifolia*, "zapote-prieto" ("or negro") from the *Diospyros obtusifolia*, and "zapotemamey." The production of rubber is becoming an important industry, large plantations having been set with both *Hevea* and *Catappa* rubber trees, the latter between the zones. In the subtropical belt where coffee of an excellent quality is produced, and where cotton is cultivated. Coffee has become an important article of export, but cotton does not yield enough for the domestic factories. Better cultivation would probably increase the output and make it an article of export. A peculiar and highly profitable branch of Mexican agriculture is the cultivation of the *Agave* for two widely different purposes—one for its fibre, which is exported, and the other for its sap, which is manufactured into intoxicating liquors called "pulque" and "mescal." In Yucatán immense plantations of the *Agave pyramida var. elongata* are cultivated, from which large quantities of "henequén" or "sisal," as the fibre is called, are exported. It is produced on light shallow soils overlying calcareous rock. It is also cultivated in Campeche and Chiapas. The pulque industry is located on the plateau surrounding the city of Mexico, the most productive district being the high, sandy, arid plain of Apam, in the state of Hidalgo, where the "maguery" (*Agave americana*) finds favourable conditions for its growth—a dry calcareous surface with moisture sufficiently near to be reached by its roots. Its cultivation is the chief industry of the states of Mexico, Colima, Puebla and Tlaxcala. Of the 208 plantations in the state of Hidalgo in 1897, 129 were devoted to maguery. The plant is propagated from suckers and requires very little attention after transplanting to the field where it is to remain, but it takes six to eight years to mature and then yields an average of ten gallons of sap during a period of four or five months, after which it dies. "Pulque" is the fermented drink made from this sap; "mescal" is the distilled spirit made from the leaves and roots of the plant. There are other agaves used both in the production of drinks and fibres, but they are not cultivated. The "ixtle" fibres shipped from Tampico and Chiapas are all obtained from the agaves and yuccas found growing wild.

The natural and forest products of Mexico include the agave and yucca (ixtle) fibres already mentioned; the "cebón" fibre derived from the silk-cotton tree (*Bombax pentandra*); rubber and vanilla in addition to the cultivated products; palm oil; castor beans; ginger; chicle, the gum extracted from the "chico-zapote" tree (*Achras zapota*); logwood and other dye-woods; mahogany, rosewood, ebony, cedar and other valuable woods; "cascalote" or divi-divi; jalap root (*Ipomoea*); sarsaparilla (*Smilax*); nuts and fruits.

Stock-raising dates from the earliest Spanish settlements in Mexico and received no slight encouragement from the mother country. For this reason much importance has always been attached to the industry, and stock-raising of some sort is to be found in every state of the republic, though not always to a great extent. The Spaniards found no indigenous domestic animals in the country, and introduced their own horses, cattle, sheep and swine. From these are descended the herds and flocks of to-day, with no admixture of new blood until toward the end of the 19th century. The horses and cattle are of a degenerate type, small, ungainly and injured to neglect and hard usage. The horse is chiefly used for saddle purposes and is not reared in large numbers. The mule is more generally used in every part of the country, being hardier, more intelligent and better adapted for service as a draft and pack animal. The transport of merchandise and produce was wholly by means of pack animals before the advent of railways, and is still the common means of transport away from the railway lines. For this purpose the sure-footed mule is invaluable. In some districts, however, oxen and ox-carts are employed, especially in the southern states, and always in the open, level country. The varying climatic conditions of Mexico have produced breeds of cattle that have not only departed from the original Spanish type, but likewise present strikingly different characteristics among themselves. Those of the northern plateau are small, hardy and long-lived, being bred on extensive ranges in a cooler atmosphere, and accustomed to long journeys in search of water and pasture. In the south they are larger and better nourished, owing to the permanent character of the pasturage, but are less vigorous because of the heat and insect plagues. In Yucatán the open plains, rich pasture, and cool, breezy weather, and always in the open, level country, have been particularly favourable to cattle-raising, and the animals are generally rated among the best in Mexico. Notwithstanding the frequency of long, destructive droughts, cattle-raising is a preferred industry among the landowners of the northern states, and especially near the American frontier. Almost total losses are frequently experienced, but the profits of a favourable year are so great that losses seldom deter ranchers from trying again. In the sierra regions of western Chihuahua and Durango, Nuevo León, Coahuila, Aguascalientes, San Luis Potosí, and the plateau states of northern Mexico, the conditions are less favourable to the industry. The largest herds are to be found in Chihuahua and Durango. Above 5000 ft. the wild pasturage is short, tender and reproduces itself annually. It is exceptionally nutritious, but it disappears altogether in the dry season because of its short roots. The lowland pasture, from 2000 to 5000 ft., is composed of more vigorous grasses, with an undergrowth of an exceptionally succulent character. The stock-raiser on the border pastures his herds on the uplands during the rainy season, and on the lower pastures during the remainder of the year. Next in importance is the breeding of sheep, which are largely confined to the cooler, higher districts, but are commonly of the Spanish merino breed, and suffer in many localities on account of insufficient pasturage. Some attention is given to the breeding of goats because of the local demand for their skins, but the industry is apparently stationary. The raising of swine, however, is increasing. In the last decade of the 19th century the capital invested in these live-stock industries was estimated (by Bancroft) to exceed \$700,000,000, but an official return of the 30th of June 1902 gave an aggregate valuation of only \$120,523,158 (Mexican), or about \$12,052,316. According to this report, which is not strictly trustworthy, the work of the republic 5,442,457 hogs, 859,217 horses, 334,435 mules, 287,991 asses, 3,424,350 sheep, 4,206,011 goats and 616,139 swine. Two years later home consumption returns noted the slaughter of 958,058 cattle (129,938 in the Federal District), 561,982 sheep, 992,263 goats and 887,130 hogs—the last item being larger than the census return of 1902. The greater part is consumed in the country, but there is a considerable export of cattle to the United States, Cuba and Central America, and of hides and skins to the United States and Europe. A few mules are sent to Central America, but the home demand usually exceeds the supply.

Other Industries.—There are no fisheries of importance except the pearl fisheries on the eastern coast of Lower California, and the tortoise fisheries on the coasts of Campeche, Yucatán, and some of the states facing the Pacific. The pearl fisheries have been worked since the arrival of the Spaniards, and were once very productive notwithstanding the primitive methods employed. Since the closing years of the last century pearl fishing in the Gulf of California has been carried on with modern appliances and better results by an English company under a concession from the government. Mother-of-pearl or abalone, sea urchin, sea slug, sea slug, and sea sponges, are exported. Fishing for the tortoiseshell turtle gives employment

to a large number of natives in the season, and considerable quantities of the shell are exported. Other industries of a desultory character include the collection of archil, or Spanish moss, on the western side of the Californian peninsula, hunting herons for their plumes and alligators for their skins, honey extraction (commonly wild honey), and the gathering of cochineal and *ni-in* insects. The cochineal insect was once an important commercial product, but the industry has fallen into decay. The *ni-in* (also known as "ase") is a small scale insect belonging to the genus *Coccus* found in Yucatán, Oaxaca, Vera Cruz, Michoacán and other southern states. It inhabits the spongy trees and produces a greasy substance called "ni-inca," which is much used by the natives as a varnish, especially for domestic utensils, as it resists fire as well as water.

Mining.—The best-known and most productive of the industries of Mexico is that of mining. It was the chief object of Spanish exploration, and the principal occupation of European residents and capital during three centuries of Spanish rule. Agricultural and pastoral industries gradually gained footholds here and there, and in time became important, but mining continued far and wide until near the end of the 19th century. Mines of some description are to be found in 26 of the 31 states and territories, and of these the great majority yield silver. According to the official records, there were registered in September 1906, 23,101 mining properties, of which very nearly five-sixths were described as producing silver, either by itself or in combination with other metals. The properties were classed as 1572 gold, 5461 silver, 970 copper, 383 iron, 151 opals, 94 lead, 86 sulphur, 52 antimony, 49 zinc, 40 tin, 21 apatite, 9 manganese, 6 "sal gema," 5 tourmalines, 1 bismuth and 1 turquoise—the remainder being various combinations of these minerals. The absence of coal from this list is due to the circumstance that coal mines were at that time considered as private property and were not registered under the general mining laws. A comparison with 1888-1889, when 8970 properties were registered, will show how rapidly the mining industries have been developed during that period. Besides the above, the mineral resources of Mexico include coal, petroleum, asphalt, platinum, graphite, soda and marble. In 1906 the productive mines numbered 1786, of which 491 were in Sonora, 282 in Chihuahua, 211 in Durango, 113 in Oaxaca and 105 in Nuevo León. Gold is found in Chihuahua, Durango, Sinaloa, Guerrero, Jalisco, Mexico, Morelos, Oaxaca, Puebla, Guanajuato, Sonora, Vera Cruz, Zacatecas, and to a limited extent in Tlaxcala, Tlaxcala, and to a limited extent in Campeche, Chiapas, states; silver in every state and to a limited extent in Baja California, California, Guanajuato, Guerrero, Jalisco, Michoacán, Sonora, Tamaulipas and some other states; mercury chiefly in Guanajuato, Guerrero, San Luis Potosí, Vera Cruz and Zacatecas; tin in Guanajuato; coal, petroleum and asphalt in 20 states; but chiefly in Coahuila, Hidalgo, Michoacán, Oaxaca, Puebla, Sonora, Tabasco, Tamaulipas and Vera Cruz; iron in Durango, Hidalgo, Oaxaca and other states; and lead in Hidalgo, Querétaro and in many of the silver-producing districts. The most celebrated iron deposit is that of the Cerro del Mercado, in the outskirts of the city of Durango—a mountain 640 ft. in height, 1,100 feet in width, and 4800 in length, reputed to be almost a solid mass of iron. Large masses of the metal are also said to exist in the sierras of Lower California. The principal coalfields that have been developed are in the vicinity of Sabinas, Coahuila. They have been opened up by American capitalists and the coal is used on the railways passing through that region. Mexican coal is of a low grade—similar to that found in Texas, but as an official geological report of 1908 estimates the supply in sight at 300,000,000 tons its industrial value to the country cannot be considered inferior to that of the precious metals. The same is true of the petroleum deposits in Tamaulipas and in the southern and southern Vera Cruz. An investigation by the U.S. Geological Survey in 1909 found that the crude Mexican oils are of low grade, but that while not equal to those found in the upper Mississippi basin for refining purposes, they furnish an excellent fuel for railway engines and other industrial purposes. Many of the Mexican railways are using these fuel oils, which are superseding imported coal. In 1909 a well was opened in the southern oilfields whose yield was equal to the best American product.

Manufactures.—Although Mexico is usually described as a non-manufacturing country, its industrial development under the President Porfirio Díaz will warrant some attention. The sugar-cane industry. Manufacturing for international trade has not been and may never be reached, but the industry certainly has reached the stage of meeting a great part of the home demand for manufactured goods, where the raw material can be produced in the country. There were of course some crude industries in existence before the arrival of the Spaniards, such as weaving and dyeing of fabrics made from various fibres, and making earthenware utensils, images, &c. The Spaniards introduced their own industries, including sugar-making, weaving, tanning, and leather- and metal-working, some of which still exist. The early methods of making cane sugar, clarified with clay and dried in conical moulds, are to be found all over Mexico, and the annual output of this product or muscovado sugar (called "panela" by the natives) is still very large. The sugar crop of 1907-1908 was reported as 123,285 metric tons, in addition to which the molasses output was estimated at 70,947.5 metric tons, and "panela" at 50,000 tons. Other estimates make the "panela" output much

larger, the product being largely consumed in the rural districts and never appearing in the larger markets. The estimated number of sugar mills in 1904 was about 2000, of which only about 300 were important for size and equipment. Merino sheep were introduced in 1541 and woollen manufactures date from that time. Large factories are now to be found in all parts of Mexico, and good and serviceable grades of broadcloths, cassimeres, blankets and other fabrics are turned out. There is also a considerable quantity of carpeting, underwear and hosiery manufactured. An important branch of this industry is the manufacture of "zarapes" (called "ponchos" in other parts of Spanish America)—a blanket slit in the centre for the head to pass through, and worn in place of a coat by men of the lower classes. The most important textile industry is cotton manufacture, which has become a highly successful feature in the industrial life of the republic. There were 146 factories in 1905, of which 19 were idle, and these were distributed over a very large part of the country. About one-half the raw cotton consumed was produced in Mexico, and the balance imported in fibre or as yarn. The industry is protected by a high tariff, as is also the production of raw cotton, and further encouragement is offered through a remission of internal revenue taxes where Mexican fabrics are exported for foreign consumption. The cotton factories of 1905 were equipped with 22,021 looms having 678,058 spindles, and with 38 stamping machines, employed 30,162 operatives, and turned out 13,731,638 pieces of cloth. Statistical returns, however, are somewhat incomplete and conflicting, and cannot be used with confidence. Coarse fabrics chiefly are manufactured, but the product also comprises percales, fine calicoes, gingham, shirtings, towings, sheetings and other kinds of goods. Considerable attention is given to the manufacture of "rebozos," the long shawls worn by women. Another very important manufacturing industry is that of tobacco, the consumption of its various products being large among all classes of the population. There were 467 tobacco factories reported in 1905 to be engaged in the manufacture of cigars, cheroots, cigarettes, snuff and cut tobacco for the pipe. The number of factories reported for 1899 was 743, but as the consumption of leaf tobacco increased from 5,546,677 to 8,587,356 kilogrammes, it may be assumed that the decrease in factories is due to the absorption or disappearance of the small shops using old-fashioned methods. Other important manufactures are flour mill, of which there were 742 in 1905, including the immense plant at Monterey; 90 smelters for the reduction of precious metals; tanneries, potteries, and factories for the manufacture of hats, paper, linen, hammocks, harness and saddles, matches, explosives, aerated waters, soap, furniture, chocolate and sweetmeats. There are also a large number of distilleries, breweries, and establishments for the manufacture of "pulque," "mescal," and imitation or counterfeited liquors. In addition to these are the many small domestic industries, such as the making of straw hats, mats, baskets, pottery, ropes and rough national manufactures, and protective duties are levied for that purpose. Other favours include exemption from taxation and exemption from import duties on machinery and raw materials. These inducements have attracted large sums of foreign capital and have brought into the country large numbers of skilled operatives, especially in the cotton, iron and steel, and smelting industries.

Constitution.—Under the Constitution of the 5th of February 1857, subsequently modified in many important particulars, the government of Mexico is described as a federation of free and sovereign states invested with representative and democratic institutions. Practically it is a Federal Republic with centralized executive powers. Its political divisions consist of 27 states (originally 19) having independent local governments, 3 territories and 1 federal district in which the national capital stands. The central government consists of three co-ordinate branches—executive, legislative and judicial—each nominally independent of the other. The executive branch consists of a president and vice-president, assisted by a cabinet of 8 secretaries of state: (1) foreign affairs; (2) interior; (3) justice; (4) public instruction and fine arts; (5) fomento, colonization and industry; (6) communications and public works; (7) finance and public credit; (8) war and marine. The president and vice-president are elected indirectly through an electoral college chosen by popular vote, and serve for a period of six years (the term was four years previous to 1904), the vice-president succeeding to the office in case of the death or permanent disability of the president. The office of vice-president was created on the 6th of May, 1904, and that official serves as president of the senate. A constitutional amendment of 1890 permits the re-election of a president without limit, the original clause prohibiting such a re-election. A candidate for the presidency must be a native-born Mexican

citizen in the full exercise of his political rights, 35 years of age, not an ecclesiastic, and a resident of the republic at the time of the election. Although the authority of the president is carefully defined and limited by the Constitution, the exercise of dictatorial powers has been so common that the executive may be considered practically supreme and irresponsible. Previous to the presidency of General Porfirio Diaz in 1877 political disorders and changes in government were frequent.

The legislative branch of government consists of a Congress of two chambers—a senate and a chamber of deputies. Two ordinary congressional sessions are held each year—April 1 to May 31 and September 16 to December 15—and a permanent committee of 20 members (14 senators and 15 deputies) sits during recess, with the power to confirm executive appointments, to give assent to a mobilization of the national guard, to convene extra legislative sessions, to administer oaths, and to report at the next session on matters requiring congressional action. The senate is composed of 56 members—or two from each state and from the federal district—who are elected by popular vote for a term of four years, one-half the number retiring every two years. A senator must be not under 30 years of age, a Mexican citizen in the full enjoyment of his rights, a resident of the state he represents, and not an ecclesiastic. The chamber of deputies is composed of popular representatives, in the proportion of one deputy for each 40,000 inhabitants or fraction over 20,000, who are elected for a term of two years. A deputy must be not less than 25 years of age, other qualifications being the same as those for a senator. The salary for either senator or deputy is \$3,000 and that of the president \$50,000. Federal officials and ecclesiastics are ineligible for election to either chamber.

Mexican citizenship includes all persons born of Mexican parents, all naturalized aliens, and all foreigners owning real estate in the republic or having children by Mexican mothers unless formal declaration is made of an intention to retain the citizenship of another country. In some cases exemptions are granted from specified taxes and military duties, otherwise naturalized citizens are treated the same as native-born. Aliens are granted the civil rights enjoyed by Mexicans, but the government reserves the right to expel those guilty of pernicious conduct. Suffrage is extended to all Mexican citizens who possess honest means of livelihood, the age limit being 18 for the married and 21 for the unmarried.

The judicial branch of the government consists of a supreme court of justice, three circuit courts, and 32 district courts. The supreme court is composed of 11 "ministros" or justices, four alternates, a "fiscal" or public prosecutor and the attorney-general—all elected by popular vote for a term of six years. It has jurisdiction in cases arising from the enforcement of the federal laws, except cases involving private interests, in admiralty cases, in cases where the republic is a party, in those between two or more states, or between a state and the citizens of another state, in those originating in treaties with foreign states, and in those affecting diplomatic and consular officials. There are likewise supreme and inferior courts in most of the states, governed by the civil and criminal codes in force in the federal district. The territories are governed by federal laws. The department of justice has oversight in matters relating to the enforcement of the federal laws and the administration of justice through minor courts. The police service is both municipal and federal in character. In some states a local police service is maintained, but in most states the federal government maintains a very efficient force of mounted "rurales."

The states are organized very much like the federal government, each with its own governor, legislature, laws and judiciary. Elections are generally indirect, like those for the national executive, and official terms correspond closely to those of similar offices in the national organization. The state is nominally sovereign within its own boundaries, and the authority of its officers and courts in local questions is supreme except in cases where federal intervention or supervision is provided for by the federal constitution. The larger political divisions of the state

(partidos, distritos, &c.) are governed by a *jefe politico*, or prefect, and the smaller by a municipal council called an *ayuntamiento*.

Defence.—The Mexican army consisted in 1907 of 247,476 officers and 24,132 men, organized on modern lines, and commanded by a general staff at the capital. There were 30 battalions of infantry and 4 battalions cadres with an effective strength of 730 officers and 14,898 men; 14 regiments of cavalry and 4 regimental cadres with 493 officers and 6058 men; 2 regiments and 3 cadres of field artillery; one regiment and one cadre each of horse and mountain artillery, 4 sections of garrison artillery, and one mitrailleuse company, in all 147 officers and 1647 men, and the remainder divided among other services. Administration and headquarters staffs comprised 885 officers and 531 men. This force represented the peace footing of the army, which is recruited in part by voluntary enlistments and in part by a form of conscription that might be called impressment. Mauser rifles (1901 model) and carbines are used by the infantry and cavalry, and Schneider Canet quick-firing guns by the field and horse artillery. The nominal war strength of the army is rated at 2510 officers and 81,954 men. Factories for arms and ammunition have been established with modern machinery and uniforms and other equipment are made in the country. The military school in the capital occupies a part of the historic castle of Chapultepec and has been thoroughly reorganized on modern lines. There is also an artillery school at Vera Cruz and subordinate schools in other parts of the republic. The national guard, to which reference is sometimes made, has no effective organization.

Mexico may be said to have no navy, the ten small vessels in commission in 1908 hardly meriting such a designation. There were 2 old despatch boats and 2 old unarmoured gunboats, a steel trading cruiser, the "Zaragoza," and 5 small modern gunboats. The personnel consisted of 198 officers and 905 men. Six new cruisers were projected, but the republic has no pressing need of a navy. Small naval schools are maintained at Campeche and Mazatlán.

Education.—Education in Mexico may be said to have entered upon a progressive phase. The institutions founded by the Spaniards were wholly under ecclesiastical control. The first college in Mexico was founded during the administration of Viceroy Menzies (1535-1550), but it taught very little beyond Latin, rhetoric, grammar and theology. The university of Mexico, planned by Mendoza and founded on the 21st of September 1551, was formally opened on the 25th of January 1553, with faculties of law, philosophy and theology. Practically nothing was done for the natives beyond oral instruction in catechism. The university of Mexico received much support from both church and state, and soon gained a position comparable to the universities of South America—Cordoba, Lima (San Marcos) and Bogotá. The overthrow of Spanish rule in Mexico was the beginning of a new period, and efforts were made to introduce educational reforms, but the colonists and ecclesiastics were still governed by their fears and prejudices, and little was accomplished. In 1833 the university of Mexico suspended work, and the old system of existence altogether. In 1857 the adoption of a more liberal and democratic constitution paved the way for a new period in the educational history of the country. Its realization was delayed by the wars that devastated the country down to the overthrow of Maximilian, but the leaven was at work, and with the return of peace a marked increase in the number of primary and secondary schools was noted. Colleges of law, medicine and engineering were created in Mexico City in 1865 in place of the old university and were successful from the beginning. Professional schools were also established in several of the more important provincial capitals, and everywhere increasing interest in educational matters was apparent. The best proof of this was to be found in the development of the primary schools, of which there were 8226 in 1874, with an attendance of 360,000 pupils. Of these, 603 were supported by the national government, 5240 by municipalities, 2260 by private enterprise, 117 by the Catholic church, and the remainder by Protestant denominations. Handsome schools were built in the cities and larger towns, and compulsory education in all the villages and hamlets. In some parts the natives made most creditable progress in all branches of learning. This was especially true of the Mixtecos and Zapotecas of Oaxaca, from whom have come some of the leading men of the republic. The national school laws now in force had their origin in the recommendations made by a national congress of public education convened on the 1st of December 1889, and again on the 1st of December 1890. The first result was a law regulating free and compulsory education in the federal district and national territories, which came into effect on the 17th of January 1892. From 1822 to this time the government primary schools had been under the supervision of the Compañia Lancasteriana, but they were now placed under charge of the Department of Public Education. On the 19th of May 1896 a general public education law was promulgated, which provided further regulations for the public schools, and outlined a comprehensive system. Compulsory attendance had been required in 1888, but did not come into effect until after the enactment of the law of 1896. It provides for uniform, free and non-sectarian primary instruction, and compulsory attendance for children of 6 to 12 years of age. Preparatory courses for professional training in the government schools were also made free and secular. As the

SILVER:	1 peso, .9027 fine, containing 24.438 grammes of pure silver,
	50 centavos, .800 fine,
	20 " " "
	10 " " "
NICKEL:	5 " " "
BRONZE:	1 and 2 centavos, 95 parts copper, 4 tin, 1 zinc.

Provisions are also made for continuing the coinage of "trade dollars" for export, which have a wide circulation in the Orient but are not current at home. Fractional silver coin is not legal tender above 20 pesos, and bronze and nickel coins worth less than 10 centavos but the government maintains conversion offices where such coins can be converted into silver pesos without loss. The amount of gold in circulation is small, the bank notes convertible into gold taking its place. Foreign coins are permitted to circulate in the republic.

There were 34 chartered banks in Mexico in 1908, of which 29 enjoyed the privilege of issuing bank notes; the total note circulation on the 31st of December 1906 was 97,787,878 pesos. These note issues are everywhere current at full nominal value, being secured under the provisions of the national banking law of 1896 by metallic reserves. The notes are not legal tender, and it is forbidden to count them as "cash on hand" in bank returns, but ample safeguards both as to issue and redemption inspire full confidence in their employment as a substitute for gold. Restrictions on speculative operations in real estate and on the use of hypothecated and discounted paper as security for other transactions, together with the publication of detailed monthly balance sheets, have kept these banks free from unsound methods, and the record thus far (1909) is conspicuously good. Mortgage and loan banks have also been established in accordance with the law of 1896, and are subject to official supervision. Private banks are numerous, but foreign banks are not encouraged to open agencies. The use of cheques is very limited because of the stamp tax.

Weights and Measures.—Mexico adopted the metric system in 1862, and it is used in all official transactions, land measurements, railway calculations and public school work. The old Spanish weights and measures, modified in many particulars, continued in private use, however, and in 1895 it became necessary to declare the metric system the only legal system and to make its use compulsory after the 16th of September 1896.

BIBLIOGRAPHY.—The historical student will find valuable material in Bernal Diaz del Castillo, *Cronica de la conquista de Nueva España* (Madrid, 1632, and other dates); Antonio Herrera *Historia general de los hechos de los Castellanos en las islas y tierra firme del mar oceano* (4 vols., Madrid, 1601); F. C. Mac Nutt, *Letters of Cortés to Charles V.* (London, 1901); H. Prescott, *Conquest of Mexico* (3 vols., London, 1845); and the works of Gomara, Helms, Kingsborough, Las Casas, Sahagun and Justin Winsor.

Among the more popular works on Mexico are Baedeker's *The United States, with Excursions to Mexico, &c.* (Leipzig, 1909); H. H. Bancroft, *Resources and Development of Mexico* (San Francisco, 1893); M. Chevalier, *Le Mexique ancien et moderne* (Paris, 1886); A. Garcia Cybas, *Étude géographique, statistique, descriptive et historique des États-Unis Mexicains* (Mexico, 1889; in English, 1893); C. B. Dahlgren, *Minas históricas de la República Mexicana* (tr. from Eng., 1887); J. Domenech, *Guía general descriptiva de la República Mexicana* (vol. i., Mexico, 1899); F. W. Egloffstein, *Contributions to the Geology and Physical Geography of Mexico* (New York, 1864); C. Reginald Enock, *Mexico, its Ancient and Modern Civilization, &c.* (London, 1909); Hans Gadow, *Travels in Southern Mexico* (London, 1908); Ernst von Hesse-Wartegg, *Mexico, Land und Leute* (Vienna, 1890); W. T. Hornaday, *Camp Fires in Desert and Lava* (London, 1908); Alex. von Humboldt, *Voyage aux régions équinoxiales du nouveau continent* (Paris, 1807 sqq.); A. H. Keane, *Mexico* (in "Stanford's Geographical Dictionary of Geography and History" (London, 1904); H. Kessler, *Notizen über Mexico* (Berlin, 1898); Carl Lumholtz, *Unknown Mexico* (New York, 1902); C. F. Lummis, *The Awakening of a Nation* (New York, 1898); P. F. Martin, *Mexico of the Twentieth Century* (London, 1907); A. H. Noll, *A Short History of Mexico* (Chicago, 1903); Santiago Ramirez, *Noticia histórica de la riqueza minera de Mexico* (Mexico, 1884); Friedrich Ratzel, *Aus Mexico: Reisezeitung aus den Jahren 1874-1876* (Breslau, 1878); Matias Romero, *Geographical and Statistical Notes on Mexico* (New York, 1898); J. H. Smith, *The United States of Mexico* (New York, 1898); E. Selser, *Mexico and Guatemala* (Berlin, 1896); Justo Serra (editor), *Mexico: Its Social Evolution, &c.* (2 vols., Mexico, 1904); J. R. Southworth, *Mines of Mexico* (9 vols., Mexico, 1905); Frederick Starr, *Indians of Southern Mexico* (Chicago, 1890); Sara V. Stevenson, *Maximilian in Mexico* (New York, 1899); T. Philip Terry, *Mexico* (Boston, 1909; an excellent guide); David A. Wells, *A Study of Mexico* (New York, 1887); W. E. Weyl, *Labor Conditions in Mexico* (Washington, 1902), Bull. No. 38, Bureau of Labor; Nevin O. Winter, *Mexico and her People* (Boston, 1901); W. H. Wright, *Wright's Mexico* (Philadelphia, 1898); and Rafael de Zayas Enriquez, *Les États-Unis Mexicains* (Mexico, 1899).

Important works of reference are: *Anuario estadístico de la República Mexicana* (Mexico); *Mexican Year-book* (London, 1908); *Biological and general publications of the U.S. Department of*

Agriculture (Washington); *Statesman's Year-book* (London); *Hand-book of Mexico* (Washington), published by the Bureau of American Republics; *Monthly Bulletin* of the Bureau of American Republics (Washington); *British Foreign Office Diplomatic and Consular Reports* (London); and the *U.S. Consular Reports* (Washington). (A. J. L.)

HISTORY

I.—Ancient Mexico.

The name Mexico is connected with the name of the group of American tribes calling themselves *Mexica* (sing. *Mexicatl*) or *Azteca*. The word is related to or derived from the name of the Mexican national war-god, Mexil, better known as Huitzilopochtli. The Aztecs from the 12th century appear to have migrated from place to place over the mountain-walled plateau of *Anahuac*, the country "by the water," so called from its salt lagoons, which is now known as the Valley of Mexico. About 1325 they founded on the lake of Tezcuczo the permanent settlement of Mexico Tenochtitlan, which is still represented by the capital city, Mexico. The name Mexico¹ was given by the Spanish conquerors to the group of countries over which the Aztec power more or less prevailed at the time of the European invasion. Clavigero (*Storia antica del Messico*, vol. i.) gives a map of the so-called "Mexican empire," which may be roughly described as reaching from the present Zacatecas to beyond Guatemala; it is noticeable that both these names are of Mexican origin, derived respectively from words for "straw" and "wood." Eventually Mexico and New Mexico came to designate the still vaster region of Spanish North America, which (till cut down by changes which have limited the modern republic of Mexico) reached as far as the Isthmus of Panama on the south and took in California and Texas on the north. Mexico in this wide sense is of high interest to the anthropologist from the several native American civilizations which appear within its limits, and which conveniently if loosely group themselves round two centres, the Mexican proper and the Central American.

When early in the 16th century the Spaniards found their way from the West India Islands to this part of the mainland of America, they discovered not rude and simple tribes like the islanders of the Antilles, but nations with arms, official administrators, courts of justice, high agriculture and mechanical arts, and, what struck the white men especially, stone buildings whose architecture and sculpture were often of dimensions and elaborateness to astonish the builders and sculptors of Europe. Here was a problem which excited the liveliest curiosity and gave rise to a whole literature. Hernandez and Acosta shared the opinion of their time that the great fossil bones found in Mexico were remains of giants, and that, as before the deluge there were giants on the earth, therefore Mexico was peopled from the Old World in antediluvian times. On the other hand the multitude of native American languages suggested that the migration to America took place after the building of the tower of Babel, and Sigüenza arrived at the curiously definite result that the Mexicans were descended from Naphtuhim, son of Mizraim and grandson of Noah, who left Egypt for Mexico shortly after the confusion of tongues. Although such speculations have fallen out of date, they induced the collection of native traditions and invaluable records of races, languages and customs, which otherwise would have been lost for ever. Even in the 19th century Lord Kingsborough spent a fortune in printing a magnificent compilation of Mexican picture-writings and documents in his *Antiquities of Mexico* to prove the theory advocated by Garcia a century earlier, that the Mexicans were the lost tribes of Israel. Modern archaeologists approach the question from a different standpoint, but the origin of the American aborigines and of Mexican civilization remains extremely obscure (see AMERICA, where the primitive Mexican cultures are fully illustrated, and CENTRAL AMERICA).

Real information as to the nations of Mexico before Spanish¹ In this, as in all other Aztec names, the x (or j) represents the English sound sh; hence *Mexitli* and *Mexico* should be properly pronounced *Meshitli*, *Meshico*. But they do not appear to have ever been so pronounced by the Spaniards, who naturally gave to the x its ordinary Spanish sound of the German ch.

times is very imperfect, but not altogether wanting. The accurate and experienced Alexander von Humboldt considered the native Americans of both continents to be substantially similar in race-characters. Such a generalization will become sounder, if, as is now generally done by anthropologists, the Eskimo with their pyramidal skulls, dull complexion and flat noses are removed into a division by themselves. Apart from these polar nomads, the American indigenes group roughly into a single division of mankind, of course with local variations. If our attention is turned to the natives of Mexico especially, the unity of type will be found particularly close. The native population of the plateau of Mexico, mainly Aztecs, may still be seen by thousands without any trace of mixture of European blood. Their stature is estimated to be about 5 ft. 3 in., but they are of muscular and sturdy build. Measurements of their skulls show them mesocephalic (index about 78), or intermediate between the dolichocephalic and brachycephalic types of mankind. The face is oval, with low forehead, high cheek-bones, long eyes sloping outward towards the temples, fleshy lips, nose wide and in some cases flattish but in others aquiline, coarsely moulded features, with a stolid and gloomy expression. Thickness of skin, masking the muscles, has been thought the cause of a peculiar heaviness in the outlines of body and face; the complexion varies from yellow-brown to chocolate (about 40 to 43 in the anthropological scale); eyes black; straight coarse glossy black hair; beard and moustache scanty. Among variations from this type may be mentioned higher stature in some districts, and lighter complexion in Tehuantepec and elsewhere. If now the native Americans be compared with the races of the regions across the oceans to their east and west, it will be seen that their unlikeness is extreme to the races eastward of them, whether white Europeans or black Africans. On the other hand they are considerably like the Mongoloid peoples of north and east Asia (less so to the Polynesians); so that the general tendency among anthropologists has been to admit a common origin, however remote, between the tribes of Tartary and of America. This original connexion, if it may be accepted, would seem to belong to a long-past period, to judge from the failure of all attempts to discover an affinity between the languages of America and Asia. At whatever date the Americans began to people America, they must have had time to import or develop the numerous families of languages actually found there, in none of which has community of origin been satisfactorily proved with any other language-group at home or abroad. In Mexico itself the languages of the Nahua nations, of which the Aztec is the best-known dialect, show no connexion of origin with the language of the Otomi tribes, nor either of these with the languages of the regions of the ruined cities of Central America, the Quiché of Guatemala and the Maya of Yucatan. The remarkable phenomenon of nations so similar in bodily make but so distinct in language can hardly be met except by supposing a long period to have elapsed since the country was first inhabited by the ancestors of peoples whose language has since passed into so different forms. The original peopling of America might then well date from the time when there was continuous land between it and Asia.

It would not follow, however, that between these remote ages and the time of Columbus no fresh immigrants can have reached America. We may put out of the question the Scandinavian sea-rovers who sailed to Greenland about the 10th century. But at all times communication has been open from east Asia, and even the South Sea Islands, to the west coast of America. The importance of this is evident when we consider that late in the 19th century Japanese junks still drifted over by the ocean current to California at the rate of about one a year, often with some of the crew still alive. Further north, the Aleutian islands offer a line of easy sea passage, while in north-east Asia, near Bering's Strait, live Chukchi tribes who carry on intercourse with the American side. Moreover there are details of Mexican civilization which are most easily accounted for on the supposition that they were borrowed from Asia. They do not seem ancient enough to have to do with a remote Asiatic origin of the

nations of America, but rather to be results of comparatively modern intercourse between Asia and America. Humboldt (*Vues des Cordillères*, Pl. xxiii.) compared the Mexican calendar with that in use in eastern Asia. The Mongols, Tibetans, Chinese and other neighbouring nations have a cycle or series of twelve animals, viz. rat, bull, tiger, hare, dragon, serpent, horse, goat, ape, cock, dog, pig, which may possibly be an imitation of the ordinary Babylonian-Greek zodiac familiar to ourselves. The Mongolian peoples not only count their lunar months by these signs, but they reckon the successive days by them, rat-day, bull-day, tiger-day, &c., and also, by combining the twelve signs in rotation with the elements, they obtain a means of marking each year in the sixty-year cycle, as the wood-rat year, the fire-tiger year, &c. This method is highly artificial, and the reappearance of its principle in the Mexican and Central American calendar is suggestive of importation from Asia. Humboldt also discussed the Mexican doctrine of four ages of the world belonging to water, earth, air and fire, and ending respectively by deluge, earthquake, tempest and conflagration. The resemblance of this to some versions of the Hindu doctrine of the four ages or yuga is hardly to be accounted for except on the hypothesis that the Mexican theology contains ideas learnt from Asiatics. Among Asiatic points of resemblance to which attention has since been called is the Mexican belief in the nine stages of heaven and hell, an idea which nothing in nature would suggest directly to a barbaric people, but which corresponds to the idea of successive heavens and hells among Brahmans and Buddhists, who apparently learnt it (in common with our own ancestors) from the Babylonian-Greek astronomical theory of successive stages or concentric planetary spheres belonging to the planets, &c. The Spanish chronicles also give accounts of a Mexican game called *patolli*, played at the time of the conquest with coloured stones moved on the squares of a cross-shaped figure, according to the throws of beans marked on one side; the descriptions of this rather complicated game correspond closely with the Hindu backgammon called *pachisi* (see Tylor in *Jour. Anthropol. Inst.*, viii. 116).

The native history of Mexico and Central America is entitled to more respect than the mere recollections of savage tribes. The Mexican pictures so far approached writing proper as to set down legibly the names of persons and places and the dates of events, and at least helped the professional historians to remember the traditions repeated orally from generation to generation. Thus actual documents of native Aztec history, or copies of them, are still open to the study of scholars, while after the conquest interpretations of these were drawn up in writing by Spanish-educated Mexicans, and histories founded on them with the aid of traditional memory were written by Ixtlilochitl and Tezozomoc. In Central America the rows of complex hieroglyphs to be seen sculptured on the ruined temples probably served a similar purpose. The documents written by natives in later times thus more or less represent real records of the past, but the task of separating myth from history is of the utmost difficulty. Among the most curious documents of early America is the *Popol-Vuh* or national book of the Quiché kingdom of Guatemala, a compilation of traditions written down by native scribes, found and translated by Father Ximenez about 1700, and published by Scherzer (Vienna, 1857) and Brasseur de Bourbourg (Paris, 1861). This book begins with the time when there was only the heaven with its boundaries towards the four winds, but as yet there was no body, nothing that clung to anything else, nothing that balanced itself or rubbed together or made a sound; there was nought below but the calm sea alone in the silent darkness. Alone were the Creator, the Former, the Ruler, the Feathered Serpent, they who give being and whose name is Gucumatz. Then follows the creation, when the creators said "Earth," and the earth was formed like a cloud or a fog, and the mountains appeared like lobsters from the water, cypress and pine covered the hills and valleys, and their forests were peopled with beasts and birds, but these could not speak the name of their creators, but could only chatter and croak. So man was made first of clay, but he was strengthless and senseless

and melted in the water; then they made a race of wooden mannikins, but these were useless creatures without heart or mind, and they were destroyed by a great flood and pitch poured down on them from heaven, those who were left of them being turned into the apes still to be seen in the woods. After this comes the creation of the four men and their wives who are the ancestors of the Quichés, and the tradition records the migrations of the nation to Tulan, otherwise called the Seven Caves, and thence across the sea, whose waters were divided for their passage. It is worth while to mention these few early incidents of the national legend of Guatemala, because their Biblical incidents show how native tradition incorporated matter learnt from the white men. Moreover, this Central American document, mythical as it is, has an historical importance from its bringing in names belonging also to the traditions of Mexico proper. Thus Gucumatz, "Feathered Serpent" corresponds in name to the Mexican deity Quetzalcoatl; Tulan and the Seven Caves are familiar words in the Aztec migration traditions, and there is even mention of a chief of Toltecat, a name plainly referring to the famed Toltecs. Thus the legends of the *Popol-Vuh* confirm what is learnt from comparing the culture of Central America and Mexico proper, that, though these districts were not connected by language, the intercourse between them had been sufficient to justify the anthropologist in including both districts in one region. Historical value of the ordinary kind may be found in the latter part of the *Popol-Vuh*, which gives names of chiefs down to the time when they began to bear Spanish names and the great city of Quiché became the deserted ruin of Santa Cruz. The Maya district of Yucatan has also some vestiges of native traditions in the manuscript translated by D. Pio Perez (in Stephens, *Incidents of Travel in Yucatan*) and in the remarkable 16th century *Relacion de las cosas de Yucatan* by Diego de Landa, published by Brasseur de Bourbourg (Paris, 1864). As in the Guatemala traditions, we hear of ancient migration from the Mexican legendary region of Tula; and here the leaders are four famous chiefs or ancestors who bear the Aztec name of the Tutul-Xiu, which means "Bird-Tree." Unfortunately for the historical standing of these four ancestors, there are in the Aztec picture-writings representations of four trees, each with a bird perched on it, and placed facing the four quarters, which make it probable that the four Tutul-Xiu of tradition may be only mythic personifications of the four cardinal points (see Schultz-Sellack in *Zeitschr. f. Ethn.*, 1879, p. 209). Nevertheless, part of the later Maya records may be genuine—for instance, when they relate the war about three centuries before the Spanish conquest, when the king of Chichen-Itza destroyed the great city of Mayapan. Though the Central American native kings have too little interest for traditions of them to be dwelt on here, they bring into view one important historical point—that the ruined cities of this region are not monuments of a forgotten past, but that at least some of them belong to history, having been inhabited up to the conquest, apparently by the very nations who built them.

Turning now to the native chronicles of the Mexican nations, these are records going back to the 12th or 13th century, with some vague but not worthless recollections of national events from times some centuries earlier. These traditions, in some measure borne out by linguistic evidence of names, point to the immigration of detachments of a widespread race speaking a common language, which is represented by the Aztec, still a spoken language in Mexico. This language was called *nahuatl*, and one who spoke it as his native tongue was called *nahuatlacatl*, so that modern anthropologists are following native precedent when they use the term *Nahua* for the whole series of peoples now under consideration. Earliest of the Nahua nations, the Toltecs are traditionally related to have left their northern home of Huehuetlapallan in the 6th century; and there is other evidence of the real existence of the nation. Their name *Toltecatl* signifies an inhabitant of *Tollan* (land of reeds), a place which has a definite geographical site in the present Tulan or Tula, north of the valley of Anahuac, where a Toltec kingdom seems to have had its centre. To this nation was due the introduction

of maize and cotton into Mexico, the skilful workmanship in gold and silver, the art of building on a scale of vastness still witnessed to by the mound of Cholula, said to be Toltec work, and the Mexican hieroglyphic writing and calendar. With the Toltecs is associated the tradition of Quetzalcoatl, a name which presents itself in Mexican religion as that of a great deity, god of the air, and in legend as that of a saintly ruler and civilizer. His brown and beardless worshippers describe him as of another race, a white man with noble features, long black hair and full beard, dressed in flowing robes. He came from Tulan or from Yucatan (for the stories differ widely), and dwelt twenty years among them, teaching men to follow his austere and virtuous life, to hate all violence and war, to sacrifice no men or beasts on the altars, and to give mild offerings of bread and flowers and perfumes, and to do penance by the votaries drawing blood with thorns from their own bodies. Legend tells stories of his teaching men picture-writing and the calendar, and also the artistic work of the silversmith, for which Cholula was long famed; but at last he departed, some say towards the unknown land of Tlapallan, but others to Coatzacoalcos on the Atlantic coast on the confines of Central America, where native tradition still keeps up the divine names of Gucumatz among the Quichés and Cukulcan among the Mayas, these names have the same meaning as Quetzalcoatl in Aztec, viz. "Feathered Serpent." Native tradition held that when Quetzalcoatl reached the Atlantic he sent back his companions to tell the Cholulans that in a future age his brethren, white men and bearded like himself, should land there from the sea where the sun rises and come to rule the country. That there is a basis of reality in the Toltec traditions is shown by the word *toltecatl* having become among the later Aztecs a substantive signifying an artist or skilled craftsman. It is further related by the Mexican historians that the Toltec nation all but perished in the 11th century by years of drought, famine and pestilence, a few only of the survivors remaining in the land, while the rest migrated into Yucatan and Guatemala. After the Toltecs came the Chichimecs, whose name, derived from *chichi*, dog, is applied to many rude tribes; they are said to have come from Amatequacan under a king named Xolotl, names which being Aztec imply that the nation was Nahua; at any rate they appear afterwards as fusing with more cultured Nahua nations in the neighbourhood of Tezucoc. Lastly is recorded the Mexican immigration of the seven nations, Xochimilca, Chalca, Tepaneca, Acolhua, Tlahuica, Tlascalteca, Azteca. This classification of the Nahuatlac tribes has a meaning and value. It is true that Aztlan, the land whence the Aztecs traced their name and source, cannot be identified, but the later stages of the long Aztec migration seem historical, and the map of Mexico still shows the names of several settlements recorded in the curious migration map, published by Gemelli Careri (*Giro del mondo*, Venice, 1728) and commented on by Humboldt; among these local names are Tzompanco, "place of skulls," now Zumpango in the north of the Mexican valley, and Chalpuitepec, "grasshopper hill," now a suburb of the city of Mexico itself, where the Aztecs are recorded to have celebrated in 1195 the festival of tying up the "bundle of years" and beginning a new cycle.

The Aztecs moving from place to place in Anahuac found little welcome from the Nahua peoples already settled there. One of the first clear events of the Aztec arrival is their being made tributary by the Tepanecs, in whose service they showed their warlike prowess in the fight near Tepeyacac, where now stands the famous shrine of Our Lady of Guadalupe. Thus they overcame the Acolhuas, who had made Tezucoc a centre of prosperity. By the 13th century the Aztecs by their ferocity had banded their neighbours together against them; some were driven to take refuge on the reedy lake shore at Acocolco, while others were taken as captives into Culhuacan. The king of this district was Coxcoxtli, whose name has gained an undeserved reputation even in Europe as "Coxcox, the Mexican Noah," from a scene in the native picture-writing where his name appears together with the figure of a man floating in a dug-out tree, which has been mistaken even by Humboldt for a representation of the

Mexican deluge-myth. Coxcohtli used the help of the Aztecs against the Xochimilco people; but his own nation, horrified at their bloodthirsty sacrifice of prisoners, drove them out to the islands and swamps of the great salt lagoon, where they are said to have taken to making their *chinampas* or floating gardens of mud heaped on rafts of reeds and brush, which in later times were so remarkable a feature of Mexico. As one of the Aztec chiefs at the time of the founding of their city was called Tenoch, it is likely that from him was derived the name Tenochtitlan or "Stone-cactus place." Written as this name is in pictures or rebus, it probably suggested the invention of the well-known legend of a prophecy that the war-god's temple should be built where a prickly pear was found growing on a rock, and perched on it an eagle holding a serpent; this legend is still commemorated on the coins of Mexico. Mexico-Tenochtitlan, founded about 1325, for many years afterwards probably remained a cluster of huts, and the higher civilization of the country was still to be found, especially among the Acolhuas in Tezcuco. The wars of this nation with the Tepanecs, which went on into the 15th century, were merely destructive, but larger effects arose from the expeditions under the Culhua king Acamapichtli, where the Aztec warriors were prominent, and which extended far outside the valley of Anahuac. Especially a foray southward to Quauhnahuac, now Cuernavaca, on the watershed between the Atlantic and Pacific, brought goldsmiths and other craftsmen to Tenochtitlan, which now began to rise in arts, the Aztecs laying aside their rude garments of aloë-fibre for more costly clothing, and going out as traders for foreign merchandise. In the 14th century the last great national struggle took place. The Acolhuas had at first the advantage, but Ixtlilxochitl did not follow up the beaten Aztecs but allowed them to make peace, whereupon, under professions of submission, they fell upon and sacked the city of Tezcuco. The next king of Tezcuco, Nezahualcoyotl, turned the course of war, when Azcapuzalco, the Tepanec stronghold, was taken and the inhabitants sold as slaves by the conquering Acolhuas and Aztecs; the place thus degraded became afterwards the great slave-market of Mexico. In this war we first meet with the Aztec name Motecuzoma, afterwards so famous in its Spanish form Montezuma. About 1430 took place the triple alliance of the Acolhua, Aztec and Tepanec kings, whose capitals were Tezcuco, Mexico and Tlacopan, the latter standing much below the other two. In fact the rest of native history may be fairly called the Aztec period, notwithstanding the magnificence and culture which make Tezcuco celebrated under Nezahualcoyotl and his son Nezahualpilli. When the first Motecuzoma was crowned king of the Aztecs, the Mexican sway extended far beyond the valley plateau of its origin, and the gods of conquered nations around had their shrines set up in Tenochtitlan in manifest inferiority to the temple of Huitzilopochtli, the war-god of the Aztec conquerors. The rich region of Quauhnahuac became tributary; the Miztec country was invaded southward to the Pacific, and the Xicalanca region to what is now Vera Cruz. It was not merely for conquest and tribute that the fierce Mexicans ravaged the neighbourhoods, but they had a stronger motive than either in the desire to obtain multitudes of prisoners whose hearts were to be torn out by the sacrificing priests to propitiate a pantheon of gods who well personified their bloodthirsty worshippers. (E. B. T.)

Ancient Civilization.

While the prairie tribes of America lived under the loose sway of chiefs and councils of old men, the settled nations of Mexico had attained to a highly organized government. This may be seen by the elaborate balance of power maintained in the federation of Mexico, Tezcuco and Tlacopan, where each king was absolute in his own country, but in war or other public interests they acted jointly, with powers in something like proportion in which they divided conquered lands and spoil, which was two-fifths each to Mexico and Tezcuco and one-fifth to Tlacopan. The successor of the Aztec king was customarily a chosen brother or nephew, the eldest having the first claim unless set aside as incompetent; this mode of succession, which has been looked on as an elaborate device for securing practical advantages, seems rather to have arisen out of the law of choice among the descendants of the female line, found in American tribes of much lower culture. Something like this appears in the succession of

kings of Tezcuco and Tlacopan, which went to sons by the principal wife, who was usually of the Aztec royal family. The Mexican chronicles, however, show instances of the king's son succeeding or of powerful chiefs being elected to the kingship. The term republic is sometimes used to describe the little state of Tlascala, but this was in fact a federation of four chiefs, with an assembly of nobles. In the Zapotec district the Wiyatao or high-priest of Zopaa was a divine ruler before whom all prostrated themselves with faces to the ground; he was even too sacred to allow his foot to touch the earth, and was only seen carried in a litter.

The accounts of the palaces of the native kings must be taken with some reserve, from the tendency to use descriptive terms not actually untrue, but which convey erroneous ideas taken from European architecture; thus what are called *Palaces, etc.*, columns of porphyry and jasper supporting marble balconies might perhaps be better described as piers carrying slabs, while the apartments and terraces must have been more remarkable for number and extent than architectural grandeur, being but low one-storied buildings. The principal palace of Mexico consisted of hundreds of rooms ranged round three open squares, of such extent that one of the companions of Cortes records having four times wandered about till he was tired, without seeing the whole. Not less remarkable was the palace of Tezcuco, surrounded with its groves and pleasure-gardens, and the remains of the palace and remains of the buildings above ground, the neighbouring hill of Tezotzinco still has its stone steps and terraces; and the immense embankment carrying the aqueduct-channel of hewn stone which supplied water to basins cut in the solid rock still remains to prove that the chroniclers' descriptions, if highly coloured, were at any rate genuine. Till the 18th century the gigantic figures of Axayacatl and his son Montezuma were to be seen carved in the porphyry hill of Chapultepec, but these as well as the hanging gardens have been destroyed, and only the groves of *ahuehuete* (cypress) remain of the ancient beauties of the place. That in the palace gardens flowed from the *terra caviene* were transplanted, and water-worked fountains fresh and salt pools fit for each kind, that all kinds of birds and beasts were kept in well-appointed zoological gardens, where there were homes even for alligators and snakes—all this testifies to a cultivation of natural history which was really beyond the European level of the time. From the palaces and retinues of thousands of servants attached to the royal service may be inferred at once the despotic power of the Mexican rulers and the heavy taxation of the people; in fact some of the most remarkable of the picture-writings are tribute-rolls enumerating by hundreds and thousands the mantles, ocelot-skins, bags of gold-dust, bronze hatchets, loads of chocolate, &c., furnished periodically by the towns. Below the king was a numerous and powerful class of nobles, the highest of whom (*tlatoas*) were great vassals over a little more than the name and tribute to their feudal lord, while the natural result of the unfitness of the noble class was that the king to keep them in check increased their numbers, brought them to the capital as councillors, and balanced their influence by military and household officers, and by a rich and powerful merchant class. The nobles not only had privileges of rank and dignity, but substantial power over the plebeian or peasant class (*macehuallis*). The greatest estates belonged to the king, or had been granted to military chiefs whose sons succeeded them, or were the endowments of temples, but the *calpulli* or village community still survived, and each freeman of the tribe held a tilled his portion of the common lands. Below the freemen were the slaves, who were war-captive persons enslaved for punishment, or children sold by their parents. Prisoners of war were mostly doomed to sacrifice, but other classes of slaves were mildly treated, retaining civil rights, and their children were born free.

The superior courts of law formed part of the palace, and there were tribunals in the principal cities, over each of which presided a supreme judge or *chihuacoatl*, who was irremovable, and whose criminal decisions not even the king might reverse; *Justice*, he appointed the lower judges and heard appeals from them; it is doubtful whether he judged in civil cases, but both kinds of suits were heard in the court below, by the *Hacatecatl* and his two associates, below who were the ward-magistrates. Lands were set apart for the maintenance of the judges, and indeed nothing gives us a better idea of the elaborate civilization of Mexico than this judicial system which culminated in a general court and council of state presided over by the king. The laws and records of suits were set down in picture-writings, of which some are still to be seen; sentence of death was recorded by drawing a line with an arrow across the portrait of the condemned, and the chronicles describe the barbaric solemnity with which the king passed sentence sitting on a golden and jewelled throne in the divine tribunal, with one hand on an ornamented skull and the golden arrow in the other. Among the resemblances to old-world law was the use of a judicial oath, the witness touching the hand with his finger and putting it to his lips, thus swearing by Mother Earth. In the criminal laws were of course severity, even petty theft being punished by the thief being enslaved to the person he had robbed, while to steal a tobacco pouch or twenty ears of corn was death; he who pilfered in the market was then and there beaten to death, and he who insulted Xipe, the god of the gold- and silver-smiths, by stealing his precious metal, was skinned alive and sacrificed to the offended deity. Though aloë-beer or "pulque" was allowed

for feasts and to invalids in moderation, and old people over seventy seem to be represented in one of the picture-writings as having liberty of drunkenness, young men found drunk were clubbed to death and young women stoned. For such offences as witchcraft, fraud, removing landmarks, and adultery the criminal had his heart cut out on the altar, or his head crushed between two stones, while even lesser punishments were meted out as that of slanders, whose heads were singed with a pine-torch to the scalp.

Based on conquest as the Aztec kingdom was, and with the most bloodthirsty religion the world ever saw, the nation was, above all, a fighting community. To be a tried soldier was the road to honour and office, and the king could not be enthroned till he had with his own hand taken captives to be butchered on the war-god's altar at his coronation. The common soldiers were promoted for acts of daring, and the children of chiefs were regularly trained to war, and initiated by being sent into battle with those who with others at the youth took his first prisoner, but his future rise depended on how many captives he took unaided in fight with warlike enemies; by such feats he gained the dignity of wearing coloured blankets, tassels and lip-jewels, and reached such military titles as that of "guiding eagle." The Mexican military costumes are to be seen in the picture-writings, where the military orders of princes, eagles and tigers are known by their braided hair, eagles' beaks and spotted armour. The common soldiers went into battle illiant in savage war-paint, but those of high rank had wooden birds on their heads, and wore armour of gold and silver, wooden greaves, and especially the *itcheapilli*, the quilted cotton tunic two fingers thick, so serviceable as a protection from arrows that the Spanish invaders were glad to adopt it. The archers shot well and with strong bows, though their arrows were generally tipped only with stone or bone; their shields or targets, mostly round, were of ordinary barbaric forms; the spears or javelins had heads of obsidian or bronze, and were sometimes hurled with a spear-thrower or *atlatl*, of which pictures and specimens still exist, showing it to be similar in principle to those used by the Australians and Eskimo. The most characteristic weapon of the Mexicans was the *maguahuatl* or "hand-wood," a club set with two rows of large sharp obsidian flakes, a well-directed blow with which would cut down man or horse. These two last-mentioned weapons have the look of highly developed savage forms, while on the other hand the military organization was in some respects equal to that of an Asiatic nation, with its regular companies commanded each by its captain and provided with its standard. The armies were very large, an expedition often consisting of several tens of thousands, and the tactics of the commanders were quite rudimentary, consisting merely of attack by arrows and javelins at a distance, gradually closing into a hand-to-hand fight with clubs and spears, with an occasional feigned retreat to draw the enemy into an ambushade. Fortification was well understood, as may still be seen in the remains of walled and escarped strongholds on hills and in steep ravines, while lagoon-cities like Mexico had the water approaches defended by fleets of boats and the causeways protected by towers and ditches; even after the town was entered, the pyramid-temples by their surrounding walls were forts capable of stubborn resistance. It was held unrighteous to invade another nation without a solemn embassy to warn their chiefs of the miseries to which they exposed themselves by refusing the submission demanded, and this again was followed by a declaration of war, but in Mexico this degenerated into a ceremonial farce, where tribute was claimed or an Aztec god was offered to be worshipped in order to pick a quarrel as a pretext for an invasion already planned to satisfy the soldiers with lands and plunder, and to meet the priestly necessities for more human sacrifices.

According to the accounts of the Mexican religion are some passages referring to the belief in a supreme deity. The word *teotl*, god, has been thought in some cases to bear this signification, but its meaning is that of deity in general, and it is applied not only to the sun-god but to very inferior gods. It is related that Nezahualcoyotl, the poet-king of Tezcuco, built a nine-storied temple with a stary roof above, in honour of the invisible deity called *Tloquehualtepec*, "who he is all in himself," or *Ipatlincatl*, "the one from whom he came," and who was sacrificed, not by bloody sacrifices, but by incense and flowers. These divinities, however, seem to have had little or no place in the popular faith, which was occupied by polytheistic gods of the ordinary barbaric type. Tezcatlipoca was held to be the highest of these, and at the festival of all the gods his footsteps were expected to appear in the flour strewn to receive this sign of their coming. He was plainly an ancient deity of the race, for attributes of many kinds are crowded together in him. Between him and Quetzalcoatl, the ancient deity of Chalchicomula, there is a close relationship. In the legends, *Quetzalcoatl* came into the land to teach men to till the soil, to work metals and to rule a well-ordered state; the two gods played their famous match at the ball-game, and Tezcatlipoca persuaded the weary Quetzalcoatl to drink the magic pulque that sent him roaming to the distant ocean, where he embarked in his boat and disappeared from among men.¹ These deities are not easily

analysed, but on the other hand Tonatihu and Metztli, the sun and moon, stand out distinctly as nature gods, and the traveller still sees in the huge adobe pyramids of Teotihuacan, with their sides oriented to the four quarters, an evidence of the importance of their worship. The war-god Huitzilopochtli was the real head of the Aztec pantheon; his idol remains in Mexico, a huge block of basalt on which is sculptured, on one of the ends, the figure of his personage, adorned with the humming-bird feather on the left hand and the quetzalcoatl's wing on the not less frightful war-goddess Teoyamiqui, or "divine war-death," occupies the other side. Centeotl, the goddess of the all-nourishing maize, was patroness of the earth and mother of the gods, while Miclantecuhtli, lord of dead-land, ruled over the departed in the dim under-world. There were numbers of lesser deities, such as Tlazolteotl, goddess of pleasure, worshipped by courtesans, Tezcatzoncatl, god of strong drink, whose garment in grim irony clothed the drunkard's corpse, and Xipe, patron of the goldsmiths. Below these were the nature-spirits of hills and groves whose shrines were built by the roadside. The temples were called *teocalli* or "god's house," and rivalled in size as they resembled in form the temples of ancient Babylon. They were pyramids on a square or oblong base, rising in successive terraces to a small summit-platform. The great *teocalli* of Huitzilopochtli in the city of Mexico stood in an immense square, whence radiated the four principal thoroughfares, its courtyard being enclosed by a square, of which the stone wall, called the *teompantli* or serpent-wall from its sculptured serpents, measured nearly a quarter of a mile. The city of Mexico, on the oblong pyramid of rubble cased with hewn stone and centered 375 x 300 ft. at the base, and rising steeply in five terraces to the height of 86 ft., showed conspicuously to the city the long processions of priests and victims winding along the terraces and up to corner flights of steps. On the paved platform were three-storey tower temples in whose ground-floor stood the stone images and altars, and before that of the war-god the green stone of sacrifice, humped so as to bend upward the body of the victim that the priest might more easily slash open the breast with his obsidian knife, and cut out the heart and hold it up before the god, while the captives and his friends were waiting below for the carcass to be tumbled down the steps for them to carry home to be cooked for the feast of victory. Before the shrines reeking with the stench of slaughter the eternal fires were kept burning, and on the platform stood the huge drum, covered with snakes' skin, whose fearful sound was heard for miles. From the terrace could be seen seventy or more other temples within the enclosure, with their images and blazing fires, and the *teompantli* of the city of Mexico, which was the city of the thousands, were sketched on cross-sticks or built into towers. They also could be seen the flat circular *temalcalli* or "spindle-stone," where captives armed with wooden weapons were allowed the mockery of a gladiatorial fight against well-armed champions. The great pyramid of Cholula with its hemispherical temple of Quetzalcoatl at the top, now an almost shapeless hill surmounted by a church, was about thrice as long and twice as high as the *teocalli* of Mexico. A large fraction of the Mexican population were set apart as priests or attendants to the services of the gods. The rites performed were such as are found elsewhere—prayer, sacrifice, processions, dances,

Brasseur de Bourbourg. It is the interpretation of different mythological and historical Mexican picture-writings, composed by an anonymous author some time after the conquest and copied by Fernand Cortez in 1519 (1648). It belonged to the priceless collection of Mexican documents collected by the king in the 18th century by Lorenzo Boturini (see his "Catálogo del Museo historico indiano," appendix of his *Idea de una nueva historia general de la America septentrional*, Madrid, 1746, § viii., No. 13). It is named there *Historia de los reynos de Colhuacan y de Mexico*. Other copies of the same manuscript, made by Leon y Gama, José Pichardo, Aubin and Brasseur, exist in the Paris National Library in the Aubin-Goupp collection. Brasseur died before he could realize his plan to publish the MS. in Nahautl with a translation. Some extracts are to be found in his *Historie des nations civilisées du Mexique*, and in Leon y Gama, *Dos Piedras*, ed. Bustamante (Mexico, 1832). Larger fragments of the Ixtlilxochitl copy were published in the *Anales del museo nacional de Mexico*, tom. iii., appx. pp. 7-70; but in this edition the Mexican text is very corrupt, and the two Spanish translations are by no means exact. The Paris MSS. and the Ixtlilxochitl copy were carefully collated by Dr Walter Lehmann (see *Zeitschrift für Ethnologie*, 1906, pp. 732-760; *Journées de la Société des américanistes de Paris*, nouv. sér., tom. iii. No. 2; Dr E. Selser, *Verhandlungen des XV. Internationalen Amerikanisten-Kongresses*, Vienna, 1909, II., pp. 129-150). The precious Ixtlilxochitl copy was found by Lehmann in the library of the National Museum of Mexico, and arrangements were made for the publication of the whole MS. by him in conjunction with Professor E. Selser. Another very important MS. was discovered by Dr Lehmann, in Guatemala. It is the MS. of Father Francisco Ximenez, *Historia de la Provincia de San Vicente de Chiapa y de Guatemala*, in three big volumes, the first of which contains the Spanish legends of the Quiché myths and the Popol-Vuh. The MS. was bought at the expense of the duke of Loubat, who decided to present it, after the death of Dr Lehmann, to the Royal Library at Berlin.

¹One of the most important sources for the ancient Mexican traditions and myths is the so-called "Codex Chimalpopuca," a manuscript in the Mexican language discovered by the Abbé

chants, fasting and other austerities, but there are some peculiarities of detail. Prayers and other formulas have been copied down by Sahagun and other chroniclers, of endless prolixity, but not without occasional touches of pathos. These prayers seem essentially genuine; indeed there was no European model from which they could have been imitated; but at the same time it must be remembered that they come down in Spanish writing, and not untouched by Spanish influences, as in one passage where there is a mention of sheep, an animal unknown to the Mexicans. As to sacrifices, maize and other vegetables were offered, and occasionally rabbits, quails, &c., but, in the absence of cattle, human sacrifice was the chief rite, and cannibalism prevailed at the feasts. Incense was constantly used, especially the *copalli* (copal) well known to us for varnish; little terra-cotta censers are among the commonest of Mexican antiquities. Long and severe religious fasts were customary at special seasons, and drawing blood from the arms, legs and body, by thrusting in aloë-thorns, and passing sharp sticks through the tongue, was an habitual act of devotion recalling the similar practices of devotees in India. The calendar of religious festivals of the Mexican year has been preserved. Each 20-day period had one or more such celebrations. In the month of the "diminishing waters" the rain gods or Tlalocs were propitiated by a procession of priests with music of flutes and trumpets carrying on plumed litters infants with painted faces, in gay clothing with coloured paper wings, to be sacrificed on the mountains or in a whirlpool in the lake. It is said that the people wept as they passed by; but if so this may have been a customary formality, for the religion of these nations must have quenched all human sympathy. In the month of the god Xipe-totoc, already mentioned, as the festival called the "flaying of men" for the human victims being flayed, after their hearts were torn out, for young men to dress in their skins and perform dances and sham fights. The succeeding festival of Camaxtli was marked by a severe fast of the priests, after which stone knives were prepared with which a hole was cut through the tongue of each, and numbers of sticks passed through. For the great festival of Tezcatlipoca, the handsomest and noblest of the captives of the year had been chosen as the incarnate representative of the god, and paraded the streets for public adoration dressed in an embroidered mantle with gold and garlands of flowers. At the end of the year for the last month they married him to four girls representing four goddesses; on the last day wives and pages escorted him to the little temple of Tlacochoalco, where he mounted the stairs, breaking an earthenware flute against each step; this was a symbolic farewell to the joys of the world, for as he reached the top he was seized by the priests, his heart torn out and held up to the sun, his head spitted on the *tzompantli*, and his body eaten as sacred food, the people drawing from his fate the moral lesson that riches and pleasure may turn into poverty and sorrow. The manner of the victim's death in these instances afforded scope for variety; of these the ancient made them, and they were then thrown into the fire for the fire-god, or crushed them between two balanced stones at the harvest-festival. The ordinary pleasures of festivals were mingled with all this, such as dances in beast-masks, sham fights and children's games, but the type of a religious function was a sickening butchery followed by a cannibal feast.

The Mexican priesthood were much concerned with the art of picture-writing, which they used systematically as a means of recording religious festivals and legends, as well as keeping calendars of years and recording the historical events which they deemed of importance. Fragments of these interesting documents, with their translations, may be seen in Kingsborough; splendid reproductions of the beautiful Mexican and Mixteco-Zapotecan codices have also been published at the expense of the duke of Loubat and by the "Junta Colombina" (Mexico, 1892). Gods are represented with their appropriate attributes—the fire-god hurling his spear, the moon-goddess with a shell, &c.; the scenes of human life are pictures of warriors fighting with club and spear, men paddling in canoes, women spinning and weaving, &c. An important step towards phonetic writing appears in the picture-names of places and persons. The simplest forms of these depict the object signified by the name, as where *Chaguitapoc* or "grasshopper-hill" is represented by a grasshopper on a hill, or a stone with a cactus on it stands for *Tenoch* or "stone-cactus," the founder of *Tenochtitlan*. The system had, however, risen a stage beyond this when objects were drawn to represent, not themselves, but the syllables forming their names, as where a trap, an eagle, a pricker, and a hand are put together not to represent these objects, but in order that the syllables of their names *mo-quauh-zo-ma* should spell the word *Moquauhzo-ma* (see Aubin's introduction to Brasseur de Blandy's *Hist. de l'Amérique*, i. 68). The analogy of this with the manner in which the Egyptian hieroglyphs were written phonetic signs is remarkable, and writing might have been invented again in Mexico had it not been for the Spanish conquest. The Aztec numerals, which were vigesimal or reckoned by scores, were depicted by dots or circles up to 20, which was represented by a flag, 400 (a score of scores) by a feather, and 8000 (a score of scores of scores) by a purse; but for convenience these symbols might be halved and quartered, so that 534 might be shown by one feather, one quarter of a feather, one flag, one-half of a flag, and four dots. The Mexican calendar depended on the combination of numbers with

picture-signs, of which the four principal were the rabbit, reed, flint, house—*tochtli, acatl, tecpatl, calli*. The cycle of 52 years was reckoned by combining these signs in rotation with numbers up to 13, thus: 1 rabbit, 2 reed, 3 flint, 4 house, 5 rabbit, 6 reed, &c. By accident this calendar may be exactly illustrated with a modern pack of cards laid out in rotation of the four suits, as, ace of hearts, 2 of spades, 3 of diamonds, 4 of clubs, 5 of hearts, 6 of spades, &c. In the Mexican ritual calendar of the days of the year, the same method is carried further; the series of twenty days that are combined in rotation with numbers up to 13; as this cycle of days only reaches 260, a series of nine other signs are affixed in addition, to make up the 365-day year. It is plain that this rotation of signs served no useful purpose whatever, being less convenient than ordinary counting such as the Mexicans employed in their other calendar already mentioned, where the 20-day periods had each a name like our months, and their days had signs in regular order. Its historical interest depends on its resemblance to the calendar-system of central and eastern Asia, where among Mongols, Tibetans, Chinese, &c., series of signs are thus combined to reckon years, months and days; for instance, the Mongol cycle of 60 years is recorded by the zodiac or series of 12 signs—mouse, bull, tiger, &c., combined in rotation with the five male and female elements—fire, earth, iron, water, wood; as "male-fire-bull" year, &c. This comparison is worked out in Humboldt's *Vues des Cordillères*, as evidence of Mexican civilization being borrowed from Asia. Naturally the Mexican calendar-system lent itself to magic in the same way as the similar zodiac-signs of the Old World, each person's fate being affected by the qualities of the signs he was born under, and the astrologer predicting the actual time to advise on every event of life. Of all Mexican festivals the most solemn was that of the *ziuhmohualli*, or "year-binding," when the 52-year cycle or bundle of years came to an end. It was believed that the destruction of the world, which after the Hindu manner the Mexicans held to have already taken place three or four times, would happen again at the end of a cycle. As the time drew near, the anxious population cleansed their houses and put out all fire, and on the last day after sunset the priests, dressed in the garb of gods, set out in procession for the hill of Huixachtla, there to watch for the approach of the Pleiades to the zenith, which gave the auspicious signal for the lighting of the new fire. The first of the captives was then taken to the altar, and led on his breast by the wooden drill of the priest, then the victim's heart was torn out, and his body flung on the pile kindled with the new flame. The people watching from their flat housetops all the country round saw joy the flame on the sacred hill, and hailed it with a thank-offering of drops of blood drawn from their ears with sharp stone-flakes. Swift runners carried burning brands to re-ignite the fires of the land, the sacred fire on the *teocalli* of the war-god blazed up again, and the people began with feasting and rejoicing the new cycle.

At the same rate that of the upper class, was a systematic discipline much under the control of religion, which here presents itself under a more favourable light. After the birth of a child, the *tonalpohguis* or "sun-calculator" drew its horoscope from the signs it was born under, and fixed the time for its solemn lustration or baptism, performed by the nurse with appropriate prayers to the gods, when a toy shield and bow were provided if it was a boy, or a toy spindle and distaff if it was a girl, and the child received its name. An interesting picture-writing, to be seen in Kingsborough, shows the details of the boy's and girl's education, from the early time when three small circles, the first of the child show to be three years old, and a ring of half a tortilla or corn-cake shows its allowance for each meal; as they grow older the lads are seen beginning to carry burdens, paddle the canoe and fish, while the girls learn to spin and weave, grind maize, and cook—good conduct being enforced by punishments of increasing severity, up to pricking their bodies with aloë-thorns and holding their faces over burning chillies. The schools were extensive buildings attached to the temples, where from an early age boys and girls were taught by the priests to sweep the sanctuaries and keep up the sacred fires, to fast at proper seasons and draw blood for penance, and where they received moral teaching in long and verbose formulas. Those fit for a soldier's life were trained to the use of weapons and sent early to learn the hardships of war; children of craftsmen were usually taught by their fathers to follow their trade; and for the children of nobles there was elaborate instruction in history, picture-writing, astrology, religious doctrines and laws. Marriages depended much, as they do still in the East, on comparison of the horoscopes of the pair to ascertain if their birth-signs were compatible. Old women were employed as go-betweens, and the marriage ceremony was conducted by priests, who, after casting lots into the young couple by tying their garments together in a knot, after which they walked seven times round the fire, cast incense into it; after the performance of the marriage ceremony, the pair entered together on a four days' fast and penance before the marriage was completed. The funeral rites of the Mexicans are best seen in the ceremonies at the death of a king. The corpse laid out in state was provided by the priest with a jug of water for his journey, and with bunches of cut papers to pass him safely through each danger of the road—the place where the two mountains strike

together, the road guarded by the great snake and the great alligator, the eight deserts and the eight hills; they gave him garments to protect him from the cutting wind, and buried a little dog by his side to carry him across the nine waters. Then the royal body was invested in the mantles of his patron-gods, especially that of the war-god, for Mexican kings were warriors; on his face was placed a mask of turquoise mosaic and green chalcuitze, set as a heart between his lips. In older times the dead king was buried on a throne with his property and dead attendants round him. But after cremation came in a mourning procession of servants and chiefs carrying the body to the funeral pyre to be burnt by the demonstrated priests, after which the crowd of wives and slaves were exhorted to serve their lord faithfully in the next world, were sacrificed and their bodies burnt. Common people would not thus be provided with a ghostly retinue, but their simpler funeral ceremonies were observed for the great nobles.

The staple food of the Mexicans before the conquest has continued with comparatively little change among the native race, and has even been adopted by those of European blood. Maize or Indian corn was cultivated on patches of ground where, as in the Hindu *jām*, the trees and bushes were burnt and the seed planted in the soil manured by the ashes. A sharp-pointed planting stick, a wooden shovel, and a bronze-bladed hoe called a *coatl* were the simple implements. The Mexicans had a good knowledge of agriculture, especially for the cultivation of the *cacahuatl*, from which they taught the Europeans to prepare the beverage *chocolatl*; these native names passed into English as the words cacao, or coco and chocolate. Other vegetables adopted from Mexico are the tomato (*tomatl*) and the *chilli*, used as flavouring to native dishes. The maize was ground with a stone roller on the grinding stone or *metlatl*, still known over Spanish America as the *metate*, and the meal baked into thin oval cakes called by Aztecs *tlacalli*, and by Spaniards *torilla*, which resemble the flat bread of India and of Scotland. The Mexicans were also skillful makers of earthen pots, in which were cooked the native beans called by the Spanish *frijoles*, and the various savoury stews still in vogue. The juice extracted by tapping the great aloe before flowering was fermented into an intoxicating drink about the strength of beer, *octli*, by the Spaniards called *pulque*. Tobacco, smoked in leaves or cane-pipes or taken as snuff, was in use, especially at feasts. In old times Mexican clothing

was of skins of woven aloe and palm fibre, but at the time of the hot lands, spun with a spindle, and woven in a rudimentary loom without a shuttle into the mantles and breech-cloths of the men and the chemises and skirts of the women, garments often of fine texture and embroidered in colours. Ornaments of gold and silver, and jewels of polished quartz and green chalcuitze were worn—not only the ears and nose but the lips being pierced for ornaments. The artificers in gold and silver melted the metals by means of a reed-blowpipe and cast them solid or hollow, and were also skilled in hammering, and chasing, as some fine specimens remain to show, though the famous animals modelled with gold and silver, fur, feathers and scales have disappeared. Iron was not known, but copper and tin ores were mined, and the metals combined into bronze of much the same alloy as in the Old World, of which hatchet blades and other instruments were made, though their use had not superseded that of obsidian and other sharp stone flakes for cutting, shaving, &c.

Metals had passed into a currency for trading purposes, especially of the gold dust and *T-shaped* pieces of copper, while coinages furnished small change. The vast size of the market-squares with their surrounding porticos, and the importance of the caravans of merchants who traded with other nations, show that mercantile had risen into some proportion to military interests. Nor was the wealth and luxury of Mexico and surrounding regions without a corresponding development of art. The stone sculptures

such as that remaining of Xochicalco, which is figured by Humboldt, as well as the ornamented wood-work, the feather-mats and fans, are not without artistic merit. The oft-quoted poems attributed to Nezahualcoyotl may not be quite genuine, but at any rate poetry had risen above the barbaric level, while the mention of ballads among the people, court odes, and the chants of temple choirs would indicate a vocal cultivation above that of the instrumental music of drums and horns, pipes and whistles, the latter often of pottery. Solemn and gay dances were frequent, and a sport called the bird-dance excited the admiration of foreigners for the skill and daring with which groups of performers dressed as birds flitted about the air and downed the ball. The ball-game, so as to fly whirled in circles far above the ground. The ball-game of the Mexicans, called *Uachtli*, was, like tennis, the pastime of princes and nobles; special courts were built for it, and the ball of india-rubber (perhaps the first object in which Europeans became acquainted with this valuable material) might not be touched by the hands, but was driven against the walls by blows of the knee or elbow, shoulder or buttock. The favourite game of *patolli* has been already mentioned for its similarity to the *pachisi* of modern India.

The accounts given by Spanish writers of the Central Americans in their state after the Spanish conquest are very scanty in com-

parison with the voluminous descriptions of Aztec life. They bring out perfectly, however, the fact of close connexion between the two civilizations. Some Central-American peoples were actually Mexican in their language and culture, especially the Pipils and a large part of the population of Nicaragua. The investigations made by Dr Walter Lehmann in Central America (1907-1909), prove that these Mexican elements were extended through Guatemala, Salvador, a small part of Nicaragua (the territory of the Nicaraos) and on several places in the peninsula of Nicoya (Costa Rica) amongst the autochthonous Chorotega or Mangue. It is an error of the Spanish authorities to pretend that the Pipil civilization in Guatemala and Salvador is not older than the time of King Ahuitzotl (c. 1482-1486). The language spoken by the Pipils of Salvador (Balsam Coast) is a very old dialect of the Mexican language of the highland of Mexico. It has preserved in the conjugation and in the formation of the plural old forms than the classical Nahuatl itself. The separation of the Pipils from the chief tribes of the Nahuatl branch happened centuries before the conquest, and they developed a singular and characteristic civilization, which can be seen in the wonderful stone-reliefs and sculptures of Sta Lucia de Cozumalhuapa on the Pacific coast of Guatemala.

Dr Lehmann's archaeological and linguistic researches, especially in Salvador and Nicaragua, also enabled him to prove another very important fact, viz. that a mass of the population descended from the peoples of the Mexican Plateau, migrated into territories previously occupied by an older race of Mayan origin. The archaeological and linguistic evidence proves also that a great part of Salvador and Honduras was once occupied by peoples of the Maya race—Pokomam, Chorti and perhaps other unknown tribes. They left typical Mayan ruins in Honduras (Tenampua) and in Salvador (Opico near Tehuacan, Quelepa near San Miguel), which seem, however, to be destitute of Mayan hieroglyphic inscriptions. The easternmost limit of prehistoric Mayan civilization, on the Pacific coast of Central America, is Fonseca Bay, with the island of Zacate Grande.

It is noteworthy that archaeological objects of the type characteristic of northern Honduras (Ulloa Valley) have been found on the Pacific coast of Salvador. A strange stone sculpture of the so-called Chac-Mol type, known before only from the country of the Tarascs, from Talxcala and Chichen Itza, was discovered in Salvador (Ahuachapan).

Unexplored central part of Nicaragua Dr Lehmann found fragments of painted polychrome clay pottery similar to objects known from the Ulloa Valley (Honduras) amongst other ceramic pieces which seem to have been left by the ancestors of the Sumo Indians, now extinct in that territory. It is possible that these remains of Mayan pottery came into central Nicaragua as articles of commerce.

It is significant that Mayan civilization cannot be traced in any other part of Nicaragua or Costa Rica.

The abovementioned prehistoric Mayan peoples lived in contact with "barbarous" nations and with another little-known civilized race. The barbarians belonged to the great family of the Sumo-Misquito Indians, the civilized race was that of the Chorotega or Mangue (Dirian, Oroñán, &c.). The Sumo-Misquito Indians occupied the Atlantic coast and the interior of Nicaragua and Honduras, where they still live in small tribes; a dialect of the hitherto unknown Sumo languages is the Matagalpan, now extinct in Nicaragua, and nearly identical with the Matagalpan in the language spoken by the Indians of Casapuera in Salvador (Ulloa-Lempa territory). There is no doubt that, at the time of the Pipil invasion, tribes of the Sumo-Misquito family were the immediate neighbours of the Pipils towards the east and north. This fact is proved by the names of some places in Salvador, e.g. Santiago Nonohualco, San Juan Nonohualco and San Pedro Nonohualco. The word *Nonohualco* signifies in the Mexican language a place where a language changes, where another idiom begins. To the east of the three places whose names are compounded with "Nonohualco," must have dwelt, in the time of the Pipil Indians, the Nonohualca, called also by Mexican tribes Chontales or Popoloca. The western neighbours of the Sumo Indians were and are (though few still survive) the Lenca Indians, who formerly occupied large parts of Honduras. A linguistic relationship can be established between all the Indian languages spoken on the Atlantic coast and in the interior of Nicaragua and Honduras. Several tribes, such as the Paya (or Poya) and the Jicaques, form together with the Lenca, Sumo (Matagalpa, Tauakcha and Uluá) and Misquito one great family.

The Chorotega race had its centre in Nicaragua (Pacific coast) and at one time extended thence as far as Guanacaste (Costa Rica); at

another time it extended as far as Honduras (actual department of Choluteca) and into eastern Salvador as far as the state of Chiapas in Mexico, where the Chorotega penetrated amongst the Mixe. The Chorotega or Mangué language, so closely affiliated to the Chiapanec, is now extinct, but its former extension is to be recognized by many Indian local names. It seems that there was formerly a mutual interpenetration between Lenca, Sumo and Chorotega tribes. The territories of all these tribes can be more or less exactly, calculated by the existence of Indian local names. The latter country is characterized by names terminating in *luya*, water, or *quala*, river; the Sumo and Ulua country by names in *uas*, water; the Matagalpa by names in *li*, water; the Lenca by names in *lique*, *lique*, *isque* and (*at*) *quin*. Such Lenca names occur on the north-eastern boundary of the Ultra-Lenca country of Salvador. It is strange that there is not a single place-name in Salvador either of Mayan origin, or, as it seems, of Chorotegan origin. Probably the Mexican elements superseded the Maya so completely that there remained no trace of the Maya except archaeological objects; it is to be supposed that the Lenca and Sumo tribes superseded the Chorotega in Salvador. If we can be sure—and the linguistic evidence admits of no doubt—that the Chorotega had their centre in Nicaragua and thence extended north-westwards, it may be hoped that Chorotegan remains will be found in the vast territory occupied for many centuries by the Maya peoples in the Pacific part of Guatemala. These remains would, of course, be archaeological or place-names.

How closely related some of the Central-American nations were in institutions to the Mexicans appears, not only in their using the same peculiar weapons, but in the similarity of their religious rites; the conditions of their life are in some certain and constant an offender's face over burning chillies as a punishment; the native legends of Central America make mention of the royal ball-game, which was the same as the Mexican game of *tlachtli* already mentioned. At the same time many of the Central-American customs differed from the Mexican; thus in Yucatán we find the custom of the youths sleeping in a great bachelor's house, an arrangement common in various parts of the world, but not in Mexico; the same remark applies to the Maya exogamous law of a man not taking a wife of his own family name (see Diego de Landa, *Relación de las cosas de Yucatán*, p. 100), which does not correspond with Mexican custom. We have the means of comparing the personal appearance of the Mexicans and Central Americans by their portraits on early sculptures, vases, &c.; and, though there does not appear any clear distinction of race-type, the extraordinary back-sloping foreheads of such figures as those of the bas-reliefs of Palenque prove that the custom of flattening the skull in infancy prevailed in Central America to an extent quite beyond any such habit in Mexico. The notion that the ruined cities now buried in the Central-American forests were of great antiquity and the work of certain nations has been long since evident; some of them have already been abandoned before the conquest, but others were inhabited by the ancestors of the Indians who now build their mean huts and till their patches of maize round the relics of the grander life of their ancestors. In comparing these ruins in Yucatán, Chiapas, Guatemala and Honduras, it is evident that, though they are the work of two or more nations highly distinct in language, yet these nations had a common system of pictorial or written characters. One specimen of a Central-American inscription may give a general idea of them all, whether it be from the sculptured façade of a temple sketched by Catherwood, or from the painted decorations called *Dioses* and *Escrituras* (see Kingsborough), or from the chapter of Diego de Landa where he professes to explain and translate the characters themselves. These consist of combinations of faces, circles, lines, &c., arranged in compartments in so complex a manner that hardly two are found alike. How they conveyed their meaning, how far they pictorially represented ideas or spelt words in the different languages of the country, is a question not yet answered in a complete way; Landa's description (p. 320) gives a table of a number of their elements as phonetically representing letters or syllables, but, though there may be a partial truth in his rules, they are insufficient or too erroneous to serve for any such decipherment. One point to the Central-American characters is clear, that part of them are calendar-signs recording dates. From the accounts given by Landa and other writers it is plain that the Central-American calendar, reckoning the year in twenty-eight periods of thirteen days, was the same in its principle of combining signs as that of Mexico. The four leading Maya signs called *kan*, *muluc*, *ix*, *cauac* corresponded in their position to the four Aztec signs rabbit, reed, flint, house, but the meanings of the Maya signs are, unlike the Aztec, very obscure. A remarkable feature of the Central-American ruins is the frequency of truncated pillars built of new stones, with flights of steps up to the temple built on the platform at top. The resemblance of these structures to the old descriptions and pictures of the Mexican *teocallis* is so striking that this name is habitually given to them. The *teocallis* built by the Nahua or Mexican nations have been mostly destroyed, but two remain at Huatusco and Tusapan (figured in Bancroft, iv. 443, 456), which bear a strong resemblance to those of Palenque. On the whole it is not too much to say that, in spite of differences in style, the best means of judging what the temples and palaces

of Mexico were like is to be gained from the actual ruins in Central America. On the other hand, there are features in Central-American architecture which scarcely appear in Mexican. Thus at Uxmal there stands on a terraced mound the long narrow building known as the governor's house (*Casa del Gobernador*), 322 ft. long, 39 ft. wide, 26 ft. high, built of rubble stone and mortar faced with square blocks of stone, the interior of the chambers rising into a sloping roof formed by courses of masonry gradually overlapping in a false arch. The same construction is seen in the building forming the sides of a quadrangle and bearing the equally imaginary name of the nunnery (*Casa de Monjas*); the resemblance of the interior of one of its apartments to an Etruscan tomb has often been noticed (see Ferguson, *History of Architecture*, vol. i; Viollet-le-Duc, in Charnay).

The explorations made by Dr Lehmann in 1909 in the famous ruins of Teotihuacan, near Mexico city throw new light upon certain chronological problems. Like the excavations made by Dr Max Uhle in Peru, they tend to determine the relative antiquity of the different periods of the ancient civilization. They also show that these various culture-periods followed one another among the Mexicans in much the same sequence as among the Peruvians. At a considerable depth below the foundations of a temple-palace at Teotihuacan, Dr Lehmann discovered certain ceramic fragments of a type quite different from any hitherto classed as Mexican. These are painted on a fine stucco in beautiful colours (notably a kind of turquoise-green) and represent archaic forms of flowers and butterflies. The relation between the wall paintings of Teotihuacan and ornaments at Chichen Itza, as also the existence of sculptured stone yokes in Teotihuacan, the country of the Totonaques, in Guatemala in Salvador, furnish important material for the investigation of the obscure problems of the Toltecs and Olmecs, and of the extension of Maya peoples on the Atlantic coast of the Mexican Gulf from Campeche as far as Tabasco and Vera Cruz.

Attempts to trace the architecture of Central America directly from Old-World types have not been successful, while on the other hand its decoration shows proof of original invention, especially in the imitations of woodwork which passed into sculptured ornament when the material became stone instead of wood. Thus the architectural remains, though they fail to solve the problem of the culture which first found its way into Mexico, throw much light on it when their evidence is added to that of religion and customs. At any rate two things seem probable—first, that the civilizations of Mexico and Central America were pervaded by a common influence in religion, art, and custom; second, that this common element shows traces of the importation of Asiatic ideas into America.

BIBLIOGRAPHY.—The most illuminating and fundamental work on Mexican archaeology is the *Gesammelte Abhandlungen*, of Eduard Seier (vol. i. Berlin, 1902; vol. ii., 1904). For the earliest descriptions of the ancient cities of Mexico the writings of Cogolludo, Landa, Antonio del Río, Sahagún, Totonacatl and others are of the greatest value. The account by Antonio de León y Gama, *Descripción histórica y cronológica de las dos piedras que se hallaron en la plaza principal de Mexico el año de 1790* (Mexico, 1792; 2nd ed. by C. M. de Mustamante), may be specially mentioned. Much of this material is to be found in Lord Kingsborough's monumental work in 9 vols., seq., on the *Antiquities of Mexico* (London, 1831-1848). Alexander von Humboldt's *Vues des Cordillères et monuments des peuples indigènes de l'Amérique* was published in Paris in 1816. At the beginning of the 19th century the colonial government undertook a comprehensive exploration of the then known groups of ruins and their conditions were traced. In 1805-1806, in the direction of Captain Guillaume Dupuix, accompanied by Luciano Castañeda as artist. The reports were not published, however, until Kingsborough included them in his work, though some of the drawings appeared in other works. In many respects these reports are the best of the early accounts. Another early explorer was the French artist Frédéric de Waldeck, who published *Voyage pittoresque et archéologique dans la province d'Yucatan* (Paris, 1838), and whose collection of drawings appeared in 1866, with the descriptive text by Brasseur de Bourbourg, under the title *Monuments anciens du Mexique*. Among other and later works, including some who have done themselves more especially with Maya inscriptions, are: Arnold and Frost, *The American Egypt* (London, 1909); H. H. Bancroft, *The Native Races of the Pacific States* (5 vols., New York, 1874-1876, vol. iv. is devoted to "Antiquities"); A. F. Bandler, *Report on an Archaeological Tour in Mexico, 1881* (Archæol. Inst. of America, papers, Am. Ser. II.); Leopoldo Batres, *Cuadro arqueológico y etnográfico de la República Mexicana* (Mexico, n.d.); W. W. Blake, *Catalogue of the Historical and Archaeological Collections of the National Museum of Mexico* (Mexico, 1884); Eug. Boban, *Cuadro arqueológico etnográfico de la República Mexicana* (Paris, 1885); Diego de Brinco, *The Ancient Races* (New York, 1891); and *Ancient Phonetic Alphabets of Yucatan*; Desiré Charnay, *The Ancient Cities of the New World* (Transl. New York, 1887); Charnay and Viollet-le-Duc, *Cités et ruines américaines* (Paris, 1863); Alfredo Chavero (ed.), *Antigüedades mexicanas* (Mexico, 1892); Dupuix, *Antigüedades mexicanas* (Paris, 1834-1836); E. Förstemann (Numerous articles in *Globus* and other German publications, 1893-1897, on Maya inscriptions); E. T. Hamy, *Decades américaines* (Paris, 1888, 1898, 1902); Wm. H. Holmes, *Archæological Studies among the*

Ancient Cities of Mexico (Parts I. and II. Field Columbian Museum, Chicago, 1895-1897); W. Lehmann, *Ergebnisse und Aufgaben der mexicanischen Forschung* (Archiv. für Anthropologie, neue Folge, iii., 2; 1907), Eng. trans.: *Methods and Results in Mexican Research*, by Seymour de Ricci (Paris, 1909); Theobert Maler, *Neue Entdeckung von Ruinen-Städten in Mittel-Amerika* (Globus, lxx. 149-150, Braunschweig, 1896), and also contributions to American archaeological publications; A. P. Maudslayi, *Biologia Centrali-Americana-Archæologia* (London, 1897); J. F. A. Nadalillac, *Prehistoric America* (New York, 1895); Zelia Nuttall, *The Fundamental Principles of the Old and New World Civilizations* (Arch. and Ethn. Papers, Peabody Museum, Cambridge, 1901); Antonio Penafiel, *Monumentos del arte mexicano antiguo* (1 vol. text, 2 vols. plates, Berlin, 1890); Carl Sapper, *Das nördliche Mittel-Amerika* (Braunschweig, 1897); Caciclie Saler, *Auf allen Wegen in Mexico und Guatemala* (Berlin, 1900); Eduard K. Selser, "Der Charakter der aztekischen und Maya-Handschriften" (*Zeitschrift für Ethnologie*, Berlin, 1888), and other papers in various German publications; John L. Stephens (F. Catherwood, artist), *Travels in Central America* (2 vols., New York, 1841), and *Ancient Travels in Yucatan* (2 vols., New York, 1843). (E. B. T.; W. L. *)

II.—Colonial Period. 1520-1821.

The conquest of Mexico by the Spanish forces under Hernando Cortes (*q.v.*) in 1520, and the death of the last Aztec emperor, Guatemozin, introduced what is known as the colonial period of Mexican history, which lasted down to the enforced resignation of the last viceroy, O'Donouj, in 1821. During these three centuries, after a brief but most unsatisfactory experience of government by audiencias (1521-1535), sixty-four viceroys ruled over New Spain. Of these a few were ecclesiastics: two had two terms of office; only two or three were of native birth, and their previous official life had always been passed in other parts of the Spanish dominions.

New Spain was one of four great viceroalties, the other three being New Granada, Buenos Aires and Peru. Its viceroy ruled over districts differing in status and with overlapping and conflicting authorities, some of these being appointed directly by the king of Spain, and responsible to him. New Spain in its widest meaning includes the audiencias or judicial districts of Manila, San Domingo and Guatemala, and the viceroy had some sort of authority over them: but in its narrower meaning it comprised the audiencia district of Mexico and the subordinate audiencia district of Guadalajara, which together extended from Chiapas and Guatemala to beyond the eastern boundary of the modern state of Texas and northwards, eventually, to Vancouver's Island. In the course of the 18th century this came to consist of the following divisions: (1) the kingdom of Mexico, which included the peninsula of Yucatán but not the present state of Chiapas or a part of Tabasco, these belonging to Guatemala. Approximately its south border ran from a point slightly east of Tehuantepec to the bay of Honduras, and its north limit was that of the modern states of Michoacan and Guanajuato, then cutting across San Luis Potosí to a point just above Tampico. (2) The kingdom of New Galicia, including the present states of Zacatecas, Jalisco and part of San Luis Potosí. (3) The Nuevo Regno de Leon (the present state of that name). (4) The Provincias Internas, i.e. "interior" regarded from the capital, viz. Nuevo Santander (Tamaulipas, and Texas to the bay of Corpus Christi, founded 1749), the several provinces of Nuevo Biscaya or Chihuahua, Durango, Sonora with Sinaloa, Coahuila, Texas (from Corpus Christi Bay to the mouth of the Mermenton in the present state of Louisiana), and the two Californias.

The audiencia councils also advised the viceroy in matters of administration; and, as with other officials, his career was subject at its close to a formal examination by a Government and Organization commission—a process known as "taking his residencia." Local government till 1786 was largely in the hands of *alcaldes mayores* and *corregidores*, the latter established in 1531 to look after the Indians, and both appointed by purchase. Towns, which were to some extent founded after the conquest as centres of civilization for the Indians, were governed by civic officials appointed in the first instance by the governor of the province, but subsequently as a rule purchasing their posts.

The church rapidly supplemented the work of the conquerors. The first Franciscan mission arrived in 1524; other orders followed. The announcement of the apparition of *The Church and the People*, the Virgin to an Indian near Mexico City provided a place of pilgrimage and a patroness in Our Lady of Guadalupe; and the friars ingeniously used the hieroglyphic writing for instruction in Christian doctrine, and taught the natives trades, for which they showed much aptitude. The university of Mexico was founded in 1553. The Jesuits established themselves in 1572, devoting themselves actively to the education both of whites and of natives, and were a powerful factor in the exploring and civilizing of the northern districts. The Inquisition was introduced in 1571. With the natives south of the latitude of Tampico there was little trouble after the Mixton War (in Guadalupe) in 1540-1562, save for occasional risings in Yucatán, Tehuantepec, and in 1711 in the Nayarit mountain region west of Zacatecas, and Tamaulipas was conquered in 1748; but the wild Indians of Sonora and New Mexico gave constant trouble to the missions and outlying settlers. There were occasionally riots due to scarcity of corn (notably in Mexico itself in 1692). As in other Spanish possessions, Indian labour was replaced or supplemented by that of negro slaves, but these were almost wholly confined to the coast regions of Vera Cruz and Acapulco, and early in the 19th century there were only some 10,000 in all.

As the Spanish conquerors brought few women, there was much mixture of races. Among the pure whites—who were practically all of Spanish extraction—there were two well-defined classes, the *Gacupines* or *chapetones*, Spaniards born in Europe, said to be so named in allusion to their spurs, from Aztec words meaning "prickers with the foot," and the native-born or creoles: the former, though a small minority, had almost all the higher positions both in the public services and in commerce. Besides these there were five well-defined *castas*: mestizos (Indian and white); mulattoes (negro and white); Zambos (negro and Indian), who were regarded as specially vicious and dangerous; native Indians and negroes. But there were about a dozen intermediate "named varieties," of which the *salto-atras* (tending away from white) and *lente en l'aire* (tending towards white) may be mentioned; and many of the last named eventually passed into the Creole class, sometimes by the decree of a court. The fact that the trade route to Manila passed through Vera Cruz, Mexico City and Acapulco entailed the settlement also of a few Chinese and Malays, chiefly on the Pacific coast.

The natives were subject to tribute and kept in perpetual tutelage: divided at the conquest, with the land, as serfs of the conquerors, in *repartimientos* or *encomiendas*, they were gradually freed at an early date from their serfage, and allowed to sell their labour as they pleased; they were, however, to a great extent kept in villages or settlements, compelled to cultivate land which they held for their life only, and strictly controlled by the friars or the priests. Their numbers were several times seriously reduced by the *malashual*, apparently analogous to yellow fever, but not attacking the whites, and unknown before the conquest. The negroes were allowed to buy their freedom gradually at rates fixed by the judicial authorities, and slavery seems never to have taken much hold except in the coast region.

Of the events of this period only a bare outline can here be given. The term of office of the first viceroy, Antonio de Mendoza, was marked by the Mixton War, by an attempt to suppress the *encomienda* system, and by a violent epidemic among the natives. Under his successor, Velasco, the measures taken for the relief of the natives provoked the landowners to a conspiracy (repressed with great severity) to set up Cortes' son as king of New Spain. In 1568 the island of Sacrificios, near Vera Cruz, was seized by John Hawkins (*q.v.*), who was surprised by the Spanish fleet accompanying the new viceroy, de Almansa, and escaped with Sir Francis Drake (*q.v.*), but without the remaining ships of his squadron. In 1572 and 1578, however, Drake took abundant

Races and Castes.

Position of the Natives.

Leading Events: 1535-1822.

vengeance, and in 1587 Cavendish captured the Manila galleon—a success repeated in the next century.

For the next sixty years an urgent question was the prevention of floods in the capital. Situated on the lowest of four lakes, the drainage of whose waters had only one small outlet from the valley, it was only 4 ft. above the level of the lowest, and was flooded on an average once in every twenty-five years. It had been protected under the native kings by a system of dikes, which were added to under the earlier viceroys, but serious inundations in 1553 and 1580 flooded the city, and the latter suggested the relief of the highest lake, that of Zumpango, by a tunnel carrying its chief affluent into a tributary of the Panuco, and so to the Atlantic. This, however, was not then undertaken, and when mooted again in 1603 was opposed as certain to involve a heavy sacrifice of Indian life. Another inundation, in 1604, suggested the transfer of the city to Tacubaya, but the landowners opposing and the city being again inundated in 1607, the Nochistongo tunnel was begun under the auspices of a Jesuit, Enrico Martinez, and roughly completed in eleven months. It passed under a depression in the mountains of the extreme north of the valley. Humboldt states that it was 6600 metres long, $\frac{3}{4}$ wide and 4 high. But it did nothing for the southern lakes, so that a further system of dikes was recommended in preference, in 1614, by the Dutch engineer Adrian Boot; it was inadequate for its work and, not being lined with masonry, it was liable to be choked by falls. Repairs were suspended in 1623, and a further inundation, with great losses of life, occurred from 1629 to 1634. The removal of the city was again mooted and, though sanctioned by the king of Spain, successfully opposed by the landowners. Another flood occurred in 1645. After a disastrous attempt to enlarge the tunnel in 1675, it was eventually converted into an open cutting, but the work was not finished till 1780, and the bottom was then 29 ft. 6 in. above the level of the lowest lake. The drainage was only satisfactorily accomplished at the end of the 19th century (see below).

A negro revolt in the Vera Cruz region (1600) and an Indian rebellion in Sinaloa and Durango may be mentioned among the events of the earlier part of the 17th century. The regular and secular clergy had early come into conflict, particularly over the tithes and the control of the Indians; and in 1621, the marquis de Gelves, an energetic reformer, who as viceroy favoured the appointment of the regulars to deal with the natives, came into conflict with Archbishop Serna of Mexico, who placed the city under interdict, excommunicated the viceroy and constrained him to hide from the mob. Some years later the bishop of Puebla, Juan de Palafox y Mendoza, transferred many native congregations from the friars to secular priests, and subsequently, in 1647, came into conflict with the Jesuits, whom he excommunicated, but who eventually triumphed with the aid of the Dominicans and the archbishop. The power of the church may be judged from the petition of the Ayuntamiento of Mexico to Philip IV. (1644) to stop the foundation of religious houses, which held half the property in the country, to suspend ordinations because there were 6000 unemployed priests, and to suppress feast days because there were at least two per week.

To check the Dutch and British corsairs the Barlovento ("windward") squadron had been set up in 1635; but the British capture of Jamaica (1655) aggravated the danger to the Spanish convoys. During the rest of the century the ports of Yucatán and Central America were frequently raided, and in 1682 Tampico suffered a like disaster; in May 1683 Vera Cruz itself was captured through stratagem by two buccaneers, Van Horn and Laurent, who plundered the town for ten days, committed shocking outrages, and escaped as the Spanish fleet arrived. In 1685-86 the Pacific coast was ravaged by Dampier and Swan, and in 1709 Woodes Rogers, with Dampier as pilot, captured the Manila treasure galleon, a feat repeated by Anson in 1743. But the European wars of the 18th century had little effect on Mexico, save that the privileges of trade given to Great Britain

by the treaty of Utrecht facilitated smuggling. In the first half of the 18th century we may note the appearance, intermittently at first, of the first Mexican periodical—the *Gaceta de Mexico*—in 1722, a severe epidemic of yellow fever in 1736, and the establishment about 1750 of a standing army with a nucleus of Walloons and Swiss, negroes and Indians being excluded and the half-breeds admitted under restrictions. But the great event of the 18th century was the expulsion of the Jesuits from Mexico, as from the other Spanish dominions, in 1767, under orders from Charles III. They were arrested *en masse* on the night of the 26th of June; their goods were sequestered, and they themselves deported to Havana, then to Cadiz, Genoa, and eventually Corsica. They had done much to civilize the natives and to educate the whites, and their expulsion, which was greatly resented by the Creoles, probably tended to increase the popular discontent and prepare for the overthrow of Spanish rule.

In 1769 Don José de Galvez was sent out as special commissioner to devise reforms, with powers independent of the then viceroy, but without much immediate result. It was, however, a consequence of his work that in 1786 the provinces and kingdoms were replaced by twelve intendencias (Guadalajara, Zacatecas, Durango, Sonora, Puebla, Vera Cruz, Merida, Oaxaca, Valladolid, Guanajuato, San Luis Potosí, Mexico), whose governors and minor officials were directly dependent on the viceroy, the former alcaldes, mayores and corregidores, who were very corrupt, being abolished. Possibly it is from this reform that we may date the antithesis of Federalists and Centralists, which is so conspicuous in the history of republican Mexico. Among the later viceroys the Conde de Revillagigedo (1789-1794) deserves mention as a progressive ruler who developed commerce and improved administration, and took the first, but very imperfect, census, on which Humboldt based his estimate of the population in 1803 at 5,840,000.

The European wars of the French revolutionary period interfered with the traffic with Spain, and so relaxed the bonds of a commercial system which hampered the manufactures of Mexico and drained away its wealth. Already in 1783 the Conde de Aranda had suggested to the Spanish king the scheme of setting up three Spanish-American kingdoms bound to Spain by perpetual treaties of alliance and reciprocity and by frequent royal intermarriages, and with the king of Spain as overlord. The plan was devised as a means of rivaling Anglo-Saxon supremacy, but was rejected through fear of the mixed races predominating over the whites. A similar fear helped to keep down the tendencies inspired by French revolutionary literature, though plots occurred against the viceroy Branciforte in 1798 and 1799. But the real causes of the revolution were local. The chief was the Creole jealousy of the Spanish immigrants. There was oppressive taxation, restriction on commerce and manufacture in the interest of Spain, even vineyards having been prohibited; and the courts were very corrupt. But to these grievances was added in 1804 the sequestration, to provide for Spain's needs, of the benevolent funds (*obras pias*) in Mexico, amounting to about \$45,000,000, and nearly all invested on mortgage. The mortgages were called in: forced sales were necessary, the mortgagors were frequently ruined, and less than a fourth of the total was realized. Other confiscations and exactions followed; and when the rule of Fernando VII. was succeeded by that of Joseph Bonaparte, the municipality of Mexico invited Iturrigaray, the viceroy, to declare the country independent. He proposed the convocation of a national congress, but was overthrown by a conspiracy of Spaniards under one Yermo, who feared that they would lose their privileged position through severance from Spain. The two next viceroys were incompetent; further demands from the Spanish authorities in revolt against Joseph Bonaparte increased the disaffection, which was not allayed by the grant of representation in the Spanish Cortes to the colonies; and, on the demands being repeated by a third viceroy, Venegas, Creole conspiracies arose in Querétaro and Guanajuato. Their discovery in 1810 was followed by the outbreak of the revolution. Hidalgo, a parish priest, and Allende, a captain of cavalry, with forces

Churr and State.

Buccaneer Raids.

Centralized Government.

Beginnings of Severance.

consisting largely of Indians, captured a stronghold at Guanajuato and even threatened the capital; but the revolutionists were defeated in 1811 at Calderon, and the leaders executed. Another priest, however, named Morelos, continued the movement, and, despite defeat in the terrible siege of Cuatla (now Morelos) on the 2nd of May 1812, raised the south, so that in the next year his forces overran most of the kingdom of Mexico and held its southern parts, and he was able to convok a congress and issue a constitution. But he also was captured, and executed at Mexico City in 1815. Though revolutionary movements still continued, by 1817 only one leader, Vincente Guerrero, was left in the field. But in March 1820 the Spanish constitution, repudiated by King Fernando VII. soon after his restoration, was restored after a military rising in Spain. It was promulgated in Mexico, and the ecclesiastics and Spaniards, fearing that a Liberal Spanish government would force on them disenfranchisement, toleration and other changes, induced Augustin de Iturbide, who had already been conspicuous in suppressing the risings, to take the field in order to effect what may be called a reactionary revolution.

III.—Independent Mexico.

Thenceforward, till the second election of Porfirio Diaz to the presidency in 1884, the history of Mexico is one of almost continuous warfare, in which Maximilian's empire is a mere episode. The conflicts, which may at first sight seem to be merely between rival generals, are seen upon closer examination to be mainly (1) between the privileged classes, *i.e.* the church and (at times) the army, and the mass of the other civilized population; (2) between Centralists and Federalists, the former being identical with the army, the church and the supporters of despotism, while the latter represent the desire for republicanism and local self-government. Similar conflicts are exhibited, though less continuously, by most of the other Spanish-American states. On both sides in Mexico there was an element consisting of honest doctrinaires; but rival military leaders exploited the struggles in their own interest, sometimes taking each side successively; and the instability was intensified by the extreme poverty of the peasantry, which made the soldiery reluctant to return to civil life, by the absence of a regular middle class, and by the concentration of wealth in a few hands, so that a revolutionary chief was generally sure both of money and of men. But after 1884 under the rule of Diaz, the Federal system continued in name, but it concealed in fact, with great benefit to the nation, a highly centralized administration, very intelligent, and on the whole both popular and successful—a modern form of rational despotism.

Iturbide eventually combined with Guerrero, and proclaimed the "Plan of Iguala," which laid down, as the bases of the new state, the maintenance of the Roman Catholic religion and the privileges of the clergy, the establishment of a limited monarchy, and equality of rights for Spaniards and native-born Mexicans. Iturbide sought the co-operation of the viceroy Apodaca, who, however, refused; but he was presently superseded by General O'Donoghé, who, being unable to get beyond Vera Cruz, recognized the independence of Mexico. O'Donoghé shortly afterwards died; the Spanish government repudiated his act; and Spanish troops held the fortress of San Juan de Ulúa, off Vera Cruz, till 1827. A provisional Junta, nominated by Iturbide, issued a declaration of independence (Oct. 1821), and nominated a regency of five, with Iturbide as its president. The first Mexican Congress met on the 24th of February 1822. A section of it favoured a republic; another, monarchy under Iturbide; another, which was broken up by the refusal of Spain (continued until 1836) to recognize Mexican independence, monarchy under a Bourbon prince. A conflict now arose between the republican majority and Iturbide, which was settled by a military pronouncement in his favour, and the Congress elected him emperor. He was crowned on the 21st of July 1822. Fresh conflicts broke out between him and the Congress, and Antonio Lopez de Santa Anna, captain-general of Vera Cruz, proclaimed a republic,

promising to support the Plan of Iguala. He was defeated at Jalapa and driven to Vera Cruz; but the army deserted Iturbide, who was compelled to abdicate (April 19, 1823). The Congress deported him to Italy, and granted him a pension. He returned almost immediately, on the pretext that Spain was intriguing against Mexican independence, and on landing (having been previously outlawed) was arrested and executed (July 1, 1824).

The Congress had meanwhile undone much of his work, and had divided into Federalists and Centralists, the latter largely Monarchists and Freemasons. The Federalists were strong enough to secure the adoption of a constitution (Oct. 4, 1824) modelled on that of the United States, with additional clauses, notably one declaring the Roman Catholic religion to be alone recognized. A source of abundant discord was opened by the provision that each state should contribute its quota to the Federal revenues. No proper statistical basis for estimating the quotas existed, and the device gave each state a plausible reason for attempting secession on occasion. Moreover, the capital and some territory round it was made into a "Federal district"—another grievance intensifying the antagonism of the state to the central power. The Freemasons had been largely instrumental in overthrowing Iturbide; they now divided into the Escoceses (lodges of the Scottish ritual), who were Monarchist and Centralist, and the Yorkinos, who took their ritual from New York, and their cue, it was alleged, from the American minister, Joel Poinsett. An attempt at revolt, headed by Nicolas Bravo, vice-president, the Grand Master of the Escoceses, was suppressed, but dissensions ensued in the Yorkino party between the followers of President Guerrero (a man largely of native blood, and the last of the revolutionary leaders) and of Gomez Pedraza, the war minister. A conflict broke out, the Guerrerists were victorious, and the pillage of foreign shops in Mexico City (1828), among them that of a French baker, gave a basis for the foreign claims which, ten years later, caused the "Pastry War" with France. Meanwhile, attacks on Spanish ships off Cuba by a Mexican squadron, commanded by an American, David Porter, had induced Spain to send an expedition to reconquer Mexico (1829) which was checked at Tampico by Santa Anna. During the invasion Vice-President Antonio Bustamante declared against President Guerrero; the bulk of the army supported him. Guerrero was deposed, and his partisans in the south were defeated at Chilpancingo (Jan. 2, 1831); and Guerrero, retiring to Acapulco, was enticed on board an Italian merchant-ship, and treacherously seized, tried and executed (Jan.-Feb. 1831). Next year, however, a revolt broke out against Bustamante, which was joined by Santa Anna, and eventually resulted in a pronunciamiento in favour of Gomez Pedraza. He, and his successor, Vice-President Gomez Farias (1833), assailed the exemption of the clergy and of military officers from the jurisdiction of the civil courts, and the latter attempted to laicize higher education and to relax monastic bonds. Santa Anna took advantage of the situation to assume the presidency. He eventually became **Santa Anna, Dictator, 1834.** state legislatures, and substituted creatures of his own for the governors of the states and mayors of towns, then retiring into private life. A new Congress, having resolved itself into a constituent assembly, followed up this Centralist policy (Dec. 30, 1836) by framing a new constitution, the Siete Leyes or Seven Laws, which converted the states into departments, ruled by governors appointed by the central authority, and considerably reduced popular representation. Antonio Bustamante became the first president under it. **Bustamante, President, 1837.** The French claims set up by the pillage of foreign shops in Mexico had, however, remained unsatisfied, and in 1838 a French fleet blockaded the coast, bombarded the fortress of San Juan de Ulúa, off Vera Cruz, and occupied the town. The Mexican government gave way, threatened by Federalist risings and secessions of states, which culminated in 1841. Santa Anna appeared, nominally as a

General
Iturbide
becomes
Emperor,
1822-1823.

President
Guerrero,
1825-1831.

Santa Anna,
Dictator,
1834.

Bustamante,
President,
1837.

mediator, and put forward the bases of Tacubaya (Sept. 28, 1841), abolishing all the Siete Leyes except the part relating to the judicial system, arranging for a new *Santa Anna Restored, 1841.* constituent assembly, and reserving for the president (himself) full power of re-organizing the administration. The Centralist government, after a vain attempt to defeat him by professing a more thorough Federalism, gave way to force, and Bustamante was allowed to leave the country. But the new Congress was too Federalist for Santa Anna, and he retired, leaving the reins to Nicolas Bravo, under whom a new Centralist constitution was established (1843). This expressly retained the privileges of the clergy and army, and was in some respects more anti-Liberal than that of 1836.

But new complications were now introduced by the question of Texas. Though a state of the Mexican Union, it had been settled from the United States in consequence of a land grant given by the Spanish viceroy to Stephen Austin in 1820, and had been estranged from Mexico partly by the abolition of slavery under a decree of President Guerrero, and partly by the prospect of the Centralist constitution of 1836. It then seceded. Santa Anna attempted to reduce it, showing great severity, but was eventually defeated and captured by Houston at the battle of San Jacinto, and compelled to sign a treaty recognizing Texan independence, which was disavowed on his return to Mexico. A state of war thus continued nominally between Mexico and its seceded member, whose independence was recognized by England, France and the United States. The slaveholders in the United States favoured annexation of Texas, and pressed the claims due from Mexico to American citizens, partly perhaps with the aim of forcing war. Most of these claims were settled by a mixed commission, with the king of Prussia as umpire, in 1840-1841, and a forced loan was raised to pay them in 1843, which stimulated the revolt of Paredes against Santa Anna, who had returned to power in 1844. It resulted in Santa Anna's downfall, imprisonment at Perote and eventual exile (Dec. 1844 to Jan. 1845), and the election of General José Joaquín Herrera as president. But Herrera was displaced in the last days of 1845 by a pronunciamiento in favour of Paredes, who undertook to uphold the national rights against the United States, and who was elected president on the 3rd of January 1846. Texas had meanwhile applied for admission into the American Union. The annexation, rejected in 1844 by the United States Senate, was sanctioned on the 1st of March 1845, and carried out on the 22nd of December 1845. The Mexican minister withdrew from Washington, and both sides made active preparations for war.

The United States forces were ordered by President Polk to advance to the Rio Grande in January 1846. They established a depot at Point Ysabel (behind the opening of Brazos Santiago), and erected a fort in Texan territory, commanding Matamoros, on the Mexican side of the Rio Grande. This provoked the Mexican forces into a defensive invasion of Texas, to cut the American communications with Point Ysabel. They were, however, defeated at Palo Alto (May 8) and Resaca de la Palma (May 9). There was an outburst of warlike feeling in the United States (with a counter-movement in the North), and an invasion of Mexico was planned by three routes—from Matamoros towards Monterey in New Leon, from San Antonio de Bexar to Chihuahua, and from Fort Leavenworth to New Mexico. Importance attaches chiefly to the movements of the first force under General Zachary Taylor. During the war preparations President Paredes, suspected of intriguing to overthrow the Republic and set up a Spanish prince, had to give place to his vice-president Bravo, who in his turn gave way before Santa Anna, who was hastily recalled from his exile at Havana to assume the presidency and the conduct of the war (Aug. 1846). He was allowed by the American squadron blockading Vera Cruz to pass in without hindrance. Probably it was thought his presence would divide the Mexicans.

The preparations of the United States took some months. It was not till the 5th of September 1846 that General Zachary Taylor could leave his depot at Camargo on the Rio Grande,

and march on Monterey. It was taken by assault on the 23rd of September; Santa Anna was defeated at Buena Vista (near Saltillo) on the 23rd of February 1847, and forced back on San Luis Potosí. New Mexico was occupied without opposition; Chihuahua was occupied, but not held, owing to the difficulties in maintaining communications; and Upper California was seized in the autumn of 1846 by John C. Fremont, who had been exploring a route across the continent, and by the United States Pacific squadron, and made secure by the aid of the New Mexico expedition. But as Mexico still continued to fight, it was determined to reach the capital via Vera Cruz. That city was taken by General Scott after a siege and bombardment (March 7 to 29, 1847); and after winning the battle of Cerro Gordo (April 18), and a long delay at Puebla, Scott marched on Mexico City, stormed its defences against greatly superior forces, and effected an entrance after severe fighting on the 13th of September 1847. This virtually ended the war; Santa Anna was deprived of his command, and the treaty of Guadalupe Hidalgo, concluded on the 2nd of February 1848, ceded to the United States Texas, New Mexico and Upper California, in return for a payment of *Treaty of Peace.* \$15,000,000 by the United States to Mexico, and the assumption of liability by it for the claims of its subjects which it had hitherto been pressing against Mexico. This payment was doubtless intended to strengthen the United States' title to the conquered territory. It is generally admitted that Mexico was provoked into aggression in order that additional territory might be available for the extension of slavery.

The American forces were withdrawn in May and June 1848 after the ratification of the treaty by Mexico. Under the presidency of Herrera (1848-1851) attempts were made to restore order and the public credit. An arrangement was effected with English holders of Mexican stock; *Herrera, President, 1848-1851.* an attempt was made to carry out a consolidation of the internal debt, which failed; the army was reduced and reorganized, and the northern frontier was defended by military colonies, formed partly of civilized Seminole Indians from the United States. But the financial situation was desperate; the federal revenue, mostly from customs—which were evaded by extensive smuggling—was not half the expenditure; and Indian revolts in Yucatan (1847-1850) and in the Sierra Gorda had added to the strain. Arista succeeded Herrera as president (Jan. 1851), but resigned (Jan. 1853).

After a sort of interregnum (Jan.-March 1853) Santa Anna was recalled (by a vote of the majority of the states under the Plan of Arroyozarco, on the 4th of February 1853, the result *Santa Anna in Power, 1853-1854.* of a pronunciamiento), and made dictator in the interests of federation. His measures, partly inspired by an able Conservative leader, Lucas Alaman, proved strongly Centralist: one is especially noteworthy, the establishment of the ministry of "fomento," or encouragement to public works, education, and intellectual and economic development, which is a conspicuous aid to Mexican welfare to-day. He also negotiated (at the end of 1853) the sale of the Mesilla valley (now Arizona) to the United States, but the purchase money was soon dissipated. On the 16th of December 1853 Santa Anna issued a decree making himself dictator, with the title of serene highness. On the 1st of March 1854, at Ayutla in Guerrero, a section of the army under Colonel Villareal proclaimed the Plan of Ayutla, demanding Santa Anna's deposition and the establishment of a provisional government to secure a new constitution. Among the leaders in the movement were Generals Alvarez and Comonfort, and it is said that Porfirio Diaz, subsequently president, then a young soldier, made his way to Benito Juarez, then in prison, and arranged with him the preliminaries of the revolt. It spread, and Santa Anna left the country (Aug. 1854).¹

Two filibustering expeditions at this time—one by William Walker, afterwards notorious in Nicaragua, in Lower California

¹ Santa Anna tried to get back to politics in Mexico after Maximilian's fall, without success. He was amnestied with other exiles in 1874, and died in obscurity in 1876.

(Dec. 1853), the other by Count Raoussset de Boulbon in Sonora (July 1854)—added to the general disorder.

The provisional president, General Carrera, proving too Centralist, was replaced by Alvarez (Sept. 24, 1855), two of whose ministers are conspicuous in later history—Ignacio Comonfort,

minister of war, and Benito Juarez, minister of finance. Juarez (b. 1806) was of unmixed Indian blood. The son of a Zapotec peasant in a mountain village of Oaxaca, he was employed as a lad by a bookbinder in Oaxaca city, and aided by him to study for the priesthood. He soon turned to the law, though for a time he was teacher of physics in a small local college; eventually went into politics, and did excellent work in 1847 as governor of his native state. Juarez almost immediately secured the enactment of a law (Ley Juarez, Nov. 23, 1855) subjecting the clergy and the army to the jurisdiction of the ordinary courts. "Benefit of clergy" was the curse of Mexico. Officers and soldiers could be tried only by courts-martial, the clergy (including numbers of persons in minor orders, who were practically laymen) only by ecclesiastical courts. The proposed reform roused the Clericals to resistance. Alvarez gave place (Dec. 8, 1855) to his war minister Comonfort, who represented the less anti-Clerical Liberals. He appointed a commission to consider the question of draining the valley of Mexico, which adopted the plan ultimately carried out in 1890-1900; suppressed a Clerical rising in Puebla (March 1856), which was punished by a considerable confiscation of church property; sanctioned a law releasing church land from mortmain, by providing for its sale, for the benefit, however, of the ecclesiastical owners (called after its author Miguel Lerdo de Tejada, brother of the subsequent president), and a new draft constitution, largely modelled on that of the United States (Feb. 5, 1857). The clergy protested violently, and the Plan of Tacubaya (Dec. 17, 1857), which made Comonfort dictator, provided for the construction of a new constitution under his auspices. He was presently displaced by a thorough reactionary, General Zuloaga, and expelled from Mexico early in 1858; and for three years Mexico was a prey to civil war between two rival governments—the Republicans at Vera Cruz under Juarez, who, as Chief Justice of the Supreme Court, succeeded Comonfort; and the reactionaries at the capital. The latter were at first presided over by Zuloaga, who, proving incompetent, was replaced at the end of 1858 by Pezuela, who early in 1859 gave place to Miguel Miramon, a young, able and unscrupulous soldier who was shortly afterwards accepted as "constitutional" president by his party. The Juarists were defeated outside the city of Mexico twice, in October 1858 and on the 11th of April 1859.

Miramón. On the second occasion the whole body of officers, who had surrendered, were shot with Miramon's authority, if not by his express orders, together with several surgeons (including one Englishman, Dr Duval) (the fifty-three "martyrs of Tacubaya"). This atrocity caused great indignation in Mexico and abroad: the reactionists were divided; their financial straits were extreme, as the Juarists held all the chief ports. Juarez was recognized by the United States, and allowed to draw supplies of arms and volunteers thence; and in July 1859 he published laws suppressing the religious orders, nationalizing ecclesiastical property (of the estimated value of \$45,000,000), establishing civil marriage and registration, transferring the cemeteries to civil control, and, in short, disestablishing the church. But the apparent hopelessness of any ending to the conflict, together with the frequent outrages of both parties on foreigners, afforded strong reasons for foreign intervention. Early in 1859 President Buchanan had recommended the step to Congress, which did not respond. On the 12th of December 1859 the M'Lean-Juarez treaty was concluded, which gave the United States a sort of disguised protectorate over Mexico, with certain rights of way for railroads over the Isthmus of Tehuantepec and between the Rio Grande and Pacific. The American Senate, however, did not ratify the treaty, and a motion for its reconsideration late in 1860 came to nothing, owing to the approach of the War of Secession.

When Napoleon III. was in captivity at Ham he dreamed of

a Central America civilized and opened up to modern enterprise by a transoceanic canal: and the clerical refugees in Paris, among them Labastida, archbishop of Mexico, easily influenced the Empress Eugénie, herself a Spaniard, to interest her husband in the cause of centralized monarchy and the church: it is said that even in 1859 they had thoughts of setting up the Archduke Maximilian as ruler of Mexico.

The question of a joint intervention of Great Britain, France, Spain and Prussia was mooted between those powers in 1860. Early in 1859 the outrages on British subjects had caused the British minister to break off diplomatic relations. Forced contributions had been levied by both sides on goods or bullion, being European property, the reactionaries being the worst offenders; and there were numerous cases of murder and robbery of Europeans. At last, on the 17th of November 1860, Miramon, under the plea of necessity, seized \$630,000 in specie which had been left under seal at the British Legation and was intended for the bondholders. On the 22nd of December 1860 his forces were routed by the Juarist general Ortega at Arroyozarco, and his government was overthrown.

Juarez entered Mexico City on the 11th of January 1861. He soon found that his government was held responsible to Europe for the excesses of its rival as well as its own. Miramon's government had violated the British Legation; the Spanish minister, the papal legate and the representatives of Guatemala and Ecuador were expelled from the country for undue interference on behalf of the reactionaries; the payments of the British loan were suspended by Juarez's Congress in July 1861; and various outrages had been committed on the persons and property of Europeans for which no redress could be obtained. The French *chargé d'affaires*, Dubois de Saligny, who had been sent out in November 1860, urged French intervention, and took up the Jecker claims. Jecker, a Swiss banker settled in Mexico, had lent Miramon's government in 1859 \$750,000 (subject, however, to various deductions): in return, Miramon gave him 6% bonds of the nominal value of \$1,500,000 which were ingeniously disguised as a conversion scheme. Jecker had failed early in 1860, Miramon was overthrown a few months later. Jecker's creditors were mostly French, but he still held most of the bonds, and there is reason to believe that he won over Dubois de Saligny by corrupt means to support his claims. Intercepted correspondence (since confirmed from the archives of the Tuileries) showed that the Duc de Morny promised Jecker his patronage in return for 30% of the profits (De la Gorce, *Hist. du Second Empire*, IV. c. 1). An imperial decree naturalized Jecker in France, and Napoleon III. took up his claim. A convention between Great Britain, France and Spain for joint interference in Mexico was signed in London on the 31st of October 1861. A separate arrangement of the British claims was negotiated by Juarez, but rejected by the Mexican Congress, November 1861; and the assistance of the United States with a small loan was declined, Mexican territory being demanded as security. On the 14th of December Vera Cruz was occupied by Spanish troops under General Prim; the French fleet and troops arrived soon after, with instructions to seize and hold the Gulf ports and collect the customs for the three Powers till a settlement was effected; Great Britain sent ships, and landed only 700 marines. In view of the unhealthiness of Vera Cruz, the convention of Soledad was concluded with the Mexican government, permitting the foreign troops to advance to Orizaba and incidentally recognizing Mexican independence. But as the French harboured leaders of the Mexican reactionaries, pressed the Jecker claims and showed a disposition to interfere in Mexican domestic politics, which lay beyond the terms of the joint convention, Great Britain and Spain withdrew their forces in March 1862.

More troops were sent from France. Their advance was checked by Zaragoza and Porfirio Diaz in the battle of Cinco de Mayo, on the 5th of May 1862; and in September of that year 30,000 more French troops arrived under General Forey. Wintering at Orizaba, they recommenced their advance

(Feb. 17, 1863), besieged and reduced Puebla, and entered Mexico City on the 7th of June. A provisional government of Mexicans,

French Expedition, Saligny, adopted monarchy, offered the crown to Maximilian of Austria, brother of the Emperor Francis Joseph, and should he refuse, left its disposal to Napoleon III.

Maximilian, after some difficulty as to renouncing his right of succession to the throne of Austria, accepted the crown subject to the approval of the Mexican people, and **Maximilian Emperor**, reached Mexico city on the 12th of June 1864. Juarez meanwhile had set up his capital, first in San Luis Potosí, then in Chihuahua. The new empire was unstable from the first. Before Maximilian arrived the provisional government had refused to cancel the sales of confiscated Church lands, as the clericals demanded. When he came, a host of new difficulties arose. A new loan, nominally of about eight millions sterling, but yielding little more than four, owing to discount and commission, was raised in Europe, but no funds were really available for its service. Maximilian carried the elaborate etiquette of the court of Vienna to Mexico, but favouring toleration of Protestantism, and the supremacy of the Crown over the Church, he was too liberal for the clericals who had set him up. As a foreigner he was unpopular, and the regiments of Austrians and Belgians which were to serve as the nucleus of his own army were more so. His reforms, excellent on paper, could not be carried out, for the trained bureaucracy necessary did not exist. For a time he nominally held sway over about two-thirds of the country—roughly, from lat. 18° to 23°, thus excluding the extreme north and south. Oaxaca city, under Porfirio Diaz,¹ capitulated to Bazaine—who had superseded the too pro-clerical Forey in October 1864—in February 1865, and by the autumn of that year the condition of the Juarists in the north seemed desperate. But the towns asked for permanent French garrisons, which were refused, as weakening their own power of self-defense. Instead, the country was traversed by flying columns, and the guerillas dealt with by a French service of "contre-guerilla," who fought with much the same savagery as their foes. Directly the French troops had passed, Republican bands sprang up, and the non-combatant Mexicans, to save themselves, could only profess neutrality. Yet on the 3rd of October 1865, Maximilian, misled by a false report that Juarez had left the country, issued a decree declaring the Juarist guerillas, who, whenever captured, were to be tried by court-martial and shot. Mexican generals on both sides had done as much. But Maximilian's decree prepared his own fate.

The American Civil War ended in the spring of 1865, and a strong popular feeling was at once manifested in favour of asserting the Monroe doctrine against Maximilian's government. In the summer there were threatening movements of United States troops towards the Rio Grande; early in 1866

Maximilian Napoleon III. announced his intention of withdrawing **France**, his forces; in response to a note of Seward, the

United States secretary of state, of the 12th of February 1866, he was induced to promise their return by three instalments—in November 1866, March and November 1867. Maximilian now turned for support to the Mexican clericals; meditated abdication, but was dissuaded by his wife Charlotte, the daughter of Leopold I. of Belgium (and "the better man of the two," as he had once jestingly said), who went to intercede for him with the emperor of the French. Finding him obdurate, she went on to appeal to the pope; while at Rome she went mad (end of September 1866).

Maximilian had meanwhile drawn nearer to the clericals and farther from the French, and, to protect French interests, Napoleon III. had decided to send out General Castelnau to supersede Bazaine, arrange for the withdrawal of the French forces in one body, and restore the Republic under Ortega, who had quarrelled with Juarez, and was therefore, of all republicans, least unacceptable to the clericals. But fearing the prospect, they induced Maximilian, who had retired to Orizaba for his

¹ Diaz refused parole, and was confined at Puebla for some months, but made his escape, and was soon in the field again.

health, to remain. He yielded on condition that a congress of all parties should be summoned to decide the fate of the empire. Hereupon he returned to the capital; the Juarist dominion extended rapidly; the French troops left (in one body) on the 5th of February 1867, and shortly after Maximilian took command of the army at Querétaro. Here, with Miramon, he was besieged by the Juarists under Escobedo, and the garrison, when about to make a last attempt to break out, was betrayed² by Colonel Lopez to the besiegers (May 15, 1867).

Execution of Maximilian, with the Mexican generals Miramon and Mejia, was tried by court-martial, and, refusing (or neglecting) to avail himself of various opportunities of escape, was convicted on charges which may be summarized as rebellion, murder and brigandage, on the 14th of June, and shot, with Miramon and Mejia, on the 19th of June 1867, despite many protests from European governments and prominent individuals, including Garibaldi and Victor Hugo. (An effort to save him made by the U.S. Government was frustrated by the dilatoriness of the U.S. Minister accredited to Juarez's Government.) After considerable difficulty with the Republican Government, his body was brought to Europe.

Meanwhile Porfirio Diaz had captured Puebla (April 2) and besieged Mexico City, which fell on the 21st of June. The last anti-Juarist stronghold (Inayarít) submitted on the 20th of July 1867. A good deal of discontent existed among the republican rank and file, and Juarez's election in October to the presidency was opposed by Diaz's friends, but without success. But so soon as Juarez was elected, insurrections broke out, and brigandage prevailed throughout the following year. There were unsuccessful insurrections also in 1866 (clerical) and 1870 (republican), but an amnesty, passed on the 13th of October 1870, helped to restore peace; trouble again arose, however, at the 1871 election, at which the candidates were Juarez, Sebastian Lerdo de Tejada and Diaz. Juarez's continued re-election was regarded as unconstitutional, and no party obtaining a clear majority, the matter was thrown into Congress, which elected him. Diaz's supporters refused to recognize him, and a revolution broke out, which went on sporadically till Juarez's death on the 18th of July 1872. Sebastian Lerdo de Tejada, as president of the Supreme Court, succeeded him, and amnestied the rebels, but made no further concessions. In the next year, however, laws were passed repeating in a stronger form the attacks of 1857 on the supremacy of the Church, and prohibiting monastic life. The first day of 1873 was marked by the opening of the Vera Cruz & Mexico railway. Protestant missions established themselves (with some opposition) in the country, and diplomatic relations were renewed with France and Spain (1874). But towards the close of Lerdo de Tejada's term he was suspected of aiming at a dictatorship, and Diaz, whom he had proscribed, made preparations for a rising, then retiring to Texas. At the beginning of 1876 the revolution broke out in Oaxaca with the plan of Tuxtepec, which was adopted by Diaz, and proclaimed as the plan of Palo Blanco (March 21). Diaz's attempt to raise the north, however, failed, and, trying to reach Vera Cruz by sea, he was recognized on the steamer, and recaptured while attempting a four-mile swim ashore. The purser, however, made it appear that he had again jumped overboard, concealed him for some days—generally inside one of the saloon sofas—and helped him to get ashore in disguise at Vera Cruz. He then escaped to Oaxaca and raised a force. Lerdo was declared re-elected, but was overthrown by Diaz after the battle of Teacoac (Nov. 16, 1876) and forced into exile (Jan. 1877), and Diaz was declared president on the 2nd of May 1877. A law forbidding the re-election of a president till four years had elapsed from his retirement from office was passed in the autumn of that year.

Death of Juarez, 1872.

Administration of Lerdo de Tejada.

Porfirio Diaz, President, 1877.

Porfirio Diaz, President, 1877.

Porfirio Diaz, President, 1877.

Porfirio Diaz, President, 1877.

Porfirio Diaz, President, 1877.

Porfirio Diaz, President, 1877.

Porfirio Diaz, President, 1877.

Porfirio Diaz, President, 1877.

Porfirio Diaz, President, 1877.

² Lopez said he acted as Maximilian's agent, but his story rested on an alleged letter from Maximilian which was discredited as a forgery. The evidence of his treason was published in *El Nacional* of Mexico, Sept. 11, 1887.

Diaz's first presidency (1870-1880) was marked by some unsuccessful attempts at revolution notably by Escobedo from Texas in 1878, and by a more serious conspiracy in 1879. Diplomatic relations were resumed with Spain, Germany, Italy and some South American states (1877), and France (1880). There were some frontier difficulties with the United States, and with Guatemala, which revived a claim dropped since 1858 to a portion of the state of Chiapas; and there was considerable internal progress, aided by a too liberal policy of subsidies to railways and even to lines of steamships. The boundary questions were settled under President Gonzalez (1880-1884); relations with Great Britain were renewed in 1884. The claims of the railways, however, necessitated retrenchment on official salaries, and the president's plan for conversion of the debt aroused unexpected and successful opposition in an ordinarily subservient Congress. At the end of 1884 Porfirio Diaz was again elected president, and was continually re-elected, the constitution being modified expressly to allow him to continue in office.

The history of Mexico from 1884 to 1910 was almost void of political strife. President Diaz's policy was to keep down disorder with a strong hand; to enforce the law; to foster railway development and economic progress; to develop native manufactures by protective tariffs; to introduce new industries, e.g. the production of silk and wine, of coca and quinine; to promote forestry; to improve elementary and higher education—for all which purposes the Ministerio del Fomento is a potent engine; to encourage colonization; and, above all, to place the national credit on a sound basis. The first step in this process was a settlement of the

Financial British debt by direct arrangement with the bond-reorganiza-
tion. holders. In 1890 the Spanish bondholders' claims were satisfactorily arranged also. In 1891 the tariff was made more protectionist. In 1893 the depreciation of silver necessitated stringent retrenchment; but the budget

balanced for the first time during many years, the floating debt was converted, and a loan raised for the completion of the Tehuantepec Railway. After 1896 substantial annual surpluses were spent in reducing taxation and in the extinction of debt. In 1895 the 6% external debt was converted into a 5% debt, the bonds of which remained at a premium for 1902; in 1896 the alcabalas or interstate customs and municipal *octrois* were abolished, and replaced in part by direct taxation and increased stamp duties.

The institution by Diaz of the *guardias rurales*, a mounted gendarmerie composed of the class who in former days drifted **Pacification** into revolution and brigandage, was a potent means of maintaining order, and the extension of railways **the Country.** and telegraphs enabled the government to cope at once with any disturbance. The old local revolutions practically disappeared. In 1886-1887 there were some disturbances in Coahuila, New Leon, Sinaloa and Tamaulipas; subsequently hardly anything was heard of such disorders except on the Texan frontier, where in 1890 Francisco Ruiz Sandoval and in 1891 Catarino Garza made incursions into Mexico. Occasionally the Church gave trouble—the presence of foreign priests was complained of; attempts to evade the law prohibiting conventual life were detected and foiled (1891, 1894); and there were Indian risings, repressed sometimes with great severity, among the Mayas of Yucatán, whose last stronghold was taken in 1891, and the Yaquis of Sonora (1899-1900). Under federal and democratic forms, Diaz exercised a strictly centralized and personal rule. He was invited to approve the candidates proposed for state governorships; in all law cases affecting the Government or political matters the judges asked his opinion; he drafted bills, and discussed their text with individual members and committees of congress. Similarly, the state legislatures, as well as the judges and municipal officers, were actually or virtually selected by the state governors, who were practically agents of the president. Now and then the old passions broke out: in September 1898 an absurd attempt to assassinate President Diaz was made by a countryman named Arroyo, but discontent with Diaz's rule was apparently confined

to a small minority.¹ In 1900 indeed there were some disquieting symptoms. Owing to Diaz's age the vice-presidency had been revived in 1904, and Don Ramon Corral elected to it; but at the elections of 1909 a movement arose in favour of replacing him by General Bernardo Reyes, Governor of Nuevo Leon, but he was disposed of by an official commission to study the military systems of Europe. It was, therefore, regarded as certain that, should President Diaz die in office, Señor Corral would succeed him without serious difficulty.

In foreign affairs the rule of Diaz was uneventful. There were transient disputes with the United States (1886, 1888). In 1888-1890 and 1894-1895 a boundary dispute with Guatemala became serious. But Guatemala **Foreign** gave way at the threat of war (Jan. 1895) and a new **Affairs.** treaty was made (April 1, 1895). Again in 1907 there was some friction owing to the murder of a Guatemalan ex-president by a patriot in Mexico: later in the year, however, the Mexican government was active in stopping a war between its Central American neighbours. In the difficulty between England and the United States over the Venezuelan boundary (Dec. 1895) Mexico expressed strong adherence to the Monroe doctrine in the abstract, and suggested that its maintenance should not be left wholly to the United States, but should be undertaken by all American Powers. The first Pan-American congress met in Mexico City in 1901, and the country was represented at the second, held in Rio Janeiro in 1906. Mexico also took part in establishing the permanent Central American Court of Arbitration, inaugurated on the 25th of May 1908 at Cartago, Costa Rica, under the Washington treaties of December 1907, and showed readiness to associate herself with the Government of her great northern neighbour in preserving peace among the Central American States. On the 17th of October 1909 President Taft and President Diaz exchanged visits at the frontier at El Paso, Texas.

In brief, under President Diaz's rule the history of Mexico is mainly economic. In the six financial years 1893-1894 to 1899-1900 inclusive the yield of the import duties **Economic** increased by upwards of 80%; the revenue from **Progress.** stamps over 60%, though the duties were reduced; the postal revenue from 1895-1896 to 1899-1900 rose 60%; the telegraph revenue over 75%. Again, in 1898-1899 the total ordinary revenue of the state was £6,013,921; in 1906-1907 it had increased to £11,428,612, or by more than 90%, and though 1907-1908 was a year of depression its total revenue (£11,177,186) exceeded that of any year save its immediate predecessor. The great drainage scheme which completed the works of the 17th century by taking out the surplus waters of the southern lakes of the valley of Mexico was devised in 1856, begun under Maximilian, proceeded with intermittently till 1885, then taken up with improved plans, practically completed by 1896, and inaugurated in 1900;² the harbour of Vera Cruz was finished in 1902; the Tehuantepec railway, likely to prove a formidable rival to any interoceanic canal, was opened on the 24th of January 1906. All three were the work of an English firm of contractors, the head of which was Sir Weetman Pearson. American, and later Canadian, capital and enterprise have also been very largely concerned in the development of the country; and its progress was not permanently interfered with by the great earthquakes of April 1907 and July 1909 at Acapulco, and the floods in August 1909 at Monterey. In 1891 elementary education was reorganized, and made compulsory, secular and gratuitous. Great attention has been paid to higher education, and—at least in the hospitals—to modern sanitation and hygiene.

AUTHORITIES.—For English readers the standard work is H. H. Bancroft, *Collected Works* (Histories of the Pacific States, Central America, &c., vols. x-xiv. (Mexico, 1521-1887) with vols. xv., xvi.

¹ Don Augustin Iturbide, grandson of the emperor, godson and (perhaps) at one time the destined heir of Maximilian, was turned out of the army and imprisoned in 1890 for abusing President Diaz.

² For a full account of the works see J. B. Body in *Proceedings of the Institution of Civil Engineers*, cxliii. 286, sqq.

(Texas), and vol. xvii. (New Mexico, &c.). Mention may also be made of Gaston Routhier's *Histoire de Mexique* (1895). Standard Mexican authorities are: C. M. de Bustamante, *Quadro historico de la revolucion mexicana*, 6 vols. (Mexico, 1832-1846); Lucas Alamán, *Historia de Mexico* (Mexico, 1849-1852); N. de Zamacois, *Historia de Mexico desde sus tiempos mas remotos hasta nuestros dias*, 19 vols. (Barcelona, 1876-1882); J. E. Hernández y Davalos, *Coleccion de documentos para la historia de la Independencia* (Mexico, 6 vols.). A huge and informative illustrated work, edited by Justo Sierra (3 vols. large 4to), summarizing products and badly translated, *Historia de Mexico, its Social Evolution* (Barcelona, 1900-1904); a useful and handy chronicle is Nicolas Leon's *Compendio de la historia general de Mexico hasta el año de 1900* (Mexico and Madrid, 1902). For the colonial period, Alexander v. Humboldt, *Essai politique sur le royaume de la Nouvelle Espagne* (Paris, 1811, 2 vols., and atlas; also an English translation). For the war with the United States see R. S. Ripley, *The War with Mexico* (New York, 1849); E. D. Mansfield, *The Mexican War* (New York, 1849); and Winfield Scott's *Memoirs*. For Maximilian, the Blue-books on Mexican affairs contained in *Accounts and Papers* (presented to parliament), vol. lxxv, 1862, and vol. lxxv, 1863, are valuable; E. de Kératry, *La Créance Jekyll: l'empereur Maximilien, son élévation et sa chute* (translated into English by Venables); *La Contre-guerilla française au Mexique*, are specially noteworthy; Prince Felix Salm-Salm's *Diary* gives valuable information as to Maximilian's decline and fall. Also Dela Gorce, *Histoire du second empire*, vols. iv. v.; J. F. Dornench, *L'Empire mexicain* (Mexico, 1866), and *Le Mexique tel qu'il est* (Paris, 1867); Daran, *El General Miguel Miramón* (in French) (Rome, 1886); Schmidt von Tavera, *Gesch. d. Regierung d. Kaisers Maximilian I.* (Vienna, 1903). Considerable value and interest. For the period since 1887 mentioned in English must be sought chiefly in magazine articles: Matias Romero, "The Garza Raid and its Lessons," *North American Review* (Sept. 1892); Don Agustín Iturbide, "Mexico under Diaz," *ibid.* (June 1894); Romero, "The Philosophy of Mexican Revolutions," *ibid.* (Jan. 1896); and C. F. Lummis, "The Awakening of a Nation" (New York, 1898, previously in *Harper's Magazine*), are valuable as giving information (especially the last named) and points of view. Van Dyke, "Politics in Mexico," *Harper's Magazine* (1888), vol. lxxi., gives particulars of the opposition to Gonzalez's debt conversion scheme of 1884. President Diaz's message of November 1896, giving an account of his stewardship from 1884 to that year, has been translated into French (*Rapport du Général Porfirio Diaz... à ses compatriotes sur les actes de son administration, &c.*), edited by Auguste Génin (Paris, 1897). The early constitutions of the Republic have been published (in Spanish) in three volumes; a study of that of 1857 by B. Moses (of the University of California) is in the *Annals of the American Academy of Political Science*, II. i. 1891. Various books, chiefly American, have been written on Mexico of late years from a tourist's standpoint. Mrs Alec Tweedie's *Mexico as I saw it* (London, 1901) and *Life of Porfirio Diaz* (1906) contain valuable information personally obtained from good authorities in Mexico. See also Percy F. Martin, *Mexico of the Twentieth Century*, 2 vols. (London, 1907); and C. R. Enock, *Mexico* (1909). (J.S.M.)

MEXICO, a state of the republic of Mexico, bounded N. by Hidalgo, E. by Tlaxcala and Puebla, S. by Morelos and Guerrero, and W. by Michoacán. Pop. (1900), 934,468, largely Indian. Area, 9247 sq. m., a large part of which lies within that great depression of the Mexican plateau known as the Valley of Mexico. Enclosed within its boundaries, except on the south, is the Federal District and capital city of Mexico with an area of 463 sq. m., which is not included in that of the state. The state is divided into two unequal parts by the Sierra de Ajusco and Montes de las Cruces, which form a wooded ridge across it from east to west, with a general elevation of about 10,000 ft. above sea-level, or about 2500 above the plateau level. These ranges are part of a broken irregular chain which sometimes bears the name of Anahuac. A considerable part of the northern plateau consists of a broad plain, once the bed of a great lake but now covered with swamps, sodden meadows and lakes. The surrounding country drains into this depression, but an artificial outlet has been created by the opening of the Tequixquiac tunnel. Beyond its margin the plateau drains westward to the Pacific through the Lerma, and north-east to the Gulf through the San Juan and Pánuco. South of the Sierra de Ajusco the country is roughly mountainous and drains to the Pacific through tributaries of the Balsas. Within the lacustrine depression of the north are the lakes of Zumpango, San Cristóbal, Xaltocán, Chalco, Xochimilco, and Texcoco, the latter three lying partly or wholly in the Federal District. Texcoco has the lowest level and its water is brackish and undrinkable, though that of the streams flowing into it and of the other lakes is sweet.

Lake Xochimilco is celebrated for its "floating gardens" or *chinampas* (see MEXICO, FEDERAL DISTRICT OF). The principal industries of the state are agricultural, and the principal products are cereals, sugar, maguey (from which "pulque" is made), coffee, and fruit. Stock-raising has also had a profitable development, owing to the proximity of the national capital. The manufacturing industries are important; among the manufactures are cotton and woollen fabrics, flour, dairy products, glass-ware, pottery, bricks, wines and spirits. The making of "pulque" from the sap of the maguey plant (*Agave americana*) is the chief industry of the state, and the product is exported in large quantities to the national capital. The state is traversed by the Central, National, Mexican International and Inter-oceanic railways, and by short lines from the national capital to neighbouring towns. The capital is Toluca, and other important towns are Zumpango (pop. 5942 in 1900), 30 m. N. of the national capital, Tenango del Valle (5881 in 1900), 15 m. S.E. of Toluca, and Lerma (estimated, 7200), near the western frontier of the state.

MEXICO, a city and the county-seat of Audrain county, Missouri, U.S.A., N.E. of the centre of the state, and about 110 m. N.W. of St Louis. Pop. (1890), 4789; (1900), 5099, including 948 negroes and 111 foreign-born; (1910), 5939. It is served by the Chicago & Alton, the Chicago, Burlington & Quincy, and the Wabash railway systems. Mexico is the seat of Hardin College and Conservatory of Music (Baptist, 1873), for young women, an institution founded and endowed by Charles H. Hardin (1820-1892), governor of the state in 1872-1874, and of the Missouri Military Academy (1889). The city is situated in the blue grass region of Missouri, and is a shipping-point for horses and mules. Among the manufactures are flour, shoes and fire-clay products. Mexico was laid out as a "New Mexico" in 1836, and became the county-seat under its present name in 1837. It was incorporated as a town in 1855, was entered by the Wabash road in 1858 and by the Alton in 1872, and was first chartered as a city in 1874.

MEXICO CITY, capital of the Republic of Mexico and chief town of the Federal District, near the southern margin of the great central plateau of Mexico, in lat. 19° 25' 45" N., long. 99° 7' W. It is about 200 m. in a direct line W. by N. of Vera Cruz, its nearest port on the Gulf of Mexico, with which it is connected by two railway lines, one of which is 264 m. long; and about 181 m. in a direct line N.N.E. of Acapulco, its nearest port on the Pacific, with which it is connected partly by rail and partly by a rough mountain trail (the *camino real*) to the coast. Pop. (1900), 344,721.

The city stands on a small plain occupying the south-western part of a large lacustrine depression known as the Valley of Mexico (*El Valle de México*), about 3 m. from the western shore of Lake Texcoco, whose waters once covered a considerable part of the ground now occupied by the city. The Valley, including the drainage basin of Lake Zumpango, has an area of 2219 sq. m. (1627 sq. m. without that basin). The elevation of the city above sea-level is 7415 ft., only a few feet above the level of Lake Texcoco. The general elevation of the Valley is about 7500 ft., that of Lake Zumpango being 7493 ft., and of Lake Chalco 7480 ft. The rim of the Valley is formed by spurs of the transverse cordillera on the north and south sides—the Sierra de Guadalupe (650 to 750 ft. above the city) on the north, and the Sierra Nevada with its snow-clad peaks of Popocatepetl and Ixtaccihuatl farther away to the south-east—and by a part of the Sierra de Ajusco, known as the Montes de las Cruces, from which the greater part of the city's water supply is derived. Lake Texcoco (*Texcoco* or *Tecuaco*) is a comparatively shallow body of brackish water, with an area of about 11½ sq. m., and is fed by a number of small streams from the neighbouring mountains, and by the overflow of the other lakes. Its shores are swampy and desolate and show considerable belts of saline incrustations with the fall in its level. The Aztecs settled there because of the security afforded by its islands and shallow waters—their city, Tenochtitlán, being so completely surrounded by water that a handful of warriors could easily

defend its approaches against a greatly superior force. The Chalco and Xochimilco lakes, 8 or 9 m. to the southward, which are separated by a narrow ridge of land, are connected with the lower part of the city by an artificial canal, called "La Vega," 16 m. long and 30 ft. wide, which serves as an outlet for the overflow of those lakes and as a waterway for the natives who bring in flowers and vegetables for sale. Lake Xochimilco, celebrated for its *chinampas*, or "floating gardens" (see MEXICO, FEDERAL DISTRICT OF), is supplied very largely by fresh-water springs opening within the lake itself, which the city has partially diverted for its own water supply. Lake Chalco is also greatly reduced in size by railway fillings and irrigation works, to the great distress of the natives who have gained their living by fishing in its waters since long before the Spanish conquest.

The climate of the city is temperate, dry and healthful. The temperature ranges from a minimum of 35° F. in winter to a maximum of 79° in summer. The winter range is 35° to 68°, and the summer 50° to 79°. The nights are always cool. The year is divided into a wet and dry season, the former from April to September, the latter from October to March. The rainfall, however, is light, about 20 to 25 in., but, with the assistance of irrigation, it serves to sustain a considerable degree of cultivation in the neighbourhood of the city. The health of the city, unfortunately, does not correspond with its favourable climatic conditions. With a wet, undrained subsoil and a large population of Indians and half-breeds living in crowded quarters, the death-rate has been notoriously high, though the completion of the Valley drainage works in 1900, supplemented by underground sewers in the better parts of the city, and by better sanitation, have recently improved matters. The annual death-rate per 1000 was 54 per 1000 for the Federal District in 1901, 50 in 1902, 48 in 1903, 46 in 1904, and 56 in 1905; the increase for the last-mentioned year being due to an epidemic of typhus fever.

The city is laid out with almost unbroken regularity and is compactly built—the streets running nearly with the cardinal points of the compass. The new and better residence sections are on the western side; the poorer districts are on the eastern side nearer the swampy shores of Lake Texcoco. As the name of a street changes with almost every block, according to the old Spanish custom, a list of street names is sometimes mistakenly accepted as the number of continuous thoroughfares in the city, so that it has been said that Mexico has 600 to 900 streets and alleys. An attempt was made in 1889 to rename the streets—all running east and west to be called *avenidas*, all running north and south *calles*, and all continuous thoroughfares to have but one name—but the people clung so tenaciously to the old names that the government was compelled to restore them in 1907. Outside the Indian districts of the eastern and southern outskirts, the streets are paved with asphalt and stone, lighted with electricity and gas, and served with an efficient street railway service. The political and commercial centre of the city is the Plaza Mayor, or Plaza de la Constitución, on which face the cathedral, national palace, and municipal palace. Grouped about the Plaza de Santo Domingo are the old convent and church of Santo Domingo, the court of the Inquisition now occupied by the School of Medicine, the offices of the Department of Communications, and the old custom-house (*aduana*). Close by are the old church of the Jesuits and the mechanics' school (*artes y oficios*) with its large and well-equipped shops. Among other well-known *plazas* are: Loreto, on which faces the great enclosed market of the city; Guardiola, in the midst of handsome private residences; San Fernando, with its statue of Vicente Guerrero; and Morelos, with its marble statue of the national hero of that name. The Paseo de la Reforma, the finest avenue of the city, is a broad boulevard extending from the Avenida Juárez south-west to Chapultepec, a distance of nearly three miles. At intervals are circular spaces, called "glorietsas," with statues (the famous bronze equestrian statue of Charles IV., and monuments to Columbus, Cuauhtemoc the last of the Aztec emperors, and Juárez). Other notable avenues are Bucareli and Juárez, and the Avenida de la Vega, which skirts the canal of

that name. The principal business streets runs westward from the Plaza Mayor toward the Alameda, and is known as the Calle de los Plateros (Silversmiths' Street) for two squares, Calle de San Francisco for three squares, and Avenida Juárez along the south side of the Alameda to its junction with the Paseo. The Alameda, or public garden, $\frac{1}{2}$ m. west of the Plaza Mayor, covers an area of 40 acres, and occupies the site of the old Indian market and place of execution, where occurred the first auto-da-fé in Mexico in 1574.

The great cathedral stands on or near the site of the Aztec temple (*teocalli*) destroyed by Cortés in 1521. The foundations were laid in 1573, the walls were completed in 1615, the roof was finished in 1623, its consecration took place in 1645 and its dedication in 1667, the towers were completed in 1791, and the great church was finished about 1811. It is 426 ft. in length by 197 ft. in width, and its towers rise to a height of 204 ft. Its general plan is that of a Greek cross, with two great naves and three aisles, twenty side-chapels and a magnificent high altar supported by marble columns and surrounded by a tumbago balustrade with sixty-two tall statues carrying elaborate candelabra made from a mixture of silver and copper. The elaborately carved choir is also enclosed by tumbago railings, made in Macaco, weighing 26 tons. The vaulted roof is supported by twenty Doric columns, 180 ft. in height, and the whole interior is richly carved and gilded. The walls are covered with rare paintings. Standing close beside the cathedral is the highly ornamented façade of a smaller church called El Sagrario Metropolitano. The city has about sixty church edifices, including La Profesa, Loreto, Santa Teresa, Santo Domingo and San Hipólito. At the time of the secularization of Church properties there were about 120 religious edifices in the city—churches, convents, monasteries, &c.—many of which were turned over to secular uses.

The national palace, also on the Plaza Mayor, has a frontage of 675 ft. on the east of the Plaza, and covers a square of 47, 840 sq. yds., or nearly 10 acres. It contains the executive offices of the government and those of five cabinet ministers (interior, foreign affairs, treasury, war and justice), the senate chamber, the general archives, national museum, observatory and meteorological bureau. The palace occupies the site of the residence of Moctezuma, which was destroyed by the Spaniards, and that of Hernando Cortés, which was also destroyed in 1692. It has three entrances on the Plaza, and over its main gateway hangs the "Liberty bell" of Mexico first rung by the humble parish priest, Fr. Hidalgo, on the night of the 16th of September 1810, to call the people of Dolores to arms, and now rung at midnight on each recurring anniversary by the president himself. The national museum, which occupies the east side of the national palace, is rich in Mexican antiquities, among which are the famous "calendar stone,"¹ supposed to be of Toltec origin, and the "sacificial stone" found in the ruins of the great *teocalli* destroyed by Cortés. Near the cathedral is the *monte de piedad*, or government pawnshop, endowed in 1775 by Pedro Romero de Terreros (conde de Recla) with 175,000, and at one time carrying on a regular banking business including the issue of bank-notes. Its business is now limited to the issue of small loans on personal property—the aggregate sometimes reaching nearly 150,000 a month. The national library, which has upwards of 225,000 volumes, occupies the old St Augustine Church, dedicated in 1692 and devoted to its present use by Juárez in 1867. It contains an interesting collection of the busts of Mexican celebrities. The academy of San Carlos and school of fine arts (founded in 1778) likewise contains good collections of paintings and statuary.

Among other institutions are the new post office, begun in 1902 and finished in 1907; the Minería, occupied by the schools of mining and engineering; the military school, occupying a part of the castle of Chapultepec; the Irburbe palace, now occupied as a hotel; the Irburbe theatre, occupied by the chamber of deputies, for which a new legislative palace to cost 2,500,000 pesos was under construction in 1909; the new palace of justice; the old mint, dating from 1537; the new penitentiary, completed in 1900; the Pantofón, with its monuments to the most celebrated Mexicans; the new general hospital; the jockey club on Plaza Guardiola, a new university (1910) and new school edifices of modern design. The city is likewise generously provided with hospitals and asylums.

The old Spanish edifices were very solidly constructed of stone, and private residences were provided with iron gates and window guards strong enough to withstand an ordinary assault. Private houses were also provided with flat roofs (*azoteas*) and battlements, which gave them great defensive strength, as well as a cool, secluded retreat for their inmates in the evening. The old Moorish style of building about an open court, or *patio*, prevails, and the living-rooms of the family are on the second floor. The better residences of the old style were commonly of two storeys—the ground-floor being occupied by shops, offices, stables and servants' quarters. The more modern constructions of the Colonia Juárez and other new residence districts are more attractive and pretentious in appearance, but are less solidly built.

¹ Bandlerier thinks it should be called the "Stone of the Sun."

Mexico was formerly one of the worst drained large cities of the New World, its subsoil being permanently saturated and its artificial drainage being through open ditches into the San Lazaro Canal which nominally discharged into Lake Texcoco. The difference in level between the city and the lake being less than six feet and the lake having no natural outlet, typhus fever became a common epidemic in its lower and poorer sections. The earliest effort to correct this evil was by the Dutch engineer Maartens (Span., Martinez), who planned a deep cutting through Nochistongo Hill, north of the city, to carry away the overflow of Lake Zumpango (7493 ft. elevation) to the river Tula, a tributary of the Panuco. The cutting was 13 m. long and is known as the Tajo de Nochistongo. It was begun in 1607, a year when the city was completely flooded—but was not completed until 1789, and then it was found that the city was still subject to partial inundations, although an enormous sum of money and 70,000 lives of Indian labourers had been expended upon it. The worst inundation in the history of the city occurred in 1629, when its streets were covered to a depth of 3 ft. and remained flooded until 1634. In 1856 President Ignacio Comonfort invited tenders for drainage works conditional on the use of waste waters for irrigation purposes, and the plan executed consists of a canal and tunnel 43 m. long, starting from the east side and 4½ ft. below the mean level of the city and running north to Tampico and thence eastward into a tunnel over 6 m. long, which discharges into a small tributary of the Panuco river near the village of Tequixquiac. The greatest depth of the tunnel is 308 ft. below the surface. The works were inaugurated in 1900.

For the water supply the Aztecs used the main causeway through their city as a dam to separate the fresh water from the hills from the brackish water of Texcoco, and obtained drinking water from a spring at the base of the hill of Chapultepec. The Spaniards added three other springs to the supply and constructed two long aqueducts to bring it into the city. Three other sources were added during the 19th century, and in 1899-1900 steps were taken to secure a further supply from the Rio Honco. Besides these there are 11 public and 137 private artesian wells in the city. All these sources are estimated to yield about 220 to 230 litres per head.

Considerable attention has always been given to education in Mexico, but in colonial times it was limited in scope, and to the dominant classes. The old university of Mexico, with its faculties of theology, law and medicine (founded 1551 and inaugurated 1553), ceased to exist in 1865 and was succeeded by schools of engineering, law and medicine, which have been signally successful. The government also maintains schools of agriculture, commerce, fine arts, music, pharmacy, technology, and an admirable preparatory or high school, besides a large number of primary and secondary schools for which modern school buildings have been erected. Normal and industrial schools for both sexes are maintained, the latter (*artes y oficios*) performing a very important service for the poorer classes. In 1908 there were 353 government schools in the city, including 13 professional and technical schools, and nearly 200 private schools. There are also several scientific organizations and societies. The Mexican Geographical Society (*Sociedad mexicana de geografía y estadística*), founded in 1833, has rendered invaluable services in the work of exploration and publication; there are also the Geological Society, the Association of Engineers and Architects, and the Society of Natural History.

Through lack of water-power and cheap fuel Mexico has never been rated as a manufacturing city. However, the development of electric power, and the possibility of transmitting it over long distances, have worked a noteworthy change in this respect, and a large number of industries have been added in recent years. The largest of these electric-power plants is on the Necaxa and Tenango rivers, in the state of Puebla, 92 m. from the city, which is designed to furnish 40,000 horse-power for industrial and lighting purposes, and a duplicate plant was decided upon in 1904. Another plant is in the suburb of San Lazaro, the current being distributed by over 100 m. of underground mains in the city and many miles of overhead wires in its outskirts and suburbs. Other plants are at San Ildefonso, 12 m. distant, and on the Churubusco river, 16 m. south. According to a British consular report for 1904 there were 153 manufacturing establishments in the city, producing cotton, linen and silk textiles, leather, boots and shoes, alcohol and alcoholic beverages, beer, flour, conserves and candied fruits, cigars and cigarettes, Italian pastes, chocolate, starch, hats, oils, ice, furniture, pianos and other musical instruments, matches, beds, glasses, chemicals, iron and steel, printing-type, paint and varnish, glass, looking-glass, cement and artificial stone, earthenware, bricks and tiles, soap, cardboard, papier mâché, cartridges and explosives, white lead, perfumery, carriages and wagons, and corks. To these should be added the foundries and iron-working shops which add so much to the prosperity of modern Mexico. Perhaps the most important of these manufactures are the cotton mills, of which there are 13, and the cigar and cigarette factories, of which there are 10. In the suburbs oils, chemicals, cigarettes and bricks are made at Tacuba; cotton textiles at Contreras, San Angel and Tlalpam; paper and boots at Tacubaya, and bricks at Mixcoac and Coyoacan. A little farther away are the woollen mills of San Ildefonso, the paper-mills of San Rafael, and important works for the manufacture of railway rolling stock.

The railway connexions include direct communication with one port on the Gulf coast and with two on the Pacific—lines were under construction in 1909 to two other Pacific ports—and indirect communication with two on the Gulf. The Mexican and Inter-oceanic lines connect with Vera Cruz, the Mexican Central with Manzanillo, via Guadalajara and Colima, and the Vera Cruz & Pacific (from Cordoba) with the Tehuantepec line and the port of Salina Cruz. The last-mentioned line also gives indirect connexion with the port of Coatzacoalcos, and the Mexican Central, via San Luis Potosí, with Tampico. A southern extension of the Mexican Central, via Cuernavaca, has reached the Balsas river and will be extended to Acapulco, once the chief Pacific port of Mexico and the dépot for the rich Philippine trade. A Mexican extension of the (American) Southern Pacific which has been completed from Nogales to Mazatlán is to be extended to Guadalajara, which will give the national capital direct communication with the thriving ports of Mazatlán and Guaymas. In addition to these, the Mexican Central and Mexican National, now consolidated, give communication with the northern capitals and the United States, and the Mexican Southern runs southward, via Puebla, to the city of Oaxaca. These railways, with the shorter lines radiating from the city, connect it with nearly all the state capitals and principal ports.

The population by the census of 1900 was 344,721—an increase of 12,947 over the returns of 1895. The great majority of the inhabitants is composed of Indians and half-breeds—from whom come the factory workers, labourers, servants, porters and other menial wage-earners. In former times Mexico was overrun with mendicants (*pardioseros*), vagrants and criminals (*rateros*), and the "Portales de las Flores" on the east of the Plaza Mayor was a favourite "hunting-ground" for them because of its proximity to the cathedral; but modern conditions have largely reduced this evil. The foreign population includes many capitalists and industrial managers who are doing much to develop the country, the American colony being concentrated in a fine modern residential district on the south-western side of the city.

History.—The City of Mexico dates, traditionally, from the year 1325 or 1327, when the Aztecs settled on an island in Lake Texcoco. The Aztec name of the city was Tenochtitlan, derived either from Tenoch, one of their priests and leaders, or from *tenuch*, the Indian name for the "nopal," which is associated with its foundation. The modern name is derived from Mexitli, one of the names of the Aztec god of war Huitzilopochtli, which name was later on applied also to the Aztecs themselves. The island settlement, which was practically a lake-village built on islets—some of them undoubtedly artificial, and perched on stakes—grew rapidly with the increasing power and civilization of its inhabitants, who had the remains of an earlier civilization (Tula, Teotihuacán, Cholula, and other older towns) to assist in their development. About the middle of the 15th century their mud-and-rush dwellings were partly replaced by stone structures, grouped around the central enclosure of the great *teocalli*, and bordering the causeways leading to the mainland. The town had reached its highest development when the Spaniards appeared in 1519, when it is said to have had, including suburban towns, a total of 60,000 dwellings, representing about 300,000 inhabitants. It was at that time about 12 m. in circumference, everywhere intersected by canals, and connected with the mainland by six long and solidly constructed causeways, as shown in the plan given in the edition of Cortés's letters published at Nuremberg in 1524 (reproduced in vol. i. of H. H. Bancroft's *History of Mexico*, San Francisco, 1883, p. 280). Allowance should be made for the habit of exaggeration among the Spanish adventurers of that time, and also for the diplomacy of Cortés in magnifying his exploits to win the favour of his king. The truth is, without doubt, that the dwellings of the lower classes were still built of reeds and mud, and covered the greater part of the city's area, otherwise it is impossible to understand how a mere handful of Spanish soldiers, without tools and explosives, could so easily have levelled it to the ground. After its almost total destruction in November 1521, Cortés employed some 400,000 natives in rebuilding the city on its former site. Since then the lake has decreased greatly in extent, its area being reduced to 1½ sq. m. and its shore-line being more than 3 m. distant from the city it once surrounded. During Spanish rule the only break in the ordinary course of events was the revolt of 1602, which resulted in the destruction of the municipal buildings. The city was not much disturbed by the struggle for independence,

but it was afterwards the scene of many a revolution until the dictatorial authority of Porfirio Diaz put an end to petty pronunciamentos and partisan intrigues.

In the war between Mexico and the United States the most decisive campaign was that of General Winfield Scott directed against the Mexican capital. With the advanced guard of an army of about 10,000 men he arrived on the 10th of August 1847 at Ayotla, on the national road 16 m. south-east of the city; but as the approaches from this direction were very strongly fortified he cut a new road southward along the eastern shore of Lake Chalco and westward along the southern shore of lakes Chalco and Xochimilco to San Augustin, where his army arrived on the 17th and 18th of August. The city was now 10 m. distant by a direct road to the northward, but as the village of San Antonio, only 3 m. ahead, was strongly fortified, another short detour was made to the westward by cutting a road through a field of broken lava. This movement brought the Americans to the hill of Contreras, which was held by General Valencia with a force of some 7000 and 22 pieces of artillery, while President Santa Anna was in the neighbourhood with reinforcements numbering 12,000 or more. The Mexicans were routed on the morning of the 20th of August after suffering heavy losses. San Antonio was easily taken about noon of the same day, and in the afternoon the main division of the Mexican army was driven from the stone church and intrenchments at Churubusco. Three days later General Scott agreed to an armistice, but Mexico rejected the terms of peace, and hostilities were resumed on the 7th of September. During the armistice the American troops were quartered in and about the village of Tacubaya, about 2½ m. west by south of the city. Near Tacubaya, on the north by west, were some massive stone buildings known as El Molino del Rey, or the King's Mill. When attacked by the Americans under the immediate command of General W. J. Worth in the early morning of the 8th of September these buildings were defended by more than 10,000 Mexicans under Generals Leon, Alvarez and Perez, and they were captured only after a most desperate fight, which cost the Americans 787 killed and wounded and the Mexicans at least 2000 killed, wounded, and prisoners. To enter the city by way of the Tacubaya causeway it was still necessary for the Americans to capture Chapultepec. This hill, defended by about 4000 Mexicans under General Nicolas Bravo, was bombarded on the 12th of September, and was carried by assault on the 13th. On the following day the City of Mexico surrendered. It was then occupied by the American army under General Winfield Scott, and held by them until the signing of the treaty of Guadalupe-Hidalgo (May 1848).

The French intervention of 1861 led to a second occupation by a foreign power—a French military force under General Forey taking possession in June 1863. Maximilian, archduke of Austria, was crowned emperor of Mexico in the cathedral in June 1864, and held possession of the capital until the 21st of June 1867, when it was captured by General Porfirio Diaz. Earthquake shocks are of frequent occurrence, but the city rarely suffers any material damage. The great earthquake shocks of the 30th and 31st of July 1909, however, caused considerable damage in the city, and a few lives were lost.

For further description see H. H. Bancroft, *History of Mexico* (6 vols., San Francisco, 1883); Robert S. Barrett, *Standard Guide to the City of Mexico and Vicinity* (Mexico, 1900); Thomas A. Janvier, *The Mexican Guide* (5th ed., New York, 1890); D. Charnay, *Ancient Cities of the New World* (Eng. ver., New York, 1887); and *Plano de la ciudad de México, in el Diccionario enciclopédico hispano-americano* (Barcelona, 1893), xii. 740.

MEXICO, FEDERAL DISTRICT OF, a territory set apart for the independent and exclusive use of the Mexican Federal Government, occupying the south-eastern part of the Valley of Mexico, and taken from and lying within the State of Mexico, which forms its boundaries on all sides except the south where it touches the state of Morelos. Pop. (1900), 540,478, largely Indian and half-breeds; area, 463 sq. m., or accordingly to later computation 1498½ sq. m. (578½ sq. m.). The district is very irregular in outline, its greatest length (N.W. to S.E.) being 30 m.,

and its greatest breadth 25 m. It was formerly divided into one urban municipality and four rural prefectures, but under the law of the 26th of March 1903 it is divided into 13 municipalities, Mexico, Guadalupe-Hidalgo, Atzacapotzalco, Tacuba, Tacubaya, Mixcoac, Cuajimalpa, San Angel, Coyoacan, Tlalpám, Xochimilco, Milpa Alta and Ixtapalapa; the first of these comprises the national capital and its immediate suburbs, and the other 12 the unequal divisions of the district with a considerable number of towns and villages. Indians and half-breeds form more than one-half of the rural population engaged in agriculture and gardening, beside which there is a large percentage employed in manufacturing industries. The government of the district is exercised by the national executive in accordance with the organic law of 1903, though some measure of popular government is vested in municipal councils (*ayuntamientos*) elected by popular vote for terms of four years. These councils have lost much of their original legislative character, but they must be consulted in matters of local importance, such as water supply, sanitary works, and the exploitation or sale of municipal property, and in regard to all contracts affecting the municipality. They can veto by a two-thirds vote the execution of any contract or administrative project, which then, at the end of four months, if again vetoed must be taken before the President of the Republic for adjudication. The administrative officers, who are appointed by the national executive, consist of a governor of the federal district, the director-general of public works, and the president of the superior board of health. The three form a superior council of district government which exercises a supervisory and advisory power, "revising, confirming, reforming or revoking the acts of each one of the members of the council, whenever these acts are called in question." The council also exercises a general supervision of the making of contracts. The governor represents the national government, and has special charge of the fire and police departments, prisons, imposition of penalties for violation of ordinances, public diversions and festivities, civil registry, street traffic, inspection of weights and measures, and the sale of intoxicating liquors. The director-general of public works has special charge of the water supply, streets and roads, parks, monuments, public lighting, drainage, street cleaning, public buildings not under federal control, cemeteries, slaughter-houses and markets, building operations, and all municipal or communal property. The president of the superior board of health has charge of all sanitary works, general sanitary inspection, the sanitary administration of markets, slaughter-houses and cemeteries, and the introduction of meats from other localities. The government of the district is copied, in part, from that of the District of Columbia in the United States, but its citizens are not disfranchised. They elect the *ayuntamientos*, which exercise no slight influence in local affairs, and, like any state, elect senators and deputies to the National Congress.

The principal towns of the district, some of which are merely suburbs of the capital, are Guadalupe, Tacubaya, Tlalpám and Xochimilco. Within the municipal limits of Mexico City are Chapultepec, Santa Anna and the hot springs of El Peñón, which are popular suburban resorts easily reached by the ordinary urban tramway service. Chapultepec (Grasshopper Hill) is an isolated rock nearly 200 ft. high surrounded by a beautiful park and surmounted by a fortified structure called the "Castle," containing the summer residence of the president and the national military school. A finely graded road leads to the summit. The park contains a grove of old cypress trees (*Taxodium distichum*, called "ahuehuetes" by the natives), one of which is 45 ft. in circumference and nearly 200 ft. high. The hill is nearly 3 m. south-west of the city and once commanded one of its principal causeway approaches. It was assaulted and captured by the American forces under General Winfield Scott on the 13th of September 1847, after a stubborn resistance. A monument to the cadets of the military school who died in this battle stands in the park. The castle, which was built by the viceroys, was greatly embellished by the emperor Maximilian, who planned for it the drive known as the Paseo de la Reforma. Of the neighbouring towns Guadalupe or Guadalupe-Hidalgo (pop. 58,34 in 1900), 24 m. north by east from Mexico City, near the shore of Lake Texcoco, is chiefly known for its shrine to Our Lady of Guadalupe, who is said to have appeared there to the Indian Juan Diego in 1531. The shrine stands on the

principal plaza and is visited by many thousands of pilgrims during the year, whose pious contributions have so enriched the church that its sacred vessels, altar-rails, candelabra and other accessories are estimated to contain fifty tons of silver. The treaty of peace between Mexico and the United States was signed here on the 2nd of February 1848. Tacubaya (pop. 18,342 in 1900), on the lower slopes of the Montes de las Cruces, about 5 m. west-south-west of the city, with which it is connected by rail, is noted for its fine old residences and beautiful gardens. The National Astronomical Observatory occupies a fine modern edifice. At Popotla is an aged tree under which, according to tradition, Cortés sat and wept after his terrible retreat from the Aztec capital on the *noche triste*. Farther south on the lowest slopes of the mountain range are San Angel and Tlalpam, the latter (pop. 4732 in 1900) standing partly on the plain 12 m. south by west of the capital. In both much attention is given to floriculture, and both are favourite country residences of the richer citizens. Xochimilco (field of flowers), (pop. 10,712 in 1900) on the west shore of the lake of that name and 10 m. south by east of the city, is an Indian town dating long before the discovery of America. It lies in the midst of a fertile plain devoted to the production of fruit, vegetables and flowers for the city markets. Its gardens are carried out on the shallow lake by floating masses of water-plants covered with soil and secured by poplar stakes, which, taking root, soon surround them with living boundaries. These remarkable and productive gardens, called *chinampas*, have so increased in number and extent that the lake is practically covered by them, with the exception of the waterways, which are kept open by scooping up mud from the bottom. From the lake a broad canal runs northward to the eastern suburbs of the city. It is known as the Viga, and is believed to have been opened by the Aztecs for the transportation of garden produce to their island capital.

MEXICO, GULF OF, a mediterranean gulf almost surrounded by the coasts of the United States and Mexico, and forming the northern division of the extension westward of the west Atlantic trench (see ATLANTIC OCEAN). Its southern boundary is defined by the partly submerged ridge which extends eastwards from the peninsula of Yucatán, and on which the island of Cuba is situated: to the east it communicates directly with the Atlantic by the Strait of Florida. On the western side of Yucatán a southerly embayment is formed by the Gulf of Campeche. The United States coast closely follows the parallel of 30° N., while the parallel of 20° N. cuts across the Gulf of Campeche; the greatest length—Vera Cruz to Florida—is 1120 m., and greatest width—Galveston to Campeche—680 m. The total area is approximately 716,000 sq. m.

The deepest part of the Gulf of Mexico, the so-called "Sigsbee" deep, lies below the line of 2000 fathoms, between 23° and 25½° N., and 84½° to 95° W. It is widest to the west, where the breadth is about 120 m., and narrows to 25 m. at its greatest depth (2110 fathoms) between 86° and 88° W., widening again to some 80 m. farther eastward. The continental shelf is for the most part narrow: its breadth is 6 m. at Cape Florida, 120 m. along the west coast of Florida, 10 m. at the south pass of the Mississippi, 130 m. near the boundary of Texas and Louisiana, and 15 m. off Vera Cruz. The shores are low, sandy and marshy, the coast-line being frequently doubled by lagoons. There are no islands except the "Keys" of Florida and Yucatán, and Cuba. The tides in the Gulf of Mexico are of comparatively small range (springs rarely exceed 4 ft. and neaps 2½ ft.), but a remarkable feature is the exaggeration of the diurnal inequality to such an extent as almost to extinguish the semi-diurnal tide in the inner parts of the gulf, giving high and low water only once daily. The mean level of the water in the Gulf of Mexico was formerly given as about 40 in. above that of mean sea-level at New York, but later reports on precise levellings from New York to Biloxi through St Louis describe it vaguely as "somewhat higher." The current movement in the Gulf of Mexico consists of a rotational movement in the direction of the hands of a watch, the branch of the equatorial current which enters the Caribbean Sea passing into the Gulf by the Strait of Yucatán and issuing from it by the Strait of Florida as the Gulf Stream, which unites with the remainder of the northward moving water, forming the Antilles current.

From March to September the prevailing winds are the north-east trades; these undergo considerable modification on account of the configuration of the surrounding land, and the rains which accompany them are interrupted by spells of calm thick

weather, and rarely by northerly winds known as *Nortes del hueso Colorado* and *Chocolateros*. In the colder dry season, from October to April, the climatic situation is dominated by the relatively high temperature of the surface of the gulf, causing a cyclonic inflow of air which is associated with the strong northerly winds or "northers" prevailing on the western side, more particularly along the Mexican coast. The northers sometimes blow with terrific force and are at times accompanied by rain. The form and position of the Gulf of Mexico exercise a profound influence on the climate of the whole of the southern and south-eastern states of the Union, and indeed of the greater part of North America. (H. N. D.)

MEYER, CHRISTIAN ERICH HERMANN VON (1801-1869), German palaeontologist, was born at Frankfurt-on-the-Main, on the 3rd of September 1801. In 1832 he issued a work entitled *Palaeologica*, and in course of time he published a series of memoirs on various fossil organic remains: mollusca, crustacea, fishes and higher vertebrata. His more elaborate researches were those on the Carboniferous amphibia, the Permian reptiles, the Triassic amphibia and reptiles, and the reptiles of the Lithographic slates; and the results were embodied in his great work *Zur Fauna der Vorwelt* (1845-1866), profusely illustrated with plates drawn on stone by the author. He was associated with W. Dunker and K. A. Zittel in the publication of the *Palaeontographica*, which began in 1851. He was awarded the Wollaston medal by the Geological Society of London in 1858. He died on the 2nd of April 1869.

MEYER, HEINRICH AUGUST WILHELM (1800-1873), German Protestant divine, was born at Gotha on the 10th of January 1800. He studied theology at Jena, and eventually became (1841) pastor, member of the consistory, and superintendent at Hanover. He died on the 21st of June 1873. He is chiefly noted for his valuable *Kritisch-exegetischer Kommentar zum Neuen Testament* (16 vols.), which began to appear in 1832, was completed in 1859 with the assistance of J. E. Huther, Friedrich Düsterdieck and G. K. G. Lünemann, and has been translated into English. New editions have been undertaken by such scholars as A. B. Ritschl, B. Weiss, H. Wendt, K. F. G. Heinrich, W. Beyschlag and F. A. E. Sieffert.

Meyer also published an edition of the New Testament, with a translation (1829) and a Latin version of the symbolical books of the Lutheran Church (1830).

He is not to be confounded with JOHANN FRIEDRICH VON MEYER (1772-1849), the senator of Frankfurt, who published a translation of the Bible in 1819 (*Die heilige Schrift in berichtigter Übersetzung mit kurzen Anmerkungen*; 2nd ed., 1823; 3rd ed., 1855).

MEYER, JULIUS LOTHAR (1830-1895), German chemist, was born on the 19th of August 1830, at Varel in Oldenburg. He was the son of a physician, and went to study medicine first at Zürich University in 1851, and then, two years later, at Würzburg, where he had R. Virchow as his teacher in pathology. The influence of C. F. W. Ludwig, under whom he studied at Zürich, decided him to devote his attention to physiological chemistry, and therefore he went, after his graduation (1854), to Heidelberg, where R. Bunsen held the chair of chemistry. There he was so influenced by G. R. Kirchhoff's mathematical teaching that he took up the study of mathematical physics at Königsberg under F. E. Neumann. In 1859 he became privat-docent in physics and chemistry at Breslau, where in the preceding year he had graduated as Ph. D. with a thesis on the action of carbon monoxide on the blood. In 1866 he accepted a post in the School of Forestry at Neustadt-Eberswalde, but soon moved to Karlsruhe Polytechnic. During the Franco-German campaign the Polytechnic was used as a hospital, and he took an active part in the care of the wounded. Finally, in 1876, he became professor of chemistry at Tübingen, where he died on the 11th of April 1895. His name is best known for the share he had in the periodic classification of the elements. He noted, as did J. A. R. Newlands in England, that if they are arranged in the order of their atomic weights they fall into groups in which similar chemical and physical properties are repeated at periodic intervals; and in particular he showed that if the atomic weights are plotted

ordinates and the atomic volumes as abscissae, the curve obtained presents a series of maxima and minima, the most electro-positive elements appearing at the peaks of the curve in the order of their atomic weights. His book on *Die modernen Theorien der Chemie*, which was first published in Breslau in 1864, contains a discussion of relations between the atomic weights and the properties of the elements. In 1882 he received from the Royal Society, at the same time as D. J. Mendelëeff, the Davy medal in recognition of his work on the Periodic Law. A younger brother, O. E. Meyer, became professor of physics at Breslau in 1864.

MEYER, KONRAD FERDINAND (1825-1898), Swiss poet and novelist, was born at Zürich on the 11th of October 1825. After studying law at the university, he went for considerable periods to Lausanne, Geneva and Paris, and in Italy interested himself in historical research. In 1875 he settled at Kilchberg near Zürich, was created in 1880 a doctor philosophiae honoris causa by that university, and died at Kilchberg on the 28th of November 1898. After Gottfried Keller, Konrad Meyer is the most important Swiss poet of modern times, though as a novelist he was perhaps more successful. His poetical works include *Balladen* (1867); *Romanzen und Bilder* (1870); the epic poem, *Huttens letzte Tage* (1871); and *Gedichte* (1882; 20th ed., 1901). Among his novels must be specially mentioned *Jürg Jenatsch* (1876; 20th ed., 1894); *Der Schuss von der Kanzel* (1878); *Der Heilige* (1880; 12th ed., 1894; English by M. von Wendheim, *Thomas à Becket, the Saint*, 1885); *Die Richterlin* (1885); *Die Versuchung des Pescara* (1887); *Angela Borgia* (1891). His shorter stories were collected in two volumes in 1885 (5th ed., 1892).

See A. Reitler, *Konrad Ferdinand Meyer* (1888); Lina Frey, *K. F. Meyer's Gedichte und Novellen* (1892); K. E. Kranz, *K. F. Meyer* (1899); A. Frey, *K. F. Meyer* (1900); H. Kramer, *K. F. Meyer: Quellen und Wandlungen seiner Gedichte* (1901); B. Meyer, *K. F. Meyer in der Erinnerung seiner Schwester* (1904); *Briefwechsel zwischen Luise von François und K. F. Meyer*, herausg. von A. Bettelheim (1905); A. Langnesser, *K. F. Meyer* (1905).

MEYER, [MARIE] PAUL HYACINTHE (1840-), French philologist, was born in Paris on the 17th of January 1840. He was educated at the École des Chartes, and in 1863 was attached to the manuscript department of the Bibliothèque Nationale. In 1876 he became professor of the languages and literatures of southern Europe at the Collège de France. In 1882 he was made director of the École des Chartes, and a year later was nominated a member of the Academy of Inscriptions. He was one of the founders of the *Revue critique*, and a founder and the chief contributor to *Romania* (1872). Paul Meyer began with the study of old Provençal literature, but subsequently did valuable work in many different departments of romance literature, and ranks as the chief modern authority on the French language. He is the author of *Rapports sur les documents manuscrits de l'ancienne littérature de la France conservés dans les bibliothèques de la Grande Bretagne* (1871); *Recueil d'anciens textes bas-latins, provençaux et français* (2 parts, 1874-1876); *Alexandre le Grand dans la littérature française du moyen âge* (2 vols., 1886). He edited a great number of old French texts for the *Société des anciens textes français*, the *Société de l'histoire de France* and independently. Among these may be mentioned *Aye d'Avignon* (1865), with Gueussard; *Flamenco* (1865); the *Histoire de Guillaume le Maréchal* (3 vols., 1892-1902); *Raoul de Cambrai* (1882), with A. Longnon; *Fragments d'une vie de Saint Thomas de Cantorbéry* (1885); *Guillaume de la Barre* (1894).

MEYER, VICTOR (1848-1897), German chemist, was born at Berlin on the 8th of September 1848, and studied at Heidelberg University under R. W. Bunsen, H. F. M. Kopp, G. R. Kirchhoff and H. L. F. Helmholtz. At the age of twenty he entered J. F. W. A. Baeyer's laboratory at Berlin, attacking among other problems that of the composition of camphor. In 1871, on Baeyer's recommendation, he was engaged by H. von Fehling as his assistant at Stuttgart Polytechnic, but within a year he left to succeed J. Wislicenus at Zürich. There he remained for thirteen years, and it was during this period that he devised his

well-known method for determining vapour densities, and carried out his experiments on the dissociation of the halogens. In 1882, on the death of W. Weith (1844-1881), professor of chemistry at Zürich University, he undertook to continue the lectures on benzene derivatives, and this led him to the discovery of thiophen. In 1885 he was chosen to succeed Hans Hübner (1837-1884) in the professorship of chemistry at Göttingen, where stereochemical questions especially engaged his attention; and in 1889, on the resignation of his old master, Bunsen, he was appointed to the chair of chemistry in Heidelberg. He died on the 8th of August 1897. In recognition of his brilliant experimental powers, and his numerous contributions to chemical science, he was awarded the Davy medal by the Royal Society in 1891.

MEYERBEER, GIACOMO (1791-1863), German composer, first known as Jakob Meyer Beer, was born at Berlin on the 5th of September 1791, of a wealthy and talented Jewish family. His father, Herz Beer, was a banker; his mother, Amalie (née Wulf), was a woman of high intellectual culture; and two of his brothers distinguished themselves in astronomy and literature. He studied the pianoforte, first under Lauska, and afterwards under Lauska's master, Clementi. When seven years old he played Mozart's Concerto in D Minor in public, and at nine he was pronounced the best pianist in Berlin. For composition he was placed under Zelter, and then under Bernard Weber, director of the Berlin opera, by whom he was introduced to the Abbé Vogler. Vogler invited him to Darmstadt, and in 1810 received him into his house, where he formed an intimate friendship with Karl Maria von Weber, who also took daily lessons in counterpoint, fugue and extempore organ-playing. At the end of two years the grand duke appointed Meyerbeer composer to the court. His first opera, *Jephtha's Gelübde*, failed lamentably at Darmstadt in 1811, and his second, *Wirth und Gast* (*Alimlek*), at Vienna in 1814. These checks discouraged him so cruelly that he feared he had mistaken his vocation. Nevertheless, by advice of Salieri he determined to study vocalization in Italy, and then to form a new style. But at Venice he was so captivated by Rossini that, renouncing all thought of originality, he produced a succession of seven Italian operas—*Romilda e Costanza*, *Semiramide riconosciuta*, *Eduardo e Cristina*, *Emma di Resburgo*, *Margherita d'Anjou*, *L'Esule di Granato* and *Il Crociato in Egitto*—which all achieved a success as brilliant as it was unexpected. Against this act of treason to German art Weber protested most earnestly, and before long Meyerbeer himself grew tired of his defection. An invitation to Paris in 1826 led him to review his position dispassionately, and he came to the conclusion that he was wasting his powers. For several years he produced nothing in public; but, in concert with Scribe, he planned his first French opera, *Robert le Diable*. This gorgeous spectacle was produced at the Grand Opéra in 1831. It was the first of its race, a grand romantic opera, with situations more theatrically effective than any that had been attempted either by Cherubini or Rossini, and with ballet music such as had never yet been heard, even in Paris. Its popularity exceeded all expectations; yet for five years Meyerbeer appeared before the public no more.

His next opera, *Les Huguenots*, was first performed in 1836. In gorgeous colouring, rhetorical force, consistency of dramatic treatment, and careful accentuation of individual types, it is at least the equal of *Robert le Diable*. In two points only did its interest fall short of that inspired by the earlier work. Meyerbeer had shown himself so eminently successful in his treatment of the supernatural that one regretted the omission of that element; and, more important still, the fifth act proved to be an anti-climax. The true interest of the drama culminates at the close of the fourth act, when Raoul, leaping from the window to his death, leaves Valentine fainting upon the ground. The opera now usually ends at the fourth act.

After the production of *Les Huguenots* Meyerbeer spent many years in the preparation of his next greatest works—*L'Africaine* and *Le Prophète*. The libretti of both these operas were furnished

¹ Or, according to some accounts, 1794.

by Scribe; and both were subjected to countless changes; in fact, the story of *L'Africaine* was more than once entirely rewritten.

Meanwhile Meyerbeer accepted the appointment of kapellmeister to the king of Prussia, and spent some years at Berlin, where he produced *Ein Feldlager in Schlesien*, a German opera, in which Jenny Lind made her first appearance in Prussia. Here also he composed, in 1846, the overture to his brother Michael's drama, *Struensee*. But his chief care at this period was bestowed upon the worthy presentation of the works of others. He began by producing his dead friend Weber's *Euryanthe*, with scrupulous attention to the composer's original idea. With equal unselfishness he procured the acceptance of *Rienzi* and *Der fliegende Holländer*, the first two operas of Richard Wagner, who, then languishing in poverty and exile, would, but for him, have found it impossible to obtain a hearing in Berlin. With Jenny Lind as prima donna and Meyerbeer as conductor, the opera flourished brilliantly in the Prussian capital; but the anxieties materially shortened the composer's life.

Meyerbeer produced *Le Prophète* at Paris in 1849. In 1854 he brought out *L'Étoile du nord* at the Opéra Comique, and in 1859 *Le Pardon de Ploumel* (Dinorah). His last great work, *L'Africaine*, was in active preparation at the Académie when, on the 23rd of April 1863, he was seized with a sudden illness, and died on the 2nd of May. *L'Africaine* was produced with pious attention to the composer's minutest wishes, on the 28th of April 1865.

Meyerbeer's genius was criticized by contemporaries with widely different results. Mendelssohn thought his style exaggerated; Fétis thought him one of the most original geniuses of the age; Wagner ungratefully calls him "a miserable music-maker," and "a Jewish banker to whom it occurred to compose operas." The reality of his talent has been recognized throughout all Europe; and his name will live so long as intensity of passion and power of dramatic treatment are regarded as indispensable characteristics of dramatic music. But his work shows that these qualities, with the aid of an experienced stage-writer, may be entirely independent of genuine music insight.

MEYNELL, ALICE CHRISTIANA (1850—), English poet and essayist, was the daughter of T. J. Thompson. Her early life was spent chiefly in Italy, and she was educated by her father. Her first volume of verse, *Preludes* (1875), illustrated by her sister Elizabeth, afterwards Lady Butler, attracted little public notice, but the delicacy and beauty of the poems and especially of the sonnet "Renunciation," were warmly praised by Ruskin. She married in 1877 the well-known Roman Catholic journalist and author Wilfrid Meynell, who became proprietor and editor of the *Weekly Register*. Under W. E. Henley's editorship she wrote regularly in prose for the *National Observer*, and also later for the *Pall Mall Gazette*, the *Saturday Review*, &c. Her poems (1893), including much of the earlier volume of *Preludes*, brought her at last more definitely before the public; and this was followed in 1901 by another slender book of delicate verse, *Later Poems*. Mrs. Meynell also showed herself a fine critic of poetry by her admirable selection, *The Flower of the Mind* (1897), an anthology of English verse. She edited the *Delight Poems* (1894) of T. G. Hake, the *Poetry of Pathos and Sorrow* (1896) of her intimate friend Coventry Patmore, and the selections from Patmore in the "Muses' Library." Her prose essays, remarkable for fineness of culture and peculiar restraint of style, appeared in successive volumes as *The Rhythm of Life* (1893), *The Colour of Life and other Essays* (1896), *The Children* (1897), and *The Spirit of Place* (1898). Later books are *London Impressions* (1898) and *The Work of John S. Sargent* (1903).

See W. Archer, *Poets of the Younger Generation* (1902).

MEYR, MELCHOIR (1810-1871), German poet, novelist and philosopher, was born at Ehingen on the 28th of June 1810, and died at Munich on the 22nd of April 1871. He read law and philosophy at Heidelberg and Munich. His greatest success was the *Erzählungen aus dem Ries* (4th ed. Leipzig, 1892), remarkable as an accurate and sympathetic picture of rural life and

character. He wrote also tragedies (*Hernö Albrecht*, 1851; *Karl der Kühne*, 1862), novels (*Vier Deutsche*, 1861; *Ewige Liebe*, 1864), and, in later life, philosophical works with a strong religious tendency. Among these were *Emilie* (philosophical dialogues, 1863), *Die Religion des Geistes* (1871), *Die Fortdauer nach dem Tode* (1869), *Die Religion und ihre jetzt gebotene Fortbildung* (1871), and *Gedanken über Kunst, Religion und Philosophie* (1874). In these works he attempted to develop a Deistic system of philosophy. He was the author of an anonymous work entitled *Gespräche mit einem Grobian* (1866).

See *Melchior Meyr. Biographisches, Briefe und Gedichte*, edited by Graf Bothmer and M. Carrière (Leipzig, 1874).

MEYRIFAB, a small semi-nomad tribe of Africans of Semitic stock, settled on the east bank of the Nile near Berber. Contrary to Arab custom, it is said they never marry slaves.

MÉZERAY, FRANÇOIS EUDES DE (1610-1683), French historian, was born at Rye near Argentan, where his father was a surgeon. He had two brothers, one of whom, Jean Eudes, was the founder of the order of the Eudists. François studied at the university of Caen, and completed his education at the college of Ste Barbe at Paris. His *Histoire de France depuis Faramond jusqu'à Louis le Juste* (3 vols., 1643-1651), is a fairly accurate summary of French and Latin chronicles. Mézeray was appointed historiographer of France, and in 1649, on the death of Vincent Voiture, was admitted to the Académie Française. His *Abbrégé chronologique* (3 vols., 1667-1668) went through fifteen editions between 1668 and 1717; but he did not hesitate in this work to attack the financiers, with the result that his salary as historiographer was diminished by Colbert. Mézeray succeeded Conrart as permanent secretary to the Académie Française (1675), and died at Paris on the 10th of July 1683. He translated Grotius's *Traité de la religion chrétienne* (1640), and a *Histoire des Turcs depuis 1612 jusqu'en 1649* (1650), which is an addition to a continuation of Chalcondyles.

See Daniel de Larroque, *Vie de François Eudes de Mézeray* (1720); vol. xiii. of *Causeries du lundi* by Sainte-Beuve, and Levasseur's *Notice sur les trois frères: Jean Eudes, François Eudes, et Charles Eudes* (1855).

MÉZIÈRES, PHILIPPE DE (c. 1327-1405), French soldier and author, was born at the château of Mézières in Picardy. He belonged to the poorer nobility, and first served under Lucchino Visconti in Lombardy, but within a year he entered the service of Andrew, king of Naples, who was assassinated in September 1345. In the autumn of that year he set out for the East in the French army. After the battle of Smyrna in 1346 he was made a knight, and when the French army was disbanded he made his way to Jerusalem. He realized the advantage which the discipline of the Saracens gave them over the disorderly armies of the West, and conceived the idea of a new order of knighthood, but his efforts proved fruitless. The first sketch of the order was drawn up by him in his *Nova religio passionis* (1367-1368; revised and enlarged in 1386 and 1396). From Jerusalem he found his way in 1347 to Cyprus to the court of Hugo IV., where he found a kindred enthusiast in the king's son, Peter of Lusignan, then count of Tripoli; but he soon left Cyprus, and had resumed his career as a soldier of fortune when the accession of Peter to the throne of Cyprus (Nov. 1358) and his recognition as king of Jerusalem induced Mézières to return to the island, probably in 1360, when he became chancellor. He came under the influence of the pious legate Peter Thomas (d. 1366), whose friend and biographer he was to be, and Thomas, who became patriarch of Constantinople in 1364, was one of the chief promoters of the crusade of 1365. In 1362 Peter of Cyprus, with the legate and Mézières, visited the princes of western Europe in quest of support for a new crusade, and when the king returned to the east he left Mézières and Thomas to represent his case at Avignon and in the cities of northern Italy. They preached the crusade throughout Germany, and later Mézières accompanied Peter to Alexandria. After the capture of this city he received the government of a third part of it and a promise for the creation of his order, but the Crusaders, satisfied by the immense booty, refused to continue the campaign. In June 1366 Mézières was

sent to Venice, to Avignon and to the princes of western Europe, to obtain help against the Saracens, who now threatened the kingdom of Cyprus. His efforts were in vain; even Pope Urban V. advised peace with the sultan. Mézières remained for some time at Avignon, seeking recruits for his order, and writing his *Vita S. Petri Thomasi* (Antwerp, 1659), which is invaluable for the history of the Alexandrian expedition. The *Prefacio* and *Epistola*, which form the first draft of his work on the projected order of the Passion, were written at this time.

Mézières returned to Cyprus in 1368, but was still at Venice when Peter was assassinated at Nicosia at the beginning of 1369, and he remained there until 1372, when he went to the court of the new pope Gregory XI. at Avignon. He occupied himself with trying to establish in the west of Europe the feast of the Presentation of the Virgin, the office of which he translated from Greek into Latin. In 1373 he was in Paris, and he was thenceforward one of the trusted counsellors of Charles V., although this king had refused to be dragged into a crusade. He was tutor to his son, the future Charles VI., but after the death of Charles V. he was compelled, with the other counsellors of the late king, to go into retirement. He lived thenceforward in the convent of the Celestines in Paris, but nevertheless continued to exert an influence on public affairs, and to his close alliance with Louis of Orleans may be put down the calamities with which the Burgundian historians covered his name. When Charles VI. freed himself from the domination of his uncles the power of Mézières increased. To this period of his life belong most of his writings. Two devotional treatises, the *Contemplatio horae mortis* and the *Soliloquium peccatoris*, belong to 1386-1387. In 1389 he wrote his *Songe du vieil pèlerin*, an elaborate allegorical voyage in which he described the customs of Europe and the near East, and advocated peace with England and the pursuit of the Crusade. His *Oratio tragédica*, largely autobiographical, was written with similar aims. In 1395 he addressed to Richard II. of England an *Épître* pressing his marriage with Isabella of France. The Crusade of 1396 inspired Mézières with no enthusiasm. The disaster of Nicopolis on the 28th of September 1396 justified his fears and was the occasion of his last work, the *Épître lamentable et consolatoire*, in which he put forward once more the principles of his order as a remedy against future disasters. Mézières died in Paris on the 29th of May 1405.

Some of his letters were printed in the *Revue historique* (vol. xlix.); the two *épîtres* just mentioned in Kervyn de Lettenhove's edition of Froissart's *Chroniques* (vols. xv. and xvi.). The *Songe du verger* or *Sonnium viridarium*, written about 1376, is sometimes attributed to him, but without definite proofs.

See Antoine Bequet, *Gallicae coelestinorum congregationis monasteria, fundationes . . .* (1719); the Abbé Jean Lebeuf's *Mémoires in the Mémoires of the Academy of Inscriptions*, vols. xvi. and xvii. (1752 and 1753); J. Delaville le Roux, *La France en Orient au xiv. siècle* (1886-1890); A. Molinier, *Manuel de bibliographie historique* vol. iv. (1904); and especially the researches of N. Jorga, published in the *Bibliothèque de l'école des hautes études* vol. 110 (Paris 1896); and the same writer's *Philippe de Mézières, et la croisade au xiv. siècle* (1896). Jorga gives a list of his works and of the MSS. on the *Songe du verger*, see P. Paris, in *Mémoires* vol. xv. (1843) of the Academy of Inscriptions.

MÉZIÈRES, a town of northern France, capital of the department of Ardennes, 55 m. N.E. of Reims by the Eastern railway. Pop. (1906), town, 7007; commune, 9393. The town itself, the streets of which are narrow and irregular, is situated on the neck of a peninsula formed by a loop of the Meuse. The river separates it from its suburb of Arches and the town of Charleville on the north and from the suburb of Pierre on the south. Adjoining Pierre is Mohon (pop. 3874), with metallurgical works. The fortifications of Mézières, as well as the citadel still dominating the town on the east, were built under Vauban's direction, but were dismantled in 1885 and 1886. Immediately to the east of the citadel runs a canal, which provides river-traffic with a short cut across the isthmus. The parish church (16th cent.) contains inscriptions commemorating the raising of the siege of Mézières in 1521 and the marriage of Charles IX. with the

daughter of the emperor Maximilian II. (1570). The north and south portals, the Renaissance tower at the west end, and the lofty vaultings, are worthy of remark. The church, which suffered severely in 1870-71, has since been restored. The prefecture and the hôtel de ville, which contains several interesting pictures relating to the history of the town, belong to the 18th century. Mézières is the seat of a prefect and of a court of assizes, and there are manufactures of bicycles, and iron and steel castings for motors, railway-carriages, &c.

Founded in the 9th century, Mézières was at first only a stronghold belonging to the bishops of Reims, which afterwards became the property of the counts of Rethel. The town was increased by successive immigrations of the people of Liège, flying first from the emperor Otto, and afterwards from Charles the Bold; and also by concessions from the counts of Rethel. Walls were built in the 13th century, and in 1521 it was defended against the Imperialists by the Chevalier Bayard, to whom a statue was erected in 1893. The anniversary of the deliverance is still observed yearly on the 27th of September. In 1815 the Germans were kept at bay for six weeks, and in 1871 the town only capitulated after a bombardment during which the greater part of it was destroyed.

MEZŐTÚR, a town of Hungary, in the county of Jász-Nagykun-Szolnok, 88 m. S.E. of Budapest by rail. Pop. (1900), 25,367. It possesses important potteries. Large herds of cattle are reared on the communal lands, which are productive also of wheat, rapeseed and maize. Several well-attended fairs are held here annually.

MEZZANINE (It. *mezzano*; Fr. *entresol*; Ger. *Zwischengeschoss*), in architecture, a storey of small height introduced between two lofty storeys, or sometimes employed to allow of the introduction of two storeys equal together in height to lofty rooms on the same floor.

MEZZOFANTI, GIUSEPPE CASPAR (1774-1840), Italian cardinal and linguist, was born on the 17th of September 1774, at Bologna, and educated there. He was ordained priest in 1797, and in the same year became professor of Arabic in the university, but shortly afterwards was deprived for refusing to take the oath of allegiance to the Cisalpine Republic. In 1803 he was appointed assistant librarian of the institute of Bologna, and soon afterwards was reinstated as professor of oriental languages and of Greek. The chair was suppressed by the viceroy in 1808, but again rehabilitated on the restoration of Pius VII. in 1814, and continued to be held by Mezzofanti until his removal from Bologna to Rome in 1831, as a member of the congregation *de propaganda fide*. In 1833 he succeeded Angelo Mai as chief keeper of the Vatican library, and in 1838 was made cardinal and director of studies in the Congregation. He died at Rome on the 15th of March 1840. His peculiar talent, comparable in many respects to that of the so-called "calculating boys," was not combined with any exceptional measure of intellectual power, and produced nothing of permanent value. It seems certain, however, that he spoke with considerable fluency, and in some cases even with attention to dialectic peculiarities, some fifty or sixty languages of the most widely separated families, besides having a less perfect acquaintance with many others.

See Russell, *Life of the Cardinal Mezzofanti* (London, 1857); A. Bellesheim, *Giuseppe Cardinal Mezzofanti* (Würzburg, 1880).

MEZZOTINT. During the 19th century two revolutions occurred in the British art of mezzotinto engraving—"la manière anglaise." The original defect of the method was the incapacity of the mezzotint "burr" on copper to yield as many fine impressions as other forms of engraving. To this defect was attributable the introduction, in 1823, of steel instead of the soft copper previously used—a change which, with the endeavour to avoid technical difficulties, led to the "mixed style," or combination of mezzotint with etching, and a general departure from the traditional form of the art, "pure mezzotint" on copper. The affinity of the method to painting in black and white which differentiates it from other kinds of engraving, and was the distinguishing charm of the mezzotints of the 17th and 18th centuries, was for a time lost, but a revival of pure mezzotint on

copper, beginning in 1780—a return, in fact, to the mode in which the classics of the art were engraved in the time of Sir Joshua Reynolds—was made possible by the invention of steel-facing. By this process engraved copper plates are electroplated with a film of steel, renewable when worn in course of printing; and a mezzotint on copper, so protected, yields more fine impressions than if it had been engraved on steel, whilst the painter-like quality remains unimpaired.

In "pure mezzotint" the design is evolved from dark to light entirely by scraping away more or less of the previously laid "ground," the original "burr" of which is left untouched in the extreme darks, and no acid, etching or line-work is used in it at all. The usual short descriptions of the method are misleading, because they fail to explain that it is the "ground," and not the "burr" of it only, which is scraped away in greater or smaller degree to produce the varying tones of the design. The necessity of realizing that there are two constituents of the "ground," the "burr" and the indentations out of which the "burr" is raised, will be appreciated later. The "rocking-tool," with which the ground is laid, somewhat resembles a carpenter's chisel, but the blade is 3 in. wide and only about 2½ in. long, whilst the cutting edge, instead of being straight, is curved in the segment of a circle. One side of the blade is deeply engraved with lines from edge to handle, and the ridges which remain between these lines form teeth at the cutting edge when the unengraved side of the tool is bevelled as an ordinary chisel is sharpened.

The tools contain from 35 to 120 teeth to each inch of their width, those with the most teeth producing grounds of the finest texture. The operator rocks the curved edge of the tool from side to side on the bare copper plate, causing the tool to travel forward, whilst each tooth makes an indentation in the copper and throws up a corresponding particle of metal, which is laid to the right. When the whole plate has been so rocked across in 45 to 60 different directions, so that no visible speck of the original bright copper surface remains unscraped by the teeth of the "rocking-tool," the "ground" is termed "full" and is ready for scraping the design. The innumerable particles of copper forming the raised "burr" give to a "full ground" much the appearance of copper-coloured plush, and a print from it, taken before any scraping has been done on it, looks not unlike a piece of black velvet. The lights and semi-tones of the design are produced by subsequent scraping and burnishing.

Assuming that a mezzotint is to be scraped from a lady's portrait by Sir Joshua Reynolds in which a piece of black drapery crosses a white dress—the engraver begins to work on a previously laid "ground" which would print uniformly black before scraping commences. In the extreme darks of the black drapery the raised "burr" is left untouched by the "scraper"—a two-edged steel instrument resembling an ancient Roman sword-blade in miniature, but having a longer point. Working from dark to light, the engraver produces the varying tones of the folds of the black drapery by scraping the raised "burr" down more or less, lowering it in fact so that it will not hold so much ink as where it is left untouched in the extreme darks. In the highest lights of the black drapery all the raised "burr" will have been removed and the original surface of the plate reached, but as yet the engraver has not produced any tone lighter than middle tint (although he has completely modelled up the black drapery), because the indentations out of which the "burr" was raised still remain in the plate and hold ink in printing. In order to produce the infinite gradation of delicate tones in the white dress, or in a sky, the scraping is continued, the indentations being thus made shallower in the passages scraped, and therefore less capable of holding ink, whilst they are obliterated almost entirely in the highest lights. When the mezzotint is finished the black drapery will stand higher than the surface of the plate modelled in a relief composed of the raised "burr," whilst all the tones of the white dress, from middle tint to pure white, will be so many actual depressions in the plate, the highest lights being the deepest. The speck of light in the eye, for instance, is a pit in the plate, surrounded by a tract of more or less raised "burr," which provides the intense black of the pupil and the half-tints of the iris. The difference of surface levels is very appreciable where high-lights impinge on strong darks, but it exists in varying degree all over the plate, and the greatest technical difficulty in pure mezzotint is to obtain adequate "edge" and definition, because the tendency is to remove too much "ground" from the edges of adjacent darks in the course of the constant scrapings necessary to smooth and polish the depressed lights.

In printing a mezzotint a non-fluid ink is thoroughly worked into every part of the plate, and the superfluous ink is wiped off again, leaving as much ink as possible in the darks, the raised "burr." If the bottom of the small lights is not quite smooth, the ink sticks in the roughness and they print dark instead of light, or the printer has to wipe so hard to get the ink out of the depressed lights that he removes too much from the raised darks. In either case loss of definition and contrast of effect results. This inherent difficulty of scraping to a sharp edge caused the use of the "mixed" methods,

in which the details were sharpened by outlining them with stipple or line etching.

Mezzotint is the best form of engraving for completeness of representation, but etching is better adapted for sketching from nature or for the expression of any fleeting idea. The two arts have distinct uses and limitations. The art function of true etching as practised by Rembrandt lies in economy of expressive line to suggest the artist's meaning, and that of mezzotint in completion of tonality to explain it. Artistic suggestion, which is not inherent in the solid tones of mezzotint, has to be imparted to the work entirely by the free play of the "scraper" on the "ground," much as the painter attains it on canvas with the brush.

The first reputed mezzotint was produced at Amsterdam in 1643 by Ludwig von Siegen, an officer in the service of the Landgrave of Hesse, and an amateur artist; but the work was a direct drawing on copper with an instrument of comparative precision resembling the roulette rather than a mezzotint, ground laid with the rocking-tool and scraped from dark to light in the present manner of the art. Siegen's innovation was led up to by the previous stipple work of Giulio Campagnola and Janus Lutma; the roulette appears to have been used before his time, and though he shared in the evolution of the rocking-tool, he was not the sole inventor of it. The earliest works referable to the method at the print room of the British Museum afford evidence, though inconclusive, that Prince Rupert, to whom Siegen showed his mode of work in 1654, and possibly also their common friend, Th. Caspar von Fürstenberger, and Rupert's assistant, Vallerant Vaillant, were more or less concerned in the gradual development of mezzotint engraving. The rocking-tool was apparently improved by Abraham Blooteling, a Dutch painter and engraver of fine portrait mezzotints, who worked in Holland and in England about the year 1680.

Rupert brought the new art over to England at the Restoration, and the portrait of Charles II., dated 1669, by William Sherwin, the first fine mezzotint, bears the engraver's acknowledgment of his indebtedness to Rupert for the secrets of the method. Mezzotint continued to be practised for a while on the Continent, but the successors of Sherwin in England so excelled in it that it early acquired abroad the title of "la manière Anglaise," and has since become an exclusively British art. Though used for transcribing the subject-pictures of the great Italian masters, and of Rembrandt, Vandyck and Rubens, almost every kind of subject being later engraved in it, the staple production in mezzotint has always been the portrait. Until the middle of the 18th century the tools continued somewhat archaic, causing in the prints an appearance of warp and wool, like that of ill-woven material, which detracted from reality of representation. The coarseness and unequal depth of the "ground" offered so much resistance to freedom of execution with the "scraper" that, though the early engravers were quite as good artists as their successors, painter-like touch was not conspicuous in the work until M'Ardeff and the interpreters of Sir Joshua Reynolds had improved the tools and technique.

Except for the collector, therefore, the chief attraction in the prints of F. Place and Luttrell, Beckett and Williams, and later those of John Simon, John Smith and John Faber, jun., who were the principal exponents of mezzotint in the last years of the seventeenth and first half of the eighteenth centuries, lies in their long series of portraits after Vandyck, Lely, Kneller and the Dutch painters then practising in England, representing such interesting personages as Charles II. and Nell Gwynn, Addison and Pope, Congreve and Wycherley, Locke and the great duke of Marlborough.

The classics of mezzotint engraving are to be found among the best plates after Sir Joshua Reynolds by James M'Ardeff, J. R. Smith and Valentine Green, the Watsons, Dickinson, Fisher, Dixon and some others, who worked during the last half of the 18th century. The brushwork of Reynolds was more in harmony with the mezzotint method than the slighter painting technique of Gainsborough and Romney, who were much less frequently engraved, perhaps because it is the highest technical difficulty in mezzotint to render the sharp edges of a sketch. For this reason a typical Gainsborough was never successfully engraved in the method. Though professional publishers and printers existed at this time and earlier, the word "excudit" on an old print, implying "published," not "engraved," the authors of the "Sir Joshua" mezzotints in most cases printed, published and sold their own works, and pure mezzotint, unmixd with etching, was almost exclusively the method they employed. Mezzotints were occasionally printed in colours, notably those engraved later after George Morland, the primary object being to conceal the worn-out condition of the plates.

The departure from pure mezzotint and temporary decay of the art began when, towards the end of the 18th century, Richard Earlom, otherwise a fine artist, introduced the radical method of a transition of Vandyck and Wright of Derby began to outline the details of his plates with stipple etching in order to avoid the labour and difficulty of scraping them to a sharp edge, using the "ground" alone. Earlom, however, did not destroy the mystery of the rich velvety darks by etching into them. A demand then arose for larger editions than the soft copper plates would yield, and the engravers attempted to meet it by combining mezzotint with

History.

positive line-etching throughout the work, thus shortening the labour of scraping the details, and fortifying the darks with lines sunk below the surface of the plate. The harmony of line and tone in some of the prints in this style by S. W. Reynolds and Charles Turner, after Sir Joshua, Hopper and their contemporaries, was more convincing than the later "mixed style" of Samuel Cousins, because there was a certain artistic significance in the etched line itself apart from the mezzotint tone, but every touch of line in a mezzotint does something to destroy the painter-like quality, and a decadence was in progress.

The same mixed method on copper was used by J. W. M. Turner in his *Liber Studiorum* series of landscape plates, his object being to rival the pen-and-wash drawings of Claude's *Liber Veritatis*. Turner, however, was not so practised in etching or mezzotint as the engravers before mentioned, and the etched foundation of the *Liber* plates was too strong for the mezzotint tone, destroying the breadth of the light, the richness of the darks, and the artistic "keeping" of the whole effect. It is the grand design of Turner reflected in the plates, rather than any quality of mezzotint or etching in them, which appeals to the artist and the connoisseur. Perhaps the greatest success in harmonizing line and tone in one plate was achieved by David Lucas in his "English Landscape" series of mezzotint after John Constable, in which he sharpened his details with the roulette, or with a slight line put in with the point of the scraper as scraping proceeded, retaining the pure "burr" in his darks. Lucas, like Samuel Cousins and his contemporaries, was handicapped by being compelled to work on the steel plates introduced in 1823, and this was the cause of the chief defect of his plates, the excessive opposition of black and white. The warm general tone which assisted the picturesqueness of the 18th century mezzotints was lost by the use of steel, because the ink did not cling to it as it does to the more porous copper. Steel being harder than copper the etching-tool penetrated less deeply, raising less "burr" and the consequent loss of force in the darks necessitated the scraping up of the lights to a higher key to force contrast of effect, which was also enhanced by the use of very white paper and a coarse black ink. It was soon found that the unfortified "burr," even on steel, would not yield the constantly increasing numbers of impressions demanded. The labour of scraping sharp lights was greatly enhanced, and though some pure mezzotints were engraved on steel, painter-like touch was practically unattainable on it, and the general effect was cold and uninteresting.

The early work of Samuel Cousins after Lawrence in the comparative use of the mixed method, and the final development of the "mixed style" on steel in his later plates after Reynolds, Millais and Landseer, are referred to in the article on Samuel Cousins.

For nearly forty years pure mezzotint ceased to be practised altogether, and the revival of it, which began in 1880, was led up to by the invention of steel-facing. The competition of photogravure, which steel-facing made a commercial possibility, for a time checked the new movement, but a photogravure, despite a mere surface resemblance to a mezzotint, is a photograph manipulated to imitate an engraving, entirely devoid of artistic individuality. In 1898 for the first time a Society of Mezzotint Engravers was formed to foster the art.

AUTHORITIES.—*British Mezzotint Portraits*, by John Challoner Smith (London, 1878), a standard book of reference, contains a long list of others at p. xiv., et p. i. See also *Lectures on Etching and Mezzotint*, by Hubert von Herkomer, R.A. (London, 1890), the most useful work on the technique. *Etching, Engraving and other Methods of Printing Pictures*, by H. W. Singer and William Strong (London, 1897); *On the Making of Etchings*, by Frank Short (London, 1898), containing a slight reference to mezzotint technique; *Art of Engraving*, by T. H. Fielding (London, 1854); Alfred Whitman, *Masters of Mezzotint* (London, 1898); *Valentine Green* (1902), *Samuel William Reynolds* (1903), *Samuel Cousins* (1904), *Charles Turner* (1907); Gordon Gordain, *James McArdell* (1909); *Thomas Watson, James Watson, Elizabeth Judkins* (1904); W. G. Rawlinson, *Turner's Liber Studiorum, a Description and a Catalogue* (2nd ed., 1906); F. Wedmore's catalogue of the David Lucas mezzotints. A little anonymous book, *A History of the Art of Engraving in Mezzotint, from its Origin to the Present Times* [by Dr James Chelsum] (Winchester, 1786), is of considerable interest. Works on the technique are somewhat elementary, and no complete history of the art exists. (G. P. R.)

MFUMBIRO, or **KIRUNGA**, general names for a chain of volcanic mountains extending across the Central African, or Albertine, rift-valley immediately north of Lake Kivu. The range, the result probably of recent geological changes, completely blocks the valley at this point, forming a divide between the rivers flowing north to the Nile and the waters of Lake Kivu, connected through Tanganyika with the Congo system. The chain consists of two groups of mountains, surrounded by a vast lava field. The western group lies directly north of Lake Kivu, and contains two active volcanoes, Kirunga-cha-gongo, the nearest to the lake (11,104 ft. high), and Kirunga-namligira

(9711 ft.), some 10 m. further north. The eastern group contains several higher peaks—some rising to needle-like points, others being truncated cones. The most lofty, Karissimbi (14,683 ft.), lies in 29° 27' 20" E., 1° 30' 20" S. Mikenjo, a few miles north and west of Karissimbi, is 14,385 ft. high. The most easterly of the peaks, Muhavuru (13,562 ft.), in 29° 40' 30" E., 1° 23' S., is an isolated sugarloaf-shaped mass with a crater filled with water on its summit. This is the mountain to which the names Mfumbiro and Kirunga were originally applied. Some 6 m. west and a little north of Muhavuru is Sabyino (Sabinjo), 11,881 ft. high. The eastern peaks are snowclad for a part of the year. North of these high mountains is a district, extending towards Albert Edward Nyanza, containing hundreds of low peaks and extinct volcanoes. It is to this region that the name Umfumbira or Mfumbiro is said properly to belong.

Mfumbiro, i.e. Muhavuru, was first seen by a white man in 1861, J. H. Speke, in his journey to discover the source of the Nile, obtaining a distant view of the cone, which was also seen by H. M. Stanley in 1876. By its Baganda name of Mfumbiro (cook-house mountains) it figured on the maps somewhat east of its true position, first ascertained by Franz Stuhlmann in 1891. In 1894 Count von Götzen travelled through the volcanic region, and the range was subsequently explored by E. S. Grogan, Major St Hill Gibbons, Captain Herrmann, Dr R. Kandt and others, the principal heights being determined in 1903. In 1907-1908 the range was geologically and topographically examined by the duke of Mecklenberg's expedition. By the Anglo-German agreement of the 1st of July 1890 "Mount Mfumbiro" was included in the British sphere in East Africa.

See Captain Herrmann, "Vulkangebiet des zentralafrikanischen Grabens," in *Mitt. v. Forsch. u. Gelehrt. a. d. Deutschen Schutzgebieten*, vol. xvii. (Berlin, 1904), and Adolf Friedrich, duke of Mecklenburg, *Ins Innerste Afrika* (Leipzig, 1909); both give maps.

MHOW, a town of Central India, with British military cantonment, within the native state of Indore, on the Malwa branch of the Rajputana railway, 13 m. S. of Indore. Pop. (1901), 36,039. It is the headquarters of the 5th division of the southern army, and one of the chief military stations of India. There are two high schools, a Zoroastrian and a Canadian mission, the Dorabji Pestonji dispensary, and a gaol.

MIAGAO, a town on the southern coast of the province of Iloilo, island of Panay, Philippine Islands, about 25 m. W.S.W. of the town of Iloilo, the capital. Pop. (1903), 20,656; in the same year the neighbouring town of San Joaquin (pop. 1903, 14,333) was incorporated with Miagao. It has a cool and healthful climate. The neighbouring country is hilly and sterile, but produces sibucao in considerable quantities. The weaving of fabrics of abacá (*Musa textilis*), or Manila hemp, and pineapple fibre is the most important local industry. The language is Panay-Visayan.

MIALL, EDWARD (1809-1881), English Nonconformist divine and journalist, was born at Portsmouth on the 8th of May 1809. He was Congregational minister at Ware (1831) and Leicester (1834), and in 1841 founded the *Nonconformist*, a weekly newspaper in which he advocated the cause of disestablishment. Miall saw that if the programme of Nonconformity was to be carried through it must have more effective representation in Parliament. One of the firstfruits of his work was the entrance of John Bright into parliamentary life; and by 1852 forty Dissenters were members of the House of Commons. This was due largely to the efforts of the Anti-State Church Association, afterwards known as the Liberation Society, which Miall had founded in 1844. The long fight for the abolition of compulsory church-rates was finally successful in 1868, and then in 1870 Miall was prominent in the discussions aroused by the Education Bill. He was at this time M.P. for Bradford (1869-1874), having previously (1852-1867) sat for Rochdale. In 1874 he retired from public life, and received from his admirers a present of ten thousand guineas. He died at Sevenoaks on the 29th of April 1881.

See the *Life*, by A. Miall (1884).

MIAMI, a city and the county-seat of Dade county, Florida, U.S.A., in the S.E. part of the state, on the N. bank of the Miami river and on Biscayne Bay. Pop. (1900), 1681; (1905), 4733; (1910), 5471. It is served by the Florida East Coast railway and by lines of coastwise steamships, and is the point of departure of the P. & O. steamships for Nassau and Havana. Miami is the centre of a farming country in which citrus fruits, especially grape-fruit, pineapples and winter vegetables are raised for northern markets. There is excellent rod-fishing; Spanish and king mackerel and blue-fish are shipped from Miami in large quantities; and in Biscayne Bay there are important sponge fisheries. An alligator "farm" and the Subtropical Laboratory of the U.S. government are points of interest. In the city is Fort Dallas (now abandoned), where American troops were quartered during the Seminole War; and Miami is still the trading point of the Seminole Indians, being immediately south of the Everglades, their home. In 1909 a project was on foot to cut a channel from Miami to Lake Okechobee and from the other side of that lake west to the Gulf at Fort Myers, thus providing an inland waterway and draining much swampy but fertile land. In 1896 there were only two dwellings and one storehouse within the present corporate limits, but in that year the place was chosen as the southern terminal of the Florida East Coast railway, which was afterwards extended towards Key West. Soon afterwards Henry M. Flagler (b. 1830), the owner of the railway, began the construction of the magnificent Royal Palm hotel, and Miami became a popular winter resort. Then came the development of commerce by the improvement of the harbour, by donations from Mr Flagler and grants by the United States government.

MIAMI, a tribe of North American Indians of Algonquian stock. The English called them *Twightwees*, a corruption of the native name, which meant the cry of the crane. They were first found in south-eastern Wisconsin, and in 1764 numbered about 1750. Their civilization was advanced and they lived in stockaded towns. They took part in Pontiac's conspiracy in 1764 and in the American War of Independence and American War of 1812 they fought on the English side. At the close of this war they were greatly reduced in numbers. A few Miami still live on a reservation in Oklahoma and in Wabash county, Indiana.

MIANTONOMO (? -1643), chief of the Narraganset tribe of North American Indians, nephew of their grand sachem, Canonicus (d. 1647). He seems to have been friendly to the English colonists of Massachusetts and Connecticut, though he was accused of being treacherous. In 1636, when under suspicion, he went to Boston to prove his loyalty to the colonists. In the following year he permitted John Mason to lead his Connecticut expedition against the Pequot Indians through the Narraganset country, and in 1638 he signed for the Narraganset the tripartite treaty between that tribe, the Connecticut colonists and the Mohegan Indians, which provided for a perpetual peace between the parties, and he agreed to take under his jurisdiction eighty of the two hundred troublesome Pequot. In 1643 a quarrel broke out between the Mohegan and the Narraganset, and Miantonomo led his warriors against those of Uncas, the Mohegan sachem. He was defeated and captured at what is now Norwich, Conn., was turned over to the Connecticut authorities, and was later tried at Boston by the commissioners of the United Colonies of New England. A committee of five clergymen, to whom his case was referred, recommended that he be executed, and the commissioners accordingly sentenced him to death and chose Uncas as his executioner. Miantonomo, who was kept in ignorance of this sentence, was taken to the scene of his defeat and was there tomahawked in cold blood by Wawegua, the brother of Uncas. There is a monument to Miantonomo in Sachem's Park, Norwich, Conn.

MIANWALI, a town and district of India in the Multan division of the Punjab. The town is situated on the left bank of the Indus, 655 ft. above sea-level. Pop. (1901), 3591. The district was formed in 1901, after the creation of the North-West Frontier Province, out of the Cis-Indus portions of Bannu and

Dera Ismail Khan districts. Area 7816 sq. m. Pop. (1901), 424,588, showing an increase of 6.1% in the decade. About three-quarters of the district lies to the east of the Indus. Along the river is a low fertile tract, liable to floods. The remaining upland, known as the Thal, is barren and sandy, cultivable only where irrigation is possible. In the north-east the district includes the western flank of the Salt Range. The part of the district west of the Indus is a level and fairly fertile plain, enclosed by the Chichali and Maidani hills. The chief agricultural products are wheat and other grains and oil-seeds. Hides and wool are also exported, together with small quantities of alum (abundant in the Salt Range), salt (from the Salt and Maidani ranges), and coal of poor quality, which is found at several points. Petroleum has been discovered. The district is served by the Multan-Rawalpindi line of the North-Western railway.

MIAOTSZE, or **MIAUTSE**, one of the aboriginal tribes of southern China. At one time they occupied a considerable portion of the fertile lands which now form the central province of the empire, but as the Chinese advanced southwards they were driven into the mountain districts of the provinces of Yunnan, Kwei-chow, Kwang-si and Kwang-tung, where they are found at the present day. As early as the reign of King Shun (about 800 B.C.) we read of an expedition having been sent to drive them out of Hu-nan. The last important campaign against them was undertaken by the emperor K'ien-lung, who, having completely subjugated the Eleuths, attacked the Miaotsze, who suffered a crushing defeat, and were compelled to purchase peace by swearing allegiance to their conquerors. They still maintain a semi-independence in their mountain-homes, but are a decaying race, gradually giving way before the Chinese. They are allowed to govern themselves on their own patriarchal system. The Miaotsze of both sexes are shorter and darker-complexioned than the Chinese, their faces are rounder and their features sharper.

See *Sketches of the Miaotse*, trans. by E. C. Bridgman; J. Edkins, *The Miaotse Tribes, their History*; and "Quaint Customs in Kwei-chow," *Cornhill Magazine* (Jan. 1872); Playfair, *The Miaotse of Kwei-chow and Yunnan* (London, 1877); A. R. Colquhoun, *Across Christy* (1883).

MIAOULIS, **ANDREAS VOKOS** or **BOKOS** (1768-1835), Greek admiral and politician, was born in Negropont. The surname Miaoulis, which was added to his family name of Vokos, or Bokos, is said to be derived from the Turkish word *miaoul*, a felucca. He settled in the island of Hydra on the east of the Morea, and when the Greek War of Independence began was known among his fellow townsmen as a trader in corn who had gained wealth, and who made a popular use of his money. He had been a merchant captain, and was chosen to lead the naval forces of the islands when they rose against the government of the Sultan. The islanders had enjoyed some measure of exemption from the worst excesses of the Turkish officials, but suffered severely from the conscription raised to man the Turkish ships; and though they seemed to be peculiarly open to attack by the Sultan's forces from the sea, they took an early and active part in the rising. As early as 1822 Miaoulis was appointed navarch, or admiral, of the swarm of small vessels which formed the insurgent fleet. He commanded the expedition sent to take revenge for the massacre of Chio (see KANARIS) in the same year. He continued to be the naval chief of the Greeks till Lord Dundonald entered their service in 1827, when he retired in order to leave the English officer free to act as commander. In the interval he had had the general direction of the naval side of the Greek struggle for freedom. He had a share in the successful relief of the first siege of Missolonghi in December 1822 and January 1823. In 1824, after the conquest of Psara by the Turks, he commanded the Greek forces which prevented the further progress of the Sultan's fleet, though at the cost of the loss of many fire ships and men to themselves. But in the same year he was unable to prevent the Egyptian forces from occupying Navarino, though he harassed them with some success. During 1825 he succeeded in carrying stores and reinforcements into Missolonghi, when it was besieged for the second time, though he could not avert its fall. His efforts to interrupt the sea communications of the Egyptian forces failed, owing to the enormous disproportion of

the two squadrons in the siege and strength of the ships. As the war went on the naval power of the Greeks diminished, partly owing to the penalty of their treasury, and partly to the growth of piracy in the general anarchy of the Eastern Mediterranean. When Miaoulis retired to make room for Dundonald the conduct of the struggle had really passed into the hands of the powers. When independence had been obtained, Miaoulis in his old age was entangled in the civil conflicts of his country, as an opponent of Capodistrias and the Russian party. He had to employ his skill in the employment of fireships against them at Poros in 1831. He was one of the deputation sent to invite King Otho to accept the crown of Greece, and was made rear-admiral and then vice-admiral by him. He died on the 24th of June 1835 at Athens.

MICA, a group of widely distributed rock-forming minerals, some of which have important commercial applications. The principal members of the group are muscovite, biotite, phlogopite and lepidolite (*q.v.*). The name mica is probably derived from the Latin *micare*, to shine, to glitter; the German word *glimmer* has the same meaning. The mineral was probably included with selenite under Pliny's term *lapis specularis*.

Mineralogical Characters.—The micas are characterized by a very easy cleavage in a single direction and by the high degree of flexibility, elasticity and toughness of the extremely thin cleavage flakes. They all crystallize in the monoclinic system, often, however, in forms closely resembling those of the rhombohedral or orthorhombic systems. Crystals have usually the form of hexagonal or rhomb-shaped scales, plates or prisms, with plane

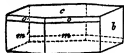

FIG. 1.



FIG. 2.

angles of 60° and 120° , and, with the exception of the basal planes, are only rarely bounded by smooth and well-defined faces. The crystal represented in fig. 1 is bounded by the basal pinacoid c (001) parallel to which is the perfect cleavage, the clinopinacoid b (010) parallel to the plane of symmetry, and the pyramids m (221) and o (112). The angles between these pyramids and the basal plane are $85\frac{1}{2}^\circ$ and 73° respectively. The prism (110) at 90° from the basal plane is not developed as a crystal face, but is a plane of twinning, the two individuals of the twin being united parallel to the basal plane (fig. 2). The different species of mica have very nearly the same forms and interfacial angles, and they not infrequently occur intergrown together in parallel position. The best developed crystals are those of Vesuvian biotite.

When a cleavage flake of mica is struck a sharp blow with a blunt needle-point a six-rayed star of cracks or "percussion figure" is developed: the rays intersect at angles of approximately 60° , and the pair most prominently developed are parallel to the plane of symmetry of the crystal. A similar six-rayed system of cracks, bisecting the angles between the rays of the previous set, is produced when a blunt punch is gradually pressed against a sheet of mica; this is known as the "pressure figure." These cracks coincide with planes of easy separation or of gliding in the crystal; they are especially useful in helping to determine the crystallographic orientation of a cleavage flake of mica when crystal faces are absent. Sheets of mica which have been subjected to earth-movements are frequently cracked and ridged parallel to these directions, and are then valueless for economic purposes.

In their optical characters the micas exhibit considerable variations. The indices of refraction are not high, the mean index being about 1.58-1.60, but the double refraction is very strong (0.04-0.05) and is negative in sign. The angle between the optic axes varies from 70° - 50° in muscovite and lepidolite to 10-0° in biotite and paragonite; the latter are thus frequently practically uniaxial. The acute bisectrix of the optic axes never deviates from the normal to the basal plane by more than a degree or two, hence a cleavage flake of mica will always show an optic figure in convergent light when placed on the stage of a polarizing microscope. The plane of the optic axes may be either perpendicular or parallel to the plane of symmetry of the crystal, and according to its position two classes of mica are distinguished. To the first class, with the optic axial plane perpendicular to the plane of symmetry, belong muscovite, lepidolite, paragonite, and a rare variety of biotite called anomite; the second class includes zinnwaldite, phlogopite, lepidomelane and

most biotites. Dark coloured micas are strongly pleochroic. Accurate determinations of the optical orientation, as well as the symmetry of the etching figures on the cleavage planes, seem to suggest that the micas, except muscovite, may be anorthic rather than monoclinic in crystallization.

The different kinds of mica vary from perfectly colourless and transparent—as in muscovite—through shades of yellow, green, red and brown to black and opaque—as in lepidomelane; the former have a pearly lustre and the latter a submetallic lustre on the cleavage surfaces. Sheets of mica very often show coloured rings and bands (Newton's rings), due to the interference of light at the surfaces of internal cleavage cracks. The spec. grav. varies between 2.7 and 3.1 in the different species. The hardness is 2-3; smooth cleavage surfaces can be just scratched with the finger-nail. The micas are bad conductors of heat and electricity, and it is on these properties that many of their technical applications depend.

Inclusions of other minerals are frequently to be observed in mica. Flattened crystals of garnet, films of quartz, and needles of tourmaline are not uncommon. Cleavage surfaces are frequently disfigured and rendered of little value by brown, red or black spots and stains, often with a dendritic arrangement of iron oxides. Minute acicular inclusions, probably of rutile, arranged parallel to the rays of the percussion figure, give rise to the phenomenon of "asterism" in some micas, particularly phlogopite: a candle-flame or spot of light viewed through a cleavage sheet of such mica appears as a six-rayed star.

Chemical Composition.—The micas are extremely complex and variable in composition. They are silicates, usually ortho-silicates, of aluminium together with alkalis (potassium, sodium, lithium, rarely rubidium and caesium), basic hydrogen, and, in some species magnesium, ferrous and ferric iron, rarely chromium, manganese and barium. Fluorine is also often an essential constituent, and titanium is sometimes present.

The composition of the several species of mica is given by the following formulae, some of which are only approximate. It will be seen that they may be divided into two groups—alkali-micas (potash-mica, &c.) and ferromagnesian micas—which correspond roughly with the division into light and dark micas.

Muscovite	$H_2K Al_2(SiO_3)_2$
Paragonite	$H_2Na Al_2(SiO_3)_2$
Lepidolite	$KLi[Al(OH,F)_2Al(SiO_3)_2]$
Zinnwaldite	$(K,Li)_2[Al(OH,F)_2]FeAl_2Si_4O_{16}$
Biotite	$(H,K)(Mg,Fe)_2(Al,Fe)_2(SiO_3)_2$
Phlogopite	$[H,K](Mg,F)Mg_2Al(SiO_3)_2$

The water which is present in muscovite to the extent of 4 to 6%, and rather less in the other species, is expelled only at a high temperature; it is therefore water of constitution, existing as basic hydrogen or as hydroxyl replacing fluorine.

Roscoelite is a mica in which the aluminium is largely replaced by vanadium (V_2O_5 , 30%); it occurs as brownish-green scaly aggregates, intimately associated with gold in California, Colorado and Western Australia.

Various attempts have been made to explain the variations in composition of the micas. G. Tschermak, in 1878, regarded them as isomorphous mixtures of the following fundamental molecules: $H_2KAl_2(SiO_3)_2$, corresponding with muscovite; $Mg_2Si_2O_6$, a hypothetical polymer of olivine; and $H_2Si_2O_6$, a hypothetical silicic acid. F. W. Clarke (1889-1893) supposes them to be substitution derivatives of normal aluminium orthosilicate $Al_2(SiO_3)_2$, in which part of the aluminium is replaced by alkalis, magnesium, iron and the univalent groups (MgF), (AlF₂), (AlO), (MgOH); an excess of silica is explained by the isomorphous replacement of H_2SiO_4 by the acid H_2SiO_3 .

Artificially formed crystals of the various species of mica have been observed in furnace-slugs and in silicate fusions.

Occurrence.—Mica occurs as a primary and essential constituent of igneous rocks of almost all kinds; it is also a common product of alteration of many mineral silicates, both by weathering and by contact- and dynamo-metamorphic processes. In sedimentary rocks it occurs as detrital material.

Muscovite and biotite are commonly found in siliceous rocks, whilst phlogopite is characteristic of calcareous rocks. The best crystallized specimens of any mica are afforded by the small brilliant crystals of biotite, which encrust cavities in the limestone blocks ejected from Monte Somma, Vesuvius. Large sheets of muscovite, such as are of commercial value, are found only in the very coarsely crystallized pegmatite veins traversing granite, gneiss or mica-schist. These veins consist of feldspar, quartz and mica, often with smaller amounts of other crystallized minerals, such as tourmaline, beryl and garnet; they are worked for mica in India, the United

States (South Dakota, Colorado and Alabama), and Brazil (Goyaz, Bahia and Minas Geraes). The commercially valuable micas of Canada and Ceylon are mainly phlogopite (*g.s.*), which has a rather different mode of occurrence. The mica mined in India is practically all muscovite. The principal mining districts are those of Hazari-bāgh in Bengal and Nellore in Madras; in the former district the mica has usually a ruby tint, whilst in the latter it is more often greenish. In the Inikūrti mine, Nellore, "books" of mica measuring 10 ft. across, and up to 15 ft. across the folia have been found, and rectangular sheets measuring 30 by 24 in. and free from cracks and flaws have frequently been obtained.

Uses.—On account of its transparency and its resistance to fire and sudden changes of temperature, mica has been much used for the windows of stoves and lanterns, for the peep-holes of furnaces, and the chimneys of lamps and gas-burners. At one time it was used for window panes of houses and the port-holes of Russian men-of-war, being commonly known as "Muscovite glass." Spangles of mica are much used for decorative purposes of various kinds, and the mineral was formerly known as *glacies Mariae* (Ger., *Frauentglas*) because of its use for decorating statues of the Virgin. The *lapis specularis* of Pliny, scattered over the Circus Maximus to produce a shining whiteness, was probably mica. Large quantities of ground mica are used in the manufacture of wall-paper, and to produce a frosted effect on toys, stage scenery, &c. Powdered mica is also used in the manufacture of paints and paper, as a lubricant, and as an absorbent of nitro-glycerine and disinfectants. Sheets of mica are used as a surface for painting, especially in India; for lantern slides; for carrying photographic films; as a protective covering for pictures and historical documents; for mounting soft and collapsible natural history specimens preserved in spirit; for the vanes of anemometers; mirrors of delicate physical instruments; for various optical and many other purposes. Being a bad conductor of heat it is used for the packing and jackets of boilers and steam-pipes. Other applications depend on the strength of its resistance to acids.

The most extensive application of mica at the present day is for electrical purposes. Being a bad conductor of electricity it is of value as an insulator, and the smooth flexible sheets are much used in the construction of armatures of dynamos and in other electrical machinery. For various purposes a manufactured material known as "micanite" or "micanite cloth" is much used; this consists of small sheets of mica cemented with shellac or other insulating cement on cloth or paper.

Muscovite and phlogopite are practically the only species used commercially, the former being the more common. Phlogopite is rarely found as colourless transparent sheets and is therefore almost exclusively used for electrical purposes. Many other uses of mica might be mentioned. The potassium it contains renders it of value as a manure. The species lepidolite is largely used for the manufacture of lithium and rubidium salts.

Mining, Preparation and Value.—Mica mining is an industry of considerable importance, especially in India; but here the methods of mining are very primitive and wasteful. In working downwards in open quarries and in tortuous shafts and passages much of the mica is damaged, and a large amount of labour is expended in hauling waste material to the surface. Since the mineral occurs in definite veins, a more satisfactory and economical method of working would be that adopted in metalliferous mines, with a vertical shaft, cross-cuts, and levels running along the strike of the vein; the mica could then be extracted by overhead stopping, and the waste material used for filling up the worked-out excavations.

In dressing mica the "books" are split along the cleavage into sheets of the required thickness, and the sheets trimmed into rectangles with a sharp knife, shears or guillotine, stained and damaged portions being rejected. The dressed sheets are sorted according to size, transparency, colour and freedom from spots or stains. Scrap mica is ground to powder or used in the manufacture of micanite.

The price of mica varies very considerably according to the size, transparency and quality of the sheets. An average price for cut sheets of all sizes is about 4s. per lb, but for large sheets it may be as high as 54s. per lb.

REFERENCES.—For the mineralogical characters see the textbooks of J. D. Dana and C. Hintze; for economic questions, the following: T. H. Holland, "The Mica Deposits of India," *Memoirs of the Geological Survey of India* (1902), xxvii, 11-121; G. P. Merrill, *The Non-Metallic Minerals* (New York, 1904), pp. 163-180; "The Mining and Preparation of Mica for Commercial Purposes," *Bulletin of the Imperial Institute* (London, 1904), ii, 278-291; F. Cirkel, "Mica: its Occurrence, Exploitation and Uses" (Canadian Dept. of the Interior, Mines Branch, Ottawa 1905, 148 pp.). (L. J. S.)

MICAH (מִיכָה), in the Bible, the name prefixed to the sixth in order of the books of the minor prophets.¹ He was a contemporary and fellow-worker of Isaiah. The name in various modifications—*Micaiāhū*, *Micāiēhū*, *Micāiāh*—is common in the Old Testament, expressing as it does a fundamental point of Hebrew faith: Who is like Yahweh?² It was also borne among others by the Danite whose history is given in Judges xvii. seq. (see separate article), by the prophet who opposed Ahab's expedition to Ramoth-Gilead (1 Kings xxii.),³ and by the son of Jonathan (see SAUL).

The editorial title of the book of Micah declares that Micah prophesied "in the days of Jotham (739-734), Ahaz (733-721) and Hezekiah (720-693), kings of Judah." Nothing in the book itself can claim to refer to the reign of Jotham, but the prophecy against Samaria (i. 5-8) may have been uttered originally before the fall of Samaria in 722, *i.e.*, in the reign of Ahaz. In its present form, however, it has been incorporated in a prophecy against Judah, belonging, most probably, to the years 705-701, when a new Palestinian rising provoked Sennacherib's campaign of 701 (Nowack; cf. Marti). This prophetic activity of Micah under Hezekiah is confirmed by the direct statement of Jer. xxvi. 17 seq., where Mic. iii. 12 is quoted ("Zion shall be plowed as a field," &c.). The verse quoted forms the climax of Mic. i.-iii., from which chapters only any certain conclusions as to the prophetic message of the historic Micah can be drawn; the remaining sections of the present book (iv.-v., vi.-vii.) consist, in whole or in greater part, of writings belonging to a later period.

Chs. i.-iii. (with the exception of two verses, ii. 12, 13)⁴ are a prediction of judgment on the sins of Judah and Ephraim. In a majestic exordium Yahweh Himself is represented as coming forth in the thunderstorm (cf. Amos i. 2) from His heavenly palace, and descending on the mountains of Palestine, at once as witness against His people, and the executor of judgment on their sins. Samaria is sentenced to destruction for idolatry; and the blow extends to Judah also, which participates in the same guilt (cf. l.). But, while Samaria is summarily dismissed, the sin of Judah is analysed at length in chs. ii. and iii., in which the prophet

¹ A confusion between the two prophets of the name has led to the insertion in the Massoretic text of 1 Kings xxii. 28 of a citation from Micah i. 2, rightly absent from the LXX.

² See, however, Gray, *Hebrew Proper Names*, p. 157; "In later times they were perhaps virtually synonymous; but this is not to be assumed for early times. The shorter forms may well have had a purely secular reference, signifying 'who is like this child?'"

³ He is called "the Morashite" (Mic. i. 1; Jer. xxvi. 18) from his birthplace, Moreseth-Gath. That Micah lived in the Shephelah or Judean lowland near the Philistine country is clear from the local colouring of l. 10 seq., where a number of places in this quarter are mentioned together (in connexion with the war in Philistia), and their names played upon in a way that could hardly have suggested itself to any but a man of the district. The paronomasia makes the verses difficult, and in i. 14 none of the ancient versions recognizes Moreseth-Gath as a proper name; but this only gives greater weight to the traditional pronunciation with *š* in the first syllable, which is as old as the LXX., and goes against the view, taken by the Targum both on Micah and on Jeremiah, and followed by some moderns (including Cheyne, E.B., 3198), that Micah came from Mareshah. When Eusebius placed *Μωραθηθ* near Eleutheropolis it is not likely that he is being placed of Mareshah (Maresa), for he speaks of the former as a village and of the latter as a ruin 2 m. from Eleutheropolis. Jerome too in the *Epist. Pauline* (Ep. cvii.), speaking as an eye-witness, distinguishes Moreseth, with the church of Micah's sepulchre, from Maresa. This indeed was after the pretended miraculous discovery of the relics of Micah in A.D. 385; but the name of the village which then existed (*Praef. in Mich.*) can hardly have been part of a pious fraud.

⁴ These two verses are a prophecy of restoration; they are admittedly an interruption in their present context (so, e.g., Driver, G. A. Smith); they belong in substance to the second section of the book (iv. v.).

no longer deals with idolatry, but with the corruption of society, and particularly of its leaders—the grasping aristocracy whose whole energies are concentrated on devouring the poor and depriving them of their little holdings, the unjust judges and priests who for gain wrest the law in favour of the rich, the hireling and gluttonous prophets who make war against every one “that putteth not into their mouth,” but are ever ready with assurances of Yahweh’s favour to their patrons, the wealthy and noble sinners that fatten on the flesh of the poor. The internal disorders of the realm depicted by Micah are also prominent in Isaiah’s prophecies; they were closely connected, not only with the foreign complications due to the approach of the Assyrians, but with the break-up of the old agrarian system within Israel, and with the rapid and uncompensated aggrandisement of the nobles during those prosperous years when the conquest of Edom by Amaziah and the occupation of the port of Elath by his son (2 Kings xiv. 7, 22) placed the lucrative trade between the Mediterranean and the Red Sea in the hands of the rulers of Judah. On the other hand the democratic tone which distinguishes Micah from Isaiah, and his announcement of the impending fall of the capital (the deliverance of which from the Assyrian appears to Isaiah as the necessary condition for the preservation of the seed of a new and better kingdom), are explained by the fact that, while Isaiah lived in the centre of affairs, Micah, a provincial prophet, sees the capital and the aristocracy entirely from the side of a mass of the oppressed people, and foretells the utter ruin of both. But this ruin does not present itself to him as involving the captivity or ruin of the nation as a whole; the congregation of Yahweh remains in Judaea when the oppressors are cast out (ii. 5); Yahweh’s words are still good to them that walk uprightly; the glory of Israel is driven to take refuge in Adullam,¹ as in the days when David’s band of broken men was the true hope of the nation, but there is no hint that it is banished from the land.

Our only evidence as to the reception of Micah’s message by his contemporaries is that afforded by Jer. xxvi. 17 seq., both directly, in the recorded effect on Hezekiah and the people; and indirectly, in the fact that the impression created was remembered a century afterwards. Micah resembles Amos, both in his country origin, and in his general character, which expresses itself in strong emphasis on the ethical side of religion. As the last of the four great prophets of the 8th century he undoubtedly contributed to that religious and ethical reformation whose literary monument is the Book of Deuteronomy.²

The remainder of the book bearing the name of Micah falls into two main divisions, viz. iv., v. and vi., vii. Each differs from the first division (i.–iii.) in a marked degree. The second consists mainly of prophecies of restoration including eschatological (v. 1 seq.)³ and Messianic (v. 2 seq.) hopes. The third is formed of three or four apparently unrelated passages, on the spirituality of true worship (vi. 1–8), social immorality and its doom (vi. 9–16; vii. 1–6), and Israel’s future recovery from present adversity through Divine grace (vii. 7–20). It is improbable that much, if any, of these chapters can be ascribed to Micah himself,⁴ not only because their contents are so different from his undoubted work (i.–iii.), for which he was subsequently remembered (Jer. xxvi. 18), but because they presuppose the historic outlook of the Exile, or a later age (e.g. iv. 6 seq.; vii. 7 seq.). It is neither psychologically nor historically impossible for a prophet of

judgment to be also a prophet of comfort; but the internal evidence of composite and (in whole or part) later authorship must outweigh the traditional attachment of these passages to a MS. containing the work of Micah.

The sequence of thought in chs. v. v. is really difficult, and has given rise to much complicated discussion. Thus iv. 11–13 stands in direct contradiction to iv. 9, 10, and indeed to iii. 12. The last two passages agree in speaking of the capture of Jerusalem, the first declares Zion inviolable, and its capture an impossible profanation. Such a thought can hardly be Micah’s, even if we resort to the violent harmonistic process of imagining that two quite distinct sieges, separated by a renewal of the theocracy, are spoken of in consecutive verses. Another difficulty lies in the words “and thou shalt come even to Babylon” in iv. 10. Micah unquestionably looked for the destruction of Jerusalem as well as for Samaria in the near future and by the Assyrians (i. 9), and this was the judgment which Hezekiah’s repentance averted. If these words, therefore, belong to the original context, they mark it as not from Micah’s hand; though they might be a later gloss. The prophetic thought is that the daughter (population) of Zion shall not be saved by her present rulers or defensive strength; she must come down from her bulwarks and dwell in the open field; there, and not within her proud ramparts, Yahweh will grant deliverance from her enemies. Opposition to present tyranny expresses itself in recurrence to the old popular ideal of the first simple Davidic kingdom (iv. 8). These old days shall return once more. A new David, like him whose exploits in the district of Micah’s home were still in the mouths of the common people (? l. 15), goes forth from Bethlehem to feed the flock in the strength of Yahweh. The kindred Hebrew nations are once more united to their brethren of Israel (cf. Amos iv. 12, Isa. vii. 1 seq.). The remnant of Jacob springs up in fresh vigour, inspiring terror among the surrounding peoples, and there is no lack of chosen captains to lead them to victory against the Assyrian foe. In the rejuvenescence of the nation the old days of that oppressive kingship which began with Solomon, the strongholds, the fortified cities, the chariots and horses so foreign to the life of ancient Israel, are no more known; they disappear together with the divinations, the soothsayers, the idols, the *mazzebah* and *asherah* of the high places. Yahweh is king on Mount Zion, and no inventions of man come between Him and His people.

The sixth chapter of Micah presents a very different situation from chs. i.–iii. or iv. v. Yahweh appears to plead with His people for their sins, but the sinners are no longer a careless and oppressive aristocracy buoyed up by deceptive assurances of Yahweh’s help, by prophecies of wine and strong drink; they are bowed down by a religion of terror, wearied with attempts to propitiate an angry God by countless offerings, and even by the sacrifice of the first-born. Meantime the substance of true religion—justice, charity and a humble walk with God—is forgotten, fraud and deceit reign in all classes, the works of the house of Ahab are observed (worship of foreign gods). Yahweh’s judgments are multiplied against the land, and the issue can be nothing else than its total desolation. All these marks may be held to fit exactly the evil times of Manasseh as described in 2 Kings xxii. ch. vii. 1–6, in which the public and private corruption of a hopeless age is bitterly bewailed, possibly belongs to the same context.

Micah may very well have lived into Manasseh’s reign, but the title in i. 1 does not cover a prophecy which certainly falls after Hezekiah’s death, and the style has nothing in common with the earlier part of the book. It is therefore prudent to regard the prophecy, with Ewald, as anonymous. Ewald ascribed the whole of chs. vi., vii. to one author. Wellhausen, however, remarks with justice that the thread is abruptly broken at vi. 6, and that verses 7–20 represent Zion as already fallen before the heathen and her inhabitants as pining in the darkness of captivity. The hope of Zion is in future restoration after she has patiently borne the chastisement of her sins. Then Yahweh shall arise mindful of His oath to the fathers, Israel shall be forgiven and restored, and the heathen humbled. The faith and hope which breathe in this passage have the closest affinities with the book of Lamentations and Isa. xl.–lxvi. Indeed, as Marti points out (p. 259) the triple division of the book of Micah (i.–iii.; iv. v.; vi., vii.) corresponds with that of the book of Isaiah (i.–xxxix; xl.–lv.; lvi.–lxvi.) in the character of the three divisions (judgment; coming restoration; prayer for help in adversity) respectively, and in the fact that the first alone gives us pre-exilic writing in the actual words of the prophet to whom the whole book is ascribed. In both cases, it need hardly be said, the great literary and spiritual value of the later passages ought in no way

¹ l. 15; the reference is, however, obscure and uncertain.

² See the Introduction to the *Century Bible*, “Deuteronomy and Joshua,” by H. Wheeler Robinson.

³ Mic. iv. 1–3 and Isa. li. 2–4 are but slightly modified recensions of the same text, and as Isa. li. is older than the prophecy of Micah, while on the other hand Mic. iv. 4 seems the natural completion of the passage, it is common to suppose that both copy an older prophet. But the words have little connexion with the context in Isaiah, and may be the quotation of a copyist suggested by ver. 5. On the other hand it has been urged that the passage belongs to a later stage of prophetic thought than the 8th century B.C. Reasons making this view the more probable one are given by Wellhausen (p. 142) and Marti (p. 281).

⁴ Nowack thinks that iv. 9, 10^a, 14 and v. 10–14 may possibly belong to Micah; Wellhausen recognizes the same possibility, which he extends, however, to vi. 1–8. Marti, who (like Cheyne in *Ency. Bib.*) finds nothing by Micah in iv.–vii., thinks these chapters have crystallized round two central passages, viz. iv. 1–4, and vi. 6–8, whose addition to the first three chapters formed the second stage in the growth of the present book. More conservative views as to authorship are taken by Driver and G. A. Smith, the former suggesting, however, that “the existing Book of Micah consists only of a collection of *excerpts*, in some cases fragmentary excerpts, from the entire series of the prophet’s discourses” (*L. O. T.*, ch. vi. § 6).

⁵ Regarded by Stade (*Z. A. T. W.*, 1903, p. 164 seq.) as an inde pendent psalm.

to suffer prejudice from critical conditions as to their date and authorship.

LITERATURE.—The chief modern commentaries are those of Nowack (*Die Kleinen Propheten*, 1897; 2nd ed., 1904) and Marti (*Dodekapropheten*, 1904), where detailed references to the older literature may be found; cf. Wellhausen, *Die Kleinen Propheten* (3rd ed., 1898). In English, reference may be made to Cheyne ("Micah," *Cambridge Bible*, 1882; 2nd ed., 1895), and to G. A. Smith ("The Book of the Twelve," vol. i, in *The Expositor's Bible*, 1896); also to the articles on "Micah" by Nowack in Hastings's *Dict. of the Bible* (1900), iii, 359, 360, and by Cheyne in the *Ency. Bibl.* (1902), iii, c. 3068-3074, the latter incorporating most of the original article (*Ency. Brit.*, 9th ed.) by W. Robertson Smith, which has been revised above. For a review of recent criticism see Cheyne, introduction to W. R. Smith's *The Prophets of Israel*, 2nd ed., pp. xxiii-xxvii.; also *Ency. Bibl. loc. cit.* J. M. F. Smith discusses "The Strophic Structure of the Book of Micah" in a volume of *Old Test. and Semitic Studies* (in memory of W. R. Harper) (Chicago, 1908).

MICAH, in the Bible, a man of the hill-country of Ephraim whose history enters into that of the foundation of the Israelite sanctuary at Dan (Judges xvii. seq.). He had stolen from his mother eleven hundred pieces of silver (for the number cf. Judges xvi. 5), and when she uttered a curse upon the unknown thief he restored the money and she consecrated it to Yahweh. A carved image was made and set up in his private temple together with an ephod-idol and teraphim (objects used in divination, cf. Gen. xxxi. 19, 30; Hos. iii. 4). He employed one of his sons to serve as priest, but when a Levite from Bethlehem in Judah came along he gladly installed him as "father and priest." When the tribe of Dan subsequently sought new territory and sent men to search for a suitable district they passed by Micah's house, recognized the Levite and requested an oracle from him. When, later, they migrated, they despoiled the sacred place and carried off the gods and priest to their new home at Laish.

MICA-SCHIST, in petrology, a rock composed essentially of mica and quartz, and having a thin parallel-banded or foliated structure, with lamellae rich in mica alternating with others which are principally quartz. They split readily along the micaceous films, and have smooth or slightly uneven surfaces covered with lustrous plates of muscovite or biotite; the quartzose lamellae are often visible only when the specimens are looked at edgewise. Mica-schists are very common in regions of Archaean rocks accompanying gneisses, crystalline limestones and other schists. Some have a flat banding yielding smooth slabs; others are crumpled or contorted with undulating foliation. Occasionally the quartz forms elliptical lenticles or "eyes." In some cases mica composes nearly the whole of the rock, in others quartz preponderates so that they approach quartz-schists and quartzites.

The mica may be muscovite or biotite; both are often present, while paragonite and green fuchsite or chrome-mica are not so common. In addition to quartz there may be a small amount of feldspar, usually albite. A great number of accessory minerals are known in mica-schists, and when these are conspicuous or important they may be regarded as constituting special varieties receiving distinctive names. Garnet, in rounded red crystals, not uncommonly idiomorphic, is the most frequent. Brown staurolite, pinkish andalusite, and grey or blue kyanite occur in some kinds of mica-schist, separately or together. The white mica-schist of the St Gothard contains kyanite and staurolite. Graphite (or graphitoid) is also a very frequent ingredient of these rocks, giving them a leaden grey colour and causing them to soil the fingers when handled. In some mica-schists there is much calcite (calc-mica-schists); and hornblende, scapolite and augite are often seen in rocks of this sort. Rutile occurs sometimes in large black prisms but more commonly in minute crystals visible only in microscopic sections. Rutile in tiny prisms, ilmenite and hematite in black or brown scales, zircon, apatite, granules of epidote or zoisite chlorite, chloritoid and pyrites occur with more or less frequency in the rocks of this group.

Mica-schists are in nearly all cases sedimentary rocks which have been recrystallized and have obtained a schistose structure during the process. This can be proved by their chemical composition, which is very much the same as that of clays, shales and slates. In some districts it is possible to trace every gradation from a slate (*q.v.*) to a mica-schist, the intermediate stages being represented by phyllites (*q.v.*) which consist of quartz, muscovite and chlorite and are neither so crystalline nor so well foliated as the schists. In a few places, e.g. Bergen in Norway, fossils have been found in mica-

schists. The association of quartzites and quartz-schists, graphitic-schists and crystalline limestones with mica-schists in the field is explained by the fact that all these rocks are altered sediments, viz. sandstones, carbonaceous shales and limestones.

Under the microscope the appearance presented by mica-schists differs according to whether the rock is cut parallel to or across the planes of foliation. In the latter case thin alternating bands composed of black or brown mica, and of quartz, cross the field of view (see Petrology, Plate 4, fig. 8). The mica scales have their cleavages and their flat sides parallel; the quartz occurs in rounded, elliptical or irregular grains, with usually a small admixture of feldspar (albite, oligoclase, orthoclase); apatite and iron oxides are rarely absent from these rocks. If garnet is present it may form large well-shaped crystals containing innumerable enclosures of quartz, biotite and iron ores; in some cases the garnets are cracked as if they had been broken by the pressures to which the rock had been subjected. Often the garnets are surrounded by small "eyes" of quartz, and they may be embedded in green chlorite, which is probably a secondary or decomposition product. Some mica-schists are rich in iron oxides and pass into haematitic-schists (fibrinites). When graphite occurs in mica-schists its crystals are small flat plates perfectly opaque even in the thinnest sections.

Like all metamorphic rocks, mica-schists are principally found in Archaean areas; the great majority of them are of pre-Cambrian age. There are, however, in the Alps, Himalayas, &c., many rocks of this sort which are believed to be secondary or even tertiary; the evidence for this is not in all cases satisfactory, as of course the fossils, which if preserved would be sufficient to prove it, are nearly always destroyed by the metamorphism. Mica-schists are rarely of economic value, being too fissile for building-stones and too brittle for roofing-slates. They are of wide-spread distribution in the Scottish Highlands, Norway and Sweden, Bohemia, Saxony, Brittany, the Alps, many parts of North America, &c. (J. S. F.)

MICCA, PIETRO, Piedmontese soldier (d. 1706), was born at Andorno, and achieved fame by his death in the defence of Turin. During the siege of that city by the French in 1706 a party of the besiegers had succeeded in penetrating by surprise into the moat of the fortress on the night of August 29-30, and would undoubtedly have captured it had not Micca, a soldier in the engineers, fired a mine, with the result that they were blown into the air and the rest of the force driven back with heavy losses. Micca's heroism has been the subject of poems, plays and romances. But, according to Count Giuseppe Solaro della Margherita, the commander of the Turin garrison at the time, it was through a miscalculation of the pace of the fuse, and not by deliberate intent, that he sacrificed his life.

See A. Manno *Pietro Micca ed il generale conte Solaro della Margherita* (Turin, 1883).

MICHAEL (Hebrew מִיכָאֵל, "Who is like God?"), an Old Testament name, synonymous with Micaiah or Micah (Num. xiii. 13; Chron. v. 13 *et passim*). In the book of Daniel the name is given to one of the chief "princes" of the heavenly host, the guardian angel or "prince" of Israel (Dan. x. 13, 21; xii. 1; cf. Enoch xx. 5 and possibly Mal. iii. 1), and as such he naturally appears in Jewish theosophy as the greatest of all angels, the first of the four (or seven) who surround the throne of God, and the antagonist of Samael, the enemy of God. He holds the earth of the mighty "word" by which God created heaven and earth (Enoch lxix. 14), and was "the angel who spoke to Moses in the Mount" (Acts vii. 38). It was through Babylonian and Persian influence that names were given to the angels, and according to Kohut (*Jüd. Angel.* p. 24) Michael is parallel to Vohumano, "Ahura's first masterpiece," one of the Zoroastrian Amesha-spentas or archangels. It is as guardian angel of Israel, or of the Church, the true Israel, that Michael appears in Jude 9 and Rev. xii. 7. This latter passage is of distinctly pre-Christian origin; it is not the Child that overthrows Satan, the figure of the Messiah is ousted by that of Michael. There is also here a relic of the primeval Babylonian myth of the struggle between the light god Marduk and the forces of chaotic darkness. In the Western Church the festival of St Michael and All Angels (Michaelmas) is celebrated on the 29th of September; it appears to have grown out of a local celebration of the dedication of a church of St Michael either at Mount Garganus in Apulia or at Rome, and was a great day by the beginning of the 9th century. The Greek Church dedicates the 8th of November to St Michael, St Gabriel and All Angels.

MICHAEL (1506-1645), tsar of Russia, was the first tsar of the house of Romanov, being the son of Theodore Nekitich Romanov, afterwards the Patriarch Philaret (*g.v.*), and Xenia Chestovaya, afterwards the nun Martha. He was elected unanimously tsar of Russia by a national assembly on the 21st of February 1613, but not till the 24th of March did the delegates of the council discover the young tsar and his mother at the Ipatievsky monastery near Kostroma. At first Martha protested that her son was too young and tender for so difficult an office in such troublesome times. At the last moment, however, Michael consented to accept the throne, but not till the weeping boyars had solemnly declared that if he persisted in his refusal they would hold him responsible to God for the utter destruction of Muscovy. In so dilapidated a condition was the capital at this time that Michael had to wait for several weeks at the Troitsa monastery, 75 m. off, before decent accommodation could be provided for him at Moscow. He was crowned on the 22nd of July. The first care of the new tsar was to clear the land of the robbers that infested it. Sweden and Poland were then got rid of respectively by the peace of Stolbova (March 10, 1617) and the truce of Deulina (Feb. 13, 1619). The most important result of the truce of Deulina was the return from exile of the tsar's father, who henceforth took over the government till his death in October 1633, Michael occupying quite a subordinate position. He was a gentle and pious prince who gave little trouble to any one and effaced himself behind his counsellors. Fortunately for him they were relatively honest and capable men. Michael's failure to wed his daughter Irene with Prince Waldemar of Denmark, in consequence of the refusal of the latter to accept orthodoxy, so deeply affected him as to contribute to bring about his death on the 12th of July 1645.

See R. Nisbet Bain, *The First Romanovs* (Lond., 1905). (R. N. B.)

MICHAEL, the name of nine East-Roman emperors.

MICHAEL I. RHANGABES (d. 845), an obscure nobleman who had married Procopie, the daughter of Nicophorus I., and was made master of the palace. He was made emperor in a revolution against his brother-in-law, Stauricus (811).

Elected as the tool of the bigoted orthodox party in the Church, Michael diligently persecuted the iconoclasts on the northern and eastern frontiers of the empire, but meanwhile allowed the Bulgarians to ravage a great part of Macedonia and Thrace; having at last taken the field in the spring of 813, he was defeated near Bersinikia, and Leo the Armenian was saluted emperor in his stead in the following summer. Michael was relegated as a monk to the island of Prote, where he lived unmolested till his death in 845.

MICHAEL II., called **PSSELLUS**, "the stammerer," emperor 820-829, was a native of Amorium in Phrygia, who began life as a private soldier, but rose by his talents to the rank of general. He had favoured the enthronement of his old companion in arms Leo the Armenian (813), but, detected in a conspiracy against that emperor, had been sentenced to death in December 820; his partisans, however, succeeded in assassinating Leo and called Michael from the prison to the throne. The principal features of his reign were a struggle against his brother general, Thomas, who aimed at the throne (822-824); the conquest of Crete by the Saracens in 823; and the beginning of their attacks upon Sicily (827). In spite of his iconoclastic sympathies, he endeavoured to conciliate the image-worshippers, but incurred the wrath of the monks by entering into a second marriage with Euphrosyne, daughter of Constantine VI., who had previously taken the veil.

MICHAEL III. (839-867), "the drunkard," was grandson of Michael II., and succeeded his father Theophilus when three years old (842). During his minority the empire was governed by his mother Theodora, who in spite of several defeats inflicted upon her generals maintained the frontiers against the Saracens of Bagdad and Crete. The regent displayed her religious zeal by restoring image-worship (842) and persecuting the Paulician heretics, but she entirely neglected the education of her son. As a result Michael grew up a debauchee, and fell under the

sway of his uncle Bardas, who induced him to banish Theodora to a convent and practically assumed the chief control (857). Bardas justified this usurpation by introducing various internal reforms; in the wars of the period Michael himself took a more active part. During a conflict with the Saracens of the Euphrates (856-63), the emperor sustained a personal defeat (860), which was retrieved by a great victory on the part of his uncle Petronas in Asia Minor. In 861 Michael and Bardas invaded Bulgaria and secured the conversion of the king to Christianity. On sea the empire suffered under the ravages of the Cretan corsairs; and in 865 the first pillaging expedition of the Russians endangered the Bosphorus. In 867 Michael was assassinated by Basil the Macedonian, a former groom, who had overthrown the influence of Bardas and in 866 been associated in the Empire.

MICHAEL IV. (d. 1041), "the Paphlagonian," owed his elevation to Zoe, daughter of Constantine VIII., who was the wife of Romanus III., but becoming enamoured of Michael, her chamberlain, poisoned her husband and married her attendant (1034). Michael, however, being of a weak character and subject to epileptic fits, left the government in the hands of his brother, John the Eunuch, who had been first minister of Constantine and Romanus. John's reforms of the army and financial system revived for a while the strength of the Empire, which held its own successfully against its foreign enemies. On the eastern frontier the important post of Edessa was relieved after a prolonged siege. The western Saracens were almost driven out of Sicily by George Maniakes (1038-40); but an expedition against the Italian Normans suffered several defeats, and after the recall of Maniakes most of the Sicilian conquests were lost (1041). In the north the Serbs achieved a successful revolt (1040), but a dangerous rising by the Bulgarians and Slavs which threatened the cities of Thrace and Macedonia was repressed by a triumphant campaign which the decrepit emperor undertook in person shortly before his death (1041).

MICHAEL V. CALAPHATES, or "the caulker," nephew and successor of the preceding, surnamed after the early occupation of his father. He owed his elevation (Dec. 1041) to his uncle John, whom along with Zoe he almost immediately banished; this led to a popular tumult in consequence of which he was dethroned after a brief reign of four months, and relegated to a monastery. His unpopularity seems largely due to his attempts at administrative reform, which were strongly resented by the dominant classes.

MICHAEL VI., "the warlike," was already an old man when chosen by the empress Theodora as her successor shortly before her death in 1056. He was unable to check the disaffection of the feudal aristocracy, who combined with an officer named Isaac Comnenus to depose him. After a successful battle in Phrygia, the rebels had no difficulty in dethroning Michael (1057), who spent the rest of his life in a monastery.

MICHAEL VII. DUCAS, or **PARAPINACES**, was the eldest son of Constantine X. Ducas. After a joint reign with his brothers, Andronicus I. and Constantine XI. (1067-1071), he was made sole emperor through his uncle John Ducas. The feebleness of Michael, whose chief interest lay in trifling academic pursuits, and the avarice of his ministers, was disastrous to the empire. As the result of anarchy in the army, the Byzantines lost their last possessions in Italy (1071), and were forced to cede a large strip of Asia Minor which they were unable to defend against the Seljuk Turks (1074). These misfortunes, which were but partially retrieved by the suppression of a Bulgarian revolt (1073), caused widespread dissatisfaction. In 1078 two generals, Nicephorus Bryennius and Nicephorus Botaniates, simultaneously revolted. Michael resigned the throne with hardly a struggle and retired into a monastery. His nickname *Parapinaces* ("starver") was due to his causing the price of wheat to rise.

MICHAEL VIII. PALAEOLOGUS (1234-1282) was the son of Andronicus Palaologus Comnenus and Irene Angela, the granddaughter of Alexius Angelus, emperor of Constantinople. At an early age he rose to distinction, and ultimately became

commander of the French mercenaries in the employment of the emperors of Nicea. A few days after the death of Theodore Lascaris II. in 1259, Michael, by the assassination of Muzalon (which he is believed but not proved to have encouraged) became joint guardian with the patriarch Arsenius of the young emperor, John Lascaris, then a lad of eight years. Afterwards invested with the title of "despot," he was finally proclaimed joint-emperor and crowned alone at Nicea on the 1st of January 1260. In July 1261 Michael, who had attacked Constantinople with the help of the Genoese, conquered the town through his general Strategopoulos. He thereupon had John Lascaris blinded and banished. For this last act he was excommunicated by Arsenius, and the ban was not removed until six years afterwards (1268) on the accession of a new patriarch. In 1263 and 1264 respectively, Michael, with the help of Urban IV., concluded peace with Villehardouin, prince of Achaia, and Michael, despot of Epirus, who had previously been incited by the pope to attack him, but had been decisively beaten at Pelagonia in Thessaly (1259); Villehardouin was obliged to cede Mistra, Monemvasia and Maina in the Morea. Subsequently Michael was involved in wars with the Genoese and Venetians, whose influence in Constantinople he sought to diminish by maintaining the balance of strength between them. In 1269 Charles of Sicily, aided by John of Thessaly, made war with the alleged purpose of restoring Baldwin to the throne of Constantinople, and pressed Michael so hard that he consented to send deputies to the council of Lyons (1274) and there accept the papal supremacy. The union thus brought about between the two Churches was, however, extremely distasteful to the Greeks, and the persecution of his "schismatic" subjects to which the emperor was compelled to resort weakened his power so much that Martin IV. was tempted to enter into alliance with Charles of Anjou and the Venetians for the purpose of reconquering Constantinople. The invasion, however, failed, and Michael so far had his revenge in the "Sicilian Vespers," which he helped to bring about. He died in Thrace in December 1282. In reconstituting the Byzantine Empire Michael restored the old administration without endeavouring to correct its abuses. By debasing the coinage he hastened the decay of Byzantine commerce.

MICHAEL IX. PALAEOLOGUS, was the son of Andronicus II. and was associated with him on the throne from 1295, but predeceased him (1320). He took the field against the Turks (1301, 1310) and against the Grand Catalan Company (1305), but was repeatedly defeated.

See Gibbon's *Decline and Fall* (ed. Bury, 1896); G. Finlay, *Hist. of Greece* (ed. 1877); G. Schlumberger, *L'Épopée byzantine* (1896); J. Bury, in *Eng. Hist. Rev.* (1889); Meliariakes, *Γεωγραφία τοῦ βασιλείου τῆς Νικαίας καὶ τοῦ δεσποτιῶν τῆς Ἠπείρου*, pp. 539-627 (Athens, 1898).

MICHAEL OBRENOVICH III. (1823-1868), Prince of Serbia, was the youngest son of Prince Milosh, the founder of the Obrenovich dynasty. After the abdication of his father (1839) and the death of his elder brother Milan Obrenovich II. (1840) he ascended the throne of Serbia. He wished to continue the work of his father, in liberating all the Serbian people, and if possible all other Balkan Christians, from direct Turkish rule. But while this programme made the Sultan hostile, it also failed to win the support of Austria, which did not wish the Eastern Question to be opened by the ambitious Serbian. The support which his aspirations found in Russia increased Turkey's and Austria's suspicions of the prince's activity. At the same time the political situation at home was not favourable to his anti-Turkish policy. The power was in the hands of men who had forced Obrenovich I. to abdicate, and feared that Obrenovich III. might avenge his father. They thought it safer for them to replace him on the throne by a man who was not an Obrenovich, and who would be personally obliged to them for his elevation. These motives were at the bottom of the revolt, started and led by Vuchich in August 1842, the outcome of which was that Prince Michael left the country and that his equerry, Alexander Karageorgevich, was elected Prince of Serbia. As an exile Prince Michael lived principally in Vienna, improving his educa-

tion by studies and travels, and frequently visiting England. He constantly refused to agree to suggestions for his restoration by forcible means. His device was *Tempus et meum jus*, "Time and my right." He supported Servian authors and artists, and wrote himself a book in defence of his father Milosh against the attacks of Cyprian Robert. He wrote poetry too, and some of his songs, set to beautiful music, were very popular amongst the Servians. He married in 1856 the beautiful Julia, Countess Hunyadi.

In 1858 the Servians, having dethroned Prince Karageorgevich, recalled Michael's father Milosh Obrenovich I. Michael returned to Servia, and on his father's death (1860) ascended the Servian throne for the second time. His proclamation "that henceforth the law is the highest will in Servia," opened a new era of strict legality and at the same time of entire emancipation from foreign influences, and more especially from Turkey's interference with the internal affairs of Servia. The old constitution, granted to Servia by the sultan as the suzerain and the tsar as the protector of Servia as far back as 1839, was discarded and replaced by one which limited the power of the oligarchic senate and gave a certain share in legislation to the "Narodna Skupshina" (the National Assembly). He established the Servian national army and increased the regular army. Reforms in all branches of public administration were introduced, and Servia, until then a half-oriental and half-patriarchal state, was resolutely led to become a civilized country in a European sense. When in 1862 the Turkish garrison bombarded the town of Belgrade from its citadel, Prince Michael, supported by the European diplomacy, succeeded in obtaining evacuation of some of the smaller forts in Servia, but the strong fortress of Belgrade still remained garrisoned by the Turkish troops. Prince Michael now made vigorous political and military preparations for war against Turkey. He made secret arrangements with the Bulgarian, Bosnian and Albanian leaders, an alliance with Montenegro and an understanding with Greece, with the object that they all should rise if Servia declared war on Turkey. He even succeeded in obtaining Austria's promise, that it would observe an attitude of friendly neutrality and would have nothing against an eventual annexation of the largest part of Bosnia to Servia, and he secured to himself the sympathies of Napoleon III. and his government. In the beginning of 1867 he formally asked the Porte to withdraw the Turkish garrisons from the fortress of Belgrade, as well as from other two fortresses of minor importance (Shabats and Smederevo (Semendria)). For some time the chances were that a war would take place that spring (1867) between Servia and Turkey, but peace was kept by the action of Great Britain, who advised the sultan to withdraw the Turkish garrisons from the Servian fortresses; and this advice, backed by Russia, France and Austria, prevailed at last with the sultan. On the 26th of April 1867 the fortresses were delivered over to Prince Michael, who shortly afterwards went to Constantinople to thank the sultan personally.

Prince Michael's policy had triumphed. But his success was short-lived. A group of young men, mostly educated in France and Germany, now started a liberal movement under the leadership of Yovan Ristich (or Ristitch). They wanted a more liberal constitution than that which Prince Michael had given; and this movement tended to qualify his popularity. Meanwhile the prince contemplated divorce from his wife Princess Julia, by whom he had no children, and marriage with the daughter of his cousin Madame Anka Constantinovitch; and the adherents of the exiled Karageorgevich dynasty were alarmed at the prospect of his eventually having legal heirs to the throne. A former private secretary to Prince Alexander Karageorgevich, and two of the same prince's brothers-in-law, formed a conspiracy, which resulted in the brutal assassination of Prince Michael on the 29th of May (June 10 (O.S.), 1868), whilst he was walking in the park of Koshutynak, a few miles distant from Belgrade. (C. M.)

MICHAELIS, JOHANN DAVID (1717-1791), German biblical scholar and teacher, a member of a family which had the chief part in maintaining that solid discipline in Hebrew and the

cognate languages which distinguished the university of Halle in the period of Pietism. Johann Heinrich Michaelis (1668-1738) was the chief director of A. H. Francke's *Collegium orientale theologicum*, a practical school of biblical and oriental philology then quite unique, and the author of an annotated Hebrew Bible and various exegetical works of reputation, especially the *Adnotationes sberiores in hagiographos* (1720). In his chief publications J. H. Michaelis had as fellow-worker his sister's son Christian Benedikt Michaelis (1680-1764), the father of Johann David, who was likewise influential as professor at Halle, and a sound scholar, especially in Syriac. J. D. Michaelis was trained for academical life under his father's eye. At Halle he was influenced, especially in philosophy, by Sigmund J. Baumgarten (1706-1757), the link between the old Pietism and J. S. Semler, while he cultivated his strong taste for history under Chancellor Ludwig. In 1739-1740 he qualified as university lecturer. One of his dissertations was a defence of the antiquity and divine authority of the vowel-points in Hebrew. His scholarship still moved in the old traditional lines, and he was also much exercised by religious scruples, the conflict of an independent mind with that submission to authority at the expense of reason encouraged by the Lutheranism in which he had been trained. A visit to England in 1741-1742 lifted him out of the narrow groove of his earlier education. In passing through Holland he made the acquaintance of Albert Schultens (1686-1750), whose influence on his philological views became all-powerful a few years later. At Halle Michaelis felt himself out of place, and in 1745 he gladly accepted an invitation to Göttingen as *privatdozent*. In 1746 he became professor extraordinary, in 1750 ordinarius, and in Göttingen he remained till his death in 1791.

His intellect was active in many directions; universal learning indeed was perhaps one of his foibles. Literature—modern as well as ancient—occupied his attention; one of his works was a translation of four parts of *Clarissa*; and translations of some of the then current English paraphrases on biblical books manifested his sympathy with a school which, if not very learned, attracted him by its freer air. His oriental studies were reshaped by diligent perusal of the works of Schultens; for the Halle school, with all its learning, had no conception of the principles on which a fruitful connexion between Biblical and Oriental learning could be established. His linguistic work indeed was always hampered by the lack of manuscript material, which is felt in his philological writings, e.g. in his valuable *Supplementum* to the Hebrew lexicons (1784-1792).¹ He could not become such an Arabist as J. J. Reiske (1716-1774); and, though for many years the most famous teacher of Semitic languages in Europe, he had little of the higher philological faculty, and neither his grammatical nor his critical work has left a permanent mark, with the exception perhaps of his text-critical studies on the Peshitta.² His tastes were all for such studies as history, antiquities, and especially geography and natural science. He had in fact started his university course as a *medicinae cultor*, and in his autobiography he half regrets that he did not choose the medical profession. In geography he found a field hardly touched since Samuel Bochart, in whose footsteps he followed in the *Spicilegium geographiae hebraeorum exterae post Bochartum* (1769-1780); and to his impulse we owe the famous Eastern expedition conducted by Carsten Niebuhr. In spite of his doctrinal writings—which at the time made no little noise, so that his *Compendium Dogmaticum* (1760) was confiscated in Sweden, and the knighthood of the North Star was afterwards given him in reparation—it was the natural side of the Bible that really attracted him, and no man did more to introduce the modern method of studying Hebrew antiquity as an integral part of ancient Eastern life.

The personal character of Michaelis can be read between the lines

of his autobiography with the aid of the other materials collected by J. M. Hassencamp (1743-1797) the editor (*J. D. Michaelis Lebensbeschreibung*, &c., 1793). The same volume contains a full list of his works. Besides those already mentioned it is sufficient to refer to his *New Testament Introduction* (the first edition, 1750, preceded the full development of his powers, and is a very different book from the later editions), his reprint of Robert Lowth's *Praelectiones* with important additions (1758-1762), his German translation of the Bible with notes (1773-1792), his *Orientalische und exegetische Bibliothek* (1775-1785) and *Neue O. und E. Bib.* (1786-1791), his *Mosaisches Recht* (1770-1771) and his edition of E. Castle's *Lexicon syriacum* (1770-1778). His *Litterarischer Briefwechsel* (1794-1796) contains much that is interesting for the history of learning in his time.

MICHAUD, JOSEPH FRANÇOIS (1767-1839), French historian and publicist, was born of an old family on the 19th of June 1767, at Albens, Savoy, was educated at Bourg-en-Bresse, and afterwards engaged in literary work at Lyons, where the events of 1789 first called out the strong dislike to revolutionary principles which manifested itself throughout the rest of his life. In 1791 he went to Paris, where, not without danger, he took part in editing several royalist journals. In 1796 he became editor of *La Quotidienne*, for his connexion with which he was arrested after the 13th of Vendémiaire; he succeeded in escaping his captors, but was sentenced to death *par contumace* by the military council. Having resumed the editorship of his newspaper on the establishment of the Directory, he was again proscribed on the 18th of Fructidor, but at the close of two years returned to Paris when the consulate had superseded the Directory. His Bourbon sympathies led to a brief imprisonment in 1800, and on his release he for the time abandoned journalism, and began to write or edit books. Along with his brother and two colleagues he published in 1806 a *Biographie moderne, ou dictionnaire des hommes qui se sont fait un nom en Europe depuis 1789*, the earliest work of its kind; and in 1811 appeared the first volume of his *Histoire des croisades* and also the first volume of his *Biographie universelle*. In 1814 he resumed the editorship of *La Quotidienne*, and in the same year was elected Academician. In 1815 his brochure entitled *Histoire des quinze semaines ou le dernier règne de Bonaparte* met with extraordinary success, passing through twenty-seven editions within a very short time. His political services were now rewarded with the cross of an officer in the Legion of Honour and the modest post of king's reader, of which last he was deprived in 1827 for having opposed Peyronnet's "Loi d'Amour" against the freedom of the Press. In 1830-1831 he travelled in Syria and Egypt for the purpose of collecting additional materials for the *Histoire des croisades*; his correspondence with a fellow explorer, J. J. F. Poujoulat, consisting practically of discussions and elucidations of various points in that work, was afterwards published (*Correspondance d'orient*, 7 vols., 1833-1835). Like the *Histoire*, it is more interesting than exact. The *Bibliothèque des croisades*, in four volumes more, contained the "Pièces justificatives" of the *Histoire*. Michaud died on the 30th of September 1839, at Passy, where his home had been since 1832.

His *Histoire des croisades* was published in its final form in six volumes in 1840 under the editorship of his friend Poujoulat (9th ed., with appendix, by Huillard-Bréholles, 1856). Michaud, along with Poujoulat, also edited *Nouvelle collection des mémoires pour servir à l'histoire de France* (32 vols., 1836-1844). See Sainte-Beuve, *Causeries du lundi*, vol. vii.

MICHAUX, ANDRÉ (1746-1802), French botanist and traveller, was born at Versailles on the 7th of March 1746. In 1779 he spent some time botanizing in England, and in 1780 he explored Auvergne, the Pyrénées and the north of Spain. In 1782 he was sent by the French government on a botanical mission to Persia. His journey began unfavourably, as he was robbed by Arabs of all his equipment except his books; but he gained influential support in Persia, having cured the shah of a dangerous illness. After two years he returned to France with a fine herbarium, and also introduced numerous Eastern plants into the botanic gardens of France. In 1785 he was sent by the French government to North America, and travelled with his son François André (1770-1855) through Canada,

¹ By a strange fortune of war it was the occupation of Göttingen by the French in the Seven Years War, and the friendly relations he formed with the officers, that procured him the Paris MS. from which he edited Abulfeida's description of Egypt.

² *Curae in actus apostolorum syriacos* (1755).

Nova Scotia and the United States. On his return to France in 1797 he was shipwrecked and lost most of his collections. In 1800 he went to Madagascar to investigate the flora of that island, and died there on the 16th of November 1802. His work as a botanist was chiefly done in the field, and he added largely to what was previously known of the botany of the East and of America.

He wrote two valuable works on North American plants—the *Histoire des chênes de l'Amérique septentrionale* (1801), with 36 plates, and the *Flora Boréal-Américaine* (2 vols., 1803), with 51 plates. His son François published a *Histoire des arbres forestiers de l'Amérique septentrionale* (3 vols., 1810-1813), with 155 plates, of which an English translation appeared in 1817-1819 as *The North American Sylva*.

MICHEL, CLAUDE, known as **CLODION** (1738-1814), French sculptor, was born on the 20th of December 1738 in Nancy. Here and probably in Lille he spent the earlier years of his life. In 1755 he came to Paris and entered the workshop of Lambert Sigisbert Adam, his maternal uncle, a clever sculptor. He remained four years in this workshop, and on the death of his uncle became a pupil of J. B. Pigalle. In 1759 he obtained the grand prize for sculpture at the Académie Royale; in 1761 he obtained the first silver medal for studies from models; and in 1762 he went to Rome. Here his activity was considerable between 1767 and 1771. Catherine II. was eager to secure his presence in St Petersburg, but he returned to Paris. Among his patrons, which were very numerous, were the chapter of Rouen, the states of Languedoc, and the *Direction générale*. His works were frequently exhibited at the Salon. In 1782 he married Catherine Flore, a daughter of the sculptor Augustin Pajou, who subsequently obtained a divorce from him. The agitation caused by the Revolution drove Clodion in 1792 to Nancy, where he remained until 1798, his energies being spent in the decoration of houses. Among Clodion's works are a statue of Montesquieu, a "Dying Cleopatra," and a chimney-piece at present in the South Kensington Museum. One of his last groups represented Homer as a beggar being driven away by fishermen (1810). On the 29th of March 1814 Clodion died in Paris, on the eve of the invasion of Paris by the allies.

Thirion's *Les Adam et Clodion* (Paris, 1885) contains a list of the sculptor's works sold between 1767 and 1884. See also A. Jacquot, *Les Adam et les Michel et Clodion* (Paris, 1898).

MICHEL, CLÉMENCE LOUISE (1830-1905), French anarchist, called *la Vierge rouge de Montmartre*, was born at the château of Vroncourt (Haute-Marne) on the 29th of May 1830, the daughter of a serving-maid, Marianne Michel, and the son of the house, Étienne Charles Demahis. She was brought up by her father's parents, and received a liberal education. After her grandfather's death in 1850 she was trained to teach, but her refusal to acknowledge Napoleon III. prevented her from serving in a state school. She found her way in 1866 to a school in the Montmartre quarter of Paris, where she threw herself ardently into works of charity and revolutionary politics. She became violently anti-Bonapartist, and is said to have meditated the assassination of Napoleon. During the siege of Paris she joined the ambulance service, and untiringly preached resistance to the Prussians. On the establishment of the Commune she joined the National Guard. She offered to shoot Thiers, and suggested the destruction of Paris by vengeance for its surrender. She was with the Communards who made their last stand in the cemetery of Montmartre, and was closely allied with Théodore Ferré, who was executed in November 1871. This ardent attachment was perhaps one of the sources of the exaltation which marked her career, and gave many handles to her enemies. When she was brought before the 6th council of war in December 1871 she defied her judges and defended the Commune. She was sent as a convict to New Caledonia, among her companions being Henri Rochefort, who remained her friend till the day of her death. The amnesty of 1880 found her revolutionary ardour unchanged. She travelled throughout France, preaching revolution, and in 1883 she led a Paris mob which pillaged a baker's shop. For this she was condemned to six years' imprisonment, but was released in 1886, at the same

time as Prince Kropotkin and other prominent anarchists. After a short period of freedom she was again arrested for making inflammatory speeches. She was soon liberated, but, hearing that her enemies hoped to intern her in a lunatic asylum, she fled to England. She returned to France in 1895, and in 1902 was back in London. She was touring France and lecturing on behalf of anarchist propaganda when she died at Marseilles on the 10th of January 1905.

Her *Mémoires* (Paris, 1886) contain accounts of her trials. See also *La Bonne Louise* (Paris, 1906), by E. Girault.

MICHEL, FRANCISQUE XAVIER (1809-1887), French antiquary, was born at Lyons on the 18th of January 1809. He became known for his editions of French works of the middle ages, and the French Government, recognizing their value, sent him to England (1833) and Scotland (1837) to continue his researches there. In 1839 he was appointed professor of foreign literature in the *Faculté des lettres* at Bordeaux. Between 1834 and 1842 he published editions of a large number of works written between the eleventh and fourteenth centuries in French, English and Saxon, including the *Roman de la rose* and the *Chanson de Roland*. Subsequently he published French translations of Goldsmith, Sterne, Shakespeare and Tennyson. He died in Paris on the 18th of May 1887.

His original works include *Histoire des races massides de la France et de l'Espagne* (1847); *Recherches sur le commerce pendant le moyen âge* (1852-1854); *Les Écossois en France et les français en Écosse* (1862); *Études de philologie comparée sur l'argot* (1856); *Le Pays basque* (1857); *Histoire du commerce et de la navigation à Bordeaux* (1867-1871); and, in conjunction with Edouard Fournier, *Histoire des hôteliers, cabarets, hôtels garnis* (1851-1854).

MICHELANGELO (MICHELANGELO BUONARROTI) (1475-1564), the most famous of the great Florentine artists of the Renaissance, was the son of Ludovico Buonarroti, a poor gentleman of that city, and of his wife Francesca dei Neri. The Buonarroti Simoni were an old and pure Florentine stock of the Guelph faction: in the days of Michelangelo's fame a connexion of the family with the counts of Canossa was imagined and admitted on both sides, but has no foundation in fact. Ludovico was barely able to live on the income of his estate, but made it his boast that he had never stooped to add to it by mercantile or mechanical pursuits. The favour of the Medici procured him temporary employment in minor offices of state, among them that of podestà or resident magistrate for six months, from the autumn of 1474, at Castello di Chiusi and Caprese in the Casentino. At Caprese, on the 6th of March 1475, his second son Michelagnolo or Michelangelo was born. Immediately afterwards the family returned to Florence, and the child was put to nurse with a marble-worker's wife of Settignano. His mother's health had already, it would seem, begun to fail; at all events in a few years from this time, after she had borne her husband three more sons, she died. While still a young boy Michelangelo determined, in spite of his father's opposition, to be an artist. He had sucked in the passion, as he himself used to say, with his foster-mother's milk. After a sharp struggle his stubborn will overcome his father's pride of gentility, and at thirteen he got himself articled as a paid assistant in the workshop of the brothers Ghirlandaio. Domenico Ghirlandaio, bred a jeweller, had become by this time the foremost painter of Florence. In his service the young Michelangelo laid the foundations of that skill in fresco which twenty years afterwards he confounded his detractors at Rome. He studied also, like all the Florentine artists of that age, in the Brancacci chapel, where the frescoes of Masaccio, painted some sixty years before, still victoriously held their own; and here, in reply, to a taunt he had flung at a fellow-student, Torrigiano, he received the blow on the nose which disfigured him to his dying day.

Though Michelangelo's earliest studies were directed towards painting, he was by nature and predilection much more inclined to sculpture. In that art he presently received encouragement and training under the eye of an illustrious patron, Lorenzo dei Medici. On the recommendation, it is said, of Ghirlandaio, he was transferred, before the term of his apprenticeship as

a painter had expired, to the school of sculpture established by Lorenzo in the Medici gardens. Here he could learn to match himself against his great predecessor, Donatello, one of whose pupils and assistants, the aged Bertoldo, was director of the school, and to compare the works of that master and his Tuscan contemporaries with the antiques collected for the instruction of the scholars. Here, too, he could listen to discourses on Platonism, and steep himself in the doctrines of an enthusiastic philosophy which sought to reconcile with Christian faith the lore and the doctrines of the Academy. Michelangelo remained a Christian Platonist to the end of his days; he was also from his youth up a devoted student of Dante. His powers of mind and hand soon attracted attention, and secured him the regard and favour of his patrons in spite of his rugged exterior and scornful unsocial temper.

Michelangelo had been attached to the school and household of the Medici for barely three years when, in 1492, his great patron Lorenzo died. Lorenzo's son Piero dei Medici inherited the position but not the qualities of his father; Florence soon chafed under his authority; and towards the autumn of 1494 it became apparent that disaster was impending over him and his adherents. Michelangelo was constitutionally subject to dark and sudden presentiments: one such seized him now, and without awaiting the popular outbreak, which soon followed, he took horse with two companions and fled to Bologna. There, being now in his twentieth year, he was received with kindness by a member of the Aldovrandi family, on whose commission he executed two figures of saints and one of an angel for the shrine of St Dominic in the church of St Petronius. After about a year, work at Bologna failing, and his name having been included in his absence on the list of artists appointed to provide a new hall of assembly for the great council of Florence, Michelangelo returned home. The strange theocracy established by Savonarola was now in force, and the whole character of civic life at Florence was for the time being changed. The influence of the fervent Dominican upon the mind and character of the young Michelangelo became as profound as that of the Platonists and of Dante. He was not left without employment. He found a friend in another Lorenzo, the son of Pierfrancesco dei Medici, for whom he at this time executed a statue of the boy St John. Having also carved a recumbent Cupid in imitation of the antique, it was suggested to him by the same patron that it should be so tinted and treated as to look like a real antique, and sold accordingly. Without increasing the price he put upon the work, Michelangelo for amusement lent himself to the counterfeit, and the piece was then actually sold for a large sum, as a genuine work of antiquity, to a Roman collector, Raffaele Riario, cardinal di San Giorgio; the dealer appropriating the profits. When the cardinal discovered the fraud he caused the dealer to refund; but as to Michelangelo himself, it was represented to the young sculptor that if he went to Rome the amateur who had just involuntarily paid so high a tribute to his skill would certainly befriend him. He set forth accordingly, and arrived at Rome for the first time at the end of June 1496. Such hopes as he may have entertained of countenance from the cardinal di San Giorgio were quickly dispelled. Neither did the banished Piero dei Medici, who also was now living at Rome, do anything to help him. On the other hand Michelangelo won the favour of a Roman nobleman, Jacopo Galli, and through him of the French cardinal Jean de Villiers de la Grolaie, abbot of St Denis. From the former he received a commission for a "Cupid" and a "Bacchus," from the latter for a "Pietà" or "Mary lamenting over the body of Christ"—works of which the two last named only are preserved. Equal originality of conception and magnificence of technical execution mark the two contrasted subjects—one as noble and the other as nearly ignoble as anything Michelangelo ever did—of the mother with the dead son on her lap, indicating with a contained but eloquent gesture of her left hand a tragedy too great for outcries, and the titubant sensual young wine-god (a condition in which ancient art would never have exhibited the god himself, but only his satellites).

Michelangelo's stay in Rome at this time lasted five years—from the summer of 1496 till that of 1501. The interval had been one of extreme political distraction at Florence. The excitement of the French invasion, the mystic and ascetic regimen of Savonarola, the reaction which led to his overthrow, and finally the external wars and internal dissidences which preceded a new settlement, had all created an atmosphere most unfavourable to art. Nevertheless Ludovico Buonarroti, who in the troubles of 1494 had lost a small permanent appointment he held in the customs, and had come to regard his son Michelangelo as the mainstay of his house, had been repeatedly urging him to come home. A spirit of family duty and family pride was the ruling principle in all Michelangelo's conduct. During the best years of his life he submitted himself sternly and without a murmur to pinching hardship and almost superhuman labour for the sake of his father and brothers, who were ever selfishly ready to be fed and helped by him. Having now, after an illness, come home in 1501, Michelangelo was requested by the cardinal Francesco Piccolomini to adorn with a number of sculptured figures a shrine already begun in the cathedral of Siena in honour of the most distinguished member of his house, Pope Pius II. Four only of these figures were ever executed, and those not apparently, or only in small part, by the master's hand. A work of greater interest in Florence itself had diverted him from his engagement to his Siennese patrons. This was the execution of the famous colossal statue of David, popularly known as "the Giant." It was carved out of a huge block of marble on which another sculptor, Agostino d'Antonio, had begun unsuccessfully to work forty years before, and which had been lying idle ever since. Michelangelo had here a difficult problem before him. Without much regard to the traditional treatment of the subject or the historical character of his hero, he carved out of the vast but cramped mass of material an adolescent, frowning colossus, tensely watchful and self-balanced in preparation for his great action. The result amazed every beholder by its freedom and science of execution and its victorious energy of expression. All the best artists of Florence were called in council to determine on what site it should be set up, and after much debate the terrace of the palace of the Signory was chosen, in preference to the neighbouring Loggia dei Lanzi. Here accordingly the colossal "David" of Michelangelo took, in the month of May 1504, the place which it continued to hold until in 1882 it was removed for the sake of protection to a hall in the Academy of Fine Arts, where it inevitably looks crushed and cabined. Other works of sculpture belong to the same period: among them a second "David," in bronze and on a smaller scale, commissioned by the *maréchal* Pierre Rohan and left by the young master to be finished by Benedetto da Rovezzano, who despatched it to France in 1508; a great rough-hewn "St Matthew" begun but never completed for the cathedral of Florence; a "Madonna and Child" executed on the commission of a merchant of Bruges; and two unfinished bas-reliefs of the same subject.

Neither was Michelangelo idle at the same time as a painter. Leaving disputed works for the moment out of sight, he in these days at any rate painted for his and Raphael's common patron, Angelo Doni, the "Holy Family" now in the Uffizi at Florence. In the autumn of 1504, the year of the completion of the "David," he received from the Florentine state a commission for a work of monumental painting on a heroic scale. Leonardo da Vinci had been for some months engaged on his great cartoon of the "Battle of Anghiari," to be painted on the wall of the great hall of the municipal council. The gonfaloniere Piero Soderini now procured for Michelangelo the commission to design a companion work. Michelangelo chose an incident at the battle of Cascina during the Pisan war of 1364, when the Florentine soldiery had been surprised by the enemy in the act of bathing. He dashed at the task with his accustomed fiery energy, and had carried a great part of the cartoon to completion when, in the early spring of 1505, he broke off the work in order to obey a call to Rome which reached him from Pope Julius II. His unfinished cartoon, in its power over the varieties and contrasts

of energetic and vitally significant action, showed how greatly Michelangelo had profited by the example of his elder rival, Leonardo, little as, personally, he yielded to Leonardo's charm or could bring himself to respond to his courtesy. The work of Michelangelo's youth is for the most part comparatively tranquil in character. His early sculpture, showing a degree of science and perfection unequalled since the antique, has also something of the antique serenity. It bears strongly the stamp of intellectual research, but not by any means that of storm or strain. In the cartoon of the "Bathers" the qualities afterwards proverbially associated with Michelangelo—his *furia*, his *terribilità*, the tempest and hurricane of the spirit which accompanied his unequalled technical mastery and knowledge—first found expression.

With Michelangelo's departure to Rome early in 1505 the first part of his artistic career may be said to end. It will be convenient here to recapitulate its principal results in sculpture and painting, both those preserved and those recorded but lost.

SCULPTURE.—*Florence, 1489-1494.*—"Head of a Faun," marble; lost. Condivi describes Michelangelo's essay in sculpture as a head of an angel with a front tooth knocked out, this latter point having been an afterthought suggested by Lorenzo dei Medici. The head is sometimes identified with one in the National Museum at Florence, which however bears no marks of Michelangelo's early style and is in all probability spurious.—"Madonna seated on a Step," bronze; Casa Buonarroti, Florence. This bas-relief, executed in imitation of the technical style of Donatello, is a genuine example of Michelangelo's early work in the Medicean school under Bertoldo.—"Centauromachia," marble; Casa Buonarroti. A fine and genuine work in full relief of probably somewhat date than the last-mentioned. The subject occurs often in ancient sarcophagus reliefs: Michelangelo has followed the antique in his conception and treatment of the nude, but the arrangement of the subject is his own.

Bologna, 1495-1495.—"Statuettes of St Petronius," "St Proculus," and a "Kneeling Angel," marble; part of the decorations of the shrine of St Dominic in the church of that saint at Bologna: the style of all three much influenced by the work of Jacopo della Quercia in the same church; the attitude of the kneeling angel with the candelabrum imitated from an ancient bas-relief.

Florence, 1495-1495.—"St John in the Wilderness," executed for Lorenzo di Pierfrancesco dei Medici, marble; probably lost. Declared in 1874 to have been found again in the possession of Count Gualandi-Rossalmi at Pisa. Vehement and prolonged discussion arose as to the authenticity of this newly-found S. Giovanni, and at last it was bought for the Berlin Museum, where its genuineness is still stoutly maintained. But the fawning and affected elegance of the conception denote a different temperament from Michelangelo's and probably a later date. With this figure must be given up also the restoration of an antique group of "Bacchus and Ampelus" at the Uffizi, which is clearly by the same hand and is claimed also as an early work of Michelangelo.—"Reclining Cupid," bought by the cardinal San Giorgio as an antique, marble; lost. The attempts to recognize it in certain extant copies or servile imitations of the antique, especially one now at Turin, must be held mistaken.

Rome, 1495-1501.—"Virgin lamenting the dead Christ," commissioned by the abbot de la Grolaie; marble; St Peter's, Rome.—"Bacchus and young Faun," commissioned by Jacopo Galli; marble, National Museum, Florence. (Of these two masterpieces of Michelangelo's youth enough has been said above.)—"Cupid," commissioned by the abbot de la Grolaie; marble; lost; has been conventionally identified as the "Kneeling Cupid" of the Victoria and Albert Museum, but this, if by Michelangelo at all, which is not quite certain, must in all likelihood belong to a later time.

Florence, 1501-1506.—"Five Saints, in niches decorating the shrine of Pius II.," commissioned by the Piccolomini family; marble; cathedral of Siena. The contract for the sculptured decoration of this shrine was one of those which the pressure of other work prevented the artist from ever taking seriously in hand. Of the five saints in niches, traditionally supposed to be his work, the St Peter alone shows any clear marks of his style; the other four were probably designed, and certainly carried out, by weaker hands.—"David" (the "Gigante"), commissioned for the city of Florence by Piero Soderini; marble; Florence Academy. Besides what has been said above, it has only to be added that a wax model in the Casa Buonarroti, showing nearly the same design with a different movement of the legs, is probably Michelangelo's original sketch for the subject.—"David," commissioned by Pierre Rohan; bronze, lost; a clay model in the National Museum, Florence, may probably be a sketch for it: more than one bronze has been brought forward with claims to be the original, but none has stood the test of criticism.—"Virgin and Child," commissioned for Taddeo Taddei; circular relief, unfinished, marble; London, Royal Academy. The motive of the Christ-child frightened by the flutterings of the bird held out by St John is the most playful in all Michelangelo's work; the whole design shows the influence of Leonardo in his gentler, as much as the cartoon of the "Bathers" shows it in his more violent, moods.

"Virgin and Child with St John," commissioned by Bartolommeo Pitti; nearly circular relief, unfinished, marble; Florence, National Museum: a more tranquil and very charming presentment.—"Madonna and Child," sold to the Mouscron family of Bruges (known in Italy as Moscheroni), and by them presented to the church of Notre Dame in that city; group in the round, marble; church of Notre Dame, Bruges. A meditative seated Virgin with upright head, the naked child seated between her knees, his smoothly rounded form in strong contrast with her complicated draperies.—"St Matthew": one of a set of twelve statues of Apostles commissioned by the consuls of the Arte della Lana for the cathedral at Florence; marble; National Museum, Florence. Unfinished (only roughly blocked out), the other figures of the set never having been so much as begun; the contract was signed in 1503 and cancelled in 1505. There is an early drawing by Raphael from this statue.

PAINTING.—"Holy Family," painted for Angelo Doni; tempera, circular; Florence, Uffizi. The only perfectly well-attested panel-painting of Michelangelo which exists. His love of restless and same-pointed, what strained actions is illustrated by the gesture of the Madonna, who kneels on the ground holding up the child on her right shoulder; his love of the nude by the introduction (wherein he follows Luca Signorelli) of some otherwise purposeless undraped figures in the background.—"Virgin and Child with Four Angels"; tempera; National Gallery, London. This unfinished painting, strongly marked by the influence of Michelangelo in his work at this period, has been confidently claimed for him, but lacks his strength and mass, and is as far more probably the work of his imitator and intimate associate, Francesco Granacci. "Cartoon of the Bathers," lost and utterly perished. The only authentic records of it are contained in a few early engravings by Marcantonio and Agostino Veneziano and a certain number of sketches and studies by the master himself, chiefly at the Albertina, Vienna, the British Museum and the University Galleries, Oxford. An elaborate drawing of many figures at Holkham Hall, well known and often engraved, seems to be a later *cento* destitute of real authority.

Michelangelo had not been long in Rome before Pope Julius devised fit employment for him. That capacious and headstrong spirit, on fire with great enterprises, had conceived the idea of a sepulchral monument to commemorate his glory when he should be dead, and to be executed according to his own plans while he was still living. He entrusted this congenial task to Michelangelo. The design being approved, the artist spent the winter of 1505-1506 at the quarries of Carrara, superintending the excavation and shipment of the necessary marbles. In the spring he returned to Rome, and when the marbles arrived fell to with all his energy at the preparations for the work. For a while the pope followed their progress eagerly, and was all kindness to the young sculptor. But presently his disposition changed. In Michelangelo's absence an artist who was no friend of his, Bramante of Urbino, had been selected by Julius to carry out a new architectural scheme, commensurate with the vast vastness of his conceptions, viz. the rebuilding of St Peter's church. To the influence and the malice of Bramante Michelangelo attributed the unwelcome invitation he now received to interrupt the great work of sculpture which he had just begun in order to decorate the Sistine chapel with frescoes. Soon, however, schemes of war and conquest interposed to divert the thoughts of Julius, not from the progress of his own monument merely, but from artistic enterprises altogether. One day Michelangelo heard him say at table to his jeweller that he meant to spend no more money on pebbles, either small or great. To add to the artist's discomfiture, when he went to apply in person for payments due, he was first put off from day to day, and at last actually with scant courtesy dismissed. At this his dark mood got the mastery of him. Convinced that not his employment only but his life was threatened, he suddenly took horse and left Rome, and before the messengers of the pope could overtake him was safe on Florentine territory. Michelangelo's flight took place in April 1506. Once among his own people, he turned a deaf ear to all overtures made from Rome for his return, and stayed throughout the summer at Florence, how occupied we are not distinctly informed, but apparently, among other things, on the continuation of his great battle cartoon.

During the same summer Julius planned and executed the victorious military campaign which ended with his unopposed entry at the head of his army into Bologna. Thither, under strict safe-conduct and promises of renewed favour, Michelangelo

was at last persuaded to betake himself. Julius received the truant artist kindly, as indeed between these two volcanic natures there existed a natural affinity, and ordered of him his own colossal likeness in bronze, to be set up, as a symbol of his conquering authority, over the principal entrance of the church of St Petronius. For the next fifteen months Michelangelo devoted his whole strength to this new task. The price at which he undertook it left him, as it turned out, hardly any margin to subsist on. Moreover in the technical art of metal casting he was inexperienced, and an assistant whom he had summoned from Florence proved insubordinate and had to be dismissed. Nevertheless his genius prevailed over every hardship and difficulty, and on the 21st of February 1508 the majestic bronze colossus of the seated pope, robed and mitred, with one hand grasping the keys and the other extended in a gesture of benediction and command, was duly raised to its station over the church porch. Three years later it was destroyed in a revolution. The people of Bologna rose against the authority of Julius; his delegates and partisans were cast out, and his effigy hurled from its place. The work of Michelangelo, after being trailed in derision through the streets, was broken up and its fragments cast into the furnace.

Meanwhile the artist himself, as soon as his work was done, had followed his reconciled master back to Rome. The task that here awaited him, however, was after all not the resumption of the papal monument, but the execution of the series of paintings in the Sistine chapel which had been mooted before his departure. Painting, he always averred, was not his business; he was aware of his enemy's hopes that a great enterprise in fresco-painting would prove beyond his powers; and he entered with misgiving and reluctance upon his new undertaking. Destiny, however, so ruled that the work thus thrust upon him remains his chief title to glory. His history is one of indomitable will and almost superhuman energy, yet of will that hardly ever had its way, and of energy continually at war with circumstance. The only work which in all his life he was able to complete as he had conceived it was this of the decoration of the Sistine ceiling. The pope had at first desired a scheme including figures of the twelve apostles only. Michelangelo began accordingly, but could rest content with nought so meagre, and soon proposed instead a design of many hundred figures embodying the story of Genesis from the Creation to the Flood, with accessory personages of prophets and sibyls dreaming on the new dispensation to come, and, in addition, those of the forefathers of Christ. The whole was to be enclosed and divided by an elaborate framework of painted architecture, with a multitude of nameless human shapes supporting its several members or reposing among them—shapes mediating, as it were, between the features of the inanimate framework and those of the great dramatic and prophetic scenes themselves. The pope bade the artist do as he pleased. By May 1508 the preparations in the chapel had been completed and the work begun. Later in the same year Michelangelo summoned a number of assistant painters from Florence. Trained in the traditions of the earlier Florentine school, they were unable, it seems, to interpret Michelangelo's designs in fresco either with sufficient freedom or sufficient uniformity of style to satisfy him. At any rate he soon dismissed them, and carried out the remainder of his colossal task alone, except for the necessary amount of purely mechanical and subordinate help. The physical conditions of prolonged work, face upwards, upon this vast expanse of ceiling were adverse and trying in the extreme. After four and a half years of toil the task was accomplished. Michelangelo had during its progress been harassed alike by delays of payment and by hostile intrigue, his ill-wishers casting doubts on his capacity, and vaunting the superior powers of Raphael. That gentle spirit would by nature have been no man's enemy, but unluckily Michelangelo's moody, self-concentrated temper prevented the two artists being on terms of amity such as might have stopped the mouths of mischief-makers. Absolute need of funds for the furtherance of the undertaking constrained him at one moment to break off work and pursue his inconsiderate patron

as far as Bologna. This was between September 1510, by which time the whole of the great series of subjects along the centre of the vault were completed, and January 1511, when the master set to work again and began filling the complicated lateral spaces of his decorative scheme.

The main field of the Sistine ceiling—in form a depressed barrel vault—is divided in Michelangelo's scheme into four larger, alternating with five smaller fields. The following is the order of the subjects depicted in them: (1) the dividing of the light from the darkness; (2) the creation of sun, moon and stars; (3) the creation of the waters; (4) the creation of man; (5) the creation of woman; (6) the temptation and expulsion; (7) the sacrifice of Noah; (8) the deluge; (9) the drunkenness of Noah. The figures in the last three of these scenes are on a smaller scale than those in the first six. In numbers 1, 3, 5, 7 and 9 the field of the picture is reduced by the encroachments of the architectural framework with its seated pairs of supporters, commonly known as "Slaves" or "Atlases." Flanking these smaller compositions, along the lateral spaces between the crown of the vault and the walls on either side, are seated figures of prophets and sibyls alternately; two other prophets are introduced at each extremity of the series—making seven prophets and five sibyls in all. In the triangles to right and left of the prophets at the two extremities are the death of Goliath, the death of Holofernes, the brazen serpent and the punishment of Haman. In the twelve lunettes above the windows are groups of the ancestors of Christ, their names designated by inscriptions, and in the twelve triangles above them (between the prophets and sibyls) other kindred groups crouched or sitting. These last are all shown in relatively simple human actions and household relations, heightened but not falsified by the artist's genius and rising into majestic significance from roots deep in daily human nature. The work represents all the powers of Michelangelo at their best. Disdaining all the accessory allurements of the painter's art, he has concentrated himself upon the exclusive delineation of the human form and face at their highest power. His imagination has conceived, and his knowledge and certainty of hand have enabled him to realize, attitudes and combinations of unmatched variety and grandeur, and countenances of unmatched expressiveness and power. But he has not trusted, as he came later to trust, to science and acquired knowledge merely; neither do his personages, so far as they did afterwards, transcend human possibility or leave the facts of actual life behind them. The profoundest knowledge and the most searching realism serve to embody all this inspiration and sustain all this sublimity; the sublimity, moreover is combined with the noblest elements of grace and even of tenderness. As for the intellectual meanings of his vast design, over and above those which reveal themselves at a first glance or by a bare description, they are from the nature of the case inexhaustible, and can never be perfectly defined. Whatever the soul of this great Florentine, the spiritual heir of Dante, with the Christianity of the middle ages not shaken in his mind, but expanded and transcendentalized, by the knowledge and love of Plato;—whatever the soul of such a man, full of suppressed tenderness and righteous indignation, and of anxious questionings of coming fate could conceive—that Michelangelo has expressed or shadowed forth in this great and significant scheme of paintings. The powers of the artist seem to have expanded with the progress of his work. He seems to have begun (as the spectator entering the chapel has to begin) with what is chronologically the last subject of the series, the drunkenness of Noah, and to have worked backwards, increasing the scale of his figures for their better effect from the fourth subject (the Temptation and Expulsion), and rising in ascending scale of majesty through the successive acts of creation from the last to the first.

The Sistine chapel was no sooner completed than Michelangelo resumed work upon the marbles for the monument of Julius. But four months only had passed when Julius died. His heirs immediately entered (in the summer of 1513) into a new contract with Michelangelo for the execution of the monument on a reduced scale. What the precise nature and extent of the original design had been we do not know, only that the monument was to be detached from the wall, and to stand four-square and free—a thing hitherto unknown in Renaissance sepulchral architecture—in one of the chapels of St Peter's. But the new design was extensive and magnificent enough. It was to consist of a great three-sided structure, two courses high, projecting from the church wall, and decorated on its three unattached sides with statues. On the upper course was to be placed the colossal recumbent figures of the pope, with a vision of the Virgin and Child above him, angels mourning at the sides, and prophetic and allegoric personages at the angles—sixteen figures in all. The lower course was to be enriched with twenty-four figures in niches and on projecting pedestals: in the niches, Victories; in front of terminal pilasters between them,

slaves or captives denoting, it would seem, either conquered provinces or arts and sciences in bondage after their patron's death. A much injured and not indisputable sketch by the master at Berlin, with a copy of the same by Sacchetti, are supposed to show the design at this stage of its reduction. The entire work was to be completed in nine years' time. During the next three years, it would seem, Michelangelo brought to completion three at least of the promised figures, for which the blocks had reached Rome from Carrara as early as July 1508; and they are among the most famous of all existing works of the sculptor's art—namely, the "Moses," now in the church of S. Pietro in Vincoli at Rome and the two "Slaves" at the Louvre.

The "Moses," originally intended for one of the angles of the upper course, is now placed at the level of the eye, in the centre of the principal face of the monument as it was at last finished, on a deplorably reduced and altered scale, by Michelangelo and his assistants in his old age. The prophet, supposed to have just come down from Mount Sinai and found the Israelites worshipping the golden calf, sits, heavily bearded and draped, with only his right arm bare, his left foot drawn back, his head raised and turned to the left, his left hand laid on his lap and his right grasping the tables of the law—an incarnation of majestic indignation and menace. The work, except in one or two places, is of the utmost finish, and the statue looks like one of the prophets of the Sixtine ceiling done in marble. The "Slaves" at the Louvre are youthful male figures of equally perfect execution, nude but for the band which passes over the breast of one and the right leg of the other. One, with his left hand raised to his head and his right pressed to his bosom, his eyes most closed, seems succumbing to the agonies of death; the other, with his arms bound behind his back, looks upward still hopelessly struggling. All three of these figures were finished between 1513 and 1516.

By 1516 Michelangelo's evil star was again in the ascendant. Julius II. had been succeeded on the papal throne by Cardinal Giovanni de' Medici under the title of Leo X. The Medici, too, had about the same time by force and fraud re-established their sway in Florence, overthrowing the free institutions that had prevailed there since the days of Savonarola. Now, on the one hand, this family were the hereditary friends and patrons of Michelangelo; on the other hand he was a patriotic son of republican Florence; so that henceforward his personal allegiance and his political sympathies were in conflict. Over much of his art, as has been thought, the pain and perplexity of this conflict have cast their shadow. For the present the consequence to him of the rise to power of the Medici was a fresh interruption of his cherished work on the tomb of Julius. Leo X. and his kinsmen were full of a vast new scheme for the enrichment and adornment of the façade of their own family church of San Lorenzo in Florence. Michelangelo, carried away by the idea and forgetful of his other still great and onerous task, offered his services for the new façade. They were eagerly accepted, although for a moment the idea had been entertained of entrusting the work to Leonardo da Vinci. The heirs of Julius on their part showed an accommodating temper, and at the request of Leo allowed their three-years-old contract to be cancelled in favour of another, whereby the scale and sculptured decorations of the Julian monument were again to be reduced by nearly a half. Michelangelo soon produced for the San Lorenzo façade a design of combined sculpture and architecture as splendid and ambitious in its way as had been that for the original monument of Julius. The contract was signed in January 1518, and the artist went to Carrara to superintend the excavation of the marbles.

Michelangelo was now in his forty-fourth year. Though half his life was yet to come, yet its best days had, as it proved, been spent. All the hindrances which he had encountered hitherto were as nothing to those which began to beset him now. For the supply of materials for the façade of San Lorenzo he had set a firm of masons to work, and had himself, it seems, entered into a kind of partnership with them, at Carrara, where he knew the quarries well, and where the industry was hereditary and well understood. When all was well in progress there under his own eye, reasons of state induced the Medici and the Florentine magistracy to bid him resort instead to certain new quarries

at Pietrasanta, near Serravalle in the territory of Florence. Hither, to the disgust of his old clients at Carrara and to his own, Michelangelo accordingly had to transfer the scene of his labours. Presently he found himself so impeded and enraged by the mechanical difficulties of raising and transporting the marbles, and by the disloyalty and incompetence of those with whom he had to deal, that he was fain to throw up the commission altogether. The contracts for the façade of San Lorenzo were rescinded in March 1518, and the whole magnificent scheme came to nothing. Michelangelo then returned to Florence, where proposals of work poured in on him from many quarters. The king of France desired something from his hand to place beside the two pictures he possessed by Raphael. The authorities of Bologna wanted him to design a façade for their church of St Petronius; those of Genoa to cast a statue in bronze of their great commander, Andrea Doria. Cardinal Grimani begged hard for any picture or statue he might have to spare; other amateurs imported him for so much as a pencil drawing or sketch. Lastly his friend and partisan Sebastian del Piombo at Rome, ever eager to keep up the feud between the followers of Michelangelo and those of Raphael, besought him on Raphael's death to return at once to Rome, and take out of the hands of the dead master's pupils the work of painting still remaining to be done in the Vatican chambers. Michelangelo complied with none of these requests. All that we certainly know of his doing between 1518 and 1522 is the blocking out in the rough of four more of the "Slaves" for the tomb of Julius, and carrying out a commission, which he had received from three citizens of Rome as early as 1514, for a statue of the risen Christ. The roughed-out "Slaves" now stand immured in a grotto in the Boboli Gardens, Florence; the Christ, practically finished by the master but with the last touches added by pupils, stands in the church, for which it was destined, of Sta Maria sopra Minerva at Rome; there is little in it either of devotional spirit or imaginative power, although, in those parts which Michelangelo himself finished, there is extreme accomplishment of design and workmanship.

The next twelve years of Michelangelo's life (1522-1534) were spent at Florence, and again employed principally in the service of his capricious and uncongenial patrons—the Medici. The plan of a great group of monuments to deceased members of this family, to be set up in a new sacristy or mortuary chapel in San Lorenzo, was first broached to Michelangelo in 1520 by Cardinal Giulio de' Medici. No practical impulse, however, was given to the work until Giulio, after the death of Leo X. and the brief pontificate of the puritanical and iconoclastic Adrian VI., had in his turn become pope in 1523 under the title of Clement VII. Even then the impulse was a wavering one. First Clement proposed to associate another artist, Sansovino, with Michelangelo in his task. This proposal being on Michelangelo's peremptory demand abandoned, Clement next distracted the artist with an order for a new architectural design—that, namely, for the proposed Medicean or "Laurentian" library. When at last after many changes of scope and scheme the plans for the sepulchral chapel or "Sagrestia nuova" took shape, they did not include, as had been at first intended, memorials to the founders of the house's greatness, Cosimo (*pater patriæ*) and Lorenzo the Magnificent, or even to Pope Leo X. himself, but only to two younger members of the house lately deceased, Giuliano, duke of Nemours, and Lorenzo, duke of Urbino. Michelangelo brooded long over various designs for this work, and was still engaged on its execution—his time being partly also taken up by the building-plans for the Medicean library—when political revolutions interposed to divert his industry. In 1527 came to pass the sack of Rome by the Austrians, and the apparently irrevocable ruin of Pope Clement. The Florentines seized the occasion to expel the Medici from their city, and set up a free republican government once more. Naturally no more funds for the works in San Lorenzo were forthcoming, and Michelangelo, on the invitation of the new signory, occupied himself for a while with designs for a group of Hercules and Cacus, and another of Samson

and the Philistines—the latter to be wrought out of a block of marble which had been rough-hewn already for another purpose by Baccio Bandinelli. Soon, however, he was called to help in defending the city itself from danger. Clement and his enemy Charles V. having become reconciled, both alike were now bent on bringing Florence again under the rule of the Medici. In view of the approaching siege, Michelangelo was appointed engineer-in-chief of the fortifications. He spent the early summer of 1529 in strengthening the defences of San Miniato; from July to September he was absent on a diplomatic mission to Ferrara and Venice. Returning in the middle of the latter month, he found the cause of Florence hopeless from internal treachery and from the overwhelming strength of her enemies. One of his dark seizures overcame him, and he departed again suddenly for Venice. There for a while he remained, negotiating for a future residence in France. Then, while the siege was still in progress, he returned once more to Florence; but in the final death-struggle of her liberties he bore no part. When in 1530 the city submitted to her conquerors, no mercy was shown to most of those who had taken part in her defence. Michelangelo believed himself in danger with the rest, but on the intervention of Baccio Valori he was presently taken back into favour and employment by Pope Clement. For four years more he continued to work at intervals on the completion of the Medici monuments, with the help from 1532 of Giovanni Montorsoli and other pupils, and on the building of the Laurentian library. In 1531 he suffered a severe illness; in 1532 he made a long stay at Rome, and entered upon yet another contract for the completion of the Julian monument, to be reduced now to a still more shrunken scale and to be placed not in St Peter's but in the church of San Pietro in Vincoli. In the autumn of 1534 he left Florence for good. What remained to be done in the Medici chapel was done by pupils, and the chapel was not finally opened to view until 1545.

The statues of the Medici monument take rank beside the "Moses" and the "Slaves" as the finest work of Michelangelo's central time in sculpture. They consist of a Madonna and Child, and of the two famous monumental groups, each composed of an armed and seated portrait-statue in a niche, with two emblematic figures reclining on each side of a sarcophagus below. The "Madonna and Child" (left unfinished because the marble was short in bulk) combines astonishingly the divers qualities of realistic motive and natural animation with learned complexity of design and imposing majesty of effect. It was set up finally—not at all in accordance with the artist's first intention—against a blank wall of the chapel, and flanked at wide intervals by statues of Sts Cosmo and Damian, the work of pupils. The portraits are treated not realistically but typically. In that of Lorenzo seems to be typified the mood of crafty brooding and concentrated inward thought; in that of Giuliano, the type of alert and confident practical survey immediately preceding action. To this contrast of the meditative and active characters corresponds a contrast in the emblematic groups accompanying the portraits.

At the feet of the duke Giuliano recline the shapes of "Night" and "Day"—the former a female, the latter a male personification; the former sunk in an attitude of deep but uneasy slumber, the latter (whose head and face are merely blocked out of the marble) lifting himself in one of wrathful and disturbed awakening. But for Michelangelo's unflinching grandeur of style, and for the sense which his works convey of a compulsive heat and tempest of thought and feeling in the spirit that thus conceived them, both these attitudes might be charged with extravagance. As grand, but far less violent, are those of the two companion figures that recline between sleep and waking on the sarcophagus of the pensive Lorenzo. Of these, the male figure is known as "Evening," the female as "Morning" (*Crepusculo* and *Aurora*). In Michelangelo's original idea, partly founded on antique precedent in pedimental and sarcophagus groups, figures of "Earth" and "Heaven" were to be associated with those of "Night" and "Day" on the monument of Giuliano, and others—no doubt of a corresponding nature, with those of the Morning and Evening Twilight on that of Lorenzo. These figures afterwards fell out of the scheme and the recesses designed for them remain empty. Michelangelo's obvious and fundamental idea was, as some words of his own record, to exhibit the elements and the powers of earth and heaven lamenting the death of the princes. River-gods were to recline on the broad bases at the foot of the monuments. These too are lacking. They were never finished, but a bronze cast from a small model of one of them, and the torso of a large model, have lately been identified, the former in the National Museum and the latter in the Academy at Florence.

Other works of 1522-1534.—"Victory" marble (National Museum, Florence). A youthful conqueror standing over a bearded enemy,

whose shoulders he crushes down with his left knee. Fine and finished work; whether intended for one of the emblematic Victories of the Julian monument, or having some connexion with the "Hercules and Cacus" and "Samson and the Philistine," subjects undertaken for the Signory in 1528, must remain uncertain. For the former of these two subjects a wax model at the Victoria and Albert Museum, for the latter a plaster model at the Casa Buonarroti, are claimed, perhaps rightly as original. "David" (formerly called "Apollo"), marble, unfinished (National Museum, Florence). Both the authenticity and the approximate date of this fine work are beyond doubt; of its origin and destination we are unformed. "Crouching boy," marble, unfinished (the Hermitage, Petersburg). Another masterly sketch in marble; the seated lad stoops forward between his parted knees, having both hands occupied with his left foot, the figure blocked out of the marble, with the least possible sacrifice of the material; the subject and motive enigmatical. "Cupid," kneeling, apparently in the act of shooting downward with a bow, marble (Victoria and Albert Museum). Probably, but not quite certainly, authentic; if so, then of 1530 or thereabouts; its identification with the early Cupid done for Jacopo Galli at Rome in 1496 is untenable. "Leda," painting, done for the duke of Ferrara, but withheld because of the misconduct of his messenger, and given by the master to his pupil Antonio Mini in 1531; lost. A fine injured tempera painting of the subject in the store-rooms of the National Gallery in London may presumably be an early copy.

Michelangelo had fully purposed, as soon as he could get free of his task on the Medici tombs, to devote all his powers to the completion of the Julian monument in accordance with the new contract of 1532. But his intention was again frustrated. Pope Clement insisted that he must complete his decorations of the Sixtine Chapel by painting anew the great end wall above the altar, adorned until then by frescoes of Perugino. The subject chosen was the Last Judgment; and Michelangelo began to prepare sketches. In the autumn of 1534, in his sixtieth year, he settled finally, and for the remainder of his life, at Rome. Immediately afterwards Clement died, and was succeeded by a Farnese under the title of Paul III. Even more than his predecessor, Paul insisted on claiming the main services of Michelangelo for himself, and forced him to let all other engagements drift. For the first seven years after the artist's return to Rome, his time was principally taken up with the painting of the colossal and multitudinous "Last Judgment." This being completed in 1541, he was next compelled to undertake two more great frescoes—one of the Conversion of Paul and another of the Martyrdom of Peter—in a new chapel which the pope had caused to be built in the Vatican, and named after himself—Capella Paolina.

The fresco of the "Last Judgment" in the Sixtine Chapel is probably the most famous single picture in the world. In it Michelangelo shows more than ever the omnipotence of his artistic science, and the fiery daring of his conceptions. But the work, so far as its deplorably deteriorated condition admits comparison, is hardly comparable in the qualities of colour and decorative effect to the earlier and far more nobly inspired frescoes of the ceiling. It is to these and not to the "Last Judgment" that the student must turn if he would realize what is best and greatest in the art of Michelangelo.

The frescoes of the Pauline Chapel are on their part so injured as to be hardly susceptible of useful study or criticism. In their ruined state they bear evidence of the same tendencies that made the art of Michelangelo in its latest phase so dangerous an example to weaker men—the tendency, that is, to seek for unqualified energy and violence of action, both in place and out, for "terribleness" *quand même*, and to design actions not by help of direct study from nature, but by scientific deduction from the abstract laws of structure and movement. At best these frescoes can never have been happy examples of Michelangelo's art.

Other Work of the years 1534-1540. SCULPTURE.—During the fifteen years when Michelangelo was mainly engaged on these paintings, he had also at last been enabled to acquit himself, although in a manner that can have been satisfactory to none concerned, of his engagements to the heirs of Julius. Once more the influence of the pope had prevailed on them to accept a compromise altogether to their disadvantage. By a final contract dated 1542, it was agreed that the "Moses" executed thirty years before, seated on a low plinth in a central recess, should be the chief figure of the new

scheme; in niches at either side of him were to be standing figures of "Leah" and "Rachel." These Michelangelo himself executed hastily with the help of assistants. To pupils entirely was left the carrying out of the upper cornice, with the recumbent effigy of the pope occupying the centre of a weak and incongruous architectural scheme, a Madonna and Child in a niche above, and a prophet and a sibyl in recesses at either side. Meantime all idea of incorporating any of the "Slaves" in the new design had been abandoned. The master gave the two that had been finished in 1513-1516 to Robert Strozzi, who gave them to Francis I.; while the four that had been roughed out between 1518 and 1522 remained at Brunsicini's marble (National Museum, Florence). Probably executed soon after 1539, in memory of the tyrannicide Lorenzino de' Medici. To the end of this period or to a year or two later belongs the infinitely pathetic unfinished sketch in marble of a life-size "Pietà" (Palazzo Rondini, Rome)—the mourning mother, standing on an elevation behind her son, holds his body upright in front of her by the shoulders. Still later, after 1550, is the more complicated and more finished group of the "Pietà," with the corpse of Christ collapsing in utter relaxation through the arms of those who try to uphold it: this Michelangelo destined for his own sepulchre; it stands now in the cathedral at Florence.

PAINTING.—"The Entombment of Christ" (National Gallery, London). This unfinished painting bears all the marks of an artist's design, and must have begun from a cartoon by him, probably about 1535-1540. The touch of his own hand seems evident in some parts, particularly the body of Christ; other parts, in various degrees of incompleteness, are apparently the work of various pupils or imitators.

For nearly all his great life-works mentioned above, preparatory sketches and studies by the master's hand exist. These, with a large number of other drawings, finished and unfinished, done for their own sakes and not for any ulterior use, are of infinite value and interest to the student. Michelangelo was the most learned and scientific as well as the most inspired and daring of draughtsmen, and from boyhood to extreme old age never ceased to practise with pen, chalk or pencil. He is said to have burned vast numbers of his drawings with his own hand and caused others to be burned by friends and pupils to whom he had given them; so that what we possess must be less than a tithe of what he executed. But there are some 250 genuine sheets—enough to let us follow and understand his modes of conceiving, preparing and maturing his designs at all periods of his life. They are scattered amongst various collections, chiefly public; those in England (at the British Museum, the University Galleries, Oxford, and the Royal Library, Windsor), are quite half the whole number; other important examples remain still at what was for centuries the home of his heirs, the Casa Buonarroti at Florence; others at the Uffizi, Florence; the Venice Académie, the Albertina, Vienna; the Louvres, the Copied Museum at Chantilly; the Berlin Museum; and, not least, the Teyler Museum at Haarlem. By means of these drawings and the many published facsimiles we are best able to trace the progress of the master's genius and its secrets. We see him diligently copying in youth from the frescoes of Giotto, Masaccio, and his own master Ghirlandajo. At this date his instrument was the pen only, used in a manner of hatching; sometimes extremely careful and close, at others fiercely bold and free, and in either case all his own. Sketches and studies thus drawn with the pen exist for the "David," the

"Bathers Surprised," "the accessory figures for the tomb of Julius as first conceived, and the great series of the Sixtine Chapel decorations. By, or even before, the date of the Sixtine Chapel, chalk, red or black, comes into use along with the pen, and many of the finest studies for the "Slaves" or "Atlases" and other decorative figures of the ceiling are in the latter material (many more studies are preserved for these subordinate figures than for the main compositions). After the Sixtine Chapel period the pen gives way to red or black chalk almost entirely. Sketches are rare for the great abortive scheme of the Julius monument; almost non-existent for the equally abortive San Lorenzo façade; fairly abundant for the various stages of the Medici monument scheme in its architectural parts, but not for the great figures. About the time of Michelangelo's final change of domicile from Florence to Rome (1532-1538) he began the practice of making highly finished and fully shaded drawings of classic or symbolic subjects in red or black chalk. For the most part these are his friends, especially to young Tommaso Cavalieri, the object of his passionate Platonic affection, from about 1532. The "Fall of Phaeton," the "Tityos," the "Ganymede," the "Men shooting at a Mark," are well-known examples; in this class of work the Windsor collection is far the richest. At the same time or soon afterwards, were produced drawings little less powerful and finished of Christian subjects, especially the "Crucifixion," "Entombment" and "Resurrection." Then comes the great fresco of the "Last Judgment," for which there exist both general sketches and particular studies. In the few extant drawings for the Cappella Paolina a faltering both of the imagination and of the hand is becoming discernible. To the same or to still later years belong many beautiful but somewhat tentative drawings done either directly for, or nearly in the spirit of, the famous "Crucifixion" which he is recorded to have painted with so much devotion for Vittoria Colonna. About many of these, for all their intensity of feeling, there is a wavering touch betraying the approach

of infirmity; so there is about many of the architectural studies done for the buildings of which he had charge in his last years at Rome; but signs of the old impressive power and penetration are not wanting in some even of the latest drawings that have come down to us.

During his later years the long-pent human elements of fervour and tenderness in Michelangelo's nature had found vent and utterance such as they had never found before. He had occasionally practised poetry in youth, and there are signs of some transient love-passages during his life at Bologna. But it was not until towards his sixtieth year that the springs of feeling were fairly opened in the heart of this solitary, this masterful and stern, life-wearied and labour-hardened man. About 1533-1534 we find him beginning to address impassioned sonnets—of which the sentiment is curiously comparable to that expressed in some of Shakespeare's—to a beautiful and gifted youth, the young Roman noble Tommaso Cavalieri. Soon afterwards he made the acquaintance of the pious, accomplished, and high-souled lady, Vittoria Colonna, widow of the Marquess Pescara. For ten years until her death, which happened in 1547, her friendship was the great solace of Michelangelo's life. On her, in all loyalty and reverence, he poured out all the treasures of his mind and all his imprisoned powers of tenderness and devotion. She was the chief inspirer of his poetry—of which, along with her praises, the main themes are the Christian religion, the joys of Platonic love, and the power and mysteries of art. Michelangelo's poetical style is strenuous and concentrated like the man. He wrote with labour and much self-correction; we seem to feel him flinging himself on the material of language with the same overwhelming energy and vehemence with which contemporaries describe him as flinging himself on the material of marble—the same impetuosity of temperament combined with the same fierce desire of perfection, but with far less either of innate instinct for the material or of trained mastery over its difficulties.

And so the mighty sculptor, painter, and poet reached old age. An infirmity which settled on him in 1544, and the death of Vittoria Colonna in 1547, left him broken in health and heart. But his strength held on for many a year longer yet. His father and brothers were dead, and his family sentiment concentrated itself on a nephew, Leonardo, to whom he showed unremitting practical kindness, coupled with his usual suspiciousness and fitfulness of temper. In almost all his relations the old man continued to the end to manifest the same loyal and righteous heart, accompanied by the same masterful, moody, and estranging temper, as in youth. Among the artists of the younger generation he held a position of absolute ascendancy and authority; nor was his example, as we have said, by any means altogether salutary for them. To artists, and to a certain number of chosen friends, belonging chiefly to the lettered, diplomatic, and secretarial classes, he was more accessible and affable than he had been to any one in earlier days, though still formidable in moods of scorn and scoffing. His great age and fame made him the most honoured citizen of Rome, to whom the highest, both of his fellow countrymen and foreigners, were eager to do homage. During the last years of his life he made but few more essays in sculpture, and those not successful, but was much employed in the fourth art in which he excelled—that of architecture. A succession of popes demanded his services for the embellishment of Rome. Between 1536 and 1546 he was engaged on plans for the rearrangement and reconstruction of the great group of buildings on the Capitol—plans which were only partially and imperfectly carried out during his lifetime and after his death. For Paul III. he finished the palace called after the name of the pope's family the Farnese. On the death of Antonio da San Gallo he succeeded to the onerous and coveted office of chief architect of St Peter's church, for which he remodelled all the designs, living to see some of the main features, including the supports and lower portion of the great central dome, carried out in spite of all obstacles, according to his plans. The dome as it stands is his most conspicuous and one of his noblest monuments: the body of the church was completed in a manner quite different from his devising. Other

great architectural tasks on which he was engaged were the reconstruction of the Porta Pia, and the conversion of a portion of the baths of Diocletian into the church of Sta Maria degli Angeli; the great cloister with its hundred columns, now used as the Museo delle Terme, is the only part of this reconstruction which remains as he designed it. At length, in the midst of these vast schemes and responsibilities, the heroic old man's last remains of strength gave way. He died on the threshold of his ninetieth year, on the 18th of February 1564.

AUTHORITIES.—For the earlier bibliography of Michelangelo, which is extensive, see the useful though very imperfect compilation of Passerini, *Bibliografia di Michelangelo Buonarroti*, &c. (Florence, 1875). The most important works, taken in chronological order, are the following: P. Giovio's supplement to the fragmentary *Dialogus de viris illis litteris tribus*, written soon after 1527, first published by Tiraboschi, *Storia della letteratura italiana* (Modena, 1871); G. Vasari, in *Vite degli più eccellenti architettori, pittori, e scultori*, &c. (Florence, 1550); A. Condivi, *Vita di Michelangelo Buonarroti* (1553); this account, for which the author, a pupil and friend of the master's, had long been collecting materials, was much fuller than that of Vasari, who made use of it in rewriting his own life of Michelangelo for his second edition, with additions, which the master's death forbade (1568). The best edition of Vasari is that by Milanesi (Florence, 1878-1883); of Condivi, that by Gori and Mariette (Pisa, 1746); for English readers there is a useful translation with notes, by Sir Charles Holroyd. The first additions of importance were published by Bottari, *Raccolta di lettere sulla pittura*, &c. (Rome, 1754; 2nd ed. by Ticozzi, Milan, 1822); the next by Gaye, *Carteggio inedito* (1840). Portions of the correspondence preserved in the Buonarroti archives were published by Guasti in his notes to the *Rime di Michelangelo Buonarroti* (1863), and by Jaelli in *Caric Michelangelo inedito* (Milan, 1865). Complete biographies of Michelangelo had been meanwhile attempted by J. Hartord (London, 1857), and with more power by Hermann Grimm, *Leben Michelangelos* (Hanover, 5th ed., 1879). A great increment of biographical material was at length obtained by the publication, in the four-hundredth year after Michelangelo's birth, of the whole body of his letters preserved in the Buonarroti archives, *Lettere di Michelangelo Buonarroti*, ed. G. Milanesi (Florence, 1875). This material was first employed in a connected but too trivial narrative by A. Gotti, *Vita di Michelangelo* (Florence, 1875). Next followed the fresco Wilson, *The Works of Michelangelo Buonarroti* (Florence, 1876); the technical remarks in which, especially as concerns the fresco paintings, are still valuable. Other lives of Michelangelo are by Anton Springer, in his *Michelangelo u. Raphael* (Leipzig, 1883); J. A. Symonds, *The Life of Michelangelo* (London, 1893), full of valuable matter on the history and spirit of Michelangelo's times, but not trustworthy in the criticism of his works; H. Mackowsky, *Michelagnolo* (Berlin, 1908), excellent in all respects, and in moderate compass; Emile Gebhardt, *Michel-Ange, sculpteur et peintre* (1808) is a handsome volume of reproductions with text. *Michelangelo* by Fritz Knapp, in the *Klassiker der Kunst* series (Stuttgart, 1906) is a very useful compendium. For the early works of Michelangelo the standard authority is H. Wölfflin, *Die Jugendwerke Michelangelos* (Munich, 1891, and later editions), a masterly work, though at variance with Berlin official opinion. The most elaborate study of the Sixtine frescoes, magnificently illustrated, is by E. Steinmann, *Die Sixtinische Kapelle*, vol. II. (Munich, 1905). Consult also C. Justi, *Michelangelo* (Leipzig, 1903), and with caution H. Thode, *Michelangelo u. das Ende der Renaissance* (Berlin, 1909-1903). Of the poems of Michelangelo the first sound edition was the *Monumenti*, to G. G. Gozzetti, *Rime di Michelangelo Buonarroti* (1863); in earlier editions the text had been recklessly tampered with, and the rugged individuality of the master's style smoothed down. An edition with German translations was published by Hasenclever (Leipzig, 1875); and a thorough critical edition by Karl Frey (Berlin, 1897); for the English student the translations by J. A. Symonds, in *Sonnets of Michelangelo and Campanella* (London, 1878) are invaluable. On the drawings of Michelangelo see especially B. Berenson, *The Drawings of Florentine Masters* (London, 1903). Comprehensive works on the same subject, in which the most important examples are reproduced and discussed, unfortunately not arranged chronologically, is Karl Frey, *Die Zeichnungen Michelangelos* (Berlin, 1908 seq.), still in progress. An elaborate life by the same author (Karl Frey, *Michelagnolo Buonarroti, sein Leben und seine Werke*) is also in progress, but is more to be prized for documentary fullness and accuracy than for critical insight. (S. C.)

MICHELET, JULES (1798-1874), French historian, was born at Paris on the 21st of August 1798, of a family which had Huguenot traditions. His father was a master printer, not very prosperous, and the son at an early age assisted him in the actual work of the press. A place was offered him in the imperial printing office, but his father was able to send him to the famous Collège or Lycée Charlemagne, where he distinguished

himself. He passed the university examination in 1821, and was shortly after appointed to a professorship of history in the Collège Rollin. Soon after this, in 1824, he married. The period of the restoration and the July monarchy was one of the most favourable to rising men of letters of a somewhat scholastic cast that has ever been known in France, and Michelet had powerful patrons in Villemain, Victor Cousin and others. But, though he was an ardent politician (having from his childhood embraced republicanism and a peculiar variety of romantic free-thought), he was first of all a man of letters and an inquirer into the history of the past.

His earliest works were school-books, and they were not written at a very early age. Between 1825 and 1827 he produced divers sketches, chronological tables, &c., of modern history. His *Précis* of the subject, published in the last-mentioned year, is a sound and careful book, far better than anything that had appeared before it, and written in a sober yet interesting style. In the same year he was appointed maître de conférences at the École normale. Four years later, in 1831, the *Introduction à l'histoire universelle* showed a very different style, exhibiting no doubt the idiosyncrasy and literary power of the writer to greater advantage, but also displaying the peculiar visionary qualities which made Michelet the most stimulating, but the most untrustworthy (not in facts, which he never consciously falsifies, but in suggestion) of all historians. The events of 1830 had unmuzzled him, and had put him in a better position for study by obtaining for him a place in the Record Office, and a deputy-professorship under Guizot in the literary faculty of the university. Very soon afterwards he began his chief and monumental work, the *Histoire de France*. But he accompanied this with numerous other books, chiefly of erudition, such as the *Œuvres choisies de Vico*, the *Mémoires de Luther écrits par lui-même*, the *Origines du droit français*, and somewhat later the *Procès des templiers*. 1838 was a year of great importance in Michelet's life. He was in the fullness of his powers, his studies had fed his natural aversion to the principles of authority and ecclesiasticism, and at a moment when the revived activity of the Jesuits caused some real and more pretended alarm he was appointed to the chair of history at the Collège de France. Assisted by his friend Edgar Quinet, he began a violent polemic against the unpopular order and the principles which it represented, a polemic which made their lectures, and especially Michelet's, one of the most popular resorts of the day. He published, in 1839, his *Histoire romaine*, but this was in his graver and earlier manner. The results of his lectures appeared in the volumes *Le Prêtre, la femme, et la famille et le peuple*. These books do not display the apocalyptic style which, partly borrowed from Lamennais, characterizes Michelet's later works, but they contain in miniature almost the whole of his curious ethico-politico-theological creed—a mixture of sentimentalism, communism, and anti-sacerdotalism, supported by the most eccentric arguments, but urged with a great deal of eloquence. The principles of the outbreak of 1848 were in the air, and Michelet was not the least important of those who condensed and propagated them: indeed his original lectures were of so incendiary a kind that the course had to be interdicted. But when the actual revolution broke out Michelet, unlike many other men of letters, did not attempt to enter on active political life, and merely devoted himself more strenuously to his literary work. Besides continuing the great history, he undertook and carried out, during the years between the downfall of Louis Philippe and the final establishment of Napoleon III., an enthusiastic *Histoire de la révolution française*. Despite or because of its enthusiasm, this was by no means Michelet's best book. The events were too near and too well known, and hardly admitted the picturesque sallies into the blue distance which make the charm and the danger of his larger work. In actual picturesqueness as well as in general veracity of picture, the book cannot approach Carlyle's; while as a mere chronicle of the events it is inferior to half a dozen prosaic histories older and younger than itself.

The *coup d'état* lost Michelet his place in the Record Office, as, though not in any way identified with the republic administratively, he refused to take the oaths to the empire. But the new régime only kindled afresh his republican zeal, and his second marriage (with Mlle Adèle Malairé, a lady of some literary capacity, and of republican belongings) seems to have further stimulated his powers. While the history steadily held its way, a crowd of extraordinary little books accompanied and diversified it. Sometimes they were expanded versions of its episodes, sometimes what may be called commentaries or companion volumes. In some of the best of them natural science, a new subject with Michelet, to which his wife is believed to have introduced him, supplies the text. The first of these (by no means the best) was *Les Femmes de la révolution* (1854), in which Michelet's natural and inimitable faculty of dithyrambic too often gives way to tedious and not very conclusive argument and preaching. In the next, *L'Oiseau* (1856), a new and most successful vein was struck. The subject of natural history was treated, not from the point of view of mere science, nor from that of sentiment, nor of anecdote nor of gossip, but from that of the author's fervent democratic pantheism, and the result, though, as was to be expected, unequal, was often excellent. *L'Insecte*, in the same key, but duller, followed. It was succeeded by *L'Amour* (1859), one of the author's most popular books, and not unworthy of its popularity, but perhaps hardly his best. These remarkable works, half pamphlets half moral treatises, succeeded each other as a rule at the twelve months' interval, and the succession was almost unbroken for five or six years. *L'Amour* was followed by *La Femme* (1860), a book on which a whole critique of French literature and French character might be founded. Then came *La Mer* (1861), a return to the natural history class, which, considering the powers of the writer and the attraction of the subject, is perhaps a little disappointing. The next year (1862) the most striking of all Michelet's minor works, *La Sorcière*, made its appearance. Developed out of an episode of the history, it has all its author's peculiarities in the strongest degree. It is a nightmare and nothing more, but a nightmare of the most extraordinary verisimilitude and poetical power.

This remarkable series, every volume of which was a work at once of imagination and of research, was not even yet finished, but the later volumes exhibit a certain falling off. The ambitious *Bible de l'humanité* (1864), an historical sketch of religions, has but little merit. In *La Montagne* (1868), the last of the natural history series, the tricks of staccato style are pushed even farther than by Victor Hugo in his less inspired moments, though—as is inevitable, in the hands of such a master of language as Michelet—the effect is frequently grandiose if not grand. *Nos fils* (1869), the last of the string of smaller books published during the author's life, is a tractate on education, written with ample knowledge of the facts and with all Michelet's usual sweep and range of view, if with visibly declining powers of expression. But in a book published posthumously, *Le Banquet*, these powers reappear at their fullest. The picture of the industrious and famishing populations of the Riviera is (whether true to fact or not) one of the best things that Michelet has done. To complete the list of his miscellaneous works, two collections of pieces, written and partly published at different times, may be mentioned. These are *Les Soldats de la révolution* and *Légendes démocratiques du nord*.

The publication of this series of books, and the completion of his history, occupied Michelet during both decades of the empire. He lived partly in France, partly in Italy, and was accustomed to spend the winter on the Riviera, chiefly at Hyères. At last, in 1867, the great work of his life was finished. In the usual edition it fills nineteen volumes. The first of these deals with the early history up to the death of Charlemagne, the second with the flourishing time of feudal France, the third with the 13th century, the fourth, fifth, and sixth with the Hundred Years' War, the seventh and eighth with the establishment of the rural power under Charles VII. and Louis XI. The 16th and 17th centuries have four volumes

apiece, much of which is very distantly connected with French history proper, especially in the two volumes entitled *Renaissance* and *Réforme*. The last three volumes carry on the history of the 18th century to the outbreak of the Revolution. Michelet was perhaps the first historian to devote himself to anything like a picturesque history of the middle ages, and his account is still the most vivid that exists. His inquiry into manuscript and printed authorities was most laborious, but his lively imagination, and his strong religious and political prejudices, made him regard all things from a singularly personal point of view. Circumstances which strike his fancy, or furnish convenient texts for his polemic, are handled at inordinate length, while others are rapidly dismissed or passed over altogether.

Uncompromisingly hostile as Michelet was to the empire, its downfall and the accompanying disasters of the country once more stimulated him to activity. Not only did he write letters and pamphlets during the struggle, but when it was over he set himself to complete the vast task which his two great histories had almost covered by a *Histoire du XIX^e siècle*. He did not, however, live to carry it farther than Waterloo, and the best criticism of it is perhaps contained in the opening words of the introduction to the last volume—"L'âge me presse." The new republic was not altogether a restoration for Michelet, and his professorship at the Collège de France, of which he contended that he had never been properly deprived, was not given back to him. He died at Hyères on the 9th of February 1874.

Almost all Michelet's works, the exceptions being his translations, compilations, &c., are published in uniform size and in about fifty volumes, partly by Marpon and Flammarion, partly by Calmann Lévy. He has not received much recent attention from critics and monographers, but his *Origines du droit français, cherchées dans les symboles et formules du droit universel* was edited by Émile Faguet in 1890 and went into a second edition in 1900. See G. Monod, *Jules Michelet; Études sur la vie et ses œuvres* (Paris, 1905).

(G. SA.)

MICHELET, KARL LUDWIG (1801–1893), German philosopher, was born on the 4th of December 1801, at Berlin, where he died on the 16th of December 1893. He studied at the gymnasium and at the university of his native town, took his degree as doctor of philosophy in 1824, and became professor in 1829, a post which he retained till his death. Educated in the doctrine of Hegel, he remained faithful to his early teaching and spent his life in defending and continuing the Hegelian tradition. His first notable work was the *System der philosophischen Moral* (Berlin, 1828), an examination of the ethical theory of responsibility. In 1836 he published, in Paris, a treatise on the *Metaphysics* of Aristotle, written in French and crowned by the Académie des Sciences Morales et Politiques. He wrote also two other treatises on Aristotle. *Nikomachische Ethik* (2nd ed., 1848) and *Die Ethik des Aristoteles in ihrem Verhältnis zum System der Moral* (1827). His own views are best expressed in his *Vorlesungen über die Persönlichkeit Gottes* (1841) and *Die Epiphanie der ewigen Persönlichkeit des Gottes*. The philosophical theology developed in these works has been described as a "Neo-Christian Spiritualism."

Among his other publications may be mentioned *Geschichte der letzten Systeme der Philos. in Deutschland von Kant bis Hegel* (1837–1838); *Anthropologie und Psychologie* (1840); *Esquisse de logique* (Paris, 1856); *Naturrecht oder Rechtsphilosophie* (1866); *Hegel der unüderlegte Weltphilosoph* (1870); *Wahrheit aus meinem Leben* (1886). From 1832 to 1842, Michelet was engaged in publishing the complete works of Hegel, and in 1845 he founded the Berlin Philosophical Society, which has continuously represented the Hegelianism of Germany. He was the first editor of *Der Gedanke* (1860), the official organ of the society.

MICHELL, JOHN (1724–1793), English natural philosopher and geologist, was born in 1724, and educated at Queens' College, Cambridge. His name appears fourth in the Tripos list for 1748–1749; and in 1755 he was moderator in that examination. He became M.A. in 1752, and B.D. in 1761. He was a fellow of his college, and was appointed Woodwardian professor of geology in 1762, and in 1767 rector of Thornhill in Yorkshire, where he died on the 29th of April 1793. He was

ected a fellow of the Royal Society in the same year as Henry Cavendish (1760). In 1750 he published at Cambridge a work of some eighty pages entitled *A Treatise of Artificial Magnets, in which is shown an easy and expeditious method of making them superior to the best natural ones*. Besides the description of the method of magnetization which still bears his name, this work contains a variety of accurate magnetic observations, and is distinguished by a lucid exposition of the nature of magnetic induction. He was the original inventor of the torsion balance, which afterwards became so famous in the hands of its second inventor Coulomb. Michell described it in his proposal of a method for obtaining the mean density of the earth. He did not live to put his method into practice; but this was done by Henry Cavendish, who made, by means of Michell's apparatus, the celebrated determination that now goes by the name of Cavendish's experiment (*Phil. Trans.*, 1798). His most important geological essay was that entitled *Conjectures concerning the Cause and Observations upon the Phenomena of Earthquakes* (*Phil. Trans.*, li. 1760), which showed a remarkable knowledge of the strata in various parts of England and abroad.

Michell's other contributions to science are: "Observations on the Comet of January 1760 at Cambridge," *Phil. Trans.* (1760); "A Recommendation of Hadley's Quadrant for Surveying," *ibid.* (1765); "Proposal of a Method for measuring Degrees of Longitude upon Parallels of the Equator," *ibid.* (1766); "An Inquiry into the Probable Parallax and Magnitude of the Fixed Stars," *ibid.* (1767); "On the Twinkling of the Fixed Stars," *ibid.* (1767); "On the Means of Discovering the Distance, Magnitude, &c., of the Fixed Stars," *ibid.* (1784).

MICHEL OF NORTHGATE, DAN (fl. 1340), English writer, the author of the *Ayenbite of Inweyt*. Nothing is known of him except what can be gathered from his work. It is a literal translation in the Kentish dialect of a French treatise entitled *Le Somme des vices et des vertues* (also known as *Le Miroir du monde* or *Le Livre des commandemens*, &c.), which was written in 1279 by Laurentius Gallus, a Dominican monk and confessor to Philip III. of France. This work was translated into Flemish, Catalanian, Spanish and Italian, and appears in no less than six English translations. Dan Michel's autograph MS. is preserved in Arundel MS. 57, which states that the work was completed in the year 1340 on the eve of the apostles Simon and Jude by Dan Michel of Northgate, a brother of the cloister of St Austin of Canterbury. The value of the book is chiefly philological as an authenticated and dated example of the southern dialect.

The *Ayenbite of Inweyt* was edited for the Roxburgh Club by the Rev Joseph Stevenson in 1855, and for the Early English Text Soc. by Richard Morris in 1876.

MICHELOZZO DI BARTOLOMEO (1391-1472?), Italian sculptor, was a Florentine by birth, the son of a tailor, and in early life a pupil of Donatello. He worked in marble, bronze and silver. The statue of the young St John over the door of the Duomo at Florence, opposite the Baptistery, is by him; and he also made the beautiful silver statuette of the Baptist on the altar-frontal of San Giovanni. Michelozzo's great friend and patron was Cosimo dei Medici, whom he accompanied to Venice in 1433 during his short exile. While at Venice, Michelozzo built the library of San Giorgio Maggiore, and designed other buildings there. In 1428, together with Donatello, he erected an open-air pulpit at an angle of the cathedral of St Stephen at Prato. The magnificent Palazzo dei Medici at Florence built by Cosimo, was designed by him; it is one of the noblest specimens of Italian 15th-century architecture, in which the great taste and skill of the architect has combined the delicate lightness of the earlier Italian Gothic with the massive stateliness of the classical style. With great engineering skill Michelozzo shored up, and partly rebuilt, the Palazzo Vecchio, then in a ruinous condition, and added to it many important rooms and staircases. When, in 1437, through Cosimo's liberality, the monastery of San Marco at Florence was handed over to the Dominicans of Fiesole, Michelozzo was employed to rebuild the domestic part and remodel the

church. For Cosimo I, he designed numerous other buildings, mostly of great beauty and importance. Among these were a guest-house at Jerusalem for the use of Florentine pilgrims, Cosimo's summer villa at Careggi, and the strongly fortified palace of Cafagiuolo in Mugello. For Giovanni dei Medici, Cosimo's son, he built a very large and magnificent palace at Fiesole. In spite of Vasari's statement that he died at the age of sixty-eight, he appears to have lived till 1472. He is buried in the monastery of San Marco, Florence. Though skilled both as a sculptor and engineer, his fame chiefly rests on his architectural works, which claim for him a position of very high honour even among the greatest names of the great 15th-century Florentines.

See Hans Stegmüller, *Michelozzo di Bartolomeo, eine kunstgeschichtliche Studie* (1888); Fritz Wolff, *Bartolomeo di Bartolomeo* (1900); cf. also Hans Semper, *Donatello* (1887).

MICHIGAN, a north central state of the United States, situated between latitudes 41° 44' and 47° 30' N. and longitudes 82° 25' and 90° 31' W., and consisting of two peninsulas—the upper or northern and the lower or southern—separated by a strait. The upper or northern peninsula is bounded N. by Lake Superior; E. by lakes Superior, George, Huron, and Michigan, and by St Mary's River, which separates it from the Province of Ontario, Canada; S. by lakes Huron and Michigan and the Straits of Mackinac, which separate it from the lower peninsula; and S. and W. by Wisconsin, and the Menominee, Montreal and Brulé Rivers, which separate it in part from Wisconsin. The lower or southern peninsula is bounded N. by lakes Michigan and Huron and the Straits of Mackinac, E. by lakes Huron, St Clair and Erie, and the St Clair and Detroit Rivers, which separate it from Ontario; S. by Ohio and Indiana, and W. by Lake Michigan. In size Michigan ranks eighteenth among the states of the Union, its total area being 57,980 sq. m., of which 500 sq. m. are water surface.²

Physical Features.—Physiographically the history of the state is similar to that of Minnesota. The northern part is rugged mountainous "old land," not completely worn down by erosion; and the southern part is a portion of the old coastal plain, whose layers contain salt, gypsum and some inferior coal. Lake Huron on the east and Lake Michigan on the west of the lower peninsula are each 58½ ft. above sea-level, and Lake Superior on the north of the upper peninsula is 602 ft. above sea-level. For the most part the surface of the state is gently undulating and at a slight elevation above the lakes, but low marsh lands are common to many sections; the north part of the lower peninsula is occupied by a plateau of considerable dimensions, and the north-west part of the upper peninsula is rugged with hills and mountains. Crossing the lower peninsula from Saginaw Bay west by south through the valleys of the Saginaw, Maple and Grand rivers, is a depression—the former channel of an old glacial river—in which elevations for a considerable area are less than 100 ft. above the lakes. To the south-east of this depression a water-parting with summits varying from about 400 to 600 ft. above the lakes extends from a point between Saginaw Bay and Lake Huron south by west to the south border of the state and beyond. The east slope descends quite rapidly to a low flat belt from 5 to 40 m. wide along the east border of the state south from Lake Huron. From Lake Huron to the south-east shore of Saginaw Bay a wide sandy beach is followed northward by precipitous shores abounding in rocks and bluffs. West of the divide and south of the depression, south-west Michigan is occupied by the valleys of the St Joseph, Kalamazoo and Grand rivers, by the gently rolling uplands that form the parting divides between them, and by sand dunes, which here and there rise to a height of from 100 to 200 ft. or more along the shore of Lake Michigan, and are formed on this side (but not on the Wisconsin side) of the lake by the prevailing west winds. The north and north-west portions of the lower peninsula—including the counties of Roscommon and Missaukee, parts of Wexford and Ogemaw, and those to the north and north-west of these—are occupied by a rolling plateau which attains an elevation at its highest point, north of its centre, of upwards of 1100 ft. above Lake Michigan; to the south of this plateau the land slopes gently down to the depression and to the low shores of Lake Michigan and Saginaw Bay. The surface of the upper

¹ This is the northernmost point of the mainland; the most northerly of the islands north-east of Isle Royal and belonging to Michigan is more than 40' further north.

² In addition, within the boundaries of Michigan, are approximately 16,653 sq. m. of Lake Superior, 12,992 sq. m. of Lake Michigan, 9925 sq. m. of Lake Huron and 460 sq. m. of lakes St Clair and Erie.

peninsula is more irregular than that of the lower peninsula. A portion extending through the middle from east to west and south, from west of the centre to Green Bay, is either flat and even swampy or only gently undulating. Eastward from Green Bay are two ranges of hills: the one lining the south shore and ranging from 100 to 300 ft. in height, the other close to or touching the north shore and ranging in places an elevation of 600 ft. above Lake Superior. The famous Pictured Rocks in Alger county, on the lake shore east of Munising, form the west portion of this north range; they are of sandstone formation, extend for several miles along the coast, rise almost perpendicularly from the water's edge, and display an interesting diversity of shapes as well as a great variety of tints and hues, especially of gray, blue, green and yellow. The most rugged portion of the state is farther west. South and south-east of Keweenaw Bay, in the Marquette iron district, is an irregular area of mountains, hills, swamps and lakes, some of the mountain peaks of the Huron Mountains (in Marquette county) rising to an elevation of 1400 ft. or more above the lake. These and a peak in the Porcupine Mountains (2023 ft. above the sea) in the north-west part of Ontonagon county are the highest in the state. To the south of this is the Menominee iron district, marked somewhat regularly by east and west ridges. Extending in a general north-east and south-west direction through Keweenaw peninsula to the Wisconsin border and beyond is the middle of three approximately parallel ranges, separated from each other by flat lands, with here and there an isolated peak (in the Porcupine Mountains) having an elevation of from 900 to 1400 ft. above the lake. The north portion of these ranges, together with the Royale iron district, west as a peak in the Porcupine Mountains, by several less elevated parallel ridges, contains the Michigan copper-bearing rocks; while to the south, along the Wisconsin border, is another iron district, the Gogebic. The rivers of the entire state consist of numerous small streams of clear water. In the interior of the upper peninsula, along the east border of the lower peninsula south from Lake Huron, and in Saginaw valley, they are rather sluggish; but many of the larger streams of the lower peninsula have sufficient fall to furnish a large amount of water-power, while the small streams that flow into Lake Superior from the central portion of the upper peninsula, west as a peak in the Porcupine Mountains, have several falls and rapids; in places also they are lined with steep, high banks. Most of the larger rivers of the state—the Muskegon, Grand, St Joseph, Manistee and Kalamazoo—are in the west portion of the lower peninsula. Several thousand lakes of clear water, formed by glacial action, dot the surface of the state, and many of them are lined with picturesque woodland shores. Islands in lakes Superior, Michigan and Huron are scarcely less numerous.

Fauna and Flora.—Michigan, especially the north portion, still abounds in game. The mammals include black bear, deer, lynx, porcupine, fox, skunk, marten, rabbit, muskrat, mink, weasel, fisher and woodchuck. Among the game birds are the "Bob White", partridges (huffed grouse), ducks, geese, woodcocks, snipes and plovers. Of song birds the favourites are the robin, thrushes, bobolink, oriole, chickadee, meadow-lark, cat-bird, blue-bird, wrens and warblers. Among fishes, white fish, lake trout, perch, herring, sun-fish, bass, sturgeon, pickerel, suckers, German carp and fresh-water drum abound in the lakes. The speckled trout thrives in many of the streams.

Before it was settled by the whites the area now included in Michigan was a forest, except in the south-west, where there were a few prairie and oak openings. The remainder of the territory to the south part of this area for about 60 m. along the southern boundary was a part of the great hardwood forest of the Ohio basin with woods varying with soil and drainage; on the drier gravel lands were oak forests consisting of red, black and white oak, hickory, ash, cherry, basswood and walnut; in depressions there were maple, elm, ash, beech, sycamore, poplar and willow; and in the south-east there were a few chestnuts and tulip trees. North of this southern hardwood forest there were pine forests on the sandier land, mixed hardwoods and conifers on the loam and clay, and tamarcks and cedar in the swamps. The sandy lands were in part burnt over by Indians, and there was a growth of scrub oak, aspens and huckleberry bushes. The tamarack and cedar swamps now have a growth, especially on their edges, of spruce, balsam, white pine, soft maple, ash and aspens. In 1909 about 25% of the area was "cut over" or "burned over" lands, mostly the old pine woods, the region of the old hardwood forest was almost entirely farmland, and about 40% of the state was still in woods. Red oak, birch, elm, ash, white cedar, hemlock, basswood, spruce, poplar, balsam, fir and several other kinds of trees are found in many sections; but a large portion of the merchantable timber, especially in the lower peninsula, has been cut. Among forest shrubs are the willow, hazel, alder, shrub maple, birch, hawthorn, dogwood, elderberry, viburnum and snowberry. Yews are common in the north, and dwarf juniper in the south. In 1900 the woodland area, including stump lands, was estimated at 36,000 sq. m., or nearly two-thirds of the entire state. Huckleberry, blackberry and raspberry bushes are common in the north sections. Smilax, clematis, honeysuckle and woodbine are the commoner forest vines.

Under the revised constitution of 1908 the legislature is authorized to provide for the reforestation of state lands.

Soil.—The soil of south-west and south-east Michigan is for the most part a dark clay loam or muck; in the north central part of the lower peninsula it is a light sandy loam, along the Huron shore it is heavy with blue clay, in the mining districts of the north-west the rocks are usually either barren or very thinly covered; and elsewhere in the state the soil is generally rich in a variety of mineral elements, and varies chiefly in the proportions of vegetable loam, sand or gravel, and clay.

Climate.—Although the temperature of the entire lower peninsula is considerably influenced by the lakes, yet, the prevailing winds being westerly, it is in the west portion of that peninsula that the moderation is greatest, both the summer and winter isotherms being there deflected more than half the length of the peninsula. On the other hand, the prevailing winds of the upper peninsula being north-westerly, the lakes have little effect on the temperature there; and so, while in the south-west the extremes are not great, in the rest of the state they have ranged within two years from 104° F. at the south-east to 49° F. in the north-west. Throughout the state July is invariably the warmest month, February the coldest, the mean annual temperature is about 45° F. The mean annual precipitation is not far from 31 in., a little more than one-half of which falls during the five growing months from May to October; the rain is evenly distributed over all parts of the state, but the snow is exceptionally heavy along the north shore of the upper peninsula.

Productions.—Of the total land surface of the state in 1900 48.08% (in 1904, 47.1%) was included in farms and 67.2% (in 1904, 66.9%) of the farm land was improved; the total number of farms was 203,261 (in 1904, 189,167), of which 143,688 contained less than 100 acres, 54,556 others contained less than 260 acres, and 136 counties (in 1904, 135) were under mow, the average size being 86.4 acres (in 1904, 91) acres. Of the total number of farms 168,814 were operated by the owners (in 1904, 161,037 by owners and 914 by managers), 22,482 (in 1904, 19,525) by share tenants, 9731 (in 1904, 7685) by cash tenants; and 312,462 of the inhabitants of the state, or 34.5% of all who were engaged in gainful occupations, were farmers. Of the total acreage in 1900 of all crops 58.3% was in cereals and 28.8% in hay and forage; of the acreage of cereals 40.8% was in wheat, 31.8% in Indian corn, 21.6% in oats and 3.7% in rye. In 1907 the buckwheat crop was 852,000 bushels; rye, 5,452,000 bushels; the hay crop, 3,246,000 tons; 100,534,000 bushels of barley, 406,000 bushels; wheat, 12,000,000 bushels; and Indian corn 57,100,000 bushels. Of livestock, sheep are the most numerous (2,310,000 in 1907), and Michigan's wool clip in 1907 was 14,080,500 lb. The number of neat cattle in 1907 was 1,852,000 (849,000 dairy cows). The number of hogs was 1,388,000; and of horses 704,000.

Michigan produces the bulk of the peppermint crop of the United States, and it is in the front rank as a fruit-producing state.

Barley and buckwheat are grown chiefly in the east part of the lower peninsula south of Saginaw Bay. Potatoes are grown in considerable quantities in the north-west part of the lower peninsula in the vicinity of Grand Traverse Bay as well as throughout the southern portion of the state; the largest crops of beans are grown in the south central part of the lower peninsula, and of peas in the counties bordering on Lake Huron. Kalamazoo, Jackson, Washtenaw, Lenawee, Ingham, Bay and Muskegon are the leading celery-producing counties; the peppermint district is in the south-west corner of the state; and market gardening is an important industry both in the south-west and in the south-east counties. All the principal fruits are grown in largest quantities in what is commonly known as the fruit belt in the south-west, particularly in Berrien, the corner county.

The fresh-water fish caught in the Great Lakes by residents in Michigan exceed in value those caught by residents of other states, and in 1907 the catch was valued at \$1,806,767. Nearly one-half both in quantity and value are taken from Lake Michigan, and, although as many as twenty kinds are caught in considerable quantities, more than 90% of the value of the catch consists of trout, herring, white fish and perch. Both the state government and the national government have established hatcheries within the state, and state laws protect the industry by regulating the size of mesh in the nets used, prescribing the size of fish that may be taken and kept, establishing close seasons for several kinds of fish, and by other limitations.

Minerals.—Of the mineral products (for which the state is noted) iron is the most valuable. This mineral was discovered in the Marquette district along the shore of Lake Superior early in the 18th century, but active operations for mining it did not begin until 1845; in 1877 mining of the same mineral began farther south in the Menominee district, and seven years later farther west along the Wisconsin border in Gogebic county. The annual product steadily increased from 3000 long tons in 1854 to 11,830,342 in 1907; from 1890 to 1901 Michigan ranked first in the union as an iron-producing state, but after 1901 its product was exceeded by that of Minnesota. Up to 1909 it was estimated that 380,417,085 tons of ore were shipped from the Lake Superior region. Next in value among the mineral products is copper; there are about twenty copper mines in Keweenaw peninsula and its vicinity. The Calumet and Hecla mine, in the central part of that peninsula, is probably the most profitable copper mine in the world; up to 1909 it had paid

MICHIGAN

Scale, 1:2,100,000
English Miles
0 10 20 30 40 50 60

County Seats Railings
County Boundaries Indian Reservations

South-Eastern Michigan

Scale, 1:1,200,000
English Miles
0 10 20 30 40 50 60



Continuation West
Same Scale

D Longitude West 90° of Greenw. B 85 F 80 G 75 H

about \$107,850,000 in dividends. Copper mining in the state began about the same time as iron mining, and the quantity mined increased from 12 long tons in 1845 to 102,543 in 1906 (in 1907, 97,175 long tons). From 1847 to 1887 the product of Michigan exceeded that of any other state; from 1847 to 1883 its copper product was more than one-half that of all the states, but after 1887 (except in 1891) more of that mineral was mined in Montana than in Michigan, and in 1906 and in the year in which Arizona and Montana was greater than in Michigan. Fields of bituminous coal extend over an area of over 10,000 sq. m. in the central portion of the lower peninsula; but its quality is inferior. The mining of coal began in Jackson county in 1835 and there was a slow increase in output until 1882 (135,339 short tons); then there was a tendency to decrease until 1897, from which time the product increased from 223,592 short tons to 2,035,858 short tons in 1907. The principal mines are in Saginaw, Bay, Eaton, Jackson, Huron and Shiawassee counties. Salt wells are numerous in the middle and south-east sections of the lower peninsula; the first successful one was drilled in Saginaw county in 1859 and 1860. For a number of years prior to 1893 Michigan was the leading salt-producing state, and, though her output was subsequently (except in 1901) exceeded by that of New York, it continued to increase up to 1905, when it was 9,492,173 barrels; in 1907, the product was 10,786,630 barrels. Gypsum is obtained from deposits along the banks of the Grand river in Kent county and in the vicinity of Alabaster along the shore of Lake Huron in Iosco county. Operations on the deposit near Grand Rapids were begun in 1841, and although that near Alabaster was opened in 1862, it was not until 1902 that it became of much importance; in that year the output of the state was 208,563 short tons, in 1907 377,261 short tons. Marl is found in Michigan in the south part of the state; limestone most largely in the north part of the lower peninsula, and the east part of the upper peninsula; and the production of Portland cement increased rapidly from 77,000 barrels in 1898 to 3,572,668 in 1907. Besides limestones and dolomites, the only building stone of much commercial importance is the Potsdam sandstone, extensive beds of which lie in the north part of the upper peninsula. Grindstones are produced in considerable quantity in Huron county. A small quantity of petroleum is obtained from thirteen wells in St. Clair county in the north part of the lower peninsula; and the mineral waters at Mount Clemens, Benton Harbor and Alma are of considerable commercial value for medicinal purposes.

Manufactures.—In 1900 the value of the manufactured products of Michigan amounted to \$356,944,082, which was an increase of 28.4% over that of 1890, and by 1904 there was a further increase of 20.19%. During the same period, however, the value of the products of the lumber and timber industry, which in 1870, 1880 and 1890 was greater than that of any other state, and in 1900 was still more than twice as great as that of the products of any other manufacturing industry in the state and was exceeded only by that of the products of Wisconsin, decreased from \$83,121,069 in 1890 to \$53,915,647 (35.1%) in 1900, and to \$40,569,335 in 1904, this decrease being due to the fact that the large quantities of raw material (both hard wood and pine) formerly found in the forests of Michigan had become so far exhausted that much of it had to be brought in from other states and from Canada. The value of the products of the furniture factories and of the planing mills, nevertheless, has steadily increased; that of the furniture factories (of which Grand Rapids is the leading centre not only in Michigan but in the United States) rising from \$10,767,038 in 1890 to \$14,614,506 in 1900 and \$18,735,735 in 1904, and that of the planing mills from \$10,007,603 in 1890 to \$12,469,532 in 1900 and \$14,375,467 in 1904. The total value of the lumber and timber products, the furniture products, and the planing-mill products amounted in 1900 to \$80,999,685; the value of those manufactures based upon minerals mined or quarried amounted in the same year to \$83,730,930.

Another important class of manufactures is that based on agriculture: the value of flour and grist mill products amounted to \$21,643,547 in 1900, and \$26,512,027 in 1904; that of food preparations, of which Battle Creek is noted, to \$1,891,516 in 1900 and \$6,753,699 in 1904; that of agricultural implements to \$6,339,508 in 1900 and \$8,719,179 in 1904; and of malt liquors to \$5,296,825 in 1900 and \$6,999,251 in 1904.

Among other manufactures in which the state ranks high and in which there was a large increase in value during the same period

¹ The 1904 census, taken by the Federal Bureau of the Census in co-operation with the secretary of state of Michigan, covered the year ending on the 30th of June 1904, and is thus not strictly comparable with the 1907 census of manufactures of other states, which were for the year ending on the 31st of December 1904. But like the special census of manufactures in other states, it is confined to establishments under the factory system, and hence its figures are considerably less than they would have been had it been taken on the same basis as that of the 1900 census, which included hand trades and other custom work; for example, on the basis of the 1904 census the value of the manufactured products in 1900 was only \$319,691,856, and as that of 1904 was \$429,120,066, the real increase was 34.2% instead of 20.19%. In the above text from this point the statistics given for 1900 are for factory products only.

are: leather, carriages and waggon, chemicals, paper and wood pulp and beet sugar. In 1904 Michigan manufactured automobiles valued at \$6,876,708.

The ten leading manufacturing centres are, in the order of the value of their products in 1904: Detroit, Grand Rapids, Kalamazoo, Battle Creek, Saginaw, Jackson, Lansing, Muskegon, Bay City and Port Huron, all in the south half of the lower peninsula.

Communications.—The building of railways in Michigan began in 1830, but little progress had been made in 1837 when the state began the construction of three railways and two canals across the south half of the lower peninsula. The Michigan Central was completed from Detroit to Ypsilanti in January 1838, a portion of the Michigan Southern was in operation in November 1840, and considerable work was done on the proposed Michigan Northern and the two canals. By 1846, however, the state had proved itself incompetent to carry on the work and sold its interests to private companies. In 1850 there were 342 m. completed, and from then until 1880 the mileage increased to 3038; but the great period of railway building in Michigan was in the decade from 1880 to 1890, when the mileage was increased to 7108.48. By the close of 1908 it had further increased to 8629.35. The principal lines are the Michigan Central, the Père Marquette, the Lake Shore & Michigan Southern, the Grand Rapids & Indiana, the Ann Arbor, the Grand Trunk, the Chicago & North-Western, the Duluth South Shore & Atlantic, the Minneapolis, St. Paul & Sault Ste. Marie, and the Chicago, Milwaukee & St. Paul. A board of railway commissioners, which in 1907 succeeded a commissioner (whose office was created in 1873) hears complaints, has power to issue various orders and permits of minor importance to railway companies, and reports annually to the governor. The legislature is empowered to appoint a commission to investigate the routes for railways and express companies. Besides railway communication Michigan has a coast line of about 1600 m., along which vessels of 2000 tons can sail and find several good harbours, the water communication having been extended and improved by several canals, among which are the Sault Ste. Marie, which passes the rapids of St. Mary's River; the St. Clair Flats, at the north end of Lake St. Clair, by which a deeper channel is made through shallow water; and the Portage Lake, in the copper district, which connects that lake with Lake Superior. The state undertook to construct that Sault Ste. Marie in 1837 but little had been accomplished in 1852 when the national government granted 750,000 acres of land to the state in aid of the enterprise, and three years after that the canal was completed. Since its completion, the national government has enlarged its locks so as to make it navigable for vessels drawing 21 ft. of water. The national government constructed the canal at the St. Clair Flats in 1871 and contributed land for aid in the construction of that connecting lakes Portage and Superior, which was completed in 1873 and passed under national control in 1891.

Population.—The population of Michigan in 1880 was 1,636,937; in 1890 it was 2,093,889, an increase of 27.9% within the decade; in 1900 it was 2,420,982, a further increase of 15.6% and in 1910, according to the preliminary returns of the U.S. census, it was 2,810,173. Of the total population in 1900, 2,398,563 or 99.07% were whites, 15,861 were negroes, 6334 were Indians, 240 were Chinese, and 9 were Japanese. 1,879,329 or 77.6% were native born and 541,653 were foreign-born, 184,398 of the foreign-born being natives of Canada (151,915 English; 32,483 French), 125,074 of Germany, 43,839 of England, and 30,406 of Holland. In 1906 982,479 communicants of different denominations were reported: of these 492,135 were Roman Catholics, 128,675 Methodists, 105,803 Lutherans, 50,136 Baptists, 37,900 Presbyterians, 28,345 members of Reformed bodies, and 26,349 members of the Protestant Episcopal Church. In 1900 39.3% of the total population lived in places having at least 2500 inhabitants.

Administration.—The constitution under which Michigan is now governed was first adopted in 1850, when it was felt that the powers which the first one, that of 1835, conferred upon the executive and the legislature were too unrestricted. In 1908 it was revised, and many changes were made.

The constitution admits of amendment by an affirmative vote of two-thirds of the members of each house of the legislature, followed at the next succeeding spring or autumn election by an affirmative vote of a majority of the electors voting upon the question; or an amendment may be proposed by an initiative petition signed by more than 20% of the total number of electors who voted for secretary of state at the preceding election, and such an amendment (unless disapproved by a majority vote in a joint meeting of the two houses of the legislature) is submitted to popular

* In 1909 telegraph and telephone companies were put under the supervision of the same board.

vote at the next election and comes into effect only if it receives a favourable majority of the popular vote. Amendments suggested by the legislature have been frequently adopted, and one, adopted in 1862, provided that the question of a general revision of the constitution shall be submitted to a popular vote once every sixteen years and at such other times as may be provided by law. When this question was so submitted for the first time, in 1866, the vote was to revise; but the revision prepared by a convention called for that purpose was rejected at the polls. The revision by the Constitutional Convention of 1907-1908 was adopted by popular vote in 1908.

In its present form the constitution confers suffrage upon every male citizen of the United States who is twenty-one years of age or over and has resided in the state six months and in his township or ward twenty days immediately preceding an election; and any woman may vote in an election involving the direct expenditure of public money or the issue of bonds if she have the qualifications of male electors and if she have property assessed for taxes in any part of the district or territory affected by the election in question. At the head of the executive department is the governor, who is elected for two years, and who at the time of his election must be at least thirty years of age and must have been for five years a citizen of the United States, and for the two years immediately preceding a resident of the state. A lieutenant-governor, for whom the same qualifications are prescribed, is elected at the same time for the same term. Under the first constitution the secretary of state, treasurer, auditor-general, attorney-general, commissioner of the land office, superintendent of public instruction and the judges were all appointed by the governor, but under the present one they are elected and only minor officers are appointed. In 1893 the legislature created a board of four members to be appointed by the governor, one of whom must be a physician, another an attorney, and made it its duty to investigate the case of every convict for whom a petition for pardon is received and then report and recommend to the governor what it deem expedient. The governor's salary is fixed by the revised constitution of 1908 at \$5000 a year. The lieutenant-governor succeeds the governor in case of vacancy, and next in order of succession comes the secretary of state.

The legislature, consisting of a Senate of 32 members, and a House of Representatives of 100 members (according to the constitution not less than 64 and not more than 100), meets biennially, in odd-numbered years, at Lansing. Both senators and representatives are elected for a term of two years by single districts, except that a township or city which is entitled by its population to more than one representative elects its representatives on a general ticket. Beginning in 1913 and at each subsequent tenth year, the legislature, under the revised constitution of 1908, rearranges the senatorial districts and reapportions the representatives among the counties and districts, using as a basis the returns of the next preceding decennial census; the taking of a state census between the decennial periods is discontinued.

No bill can pass either house except by an affirmative vote of a majority of the members elected to that house, and on its third reading the yeas and noes must be taken and recorded; for appropriation bills a two-thirds majority of all members elected to each house is required. All legislation must be by bill, legislation by joint and concurrent resolutions thus being prevented. No bill may be passed at a regular session until it has been printed and in possession of each house for five days; no bill may be passed at a special session on any subject not expressly stated in the governor's proclamation or submitted by special message. The governor has ten days (Sundays not being counted) in which to exercise his veto power (which may be applied to any item or items of any bill making appropriations of money and embracing distinct items), and an affirmative vote in each house of two-thirds of the members elected is required to pass a bill over his veto. Under the revised constitution of 1908 any bill passed by the legislature and approved by the governor, except appropriation bills, may be referred by the legislature to the qualified electors; and no bill so referred shall become law unless approved by a majority of the electors voting thereon; no local or special act, passed by the legislature, takes effect until it is approved by a majority vote of the electors in the affected district.

The administration of justice is entrusted to a supreme court, a continually increasing number of circuit courts (thirty-eight

in 1909), one probate court in each county, and not exceeding four justices of the peace in each township. The supreme court is composed of one chief justice and seven associate justices, all elected for a term of ten years, not more than two retiring every two years; it holds four sessions annually, exercises a general control over the inferior courts, may issue, hear and determine any of the more important writs, and has appellate jurisdiction only in all other important cases. There is only one circuit court judge for a circuit, unless the legislature provides for the election of more; the term of office is six years. Circuit court judges have original jurisdiction in most matters civil and criminal, hear appeals from the lower courts, and must hold at least four sessions annually in each county of the circuit. Each county elects a judge of probate for a term of four years; he has original concurrent jurisdiction with the circuit court in matters of probate, and has original jurisdiction in all cases of juvenile delinquents and dependents. The legislature may provide for the election of more than one judge of probate in a county with more than 100,000 inhabitants. Justices of the peace are elected by the townships for a term of four years—there are not more than four in each township; in civil matters they have exclusive jurisdiction of cases in which the demand does not exceed \$100 and concurrent jurisdiction with the circuit courts in contract cases in which the demand does not exceed \$300.

For purposes of local government the state is divided into eighty-three counties, each of which is in turn divided regularly by N. and S. and E. and W. lines into several townships. In the more sparsely inhabited counties of the upper peninsula and in the N.E. section of the lower peninsula the townships are much larger than in other parts of the state. The officers of the township are a supervisor, clerk, treasurer, highway-commissioner, one overseer of highways for each highway district, a justice of the peace, and not more than four constables, all of whom are elected at the annual township meeting in April. The supervisor, two of the justices of the peace and the clerk constitute the township board, whose duty it is to settle claims against the township, audit accounts, and publish annually an itemized statement of receipts and disbursements. The supervisor is also the township assessor, and the several township supervisors constitute the county board of supervisors who equalize property valuations as between townships, authorize townships to borrow money with which to build or repair bridges, are entrusted with the care and management of the property and business of the county, and may borrow or raise by tax what is necessary to meet the more common expenses of the county. Other county officers are a treasurer, clerk, sheriff, register of deeds, attorney, surveyor and two coroners, each elected for a term of two years, a school commissioner elected for a term of four years, and one or more notaries public appointed by the governor.

Under the revised constitution of 1908 the former classification of cities into four classes and the practice of granting special charters were abolished, and the legislature is required to provide by general laws for the incorporation of cities and villages; "such general laws shall limit their rate of taxation for municipal purposes and restrict their powers of borrowing money and contracting debts." Cities and villages are permitted—upon authorization by the affirmative vote of three-fifths of the electors voting on the question—to own and operate, even outside their corporate limits, public utilities for supplying water, light, heat, power and transportation, and may sell and deliver, outside their corporate limits, water, heat, power and light to an amount not more than one-fourth that furnished by them in each case within their corporate limits; but no city or village of less than 25,000 inhabitants may own or operate transportation facilities. Under the revision of 1908 corporate franchises cannot be granted for a longer term than thirty years.

Law.—A wife in Michigan has the same right to her property acquired either before or after marriage as she would have if single, except that she cannot under ordinary circumstances give, grant or

sell it to another without her husband's consent. Grounds for a divorce are adultery, physical incapacity at the time of marriage, sentence to imprisonment for three years or more, desertion for two years, habitual drunkenness, extreme cruelty, or, in case of the wife, refusal of the husband to provide for her maintenance when sufficiently able to do so; but in case the parties were married outside of Michigan the party seeking the divorce must reside within the state at least one year before petitioning for the same. An insolvent debtor's homestead—consisting of not more than 40 acres of land with a house thereon, or a house and lot in a city or village not exceeding \$1500 in value, together with not less than \$500 of his personal property—is exempt from execution. For several years previous to 1876 a clause of the constitution prohibited the sale of intoxicating liquors within the state. Since then the whole liquor business has been subjected to a heavy tax, and since 1887 the prohibition of it has been left to the option of each of the several counties. A state court of mediation and arbitration, consisting of three members appointed by the governor with the consent of the senate, was created in 1889 to inquire into the cause of grievances threatening or resulting in any strike or lock-out and to endeavour to effect a settlement.

Charitable and Penal Institutions.—The state supports the Michigan Asylum for the Insane (opened 1850), at Kalamazoo; the Eastern Michigan Asylum for the Insane (opened 1878), at Pontiac; the Northern Michigan Asylum for the Insane (opened 1885), at Traverse City; the Michigan Asylum for the Dangerous and Criminal Insane (established 1885), at Ionia; the Upper Peninsula Hospital for the Insane, at Newberry; a Psychopathic Hospital (established 1907), at Ann Arbor; a State Sanatorium (established 1905), at Howell; the Michigan State Prison (established 1839), at Jackson; the Michigan Reformatory (established 1887), at Ionia; the State House of Correction and Branch Prison (established 1885), at Marquette; the Industrial School for Boys, at Lansing; the Industrial Home for Girls (established 1879), near Adrian; the State Public School (opened 1874), at Coldwater, a temporary home for dependent children until homes in families can be found for them; the School for the Deaf (established 1854), at Flint; the School for the Blind, at Lansing; an Employment Institution for the Blind (established 1903), at Saginaw; the Home for the Feeble Minded and Epileptic (established 1893), at Lapeer; and the Michigan Soldiers' Home (established 1918), at Grand Rapids. Each of these institutions is under the control of a board of three or more members appointed by the governor with the approval of the Senate, and at the head of the department is the State Board of Corrections and Charities, consisting of the governor and four other members appointed by him, with the approval of the Senate, for a term of eight years, one retiring every two years. This board is required to visit each of the institutions at least once a year to ascertain its condition and needs, and all proposed appropriations for their support, plans of buildings, proposed systems of sewerage, ventilation and heating must be submitted to it.

Education.—Michigan was a pioneer state in creating the American educational system; she began the organization of it at the time of her admission into the Union in 1837, and has since been noted for the high standard of her schools. Each township operating under the District Act has two school inspectors—one being elected at each town meeting for a term of two years—who with the township clerk constitute the township board of school inspectors, and to this board is given authority to divide the township into school districts and to exercise a general supervision over the several schools within their jurisdiction; a township may be organized as a single district, called a "township unit district." The qualified electors of each district having an ungraded school elect a moderator, a director and a treasurer—one at each annual school meeting—for a term of three years, who constitute the district school board, and this board is entrusted with ample power for directing the affairs of the school. In a district having more than 100 children of school age a graded school under the control of five trustees is formed whenever two-thirds of the electors vote for it at a town meeting, and the trustees of a graded school may establish a high school whenever a majority of the electors authorize them to do so. A high school may also be established in any township in which there is no incorporated village or city if when the question is submitted to the electors of that township a majority of the votes cast are in the affirmative. Each county has a county school commissioner, elected for a term of four years, who exercises a general supervision over the schools within his jurisdiction, and a board of examiners, consisting of three members (including the commissioner) and appointed by the several boards of county supervisors, from whom teachers receive certificates. Finally, at the head

of all the public elementary and secondary schools of the state is the state superintendent of public instruction, elected for a term of two years; he is *ex officio* a member and secretary of the state board of education, and a member, with the right to speak but not to vote, of all other boards having control of public instruction in any state institution. In every district having as many as 800 children between the ages of five and twenty the state requires that the school be taught not less than nine months a year; and a compulsory education law requires the attendance of all children between the ages of eight and fifteen for four months each year, in cities all between the same ages for the full school year, and between the ages of seven and sixteen if found frequenting public places without lawful occupation.

The higher state institutions of learning consist of a university, to which graduates of high schools on an accredited list are admitted without examination, four normal schools, an agricultural college, and a school of mines. The university (at Ann Arbor) was established in 1837, and is under the control of a board of regents elected by the people for a term of eight years, two every two years; the president of the institution and the superintendent of public instruction are members of the board but without the right to vote. The state normal schools are: the Michigan State Normal College at Ypsilanti (organized in 1847); the Michigan Normal College at Mount Pleasant (established in 1805); the Northern State Normal School at Marquette (established in 1899); and the Western State Normal School at Kalamazoo (established in 1904). All of them are under the state board of education, which consists of the state superintendent of public instruction and three other members elected, one every two years, for a term of six years. The agricultural college, at East Lansing, 3 m. east of Lansing, is the oldest in the United States; it was provided for by the state constitution of 1850, organized in 1855 and opened in 1857, and is under the control of the state board of agriculture, consisting of the president of the college and six other members elected by popular vote for a term of six years, two every two years. The college of mines, at Houghton, was established in 1885 and is under the control of a board of six members appointed by the governor with the approval of the Senate, two every two years. In 1908 it had 35 instructors, 253 students, and a library of 22,000 volumes. Other important institutions of learning within the state but not maintained by it are: Albion College (Methodist Episcopal; opened in 1843); at Albion; Hillsdale College (Free Baptist, 1855), at Hillsdale; Kalamazoo College (Baptist, 1855), at Kalamazoo; Adrian College (controlled by the Methodist Protestant Church since 1857); Adrian College (Methodist Episcopal, 1859), at Olivet; Hope College (Reformed, 1860), at Holland; Detroit College (Roman Catholic, 1877), at Detroit; Alma College (Presbyterian; incorporated 1886), at Alma; and some professional schools at Detroit (*q.v.*).

Finance.—The revenue of the state is derived almost wholly from taxes, about 87% from a direct or general property tax and the rest from various specific or indirect taxes, such as the liquor tax and the inheritance tax. The direct tax, other than that on the property of corporations, is assessed by the township supervisors, or, in cities and incorporated villages by the officer named in the charter for that service, on what is supposed to be the full cash value of the property. The assessment roll thus prepared is reviewed by a local board of review; an equalization between the assessing districts in a county is made annually by the county board of supervisors, and between the counties in the state every five years (and at such other times as the legislature may direct) by the state board of equalization, which is composed of the lieutenant-governor, auditor-general, secretary of state, treasurer, and commissioner of the land office. But at the head of the whole taxing system is the board of state tax commissioners and *ex officio* state board of assessors, consisting of three members appointed by the governor with the approval of the senate for a term of six years. It exercises a general supervision over all other taxing officers and is itself the assessor of the property of railroads, express companies and certain car companies. Mainly through the efficiency of this board the assessed value of the taxable property of the state was increased from \$668,189,087 in 1899 to \$1,418,251,858 in 1902, or 46.4%, and the taxes levied on railways, which had hitherto been assessed on their gross earnings, were increased from \$1,483,907 in 1901 to \$3,288,162 in 1902, or 121.6%. In entering upon the work of public improvements in 1837 the state borrowed \$5,200,000, and the greater portion of the bonds were sold to the Mercantile and what Bank Company and to the Pennsylvania and the United States Bank, both of which failed when they had only in part paid for the bonds. About this time it was seen that the cost of the improvements undertaken would be much greater than the original estimate and that several of them were impracticable. The difficulty of meeting the interest as it became due soon threatened to be insurmountable, but the state finally sold the improvements made and came out of the experience with good credit although with a large debt—about two and a half millions of dollars. This was further increased during the Civil War, but after the close of that war it was rapidly diminished and finally was extinguished in

the last decade of the century. The present constitution (as revised in 1908) forbids the contraction of a state debt exceeding \$250,000 except for repelling an invasion or suppressing an insurrection, and the borrowing power of the minor civil divisions is restricted by a general law.

The early experience of the state with banks was scarcely less serious than that with public improvements. Although there were already fifteen banks in the state in 1827 yet the cry against monopoly was loud, and so in that year a general banking law was passed whereby any ten or more freeholders might establish a bank with a capital of not less than fifty thousand nor more than three hundred thousand dollars and begin business as soon as 30% of the capital was paid in specie. Only a few provisions were made, and those ineffectual, for the protection of the public: later in the same year the legislature passed an act for the suspension of specie payments until the 6th of May 1838, and the consequence was that the state was flooded with irredeemable paper currency. But most of the "wild cat" banks had passed out of existence by 1839, and in 1844 the bank act of 1837 was declared unconstitutional. Profiting by this experience, the framers of the constitution of 1850 inserted a provision in that document whereby no general banking law can have effect until it has been submitted to the people and has been approved by a majority of the votes cast on the question. This provision is included in the revised constitution adopted in 1908, with an additional provision that no amendment shall be made to any banking law unless it shall receive an affirmative two-thirds vote of both branches of the legislature. The present banking law provides that the capital stock of a state bank shall be not less than \$20,000 in a city of not more than 1500 inhabitants, not less than \$25,000 in a city of not more than 5000, not less than \$50,000 in a city of between 5000 and 20,000, not less than \$100,000 in a city of between 20,000 and 110,000, and not less than \$250,000 in all larger cities. Commercial banks and savings banks are required to keep on hand at least 15% of their total deposits. Every stockholder in a bank is made individually liable to the amount of his stock at its par value in addition to the said stock. And all banks are subject to the inspection and supervision of the commissioner of the state banking department, who is appointed by the governor with the approval of the Senate for a term of four years.

History.—From 1613 until 1760 the territory now within the borders of Michigan formed a part of New France, and the first Europeans to found missions and settlements within those borders were Frenchmen. Two Jesuits, Kaybault and Jogues, visited the site of Sault Sainte Marie as early as 1621 for the conversion of the Chippewas; in 1668 Marquette founded there the first permanent settlement within the state; three years later he had founded a mission among the Hurons at Michilimackinac; La Salle built a fort at the mouth of the Saint Joseph in 1679; and in 1701 Cadillac founded Detroit as an important point for the French control of the fur trade. But the missionaries were not interested in the settlement of the country by Europeans, the fur traders were generally opposed to it, there was bitter strife between the missionaries and Cadillac, and the French system of absolutism in government and monopoly in trade were further obstacles to progress. Even Detroit was so expensive to the government of the mother country that there was occasional talk of abandoning it; and so during the last fifty-nine years that Michigan was a part of new France there were no new settlements, and little if any growth in those already established. During the last war between the English and the French in America the Michigan settlements passed into the possession of the English, Detroit in 1760 and the others in 1761, but the time had not yet come for much improvement. The white inhabitants, still mostly French, were subjected to an English rule that until the Quebec Act of 1774 was chiefly military, and as a consequence many of the more thrifty sought homes elsewhere, and the Indians, most of whom had been allies of the French, were so ill-treated, both by the officers and traders, that under Pontiac, chief of the Ottawas, a simultaneous attack on the English posts was planned. Detroit was besieged for five months and both Michilimackinac and Saint Joseph were taken. Moreover, the English policy, which first of all was concerned with the profits of trade and manufacture, gave little more encouragement to the settlement of this section of the country than did the French. By the Treaty of Paris, in 1783, which concluded the American War of Independence, the title to what is now Michigan passed to the United States, and in 1787 this region became a part of the North-West Territory; but it was not until 1796 that Detroit and Mackinac (Michilimackinac), in

accordance with Jay's Treaty of 1794, were surrendered by Great Britain. In 1800, on the division of the North-West Territory, the west portion of Michigan became a part of the newly-established Indiana Territory, into which the entire area of the present state was embodied in 1802, when Ohio was admitted to the Union; and finally, in 1805, Michigan Territory was organized, its south boundary being then described as a line drawn east from the south extremity of Lake Michigan until it intersected Lake Erie, and its west boundary a line drawn from the same starting point through the middle of Lake Michigan to its north extremity and then due north to the north boundary of the United States. In 1812, during the second war between Great Britain and the United States, General William Hull, first governor of the Territory, although not greatly outnumbered, surrendered Detroit to the British without a struggle; in the same year also Mackinac was taken and Michigan again passed under British rule. This rule was of short duration, however, for soon after Commodore Oliver H. Perry's victory on Lake Erie, in September of the next year, Detroit and the rest of Michigan except Mackinac, which was not recaptured until July 1815, were again taken into the possession of the United States. Up to this time the Territory had still remained for the most part a wilderness in which the fur trade reaped the largest profits, its few small settlements being confined to the borders; and the inaccurate reports of the surveyors sent out by the national government described the interior as a vast swamp with only here and there a little land fit for cultivation. The large number of hostile Indians was also a factor in making the Territory unattractive. But during the efficient administration of Lewis Cass, governor of the Territory from 1813 to 1831, the interference of the British was checked and many of the Indians were removed to the west of the Mississippi; printing presses, established during the same period at Detroit, Ann Arbor, Monroe and Pontiac, became largely instrumental in making the country better known; the first steamboat, the "Walk-in-the-Water," appeared at Detroit in 1818; the Erie canal was opened in 1825; by 1830 a daily boat line was running between Detroit and Buffalo, and the population of Michigan, which was only 4762 in 1810 and 8896 in 1820, increased to 31,639 in 1830 and 212,267 in 1840. In 1819 the Territory had been empowered to send a delegate to Congress. By 1832 the question of admission into the Union had arisen, and in 1835 a convention was called in Detroit, a constitution was framed in May, that constitution was adopted by popular vote in October, state officers were elected, and application for admission was made; but a dispute with Ohio over the boundary between the two caused a delay in the admission by Congress until early in the year 1837. Although the ordinance creating the North-West Territory fixed the boundary line as claimed by Michigan, yet that line was found to be farther south than was at the time expected and when the constitution of Ohio was adopted it was accompanied with a proviso designed to secure to that state a north boundary that was north of the mouth of the Maumee River. The territory between the two proposed lines was unquestionably of greater economic importance to Ohio than to Michigan, and, besides, at this particular time there were forcible political reasons for not offending the older state. The consequence was that after the bloodless "war" between the two states for the possession of Toledo, Congress settled the dispute in Ohio's favour and gave to Michigan the territory since known as the upper peninsula. The boundaries as fixed by Congress were rejected by a convention which met on the 4th of September at Ann Arbor, but they were accepted by the convention of the Jackson party, which met, also at Ann Arbor, on the 6th of December; the action of this latter convention was considered authoritative by Congress, which admitted Michigan into the Union as a state on the 26th of January 1837. Since admission into the Union the more interesting experiences of the state have been with internal improvements and with banking, which together resulted in serious financial distress; in the utilization of its natural resources, which have been a vast source of

wealth; and in the development of its educational system, in which the state has exerted a large influence throughout the Union. From the beginning of its government under its first state constitution in 1835 until 1855 Michigan had a Democratic administration with the exception of the years 1840-1842, when opposition to the financial measures of the Democrats placed the Whigs in power. But it was in Michigan that the Republican party received its first official recognition, at a state convention held at Jackson on the 6th of July 1857, and from the beginning of the following year the administration has been Republican with the exception of two terms from 1883 to 1885, and from 1891 to 1893, when it was again Democratic.

GOVERNORS OF MICHIGAN

Territorial.			
William Hull			1805-1813
Lewis Cass			1813-1831
Stevens Thompson Mason (acting)			1831
George Bryan Porter			1831-1834
Stevens Thompson Mason (acting)			1834-1835
John Scott Horner (acting)			1835
State.			
Stevens Thompson Mason	Democrat		1835-1840
William Woodbridge	Whig		1840-1841
James Wright Gordon (acting)			1841-1842
John Steward Barry	Democrat		1842-1846
Alpheus Felch			1846-1847
William L. Greenly (acting)			1847-1848
Epaphroditus Ransom			1848-1850
John Steward Barry			1850-1851
Robert McClelland			1851-1853
Andrew Parsons (acting)			1853-1855
Moses Wisner			1855-1859
Austin Blair	Republican		1859-1861
			1861-1865
			1865-1869
Henry Howland Crapo			1869-1873
Henry Porter Baldwin			1873-1877
John Judson Bagley			1877-1881
Charles Miller Crowell			1881-1883
David Howell Jerome			1883-1885
Josiah W. Begole	Democrat and Greenback		1885-1887
Russell Alexander Alger	Republican		1887-1891
Cyrus Baruch Winans			1891-1893
Edwin Gary Lucas	Democrat		1893-1897
John T. Rich	Republican		1897-1901
Hazen Smith Piessree			1901-1905
Aaron Thomas Bliss			1905-1911
Fred M. Warner			1911
Chase S. Osborn			

AUTHORITIES.—The *Publications of the Michigan Geological Survey* (Detroit, Lansing and New York, 1838 seq.) deal largely with the mining districts of the upper peninsula. Alexander Winchell, *Michigan: Being Condensed Popular Sketches of the Topography, Climate and Geology of the State* (1873), is in large measure restricted to the south half of the state. W. J. Beal and C. F. Wheeler, *Michigan Flora* (Lansing, 1892), contains the results of an extensive study of the subject. See also the *Twelfth Census of the United States* (Washington, 1901-1902); Silas Farmer, *Michigan Book: a State Cyclopaedia with Sections County Maps* (Detroit, 1901); Bela Hubbard, *Memorials of a Half-Century* (New York, 1887), a well written account of observations, chiefly upon scenery, fauna, flora and climate; Webster Cook, *Michigan: its History and Government* (New York, 1905), written primarily for use in schools and containing a reference bibliography; A. C. McLaughlin, *History of Higher Education in Michigan*, in *Circulars of Information of the United States Bureau of Education* (Washington, 1891), being an account of the origin of the public school system and an individual account of each higher institution of learning; T. M. Cooley, *Michigan: a History of Government* (Boston, 1885), a critical but popular narrative by an eminent jurist; J. V. Campbell, *Outlines of the Political History of Michigan* (Detroit, 1876), also by a jurist of the state; Henry M. Utley and Byron M. Cutcheon, *Michigan as a Province, Territory and State* (4 vols., New York, 1906); Michigan Pioneer and Historical Society, *Historical Collections: Collections and Researches* (Lansing, 1877 seq.); and *Publications of the Michigan Political Science Association* (Ann Arbor, 1893).

MICHIGAN LAKE, the only one of the great lakes of North America wholly within the boundaries of the United States, and the second largest body of fresh water in the world. It lies S. of Lake Superior and W. of Lake Huron, between 41° 37' and 46° 05' N. and 84° 45' and 88° W.; is bounded on the N. and E. by the state of Michigan, on the W. by Wisconsin, while Illinois and Indiana touch its S. end. It is 320 m. long, and has an average width of 65 m. The maximum depth recorded by the United States Lake Survey is

870 ft.; the mean level of the surface is 58½ ft. above mean sea-level, being the same as that of Lake Huron and 21 ft. below that of Lake Superior. Its area is 22,400 sq. m., and it has a basin 68,100 sq. m. in area.

The shores of Lake Michigan are generally low and sandy, and the land slopes gradually to the water. The northern shore of the lake is irregular and more rugged and picturesque than the other shores, the summit of the highest peak being about 1400 ft. above the sea. On the eastern side are numerous sand hills, formed by the wind into innumerable fantastic shapes, sometimes covered with stunted trees and scanty vegetation, but usually bare and rising to heights of from 150 to 250 ft. The south-western shore is generally low, with sand hills covered with shrivelled pines and bur oaks. Along the western shore woods and prairies alternate, interspersed with a few high peaks. The cliffs on the east shore of Green Bay form a bold escarpment, and from this ridge the land slopes gradually to the lake. With the exception of Green and Traverse bays, Lake Michigan has few indentations of the coast line, and except at the north end it is free from islands. The waters near shore are shoal, and as there are few harbours of refuge of easy access navigation is dangerous in heavy storms. Around the lake the climate is equable, for, though the winter is cold and the summer hot, the waters of the lake modify the extremes, the mean temperature varying from 40° to 54° F. The average annual rainfall is 33 in. The finest agricultural land in the United States is near the lake, and there is an immense trade in all grains, fruits, livestock and lumber, and in products such as flour, pork, hides, leather goods, furniture, &c. Rich lead and copper mines abound, as also salt, iron and coal. Abundant water power promotes manufactures of all kinds. Beer and distilled liquors are largely manufactured, and fine building stone is obtained from numerous quarries.

The lake is practically tideless, though true tidal pulsations amounting to 3 in. in height are stated to have been observed in Chicago. In the water of the lake there is a general set of current towards the outlet at the strait of Mackinac, following the east shore, with slight circular currents in the main portion of the lake and at the northern end around Beaver island. These currents vary in speed from 4 to 10 m. per day. Surface currents are set up by prevailing winds, which also seriously affect water levels, lowering the water at Chicago and raising it at the strait, or the reverse, so as greatly to inconvenience navigation. The level of the lake is subject to seasonal fluctuations, reaching a maximum in midsummer and a minimum in February, as well as to alternating cycles of years of high and low water. Standard high-water of 1838 was 3.36 ft. above mean level and standard low-water of 1895, 2.82 ft. below that datum, giving an extreme recorded range slightly over 6 ft.

The northern portion of the lake only is covered with ice in winter, and ice never reaches as far south as Milwaukee. Milwaukee River remains closed on an average for one hundred days—from the beginning of December to the middle of March. The average date of the opening and closing of navigation at the strait of Mackinac, where the ice remains longest, is the 17th of April and the 9th of January respectively.¹ Regular lines of steamers specially equipped to meet winter conditions, most of them being car ferries, cross the lake and the strait of Mackinac all winter between the various ports.

No notable rivers flow into Lake Michigan, the largest being the Big Manistee and Muskegon on the east shore, and on the west shore the Menominee and the Fox, both of which empty into Green Bay, the most important arm of the lake. The numerous harbours are chiefly artificial, usually located at the mouths of streams, the improvements consisting of two parallel piers extending into the lake and protecting a dredged channel. Sand bars keep filling up the mouths of these channels, necessitating frequent dredging and extension of the breakwaters, work undertaken by the Federal government, which also maintains a most comprehensive and complete system of aids to navigation, including lighthouses and light-ships, fog alarms, gas and other buoys, life-saving, storm signal and weather report stations.

¹ Report of Deep Waterways Commission (1896).

Chicago, the principal port on the lake, is at its south-west extremity, and is remarkable for the volume of its trade, the number of vessels arriving and departing exceeding that of any port in the United States, though the tonnage is less than that of New York. It is a large railway centre, and the number and size of the grain elevators are noticeable. The port is protected by breakwaters enclosing a portion of the lake front. The level of the city above the lake being only 14 ft., much difficulty arose in draining it. A sanitary and ship canal 24 m. long was therefore completed in 1900 to divert the Chicago river, a small stream that flows into the lake, into the head waters of the Des Plaines river and thence through the river Joliet into the Mississippi at St. Louis. The discharge of water is by law so regulated that the maximum flow shall not exceed 250,000 cub. ft. per minute. The effect upon the permanent level of the lakes of the withdrawal of water through this artificial outlet is receiving much attention. Milwaukee, situated on the shore of Milwaukee Bay, on the western side of the lake, is, next to Chicago, the largest city on the lake, and has a large commerce and a harbour of refuge. Escanaba, on Little Bay de Noc (Noquette), in the northern part of the lake, is a natural harbour and a large iron shipping port. Green Bay and Lake Michigan are connected by a canal extending from the lake to the head of Sturgeon Bay. Lake Michigan is connected at its north-east extremity with Lake Huron by the strait of Mackinac, 48 m. long, with a minimum width of 6 m.; the water is generally deep and the shoals lying near the usually travelled routes are well marked.

BIBLIOGRAPHY.—*Sailing directions for Lake Michigan, Green Bay, and the Strait of Mackinac*, U.S. Navy Hydrographic office publication No. 108 B (Washington, 1906). *Bulletin No. 17: Survey of North and North-west Lakes*, U.S. Lake Survey Office (Detroit, Michigan, 1907). *St. Lawrence Pilot*, 7th ed., Hydrographic Office Admiralty (London, 1906); *Effect of Withdrawal of Water from Lake Michigan by the Sanitary District of Chicago*, U.S. House of Representatives' Document No. 6, 59th Congress, 1st session (Washington, 1906). (W. P. A.)

MICHIGAN, UNIVERSITY OF, one of the principal educational institutions of the United States, situated at Ann Arbor, Michigan. It embraces a department of literature, science and the arts (including industry and commerce), opened in 1841, and including a graduate school, organized in 1892; a department of medicine and surgery, opened in 1850; a department of law, opened in 1859; a school of pharmacy, opened as a separate department in 1876; a homoeopathic medical college, opened in 1875; a college of dental surgery, opened in 1875; and a department of engineering, separately organized in 1895, which includes courses in marine engineering, architecture, and architectural engineering. The university was one of the first to admit women, having opened its doors to them in 1870 as a natural consequence of its receiving aid from the state (since 1867), and since 1900 they have constituted nearly one-half of the student body in the department of literature, science and the arts. In 1907-1908 there were in all departments 350 instructors and 5013 students (1796 in the department of literature, science and the arts; 1354 in the department of engineering; 391 in the department of medicine and surgery; 791 in the department of law; 101 in the school of pharmacy; 82 in the homoeopathic medical college; 168 in the college of dental surgery; and 1070 in the summer sessions). Besides the several main department buildings there is a library building, a museum building, several laboratories, a gymnasium for men, and a gymnasium for women. The general library in 1908 contained 172,940 volumes, 3800 pamphlets, and 3370 maps, and the several department libraries brought the total up to 222,600 volumes and 5000 pamphlets. The general museum contains large zoological collections, geological and anthropological collections, including the exhibit of the Chinese government at the New Orleans Exposition, which was given by the government to the university in 1885; there are besides several special collections in some of the laboratories. The astronomical observatory is surmounted by a movable dome in which is mounted a refracting telescope having a thirteen-inch object glass. The several laboratories are equipped for use in instruction in physics, chemistry, mineralogy, geology, zoology, psychology, botany, forestry, actuarial work, engineering, histology, physiology, hygiene, electrotherapeutics, pathology, anatomy and dentistry.

The university is governed from without by a board of eight regents elected by popular suffrage, two biennially, at the same time as the election of judges of the supreme court; from

within the government is to a large extent in the hands of a university senate, in which the faculty of each department is represented. The university is maintained by a permanent annuity of \$30,000, derived from the land set apart for it by the Ordinance of 1787, by the proceeds of a three-eighths mill tax, and by small fees paid by the students. Its organic relation to the other public schools of the state was well established in 1870, when it was provided that graduates from such high schools as had been examined and approved by a committee of the university should be admitted without examination; one of the most important functions of the university is to prepare students for teaching in the high schools.

The first charter for a university within what is now the state was granted by the governor and judges of the Territory of Michigan in 1817, for a "Catholopistemiad," or University of Michigania, with a remarkable "Greek" system of nomenclature for its courses and faculties; this institution did practically no teaching. A second charter was granted in 1821, for a University of Michigan in Detroit; but little was accomplished until the admission of Michigan into the Union as a state in 1837, when by the third charter the aim was to model the institution after the German university minus the theological department, and the university was entrusted to a board of regents and a chancellor appointed by the governor. Branches to correspond to the German gymnasia were established in the principal towns before any money was spent on the University proper, but the question of the constitutionality of their establishment and maintenance arose, and they were soon discontinued. Plans for building at Ann Arbor were begun in 1838. The first class graduated in 1845. The department of literature, science and the arts was at first much like a New England college. For some time the prospects did not seem promising; but in 1851 a new state constitution provided that the regents should be elected, and directed them to choose a president; and it was under the administration (1852-1863) of the first incumbent of that office, Henry Philip Tappan (1805-1881), that the present broad and liberal basis was established. Although he was a Presbyterian clergyman, he endeavoured at the outset to substitute the tests of scholarship for those of religion; at the same time a scientific course was introduced, courses in pedagogy followed, and in 1878 the elective system, which has since rapidly expanded, was established. President Tappan was succeeded in 1863 by Erastus Otis Haven (1820-1881), who resigned in 1869, and was succeeded temporarily (1869-1871) by Professor Henry S. Frieze (1817-1889), and in 1871 by James Burrill Angell (b. 1829),¹ who resigned in 1909. In 1871-1872 the German seminar method was introduced in graduate work in history, by Prof. Charles Kendall Adams (1835-1902), afterwards president of Cornell University (1885-1892) and of the University of Wisconsin (1892-1902).

See B. A. Hinsdale and I. N. Demmon, *History of the University of Michigan* (Ann Arbor, 1906); Elizabeth M. Farrand, *History of the University of Michigan* (Ann Arbor, 1885); and *The Quarter Centennial of the Presidency of James Burrill Angell* (Ann Arbor, 1896).

MICHIGAN CITY, a city of Laporte county, Indiana, U.S.A., on the S.E. shore of Lake Michigan, about 40 m. E. of S. of Chicago. Pop. (1890) 10,776; (1900) 14,850, of whom 3662 were foreign-born; (1910 census) 19,027. Michigan City is served by the Chicago, Indianapolis & Louisville, the Lake Erie & Western, the Michigan Central and the Père Marquette railways, by interurban electric lines, and by several lines of lake steamships. The city contains a United States Life Saving Station and the Indiana State Prison, and is the seat of a Protestant Episcopal bishop. Its transportation

¹ President Angell graduated in 1849 at Brown University, where he was assistant librarian in 1849-1850 and was professor of modern languages in 1853-1860; was editor of the *Providence Journal* in 1860-1866; was president of the University of Vermont in 1866-1871, was United States minister to China in 1880-1881, was a member of the joint commission of 1887-1888 to settle fishery disputes between the United States and Great Britain, was chairman of the international deep waterways commission in 1896, and in 1897-1898 was United States minister to Turkey.

advantages make it one of the principal commercial cities in the state. Its shipments of lumber are of special importance, and it has also a large transshipment trade in salt and iron ore. The total factory product in 1905 was valued at \$6,314,226. The municipality owns and operates its water-works system. Michigan City was first settled about 1830, was incorporated as a village in 1837, and was first chartered as a city in 1867.

MICHMASH, a place in Benjamin, about 9 Roman miles north of Jerusalem (*Onom.*, ed. Lag., p. 280), the scene of one of the most striking episodes in Old Testament history (1 Sam. xiv.). Though it did not rank as a city (not being mentioned in Joshua xviii. 21 seq.), Michmash was reconquered after the exile (Neh. xi. 31), and, favoured by the possession of excellent wheat-land (*Mishna*, Men. viii. 1), was still a very large village (*Maxpás*) in the time of Eusebius. The modern Mukhmas is quite a small place.

The historical interest of Michmash is connected with the strategical importance of the position, commanding the north side of the Pass of Michmash, which made it the headquarters of the Philistines and the centre of their forays in their attempt to quell the first rising under Saul, as it was also at a later date the headquarters of Jonathan the Hasmonæan (1 Macc. ix. 73). From Jerusalem to Mount Ephraim there are two main routes. The present caravan road keeps the high ground to the west near the watershed, and avoids the Pass of Michmash altogether. But another route, the importance of which in antiquity may be judged of from Isa. x. 28 seq., led southwards from Ai over an undulating plateau to Michmash. Thus far the road is easy; but at Michmash it descends into a very steep and rough valley, which has to be crossed before ascending to Geba.¹ At the bottom of the valley is the Pass of Michmash, a noble gorge with precipitous craggy sides. On the north the crag is crowned by a sort of plateau sloping backwards into a round-topped hill. This little plateau, about a mile east of the present village of Mukhmas, seems to have been the post of the Philistines, lying close to the centre of the insurrection, yet possessing unusually good communication with their establishments on Mount Ephraim by way of Ai and Bethel, and at the same time commanding the routes leading down to the Jordan from Ai and from Michmash itself. See further C. R. Conder, *Tentwork* ii. 112 seq.; and T. K. Cheyne in *Encyc. Bib.*, s.s. (R. A. S. M.)

MICHOACÁN, or MICHOACÁN DE OCAÑO, a state of Mexico touching on the Pacific, bounded N. by Jalisco and Guanajuato, E. by Mexico and Guerrero, S. by Guerrero and the Pacific, and W. by the Pacific, Colima, and Jalisco. Pop. (1900), 935,868, chiefly Indians and mestizos. Area, 22,874 sq. m. Its territory is divided into two nearly equal parts by the eastern branch of the Sierra Madre Occidental, the northern part belonging to the great central plateau region, and the southern to an extremely broken region formed by the diverging branches of the Sierra Madre, with their wooded terraces and slopes and highly fertile valleys. The general slope of the southern part is southward to the river Balsas, or Mescala, which forms its boundary-line with Guerrero. The narrow coastal zone on the Pacific is only 101 m. long and has no ports or towns of importance, the slopes of the Sierra Madre del Pacífico being precipitous and heavily wooded and the coast-belt sandy, hot and malarial. The Lerma, on the northern frontier, and the Balsas on the southern, are the only rivers of importance of the state, their tributaries within its boundaries being small and swift-flowing. There are several large and beautiful lakes in the state, the best known of which are Patzcuaro and Cuitzeo. Lake Chapala lies on the northern boundary. Michoacán lies within the most active volcanic region of Mexico: Jorullo (4262 ft.) is near its southern line, and Colima (12,750 ft.) is northwest of it in the state of Jalisco. Earthquake shocks are numerous, and Colima was in violent eruption in 1908-1909. The highest summit in the state is Tancitaro (12,660 ft.). The climate is for the most part temperate and healthy, but it is hot and unhealthy on the coast. Michoacán is essentially a mining region, producing gold, silver, lead and cinnabar, and having rich deposits of copper, coal, petroleum and sulphur. The natural products include fine cabinet and construction woods, rubber, fruit, palm oil and fibres. The soil of the valleys is highly fertile, and produces cereals in the higher

¹ So Isa. x. 28 describes the invader as leaving his heavy baggage at Michmash before pushing on through the pass.

regions, and sugar-cane, tobacco, coffee and tropical fruits in the lower. Though the plateau region was settled soon after the arrival of the Spaniards in Mexico, there are large districts on the southern and Pacific slopes that still belong almost exclusively to the Indians. Besides Morelia, the capital and largest city, the principal towns of the state are: La Piedad (pop. 15,123), an important commercial town on the Lerma river and on the Mexican Central railway, 112 m. N.N.W. of Morelia; Zamora (10,373), 75 m. W.N.W. of Morelia; Uruapan (9808), on the Mexican National, 55 m. S.W. of Morelia in a mountainous district celebrated for the fine quality of its coffee; Puraúndiro (7782), a commercial and manufacturing town 40 m. N.W. of Morelia; Patzcuaro (7621), on Patzcuaro lake, with a station on the Mexican National, 7550 ft. above sea level; Sahuayo (7408), 103 m. W. by N. of Morelia near Lake Chapala; Zitacuaro (6052), 60 m. S.E. of Morelia on a branch of the Mexican National, which also passes through the mining town of Angangué (9115) in the same district; and Tacambaro (5070), 46 m. S.S.W. of Morelia in a fertile valley of the Rio de las Balsas basin.

MICKIEWICZ, ADAM (1798-1855), Polish poet, was born in 1798, near Nowogrodek, in the present Russian government of Minsk, where his father, who belonged to the *schlachta* or lesser nobility, had a small property. The poet was educated at the university of Vilna; but, becoming involved in some political troubles there, he was forced to terminate his studies abruptly, and was ordered to live for a time in Russia. He had already published two small volumes of miscellaneous poetry at Vilna, which had been favourably received by the Slavonic public, and on his arrival at St Petersburg he found himself admitted to the leading literary circles, where he was a great favourite both from his agreeable manners and his extraordinary talent of improvisation. In 1825 he visited the Crimea, which inspired a collection of sonnets in which we may admire both the elegance of the rhythm and the rich oriental colouring. The most beautiful are *The Storm*, *Bachisera*, and *Grave of the Countess Polocka*.

In 1828 appeared his *Konrad Wallenrod*, a narrative poem describing the battles of knights of the Teutonic order with the heathen Lithuanians. Here, under a thin veil, Mickiewicz represented the sanguinary passages of arms and burning hatred which had characterized the long feuds of the Russians and Poles. The objects of the poem, although evident to many, escaped the Russian censors, and it was suffered to appear, although the very motto, taken from Machiavelli, was significant: "Dovete adunque sapere come sono due generazioni da combattere . . . bisogna essere volpe e leone." This is a striking poem and contains two beautiful lyrics. After a five years' exile in Russia the poet obtained leave to travel; he had secretly made up his mind never to return to that country or Poland so long as it remained under the government of the Muscovites. Wending his way to Weimar, he there made the acquaintance of Goethe, who received him cordially, and, pursuing his journey through Germany, he entered Italy by the Splügen, visited Milan, Venice, and Florence, and finally took up his abode at Rome. There he wrote the third part of his poem *Dziady*, the subject of which is the religious commemoration of their ancestors practised among Slavonic nations, and *Pan Tadeusz*, his longest poem, by many considered his masterpiece. A graphic picture is drawn of Lithuania on the eve of Napoleon's expedition to Russia in 1812. In this village idyll, as Brückner calls it, Mickiewicz gives us a picture of the homes of the Polish magnates, with their somewhat boisterous but very genuine hospitality. We see them before us, just as the knell of their nationalism, as Brückner says, seemed to be sounding, and therefore there is something melancholy and dirge-like in the poem in spite of the pretty love story which forms the main incident. Mickiewicz turned to Lithuania with the loving eyes of an exile, and gives us some of the most delightful descriptions of Lithuanian skies and Lithuanian forests. He describes the weird sounds to be heard in the primeval woods in a country where the trees were sacred. The cloud-pictures

are equally striking. There is nothing finer in Shelley or Wordsworth.

In 1832 Mickiewicz left Rome for Paris, where his life was for some time spent in poverty and unhappiness. He had married a Polish lady, Selina Szymanowska, who became insane. In 1840 he was appointed to the newly founded chair of Slavonic languages and literature in the Collège de France, a post which he was especially qualified to fill, as he was now the chief representative of Slavonic literature, Pushkin having died in 1837. He was, however, only destined to hold it for a little more than three years, his last lecture having been given on the 28th of May 1844. His mind had become more and more disordered under the influence of religious mysticism. He had fallen under the influence of a strange fanatic named Towianski. His lectures became a medley of religion and politics, and thus brought him under the censure of the Government. A selection of them has been published in four volumes. They contain some good sound criticism, but the philological part is very defective, for Mickiewicz was no scholar, and he is obviously only well acquainted with two of the literatures, viz. Polish and Russian, the latter only till the year 1830. A very sad picture of his declining days is given in the memoirs of Herzen. At a comparatively early period the unfortunate poet exhibited all the signs of premature old age; poverty, despair and domestic affliction had wrought their work upon him. In 1840 he founded a French newspaper, *La Tribune des peuples*, but it only existed a year. The restoration of the French Empire seemed to kindle his hopes afresh; his last composition is said to have been a Latin ode in honour of Napoleon III. On the outbreak of the Crimean War he was sent to Constantinople to assist in raising a regiment of Poles to take service against the Russians. He died suddenly there in 1855, and his body was removed to France and buried at Montmorency. In 1900 his remains were disinterred and buried in the cathedral of Cracow, the Santa Croce of Poland, where rest, besides many of the kings, the greatest of her worthies.

Mickiewicz is held to have been the greatest Slavonic poet, with the exception of Pushkin. Unfortunately in other parts of Europe he is but little known; he writes in a very difficult language, and one which it is not the fashion to learn. There were both pathos and irony in the expression used by a Polish lady to a foreigner, "Nous avons notre Mickiewicz à nous." He is one of the best products of the so-called romantic school. The Poles had long groaned under the yoke of the classicists, and the country was full of legends and picturesque stories which only awaited the coming poet to put them into shape. Hence the great popularity among his countrymen of his ballads, each of them being connected with some national tradition. Besides *Konrad Wallenrod* and *Pan Tadeusz*, attention may be called to the poem *Graszyna*, which describes the adventures of a Lithuanian chieftainess against the Teutonic knights. It is said by Ostrowski to have inspired the brave Emilia Plater, who was the heroine of the rebellion of 1830, and after having fought in the ranks of the insurgents, found a grave in the forests of Lithuania. A fine vigorous Oriental piece is *Farys*. Very good too are the odes to Youth and to the historian Lelewel; the former did much to stimulate the efforts of the Poles to shake off their Russian conquerors. It is enough to say of Mickiewicz that he has obtained the proud position of the representative poet of his country; her customs, her superstitions, her history, her struggles are reflected in his works. It is the great voice of Poland appealing to the nations in her agony.

His son, Ladislas Mickiewicz, wrote *Vie d'Adam Mickiewicz* (Posen, 1890-1895, 4 vols.), also *Adam Mickiewicz, sa vie et son oeuvre* (Paris, 1888). Translations into English (1881-1885) of *Konrad Wallenrod* and *Pan Tadeusz* were made by Miss Biggs. See also *Œuvres poétiques de Mickiewicz*, trans. by Christien Ostrowski (Paris, 1845).

MICKLE, WILLIAM JULIUS (1735-1788), Scottish poet, son of the minister of Langholm, Dumfriesshire, was born on the 28th of September 1735. He was educated at the Edinburgh high school, and in his fifteenth year entered business as a

brewer. His father purchased the business, and on his death William Mickle became the owner; but he neglected his affairs, devoting his time to literature, and before long became bankrupt. In 1763 he went to London, where in 1765 he published "a poem in the manner of Spenser" called the *Concubine* (afterwards *Syr Martyn*); was appointed corrector to the Clarendon Press, and translated the *Lusid* of Camoens into heroic couplets (specimen published 1771, whole work, 1775). So great was the repute of this translation that when Mickle—appointed secretary to Commodore Johnstone—visited Lisbon in 1779, the king of Portugal gave him a public reception. On his return to London he was appointed one of the agents responsible for the distribution of prize-money, and this employment, in addition to the sums brought him by his translation of the *Lusid*, placed him in comfortable circumstances.

It has been suggested that the Scottish poem "There's nae luck about the hoose" was Mickle's. It is more likely, however, that Jean Adams was the author. Scott read and admired Mickle's poems in his youth, and founded *Kentworth* on his ballad of *Cumner Hall*, which appeared in Thomas Evans's *Old Ballads . . . with some of Modern Date* (1784).

MICMAC, a tribe of North American Indians of Algonquian stock. They formerly occupied all Nova Scotia, Cape Breton and Prince Edward Islands, and portions of New Brunswick, Quebec and Newfoundland. They fought on the French side in the colonial wars. They are now civilized and almost all profess Catholicism. They number some 4000 in settled communities throughout their former territory.

There is an excellent account of the Micmac Indians in J. G. Millais's *Newfoundland and its Untrodden Ways* (1908).

MICON, a Greek painter of the middle of the fifth century B.C. He was closely associated with Polygnotus of Thasos, in conjunction with whom he adorned the Painted Stoa, at Athens, with paintings of the battle of Marathon and other battles. He also painted in the Anaceum at Athens.

MICROCLINE, a rock-forming mineral belonging to the feldspar group (see FELSPAR). Like orthoclase it is a potash-feldspar with the formula $KAlSi_3O_8$, but differs from this in crystallizing in the anorthic system. The name (from Greek μικρός, small, and κλίνειν, to incline) was given by A. Breithaupt in 1830, and has reference to the fact that the angle ($89^\circ 30'$) between the two perfect cleavages differs but little from a right angle: the species was, however, first definitely established by A. Des Cloizeaux in 1836. The crystals and cleavage masses are very like orthoclase in appearance, and the hardness (6) and specific gravity (2.56) are the same for the two minerals; there are, however, important differences in the twinning and in the optical characters. In addition to being twinned according to the same laws as orthoclase, microcline is repeatedly twinned according to the albite-law and the pericline-law, producing a very characteristic grating or cross-hatched structure which is especially prominent when thin sections of the mineral are examined in polarized light. This lamellar structure is often on a very minute scale, sometimes so minute as to be almost indistinguishable; it has therefore been suggested that orthoclase is really a microcline in which the twin-lamellae are ultra-microscopic. In a section parallel to the basal plane c (001) of a microcline crystal the lamellae do not extinguish optically parallel to the edge bc as in orthoclase, but at an angle of $15^\circ 30'$; further, the obtuse bisectrix of the optic axes in microcline is inclined to the normal of the plane b (010) at an angle of $15^\circ 26'$. Green microcline is distinctly pleochroic.

Microcline occurs, usually with orthoclase, as a constituent of pegmatites, granites and gneisses; it is rare in porphyries and is not known in volcanic rocks. A beautiful crystallized variety of a bright verdigris-green colour is known as amazonstone (*q.v.*). Chesterite is a variety occurring as crystals on dolomite in Chester county, Pennsylvania.

Closely allied to microcline is the anorthic soda-potash-feldspar known as anorthoclase or natron-microcline. Here sodium predominates over potassium and a little calcium is also often present, the formula being $(Na, K) AlSi_3O_8$. It resembles microcline in having a cleavage angle of very nearly 90° and in the cross-hatched structure, the latter being usually very minute and giving rise to a mottled

extinction. It is the characteristic feldspar of volcanic rocks which are rich in soda, and is typically developed in the lavas of the island of Pantelleria near Sicily and those of Kilimanjaro and Mount Kenya in East Africa: the rhomb-shaped porphyritic feldspars of the "rhomb-porphry" of southern Norway also belong here.

(L. J. S.)

MICROCOSM, a term often applied in philosophical and in general literature to man regarded as a "little world" (Gr. *κόσμος κόσμος*) in opposition to the "macrocosm," great world, in which he lives. From the dawn of speculative thought in Greece the analogy between man and the world has been a common-place, and may be traced from Heraclitus and Empedocles, through Plato, Aristotle, the Stoics, the Schoolmen and the thinkers of the Renaissance down to the present day. Thus Lotze's comprehensive survey of mental and moral science is termed *Micocosmus*. The most systematic expression of the tendency indicated by the term is the monadology of Leibnitz, in which the monad is regarded as containing within its own closed sphere an expression of the universe, the typical created monad being the human soul.

MICROCOSMIC SALT, or ammonium sodium hydrogen orthophosphate, $\text{NH}_4\text{NaHPO}_4 \cdot 4\text{H}_2\text{O}$, so named by the alchemists because it is contained in the decomposing urine of man (the "microcosm"). It is interesting historically as being the raw material from which Brand prepared phosphorus, whence it is also called "salt of phosphorus." It may be obtained in large transparent crystals from a mixture of solutions of sal-ammoniac and disodium phosphate, or by saturating a solution of monosodium phosphate with ammonia. When heated to redness, it leaves a transparent glass of sodium metaphosphate, NaPO_3 , which like borax dissolves most metallic oxides, with formation of glasses that often exhibit characteristic colours, and which may be used in the qualitative analysis of substances. (See CHEMISTRY, § *Analytical*.)

MICROMETER (from Gr. *μικρός*, small, *μέτρον*, a measure), an instrument generally applied to telescopes and microscopes for measuring small angular distances with the former or the dimensions of small objects with the latter.

Before the invention of the telescope the accuracy of astronomical observations was necessarily limited by the angle that could be distinguished by the naked eye. The angle between two objects, such as stars or the opposite limbs of the sun, was measured by directing an arm furnished with fine "sights" (in the sense of the "sights" of a rifle) first upon one of the objects and then upon the other (*q.s.*), or by employing an instrument having two arms, each furnished with a pair of sights, and directing one pair of sights upon one object and the second pair upon the other. The angle through which the arm was moved, or, in the latter case, the angle between the two arms, was read off upon a finely graduated arc. With such means no very high accuracy was possible. Archimedes concluded from his measurements that the sun's diameter was greater than $27'$ and less than $32'$; and even Tycho Brahe was so misled by his measures of the apparent diameters of the sun and moon as to conclude that a total eclipse of the sun was impossible.¹ Michael Maestlin in 1579 determined the relative positions of eleven stars in the Pleiades (*Historia coelestis Lucii Borelli*, Augsburg, 1666), and A. Winnecke has shown (*Monthly Notices R.A.S.*, xxxix. 146) that the probable error of these measures amounted to about $\pm 2'$.

The invention of the telescope at once extended the possibilities of accuracy in astronomical measurements. The planets were shown to have visible disks, and to be attended by satellites whose distance and position angle relative to the planet it was desirable to measure. It became, in fact, essential to invent a "micrometer" for measuring the small angles which were thus for the first time rendered sensible. There is no doubt that William Gascoigne, a young gentleman of Yorkshire, was the first

inventor of the micrometer. William Crabtree, a friend of his, taking a journey to Yorkshire in 1639 to see Gascoigne, writes thus to his friend Jeremiah Horrocks. "The first thing Mr Gascoigne showed me was a large telescope amplified and adorned with inventions of his own, whereby he can take the diameters of the sun and moon, or any small angle in the heavens or upon the earth, most exactly through the glass, to a second." The micrometer so mentioned fell into the possession of Richard Townley of Lancashire, who exhibited it at the meeting of the Royal Society held on the 25th of July 1667.

The principle of Gascoigne's micrometer is that two pointers having parallel edges at right angles to the measuring screw, are moved in opposite directions symmetrically with and at right angles to the axis of the telescope. The micrometer is at zero when the two edges are brought exactly together. The edges are then separated till they are tangent to the opposite limbs of the disk of the planet to be measured, or till they respectively bisect two stars, the angle between which is to be determined. The symmetrical separation of the edges is produced and measured by a single screw; the fractions of a revolution of the screw are obtained by an index attached to one end of the screw, reading on a dial divided into 100 equal parts. The whole arrangement is elegant and ingenious. A steel cylinder (about the thickness of a goose-quill), which forms the micrometer screw, has two threads cut upon it, one-half being cut with a thread double the pitch of the other. This screw is mounted on an oblong box which carries one of the measuring edges; the other edge is moved by the coarser part of the screw relatively to the edge attached to the box, whilst the box itself is moved relatively to the axis of the telescope by the finer screw. This produces an opening and closing of the edges symmetrically with respect to the telescope axis. Flamsteed, in the first volume of the *Historia coelestis*, has inserted a series of measurements made by Gascoigne extending from 1638 to 1643. These include the mutual distances of some of the stars in the Pleiades, a few observations of the apparent diameter of the sun, others of the distance of the moon from neighbouring stars, and a great number of measurements of the diameter of the moon. Dr John Bevis (*Phil. Trans.* (1773), p. 190) also gives figures of measurements by Gascoigne of the diameters of the moon, Jupiter, Mars and Venus with his micrometer.

Delambre gives² the following comparison between the results of Gascoigne's measurements of the sun's semi-diameter and the computed results from modern determinations:—

	Gascoigne.	Conn. d. temps.
October 25 (o.s.)	$16' 11''$ or $10''$	$16' 10'' \cdot 0$
" 31 "	$16' 11''$	$16' 11'' \cdot 4$
December 2 "	$16' 24''$	$16' 16'' \cdot 8$

Gascoigne, from his observations, deduces the greatest variation of the apparent diameter of the sun to be $35'$; according to the *Connaissance des temps* it amounts to $32' \cdot 3$.³ These results prove the enormous advance attained in accuracy by Gascoigne, and his indisputable title to the credit of inventing the micrometer.

Huygens, in his *Systema saturnium* (1659), describes a micrometer with which he determined the apparent diameters of the principal planets. He inserted a slip of metal, of variable breadth, at the focus of the telescope, and observed at what part it exactly covered the object under examination; knowing the focal length of the telescope and the width of the slip at the point observed, he thence deduced the apparent angular breadth of the object. The Marquis Malvasia in his *Ephemérides* (Bologna, 1662) describes a micrometer of his own invention. At the focus of his telescope he placed fine silver wires at right angles to each other, which, by their intersection, formed a network of small squares. The mutual distances of the intersecting wires he determined by counting, with the aid of a pendulum clock, the number of seconds required by an equatorial star to pass from web to web, while the telescope was adjusted so that the star ran parallel to the wires at right angles to those under investigation.⁴ In the *Phil. Trans.* (1667), No. 21, p. 373, Adrien Auzout gives the results of some measures of the diameter of the sun and moon made by himself, and this communication led to the letters of Townley and Bevis above referred to. The micrometer of Auzout and Picard was provided with silk fibres or silver wires instead of the edges of Gascoigne, but one of the silk fibres remained fixed while the other was moved by a screw. It is beyond doubt that Huygens independently discovered that an object placed in the common focus of the two lenses of a Kepler telescope appears as distinct and well-defined as the

¹ Delambre, *Hist. ast. moderne*, ii. 590.

² *Mém. acad. des sciences* (1717), pp. 78 seq.

³ Grant, *History of Physical Astronomy*, p. 449.

⁴ This is an astonishing accuracy when the difficulty of the objects is considered. Few persons can see with the naked eye—much less measure—more than six stars of the Pleiades, although all the stars measured by Maestlin have been seen with the naked eye by a few individuals of exceptional powers of eyesight.

image of a distant body; and the micrometers of Malvasia, Auzout and Picard are the natural developments of this discovery. Gascoigne was killed at the battle of Marston Moor on the 2nd of July 1644, in the twenty-fourth year of his age, and his untimely death was doubtless the cause that delayed the publication of a discovery which anticipated, by twenty years, the combined work of Huygens, Malvasion, Auzout and Picard in the same direction.

As the powers of the telescope were gradually developed, it was found that the finest hairs or filaments of silk, or the thinnest silver wires that could be drawn, were much too thick for the refined purposes of the astronomer, as they entirely obliterated the image of a star in the more powerful telescopes. To obviate this difficulty Felice Fontana of Florence (*Saggio del real gabinetto di fisica e di storia naturale*, 1755) first proposed the use of spider webs in micrometers,¹ but it was not till the attention of Troughton had been directed to the subject by Rittenhouse that the idea was carried into practice.² In 1813 Wollaston proposed fine platinum wires, prepared by surrounding a platinum wire with a cylinder of silver, and drawing out the cylinder with its platinum axis into a fine wire.³ The surrounding silver was then dissolved by nitric acid, and a platinum wire of extreme fineness remained. But experience soon proved the superiority of the spider web; its perfection of shape, its lightness and elasticity, have led to its universal adoption.

Beyond the introduction of the spider line it is unnecessary to mention the various steps by which the Gascoigne micrometer assumed the modern forms now in use, or to describe in detail the suggestions of Hooke,⁴ Wren, Smeaton, Cassini, Bradley, Maskelyne, Herschel, Arago, Pearson, Bessel, Struve, Dawes, &c., or the successive productions of the great artists Ramsden, Troughton, Fraunhofer, Ertel, Simms, Cooke, Grubb, Clarke and Repsold. It will be sufficient to describe those forms with which the most important work has been done, or which have survived the tests of time and experience.

Before astronomical telescopes were mounted parallaxically, the measurement of position angles was seldom attempted. Indeed, in those days, the difficulties attached to such measures, and to the measurements of distances with the filar micrometer, were exceedingly great, and must have taxed to the utmost the skill and patience of the observer. For, on account of the diurnal motion, the direction of the axis of the telescope when pointed to a star is always changing, so that, to follow a star with an altazimuth mounting, the observer requires to move continuously the two handles which give slow motion in altitude and azimuth.

Sir William Herschel was the first astronomer who measured position angles; the instrument he employed is described in *Phil. Trans.* (1781), lxxi, 500. It was used by him in his earliest observations of double stars (1779-1783); but, even in his hands, the measurements were comparatively crude, because of the difficulties he had to encounter from the want of a parallactic mounting. In the case of close double stars he estimated the distance in terms of the disk of the components. For the measurement of wider stars he invented his lamp-micrometer, in which the components of a double star observed with the right eye were made to coincide with two lucid points placed to it from the left eye. The distance of the lucid points was the tangent of the magnified angles subtended by the stars to a radius of 10 ft. This angle, therefore, divided by the magnifying power of the telescope gives the real angular distance of the centres of a double star. With a power of 460 the scale was a quarter of an inch for every second.

The Modern Filar Micrometer.

When equatorial mountings for telescopes became more general, no filar micrometer was considered complete which was not fitted with a position circle.⁵ The use of the spider line or filar micrometer

¹ In 1782 (*Phil. Trans.* lxxi, 163) Sir W. Herschel writes:—"I have in vain attempted to find lines sufficiently thin to extend them across the centres of the stars, so that their thickness might be neglected." It is a matter of regret that Fontana's suggestion was unacknowledged to him.

² J. T. Quekett in his *Treatise on the Microscope* ascribes to Ramsden the practical introduction of the spider web in micrometers. The evidence appears to be in favour of Troughton.

³ *Phil. Trans.* 1813, pp. 107, 108.

⁴ Dr Hooke made the important improvement on Gascoigne's micrometer of substituting parallel hairs for the parallel edges of its original construction (Hooke's *Posthumous Works*, p. 497).

⁵ Herschel and South (*Phil. Trans.*, 1824, part iii, p. 10) claim that

became universal; the methods of illumination were improved; and micrometers with screws of previously unheard of fineness and accuracy were produced. These facilities, coupled with the wide and fascinating field of research opened up by Sir William Herschel's discovery of the binary character of double stars, gave an impulse to microscopic research which has continued unabated to the present time. A still further facility was given to the use of the filar micrometer by the introduction of clockwork, which caused the telescope automatically to follow the diurnal motion of a star, and left the observer's hands entirely at liberty.⁶

The micrometer represented in figs. 1, 2, 3 is due to Troughton. Fig. 1 is a horizontal section in the direction of the axis of the tele-

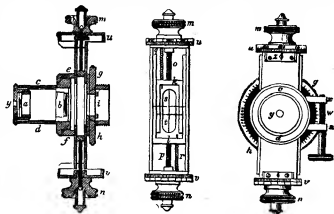

FIG. 1.

FIG. 2.

FIG. 3.

scope. The eyepiece *ab* consists of two plano-convex lenses *a*, *b*, of nearly the same focal length, and with the two convex sides facing each other. They are placed at a distance apart less than the focal length of *a*, so that the wires of the micrometer, which must be distinctly seen, are beyond *b*. This is known as Ramsden's eyepiece, having been made originally by him. The eyepiece slides into the tube *cd*, which screws into the brass ring *ef*, through two openings in which the oblong frame, containing the micrometer slides, passes. These slides are shown in fig. 2, and consist of brass forks *k* and *l*, into which the ends of the screws *o* and *p* are rigidly fitted. The slides are accurately fitted so as to have no sensible lateral shake, but yet so as to move easily in the direction of the greatest length of the micrometer box. Motion is communicated to the forks by female screws tapped in the heads *m* and *n* acting on the screws *o* and *p* respectively. Two pins *g*, *r*, with spiral springs coiled round them, pass loosely through holes in the forks *k*, *l*, and keep the bearings of the heads *m* and *n* firmly pressed against the ends of the micrometer box. Thus the smallest rotation of either head communicates to the corresponding slide motion, which, if the screws are accurate, is proportional to the amount through which the head is turned. Each head is graduated into too equal parts on the drums *u* and *v*, so that, by estimation, the reading can easily be carried to $\frac{1}{1000}$ th of a revolution. The total number of revolutions is read off by a scale attached to the side of the box, but not seen in the figure.

Two spider webs are stretched across the forks, one (*l*) being cemented in a fine groove cut in the inner fork *k*, the other (*s*) in a similar groove cut in the outer fork *l*. These grooves are simultaneously cut *in situ* by the maker, with the aid of an engine capable of ruling fine straight lines, so that the webs which are accurately laid in the grooves are perfectly parallel. A wire *t* is stretched across the centre of the field, perpendicular to the parallel wires. Each movable web must pass the other without coming in contact with it or the fixed wire, and without rubbing on any part of the brass-work. Should either fault occur (technically called "fiddling") it is fatal to accurate measurement. One of the most essential points in a good micrometer is that all the webs shall be so nearly in the same plane as to be well in focus together under the highest powers used, and at the same time absolutely free from "fiddling." For measuring position angles a brass circle *gh* (fig. 3), fixed to the telescope by the screw *i*, has rack teeth on its circumference that receive the teeth of an endless screw *w*, which, being fixed by the arms *xx* to the oblong box *mn*, gives the latter a motion of rotation round the axis of the telescope; an index upon this box points out on the graduated circle *gh* the angular rotation of the instrument.

the micrometer by Troughton, fitted to their 5 ft. equatorial telescope, is the first position micrometer constructed capable of measuring position angles to $\frac{1}{10}$ of arc.

So far as we can ascertain, the first telescope of large size driven by clockwork was the 9-in. equatorial made for Struve at Dorpat by Fraunhofer; it was completed in 1826. The original idea appears to be due to Claude Simeon Passeman (*Mem. Acad.*, Paris, 1746). In 1757 he presented a telescope to the king, so accurately driven by clockwork that it would follow a star all night long.

The English micrometer still retains the essential features of Troughton's original construction above described. The later

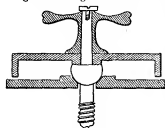

FIG. 4.

Fraunhofer's Pilar Micrometer.—The micrometer represented in fig. 5¹ is the original Metz micrometer of the Cape Observatory, made

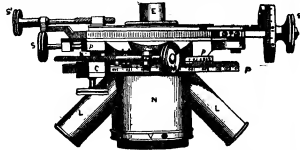

FIG. 5.

on Fraunhofer's model. S is the head of the micrometer screw proper, s that of the screw moving the slide to which the so-called "fixed web" is attached, s' that of a screw which moves the eyepiece E. C is the clamp and M the slow motion in position angle. L, L are tubes attached to a larger tube N; the latter fits loosely on this screw the whole apparatus is attached to the telescope. The nozzles of small lamps are inserted in the tubes L, L, for illuminating the webs in a dark field; the light from these lamps is admitted through apertures in the strong hollow cylinder above mentioned (for illumination, see p. 385). In this micrometer the three slides moved by S, s, and s' are simple dovetails. The lowest of these slides reposes upon a foundation-plate pp, into one end of which the screw s is tapped. In the middle of this slide a stiffly fitting brass disk is inserted, to which a small turn-table motion may be communicated by an attached arm, acted on by two fine opposing screws accessible to the astronomer; and by their means the "fixed web" may be rendered strictly parallel with the movable one. Another way is fixed parallel to the axis of the screw, as nearly as possible in the same plane with it and passing through the axis of rotation of the micrometer. For the internal structural details of the micrometer the reader is referred to the article "Micrometer" in the 9th edition of the *Encyclopædia Britannica*.

To use the instrument, it is well first to adjust the web moved by the screw S, so that its point of intersection with the web (commonly called the "position-web"), which is parallel to the axis of the screw, shall be nearly coincident with the axis of rotation of the micrometer box. For this purpose it is only necessary to direct the telescope to some distant object, bisect that object with the movable wire, and read the number of revolutions and parts of a revolution of the screw; now reverse the micrometer box 180° and repeat the observations; the mean of the two readings will be the point required. Now direct the telescope to a star near the equator and so that the star's image in its diurnal motion shall pass across the intersection of the two webs which mark the axis of rotation of the micrometer box. Then, as the diurnal motion causes the star-image to travel away from the axis of rotation, the micrometer box is rotated till the image of the star when at a considerable distance from the axis is bisected by the position-web. The micrometer is now clamped in position-angle by the clamp C, the star again brought back to the axis, and delicate adjustment given in position-angle by the slow-motion screw M, till the star-image remains bisected whilst it traverses the whole length of the position-web by the diurnal motion only. This determines the reading of the position-circle corresponding to position-angle 90° or 270°.²

¹ When it is remembered that the measurements of the Struves, Dembowski, Secchi, the Bonds, Maclear and of most modern European astronomers have been made with Fraunhofer or Metz micrometers it is not too much to say that fig. 5 represents the instrument with which a half of the astronomical measurements of the 19th century were made.

² For the corrections applicable to measures of position-angle in different hour angles, on account of errors of the equatorial instrument and of refraction, see Chauvenet's *Practical and Spherical Astronomy*, ii. 392 and 450.

The position-angles of double stars are reckoned from north through east, the brighter star being taken as origin. To observe the position-angle of a double star it is only necessary to turn the position-web so that it shall be parallel to the line joining the centres of the components of the double star. To test this parallelism the single web must be made to bisect the images of both components simultaneously, as in fig. 6, because it is evident that if the two components of the double star are not exactly equal in magnitude, there will be great tendency to systematic error if the web is placed on one side or other of the stars.

To avoid such error Dawes used double wires, not spider webs, placing the image of the star symmetrically between these wires, as in fig. 7, and believed that by the use of wires, much thicker than spider webs, the eye could estimate more accurately the symmetry of the star-images with respect to the wires. Other astronomers use the two distance-measuring webs, placed at a convenient distance apart, for position wires. This plan has the advantage of permitting easy adjustment of the webs to such a distance apart as may be found most suitable for the particular observation, but has the disadvantage that it does not permit the zero of the position-circle to be determined with the same accuracy; because, whilst by means of the screw s' (fig. 5) the eyepiece can be made to follow the star for a considerable distance along a position-web parallel to the screw, the bisection of the web by a star moving by the diurnal motion at right angles to the micrometer screw can only be followed for a limited distance, viz. the field of the eyepiece. But, as the angle between the position-web and the distance-webs is a constant, the remedy is to determine that angle (always very nearly a right angle) by any independent method and employ the distance-webs as position-webs in the way described, using the position-web only to determine the instantaneous index error of the position-circle.

To measure distances with the Fraunhofer micrometer, the position-circle is clamped as the true position-angle of the star, and the telescope is moved by its slow motions so that the component A of the star is bisected by the fixed wire; the other component B is then bisected by the web, which is moved by the graduated head S. Next the star B is bisected by the fixed web and A by the movable one. The difference between the two readings of S is then twice the distance between A and B.

The great improvement now introduced into all the best micrometers is to provide a screw s, which, not as in the Fraunhofer micrometer, moves only one of the wires, but which moves the whole micrometer box, i.e. moves both webs together with respect to the star's image in the direction of the axis of the screw. Thus the fixed wire can be set exactly on star A by the screw s, while star B is simultaneously bisected by the movable wire, or vice versa, without disturbing the reading for coincidence of the wires. No one, unless he has previously worked without such an arrangement, can fully appreciate the advantage of bringing up a star to bisection by moving a micrometer with a delicate screw-motion, instead of having to change the direction of the axis of a huge telescope for the same purpose. When it is further remembered that the earlier telescopes were not provided with the modern slow motions in right ascension and that the Struves, in their extensive labours among the double

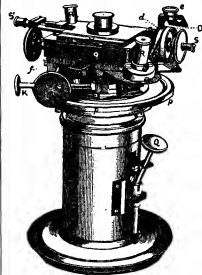

FIG. 8.

stars, used to complete their bisections of the fixed wire by a pressure of the finger on the side of the tube, one is puzzled whether more to wonder at such poor adaptation of means to ends or the patience and skill which, with such means, led to such results.³ Dawes, who employed a micrometer of the English type (figs. 1, 2 and 3), used to bolt the head of one of the screws, and the instrument was provided with a slipping piece, giving motion to the micrometer by screws acting on two slides, one in right ascension, the other in declination, so that "either of the webs can be placed upon either component of a double star with ease and certainty" (*Mem. R.A.S.* xxxv. 19).

The micrometer shown in fig. 8 was made by Repsold for the Cape Observatory. Fig. 9 represents the same

³ Professor Watson used to say, "After all the most important part of a telescope is the man at the small end."

micrometer with the upper side of the box removed. The letters in the description refer to both figures.

S is the head of the micrometer screw, *s* that of the screw by which the micrometer box is moved relative to the plate *f* (fig. 8), *s'* that of the screw which moves the eyepiece slide. *K* is the clamp in position angle, *P* the slow motion screw in position-angle; *pp* is the position circle, *R*, *R* its two readers. The latter are in fact little microscopes carrying a vernier etched on glass, in lieu of a filar micrometer. These verniers can be read to $1'$, and estimated to $0'.2$. *D* is the drum-head which gives the fraction of a revolution, *d* that which gives the whole number of revolutions. *I* is the index or pointer at which both drums are read. This index is shown in fig. 9, but only its mode of attachment (*X*, fig. 9) in fig. 8. The teeth of the pinion *z*, fig. 9, are cut on the axis of the micrometer screw. The drum *d* and

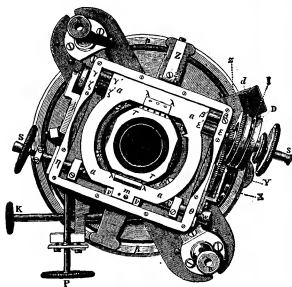

FIG. 9.

is attached tooth wheel are ground to turn smoothly on the axis of the screw. The pinion *z* and the toothed wheel *d* are connected by an intermediate wheel and pinion *Y*; the numbers of teeth in the wheels and pinions are so proportioned that twenty-four revolutions of the micrometer screw produce one revolution of the drum and wheel *d*. The divisions of both drums are conveniently read, simultaneously, by the lens *e*; at night the lamp which illuminates the webs and the position-circle also illuminates the drum-heads (see on illumination p. 385). *aaaa* is the web-frame (fig. 9), *βγ* is a single rod consisting of two cylinders accurately fitting in the ends of the micrometer box, the larger cylinder being at *β*. There is a hole in the web-frame which smoothly fits the larger cylinder at *β'*, and another which similarly fits the smaller cylinder at *γ'*. A spiral spring, coiled round the cylinder *γ*, resting one end on the shoulder formed by the difference of the diameters of the cylinders *β* and *γ* and the other on the inside of the web-frame, presses the latter continuously towards *γ*. Contact of the web-frame of the micrometer with the side of the box at *γ* would therefore take place, were it not for the micrometer screw. This screw fits neatly in the end of the box at *e*, passes loosely through the web-frame at *e'*, is tapped into the frame at *f'*, and its end rests on a flat hardened surface at *f*. Rotation of the web-frame about *βγ* is prevented by the heads of the screws at *m*; the head of the screw on the lower side of the frame reposes on the plane *ω*, that on the upper side (fig. 9) touches lightly on the inner surface of the lid of the box. Such rotation can obviously be controlled within limits that need not be further considered. But freedom of rotation in the plane of the paper (fig. 9) is only prevented by good fitting of the holes *β' γ'*; and, since the weight of the slide is on one side of the screw, misfit here will have the effect of changing the reading for coincidence of the movable with the fixed web in reverse positions of the micrometer. With the Cape micrometer a systematic difference has been found in the coincidence point for head above and head below amounting to $0''.14$. This corresponds, in the Cape instrument, with an excess of the diameters of the holes over those of the cylinders of about $\frac{1}{125}$ of an inch—a quantity so small as to imply good workmanship, though it involves a systematic error which is very much larger than the probable error of a single determination of the coincidence point. The obvious remedy is to make all measures on opposite sides of the fixed web before reversing in position-angle—a precaution, however, which no careful observer would neglect. In measuring differences of declination, where the stars are brought up by the diurnal motion, this precaution cannot be adopted, because it is

necessary always to bisect the preceding star with the fixed web. But in $\Delta\delta$ measures index error can be eliminated by bisecting both stars with the same web (or different webs of known interval fixed on the same frame), and not employing the fixed web at all. The discordance in zero, when known to exist, is really of no consequence, because the observations can be so arranged as to eliminate it.

The box is mounted on a strong hollow steel cylinder *CC* (fig. 9) by holes *η*, *θ* in the ends of the box, which fit the cylinder closely and smoothly. The cylinder is rigidly fixed in the studs *C*, *C*, and these are attached to the foundation plate *f*. The cylinder contains towards *η* a sliding rod, and towards *θ* a compressed spiral spring. There is thus a thrust outwards of the spring upon the hollow cap *W* (attached outside the box), and a thrust of the rod upon the end of the screw *s*. The position of the *Lox* relative to the plate *f*, in the direction of measurement, depends therefore on the distance between the end of the screw *s* and the fixed stud *C*. A screwing in of *s* thus causes the box to move to the left, and vice versa. Rotation of the box round *C* is prevented by downward pressure of the spring *Z* on a projection attached to the side of the box. The amount of this pressure is regulated by the screw *z'*.

The short screw whose divided milled head is *s* shifts the zero of the micrometer by pushing, without turning, the short sliding rod whose flat end forms the *point d'appui* of the micrometer screw at *f*. The pitch of the screw *s* is the same as that of the measuring screw (50 threads to the inch), and its motion can be limited by a stop to half a revolution.

The five fixed webs are attached to the table *ττ*, which is secured to the bottom of the box by the screws *ρ*. The three movable webs are attached to the projections *λλ* on the frame *aa*. The plane surfaces *ππ* and *λλ* are composed of a bronze of very close texture, which appears capable of receiving a finish having almost the truth and polish of an optical surface. It seems also to take a very clean *V* cut, as the webs can be laid in their furrows with an astonishing ease and precision. These furrows have apparently been cut *in situ* with a very accurate engine; for not the slightest departure from parallelism can be detected in any of the movable webs relative to the fixed webs. Extraordinary care has evidently been bestowed in adjusting the parallelism and distance of the planes *τ* and *λ*, so that the movable wires shall almost, but not quite, touch the surface *τ*. The varnish to fix the webs is applied, not on the surface *π* as is usual, but on a bevel for the purpose,¹ the position of the webs depending on their tension to keep them in their furrows. The result is that no trace of "fiddling" exists, and the movable and fixed webs come sharply together in focus with the highest powers. Under such powers the webs can be brought into apparent contact with such precision and delicacy that the uncertainty of measurement seems to lie as much in the estimation of the fraction of the division of the head as in the accuracy of the contact. It is

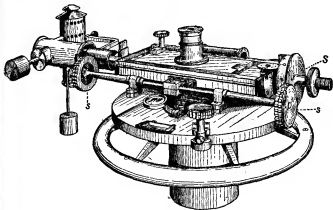

FIG. 10.

a convenient feature in Repsold's micrometer that the webs are very near the inner surface of the top of the box, so that the eye is not brought inconveniently close to the plate when high powers are used.

Another excellent micrometer, originally based on a model by Clark of Cambridge, Massachusetts, has been largely used by Burnham and others in America. The form, as constructed by Warner and Swasey for the 40-in. Yerkes telescope, is shown in figs. 10 and 11. The micrometer box, and of course with it the whole system of spider webs, is moved by the screw *s*, while the measuring web is independently moved by the screw *s'*. The other parts of the instrument will be readily understood from the figure without further explanation. The method of counting the total number of revolutions gives more friction and is less convenient than Repsold's, and no provision seems to be made for illuminating the micrometer head in the practical and convenient plan adopted by Repsold.

Repsold's more recent form of the spider-line micrometer (since

¹ The marks of varnish so applied will be seen in fig. 9.

It is generally possible so to arrange the method of observation as to eliminate the effect of an error in "the reading for coincidence of the webs" from the results. This excellent time-saving contrivance has also been used in Gill's apparatus for measuring astrophotographic plates (see below).

Ghost Micrometer.—C. E. Burton and Sir Howard Grubb (*Monthly Notices*, xli, 59), after calling attention to J. von Lamont's paper (*Jahrbuch der K. S. b. Mühen*, p. 187) and K. L. von Littrow's paper (*Proc. of Vienna Acad. of Sciences*, xx, 253) on a like subject, proceed to describe a most ingenious form of "Ghost Micrometer," in which the image of a fine line or lines ruled in (or rather cut through) a silver film deposited on glass is formed at the common focus of an object-glass and eyepiece of a telescope. A faint light being thrown on the outside of the silvered plate, there appear bright lines in the field of view. We have not had an opportunity of testing this, nor Grubb's more recent models; but, should it be found possible to produce such images satisfactorily, without distortion and with an apparatus convenient and rigid in form, such micrometers may possibly supersede the filar micrometer. Their absolute freedom from diffraction, the perfect control of the illumination and thickness of the lines, and the accuracy with which it will be possible to construct scales for zone observations will be important features of the new method.

The Astrophotographic Micrometer or Measuring Machine.—The application of photography to exact astronomy has created the necessity for new forms of apparatus to measure the relative positions of stellar and planetary images on photographic plates, and the relative positions of lines in photographic spectra.

Especially important has been the problem of measuring the catalogue plates of the international *Carte du ciel*—a work that implies the determination of the positions of some millions of stars—that is to say, of all stars to the 11th or 12th magnitude. The problem has been how to accomplish this work with the minimum of labour consistent with the desired accuracy. The adoption of a réseau photographed upon the plate has greatly facilitated the procedure. A plate of parallel-surfaced glass has a film of silver deposited upon it. On this film is ruled a system of lines 5 mm. apart, and another similar system of lines at right angles to the first, thus dividing the silvered surface of the plate into squares 5 mm. on the side. The cutter employed to rule these lines removes the silver in fine lines from the surface of the glass. Thus, if a photographic plate, before it is exposed in the telescope, is placed with its sensitive surface nearly in contact with the silvered surface of this réseau, and if parallel light, normal to the surface of the plate, is allowed to fall on the silvered film through the glass on which the film has been deposited, that light will pass through the fine lines in the silver film where the silver has been removed by the cutter, but will otherwise be intercepted by the silver film. Thus a latent image of the "réseau-lines" will be formed on the sensitive plate, and, when the latter has been exposed to the sky in the telescope, on development, a negative of the images both of the stars and of the réseau-lines. If the errors of the rectangular co-ordinates of these lines are known, the problem of determining the co-ordinates of any star-image on the plate becomes reduced to the comparatively simple one of interpolating the co-ordinates of the star relative to the 5 mm. square within which that image is included. This interpolation can, of course, be accomplished with the aid of a micrometer-microscope whose optical axis is normal to the plate, provided that the plate is mounted on slides which enable the observer to bring the réseau-squares successively, under the microscope.

This system has an additional advantage beyond its convenience, viz. that if any distortion of the film takes place during development the same distortion will be communicated both to the star-images and to the réseau-lines, and consequently its effect will be eliminated from the resulting co-ordinates, except in so far as the distortion within the 5 mm. square is of an irregular character; this exception is hardly worth consideration. An originally unanticipated difficulty has arisen from the fact that the réseau-lines have not been ruled on plates of optical glass with optical surfaces, and that, in consequence of irregular refraction in the glass plate, the rays do not always pass through the silver film-lines in a direction strictly normal to the silvered surface; therefore, if the sensitive surface of the photographic plate is not in contact with the silver film of the réseau, the undeveloped photographic copy of the réseau may in such a case not be an exact reproduction of the silvered réseau. It is practically impossible to work with the sensitive film in contact

with the réseau-film, not only because dust particles and contact would injure the silver film, but also because the plate-glass used for the photographic plates is seldom a perfect plane. The discrepancies produced in this way are, however, very small, if care is taken to minimize the distance between the silver film and the photographic plate and to select a reasonably good piece of glass for the réseau. For very refined work, however, the irregularities in the reproduction of the réseau may be studied by comparing the measures of the original réseau with the mean of corresponding measures of a number of photographed copies of it.

At Greenwich, Oxford and several other observatories, instead of measuring the distances of the star's image from the opposite sides of the 5 mm. réseau-square by means of a spider-line micrometer, a glass scale, on the plan shown in fig. 16, is employed in the common focus of the objective and the eyepiece. The image of the star is set upon the intersections of the lines of the central cross, and the positions of the réseau-lines are read off by estimation to $\frac{1}{10}$ of a division on the glass scale. As each division corresponds to 3 sec.

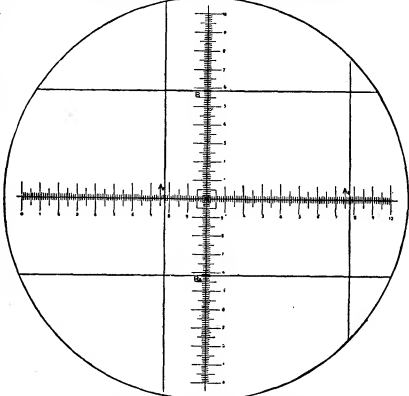

Greenwich Astrophotographic Catalogue, vol. 1, by permission of the Controller of H.M. Stationery Office.
FIG. 16.—Diagram of the diaphragm in eyepieces of the micrometer used for measuring the plates of the Astrophotographic Catalogue.

of arc, the nearest estimate corresponds with a nominal accuracy of $\approx 0.3''$. This involves a loss of accuracy because, with a spider-line micrometer, the accidental error of pointing is of the order of $\approx 0.1''$ of arc.

In the measuring machines in general use the field of view, as in the case of the glass-scale micrometer, is sufficiently large to include the image of the 5 mm. square. The microscope or viewing telescope is fitted with a spider-line micrometer having two screws at right angles to each other, by means of which readings can be made first on one réseau-line, then on the star, and finally on the opposite réseau-line in both co-ordinates. This form of micrometer is of course capable of giving results of high precision, but the drawback is that the process involves a minimum of six pointings and the entering of six screw-head readings in order to measure the two co-ordinates of the star.

Gill's Measuring Machine.—Sir David Gill (*Monthly Notices*, R.A.S. lix, 61) devised measuring machine which combines the rapidity of the glass-scale micrometer with the accuracy of the spider-line micrometer and simplifies the reductions of the observations at the same time. The essential conditions of the instrument are:—

1. The object glass of the micrometer-microscope is placed midway between the plane of the photographic plate and the plane of the micrometer webs.
2. The micrometer is provided with a "fixed square" 5 mm. X 5 mm., the sides of this square being parallel spider webs $4''$ of arc apart; the size of the square is reckoned from centre to centre of these double webs.

3. The two micrometer screws (X and Y, fig. 17), which actuate the movable slides, have been divided into 100 parts, one revolution = 0.5 mm.; so that ten revolutions are = 5 mm., or = the interval between two adjacent réseau-lines, or = the interval between the sides of the "fixed square."

4. Two other screws, α , β , the heads of which are not graduated, give motions to the whole micrometer box through ≈ 1 mm. in directions parallel to the axes of the two micrometer screws.

5. Each of the two micrometer screws X and Y moves a system of six parallel webs, placed 4° of arc apart from each other. These

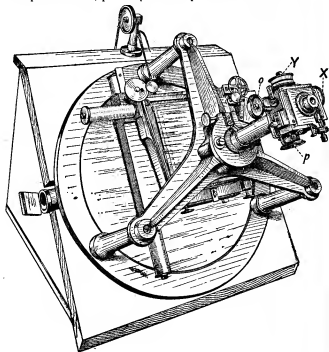

FIG. 17.

webs serve not only for pointing on stars to determine their co-ordinates (in manner afterwards described), but also for estimating the diameters of the star-images in terms of these 4° intervals.

6. All the essential parts of the micrometer, including the slides, micrometer box, tube, &c., are of steel or cast-iron, so that changes of temperature do not affect the adjustments.

The necessary adjustments are the following—

1. The webs of each set of movable webs shall, *inter se*, be strictly parallel, and the two sets shall be strictly at right angles to each other.

2. The double webs composing the sides of the fixed square shall be strictly parallel, and shall form a true square of exactly ten revolutions of the screw on the side.

3. The two micrometer screws shall be without sensible periodic or other error, and exactly alike in pitch.

4. The micrometer readings for coincidence of the movable webs with the webs of the fixed square shall be exactly 0.000R and 10.000R.

5. The image of a normal réseau-square, as viewed in the microscope, shall exactly coincide with the square formed by the fixed webs—that is to say, the image of the sides of a normal réseau-square shall measure exactly 10 screw-revolutions.

Assuming that these conditions can be rigidly realized, we have the following very simple *modus operandi*:—

1. By means of the quick rack motions A and B move the plate so as to bring the réseau-square into the centre of the field of the micrometer; then, by means of the screw heads α , β , perfect the coincidence of the "fixed square" of webs, with the image of the réseau-square.

2. By means of one of the micrometer screws X place the star's image in the middle of the six parallel webs which are moved by X.

3. Similarly, place the star's image in the middle of the webs moved by Y.

4. Estimate the diameter of the star's image in terms of the 4° intervals of the movable webs.

By employing both hands, operation (1) can be made as quickly as a single pointing with the ordinary spider-line micrometer, and operations (2) and (3) can be similarly performed in the time required for a single pointing. The reading (2) is then the required co-ordinate in x and that of (3) is the required co-ordinate in y; or, if the plate is reversed, 180° , these readings have to be subtracted from 10.000R.

A general idea of the construction of the machine can be gathered from fig. 17 above, but the reader will find a detailed account of it, and of the manner in which the requisite adjustments are made, in the paper already quoted.

The apparatus has been used with complete success at the Royal Observatory, Cape of Good Hope, and at Melbourne, Sydney and Córdoba.

Effects of Wear on the Micrometer Screws.—The accuracy of this apparatus has been frequently criticized on the ground that errors are produced in the screws by the effect of wear. One reply to this is that it is not difficult to determine from time to time the errors of the screws and to apply the necessary corrections to the observations. But a little consideration will show that when the plate is reversed 180° the effects of errors of the screws produced by wear are practically eliminated.

In discussing the effect of wear upon a screw, it will be convenient to imagine the thread unrolled and forming a wedge, of which we can represent the unworn bearing-side by a straight line AB (fig. 18),

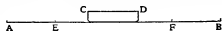

FIG. 18.

on which rubs the block CD, which represents the female screw or bush, and moves between the points E and F, sometimes towards E, sometimes towards F, but having as often to measure short distances as long distances from the middle point of this range, and these as often towards E as towards F. Now, if CD is pressed by its weight or by a spring on the surface AB, the effect of wear will be to produce a symmetrical grinding away of both surfaces, which may be represented thus, fig. 19. That is to say, the screw-errors will be

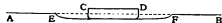

FIG. 19.

identical for revolution n and for $10-n$, and thus will disappear in their effect in the mean of observations made in reversed positions of the plate. At the Cape of Good Hope, after more than 200,000 pointings had been made, the screw-errors were redetermined; the results proved the truth of the above conclusions, viz. the absolute freedom of the derived co-ordinates from the effects of wear of the plates in the mean of measures made in reversed positions of the plate.

Hinks's Measuring Machine.—A very refined modification of the Cape machine is described by A. Hinks (*Monthly Notices, R.A.S.*, vol. 61, p. 444), and the instrument contains many elegant mechanical and optical details due to Horace Darwin and Messrs Zeiss respectively.

Its fundamental principle is that, by a combination of glass scales with a micrometer screw, "the chief part of the distance to be measured is read off on the scale; the fractional part of the scale-space is not estimated but measured by the screw." Hinks claims that this never more than one- or two-tenths of a revolution of the screw need be used in making the measure, and little time is lost in running the screw backwards and forwards. All this is true, but three readings instead of one for each pointing, much more figure-work in computation (especially if corrections have to be applied to the scale readings to reduce them to exact normal screw readings), are factors which involve a far greater expenditure of time than making a few additional turns of a screw in the process of measurement. Hinks's further claim that, in consequence of the small motion of the screw, less error is produced in the screw by wear is not true; for, although large movements of the screw produce a large amount of wear, that wear is spread over longer parts of the screw but remains the same for any particular part of the screw; the resulting errors are exaggerated towards the extremity of the range of screw employed (see *Monthly Notices, R.A.S.*, vol. 45, p. 83), and are therefore more likely to produce errors which are not eliminated on reversal of the plate in cases where the screw range is not strictly limited, and the wear therefore not strictly symmetrical.

The excellent manner in which the scales and micrometers are mounted, the employment of a compound microscope for viewing the scales, with its ingeniously arranged and admirably efficient reversing prism, and the perfection of its slow motions for focusing and reading, combine to render this a most accurate and convenient instrument for very refined measures, although too slow for work in which the measures must depend on single pointings in each of two reversed positions of the plate, and where speed of working is essential.

Apparatus for Measuring Star-Spectra, &c.—These machines may be divided into three classes, viz. A, in which the motion of the slide which carries the photographic plate is measured entirely by a screw; B, in which that motion is measured by combination of a scale and screw; and C, in which the

photographic plate is fixed and the measuring microscope is moved.

The chief drawback to type A is that the errors of the screw are liable to change by wear, otherwise the apparatus, as made and used at Potsdam, is on the whole, a convenient and accurate one. In determining the errors of the screw of the Potsdam form

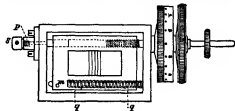

FIG. 20.

of machine it is necessary to have regard to the fact that the screw is placed at one side of the slide, as in fig. 20.

The result is that, if the screw is bent—if, for example, the end of the frame next the screw-head is raised and that next the end β is lowered in the diagram—a twist will be given to the web-frame, and the centre of the web will be moved nearer to the micrometer-drum than it should be, whilst the reverse effect will follow when the head has been turned 180° . This would, of course, create a periodic error, which would be determinable for the motion of any particular point (say the middle) of the web, but which would be smaller for a point near the axis of the screw and greater for a point farther from that axis. In the Potsdam form of this apparatus the micrometer is, for convenience, provided with a motion at right angles to the axis of the screw, and it has been found at the Cape Observatory that the periodic errors in this apparatus do vary very sensibly according as the microscope is directed to a point more or less distant from the measuring screw. Since the discovery of this fact all measurements have been made in that fixed position of the microscope with respect to the axis of the screw for which the errors of the screw have been determined.

In the apparatus of type B as made by Zeiss there are two microscopes attached to a base-plate, one of which views the spectrum-plate (or other object) to be measured, while the other views a scale that moves with the slide on which the spectrum-plate is fixed. In this way the scale can be viewed by a microscope of much higher magnifying power than can be employed for the photographed spectrum. Indeed, if the scale were subdivided to $\frac{1}{10}$ mm. the power employed might only be limited by the sharpness of the division-lines. But for refined work this would imply the investigation of too many divisions of the scale; it is therefore more usual to divide the scale into single millimetres or half-millimetres and to provide a micrometer which subdivides the millimetre into 1000 or, by estimation, into 10,000 parts. For very accurate work it is desirable that the base-plate, the slide and the scale should be of nickel steel, having the same thermal coefficient of expansion as glass.

The forms of measuring machines of type C, often seen in physical laboratories, should be at once rejected for refined measurements, because it is impossible to construct slides of such perfection that the axis of the microscope will remain absolutely normal to the surface of the plate (assumed to be a plane) throughout the range of measurement. Even if the slide itself is mechanically perfect, the irregularity in the thickness of the lubricating oil between the bearing surfaces of the slide is apt to produce a variable error.

Balkhuyzen (*Bulletin de Com. perm. congrès. astr.*, 1, 164) described a measuring-machine by Repsold's, in which the micrometer-microscope tilts in the bearings of the chariot on which it moves, so that it can view either a graduated scale or the photographic plate. We have, in fact, in this instrument a combination of types B and C. Even in this apparatus if the slide on which the chariot moves is not perfect (and no slide is perfect), the azimuth of the axis of the microscope is liable to change in the course of movement of the slide, and the equal spaces on the scale will not be represented by equal spaces on the plate under measurement. The remedy proposed by Repsold for this proved false is to cause the whole slide to tilt instead of the microscope only; this should prove a complete remedy.

The Travelling Wire Micrometer.—An important modern application of the micrometer, which is not dealt with in the article TRANSIT CIRCLE, is that which is now called "the travelling wire micrometer."

In the *Astronomische Nachrichten*, No. 2940, Dr Repsold proposed a method of meridian observing which consists in causing a web to follow the image of a star in transit by motions communicated by the observer's hands alone, whilst electrical contacts on the drum of the micrometer screw register on the chronograph the instants corresponding to known intervals from the line of collimation. The purpose of his paper was to show that if the axis, by which the

observer imparts motion to the slide on which the travelling web is mounted, is provided with two disks at its extremities, so that the observer can use the thumb and finger of both hands in rotating it, there is no difficulty, after a little practice, in keeping the web constantly bisecting the star in transit, and that with a little practice the mean of the absolute errors in following the star becomes less than a hair.

In the *Astron. Nach.*, No. 3377, Repsold gives a detailed description of two forms of eye-ends of transit circles, fitted with means of observing in this manner, to which he gives the name of "the impersonal micrometer." This method of observation was very successfully employed, under Seeliger at Munich, in an extensive series of meridian observations, and, under the auspices of the Geodetic Institute at Potsdam, in telegraphic longitude operations. Still more recently the method has been largely employed at the Cape of Good Hope and elsewhere.

Under the date March 1901 Dr H. Struve published an account of the application of clockwork as an aid in Repsold's method; and, later, Dr Cohn published a more elaborate paper on the same subject in the *Astron. Nach.*, 3767. The method consisted in having motion transmitted to the micrometer screw from an axis on which is mounted a disk that presses with friction-contact upon a cone that revolves uniformly by clockwork. The velocity of rotation of the micrometer-screw could therefore be varied for stars of different declination by varying the distance from the apex at which the driving disk presses upon the revolving cone. In the Königberg transit instrument used by Struve and Cohn, the clockwork was attached to the eye-end of the instrument—a condition which is obviously undesirable both from the necessarily unsymmetrical position of the clockwork with respect to the optical axis, and from the impossibility of securing the uniform going of the clock in different positions of the instrument. In more recent instruments at the observatories of the Cape of Good Hope and Paris the motion is transmitted from a separately mounted cone and clock by a light rod passing through a perforation in the pivot of the transit instrument and thence through bevel-wheels in the cube of the axis to a second rod leading to the eyepiece. This rod turns a worm-screw which acts on a worm-wheel fitted "spring tight" upon the axis of the micrometer-screw.

It should be mentioned that an essential feature of the travelling wire micrometer is that the eyepiece as well as the wire shall be moved by the micrometer-screw. Thus, if the star's image is kept in bisection by the wire, both star and wire will appear at rest in the field of view.

The difference between the old and new method of observation may thus, in one sense, be described as the difference between shooting at a moving object and in shooting at one at rest. In the case of the original Repsold plan without clockwork the description is not quite exact, because both the process of following the object and correcting the aim are simultaneously performed; whilst, if the clockwork runs uniformly and the friction-disk is set to the proper distance from the apex of the cone, the star will appear almost perfectly at rest, and the observer has only to apply delicate corrections by differential gear—a condition which is exactly analogous to that of training a modern gun-sight upon a fixed object. It is impossible in this article to give a detailed description of the apparatus, but the reader is referred to *Astron. Nach.*, 3377, for an illustrated account of the original Repsold's instrument and to the *History and Description of the Cape Observatory* for a complete description of the most modern form of its application to the Cape transit circle, with and without clockwork.

The Hartmann Spectrocomparator.—For accurate measurement of the displacements of lines of stellar spectra which are produced by the relative motion of star and observer in the line of sight, a very beautiful instrument has been devised by Dr J. Hartmann of Potsdam, and is described by him in the *Publication des astrophysikalischen Observatoriums zu Potsdam*, Bd. 18, Stück 53 (1906). An English translation of this paper is given in the *Astrophysical Journal*, xiv, 285-302. The method originally used by Huggins, who first conceived and proved the possibility of measuring stellar velocities in the line of sight, was to measure with a filar micrometer the displacement of some well-known line in a stellar spectrum relative to the corresponding line of a terrestrial spectrum. Vogel of Potsdam introduced the method of photographing stellar and terrestrial spectra on the same plate, and in this way obtained an immense advance in the ease and precision of observation. Vogel and his successors employed one or other form of measuring machine, provided with a microscope having single or close parallel webs which could be successively pointed on the photographed lines of the star spectrum and the lines of the terrestrial spectrum. To derive the stellar velocity in the line of sight relative to the observer it was then necessary to assume that the normal wave-lengths of the stellar and terrestrial spectra are accurately known. But in the

complex spectra of stars of the solar type this is by no means the case; for, as Dr Hartmann remarks, "in the first place the lines in these spectra are so numerous that their complete measurement and reduction would require many days, and in the second place a rigorous reduction of such material has hitherto not been at all possible because the wave-lengths of the lines are not known with sufficient accuracy. On this account, observers have until now limited themselves to a partial treatment of such spectra, measuring only a small number of lines, whereby the major part of the rich material present in the plate remains unutilized." But the spectroscopes that can be employed for stellar spectrographs are not sufficiently powerful to separate fully lines which are very closely adjacent, and therefore a line, assumed to be of a known wave-length, may be apparently displaced by the near neighbourhood of an unknown line. Hartmann overcame these and many other difficulties by directly superposing the image of the spectrogram of a star, having iron comparison lines, upon the image of a spectrogram of the sun taken also with iron comparison lines.

The apparatus for this purpose is shown in fig. 21, its principle of construction is shown in figs. 22 and 23. The solar spectrograph is attached by clamps to the plate A_1 , the stellar spectrograph to the plate A_2 . The plate A_1 is mounted on the dove-tailed slide B_1 , upon the metallic stage T , and can be moved to right or left relative to T by the micrometer-screw S ; whilst the plate A_2 is mounted on the dove-tailed slide B_2 and can

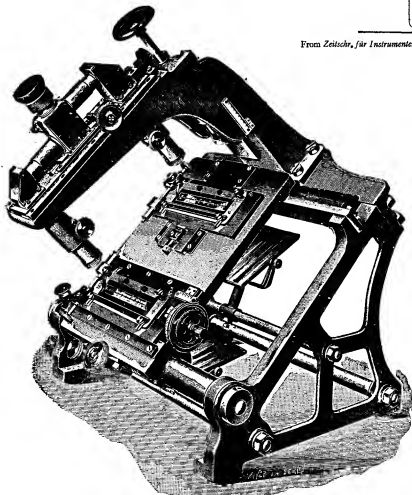

From *Zeitschr. für Instrumentenkunde*, by permission of Julius Springer, Berlin.
FIG. 21.

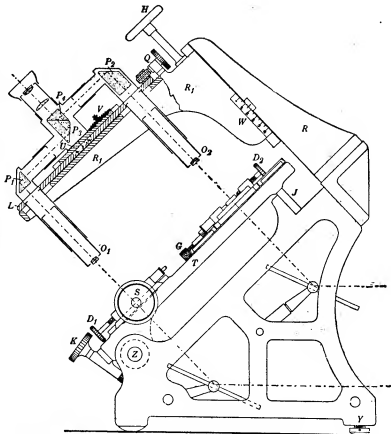

From *Zeitschr. für Instrumentenkunde*, by permission of Julius Springer, Berlin.

FIG. 22.

be moved at right angles to its greatest length by the screw G . The micrometer-screw S has a pitch of 0.5 mm., its head is divided into 100 parts. Two spiral springs underneath press the plate B_2 with its agate end-bearing against the rounded end of the screw S . The whole number of revolutions of the screw is read by the scale X (fig. 23). The whole stage T , carrying both spectrographs, can be moved from right to left on the steel cylinder Z , by turning the head K , on the axis of which is a pinion that gears into a toothed rack attached to the lower side of the cylinder Z . A scale N on the cylinder Z serves for setting the slide to any required position. The preliminary conditions of measurement are:—

1. The centre of both spectrographs shall be parallel to the axis of the cylinder Z .
2. The distance between the centres of the two spectrographs shall be equal to the distance between the optical axes of the two viewing microscopes.

The scales of the images formed in the focus of the eyepiece common to both microscopes shall be identical.

To fulfil condition (1) the plates A_1 and A_2 are mounted in circular slides, whose centres are E_1 and E_2 respectively, so that by means of the screws D_1 , D_2 , with their corresponding opposing springs F_1 and F_2 , the operation can be very easily accomplished. To fulfil condition (2) the two microscopes whose object glasses are O_1 and O_2 (fig. 22) are attached to the plate L , their optical axes being normal to the stage T . The screw G serves to adjust the axis of O_1 to coincidence with the centre of the lines of the solar spectrograph, and the screw G then serves to move the slide B_2 till the optical axis of O_2 is coincident with the centre of the lines of the stellar spectrograph. Suppose now the solar spectrogram to be viewed in the focus of O_1 , and the converging rays to be reflected by the prisms P_1 and P_2 , till an image is formed in the focus of the eyepiece at the point where the axis of the eyepiece intersects

the upper face of the prism P_2 . Then if the prism P_4 is cemented to P_2 , a sharp image of such lines of the solar spectrograph as are visible in the field of view will be seen in the eyepiece. If the stellar spectrograph is viewed in the focus of O_2 and the converging rays are reflected by the prism P_2 to P_4 , no image would be seen in the eyepiece, for the rays would pass out directly through the parallel glass plate which is formed by the cementing together of the prisms P_2 and P_4 . But if the cemented face of P_4 is silvered,

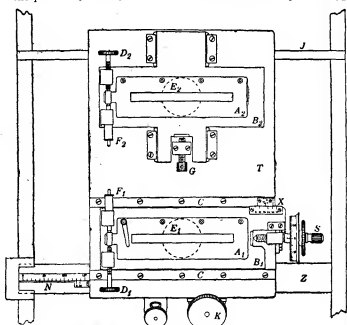

From *Zeitschr. für Instrumentenkunde* by permission of Julius Springer, Berlin.
FIG. 23.

then the lines of the stellar spectrograph would be seen in focus of the eyepiece and the image of the solar spectrograph would be obliterated. Therefore, if one-half of the cemented face of P_4 is silvered, it becomes possible to view, side by side, one-half of the image of the solar spectrograph formed by O_2 and one-half of the image of the stellar spectrograph formed by O_1 . A prism half silvered in this way is provided, which enables the observer to compare the equality of scale of both photographs. If, for example, it is found that the image of the solar spectrograph is the larger of the two it becomes necessary to adjust the object glass O_1 farther

from the stellar spectrograph. This has the effect of forming the image of the latter farther from the observer's eye, and so it becomes necessary to turn the handle of the rack-pinion V in such a way as to move the prisms P_3 and P_4 nearer to P_2 till the lines of the stellar spectrograph are again sharply in focus. The effect of turning the pinion V is, of course, to displace the focus both of the solar and stellar spectrographs in the field of the eyepiece, but this displacement is easily restored by the focussing screws O_1 and O_2 . By successive adjustments of this kind condition (3) can be accurately realized.

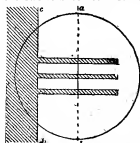

From *Zeitschr. für Instrumentenkunde*, by permission of Julius Springer, Berlin.
FIG. 24.

These three adjustments having been made, the prisms P_2 and P_4 are removed and replaced by another prism in which the silvering is arranged as in fig. 24, where the hatched lines denote the silvered surfaces. The narrow tongues of the silvered surface will now reflect corresponding parts of the star-spectrograph, and will obliterate corresponding parts of the solar spectrograph—as shown in figs. 25 and 26. Fig. 25 shows the stellar and solar lines of the two spectrographs in coincidence, whilst the metallic lines of comparison are non-coincident. Fig. 26 shows the metallic lines of comparison in coincidence whilst the solar and stellar lines are non-coincident. It is obvious that these two conditions can be produced at the will of the observer by simply turning the screw S, and that the difference of the readings of the screw-head, which are required to reproduce the two conditions in question, gives a measure of the displacement of the stellar lines relative to the solar lines. If then the screw-value in kilometres per second is known for the neighbourhood of each of the comparison lines employed, the radial velocity of the star can be independently derived directly from coincidences made in above manner in the

neighbourhood of each comparison line. For the special purpose of determining the solar parallax this instrument has been used in a most refined and perfect manner by Dr Halm at the Cape of Good Hope (*Annals of the Cape Observatory*, vol. x. part 3).

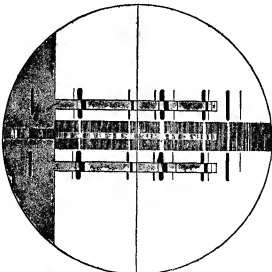

From *Zeitschr. für Instrumentenkunde*, by permission of Julius Springer, Berlin.

FIG. 25.

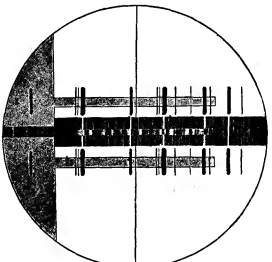

From *Zeitschr. für Instrumentenkunde*, by permission of Julius Springer, Berlin.

FIG. 26.

Double Image Micrometers are described in the article HELIOMETER (q.v.). (D. GL.)

MICRONESIA (from Gr. $\mu\kappa\rho\sigma\varsigma$, small, and $\nu\eta\sigma\sigma\varsigma$, island), one of the three great divisions of the oceanic islands in the central and western Pacific. Lying to the north of Melanesia, it embraces the following groups: Mariana, Pelew, Caroline, Marshall and Gilbert. See articles under these headings, and PACIFIC OCEAN (section on Islands).

The Micronesian islands form in the main a branch of the Polynesian race, but distinguished from it by well-marked differences in appearance, language and institutions. Many of the islanders, however, show signs of hybridism. The proximity of Japan and the Philippines¹ on the west, and of the Papuan

¹ There are authenticated instances of Japanese junks, with living people in them, having been found in various parts of the North Pacific. In 1814 the British brig "Forester" met with one off the coast of California (about 30° N. lat.), with three living men and fourteen dead bodies on board. In December 1832 a Japanese junk arrived at the Hawaiian Islands with four of the crew living. If these junks could cross the Pacific in the south of Hawaii it is not at all unlikely that others running in a little easterly direction would reach some of the many atolls which stretch over about 35° of longitude, forming the Caroline and Marshall archipelagoes.

The traditions of the Gilbert Islanders tell us that their islands

and South Polynesian islands on the south and south-east, suggests, what in fact is found, a combination of races. In some places the oblique Mongolian eye is noticed, and (together with certain Indo-Chinese customs) there is often a scantiness of beard and general "Malay" look, which increases westwards, and seems to imply relations with the archipelago subsequent to the departure thence of the pure Polynesians. In the Gilberts the traces of Polynesian (Samoan) influences are evident, and are confirmed by tradition. Among the Carolines and the Marshalls darker and more savage communities are found, suggesting a Melanesian element, which is further traceable in the Ebon (Marshall) and other languages.

Each of the four main groups, viz. the Caroline, Marshall, Gilbert and Ladrone (Mariana), from long isolation, has developed ethnological peculiarities of its own. The most advanced folk were the "Chamorros" of the Ladrone, owing to the greater natural resources of the islands, and perhaps more frequent contact with influences from the west; but as a separate people they no longer exist, having been nearly exterminated by the Spaniards in the 17th century. Next in advancement come the Caroline islanders. The general Micronesian type is a well-proportioned rather slightly built figure, with small and regular features; head high and well proportioned, but forehead rather retreating and narrow at the temples; cheek bones and chin slightly prominent; straight black hair, lankner than that of the Polynesians, colour somewhat darker than the Polynesians, the Marshalls being darker and more vigorous than the Carolines, while the Gilbert type, though smaller than the latter, is still darker and coarser. The upper class greatly surpasses the common people in physique and intelligence.

There is a division of society into septs or clans, a membership of which constitutes the closest tie. Persons of the same sept must not intermarry, and when two islands or communities meet in war the members of one sept, however widely separated by distance of space or time, will not injure or fight with each other. Each community is usually composed (but there are local differences) of—(1) an upper class of chiefs, from among whom the head (*tamol* or *iroa*) is chosen; (2) a lower but still noble class; and (3) a common people, mostly without rights of property. These last are only allowed one wife. Here and there are traces, as in Tonga, of a spiritual sovereign, the descendants probably of a conquered dynasty. Succession is through the female side, which assures to women a certain position, and leads besides to some curious results (see paper by J. S. Kubary in *Das Ausland*, 1880, No. 27). The upper class are the keepers of traditions, boat-builders, leaders of expeditions; tattooing is generally done by them, the amount increasing with a man's rank; the custom here still has definite religious associations. Both sexes are tattooed.

The Marshall Islanders are the boldest and most skillful navigators in the Pacific. Their voyages of many months' duration, in great canoes sailing with outrigger to windward, well-provisioned, and depending on the skies for fresh water, help to show how the Pacific was colonized. They have a sort of chart, *medo*, of small sticks tied together, representing the positions of islands and the directions of the winds and currents. A two-edged weapon, of which the blade is of sharks' teeth, and a defensive armour of braided sennit, are also peculiar to the islands; a large *adze*, made of the shell of the *Tridacna gigas* (the largest bivalve known), was formerly used in the Carolines, probably by the old builder race.

The dialects of Micronesia, though grammatically alike, differ widely in their vocabularies. They have the chief characteristics of the Polynesian, with Malay affinities, and peculiarities such as the use of suffixes and inseparable pronouns and, as in Tagal, of the infix to denote changes in the verb; in the west groups there is a tendency to closed syllables and double consonants, and a use of the palatals *ch*, *j*, *sh*, the dental *th*, and *s* (the last perhaps only in foreign words), which is alien to the Polynesian. These letters are wanting in the Gilbert language, which differs considerably from all the others, and has much greater affinities with the Polynesian. Most words take the accent on the penult. In some of the dialects there appears to be no true article, but in the Gilbert Islands the Polynesian *te* is used for both definite and indefinite article. Gender is sexual only. Number in the noun is either gathered from the

were peopled from the west and also from the east. Those who came from the east are expressly said to be from Samoa. Those from the west were more numerous than those from the east. There are also traditions of the arrival of other strangers at some of these islands. On the island of Peru, in the Gilbert group, in 1869 there was still the remnants of a large proah which, from the description given, appears to have been like those used in the Indian Archipelago.

requirement of the sense or is marked by pronominal words or numerals. Case is known by the position of the noun in the sentence or by prepositions. In the language of Ebon, one of the islands in the Marshall archipelago, nouns have the peculiarity which is characteristic of the Papuan languages: those which indicate close relationship—as of a son to a father, or of the members of a person's body—take a pronominal suffix which gives them the appearance of inflexions. Many words are used indiscriminately as nouns, adjectives or verbs, without any change of form. In some languages the personal pronouns are singular, dual and plural. In others there are no special dual forms, but the numeral for two is used to indicate the dual. In the Ebon language there are inclusive and exclusive forms of the personal pronouns which, so far as has been ascertained, do not occur in any of the other languages. The verbs usually have no inflexions to express relations of voice, mood, tense, number of person—such distinctions being indicated by particles. In the Ebon language, however, the tenses are sometimes marked; but in that the simple form of the verb is frequently given. All have verbal directive particles. In Ponape, one of the Caroline Islands, many words of ceremony are used in addressing chiefs, as they are used in Samoa. The custom of tabooing words is also found there as it is in the Polynesian languages.

The religious myths are generally identifiable with the Polynesian, but a belief in the gods proper is overshadowed by a general deification of ancestors, who are supposed from time to time to occupy certain places, and to set up near the family dwelling, and surrounded by circles of smaller ones. These stones are anointed with oil, and worshipped with prayer and offerings, and are also used for purposes of divination, in which, and in various others, there is a general belief. In the Marshalls, in place of these stones, certain palm trees are similarly enclosed. The spirits also sometimes inhabit certain birds or fishes, which are then taboo, as food, to the family; but they will help to catch them for others. Temples are very rare, though these blocks of coral are sometimes surrounded by a roofless enclosure opening to the west. The bodies of the dead, and sometimes even of the sick, are dispatched to sea westwards, with certain rites; those of the chiefs, however, are buried, for the order has something essentially divine about it; their bodies therefore are sacred, and their spirits naturally assume the position above described. Such a belief greatly strengthened the king's authority, for the spirits of his ancestors were necessarily more powerful than any other spirits. Thus too it comes that the chiefs, and all belonging to them, are taboo as regards the common people.

There are various other subjects and occasions of taboo, but the institution has no the oppression and all-pervading character which it has in Polynesia. Its action is often economical or charitable, e.g. the ripening coco-nuts are taboo as long as the bread-fruit lasts, thus securing the former for future use; or it is put on after a death, and the nuts thus saved are given to the family—a kindness to them, and a mark of respect for the dead.

The houses in the Gilberts and Marshalls (much less elaborate than in the Carolines) consist merely of a thatched roof resting on posts or on blocks of coral about 3 ft. high, with a floor at that level, which is reached from an opening in the centre. On this the principal people sleep, and it serves as a storehouse inaccessible to rats, which infest all the islands.

MICRONUCLEUS, the smaller nucleus in Infusoria (*g.s.*). In fission it divides by mitosis, and in conjugation furnishes the pairing or gametoneucl, by whose reciprocal fusion a zygote-nucleus is formed, which gives rise to the meganeucl and micronuclei of the individuals of the next cycle of fission.

MICROPEGMATITE, in petrology, a very fine intergrowth of quartz and alkali feldspar, occurring as the last product of consolidation in many igneous rocks which contain high or moderately high percentages of silica. It shows the same structure on a minute scale as certain pegmatites (*g.s.*) or coarse granitic veins do on a large scale (see *PETROLOGY*, Pl. 2, figs. 6 and 8); the quartz forms angular patches scattered through a matrix of feldspar. In polarized light the separate areas of each mineral extinguish at the same time, and this proves that even though apparently discontinuous they have the same crystalline orientation. The feldspar may be considered an irregular crystal of spongy structure, the interstices being filled up by another spongy crystal of quartz. This kind of mineral intergrowth is said to be "graphic," because the coarsely graphic veins have triangular quartz areas dotted over a feldspathic background resembling certain primitive inscriptions. Micropegmatite differs from "graphic granite" only in being so much finer grained that its nature can only be detected with the microscope. The feldspar of micropegmatite is usually orthoclase, but sometimes albite, oligoclase or microcline. Occasionally it has crystalline form, and then it has been proved that the quartz

may be so disposed that the two minerals have a definite relation between their crystallographic axes (parallel growth). The quartz typically occurs as angular patches; at other times it forms club-shaped, curved or vermicular threads (vermicular micropegmatite, myrmeikite), and then some authors consider that the feldspar has been corroded and the quartz fills up the spaces thus produced (*quartz de corrosion* of French petrographers). Micropegmatite is often so fine grained that even in the thinnest sections and with high powers it cannot be resolved into its components. This fine micropegmatite resembles threads, having a divergent arrangement. In some rocks the whole ground mass consists of such spherulitic growths of fibrous micropegmatite (see QUARTZ—PORPHYRY); in their centres there is often a quartz or feldspar crystal; the outer boundaries of the spherulites are not usually circular but irregular owing to the interlocking of adjacent spherulites at their margins ("granophytic structure"). Micrographic structures may occur in other minerals, e.g. quartz and garnet, cordierite, epidote or hornblende, augite and feldspar, but are less common, and the name micropegmatite is usually reserved for aggregates of quartz and feldspar.

In rocks where micropegmatite frequently occurs (e.g. granite, porphyry and granophyre, quartz-diorite) it is usually the last product of consolidation, and represents the mother liquor left over after the other minerals had separated out in more or less perfect crystals. Hence it has no definite form of its own, but fills up the irregular interspaces between the earlier crystallizations. For that reason it has been compared to a eutectic, and is supposed to be the mixture of quartz and feldspar which has the lowest fusion point. Eutectics are common in alloys and often have a very perfect micrographic structure. The eutectic mixture of quartz and orthoclase has been estimated to contain 70-75% of the latter. This theory, however, is not without its difficulties; analyses of micropegmatite prove that its composition is by no means constant (this may perhaps be due to small admixtures of soda and lime feldspars); and experimental researches on the fusion points of mixtures of quartz and feldspar have not yet shown that there is a definite mixture which melts at a lower temperature than any other. Furthermore micropegmatite is not always the last consolidation product, as a eutectic should be, but may occur as well-shaped phenocrysts lying in a felsitic or glassy matrix which solidified at a still later time. Micrographic structures in the minerals of igneous rocks prove only that these minerals crystallized simultaneously. (J. S. F.)

MICROSCOPE (Gr. *μικρός*, small, *σκοπέω*, to view), an optical instrument for examining small objects or details of such objects; it acts by making the angles of vision under which the images appear greater than when the objects themselves are viewed by the naked eye.

Microscopes are distinguished as *simple* and *compound*. A simple microscope consists of a single positive lens, or of a lens combination acting as a single lens, placed between the eye and the object so that it presents a virtual and enlarged image. The compound microscope generally consists of two positive lens systems, so arranged that the system nearer the object (termed the *objective*) projects a real enlarged image, which occupies the same place relatively to the second system (the *eyepiece* or *ocular*) as does the real object in the simple microscope. An image is therefore projected by the ocular from the real magnified image produced by the objective with increased magnification.

History of the Simple Microscope.—Any solid or liquid transparent medium of lenticular form, having either one convex and one flat surface or two convex surfaces whose axes are coincident, may serve as a "magnifier," the essential condition being that it shall refract the rays which pass through it so as to cause widely diverging rays to become either parallel or but slightly divergent. Thus if a minute object be placed on a slip of glass, and a single drop of water be placed upon it, the drop will act as a magnifier in virtue of the convexity of its upper surface; so that when the eye is brought sufficiently near it (the glass being held horizontally) the object will be seen magnified. Again if a small hole be made in a thin plate of metal, and a minute drop of water be inserted in it, this drop, having two convex surfaces, will serve as a still more powerful magnifier. There is reason to believe that the magnifying power of transparent media with

convex surfaces was very early known. A convex lens of rock-crystal was found by Layard among the ruins of the palace of Nimrud; Seneca describes hollow spheres of glass filled with water as being commonly used as magnifiers.

The perfect gem-cutting of the ancients could not have been attained without the use of magnifiers; and doubtless the artificers who executed these wonderful works also made them. Convex glass lenses were first generally used to assist ordinary vision as "spectacles"; and not only were spectacle-makers the first to produce glass magnifiers (or simple microscopes), but by them also the telescope and the compound microscope were first invented. During the Thirty Years' War the simple microscope was widely known. Descartes (*Dioptrique*, 1637) describes microscopes wherein a concave mirror, with its concavity towards the object, is used, in conjunction with a lens, for illuminating the object, which is mounted on a point fixing it at the focus of the mirror. Antony van Leeuwenhoek appears to be the first to succeed in grinding and polishing lenses of such short focus and perfect figure as to render the simple microscope a better instrument for most purposes than any compound microscope then constructed. At that time the "compass" microscope was in use. One leg of a compass carried the object, and the other the lens, the distance between the two being regulated by a screw. Stands were also in use, permitting the manipulation of the object by hand. Robert Hooke shaped the minutest of the lenses with which he made many of the discoveries recorded in his *Micrographia* from small glass globules made by fusing the ends of threads of spun glass; and the same method was employed by the Italian Father Di-Torre. Early opticians and microscopists gave their chief attention to the improvement of the simple microscope, the principle of which we now explain.

SIMPLE MICROSCOPE

Position and Size of the Image.—A person with normal vision can see objects distinctly at a distance varying from ten inches to a very great distance. Objects at different distances, however, are not seen distinctly simultaneously, but in succession. This is effected by the power of accommodation of the eye, which can so alter the focal length of its crystalline lens that images of objects at different distances can be produced rapidly and distinctly one after another upon the retina.

The angle under which the object appears depends upon the distance and size of the object, or, in other words, the size of the image on the retina is determined by the distance and the dimensions of the object. The ratio between the real size of the object y (fig. 1)

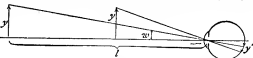

FIG. 1.

and the distance l , which is equal to the tangent of the visual angle w , is termed the "apparent size" of the object. From the figure, which represents vision with a motionless eye, it is seen that the apparent size increases as the object under observation is approached. The greater the visual angle, the more distinctly are the details of the object perceived. On the other hand, as the observer recedes from the object, the apparent size, and also the image on the retina diminishes; details become more and more confused, and gradually, after a while, disappear altogether, and ultimately the external configuration of the object as a whole is no longer recognizable. This case arises when the visual angle, under which the object appears, is approximately a minute arc; it is due to the physiological construction of the retina, for the ends of nerve fibres, which receive the impression of light, have themselves a definite size. The lower limit of the resolving power of the eye is reached when the distance is approximately 3438 times the size of the object. If the object be represented by two separate points, these points would appear distinct to the normal eye only so long as the distance between them is at the most only 3438 times smaller than their distance from the eye. When the latter distance is increased still further, the two appear as one. Therefore when it is desired to distinctly recognize exceedingly small objects or details of such, they are brought as near as possible to the eye. The eye is strained in bringing its focal length to the smallest possible amount, and when this strain is long continued it may cause pain. When the shortest distance obtained by the highest strain of accommodation is insufficient to recognize small objects, distinct vision is possible at even a shorter distance by placing a very small diaphragm

between the eye and the object, the pencils of rays proceeding from the object-points, which otherwise are limited by the pupils of the eye, being thus restricted by the diaphragm. The object is then projected with such acute pencils on the plane focused for, in this case on the plane on which the eye can just accommodate itself, that the circle of confusion arising there is still so small that it is below the limit of angular visual distinctness and on that account appears as a sharp point. However, the loss of light in this procedure is extraordinarily large, so that only most intensely illuminated objects can be investigated.

A naked short-sighted eye, which would be corrected for distant objects by a spectacle glass of -10 diopters, may approach the object up to about 4 in. and have a sharp image upon the retina without any strain whatever. For the observation of small objects, a myopic eye is consequently superior to a normal eye; and the normal eye in its turn is superior to the hypermetropic one. When the details are no longer recognizable by the unaided eye, the magnifying glass or the simple microscope is necessary. As a rule large magnification is not demanded from the former, but a larger field of view, whilst the simple microscope should ensure powerful magnification even when the field is small. The simple microscope enlarges the angle of vision, and does not tire the eye when it is arranged so that the image lies in the farthest limit of distinct vision (the *punctum remotum*). A normal eye will therefore see an image formed by the magnifying glass most conveniently when it is produced at a great distance, i.e. when the object is in its front focal plane. If y (fig. 2) be the object the image appears to a normal

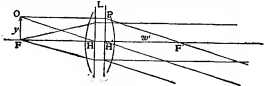

FIG. 2.

eye situated behind the system L with passive accommodation at a very great distance under the angle w' . Since $H'P = F$, $O = y$, from the focal length of the simple microscope, the visual angle w' is given by

$$\tan w'/y = 1/f' = V, \quad (1)$$

in which $f' = H'F'$, is the image-side focal length (see LENS). Since the lens is bounded by air, the image- and object-side focal lengths f' and f are equal. The value $1/f'$ or V in (1), is termed the *power* of the lens. In most cases the number of "diameters" of the simple microscope is required; i.e. the ratio between the apparent sizes of the object when observed through the microscope and when viewed by the naked eye. When a person of normal vision views a small object, he brings it to the distance of distinct vision, which would average about 10 in. The apparent size is then (fig. 1) $\tan w = y/l$, where $l = 10$ in., whilst the apparent size of the object viewed through the magnifying glass would result from the formula (1) $\tan w' = y/f$. Consequently the number of diameters will be

$$N = \tan w' / \tan w = y/f \cdot l/y = lf = V \cdot l; \quad (2)$$

it is thus equal to the magnifying power multiplied by the distance of distinct vision, or the number of times that the focal length is contained in l in.

Since this V for the distance of distinct vision is only conventional, it is understood that the capacity of the simple microscope given in (2) holds good only for eyes accustomed to examine small objects 10 in. away; and observation through the magnifying glass must be undertaken by the normal eye with passive accommodation. A lens of 1 in. focal length must be spoken of, according to this notation, as a $\times 10$ lens, and a lens of $\frac{1}{10}$ in. focal length as a $\times 100$ lens. Obviously the position of a normal eye free from accommodation is immaterial for determining the magnification. A $\times 10$ magnification is, however, by no means guaranteed to a myopic eye of -10 D by a lens of 1 in. focus. Since this short-sighted observer can view the object with the naked eye with no inconvenience to himself at 4 in. distance, it follows (to him) the apparent size is $\tan w = y/4$; and to secure convenient vision through the lens the short-sighted person would bring the object to such a distance that a virtual, magnified image would be projected in his *punctum remotum*. In addition it will be supposed that the centre of the pupil of the observer coincides with the back focal point of the system. The apparent size of the object seen through the lens is then $\tan w' = y/f$. The magnification, resulting from the simple microscope of 1 in. focus, is here $N = \tan w' / \tan w = y/f \cdot 4/y = 4f = 4$. Thus, while a lens of 1 in. focal length assures to the normal-sighted person a $\times 10$ magnification, it affords to the short-sighted individual only $\times 4$. On the other hand, it is even of greater use to the hypermetropic than to the observer of normal sight. From this it appears that each observer obtains specific advantages from one and the same simple microscope, and also the individual observer can obtain different magnifications by either using different accommodations, or by viewing in passive accommodation.

Regulation of the Rays.—In using optical instruments the eye in general is moved just as in free vision; that is to say, the attention is fixed upon the individual parts of the image one after another, the eye being turned in its cavity. In this case the eye is always directed so that the part of the image which is wished to be viewed exactly falls upon the most sensitive portion of the retina, viz. the *macula lutea* (yellow spot). Corresponding to the size of the yellow spot only a small fraction of the image appears particularly distinctly. The other portions which are reproduced on the retina on the regions surrounding the yellow spot will also be perceived, but with reduced definition. These external and less sensitive parts of the retina, therefore, merely give information as to the general arrangement of the objects and to a certain extent act as guide-post in order to show quickly and conveniently, although not distinctly, the places in the image which should claim special attention. Vision with a motionless eye, or "indirect vision," gives a general view of the whole object with particular definition of a small central portion. Vision with a movable eye, or "direct vision," gives exact information as to the parts of the object one after another.

The simple microscope permits such vision. If the instrument has a sensible lens diameter, and is arranged so that the centre of rotation of the eye can coincide with the intersection of the principal rays, the lens can then form with the eye a centred system. Such lenses are termed "lenses for direct vision." By moving the eye about its centre of rotation M the whole field can be examined. The margin of the mount of the lens serves as the diaphragm of the field of view. The selection of the rays emerging from the lens and actually employed in forming the image is undertaken by the pupil of the eye which, in this case, is consequently the exit pupil of the instrument. In fig. 3 PP_1 designates the exit pupil of the

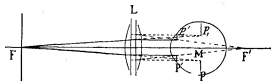

FIG. 3.

lens, and the image of PP_1 , i.e. PP_1 , which is formed by the lens, limits the aperture of the pencils of rays on the object-side; consequently it is the entrance pupil of the instrument. Since the exit pupil moves in observing the whole field, the entrance pupil also moves. The principal rays, which on the object-side connect the object-points with the centre of the entrance pupil, intersect the axis on the image-side at the centre of rotation M of the eye. M is therefore the intersection of the principal rays.

So long as the exit pupil is completely filled the brightness of the image will be approximately equal to that of free vision. If, however, we fix the points lying towards the margin of the field of view, the diaphragm gradually cuts off more and more of the rays which were necessary to fill the pupil, and in consequence the brightness gradually falls off to zero. This vignetting can be observed in all lenses.

In most cases, and also in corrected systems, the intersection of the principal rays is no longer available for the centre of rotation of the eye, and this kind of observation is impossible.

In some instruments observation of the whole available field is only possible when the head and eye are moved at the same time, the lens retaining its position. Dr M. von Rohr terms this kind of vision "peep-hole observation." It has mainly to be considered in connexion with powerful magnifying glasses. In most cases a diaphragm regulates the

rays. Fig. 4 shows the position of the diaphragms to be considered in this kind of observation. PP_1 is the entrance pupil, PP_1' the exit pupil, and GG the diaphragm. The intersection of the principal rays in this case lies in the middle of the entrance pupil or of the exit pupil. By head and eye motion the various parts of the whole field can be viewed one after another. The distance of the eye from the lens is here immaterial. In this case also the illumination must fall to zero by the vignetting of the pencils coming from objects at the margin of the field of view. C and D are the outermost rays which can pass through the instrument.

Magnifying glasses are often used for viewing three-dimensional objects. Only points lying on the plane focused for can be sharply reproduced in the retina, which acts as object-plane to the retina.

¹ See also LENS.

All points lying out of this plane are reproduced as circles of confusion. The central projection, of which the centre is the middle point of the entrance pupil on the plane focused for, will show in weaker systems, or those very much stopped down, a certain finite depth of definition; that is to say, the totality of points, which lie out of the plane focused for, and which are projected with circles of confusion so small that they appear to the eye as sharp points, will include the sharp object relief, and determine the depth of definition of the lens. With increasing magnification the depth of definition diminishes, because the circles of confusion are greater in consequence of the shorter focal length. Very powerful simple microscopes have hardly any depth of definition so that in fact only points lying in one plane can be seen sharply with one focusing.

Illumination.—So long as the pupil of the observer alone undertakes the regulation of the rays there is no perceptible diminution of illumination in comparison with the naked eye vision. The losses of light which occur in this case are due to reflection, which takes place in the passage of the light through the glass surfaces. In a lens with two bounding surfaces in air there is a loss of about 9%; and in a lens system consisting of two separated lenses, *i.e.* with four surfaces in air, about 17%. Losses due to absorption are almost zero when the lenses are very thin, as with lenses of small diameter. A very marked diminution in illumination occurs, however, when the exit-pupil of the instrument is smaller than the pupil of the eye. In such instruments an arrangement is often required to intensely illuminate the object.

Forms of the Simple Microscope.—If the ordinary convex lens be employed as magnifying glass, great aberrations occur even in medium magnifications. These are: (1) chromatic aberration, (2) spherical aberration and (3) astigmatism (see **ABERRATION**).

When the pupil regulates the aperture of the rays producing the image the aberrations of the ordinary lenses increase considerably with the magnification, or, what amounts to the same thing, with the increase in the curvature of the surfaces. For lenses of short focus the diameter of the pupil is too large, and diaphragms must be employed which strongly diminish the aperture of the pencils, and so reduce the errors, but with a falling off of illumination. To reduce the aberrations Sir David Brewster proposed to employ in the place of glass transparent minerals of high refractive index and low dispersion. In this manner lenses of short focus can be produced having lower curvatures than glass lenses necessitate. The diamond has the requisite optical properties, its index of refraction being about 1.6 times as large as that of ordinary glass. The spherical aberration of a diamond lens can be brought down to one-ninth of a glass lens of equal focus. Apart, however, from the cost of the mineral and its very difficult working, a source of error lies in its want of homogeneity, which often causes a double or even a triple image. Similar attempts made by Pritchard with sapphires were more successful. With this mineral also spherical and chromatic aberration are a fraction of that of a glass lens, but double refraction, which involves a doubling of the image, is fatal to its use. Improvements in glass lenses, however, have rendered further experiments with precious stones unnecessary. The simplest was a sphere of glass, the equator of which (*i.e.* the mount) formed the diaphragm. Wollaston altered this by taking two plano-convex lenses, placing the plane surfaces towards each other and employing a diaphragm between the two parts (fig. 5).

Wollaston. Brewster. Brewster (Stanhope).



FIG. 5.

FIG. 6.

FIG. 7.

Sir David Brewster found that Wollaston's form worked best when the two lenses were hemispheres and the central space was filled up with a transparent cement having the same refractive index as the glass; he therefore used a sphere and provided it with a groove at the equator (see fig. 6). Coddington employed the same considered further experiments with precious stones unnecessary. The simplest was a sphere of glass, the equator of which (*i.e.* the mount) formed the diaphragm. Wollaston altered this by taking two plano-convex lenses, placing the plane surfaces towards each other and employing a diaphragm between the two parts (fig. 5).

Doublets, &c.—To remove the errors which the above lenses showed, particularly when very short focal lengths were in question, lens combinations were adopted. The individual

components required weaker curvatures and permitted of being more correctly manufactured, and, more particularly, the advantage of reduced aberrations was the predominant factor.

Wollaston's doublet (fig. 8) is a combination of two plano-convex lenses, the focal lengths of which are in the ratio of 3 : 1; the plane Wollaston. Fraunhofer. Wilson. Steinhil. Chevalier (Brücke).

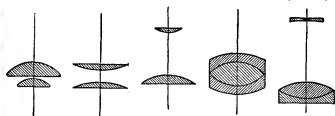

FIG. 8.

FIG. 9.

FIG. 10.

FIG. 11.

FIG. 12.

sides are turned towards the object, and the smaller of the two lenses is nearer the object. This construction was further improved (1) by introducing a diaphragm between the two lenses; (2) by altering the distance between the two lenses; and (3) by splitting the lower lens into two lenses. Triplets are employed when the focal length of the simple microscope was less than $\frac{1}{4}$ in. When well made such constructions are almost free from spherical aberration, and the chromatic errors are very small. Similar doublets composed of two plano-convex lenses are the Fraunhofer (fig. 9) and the Wilson (fig. 10). Axial aberration is reduced by distributing the refraction between two lenses; and by placing the two lenses farther apart the errors of the pencils of rays proceeding from points lying outside the axis are reduced. The Wilson has a greater distance between the lenses, and also a reduction of the chromatic difference of magnification, but compared with the Fraunhofer it is at a disadvantage with regard to the size of the free working distance, *i.e.* the distance of the object from the lens surface nearer it.

By introducing a dispersive lens of flint the magnifying glass could be corrected for both chromatic and spherical aberrations. Browning's "platicopic" lens and the Steinhil "aplanatic" lens (fig. 11) are of this type. Both yield a field of good definition free from colour.

The manner in which the eye uses such a lens was first effectively taken into account by M. von Rohr. These anastigmatic lenses, which are manufactured up to X 40, are chromatically and spherically corrected, and for a middle diaphragm the errors of lateral pencils, distortion, astigmatism and coma are eliminated. "Peephole" observation is employed, observation being made by moving the head and eye while the lens is held steady. Even in powerful magnifications a good image exists in all parts of a relatively large field, and the free working distance is fairly large.

For especially large free working distances the corrections proposed by Chevalier and carried out by E. Brücke must be noticed (fig. 12). To an achromatic collective lens, which is turned towards the object, a dispersive lens is combined (this type to a certain extent belongs to the compound microscope). By altering the distance of the collective and dispersive members the magnification can be widely varied. Through the large free working distance, which for certain work offers great advantages, the size of the field of view is diminished.

In magnifying glasses for direct vision the eye must always be considered. The lens is brought as close as possible to the eye so as to view as large a field as possible. The watchmaker's glass is one of the earliest forms of this kind. Gullstrand showed how to correct these lenses for direct vision, *i.e.* to eliminate distortion and astigmatism when the centre of rotation of the eye coincided with the point where the principal rays crossed the axis. Von Rohr fulfilled this condition by constructing the Verant lens, which are low power systems intended for viewing a large flat field.

Stands.—For dissecting or examining objects it is an advantage to have both hands free. Where very short focus simple microscopes are employed, using high magnifications, it is imperative to employ a stand which permits exact focusing and the use of a special illuminating apparatus. Since, however, only relatively low powers are now employed, the ordinary rack and pinion movement for focusing suffices, and for illuminating the object only a mirror below the stage is required when the object is transparent, and a condensing lens above the stage when opaque.

Dissecting stands vary as to portability, the size of the stand, and the manner in which the apparatus are arranged. A stand is shown in fig. 57 (Plate). On the heavy horseshoe foot is a column carrying the stage. In the column is the guide for the rack-and-pinion movement. Lenses of various magnifications can be adapted to the carrier and moved about over the stage. The rests can be attached to the stage, and when done with folded together. Illumination of transparent objects is effected by the universal-jointed mirror. By turning the knob A, placed at the front corner of

the stage, a black or white plate, forming a dark or light background, can be swung underneath the specimen.

When the recognition of the arrangement in space of small objects is desired a stereoscopic lens can be used. In most cases refracting and reflecting systems are arranged so that the natural inter-pupillary distance is reduced. Stereoscopic lenses can never be powerful systems, for the main idea is the recognition of the depth of objects, so that only systems having a sufficient depth of definition can be utilized. Very often such stereoscopic lenses, owing to faulty construction, give a false idea of space, ignoring the errors which are due to the alteration of the inter-pupillary distance and the visual angles belonging to the principal rays at the object-side (see BINOCULAR INSTRUMENTS).

COMPOUND MICROSCOPE

The view held by early opticians, that a compound microscope could never produce such good images as an instrument of the simple type, has proved erroneous; and the principal attention of modern opticians has been directed to the compound instrument. Although we now know how the errors of lenses may be corrected, and how the simple microscope may be improved, this instrument remains with relatively feeble magnification, and to obtain stronger magnifications the compound form is necessary.

By compounding two lenses or lens systems separated by a definite interval, a system is obtained having a focal length considerably less than the focal lengths of the separate systems. If f and f' be the focal lengths of the combination, f_1, f'_1 and f_2, f'_2 the focal lengths of the two components, and Δ the distance between the inner foci of the components, then $f = -f_1 f_2 / \Delta$, $f' = f'_1 f'_2 / \Delta$ (see LENS). Δ is also equal to the distance $F_1 F_2$. The accented f 's are always on the image side, whilst the unaccented are on the object side. From this formula it follows, for example, that one obtains a system of $\frac{1}{2}$ in. focal length by compounding two positive systems of 1 in. each, whose focal planes, turned towards one another, are separated by 8 in.

A microscope objective being made in essentially the same way as a simple microscope, and the front focus of the compound system being situated before the front focus of the objective, the magnification due to the simple system makes the free object distance greater than that obtained with a simple microscope of equal magnification. Moreover, the distance between the object and eye is substantially increased in the compound microscope by the stand; the inconveniences, and in certain circumstances also the dangers, to the eye which may arise, for example by warming the object, are also avoided. The convenient and rapid change in the magnification obtained by changing the eyepiece or the objective is also a special advantage of the compound form.

In the commonest compound microscopes, which consist of two positive systems a real magnified image is produced by the objective. This permits researches which are impossible with the simple microscope. For example, the real image may be recorded on a photographic plate; it may be measured; it can be physically altered by polarization, by spectrum analysis of the light employed by absorbing layers, &c. The greatest advantage of the compound microscope is that it represents a larger area, and this much more completely than is possible in the simple form. According to the laws of optics it is only possible either to portray a small object near one of the foci of the system with wide pencils, or to produce an image from a relatively large object by correspondingly narrow pencils. The simple microscope is subject to this limitation. As we shall see later, one of the principal functions of the microscope objective is the representation with wide pencils. In that case, however, in the compound microscope a small object may always be represented by means of wider pencils, one of the foci of the objective (not of the collective system) being near it. For the eyepiece and the other rule holds; the object is represented by narrow pencils, and it is hence possible to subject the relatively great object, viz. the magnified real image, to a further representation.

History of the Compound Microscope.—The arrangement of two lenses so that small objects can be seen magnified followed soon after the discovery of the telescope. The first compound microscope (discovered probably by the Middelburg lens-grinders, Johann and Zacharias Jansen about 1590) was a combination of a strong biconvex with a still stronger biconcave lens; it had thus, as well as the first telescope, a negative eyepiece. In 1646 Fontana described a microscope which had a positive eyepiece. The development of the compound microscope essentially depends on the improvement of the objective; but no distinct improvement was made in its construction in the two centuries following the discovery. In 1668 the Italian Divini employed several doublets, i.e. pairs of plano-convex lenses, and his example was followed by Griendl von Ach. But even with such moderate magnification as these instruments permitted many faults were apparent. A microscope, using concave mirrors, was proposed in 1672 by Sir Isaac Newton; and he was succeeded

by Barker, R. Smith, B. Martin, D. Brewster, and, above all, Amici. More recently these catadioptric microscopes were disregarded because they yielded unfavourable results. From 1830 onwards many improvements were made in the microscope objective; these may be best followed from a discussion of the faults of the image.

Position and Size of Image.—In most microscopic observations the object is mounted on a plane glass plate or slide about 0.06 in. thick, embedded in a liquid such as water, glycerine or Canada balsam, and covered with a plane glass plate of about 0.008 to 0.006 in. thick, called the cover-slip. If we consider the production of the image of an object of this kind by the two positive systems of a compound microscope shown in fig. 13, the objective L_1 forms a real magnified image $O'O_1$; the object OO_1 must therefore lie somewhat in front of the front focus F_1 of the objective. Let $OO_1 = y$, $O'O_1 = y'$, the focal distance of the image $F_1 O' = \Delta$, and the image-side focal length f'_1 , then the magnification

$$M = y'/y = \Delta/f'_1 \quad (3)$$

The distance Δ is called the "optical tube length". Weak and strong microscope objectives act differently. Weak systems act like photographic objectives. In this case the optical tube length may be altered within fixed limits without spoiling the image; at the same time the objective magnification M is also altered. This change is usually effected by mounting the objective and eyepiece on two telescoping tubes, so that by drawing apart or pushing in the tube length is increased or diminished at will. For strong objectives there is, however, only one optical tube length in which it is possible to obtain a good image by means of wide pencils, any alteration of the tube length involving a considerable spoiling of the image. This limitation is examined below.

When forming an image by a microscope objective it often happens that the transparent media bounding the system have different optical properties. A series of objectives with short focal lengths are available, which permit the placing of a liquid between the cover-slip and the front lens of the objective; such lenses are known as "immersion systems"; objectives bounded on both sides by air are called "dry systems." The immersion liquids in common use are water, glycerine, cedar-wood oil, monobromonaphthalene, &c. Immersion systems in which the embedding liquid, cover-slip, immersion-liquid and front lens have equal refractive indices are called "homogeneous immersion systems." In immersion systems the object-side focal length is greater than the image-side focal length. Nothing is altered as to objective magnification, however, as the first surface is plane, and the employment of the immersion means that the value of f'_1 is unaltered.

If we assume that a normal eye observes the image through the eyepiece, the eyepiece must project a distant image from the real image produced by the objective. This is the case if the image $O'O_1$ lies in the front focal plane of the eyepiece. In this case the optical tube length equals the distance of the adjacent focal planes of the two systems, which equals the distance of the image-side focus of the objective F_2 from the object-side focus of the eyepiece F_1 . The image viewed through the eyepiece appears then to the observer under the angle w' , and as with the single microscope

$$\tan w'/y' = 1/f'_2 \quad (4)$$

where f'_2 is the image-side focal length of the eyepiece.

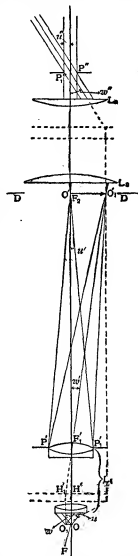

FIG. 13.—Ray transmission in compound microscope with a positive ocular.

L_1 = objective, L_2 = eyepiece of the Ramsden type. F_1, F'_1 = object- and image-side foci of objective.

F_2 = front focus of eyepiece.

P, P' = exit pupil of objective.

P, P' = exit pupil of complete microscope.

D, D' = diaphragm of field of view.

To obtain the magnification of the complete microscope we must combine the objective magnification M with the action of the eyepiece. If we replace y' in equation (4) by the value given by (3), we obtain

$$\tan w''/y = \Delta l/f_1' \cdot 1/f_2'' = V, \quad (5)$$

the magnification of the complete microscope. The magnification therefore equals the power of the joint system.

The magnification is also expressed as the ratio of the apparent size of the object observed through the microscope to the apparent size of the object seen with the naked eye. As the conventional distance for clear vision with naked eye is 10 in., it results from fig. 1 that the apparent size is $\tan w = y/l$. If this value of y be inserted in equation (5), we obtain the magnification number of the compound microscope:—

$$N = \tan w''/\tan w = \Delta l/f_1' f_2'' = V. \quad (6)$$

The magnification number increases then with the optical tube-length and with the diminution of the focal lengths of objective and eyepiece. As with the simple microscope, different observers see differently in the same compound microscope; and hence the magnification varies with the power of accommodation.

The image produced by a microscope formed of two positive systems (fig. 13) is inverted, the objective L_1 tracing from the object OO_1 a real inverted image $O'O'_1$, and the eyepiece L_2 maintaining this arrangement. For many purposes it is immaterial whether the image is inverted or upright; but in some cases an upright image lightens the work, or may be indispensable.

The simplest microscope which produces an upright image has a negative lens as eyepiece. As shown in fig. 14, the real image formed by the objective must fall on the object-side focal plane of the eyepiece F_2 , where a normal eye without accommodation can observe it. But as the object-side focus F_2 lies behind the eyepiece, the real image is not produced, but the converging pencils from the object are changed by the eyepiece into parallels; and the point O_1 in the top of the object y appears at the top of the eye, i.e. the image is upright.

The erection of inverted images by prisms, which was applied to the simple telescope by Porro, and to the binocular (q.v.) by A. A. Boutanger was employed by K. Bratuschek in the Greenough double microscope; these inverting prisms permit a convenient adaptation of the instrument to the interpupillary distance of the observer. Double microscopes, which produce a correct impression of the solidity of the object, must project upright images. The terrestrial eyepiece (see TELESCOPE), which likewise ensures an upright image, but which involves an inconvenient lengthening, has also been employed in the binocular microscope.

Regulation of the Eye.—Weak and medium microscope objectives work like photographic objectives in episcopic or diascopic projection; in the microscope, however, the projected image is not intercepted on a screen, but a real image in air is formed. This must lie in the front focal plane of the eyepiece if we retain the supposition that it is to be viewed by a normal eye with passive accommodation. The plane in the object conjugate to the focal plane of the eye-piece is the plane focused for; and all points in it are sharply portrayed (a perfect objective being assumed). Object points lying out of the focal plane, on the other hand, are projected as circles of confusion on the plane focused for, the centre of the entrance pupil being the centre of projection and the circles of confusion consisting of the points of the focal plane, the object-side *imago*. As the pencils used in the representations are of wide aperture on the object-side, only such points as are proportionately very near the focal plane can produce such small dispersion circles on the plane focused for, that they, so far as the objective- and eyepiece-magnification permit, appear as points to the eye. It follows that the depth of definition of the microscope is in general very trifling. As it is entirely a

function of the aperture and the magnification, it can be increased by diminishing the entrance pupil, the magnification remaining unchanged. A diminution of the aperture, however, would injure a very much more important property, viz. the resolving power (see below). With powerful systems, object-points lying quite near the plane focused for would be represented by such large dispersion circles that practically only the points lying in one plane appear simultaneously sharp; and it is only by varying the focus that the object-points lying in other planes can be observed.

The position of the diaphragm limiting the pencils proceeding from the object-points is not constant in the compound microscope. In all microscopes the rays are limited, not in the eyepiece, but in the objective, or before the objective when using a condenser. If the pencils are limited in the objective, the restriction of the pencil proceeding from the object-point is effected by either the front lens itself, by the boundary of a lens lying behind, by a real diaphragm placed between or behind the objective, or by a diaphragm-image.

The centre of the entrance pupil is the point of intersection of the principal rays; and it is therefore determinative for the perspective representation on the plane focused for. In fig. 15 the centre of the

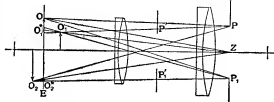

(After M. v. Rohr.)

FIG. 15.—Entocentric transmission through a microscope objective.

E = plane focused for; O_1^* , O_2^* = projections of O_1O_2 on E ; Z = centre of projection; P P_1 = a virtual image of real diaphragm $P'P'_1$ with regard to the preceding part of the objective is the entrance pupil.

entrance pupil lies behind the focal plane, and consequently nearer objects appear larger, and farther objects smaller ("entocentric transmission," see below). If a diaphragm lying in the back focal plane of the objective forms the exit pupil for the objective, as in figs. 13 and 14, so that its image, the entrance pupil, lies at infinity, all the principal rays in the object-space are parallel to the axis, and we have on the object-side "telecentric" transmission. The size of the *imago* on the focal plane is always equal to its actual size, and is independent of the distance of the object from the plane focused for. This representation acquires a special importance if the object be microscopically measured, for an inaccuracy in focusing does not involve an alteration of the size of the image. To ensure the telecentric transmission, the diaphragm in the back focus of the objective may be replaced by a diaphragm in the front focal plane of the condenser, supposing that uniformly illuminated objects are being dealt with; for in this case all the principal rays in the object-space are transmitted parallel to the axis.

With uniformly illuminated objects it may happen that the pencil in the object-space may be limited before passing the object, either through the size of the source of light employed or through a diaphragm connected with the illuminating system. In fig. 16

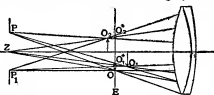

(After M. v. Rohr.)

FIG. 16.—Hypercentric transmission in a microscope objective.

E , O_1^* , O_2^* and Z as in fig. 15. PP_1 is the entrance pupil.

the intersection of the principal rays lies in front of the object, and consequently objects in front of the plane focused for will be projected on E magnified and the objects lying behind it diminished ("hypercentric" transmission). It produces a perspective representation entirely opposed to ordinary vision. As objects lying near us appear smaller in the case of hypercentric transmission than those lying farther from us, we receive a false impression of the spatial arrangement of the object.

Whether the entrance pupil be before or behind the object, in general its position is such that it lies not too near the object, so that the principal rays will have in the object space only trifling inclinations towards one another or are strictly parallel. This is especially important, for otherwise pencils from points placed somewhat laterally to the axis arrive with diminished aperture at the image.

We see from fig. 13 that the objective's exit pupil $P'P'_1$ is portrayed by the positive eyepiece, the image $P''P''_1$ limits the pencils

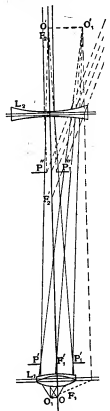

FIG. 14.—Ray transmission in compound microscope with a negative eyepiece.

L_1 = weak achromatic objective.
 L_2 = negative eyepiece.
 F_1 , F_1' = object- and image-side foci of objective.
 F_2 , F_2' = object- and image-side foci of eyepiece.
 $P'P'_1$ = exit pupil of objective.
 $P''P''_1$ = virtual image of $P'P'_1$ = exit pupil of complete microscope.

of the microscope is in general very trifling. As it is entirely a

proceeding from the eyepiece. This image $P'P_1''$ is then the exit pupil of the combined system, and consequently the image of the entrance pupil of the combined system. As the exit pupil $P'P_1''$ for the objective lies before the front focus of the eyepiece, generally at some distance and near the objective, the eyepiece projects a real image from it behind its image-side focus, so that if this point is accessible it is the exit pupil $P''P_1'$. If, e.g., on the object-space the objective has telecentric transmission, the exit pupil must coincide with the back focal plane of the combined system, and it always lies behind the image-side focus of the eyepiece. The exit pupil, often called Ramsden's circle, is thus accessible to the observer, who by head- and eye-movements may survey the whole field.

We can now understand the ray transmission in the compound microscope, shown in fig. 13. Points of a small object (compared with the focus of the objective) send to the objective wide pencils. The diaphragm limiting them, i.e. the entrance pupil, is placed so that the principal rays are either parallel or slightly inclined. The pencils producing the real image are very much more acute, and their inclination is the smaller the stronger the magnification. The eyepiece, which by means of narrow pencils represents the relatively large real image at infinity, transmits from all points of this real image parallel pencils, whereby the inclination of the principal rays becomes further increased. The point of intersection, i.e. the centre of the exit pupil, is accessible to the eye of the observer. In the case of the negative eyepiece, on the other hand, the divergence of the principal rays through the eyepiece is also further augmented, but their point of intersection is not accessible to the eye. This property shows the superiority of the collective eyepiece over the dispersive.

The increase of the inclination of the principal rays, which arises with the microscope, influences the perception of the relief of the object. In entocentric transmission this phenomenon appears in general as in the case of the contemplation of perspective representations at a too short distance, the objects appearing flattened. Although in the case of the spatial comprehension of a perspective representation experience plays a large part, in observing through a microscope it does not count, or only a little, for the object is presumably quite unknown. In telecentric and hypercentric transmission we obtain a false conception of the spatial arrangement of the objects or their details; in these cases one focusses by turns on the different details, and so obtains an approximate idea of their spatial arrangement.

While the limiting of the pencil is almost always effected by the objective, the limiting of the field of view is effected by the eyepiece, and indeed it is carried out by a real diaphragm DD arranged in the plane of the real image $O'O_1'$ (fig. 13) projected from the objective. The entrance window of the eyepiece in this diaphragm projected by the objective in the surface conjugate to the plane focused for, and the exit window is the image projected by the eyepiece; this happens with the image of the object lying at infinity. The result must be that the field of view exhibits a sharp border. In the case of the dispersive eyepiece, on the contrary, no sharply limited field can arise, but vignetting must occur.

Illumination.—The dependence of the clearness of the image on the aperture of the system, i.e. on the angular aperture of the image-producing pencil, holds for all instruments.

The brightness of image points in a median section of the pencil are proportional to the aperture of the lens, supposing that the rays are completely reunited. This is valid so long as the pencil is in air; but if, on the other hand, the pencil passes from air through a plane surface into an optically denser medium, e.g. water or glass, the pencil becomes more acute and the aperture smaller. But since no rays are lost in this transmission (apart from the slight loss due to reflection) the brightness of the image point in the water is as large as that in air, although the apertures have become less. Fig. 17 shows a pencil in air, A, dispersing in water, W, from the semi-aperture u_0 , or a pencil in water dispersing in air from the semi-aperture u_1 . If the value of the clearness in air be taken as $\sin u_0$, then by the law of refraction $N \sin u_1 = \sin u_0$, the value for the clearness in water is $N \sin u_1$. This rule is general. The value of the

clearness cannot come out into the air, but are totally reflected. If pencils proceed from media of high optical density to media of low density, and have a semi-aperture greater than the critical angle, total reflection occurs; in such cases no plane surface can be employed, hence front lenses have small radii of curvature in order to permit the wide pencils to reach the air (see fig. 19, in which P is the preparation, O the object-point in it, D the cover slip, the immersing liquid, and L the front lens).

The function $n \sin u = A$, for the microscope, has been called by Abbe the **numerical aperture**. In dry-systems only the sine of the semi-aperture is concerned; in immersion-systems it is the product of the refractive index of the immersion-liquid and the sine of the object-side semi-aperture. In the case of the brightness of large objects obviously the whole pencil is involved, and hence the clearness is the squares of these values, i.e. $\sin^2 u$ or $n^2 \sin^2 u$. As the semi-aperture of a pencil proceeding from an object point cannot exceed 90° , the numerical aperture of a dry-system cannot be greater than 1. On the other hand, in immersion-systems the numerical aperture can almost amount to the refractive index, for $A = n \sin u < n$.

Dry systems of 0.98 numerical aperture, water immersion ($n = 1.33$) from $A = 1.25$, of immersion ($n = 1.51$) from $A = 1.40$, are even α -bromonaphthalene immersion ($n = 1.65$ from $A = 1.60$, are available. In immersion-systems of such considerable aperture no medium of smaller refractive index than the immersion liquid may be placed between the surface of the front lens and the object, as otherwise total reflection would occur. This is especially inconvenient in the case of the α -bromonaphthalene immersion. As the embedding and immersing liquids must have equal refractive indexes, one must use α -bromonaphthalene for embedding; but this substance destroys organic preparations, so that one can employ this immersion-system only for examining inorganic materials, e.g. fine diatoms.

In immersion-systems a very much greater aggregate of rays is used in the representation than is possible in dry-systems. In addition to a considerable increase in brightness the losses due to reflection are avoided; losses which arise in passing to the back surface of the cover-slip and to the front surface of the front lens.

THE PHYSICAL THEORY

In order to fully understand the representation in the microscope, the process must be investigated according to the wave-theory, especially in considering the representation of objects or object details having nearly the size of a wave-length. The rectilinear rays, which we have considered above, but which have no real existence, are nothing but the *paths* in which the light waves are transmitted. According to Huygens's principle (see DIFFRACTION) each aether particle, set vibrating by an incident wave, can itself act as a new centre of excitement, emitting a spherical wave; and similarly each particle on this wave itself produces wave systems. All systems which are emitted from a single source can by a suitable optical device be directed that they simultaneously influence one and the same aether particle. According to the phase of the vibrations at this common point, the waves mutually strengthen or weaken their action, and there arises greater clearness or obscurity. This phenomenon is called interference (*q.v.*). E. Abbe applied the Fraunhofer diffraction phenomena to the explanation of the representation in the microscope of uniformly illuminated objects.

If a grating is placed as object before the microscope objective, Abbe showed that in the image there is intermittent clear and dark banding only, if at least two consecutive diffraction spectra enter into the objective and contribute towards the image. If the illuminating pencil is parallel to the axis of the microscope objective, the illumination is said to be direct. If in this case the aperture of the objective be so small, or the diffraction spectra lie so far from each other, that only the pencil parallel to the axis, i.e. the spectrum of zero order, can be admitted, no trace is generally found of the image of the grating. If, in addition to the principal maximum, the maximum of 1st order is admitted, the banding is distinctly seen, although the image does not yet accurately resemble the object. The resemblance is greater the more diffraction spectra enter the objective. From the Fraunhofer formula $\delta = \lambda/n \sin u_0$ one can immediately deduce the limit to the diffraction constant δ , so that the banding by an objective of a certain numerical aperture can be perceived. The value $n \sin u_0$ equals the numerical aperture A , where n is the refractive index of the immersion-liquid, and u_0 is the semi-aperture on the object-side. For microscopy the Fraunhofer formula is best written $\delta = \lambda/A$. This expresses δ as the resolving power in the case of direct lighting. All details of the object so resolved are perceived, if two diffraction maxima can be passed through the objective, so that the character of the object is seen in the image, even if an exact resemblance has not yet been attained.

The Fraunhofer diffraction phenomena, which take place in the

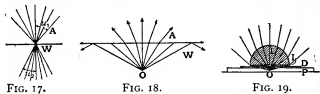

FIG. 17.

FIG. 18.

FIG. 19.

clearness of an image-point in a median section is the sine of the semi-aperture of the pencil multiplied with the refractive index of the medium.

An illustration of this principle is the immersion experiment. A view taken under water from the point O (fig. 18) sees not only the whole horizon, but also a part of the bed of the sea. The whole field of view in air of 180° is compressed to one of 97.5° in water. The rays from O which have a greater inclination to the vertical

back focal plane of the objective, can be conveniently seen with the naked eye by removing the eyepiece and looking into the tube, or better by focusing a weak auxiliary microscope on the back focal plane of the objective. If one has, e.g. in the case of a grating, telecentric transmission on the object-side, and in the front focal plane of the illuminating system a small circular aperture is arranged, then by the help of the auxiliary microscope one sees in the middle of the back focal plane the round white image O (fig. 20) and to the right and left the diffraction spectra, the images of different colours partially overlapping. If a resolvable grating is considered, the diffraction phenomenon has the appearance shown in fig. 21.

It is possible to almost double the resolving power, as in the case

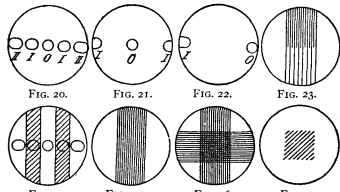

FIG. 20.

FIG. 21.

FIG. 22.

FIG. 23.

FIG. 24.

FIG. 25.

FIG. 26.

FIG. 27.

(From Abbe, *Theorie der Bilderzeugung im Mikroskop*.)

of direct lighting, so that a banding of double the fineness can be perceived, by inclining the illuminating pencil to the axis; this is controlled by moving the diaphragm laterally. If the obliquity of illumination be so great that the principal maximum passes through the outermost edge of the objective, while a spectrum of 1st order passes the opposite edge, so that in the back focal plane the diffraction phenomenon shown in fig. 22 arises, banding is still to be seen. The resolution in the case of oblique illumination is given by the formula $\delta = \lambda/2A$.

Reverting to fig. 13, we suppose that a diffracting particle of such fineness is placed at O that the diffracted pencils of the 1st order make an angle w with the axis; the principal maximum of the Fraunhofer diffraction phenomena lies in F_1' ; and the two diffraction maxima of the 1st order in P' and P_1' . The waves proceeding from this point are united in the point O' . Suppose that a well corrected objective is employed. The image O' of the point O is then the interference effect of all waves proceeding from the exit pupil of the objective $F_1 P_1'$.

As he showed that for the production of an image the diffraction maxima must lie within the exit pupil of the objective. In the silencing of a glass plate lines are ruled as shown in fig. 23, one set traversing the field while the intermediate set extends only half-way across. If this object be viewed by the objective, so that at least the diffraction spectra of 1st order pass the finer divisions, then the corresponding diffraction phenomenon in the back focal plane of the objective has the appearance shown in fig. 21, while the diffraction figure corresponding to the coarser ruling appears as given in fig. 20. If one puts out by a diaphragm in the back focal plane of the objective all diffraction spectra except the principal maximum, one sees in the image a field divided into two halves, which show different clearness, but no banding. By choosing a somewhat broader diaphragm, so that the spectra of 1st order can pass the larger division, there arises in the one half of the field of view the image of the larger division, the other half being clear without any such structure. By using a yet wider diaphragm which admits the spectra of 2nd order of the larger division and also the spectra of 1st order of the fine division, an image is obtained which is similar to the object, i.e. it shows bands one half a division double as fine as the other. If now the spectrum of 1st order of the larger division be cut out from the diffraction figure, as is shown in fig. 24, an image is obtained which over the whole field shows a similar division (fig. 25), although in the one half of the object the represented banding does not occur. Still more strikingly is this phenomenon shown by Abbe's diffraction plate (fig. 26). This is a so-called cross grating formed by two perpendicular gratings. Through a suitable diaphragm in the back focal plane, banding can easily be produced in the image, which contains neither the vertical nor the horizontal lines of the two gratings, but there exist streaks, whose direction halves the angle under which the two gratings intersect (fig. 27). There can thus be shown structures which are not present in the object. Colonel Dr Woodward of the United States army showed that interference effects appear to produce details in the image which do not exist in the object. For example, two to five rows of globules were produced, and photographed, between the bristles of mosquito wings by using oblique illumination. In observing with strong systems it is therefore necessary cautiously to distinguish

between spectral and real marks. To determine the utility of an objective for resolving fine details, one experiments with definite objects, which are usually employed simultaneously for examining its other properties. Most important are the fine structures of diatoms such as *Sarrella gemma* and *Amphipleura pellucida* or artificial fine divisions as in a Nobert's grating. The examination of the objectives can only be attempted when the different faults of the objective are known.

If microscopic preparations are observed by diffused daylight or by the more or less white light of the usual artificial sources, then an objective of fixed numerical aperture will only represent details of a definite fineness. All smaller details are not portrayed. The Fraunhofer formula permits the determination of the most useful magnification of such an objective in order to utilize its full resolving power.

As we saw above, the apparent size of a detail of an object must be greater than the angular range of vision, i.e. $1'$. Therefore we can assume that a detail which appears under an angle of $2'$ can be surely perceived. Supposing, however, there is oblique illumination, then formula (5) can always be applied to determine the magnifying power attainable with at least one objective. By substituting γ , the size of the object, for d , the smallest value which a single object can have in order to be analysed, and the angle w' by $2'$, we obtain the magnifying power and the magnification number:

$$V_2 = \tan w'/\delta = 2A \tan 2'/\lambda; N_2 = 2A \tan 2'/\lambda;$$

where l equals the sight range of 10 in.

Even if the details can be recognized with an apparent magnification of $2'$, the observation may still be inconvenient. This may be improved when the magnification is so increased that the angle under which the object, when still just recognizable, is raised to $4'$. The magnification and magnifying number which are most necessary for a microscope with an objective of a given aperture can then be calculated from the formulae:

$$V_4 = 2A \tan 4'/\lambda; N_4 = 2A \tan 4'/\lambda.$$

If 0.55μ is assumed for daylight observation, then according to Abbe (*Journ. Roy. Soc.*, 1882, p. 463) we have the following table for the limits of the magnification numbers, for various microscopic objectives, $A = 0.901 \text{ mm.}^{-1}$.

$A = 0.901 \text{ mm.}^{-1}$	d in μ .	N_2	N_4
0-10	2.75	53	106
0-30	0-92	159	317
0-60	0-46	317	635
0-90	0-31	476	952
1-20	0-23	635	1270
1-40	0-19	741	1481
1-60	0-17	847	1693

From this it can be seen that, as a rule, quite slight magnifications suffice to bring all representable details into observation. If the magnification is below the given numbers, the details can either not be seen at all, or only very indistinctly; on the contrary, the given magnification is increased, there will still be no more details visible. The table shows at the same time the great superiority of the immersion-system over the dry-system with reference to the resolving power. With the best immersion-system, having a numerical aperture of 1.6, details of the size 0.17μ can be resolved, while the theoretical maximum of the resolving power is 0.167μ , so that the theoretical maximum has almost been reached in practice. Still smaller particles cannot be portrayed by using ordinary dry-light.

In order to increase the resolving power, A. Köhler (*Zeit. f. Mikrosk.*, 1904, 21, pp. 129, 273) suggested employing ultra-violet light, of a wave-length 275 μ ; he thus increased the resolving power to about double that which is reached with day-light, of which the mean wave-length is 550 μ . Light of such short wave-length is, however, not visible, and therefore a photographic plate must be employed. Since glass does not transmit the ultra-violet light, quartz is used, but such lenses can only be spherically corrected and not chromatically. For this reason the objectives have been called monochromats, as they have only been corrected for light of one wave-length. Further, the different transparencies of the cells for the ultra-violet rays render it unnecessary to dye the preparations. Glycerin is chiefly used as immersion fluid. M. v. Rohr's monochromats are constructed with apertures up to 1.25. The smallest resolving detail with oblique lighting is $\delta = \lambda/2A$, where $\lambda = 275 \mu$. As the microscopist usually estimates the resolving power according to the aperture with ordinary day-light, Köhler introduced the "relative resolving power" for ultra-violet light. The power of the microscope is thus represented by presupposing day-light with a wave-length of 550 μ . Then the denominator of the fraction, the numerical aperture, must be correspondingly increased, in order to ascertain the real resolving power. In this way a monochromat for glycerin of a numerical aperture 1.25 gives a relative numerical aperture of 2.50.

If the magnification be greater than the resolving power demands, the observation is not only needlessly made more difficult, but the entrance pupil is diminished, and with it a very considerable decrease of clearness, for with an objective of a certain aperture the size of the exit pupil depends upon the magnification. The diameter of

the exit pupil of the microscope is about 0.04 in. with the magnification N_0 , and about 0.02 in. with the magnification N_1 . Moreover, with such exceptionally narrow pencils shadows are formed on the retina of the observer's eye, from the irregularities in the eye itself. These disturbances are called "entoptical phenomena." From the section *Regulation of the Rays* (above) it is seen that the resolving power is opposed to the depth of definition, which is measured by the reciprocal of the numerical aperture, $1/\lambda$.

Dark-field Illumination.—It is sometimes desirable to make minutest objects in a preparation specially visible. This can be done by cutting off the chief maximum and using only the diffracted spectra for producing the image.

At least two successive diffraction maxima must be admitted through the objective for there to be any image of the objects. With this device these particles appear bright against a dark background, and can be easily seen. The cutting off of the chief maximum can be effected by a suitable diaphragm in the back focal plane of the objective. But, owing to the various partial reflections which the illuminating cone of rays undergoes when traversing the surfaces of the lenses, a portion of the light comes again into the preparation, and into the eye of the observer, thus veiling the image. This defect can be avoided (after Abbe) if a small central portion of the back surface of the front lens be ground away and blackened; this portion should exactly catch the direct cone of rays, whilst the edges of the lens let the deflected cone of rays pass through (fig. 28).

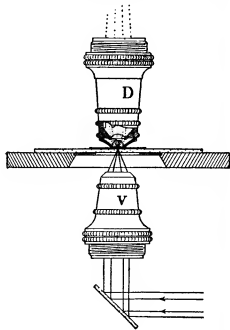

(By permission of C. Zeiss.)

FIG. 28.

The large loss of light, which is caused in dark-field illumination by the cutting off of the direct cone of rays, must be compensated by employing exceptionally strong sources. By dark-field illumination it is even possible to make such small details of objects perceptible as are below the limits of the resolving power. It is a similar phenomenon to that which arises when a ray of sunlight falls into a darkened room. The extremely small particles of dust (notes in a sunbeam) in the rays are made perceptible by the diffracted light, whilst by ordinary illumination they are invisible. The same observation can be made with the cone of rays of a reflector, and in the same way the fine rain-drops upon a dark background and the fixed stars in the sky become visible. It is not possible to recognize the exact form of the minute objects because their apparent size is much too small; only their presence is observable. In addition, the particles can only be recognized as separate objects if their apparent distance from one another is greater than the angular definition of sight.

Ultramicroscopy.—This method of illumination has been used by H. Siedentopf in his ultramicroscope. The image consists of a diffraction disk from whose form and size certain conclusions may be drawn as to the size and form of the object. It is impossible to get a representation as from an object. Very finely divided sub-microscopic particles in liquids or in transparent solids can be examined; and the method has proved exceptionally valuable in the investigation of colloidal solutions.

Siedentopf employed two illuminating arrangements. With the orthogonal arrangement for illuminating and observing the beam

of light traverses an extremely fine slit through a well-corrected system, whose optic axis is perpendicular to the axis of the microscope; the system reduces the dimensions of the beam to about 2 to 4 μ in the focal plane of the objective. For the microscopic observation it is the same as if a thin section of a thickness of 2 to 4 μ had been shown. In this optical way it is possible to show thin sections even in liquid preparations. The inconvenience of orthogonal illumination, which certainly gives better results, is avoided in the coaxial apparatus. Care must here be taken, by using suitable dark-field screens, that no direct rays enter the observing system. The only sources of light are sunlight or the electric arc. The limit at which sub-microscopic particles are made visible is dependent upon the specific intensity of the source of light. With sunlight particles can be made visible to a size of about 0.004 μ .

Production of the Image.—As shown in LENS and ABERRATION, for reproduction through a single lens with spherical surfaces, a combination of the rays is only possible for an extremely small angular aperture. The aberrations, both spherical and chromatic, increase very rapidly with the aperture. If it were not possible to recombine in one image-point the rays leaving the objective and derived from one object-point, i.e. to eliminate the spherical and chromatic aberrations, the large angular aperture of the objective, which is necessary for its resolving power, would be valueless. Owing to these aberrations, the fine structure, which in contrast to the large aperture could be resolved, could not be perceived. In other words, a sufficiently good and distinct image as the resolving power permits cannot be arrived at, until the elimination, or a sufficient diminution, of the spherical and chromatic aberrations has been brought about.

The objective and eyepiece have such different functions that as a rule it is not possible to correct the aberrations of one system by those of the other. Such a compensation is only possible for one single defect, as we shall see later. The demands made upon the eyepiece, which has to represent a relatively large field by narrow cones of rays, are not very considerable. It is therefore not very difficult to produce a usable eyepiece. On the other hand, the correction of the objective presents many difficulties.

We will now examine the conditions which must be fulfilled by an objective, and then how far these conditions have been realized.

Consider the aberrations which may arise from the representation by a system of wide aperture with monochromatic light, i.e. the spherical aberrations. The rays emitted from an axial object-point are not combined into one image-point by an ordinary biconvex lens of fixed aperture, but the central rays come to a more distant focus than the outer rays. The so-called "caustic" occupies a definite position in the image-space. The spherical aberrations, however, can be overcome, or at least so diminished that they are quite harmless, by forming appropriate combinations of lenses.

The aberration of rays in which the outer rays intersect the axis at a shorter distance than the central rays is known as "under-correction," the reverse is known as "over-correction." By selecting the radii of the surfaces and the kind of glass the under- or over-correction can be regulated. Thus it is possible to correct a system by combining a convex and a concave lens, if both have aberrations of the same amount but of opposite signs. In this case the power of the crown lens must preponderate so that the resulting lens is of the same sign, but of a little less power. Correction of the spherical aberration in strong systems with very large aperture can not be brought about by means of a single combination of two lenses, but several partial systems are necessary. Further, under-corrected systems must be combined with over-corrected ones. Another way of correcting this system is to alter the distances. If, by these methods, a point in the optic axis has been freed from aberration, it is possible to follow that a point at a very small distance from the optic axis can also be represented without spherical aberration. The representation, free from aberration, of a small surface-element, is only possible, as Abbe has shown, if the objective simultaneously fulfils the "sine-condition," i.e. if the ratio of the sine of the aperture u on the object-side to the sine of the corresponding aperture u' on the image-side is constant, i.e. if $n \sin u / \sin u' = C$, in which C is a constant. The sine-condition is in contrast to the tangent-condition, which must be regarded as the point-by-point representation of the whole object-space in the image-space (see LENS), and according therefore the equation $n \tan u / \tan u' = C$ must exist. These two conditions are only compatible when the representation is made with quite narrow pencils, and where the apertures are so small that the sines and tangents are of about the same value.

Very large apertures occur in strong microscope objectives, and hence the two conditions are not compatible. The sine-condition is, however, the most important as far as the microscopic representation is concerned, because it must be possible to represent a surface-element through the objective by wide cones of rays. The removal of the spherical aberration and the sine-condition can be accomplished only for two conjugate points. A well-corrected microscope objective with a wide aperture therefore can only represent, free from aberrations, one object-element situated on a definite spot on the axis. As soon as the object is moved a short distance away from this spot the representation is quite useless. Hence the importance of observing the length of the tube in strong systems. If the sine-condition is not fulfilled but the spherical aberrations in the

axis have been removed, then the image shown in fig. 19 results. The cones of rays issuing from a point situated only a little to the

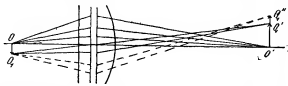

FIG. 29.—The lens is spherically corrected for O' , but the sine-condition is not fulfilled. Hence the different magnifications of a point O , beyond the axis.

side, which traverse different zones of the objective, have a different magnification. The sine-condition can therefore also be understood as follows: that all objective zones must have the same magnification for the plane-element.

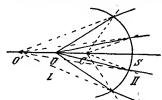

FIG. 30.— O' is the virtual image of O formed at a spherical surface of centre C and radius CS .

then there are two points on the axis where they can be reproduced free from error by monochromatic light, and these are called "aplanatic points." The first is the centre of the sphere. All rays issuing from this point pass unrefracted through the dividing surface; its image-point coincides with it. Besides this there is a second point on the axis, from which all issuing rays are so refracted at the surface of the sphere that, after the refraction, they appear to originate from one point—the image-point (see fig. 30). With this, the object-point O , and consequently the image-point O' also, will be at a quite definite distance from the centre. If however the object-point does not lie in the medium with the index n , but before it, and the medium is, for example, like a front lens, still limited by a plane surface, just in front of which is the object-point, then in traversing the plane surface spherical aberrations of the under-corrected type again arise, and must be removed. By homogeneous immersion the object-point can readily be reduced to an aplanatic point. By experiment Abbe proved that old, good microscope objectives, which by mere testing had become so corrected that they produced usable images, were not only free from spherical aberrations, but also fulfilled the sine-condition, and were therefore really aplanatic systems.

The second aberration which must be removed from microscope objectives are the chromatic. To diminish these a collective lens of crown-glass is combined with a dispersing lens of flint; in such a system the red and the blue rays intersect at a point (see ABERRATION). In systems employed for visual observation (to which class the microscope belongs) the red and blue rays, which include the physiologically most active part of the spectrum, are combined; but rays other than the two selected are not united in one point. The transverse sections of these cones of rays diverge more or less from the transverse section of the chosen blue and red cones, and produce a secondary spectrum in the image, and the images still appear to have a slightly coloured edge, mostly greenish-yellow or purple; in other words, a chromatic difference of the spherical aberrations arises (see fig. 31). This refers to systems with small apertures, but still more so to systems with large ones; chromatic aberrations are exceptionally increased by large apertures.

The new glasses produced at Schott's glass works, Jena, possessed in part optical qualities which differed considerably from those of the older kinds of glass. In the old crown and flint glass a high

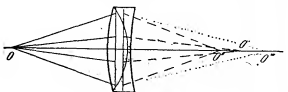

FIG. 31.—Showing a system with chromatic difference of spherical aberration. O'' = image of O for red light; O''' for blue. The system is under-corrected for red, and over-corrected for blue rays.

refractive index was always connected with a strong dispersion and the reverse. Schott succeeded, however, in producing glasses which with a comparatively low refraction have a high dispersion,

and with a high refraction a low dispersion. By using these glasses and employing minerals with special optical properties, it is possible to correct objectives so that three colours can be combined, leaving only a quite slight tertiary spectrum, and removing the spherical aberration for two colours. Abbe called such systems "apochromats." Good apochromats often have as many as twelve lenses, whilst systems of simpler construction are only achromatic, and are therefore called "achromats."

Even in apochromats it is not possible to entirely remove the chromatic difference of magnification, i.e. the images produced by the red rays are somewhat smaller than the images produced by the blue. A white object is represented with blue streaks and a black one with red streaks. This aberration can, however, be successfully controlled by a suitable eyepiece (see below).

A further aberration which can only be overcome with difficulty, and even then only partially, is the "curvature of the field," i.e. the points situated in the middle and at the edge of the plane object can not be seen clearly at the same focusing.

Historical Development.—The first real improvement in the microscope objective dates from 1830 when V. and C. Chevalier, at first after the designs of Selligie, produced objectives, consisting of several achromatic systems arranged one above the other. The systems could be used separately or in any combination. A second method for diminishing the spherical aberration was to alter the distances of the single systems, a method still used. Selligie had no particular comprehension of the problem, for his achromatic single systems were simply telescope objectives corrected for an infinitely distant point, and were placed so that the same surface was turned towards the object in the microscope objective as in the telescope objective; although contrary to the telescope, the distance of the object in the microscope objective is small in proportion to the distance of the image. It would have been more correct to have employed these objectives in a reverse position.

These circumstances were considered by Chevalier and Lister. Lister showed that a combination of lenses can be achromatic for only two points on the axis, and therefore that the single systems must be so arranged that the aplanatic (virtual) image-point O' (fig. 32) of the first system coincides with the object-point of the next system. This system will always be aplanatic. These objectives permitted a much larger aperture than a simple achromatic system. Although such systems have been made recently for special purposes, this construction was abandoned, and a more complex one adopted, which also made the production of better objectives possible; this is the principle of the compensation of the aberrations produced in the different parts of the objective. Even Lister, who proceeded on quite different lines, hinted at the possibility of such a compensation. This method makes it specially possible to overcome the chromatic and spherical aberrations of higher orders and to fulfil the sine-condition, and the chief merit of this improvement belongs to Amici. He had recognized that the good operation of a microscope objective depended essentially upon the size of the aperture, and he therefore endeavoured to produce systems with wide aperture and good correction. He used chiefly a highly curved plano-convex front lens, which has since always been employed in strong systems. Even if the object-point on the axis cannot be reproduced quite free from aberration through such a lens, because aberrations of the type of an under-correction have been produced by the first plane outer limiting surface, yet the defects with the strong refraction are relatively small and can be well compensated by other systems. Amici chiefly employed cemented pairs of lenses consisting of a plano-convex flint lens and a biconvex crown lens (fig. 33), and constructed objectives with an aperture of 135° . He also showed the influence of the cover-slip on pencils of such wide aperture. The lower surface of the slip causes under-correction on being traversed by the pencil, with over-correction when it leaves it; and since the aberration of the surface lying farthest from the object, i.e. those caused by the upper surface preponderate, an over-corrected cone of rays enters the objective. The over-correction increases when the glass is thickened. In order to counteract this aberration the whole objective must be correspondingly under-corrected. Objectives with definite under-correction can however only produce really good images with glass covers of a specified thickness. With apertures of 0.90-0.95 differences of even 0.004-0.008 in. in the glass covers can be noticed by the deterioration of the image. In systems with smaller apertures variations of the thickness of the glass cover are not so

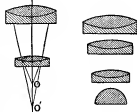

FIG. 32.



FIG. 33.

noticeable. For this reason Amici constructed objectives of a similar aperture and focus for different thicknesses of glass covers.

This expensive method was simplified in 1837 by Andrew Ross by making the upper and lower portion of the objective variable by means of a so-called correction-collar, and so giving the objective a corresponding under-correction according to the thickness of the glass cover. The alteration of the focus and the aperture are little influenced. The correction-collar was improved by Wenharm and Zeiss, by working the upper system upon the lower, and not the reverse; for in this way the preparation remains almost exactly focused during the operation (see fig. 34).

The injurious influence of the glass cover is substantially lessened if no air is admitted to the space between the glass cover and the



FIG. 34.—Objective fitted with correction collar (Zeiss).

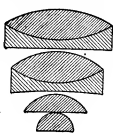

FIG. 35.—Achromatic objective for homogeneous immersion.

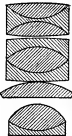

FIG. 36.—Apochromatic system.

front lens (as in the dry-system) but if the intervening space is filled with an immersion-liquid. Amici was likewise the first to produce practical and good immersion-systems. The slight difference of the refractive indexes of the glass cover and the immersion-liquid involves a diminution of the aberrations, by which the objective will become less sensitive to the differences in thickness of the glass covers and admits of a more perfect adjustment. Water-immersion was introduced by Amici in 1840, and was improved by E. Hartnack in 1855.

The advantages of the immersion over the dry-systems are greatest when the embedding-liquid, the glass cover, the immersion-liquid and the front lens have the same refractive index. Such systems with a so-called homogeneous immersion were first constructed after the plan of E. Abbe in 1878 in the Zeiss workshops at the instigation of J. W. Stephenson. Cedarwood oil (Canada balsam), which has a refractive index of 1.515, is the immersion-liquid. The structure of a modern system of this type, with a numerical aperture of 1.30, is shown in fig. 35.

The most perfect microscope objective was invented by E. Abbe in 1886 in the so-called apochromatic objective. In this, the secondary spectrum is so much lessened that for all practical purposes it is unnoticeable. In the apochromats the chromatic difference of the spherical aberrations is eliminated, for the spherical aberration is completely avoided for three colours. Since in these systems the sine-condition can be fulfilled for several colours, the quality of the images of points beyond the axis is better. There still remains a slight chromatic difference in magnification, for although the magnification consequent upon the fulfilment of the sine-condition is the same for all zones for one colour, it is impossible to avoid a change of the magnification with the colour. Abbe overcame this defect by using the so-called compensation ocular, made with Jena glasses. Fig. 36 shows an apochromat of a numerical aperture of 1.40.

THE EYEPiece OR OCULAR

The eyepiece is considerably simpler in its construction than the objective.

Its purpose in a microscope is by means of narrow cones of rays to represent at infinity the real magnified image which the objective produces. As, however, the object represents a real image, the problem is to project a transparent diapositive. It is therefore impossible to observe this image through an ordinary lens. Since many of the rays coming from the exit-pupil of the objective would not reach the eye of the observer at all, it is necessary, in order to make use of all of them, to direct the diverging rays forming the real image so that the whole of the light enters the eye of the observer. This is effected by a collective lens; it may be compared with the second part of the condenser system of a projecting lantern.

The two most customary eyepieces consist in two simple plano-convex lenses, whose distance one from the other is equal to half the sum of the two focal lengths. One of these is the Ramsden eyepiece (fig. 37). If the real image produced by the objective coincides with the collective lens, only the inclination of the principal rays is altered, the form of the cone being affected only to a very small extent. The lens nearer the eye, which has about the same focal length as the collective lens, is distant from it by about its focal

length. The eye-lens converts diverging pencils into parallels. Both lenses together form the exit-pupil of the objective behind the eye-lens, so that this image, the exit-pupil of the total system or the Ramsden circle, is accessible to the eye of the observer. It is possible to see the whole field through this pupil by slightly moving the head and eye. In practice the real image is formed not directly

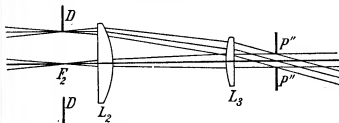

FIG. 37.—Ramsden Eyepiece.

L_1 = collective, L_3 = eye-lens.
DD = diaphragm of the field of view.
 $P''P''$ = Ramsden's circle, or exit-pupil of whole microscope.

on the collective lens but a little in front of it, because otherwise all the particles of dust on the collective would also be seen magnified.

In the other type, the Huygenian eyepiece (fig. 38), which is much more widely used, the collective lens is in front of the real image; it alters the direction of the principal rays and somewhat diminishes the real image. In this type the eye-lens is about twice as powerful as the collective lens, and makes the rays parallel. Here also the exit-pupil is accessible to the eye and through it the whole field can be seen by moving the head and eye. In both eyepieces micro-meters or cross-wires are used for measuring in the plane of the real

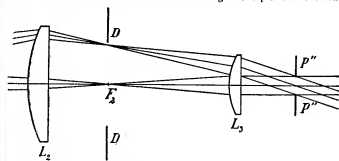

FIG. 38.—Huygenian Eyepiece.

L_2 = collective, L_3 = eye-lens.
DD = diaphragm of the field of view.
 $P''P''$ = Ramsden's circle, or exit-pupil of whole microscope.

image. The Ramsden eyepiece is the most convenient for this because this plane lies in front of the collective lens, and the objective image has not yet been influenced by the eyepiece. As both eyepieces are used with very small apertures (about $f:20$) no attempt has been made to overcome the spherical aberrations, which are usually very slight; neither, as a rule, are the eyepieces chromatically corrected, care has only to be taken by a suitable choice of the distance of one lens from the other, that the coloured images derived from a colourless object should have the same apparent size. Since, however, the difference of chromatic magnification cannot be overcome in powerful objectives, this error is still further increased by the eyepiece. The difference of chromatic magnification cannot even be overcome in apochromats, and to cancel this aberration Abbe devised the compensating ocular (fig. 39).

The weak compensation oculars resemble a Huygenian eyepiece with achromatic eye-lens, whilst the more powerful ones are of a different construction. These eyepieces are intentionally provided with a different chromatic magnification, which however is in opposition to that originating in the objective. They have also a shorter focus for red, and a longer one for blue, and thus magnify the red image more than the blue; and as the objective gives a large blue and a small red image, the two cancel one another and a colourless image is produced.

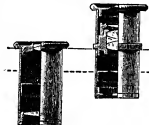

FIG. 39.—Compensating Eyepieces (Zeiss).

These eyepieces are very convenient in use, for when they are changed the lower focus always falls in about the same plane. In German and French microscopes the optical length of the tube, when apochromats and compensation-eyepieces are used, is 180 mm. By multiplying the magnification of the objective by the number

on the eyepiece the total magnification of the microscope is obtained. By the magnification of the objective is meant the ratio of the distance of distinct vision to the focal length of the objective. As powerful achromatic objectives show differences of chromatic magnification in the same way as apochromats, compensation eyepieces can be used in combination with these objectives.

ILLUMINATING SYSTEMS

Most microscopic observations are made with transmitted light; an illuminating arrangement is therefore necessary, and as the plane of the object is nearly always horizontal or only slightly inclined, the illuminating rays must be directed along the optical axis of the microscope.

To fully utilize the aperture of the system all dispersing rays in the object-space of the objective must be retained in the image-space of the illuminating system. When this occurs the greatest brightness will be obtained if the corresponding diaphragms of the two systems coincide; i.e. the field-diaphragm on the image-side of the observing system with object-side of the illuminating system, and the exit pupil of the illuminating system with the entrance-pupil of the objective.

For slight magnifications a revolving plane mirror fixed below the object for altering the direction of the rays suffices. For this mirror to illuminate all the points of the objective so that the rays fill up the objective, it must not be too small, and should be as near as possible to the stage plate, and the source of light must be considerably extended (fig. 40). Diffused daylight is very suitable. If the aperture of the objective is increased, the diameter of the illuminating surface must also be increased so that the system is quite filled up, from which it follows that this method of illuminating soon fails. The possibilities of illuminating with a concave mirror seem a little more favourable. As a rule a concave mirror of similar aperture is fitted on the other side of the plane mirror. With the concave mirror an image of the source of light can be thrown upon the object.

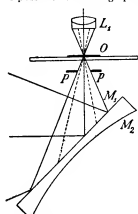

FIG. 40.—Mirror Illumination.

M_1 = plane-, M_2 = curved-mirror.
 O = object; L_1 = front lens of microscope;
 PP = diaphragm.

consequently is represented at infinity through the illuminating lens. By a correct choice of the focal length of the illuminating lens in relation to the focal length of the mirror, it is possible to choose the size of the image of the source of light so that the whole object-field is uniformly lighted.

Too much light is useless for observing delicately coloured or colourless preparations, whose parts only become visible as a result of slight differences of diffraction. Then it is necessary to use powerfully concentrated cones of light. The apparatus must be such that the apertures of the illuminating rays can be altered, e.g. by inserting diaphragms in the course of the rays of the illuminating cone below the stage plate (fig. 40, PP). This concentration is most easily produced by sliding or revolving diaphragms. A series of holes of different sizes perforate a revolving disk below the stage plate at an equal radial distance from the axis of the disk, so that the holes can be brought under the preparation in turn, the centre of the diaphragms always being a continuation of the optical axis of the microscope.



FIG. 41.—Cylinder Diaphragm (Zeiss).

The so-called cylinder diaphragms (fig. 41) are used especially in German microscopes. A changeable diaphragm is placed at the upper end of a short tube which can be moved in a case below the stage in the direction of the optical axis. By bringing the diaphragm nearer the object the aperture of the rays is increased; if the diaphragm is removed farther from the object the cone of rays is diminished (cf. fig. 40). These diaphragms are

sometimes fitted in a slide, so that it is possible to move the diaphragm sideways and give oblique illumination (see below).

With very powerful objectives these methods are insufficient; and a condenser is fitted below the stage plate. As a rule an iris diaphragm, which can be moved sideways, is now fitted below this condenser; below is the mirror which can be moved in all directions. The Abbe apparatus consists of a condenser, movable iris diaphragm, and mirror (fig. 42). The whole apparatus can be focused by a rack

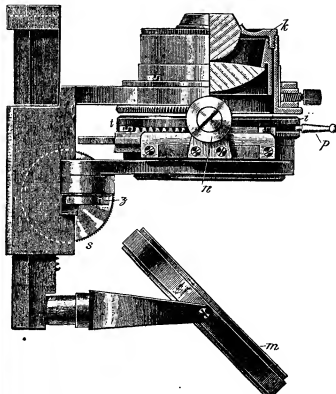

FIG. 42.—Abbe Illuminating Apparatus with Ordinary Condenser (Zeiss).

and the button s . The iris diaphragm can be regulated by the lever p ; it can also be turned to one side round the pivot z , so that the condenser k can be removed or changed. The correct direction can be given to the illuminating cone by the mirror m . It is often desirable to pass from direct to oblique lighting. The Abbe apparatus makes this easy. The iris diaphragm i is pushed to the side by the rack and pinion t . The chief cone of rays then enters obliquely into the objective, the angle between the direct cone of rays and the diffraction spectrum of the first order can then become as large again as with direct lighting, and still be taken up in the objective. Oblique lighting, however, can only be in an azimuth, so that the object must be turned in order that the details may be observed. Hence a condenser, for lighting with very oblique cones, must have about the same aperture as the objective, and therefore be of very wide aperture; they therefore closely resemble microscope objectives in construction. Especially powerful achromatic condensers are really only magnified microscope objectives, with the difference that they are not corrected for the thickness of the cover slip, but for the thickness of the glass on which the object is placed. For exceptionally accurate work microscope objectives are sometimes used as condenser systems. When using immersion objectives, an immersion condenser must also be used if rays of extreme obliquity are wanted, for, in consequence of the total reflections, rays can only come from the upper plane surface of the condenser, which have not a larger inclination to the axis than about 41° , varying according to the refractive index of the glass. In order to let highly inclined rays pass out from the condenser, some immersion liquid must be placed between the upper surface of the condenser and the object slide. Condensers are for this reason also constructed with apertures up to 1.40.

Vertical Illuminators.—Opaque objects can only be seen by reflected light. With low magnifying systems and a large free object distance, ordinary good daylight is sufficient. If the objects have a low reflecting power, or if a slightly higher magnification is needed, the lighting can be improved by optical system.

To examine small opaque objects with a high magnification the Lieberkühn mirror, so named after its inventor, was formerly much used. This was a concave mirror, pierced in the middle, fixed to the objective, and directed towards the object and with such a

focal length that rays parallel to the axis falling upon it were united exactly upon the object. In this case the object lay upon a stage plate, whose centre had so far been made opaque, so that the rays coming from the illuminating plane mirror could not reach the objective direct, but only the rays passing the stage plate to the side of this blackened portion reached the Lieberkühn mirror, and were used in lighting. The disadvantage of this method was that only small opaque objects could be examined. Much more easily manipulated is the parabolic side-illuminator invented by R. Beck, which can be conveniently fitted in and used for objectives with different focal lengths. It consists in half of a short focused parabolic mirror, which concentrates all the light coming from the one side on to the object. To examine objects with objectives of high power and low free object distance, the apparatus for side-illumination is not sufficient, and a so-called vertical illuminator is used. In Zeiss's form (fig. 43) a small prism P , which also revolves upon a horizontal axis, is placed as near as possible to the back lens of the objective. The edge which is the separating line of the horizontal and hypotenuse surfaces of the prism, lies approximately over the middle of the system, so that the rays entering through the opening in the side after having been reflected by the hypotenuse surface are concentrated through one half of the objective on to the object. When observing only the other half of the objective is used. The sources of light used should be arranged so that the objective throws an image of the light-source upon the object. It is best if the image of the light is not larger than the object examined, and to effect this, an illuminating lens with an iris diaphragm is often placed between the source of light and the illuminator. By suitable adjustment and by changing the iris diaphragm the size of the illuminating field can be controlled. The objects observed with the vertical illuminator must not have a glass cover if the dry system is employed, because the upper surface of the glass cover would send so much light back into the objective by reflection, that the image would be indistinct. It is, on the contrary, possible to examine covered objects with the vertical illuminator, if the immersion system be employed. Owing to the slight difference of illumination between the immersion liquid and the cover, the portion of light reflected on the cover is not noticeable.

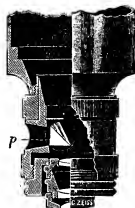

FIG. 43.—Vertical illuminator (Zeiss).

Dark Field Illumination.—As was seen when discussing the physical theory, the minute details of the object cause diffractions, and can only be examined if the objective can take up at least two consecutive diffraction spectra. These diffracting details become especially distinct if the direct lighting cone of rays, the spectrum of zero order or the chief maximum, is not allowed to enter the objective and instead only two or more diffraction maxima are taken up; the details then appear bright on a dark background. In dark field illumination care has to be taken that no direct rays reach the objective, and hence a good dark field illumination can be produced if the condenser system has a larger aperture than the objective. If an Abbe lighting apparatus is used a dark field diaphragm (fig. 44) can be placed in the iris diaphragm case. The central diaphragm disk keeps away all the light which would otherwise fall directly into the objective, and the open zones send so many oblique rays through the objective that they cannot all be taken up by the objective.

Exactly the same is reached when, as is shown in Fig. 45, a more powerful system D is used for the condenser which has a blackened section on the back of the front lens of such a size that no light can enter the objective A . In this way it is only possible for diffracted rays to enter the objective. Apparatus for a good dark field illumination has received much attention, because in this way ultra-microscopical particles can be made visible. This depends on the oblique combination of the entering cones of rays, which should be as oblique as possible; this is most easily done by mirror condensers. A number of early inventions have been revised for this purpose.

Wenhem's paraboloid illuminator (fig. 46) is made entirely of glass, and is in the form of a paraboloid, having on the top a spherical hole, of such a curvature that all entering rays, r, r', r'' , parallel to the axis, after their reflection on the surface of the paraboloid, traverse the spherical surface perpendicularly and unite in F , the centre of the sphere. A diaphragm s is placed in the middle of the spherical surface, and this keeps back the central rays. This diaphragm is sometimes fixed to a handle piercing the condenser, and which can be moved up and down, so that the aperture of the oblique entering cones of rays can be altered.

Another form of the paraboloid condenser, also due to Wenhem, has a plane placed on the upper side. Some immersion fluid must then be placed between the stage plate and the condenser in order to allow all the rays to pass out; otherwise only those rays would be able to pass out which are

close to the axis of the condenser in the inside of the condenser, and are smaller than the limiting angle of the total reflection.

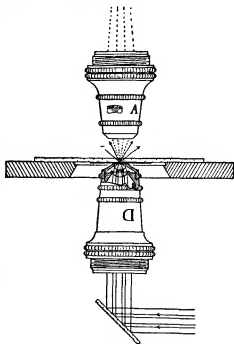

FIG. 45.—Path of Rays for dark ground illumination with fixed diaphragm in the objective.

(Objective D can also be used as a condenser (Zeiss).)

Th. Ross's "spot lens," invented in 1855, and J. W. Stephenson's catoptric illuminator (1879), may also be mentioned. A recent condenser of very high illuminating power is due to H. Siedentopf (fig. 47). It is a double mirror system, whose reflecting surfaces are a sphere a and a cardioid b . The combination of rays is also sufficient in practice if the cardioid surface is replaced by a spherical one.

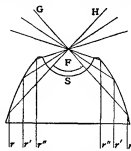

FIG. 46.—Wenhem's Paraboloid Condenser.

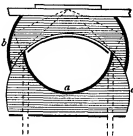

FIG. 47.—Siedentopf's Cardioid Condenser.

A supplementary spherical surface c is necessary for the completion of the condenser.

BINOCULAR INSTRUMENTS

The stereoscopic microscope is the most suitable for finding out the space taken up by the separate parts of a preparation. (See also BINOCULAR INSTRUMENTS and STEREOSCOPY.) The observer has a stereoscopic impression of an object, when different perspective representations are presented to both eyes, which, through the action of the central nerve system, resolve into one impression.

One way of receiving a stereoscopic impression through a microscope is by fixing an apparatus as directly, as possible above the last lens of the microscopic objective, which divides the rays passing out and directs half into each eyepiece. The half cones of rays have now semicircular sections, the diaphragms having the same form. The cones must be so directed through the divided system that the two exit pupils correspond to the interpupillary distance of the observer. The distance of the centres of the semicircular entrance pupils and their distance from the object regulates the difference of the two perspective representations, which are presented one to the right eye and one to the left. If the perspective centres lie too near one another in the object-space, as may happen with slightly opened and weak systems, the difference of the perspective is then too slight to make any real stereoscopic impression. On the other hand, a very much exaggerated stereoscopic effect can be derived from short focused

systems of wide aperture. On account of the slight depth definition, short focused systems of wide aperture are not at all specially suitable for stereoscopic observation, because the possibility of observing objects taking up a good deal of space is too limited when such systems are used.

Professor J. L. Riddell (*Quart. Journ. Micros.*, 1853, p. 236; 1854, pp. 18-24) published an arrangement of prisms, which, however, imparted a pseudomorphous impression if image-forming oculars

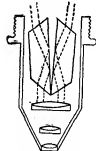

FIG. 48.—Riddell's Prisms.

were not used, and in 1854 a second system (fig. 48), essentially a Wheatstone pseudoscopic, added just above the objective. This gave an orthoscopic image even in ordinary eyepieces. By adopting right-angled reflection-prisms above the eyepiece he completely erected the image. Stephenson's stereoscopic microscope (fig. 58, Plate) resembles this apparatus in all essentials. A construction of prisms by Nachet is now almost forgotten, while on the contrary an extremely simple dividing prism published by Wenham (*Lond. Micros. Soc.*, 1861, i. 109) has been exceptionally well attested in practice. It is more easily used than any other apparatus. See BINOCULAR INSTRUMENTS, fig. 8). A reflection-prism (fig. 49) is placed above the last surface of the objective and divides the exit rays. The group of rays coming from the left half of the objective can continue its way without hindrance to the right eye. The group of rays coming from the right half of the objective is reflected twice in the prism and directed to the left eye. The tube containing the left eyepiece is a little inclined towards the right tube, which is perpendicular. It can be adapted to the interpupillary distance by changing the tube side. If it is desired to use the instrument as a monocular, the setting with the prism at the lower end of the tube is taken away.



FIG. 49.—Wenham's Prism.

A second manner of making stereoscopic observations employs stereoscopic eyepieces. The first of such eyepieces was proposed by R. B. Tolles.¹ He realized that the division of the cones of rays by prisms could only be satisfactorily performed if the prism was placed in the position of the exit pupil of the objective or in the position of the real image of this exit pupil. He employed a Nachet combination of prisms and placed the dividing prism at the spot where a special reversing system formed a real image of the exit pupil of the objective. A second stereoscopic eyepiece was devised by A. Prazmowski who substituted a Wenham diffracting division prism at the position of the real image of the exit pupil of the objective formed by a reversing system. The newest form of a stereoscopic microscope resembles the oldest in so far as two completely separate microscopes are used. In the oldest microscope by Cherubin d'Orleans the observer receives a pseudoscopic impression in consequence of the reversed image. This defect has been avoided in the instruments constructed in the Zeiss factory (fig. 59, Plate) at the instigation of the American zoologist H. S. Greenough. The system of Porro prisms employed affords a convenient method of adapting the ends of the eyepieces to the interpupillary distance. The two tubes are inclined to one another at an angle of about 14°. The microscope is only intended for slight magnifications. The possibility already suggested of using both eyes for observing without having a stereoscopic impression, is often regarded as a great advantage. Binocular microscopes have therefore been constructed on this plan. Such a combination of prisms was used by Wenham, who placed it directly behind the last objective lens. As a rule this arrangement of prisms can be exchanged for the Wenham stereoscopic reflection-prisms.

A second kind of dividing prism which directs the entire course of rays to both eyes, and thus produces identical images, was used by Powell and Lealand (fig. 50). Every ray is divided into a reflected and a refracted portion on the front side of a parallel plate. Whilst the refracted portion after leaving the plate continues its way in the same direction, displaced a little to one side, the reflected portion is directed into the side tube by a reflection-prism. With these microscopes, which are not stereoscopic, objectives of any power can be used. The surfaces of the dividing prisms must be very exact, so that no deterioration of the image may arise from them. A microscope for two eyes can also be obtained by employing the Abbe stereoscopic eyepiece.

By the supplementary use of one of Wenham's prisms every ray is analysed into a more powerful refracted and a weaker reflected one. The same image can be presented to each eye by using this eyepiece also. No stereoscopic impression is then felt. It is brought about by placing special semicircular diaphragms in the plane of the exit pupil of the microscope. By

¹R. B. Tolles, *Sill. Journ.* (1865), xxxix. 212; *Journ. Roy. Micr. Soc.* (1890), pt. i. p. 383.

turning the diaphragms 180° round the optical axis, the orthoscopic impression can be changed into the pseudoscopic. The mechanical arrangement of the eyepiece is such that the distance of the two exit pupils can be adjusted to the interpupillary distance.

MECHANICAL ARRANGEMENTS

Although the optical system is the first consideration in a microscope, the system is valueless if the fittings do not allow its correct use. The optical system must be kept at a certain distance and well centred, and a correct position for the object in relation to the system must be assured.

In fig. 60, Plate, the microscope is seen to consist of the heavy metal foot A, which rests on the table at three points. The whole microscope is fitted to this foot. The object can be held firmly on the stage plate B by cramps C. On the lower side of the stage plate are the condenser and the diaphragms, and the illuminating mirror J is held by a rod D fixed to the stage plate. Likewise on the stage plate is the support for the tube E. The rough adjustment of the microscope can be made by a rack and pinion F, and the fine adjustment by the screw G. The tube containing the eyepiece and the objective is double. The inner tube H is movable, making a change in the length of the tube possible. As a rule this inner tube has a mark which allows the length of the tube to be set.

It is most important the stand should be free of vibration. A fine adjustment is also necessary, in order to perform conveniently and with certainty the slight motion of the microscope in relation to the object. In cheap stands the rough adjustment was worked by moving the inner tube by hand, but the more convenient rack and pinion is now used almost exclusively.

For slight magnifications rough adjustment is sufficient, but with objectives of a focus below 1 in., a fine adjustment is wanted. Very different constructions are in use. Almost all are such that the whole microscope tube is raised or sunk by the mechanism of the fine adjustment, and not only the objective. The most used is the micrometer screw adjustment (fig. 51). The tube carrier B

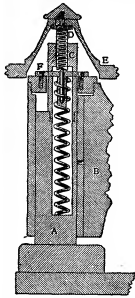

FIG. 51.—Micrometer Screw Adjustment of Leitz.

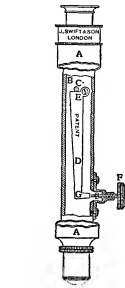

FIG. 52.—Lever Adjustment of J. Swift & Son.

fits closely on to a column A which is fixed firmly to the stage plate. The end of the column C is traversed by the micrometer screw D which is set in action by the knob E. The column A contains a powerful spiral spring, which exercises a strong pressure on the plate F fixed to the carrier B. By screwing in the micrometer, the spring is compressed and the tube lowered. By the contrary movement the spring pressure raises the tube as far as is allowed by the screw. The strong pressure of the spring practically excludes motion, which with fine adjustments is very important. Another very good adjustment is that of Messrs Swift & Son, shown in fig. 52. The long lever D is pressed to one side by the screw F, and is thus turned round the pin E. On the tube very near to the pin E is a cylinder C, which by the action of the screw F is very slightly raised or lowered. A double lever is used in a fine adjustment by Messrs Watson & Sons (fig. 53). According to whether the screw A or B is used, the adjustment is fine or coarse. In other fine adjustments by means of springs and balance wheels either a micrometer screw is moved (Zeiss), or a curved disk fixed to the balance wheel is turned (Leitz), or an oblique disk arranged more or less in a circle and attached to the balance wheel is revolved (Reichert). These modern adjustments are made so exact that motions can be easily measured

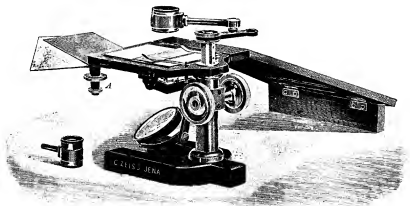

FIG. 57.—LARGE DISSECTING STAND (ZEISS).

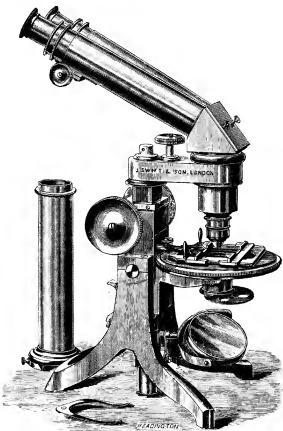

FIG. 58.—STEPHENSON'S BINOCULAR MICROSCOPE (SWIFT).

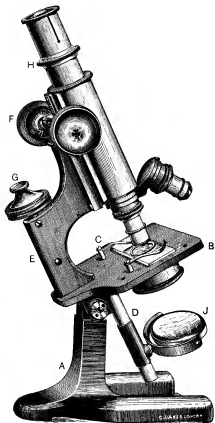

FIG. 60.—THE DEMONSTRATION MICROSCOPE (BAKER).

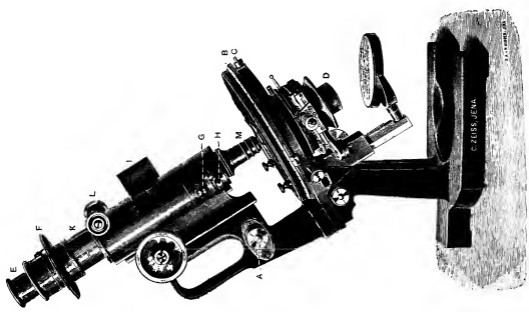

FIG. 61.—PETROGRAPHICAL MICROSCOPE (ZEISS).

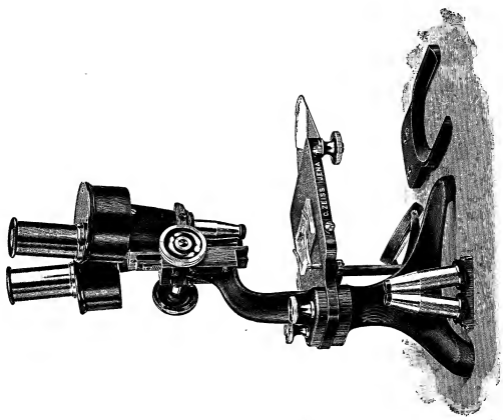

FIG. 59.—GREENOUGH'S BINOCULAR MICROSCOPE (ZEISS).

up to 0.002 mm. An essential in all rough and fine adjustments is that the motion must always

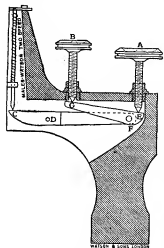

FIG. 53.—Double Lever Adjustment of Watson & Sons.

be parallel to the optical axis of the microscope, so that the same point in the object remains in the centre of the field.

Another condition which must be fulfilled by a good stand is the power of inclination. It is only rarely necessary to arrange the preparation really horizontal; and for easy observation, especially when it will take a long time, it is of great assistance if the microscope can be inclined, so that the observations can be made in a natural position. The apparatus for inclining the microscope is chiefly such that the microscope can be placed in all positions between the vertical and the horizontal. The horizontal position is sometimes necessary if photographs are to be taken by the microscope.

Many devices are available for changing the objective. It is essential that the objective is always brought before the lower end of the tube in such a way that the optic axis of the objective coincides with the optic axis of the rest of the system. The fittings of the objective and the changer are so arranged that little or no fine adjustment is necessary after the change. The most widely used is the revolving changer (fig. 60, Plate). The revolver may hold two, three or four objectives. In the sliding changer the objective is, dovetailed to a slide, the correct position being secured by clamps.

Fully equipped microscopes have apparatus for moving and turning the object. In simple microscopes the stage plate lies on the stand held by two springs, and must be moved by the hand (fig. 60, Plate). For elaborate work a so-called cross-table is indispensable. By means of screws the stage plate is movable in two directions at right angles to one another, in the plane of the stand. In many cases the stand is also movable round the optic axis.

The microscope stands described above can be used for the greater number of the naturalist's experiments. For very special objects the stand must be expressly made; thus stands with tube carriers very much projecting are made for examining sections of the brain. The petrographical microscope is shown in fig. 61, Plate.

In order to determine the refractive index when the thickness of the crystal is known, or the thickness of the crystal when the index is known, a fine adjustment A makes it possible to measure exactly the changes in the length of the microscope. Further, a revolving stage plate provided with a graduation B is used to determine the angle in crystals. To obviate mistakes the optical axis of the microscope must coincide with the revolving axis of the plate, and the revolving plate has a central position C to keep this condition fulfilled. In many stands the objective can be centred instead of the plate. For measuring this angle, an eyepiece with cross-threads is used. In the lower focal plane of the eyepiece, at the spot where the real image which the objective forms of the object arises, a glass plate is introduced on which are two fine cross lines or even two very thin threads. The eye-lens can be adjusted for the thread-plate, so that different observers can see the cross clearly. The cross is always adjusted first. When observing with such an eyepiece, care must be taken that the real image of the object lies in the plane of the cross-threads, i.e. that there is no parallax. The adjustment is easily controlled. If the eye is moved to and fro over the eyepiece and the image makes apparently similar movements in relation to the cross threads, then the image does not yet lie in the plane of the threads.

To measure the angle, the images of the crystal edges are covered in turn by one of the threads by turning the table, and the angle of rotation is read from the scale. A cross-table is very convenient for this calculation, for with the aid of the two movable slides situated in the plane of the plate and at right angles to one another, the point where the two crystal edges intersect can be quickly and correctly brought into the revolving axis of the plate. This measurement can also be made with a goniometer eyepiece, in which a row of parallel double-marks are used instead of the cross threads. The fitting of the eyepiece at the upper end of the tube is provided with a graduated circle. The eyepiece proper with the parallel strokes can be removed, and the rotation be read from the graduated circle. In revolving that calculation the marks of the thread-plate have only to be placed exactly parallel to the crystal edge.

For examining preparations in polarized light a polarizer D is introduced in the illuminating apparatus below the diaphragm and an analyser E above the eyepiece. The analyser can be rotated, the angle being read by a divided circle F. Very often the analyser is placed in the tube, a little above the objective: it is then generally in a case G, which can be put into the tube. The placing of the analyser near the objective has the advantage that the field of view

is not restricted, as is the case if the analyser is used above the eyepiece. Nicols's, Glan-Thomson prisms or similar polarization apparatus are used as polarizers and analysers. Below the analyser G a plate H of selenite or mica may be put in the course of the rays. This small plate can also be laid above the polarizer in the illuminating apparatus or in the eyepiece.

To examine crystals, especially in converging light, a condenser, movable in the optic axis, is needed above the polarizer. The image produced by the microscope objective M in its back focus plane is then observed through a supplementary microscope. The objective of this supplementary microscope, the Bertrand lens, can be applied through a window I at the lower end of the inner tube K. By using a rack and pinion movement L the supplementary microscope can be adjusted for the images. There is nearly always an arrangement to observe the preparation first in convergent light and then in parallel polarized light. This change can often be brought about by taking away or adding parts of the condenser.

MICROMETRY

It is often required in microscopical work to determine the size of objects or parts of objects.

There are three essential ways of performing this. The first method uses the objective screw micrometer. The object is placed on a slide in the plane of the stage plate and able to be very finely moved by the micrometer screw, which has as fine a worm as possible. A divided cylinder is fixed to the turning knob, which thus makes it possible to measure fractions of the revolution. The revolutions of the cylinder are registered by a calculator. The use of an eyepiece with a cross thread is essential to this measurement. After the microscope has been so adjusted that the image of the object to be measured falls exactly in the plane of the cross threads, the object is moved by the micrometer until one edge of the object is exactly covered by a thread. The micrometer is now read. Then the object is moved by the micrometer till the image of the other edge is covered by the thread in the eyepiece, and the micrometer is again read. The difference between the two positions gives the size of the object. The objective screw micrometer is, however, not sufficiently delicate, and is only used when comparatively large objects are to be measured, and especially for objects whose edges do not appear at the same time in the field of view.

The second and most widely used method employs a micrometer eyepiece. In this case not the object itself but a real image which has already been magnified by the objective is measured, and obviously much more accurate results are possible. The most accurate calculations are obtained by using the screw micrometer ocular (fig. 54). Directly below the collective lens of a Ramsden

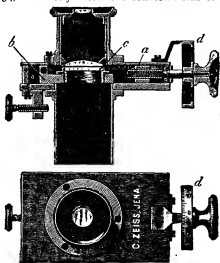

FIG. 54.—Screw Micrometer Ocular. Sectional elevation and plan (Zeiss).

eyepiece a slide *b* can be moved by a micrometer screw *a*; the slide carries a little glass plate *c* provided with a graduation. With the help of this scale the total revolutions of the screw can be read; fractions of the revolution can be read from the divided cylinder *d*. The scale is generally divided into hundredths of millimetres or thousandths of inches. A fixed mark which serves as an index is placed on the lower side of the collective lens and is seen clearly at the same time as the graduation of the movable slide. The micrometer stands at zero if the zero mark of the cylinder coincides with the index and the fixed mark is at a known division. The calculation is most convenient if the micrometer is left in the position of zero and the object is moved till one of its edges corresponds to the zero mark of the eyepiece scale. If the micrometer is then moved till another graduation corresponds to the other edge of the image the size of the image can be read off. As this method measures

the image correctly to a few thousandths of millimetres, the object itself is measured accurately to some hundred-thousandths of millimetres, if it has been magnified a hundred times by the objective. To keep up this degree of exactitude the magnification of the objective must be carefully ascertained, e.g. by using an objective micrometer. A fine scale with known intervals is put on the stage plate, and by determining the distance between the graduations of the objective micrometer formed through the same objective, by means of the screw micrometer ocular, the magnification of the objective is determined. As the errors in the graduation of the objective micrometer are also magnified, very exact scales are necessary. When determining the magnification the microscope must be used under exactly the same conditions: neither the length of the tube nor the focal length of the objective may be altered.

A fixed eyepiece micrometer is simpler and more popular. This consists of a scale on a little glass plate, which, instead of a cross wire, is placed in the eyepiece. The adjustment must be such that the image produced by the objective falls exactly in the plane of the scale. The size of the image is determined by calculating the entire interval taken up by it. By using an objective micrometer in place of the object, the magnification of the objective can be ascertained and from this the actual size of the object. As fractions of intervals can only be estimated in this method, a measurement with such an eyepiece scale can of course not be as exact as with a screw micrometer ocular. However, such a determination of size is often quite accurate enough.

A third method employs a drawing prism. The object and the drawing plane are seen at the same time and the outlines can be readily drawn. If, as before, an objective micrometer is placed below the microscope in the place of the object, and the size of a special micrometer-interval is drawn on the same board, then the actual size of the object can be ascertained. Instead of first drawing the object and the objective micrometer, they can of course be projected at the same moment on a scale on the drawing board.

The errors attending the determination of the size of a microscopic object depend chiefly on the accuracy of the objective micrometer; any errors in the micrometer being magnified by the objective. These may be diminished by using different parts of the objective micrometer for the correction of the eyepiece scale, and the calculation of the size is based on the found mean value. A second error can arise through the inaccuracy of the eyepiece micrometer, and also in the case of a screw micrometer through periodic faults of the screw, and through dead motion. The eyepiece micrometer allows its errors to be diminished, if one measures at different points and then takes a mean value. The dead motion of a micrometer screw is best avoided by working the screw away from one and the same side. The thickness of the cross wire may also occasion a fault. For this reason there is sometimes employed two very narrow threads lying beside one another, and which limit the image as nearly as possible.

THE TESTING OF THE MICROSCOPE

The excellence of a microscope objective depends on its definition and its resolving power.

The definition is better according as the chromatic and spherical aberrations are removed; there always remains in even the best constructions some slight aberration. In consequence of these residual aberrations, every object-point is not reproduced in an ideal image-point, but as a small circle of aberration. These circles will be objectionable when the smallest details are examined. The size of these circles depends, in the case of equal tube lengths, only on the type of the objective, and not on the focal length, exact execution being assumed. Object details will only be well seen if the aberration circles are small in comparison. The size of these details in the image depends only on the magnification of the objective, $M = \Delta/f_1$, and can by appropriate choice, to the right value. In the case of a suitable ocular magnification, the details will be well seen, while the aberration circles remain invisible. It is therefore possible to judge the excellence of the focusing of objectives on the strength of the ocular-magnification of the over-magnification, which they permit.

E. Abbe, through the so-called delicate ray transmission, suggested a way by which the quality of the images of objectives can be observed. The ray transmission, shown in fig. 55, is obtained by means of a stop placed under the condenser in the plane of the iris diaphragm. The entrance pupil is in this way rayed on two small separate fields, which nevertheless contain rays of all zones. It is necessary that the outside edge of the diaphragm

coincides with the edge of the entrance pupil. This can be attained by drawing the iris diaphragm so far as to form the entrance pupil. The double diaphragm is then in such a position that the edge of the outer diaphragm coincides with the edge of the iris diaphragm.

The object employed must have distinct boundaries. Abbe's test plate consists of an object carrier on which six cover glasses of exactly determined thickness (between 0.09 mm. and 0.24 mm.) are cemented. The cover glasses are silvered on their under surfaces, and in the silvering fine lines are drawn; these lines form the test object. This plate admits at the same time of a correct determination of the thickness of the cover glass, for which the best correction exists. So long as the object is not sharply focused two separate dispersion figures will be seen. The defects of the objective are revealed, e.g. two adjacent sharp images are formed, which become indistinct if they coincide, or one pencil produces a distinct, the other an indistinct image, or that the images are surrounded with coloured rings. Owing to the curvature of the image, all parts of the object are not seen distinctly at one and the same time.

The resolving power of an objective depends on its numerical aperture. The numerical aperture can be determined in two ways. A diaphragm with a very narrow hole is placed on the stage, and the microscope sharply focused on the edges of the hole. The illuminating mirror is turned aside and a graduated scale is laid on the foot of the microscope. Strong systems produce in the proximity of their back focal plane an image of the scale, which can be inspected with a weak auxiliary microscope, and the length of the visible part of the graduation determined. The ratio of half the length of the visible piece of the scale to its distance from the diaphragm on the stage gives the tangent of half the angular aperture. The sine of this angle is the numerical aperture for dry lenses. With weak systems no auxiliary microscope is necessary, the eyepiece being removed and the scale viewed directly in the tube.

E. Abbe constructed a simple instrument for the determination of the aperture, termed the apertometer (fig. 56). A semi-circular

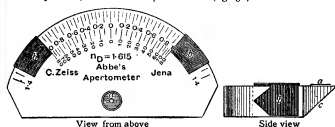

FIG. 56.—Abbe's Apertometer (Zeiss).

glass plate bears two scales, over which two black thin metal plates bent back at right angles may be moved. A little hole in the silvered plate marks the centre of this circle. Through this hole the points of the metal plates *b* can be observed by total reflection on the surface *c*. The apertometer is laid on the stage, so that the hole lies in the axis of the microscope, and the hole is sharply focused. The eyepiece being removed the image of the metal plates *b* produced by the objective is seen. In order to ensure for the eye a central position, there is fixed on the upper end of the tube in place of the eyepiece a disk of pasteboard or metal with an axial hole. The metal plates *b* are then moved till the points just cut off the edge of the field to be surveyed. The angular or numerical aperture can then be read off. With strong systems the vanishing of the points is observed with an auxiliary microscope, formed by means of the inner tube. In immersion systems the immersion liquid is placed between the front lens and the apertometer.

If the numerical aperture be known the resolving power is easily found. The resolving power can also be determined by using different fine test objects. Norbert's test plates, which bear graduated groups of extremely fine and narrow divisions are very useful, while the tests of *Amphipleura pellucida* and *Spirillum gemma* are often employed.

The magnification of a microscope is determined from the focal lengths of the two optical systems and the optical tube length, for $N = 250 \Delta/f_1/f_2$. To determine the optical tube length Δ , it is necessary to know the position of the focal planes of the objective and of the ocular. If one focuses an auxiliary microscope, carried in the inner tube, on the image situated in the back focal plane of the objective of a distant object, and then on the dust particles lying on a slide pressed against the end of the outer tube, the displacement of the auxiliary microscope gives the distance of the back focal plane of the objective from the end of the outer tube. To determine the position of the anterior focal plane of the eyepiece, the eyepiece is placed on the stage with the eye-lens downwards. An auxiliary microscope is now focused first on the image of a distant object and then on the plane of the edge of the setting. This plane can be marked by a small piece of paper. This gives the distance of the anterior focal plane of the eyepiece from the bottom edge of the setting of the eyepiece and consequently also of the edge of the eyepiece carried by the upper end of the tube. These measurements determine the optical tube length Δ .

There are many methods for determining the focal length of the objective. The objective to be examined is placed on the stage, and in the manner just shown, the distance of the focal plane from the edge of the fittings or to the surface plane of the front lens is determined. Any plane object a few yards distant can be used. If the object can be seen by using the mirror, the plane mirror must be used; then the actual size of the object and of the image produced by the objective is measured (of the image by a micrometer ocular). The distance of the object from the nearer focus of the objective is next determined. This distance is composed of the distance of the object from the centre of the plane mirror, and of the distance of the focus of the objective on the stage plate from the centre of the plane mirror. Let the size of the object be y , the distance of the image y' , the distance of the object from the focus x , then $y/y' = x/f_1$, from which f_1 can be calculated (see LENS). The same method can be used to determine the focal length of the eyepiece. These are the dimensions necessary for determining the magnification of the microscope, viz. the optical length of the tube Δ , the focal lengths of the objective f_1 , and of the eyepiece f_2 .

The focal length of an objective can be more simply determined by placing an objective micrometer on the stage and reproducing on a screen some yards away by the objective which is to be examined. If the size of the image of a known interval of the objective micrometer is determined by an ordinary scale, and the distance of the image from the focal plane of the objective belonging to it is measured, then the focal length can be calculated from the ratio $y/y' = f_1/x_1$, in which y is the size of the object, y' that of the image, and x_1 the distance of the image from the focal plane belonging to it.

Besides this indirect method of determining the magnification there is also a direct one, in which it is not necessary to first measure f_1 , f_2 or Δ . If a drawing prism is used above the eyepiece, and an objective micrometer is inserted, then if a scale is laid on the drawing board which is 25 cm. distant from the exit pupil, one or more intervals of the objective micrometer can be seen projected on the scale lying on the board. The comparison of the two scales gives directly the magnification. The course of the light within the drawing prism must be taken into account when determining the distance of the scale from the exit pupil. Although this method does not give very accurate results, it is more convenient and simple than the indirect method.

BIBLIOGRAPHY.—E. J. Spitta, *Microscopy* (2nd ed., 1909); Sir A. E. Wright, *Principles of Microscopy* (1906); W. B. Carpenter, *The Microscope and its Revelations* (8th ed. by W. H. Dallinger, 1901); J. Hogg, *The Microscope* (15th ed., 1898); H. van Heurck, *Die Microscope* (Eng. trans. by W. E. Baxter, 1893). W. Kaiser, *Technik des modernen Mikroskops* (Vienna, 1906), deals with the practical aspects, whilst the theory is treated in M. von Rohr (*Die Theorie der optischen Instrumente*, Berlin, 1904) and in S. Czapski (*Grundzüge der Theorie der optischen Instrumente*; ed. by O. Eppenstein, Leipzig, 1904).

MICROTOMY (Gr. *τομή*; *τέμνειν*, to cut), the term applied to the preparation of minute sections of organic tissue for the microscope. In 1875 the methods were yet in their infancy; their development has enabled observers to achieve the most exact study of minute anatomy, in the case of small objects, which without these methods could only be investigated by the unsatisfactory process of focusing with the microscope through the solid object.

It is not necessary here to detail at length the *wet method* of preparing sections. Briefly, the tissue is soaked in a solution of gum, or of gum and syrup, and after being frozen by ether spray, or by a mixture of ice and salt, is cut into sections either by the Rutherford, Cathcart or some similar section-cutter, or by apparatus which can be fitted to the more modern types of microtome referred to below. This method, which is to-day used mainly by pathologists, has two main disadvantages: the prolonged action of watery fluids on the tissues, and the impossibility of getting ribbons, each section having to be picked up separately.

The general processes of the *dry method* employed in zoological and botanical microtomy are, up to a certain point, practically identified with those used for the preservation of animals and their tissues for other branches of microscopic work. In the first place the tissues must be *killed*; in the second, they must be *fixed*, i.e. the protoplasm must be set or coagulated as far as possible in the condition in which it appears in life; and in the third, they must be *hardened*, i.e. in most cases dehydrated. Killing may be effected by asphyxiation or narcotization (nicotine, cocaine, chloral hydrate, &c.) in special cases, but is generally achieved by fixing reagents, of which corrosive sublimate and other chlorides, picric, acetic, osmic and chromic acids, alone or in combination, chromates and strong alcohol

are the most usual. These serve to a great extent also as hardening agents, but alcohol, used after them, completes this process effectively, and when not too strong (70%) is the best storage fluid. The second set of processes relates to the *staining*, without which transparent sections are almost invisible. The stains are divisible into *general* stains, which dye the tissue practically uniformly and indifferently; and *selective* stains, which have affinity for special tissues or cell elements. Of the latter group some fasten on nuclei, others only on the chromatin of the nuclei; some on connective tissues, others on muscle fibres and so on. It is probable that the action of all these selective stains is produced by definite chemical combination with compounds originally present in, generated in, or introduced into the tissue selected. The most generally useful stains for ordinary work belong either to the *cochineal* series (borax-carmin, carmalum, &c.), or to the *Jogwood* series (haematoxylin, haemalum, iron haematoxylin, &c.); in both of these great improvements have been introduced of late years by Dr Paul Mayer. The activity of these stains apparently depends upon the presence of alumina or of some similar base. For more special researches, such as cytology, neuropathology, neurohistology, and so forth, greater dependence is placed on the *coal-tar* colours, the name of which is legion. Some of these, such as safranin or gentian violet, are regressive stains; that is to say, the tissues are overstained uniformly, and the superfluous colouring matter washed out either by alcohol or by weak hydrochloric acid from the unselected parts. Others, such as methyl green, are progressive—that is, the colour is brought up to the pitch required and the reaction promptly stopped. The coal-tar stains can be used singly, or in combinations of two or three. Some of the best, unfortunately, are not permanent. A third group of stains is furnished by such reagents as silver nitrate, gold chloride, and the like (impregnation stains), which can be made not only to stain, but also to deposit a fine metallic precipitate on certain structures. In the case of small and delicate objects, the staining is done in the mass before any further preparation for sections, but with larger animals, or large pieces of resistant tissue, the stain is applied to the sections only. The processes so far mentioned are applicable to many branches of microscopic work.

When preparing tissues for sections the first step is complete dehydration, generally effected by bringing the object into absolute alcohol. It is then transferred to one of a group of reagents, which are miscible with absolute alcohol, but would form an emulsion with water, and are solvents of the embedding medium. The embedding mass in most general use is paraffin wax, melting at a temperature of 54° to 60° C., according to the character of the object and the thickness of section required. The object is transferred from absolute alcohol to benzol, chloroform, cedar oil, or similar fluid to the melted paraffin; the fluid diffuses and evaporates, leaving the tissues to be completely permeated by the paraffin. This process can be greatly hastened by the use of a partial vacuum. When impregnation is complete the paraffin is cooled rapidly, so as to assume a homogeneous non-crystalline condition, and the tissue thus comes to form part of a block of soft but tenacious material, which protects it from damage by air or damp, and can be readily cut by a razor. The block is then trimmed to the form of a triangle or rectangle, and fixed by a clamp or by local melting in the holder of the microtome.

The first automatic microtome suitable for cutting a block of tissue into a continuous series of sections was made in 1883 in the university workshops of Cambridge, from a design by W. H. Caldwell and R. Threlfall. Only a single machine was made, but in 1884 twelve machines were made by the Cambridge Scientific Instrument Company from a design by Caldwell. Since then numerous excellent and simpler forms of microtome have been evolved. Some of these have distinct advantages over others, but with microtomes as with other tools—the success of the results depends very largely on the manipulator, for every one works best with his accustomed instrument. In one type of microtome the razor is attached at one end only to a heavy

block, sliding backwards and forwards in a horizontal V-groove; the paraffin block is fed to this either up a vertical guide (Schanze, Reichert, &c.) or up an inclined plane (Thoma-Jung). In another type the razor is firmly clamped at both ends, to diminish vibration, and the paraffin block advances to it at the end of a long lever on trunnion bearings (Cambridge rocker) or up a vertical guide (Minot types).

In the selection of a microtome, apart from its steadiness, rigidity, accuracy of workmanship, and so forth, it must be borne in mind that, in general, simplicity of working parts means longer life, and that an elaborate "automatic" mechanism, by which a single movement is translated into several in different directions, not only complicates the machine, but robs the operator of those alterations of pace, rigidity, pressure, &c., which are often necessitated by the varying texture in different parts of the object cut. For general use by less skilful students in a laboratory, price, simplicity and rapidity of work recommend the rocking microtome of the Cambridge Scientific Instrument Company, but it tends to fail at large or hard objects. For the all-round work of an investigator, its simplicity and finish have made Jung's sliding microtome with the Naples improvements deservedly popular for many years; it can be fitted with special apparatus for cutting celloidin and frozen objects, and it can be relied upon to cut any tissue, however difficult; but it cannot be worked as rapidly as some others, nor produce long ribbons of large objects. For this latter purpose the Minot-Becker, Minot-Zimmermann and Reinhold-Gilltlay have been strongly recommended; these, however, are all of more complicated construction, with corresponding liability to uneven wear and damage; they are highly "automatic," leaving nothing but pace under control of the operator, and they are (particularly the last) expensive.

In 1910 the Cambridge Scientific Instrument Company issued a new microtome designed primarily for cutting larger sections than was possible in their earlier forms, which respectively dealt with sections 12x20 mm. and 30 mm. in diameter; the new instrument cuts sections measuring 150x120 mm. (6x4½ in.) embedded in paraffin or celloidin and of a thickness varying from 0.002 to 0.06 mm., each division of the scale being equal to 0.002 mm. and the total distance of automatic feed being 21 mm. The construction and action of the instrument can be understood by referring to the figure; a detailed description is given, since the same principles are utilized to a greater or less extent in all sliding microtomes.

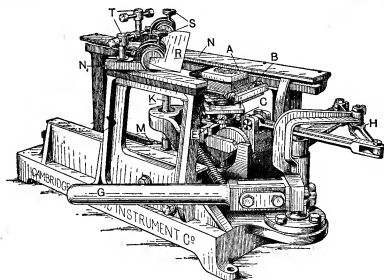

Large Sliding Microtome.

The object to be cut, having been embedded in a suitable preparation A, is fixed to a wooden block which is attached by clamps to the object-holder B. The object-holder is provided with mechanism by means of which the height of the block is set; this is effected by mounting the holder in a cup-shaped socket at the extremity of a brass pillar E, which can be raised or lowered and fixed in any position by a clamp. In addition, the direction in which a section is cut can be varied by adjusting the four screws,

one of which is shown at C, which orientate the block. The object-holder and feeding mechanism are carried on a sliding carriage which rests at three points on two guides in the frame N, N₁ of the instrument; and in order to secure easy running the necessary lubrication of the bearing surfaces is provided for by a groove in which oil is placed. The motion of the carriage in either direction is effected by the handle G, connected to a system of levers H, which, being constructed on geometrical principles, prevent any side-play and ensure a uniform motion. The arrangement for determining the thickness of the section cut consists of a stop-pin, which, operating through the ratchet M, causes a toothed wheel to revolve, which in turn raises the pillar K; the amount of the motion can be read off by an index. On the return stroke of the sliding carriage the stop-pin is again actuated in such a manner that just before the knife R reaches the object-holder the mechanism depresses this part of the instrument so that the knife is not fouled; and after its passage the object-holder is raised to the position appropriate for taking the next section. The knife R is rigidly set in two heavy brass clamps adjustable by the screws S, and these clamps are attached to the frame of the instrument by the screws T. The angle which the cutting edge makes with the frame is also adjustable, and by means of a small angular scale engraved on the knife-holders any setting can be easily determined or repeated. The knife is flat on one side and hollow-ground on the other. In using the microtome it is essential that the cutting edge of the knife points towards the end of the instrument where the handle is placed; the hollow-ground face should be uppermost, and the flat surface should not be exactly horizontal but slightly inclined so that the lower facet of the cutting edge parallels the frame. As to the relation of the position of the knife to the direction of motion, it is the usual practice, when paraffin sections are to be taken, to have the cutting edge at right angles to the motion; when, on the other hand, celloidin preparations are being cut, the knife must be set obliquely across the frame, an angle of 30° being convenient. This oblique setting is also recommended for paraffin sections. In addition it must be remembered that celloidin preparations always require lubricating when being cut, and it is also necessary to keep both the knife and the preparation constantly moistened with either 80% alcohol or with cedar-wood oil.]

The sections, when cut by the microtome with the knife straight and the two sides of the rectangular paraffin block parallel to it, in most cases can be got off in a continuous ribbon, each sticking to its predecessor. This very desirable result generally can be insured by a coating of softer paraffin; but if the object be large, or brittle, or of varying texture, it is safer to cut the sections singly from a triangular block with an oblique knife. The sections or ribbon are often not quite flat, but rolled, creased or compressed; they must be flattened before being attached to the slide. It is possible to carry out these two processes simultaneously by covering the carefully cleaned slide with plenty of a very dilute solution of Mayer's glycerine and albumen, and laying the sections on the fluid and the slide on a hot-plate; as the water becomes warm the sections flatten out, and as it evaporates they settle down on the slide, and are held there by the albumen (many other methods are in use). The slide is then warmed to melt the paraffin, and plunged into benzol, or some similar fluid, which removes the paraffin; thence into absolute alcohol, which dehydrates and coagulates the albumen. If the tissue has not been stained *en bloc* the sections can now be stained on the slide. After staining they are fully dehydrated, rendered transparent by oil of cloves, and mounted in xylol-dammar or Canada balsam. W. Giesbrecht was the first to fix sections on the slide, using a solution of shellac in creosote in 1881; and also in the same year and in the laboratory of the Naples aquarium, W. H. Caldwell first cut and fixed ribbons of sections.

For ordinary work the paraffin method excels all others for rapidity, certainty and cleanliness; but for large and hard objects, or crumbling tissues (such as ova with a large quantity of yolk), some manipulators prefer to embed in celloidin. By this method, after dehydration, the tissue is soaked in a mixture of absolute alcohol and ether; thence transferred either to increasingly strong solutions of celloidin in the same mixture or to a thin solution which is then boiled down till strong. The celloidin mass is then hardened: at first, if necessary, by drying; afterwards by a bath of chloroform or its vapour. It can then be cut in the microtome, either wet, or (if

previously cleaned with cedar oil) dry like a paraffin block. The method is more tedious and more messy than the paraffin process; but amongst its advantages must be reckoned that little or no heat is required, and that the embedding mass is transparent, though it does not allow of such thin sections as paraffin.

The above accounts present an outline of the complex processes employed to-day, by which, on the one hand, sections 30 μ in thickness may be made through the entire human brain; and, on the other, organisms invisible to the naked eye may be cut into a long ribbon of consecutive sections 1 μ (one-thousandth of a millimetre) thick, every minutest fragment being retained in its proper place.

The standard book on the subject is Bolles Lee's *Microtomist's vade-mecum*. Other works are G. Mann, *Methods and Theory of Physiological Histology* (Oxford, 1902), and A. Flatters, *Methods in Microscopical Research* (London, 1905). (C. H. Fox.)

MIDAS, the name of several Phrygian kings. The first of these was said to have been the son of Gordius and Cybele, whose first priest he was, and in whose honour he founded a temple at Pessinus. Having taken the drunken Silenus back to his youthful charge Dionysus, he was rewarded by the god with the power of transforming everything he touched into gold. Finding himself in danger of starvation, even his food and drink being changed by his touch, Midas entreated Dionysus to take back the gift. By the command of the god he bathed in the river Pactolus, which henceforth became auriferous (Ovid, *Metam.* xi. 85-145; Hyginus, *Fab.* 191). Another story connects him with the musical contest between Apollo and Marsyas (or Pan). Having decided against the god, his ears were changed into those of an ass. He concealed them under a Phrygian cap; but the secret was discovered by his barber, who, being unable to keep it, dug a hole in the ground and whispered into it "Midas has the ears of an ass." He then filled up the hole, thinking his secret safe; but the reeds which grew up over the spot proclaimed it to all the world. Midas with the ass's ears was a frequent subject of the Attic satyr-drama. There is no doubt that Midas was the name of one or more real persons around whom religious legends have grown up. The name "Midas the king" occurs on a very ancient tomb in the valley of the Sangarius, the legendary seat of the Phrygian kingdom. The Phrygian monarchy was destroyed by the Cimærians about 670 B.C., and the name Midas became in Greek tradition the representative of this ancient dynasty.

On the connexion between Midas and the Attic story see J. G. Frazer, *The Golden Bough*, ii. 134.

MIDDELBURG, the ancient capital of the province of Zeeland, Holland, in the middle of the island of Walcheren, 4 m. by rail N. by E. of Flushing, with which it is also connected by steam tramway and by ship canal (1873), which continues to Veere on the N.E. coast, with a branch eastward to Arnemuiden. Pop. (1903), 19,002. Middelburg contains many splendid old houses, which recall the prosperity which distinguished it until the end of the 18th century. The beautiful town-hall, built by Anton Keldermans about 1512, with a square tower 180 ft. high, and a façade adorned with statues of the counts and countesses of Zeeland and Holland, contains the valuable city archives and antiquarian and historical collections. The old abbey of St Nicholas, founded in 1150, and now occupied by the provincial council, has some fine old tapestry of the end of the 16th century. The building was added to in the 14th and 15th centuries, and partly rebuilt after a fire in 1492. It was the scene in 1503 of a meeting of the knights of the Golden Fleece, and was frequently the residence of royal visitors, including Maximilian, Philip the Fair and Charles V. The abbot of Middelburg formerly possessed a vote of his own in the Provincial States. What was formerly the nave of the abbey church is now the New Church, and the ancient choir constitutes the Choir Church. These churches are interesting for the monuments of William II., count of Holland, king of the Romans (d. 1256), the 16th century scholar Hadrian Junius, and Jan Pieterszoon; and the tombs of Jan and Cornelius Evertsen, who fell in the naval war against England in 1666. The high tower (280 ft.), known as *de lange Jan*, standing apart from the church

contains a good chime of bells. The corn exchange, the hof St Joris and the hof St Sebastian (formerly buildings belonging to the guilds of archers, and now places of amusement) also deserve mention. The museum of antiquities belonging to the Zeeland Society of Arts and Sciences (founded at Flushing in 1769, and transferred to Middelburg in 1801) contains a complete collection of the fauna and flora of the province, many maps, plans and drawings relating to Zeeland, the first telescope made by Hans Lippershey and Zacharias Jansen in Middelburg in 1608, and some provincial Roman antiquities.

The extensive trade which Middelburg formerly carried on with the East and West Indies and with England and Flanders, was ruined by the war with England and the French occupation. But the construction of the railway in 1872, followed by the opening of the ship canal and the large dock (1876), as well as the establishment, by the aid of the chamber of commerce, of certain manufacturing industries (iron, machinery, furniture, oil and cigars), lifted it out of its isolation.

MIDDELBURG, a town of the Transvaal, 98 m. E. by rail of Pretoria, and 251 m. W. of Lourenço Marques. Pop. (1904), 5085—of whom 2343 were whites. It is prettily situated on the high veld, 5090 ft. above the sea, on one of the head streams of the Olifants River. Middelburg is the chief town of an administrative division of the same name, and is a trading centre for a large district. It is also the centre of one of the richest coal-fields in South Africa. From some of the adjacent collieries excellent steam coal is obtained. Copper and cobalt are found in the neighbourhood.

Middelburg was chosen in 1901 as the place of conference for peace negotiations between the British and the Boers. After the occupation of Pretoria in June 1900 by Lord Roberts the Boer forces had been reduced to guerilla warfare, and Lord Kitchener, learning that the Transvaal commandants were despondent, invited General Botha to enter into negotiations, on the basis of the recognition of British sovereignty. The conference between Lord Kitchener and General Botha was opened on the 28th of February and the negotiations, which ended in failure, were protracted until the 16th of March (see *TRANSVAAL: History*, § *The War of 1899-1902*).

Middelburg is also the name of a town in the Cape Province, South Africa, 250 m. N. by W. of Port Elizabeth. Pop. (1904), 6137.

MIDDLE AGES, THE. This name is commonly given to that period of European history which lies between what are known as ancient and modern times, and which has generally been considered as extending from about the middle of the 5th to about the middle of the 15th centuries. The two dates adopted in old textbooks were 476 and 1453, from the setting aside of the last emperor in the West until the fall of Constantinople. In reality it is impossible to assign any exact dates for the opening and close of such a period. The trend of recent historical research leads one even to doubt the validity of the very conception of any definite medieval period. The evolution of modern European society has been continuous. Progress has not been uniform. There was much retrogression with the intrusion of new barbarian races; but from their absorption by the 10th century until the 20th there is not a century in which some notable gain was not made towards the attainments of modern civilization. The correct perspective places between the summits of modern and ancient times, not a long level stretch of a thousand years, with mankind stationary, spell-bound under the authority of the Church, absorbed in war or monastic dreams, but a downward and then a long upward slope, on both of which the forces which make for civilization may be seen at work.

It is clear that a survey of the history of these so-called middle ages—long use makes the term inevitable—must include not only the political phase, but also economics, religion, law, science, literature, &c., since all are involved in the concept. A hurried outline of each of these vital branches of our civilization will at once reveal the falseness of the usual periodizing. It is only after having traced these one by one that we can properly review the process as a whole.

In political history, the epochal fact which marks the close of ancient times is the decline of the Roman Empire. This was a process extending over three or four centuries, in which no one date lends itself to the historian. The deposition of Romulus Augustulus, the last Roman emperor in the West, in 476, was certainly not one of those events upon which the history of the Western world depends. Outwardly it did not mark the end of the Empire, but the restoration of imperial unity. The throne in Italy had been vacant before, and the restoration of unity was realized in fact under Justinian. There is no reason why the date 476 should stand out in European history more strongly than half a dozen other such dates. Yet we may say that the 5th century did witness the actual dismemberment of the Roman Empire. The new nations in Spain, Gaul, parts of Italy and Britain were forming the rude beginnings of what were to become national states in the centuries following. Western Europe was taken out of the imperial mould and broken up. This is a revolution of sufficient magnitude to be regarded as politically the opening of a new era. It had been long preparing in the economic and administrative decline of the Empire, and in the steady influx of Germanic peoples into Roman territory for over two centuries; but the power of the old civilization to absorb the new races was exhausted by the 5th century, and the political history of Europe was turned into a different path. That path, however, was not destined to end blindly in a "middle age." The line of political development marked out in the 5th century—that of the national state—still continues. The revolution in which Alaric, Theodoric and Clovis figured did not set the problem for the middle ages only, as is frequently stated; its full meaning did not appear until the Peninsular War, the Prussia of Stein and Scharnhorst, and even Solferino and Sedan. Thus the 5th century politically introduces not so much the history of the middle ages as that of modern Europe.

The immediate introduction, however, was a long one—so long and so distinct from the later development as to constitute in itself a distinct phase. For five or six centuries—from the 5th until about the 11th—comparatively little permanent progress was made. The Germanic tribes were still adjusting themselves and slowly learning to combine their primitive institutions with the remains of those of Rome; the premature union under Charlemagne gave way before new invasions, and anarchy became crystallized in feudalism. It was not until the 12th and 13th centuries that modern national states really took shape: England with its trial by jury, circuit courts, Magna Charta and parliament; France under the strong hand of the Capetians. A political middle age certainly lay between Theodosius and William the Conqueror, or at least between Justinian and Henry II. It is difficult to grasp its vastness. Few students of history realize that the period from the Saxon to the Norman Conquest of England would take us as far back as from George V. to Edward I.; or that from Theodosius to Philip Augustus there is an interval equal to that between the accession of Hugh Capet and the French Revolution.

This, however, is not the period most frequently termed the middle ages in political histories. It does not include those two institutions which more than any others stand in popular imagination as genuinely medieval—the papal monarchy and the Holy Roman Empire. The papacy received its full monarchical structure under Hildebrand (Gregory VII.) in the middle of the 11th century; its political decline set in suddenly after the pontificate of Boniface VIII. at the opening of the 14th. The great age of the Empire began slightly earlier, and continued until the fall of the Hohenstaufen in the middle of the 13th century. One cannot now deny the term middle ages to the period of these two institutions. It has been consecrated to this use too long. Yet when we include under a common name two eras so distinct as this and that preceding, our term becomes so vague as to be almost valueless. Moreover, it is doubtful if this second period is really as "medieval" as it has seemed. Papal monarchy and Holy Roman Empire were not the only political phenomena of their age, and it is possible that their vast pretensions have somewhat blinded historians as to their real

importance. While they were struggling to enforce their claims to universal sovereignty, the royal power, less extravagant but more real, was welding together the feudal states of France and moulding the England of to-day. Compared with this obscure process—this spread of the king's peace along the highways and through the distant forest lands of the 12th and 13th centuries—papal interdicts and jubilees, however impressive their spectacle, are but fleeting shows. The chivalry of Germany pouring through Alpine passes for an Italian campaign, or a coronation, left little trace in history except the lesson of their futility. There is much in the imperial and papal histories that is merely spectacular and romantic; much that appeals to the imagination and lends itself to myth; and since the sources are abundant—the papal archives inexhaustible and the German chronicles easily accessible—an undue emphasis has been placed upon them. It is at least evident that the political middle ages were already disintegrating during the period of papal monarchy and Holy Roman Empire.

In economic history there is a more definite line traceable. The one great economic change brought about by the decline of the Roman Empire was the lessening of urban life throughout the greater part of Europe, the closing up of avenues of communication and the predominance of isolated agricultural communities. This phase began to give way in the 11th century to a commercial and industrial renaissance, which received a great impetus from the crusading movements—themselves largely economic—and by the 14th century had made the Netherlands the factory of Europe, the Rhine a vast artery of trade, and north Italy a hive of busy cities. The discovery of America and the expansion of commerce merely readjusted conditions already highly developed. The period of isolated economy which we may term medieval lasted only from about the 5th to the 12th centuries. As for manufactures, the antique methods survived until the 18th and 19th centuries.

In religious history—to be distinguished from that of the political organization referred to above as the papal monarchy—the official recognition of the Christian Church by Galerius in 311 serves as a convenient starting-point for what we know as universal Christendom, though the slow disappearance of paganism, as distinct from Christianity, stretches over at least a century more. The Reformation of the 16th century has long been regarded as the close of the period. The real close, however, is the present day—as the result of the rationalism and science of the 18th and 19th centuries. The heroes of the Reformation, judged by modern standards, were reactionaries. Unconsciously and to its own ultimate damage the Reformation forged the weapons of progress; but it was itself in no sense, except the institutional and political, the end of that religious history inaugurated before the Council of Nicea. The real change in attitude which marks the dawn of a new era came in the generation of Voltaire. And "medievalism" is only now on the defence against "modernism," both Catholic and Protestant.

In legal history there was a distinct medieval period, when Germanic customs superseded Roman law, that most splendid of Rome's legacies. But the renaissance of law began relatively early; by the 12th century it had created a university, by the 13th it was helping to organize national states and laying the basis for that order which the economic renaissance was already demanding.

In science there was no great product in antiquity to be lost. Compared with art or law, literature or philosophy, ancient science (in our sense) was almost insignificant. The promise in Aristotle of such production remained unfulfilled. The 17th century is not so much a renaissance here as a mere beginning. No one can deny the general unscientific, uncritical nature of "medieval" thought. A single Roger Bacon does not relieve his age of the charge. But the middle age in science must include much of antiquity, including Pliny.

Philosophy was the one subject which had, clearly and definitely, a medieval period. Scholasticism, which absorbed the attention of most thinkers from about the 11th to about the

15th centuries, is so easily marked off and played so considerable a rôle in the academic history of that time, that historians often refer to it as the only intellectual interest of "medieval" men. Then, selecting some of the later and less virile scholastics as victims, they ask how men could be seriously interested in their trivialities. But these men were not all busy over the problem of how many angels could stand on a needle-point; nor were they all dominated by the religious spirit of faith or intellectual cowardice. They were searching for truth with scientific eagerness. Their very failure made possible the modern era. It is perhaps unnecessary to point out how small a proportion of the "intellectuals" were scholastics even in the 13th century.

In the realm of art the "middle ages" had already set in before Constantine robbed the arch of Titus to decorate his own, and before those museums of antiquity, the temples, were plundered by Christian mobs. The victory of Christianity—iconoclastic in its primitive spirit—was but a single chapter in the story of decline. The process was completed by the misery of the decaying empire, and by the Germanic invasions. The barbarians, however, destroyed less than has been commonly supposed. Destruction was more the product of necessity than of wantonness. Thus public monuments became fortresses, and antique sculpture was built into city walls. Such art as continued was almost wholly religious; for in the wilderness of the times the churches formed oases of comparative prosperity and peace, and, even in the darkest times, wherever such oases existed there the seeds of art took root. The Church architecture of the "middle ages," then developed naturally and without a break, through the Byzantine and Romanesque styles, out of the secular and religious architecture of Greece and Rome. And, with the return of comparatively settled and prosperous conditions, not only architecture but the other arts also blossomed under the influence of what was later stigmatized as the "Gothic" spirit into new and original forms. Down to the Reformation the churches continued to be, as the temples of the ancient world had been, the main centres of the arts; yet the arts were not confined to them, but flourished wherever, as in castles or walled cities, the conditions essential to their development existed. With the revival of civilized conditions in secular life, secular ideals in art also revived; the ecclesiastical traditions in painting and sculpture, which always tend to become stereotyped, began in the West to be encroached upon long before the period of the "Renaissance." The 12th and 13th centuries, which witnessed the great struggle between the secular and spiritual powers in the state, witnessed also the rise of a literature inspired by the lay spirit, and of an art which was already escaping from the thraldom of the stereotyped ecclesiastical forms. Gothic sculpture was not incidentally decorative, it was an essential element in the harmony of the architectural design. The elongated kings that guard the door of Chartres Cathedral, or the portals with the Last Judgment, are a necessary element in the façade. Thus fettered, even the realism of the Gothic sculptors failed, except in rare instances, of its full expression. The plastic arts were left for Italy, where antique models were at hand, and the glory of its achievement in the 15th and 16th centuries was so great as to obscure in men's eyes what had been done before.

But this Italian renaissance was not the only one. It was but one of many; and it was concerned with the two subjects which perhaps least deeply influence the lives of the mass of men—literary humanism and art. It is obviously absurd, in the face of the foregoing facts, to regard it as the end of a middle age in anything but in its own field.

When one studies the history of Europe subject by subject, as indicated above, and not merely in a monastic chronicle of things in general, chosen according to the author's point of view, one sees the old-time framework passing away. The traditional idea of a barren middle age and a single glorious renaissance proves false. An organic study of the past reveals a more rational picture of the process which produced the Europe of to-day. Cataclysm and special creation here as elsewhere give way to evolution. The new synthesis reveals a universal

decline from the 5th to the 10th centuries, while the Germanic races were learning the rudiments of culture, a decline that was deepened by each succeeding wave of migration, each tribal war of Franks or Saxons, and reached its climax in the disorders of the 9th and 10th centuries when the half-formed civilization of Christendom was forced to face the migration of the Northmen by sea, the raids of the Saracens upon the south and the onslaught of Hungarians and Slavs upon the east. That was the dark age. It left Europe bristling with feudal castles, and already alert for the march of progress. At once the march begins. Henry the Fowler beats back the Slavs and places the outposts of Christendom along the Elbe and the Oder. Otto I., his son, drives the Magyars from southern Germany and establishes the East Mark (Austria) to guard the upper Danube. The restoration of the Empire in 962 marks the first milestone on the pathway of recovery. Already scholarship had found a home in monasteries planted in the heart of the German forests. The succeeding century brought the Empire to the acme of its power, until Henry III. in the Synod of Sutri, sat in judgment on the impotent and demoralized papacy. Meanwhile France had been learning something even in its feudal anarchy. The monks of Cluny were at work. The Capetians had begun. The great monastery of Bec was drawing the sons of northern sea-robbers to the service of that greatest civilizing force, the Church. The progress made through even this darkest age may be measured by the difference between the army of Rollo and that which William the Conqueror gathered for the invasion of England.

There is a legend, current among historians from the days of Robertson and Hallam, that as the year 1000 approached mankind prepared for the Last Judgment; that the earth "clothed itself with the white mantle of churches," and like a penitent watched in terror and in prayer for the fatal dawn. Contemporary sources fail to bear out this beautiful conception. Apart from the fact that reckoning from the birth of Christ was by no means universal, and consequently the mass of men were ignorant that there was such a thing as the year 1000, one wonders how that most enduring type of architecture, the Romanesque, reached its maturity among men who thought that the earth itself was so soon to "shrivel like a parched scroll." Recent scholarship has absolutely disproved this legend, founded on a few trite phrases in monastic chronicles, and still to be heard in similar contexts. The year 1000 marks no epoch in medieval history.

The latter half of the 11th century witnessed the most remarkable political creation in Europe since the days of Caesar, the papal monarchy of Hildebrand. The great scholastic controversies had already begun in the schools of France; the revival of Roman law had called forth the university of Bologna, and the canonists had begun the codification of the law of the Church. The way was already cleared for the busy 12th century—the age of Louis VI. and Henry II., of Glanvill and Suger, of Abelard and Maimonides, of Frederick Barbarossa and Alexander III., of the emancipation of French communes and cities and the independence of those of Lombardy, of the growth of guilds and the extension of commerce, of *trouvere* and *troubadour* and the beginnings of vernacular literature, of the creation of Gothic art, of trial by jury and the supremacy of royal justice. Such are but a fraction of its achievements. The 12th century stands beside the 18th as one of the greatest creative centuries in human history. The 13th like the 10th applied these creations in the transformation of society. The century of Dante was also that of the first English parliament; its vast economic expansion enabled the national state to triumph in both England and France, and furnished the grounds for the overthrow of Boniface VIII. Into the complex history of this momentous age it is impossible to go in any detail. Sufficient to say that in the opening quarter of the 14th century England and France at least stood on the brink of "modern times." Then these two nations entered upon that long tragedy of the Hundred Years' War, a calamity absolutely immeasurable to both. But during its massacres, jacqueries, plagues and famines, the cities of Italy, growing rich with trade and manufactures, were in their turn

the centres of progress, this time in a new direction, toward the recovery of the antique past and the development of art.

This is the so-called Renaissance (*q.v.*). The humanists which it produced, interested only in its splendid revelations, forgot or ignored the achievements of the period which intervened between Cicero and Petrarch. Then by the genius of their work they fastened their mistaken perspective upon historians and the cultured world at large. They struck upon the unfortunate and opprobrious term "middle ages" for that which stood between them and their classic ideals. The term was first used in this sense by Flavio Biondo, whose "decades" was an attempt to block out the annals of history from 410 to 1410. His treatment fell in admirably with the ideas of his age and of that following. To Protestants the age of the papal monarchy was like the reign of Anti-Christ. Then, after the indifference of humanists and Protestant polemic, came the disgust of men of science at the scholastic philosophy—an attitude best exhibited in Bacon's *Advancement of Learning*. The 18th century was thus trebly barred from a knowledge of genuine medieval history. Romanticism, that reaction in which Sir Walter Scott, the Schlegels and Victor Hugo so largely figured, was as far from understanding what it admired as classicism had been from what it hated. Its extravagant praise of all that savoured of the middle ages was still blind to their real progress and work. They were, for it, the ages of romance and chivalry. The view of the romanticists was as one-sided as any that had gone before. It is only with the introduction of a wider outlook in the scientific study of history that it has been possible to straighten the perspective and modify the traditional scheme.

In the purely intellectual sphere it is certainly true that the recovery of the antique world was of great importance; that it made possible genuine criticism by presenting new points of contrast and opening up fields that led away from theological quibbles. But it did not mean the "double discovery of the outer and inner world." Mankind did not, as Burckhardt and J. A. Symonds lead one to imagine, suddenly throw off a cowl that had blinded the eyes for a thousand years to the beauty of the world around, and awaken all at once to the mere joy of living. If any one was ever awake to the joys of living it was the minesinger, troubadour or goliard, and the world had to wait until Rousseau and Burns before its external beauty was discovered, or at least deeply appreciated, by any but a few Dutch artists. Even Goethe crossed the Alps with his carriage shutters closed. Mont Blanc is not mentioned by travellers until after the middle of the 18th century. The discovery of the outer world is a recent thing in art as well as in science. As for the claim that the "Renaissance" delivered men from that blind reliance upon authority which was typical of "medieval" thought, that is a fallacy cherished by those who themselves rely upon the authority of historians, blind to the most ordinary processes of thought. In this regard, indeed, in spite of the advance of scientific method and the wealth of material upon which to base criticism, we are still for the most part in the middle ages. The respect for anything in books, the dogma of journalistic inerrancy which still numbers its devotees by millions, the common acceptance of even scientific conceptions upon the dicta of a small group of investigators, these are but a few of the signs of the persistence of what is surely not a medieval but a universal trait. The so-called Renaissance did much; but it did not do the things attributed to it by those who see the "middle ages" through humanist glasses.

Upon the whole, therefore, it would seem that not only was there no one middle age common to all branches of human evolution, except the period more definitely marked as the dark age, but that those characteristics which are generally regarded as "medieval" were by no means limited to a single epoch of European history. In short, the dark age was a reality; but the traditional "middle ages" are a myth. (J. T. S.)*

MIDDLEBORO, a township of Plymouth county, Massachusetts, U.S.A., in the S.E. part of the state, bounded on the N.W. by the Taunton river. Pop. (1890), 6065; (1900), 6885—of whom 920 were foreign-born; (1910 census) 8214. Area,

about 70 sq. m. The principal village also is named Middleboro; it is 35 m. S. of Boston, is served by the New York, New Haven & Hartford railroad and by electric lines connecting with Taunton, Boston, New Bedford and Cape Cod, and has a town-house, a soldiers' monument, and a public library housed in a building erected from a fund (part of which is used as a permanent endowment) bequeathed by Thomas Sprout Peirce (1823-1901), a merchant of the township, who, in addition, bequeathed about \$500,000 as a special trust-fund for the use and benefit of the town of Middleboro; the income has been spent largely in the construction of macadam roads, the erection of an almshouse and the installation of special courses in the high school. The village, a place of considerable natural beauty, is a summer resort, and has various manufactures. Other villages in the township are North, East and South Middleboro, and Rock. The township had important herring fisheries in early times and manufactured straw hats (from 1828) and ladies' dress goods. Middleboro was settled about 1662 under the Indian name Nemasket; became a part of the township of Plymouth in 1663; and in 1669 was incorporated as a separate township, taking its name probably from Middlesbrough, North Riding, York.

See Thomas Weston, *History of the Town of Middleboro, Massachusetts* (Boston, 1906).

MIDDLEBORO, a village and the county-seat of Addison county, Vermont, U.S.A., in Middlebury township, on Otter Creek, about 37 m. N.N.W. of Rutland. Pop. of the village (1890), 1762; (1900), 1897 (221 foreign-born); (1910), 1866; of the township, (1900), 3045; (1910), 2848. Middlebury is served by the Rutland railroad. It is picturesquely situated near the Green Mountain range, and is the seat of Middlebury College (chartered, 1800; co-educational since 1883), which offers a classical course and a Latin-scientific course, and had in 1907-1908 12 instructors and 203 students (84 of whom were women), and a library of 35,000 volumes. The Sheldon art museum and a public library are among the public institutions of the village, and the principal buildings include the court-house and the opera-house. The principal industrial establishments are marble quarries, "Italian" marble works, iron foundries, lime-kilns, flour-mills, and door, sash and lumber mills. About 1 m. north of the village, in the township of Weybridge, there is a large United States government breeding station for Morgan horses; and merino sheep are raised in the vicinity.

The township of Middlebury was incorporated in 1761, and the first settlement on the site of the present village was made in 1773. At the outbreak of the War of Independence the settlement was deserted, and all except two or three of the houses were destroyed by British troops; but the settlers returned soon after the close of the war, and the township was formally organized and sent a member to the state assembly in 1788. Middlebury was incorporated as a borough in 1813, and as a village in 1832.

MIDDLESBROUGH, a municipal, county and parliamentary borough and seaport in the North Riding of Yorkshire, England, 2383 m. N. by W. from London, on the North Eastern railway. Pop. (1891), 75,532; (1901), 91,302. It lies on the south bank of the Tees, 5 m. from its mouth in the North Sea, and is the centre of one of the most important iron-working districts in the world. It is wholly of modern growth, having been incorporated in 1853. Its chief buildings are a fine town-hall with lofty clock-tower and spire (1889), containing the municipal offices, free library, &c.; the exchange, county court, Dorman memorial museum and Roman Catholic cathedral. Besides iron and steel works, the first of which was that of Messrs Bolckow, Vaughan & Co., there are rolling-mills, tube works, wire-mills, engineering works, oil works, chemical works, salt works and a considerable ship-building industry. The district abounds in blast furnaces. The docks are accessible to large vessels, the entrance having a depth of 32 ft. Extensive dredging operations are carried on in the river. The accommodation for shipping includes two graving docks, two patent slips, &c. The entrance to the river is protected by two breakwaters named respectively the North Gare and South Gare. The furnaces within the port produce some

2,500,000 tons of pig iron annually. Middlesbrough is the seat of a Roman Catholic bishop. The parliamentary borough falling within the Cleveland division of the county, returns one member. The county borough was created in 1888. The town is governed by a mayor, ten aldermen and thirty councillors. Area, 2823 acres.

The earlier history of the place is meagre. Where Middlesbrough now stands there were at one time a small chapel and priory founded by Robert de Brus of Skelton Castle. These were dedicated to St Hilda, and with some lands were given by de Brus to the abbey of St Hilda at Whitby in 1130. The priory fell into ruins at the time of the Reformation, and no trace now remains beyond some stones built into the wall of a brewery. The Oak Chair in the town-hall also is made from a fragment. In 1801 there were upon the site of Middlesbrough only four farm-houses. In 1829 a company styling itself the Middlesbrough Owners bought 500 acres of land, and began building in the town. In 1830 the Stockton & Darlington railway was extended to Middlesbrough; four years later the town was lighted with gas; and after six years more a public market was established. The census of 1831 showed the population to be 154; that of 1841 showed 5709. In 1842 the opening of the docks gave additional importance to the town. From the year 1851, when John Vaughan discovered the presence of ironstone in the Eston hills, the town advanced rapidly.

MIDDLESEX, LIONEL CRANFIELD, 1ST EARL OF (1575-1645), was a successful London merchant, who was introduced to King James I. by Henry Howard, earl of Northampton, and entered the royal service in 1605. In 1613 he was knighted and was appointed surveyor-general of customs; in 1616 he became one of the masters of requests, and in 1619 master of the court of wards and liveries and chief commissioner of the navy. He was returned to parliament as member for Hythe in 1614 and for Arundel in 1621. Cranfield, who was also master of the wardrobe, was responsible for many economies in the public service, and his business acumen was very useful to the king. He took part in the attack on Bacon in 1621, and although, contrary to general expectation, he did not succeed Bacon as lord chancellor, he was created Baron Cranfield in July of this year. In 1621 also he became lord high treasurer, and in September 1622 was created earl of Middlesex, losing his positions and influence shortly afterwards because he opposed the projected war with Spain, and had incurred the hostility of Prince Charles and George Villiers, duke of Buckingham. Impeached by the House of Commons for corruption, he was found guilty by the House of Lords in May 1624 and was sentenced to lose all his offices, to pay a heavy fine and to be imprisoned during the king's pleasure. However, he was released from prison in a few days, was pardoned in the following year, and was restored to his seat in the House of Lords in 1640. The earl's second wife was Anne Brett (d. 1670), a cousin of Buckingham's mother, whom he married somewhat reluctantly in 1621 in order to ensure Buckingham's support. Middlesex died on the 6th of August 1645, leaving with other issue a son James (1621-1651), 2nd earl of Middlesex, who was a partisan of the parliamentary party during the Civil War. James was succeeded by his brother, Lionel, and when this earl died in October 1674 his titles became extinct. The first earl's daughter Frances married Richard Sackville, 5th earl of Dorset, and their son Charles was created earl of Middlesex in 1675. Two years later he became earl of Dorset, and the title of earl of Middlesex was borne by the earls and dukes of Dorset until 1843.

MIDDLESEX, a south-eastern county of England, bounded N. by Hertfordshire, E. by Essex, S.E. by the county of London, S. by Surrey, and W. by Buckinghamshire. The area is 283.3 sq. m., and, excepting Rutland, the county is the smallest in England. The area outside the county of London, or extra-metropolitan area, with which this article is mainly concerned, is 233.8 sq. m. It lies entirely in the basin of the river Thames, which forms its southern boundary. On the east it is separated from Essex by the Lea, the largest northern tributary of the Thames. The other rivers, in order westward, are the Brent, the Crane or Yedding Brook, and the Colne. The waters of

several streams are collected in the artificial Brent reservoir near Hendon, from which the Brent flows with a circuitous course to the Thames at Brentford. The Crane, rising in the high ground near Harrow-on-the-Hill, joins the Thames at Isleworth; and the Colne, which rises on the elevated plain between Hatfield and St Albans (Hertfordshire), traverses a flat valley on the western boundary of the county, where it divides into several channels, and joins the main river at Staines. The highest ground, exceeding 400 ft. at several points, and reaching 503 ft. above Stanmore, is found along the northern boundary, in a line from Stanmore through Elstree, Chipping Barnet and Potter's Bar. Two well-marked lines of heights, detached from the main line, project southward, the eastern from Whetstone through Finchley and Highgate to Hampstead, where, within the county of London, a height of 443 ft. is found on Hampstead Heath; the western being the isolated elevation on which stands Harrow-on-the-Hill. The hills skirting the Lea valley, in the neighbourhood of Enfield, are abrupt, though of no great elevation. Elsewhere the country is very slightly undulating or quite flat, as along the banks of the Thames and Lea. The Thames, however, beautifies its immediate neighbourhood, and rich sylvan scenery is not wanting in the higher districts. The greater part of the county was formerly densely forested and sparsely populated, and the name of Enfield Chase, a royal preserve in the north-east, still recalls this condition. In modern times the visible influence of London has spread over practically the entire county. Villages have grown into populous suburbs; large institutions, for which sites adjacent to rather than within the metropolis have been found preferable, are numerous, and the development of suburban railway communications has brought fresh ground within reach of builders.

Geology.—The county lies entirely within the structural basin of the Thames, and, as in the neighbouring counties, the general slope of the ground and dip of the strata is towards the south-east. South of an irregular line passing from Uxbridge, north of Hayes, by Hanwell and Ealing to Hyde Park and east of a similar line from the upper side of the Park to Tottenham and on from that point to Enfield, the only visible deposits are the gravels, loams, brick-earths and sands laid down in former times by the Thames, with contributions by the Lea and the Colne. These alluvial deposits rise gradually northward from the Thames and westward from the Lea, in a series of gentle terraces. The earliest portions of London were built upon these terraces, because while they were dry at the surface, water could be obtained by sinking shallow wells. The alluvium has yielded many flint implements and the bones of the mammoth, bear and rhinoceros, great elk and other extinct forms. The loams are dug for bricks and the gravel for ballast, &c., about West Drayton, Southall, Enfield and Tottenham.

The London clay, a marine deposit, is bluish where it has not been turned brown by exposure to the weather. It underlies all the river deposits and rises to the surface north and east of the alluvial boundary indicated above. It gives rise to the undulating grassy country round Harrow, Chipping Barnet and Elstree. Below the London clay are the more sandy Reading beds, they may be seen at Harefield and at South Mimms; inliers occur at Pinner and Ruislip. Chalk is only visible on the side of the Colne valley at Harefield, where it is quarried, and at South Mimms. Formerly, the sandy and pebbly Bagshot beds covered all the London clay area, but now only isolated patches remain, such as those on the top of Harrow, Hampstead and Highgate hills. Long after the Bagshot beds were laid down the country was covered by a variety of glacial deposits; such are the pebbly gravels of Stanmore Heath and the district north of Barnet, the clay and sand of Finchley, Muswell Hill and Southgate, the chalky boulder clay to be seen at Finchley, Southgate and Potter's Bar. Several deep borings in the London basin prove the existence, beneath the chalk, of beds which do not crop out in Middlesex. The most interesting is that at Meux's Brewery, Tottenham Court Road (about 1146 ft.), which passes through the following formations: gravel and clay, 21 ft.; London clay, 64 ft.; Reading beds, 51 ft.; Thanet sand, 21 ft.; chalk, 655 ft.; upper greensand, 28 ft.; gault, 160 ft.; lower greensand, 64 ft.; Devonian rocks, 80 ft.

Industries, &c.—The climate of some of the high-lying districts is particularly healthy. Little more than one-half the total area of the county is under cultivation; and the grain crops, greatly decreasing, are insignificant. The soil in the north and north-west

¹ See "Geology of Part of the London Basin," *Mem. Geol. Survey*, 2 vols.: "Soils and Subsoils," ditto; *Proceedings of the Geologists' Association*. A large model of the geology of London is exhibited in the Museum of Practical Geology, Jermyn Street, London.

is heavy, poor clay; but the rich alluvial soil of the Thames Valley is specially suitable for market gardens. On the outskirts of London much land now built over was formerly devoted to market gardening. The number of livestock decreases; in fact, agriculture as a whole has slowly to give place to extension of building. Industries are extensive and varied. The county is naturally, in view of the proximity of London, closely intersected with railways, the following companies, from east to west and south, affording communications: Great Eastern, Great Northern, Midland, London & North-Western, Metropolitan, Great Central, Metropolitan District, Great Western, London & South-Western. Moreover, in some parts the tramway system has been extended over a wide area from London; thus Uxbridge, in the extreme west of the county, is so served. The principal canals are the Grand Junction, running west from Brentford to the Colne Valley, and thence northward; with a branch (the Paddington Canal) connecting it with the Regent's Canal in London; and, in the east, the Lea navigation.

Population and Administration.—The area of the ancient county is 181,320 acres, with a population in 1871 of 2,597,765; in 1891 of 3,251,671; and in 1901 of 3,585,323. At the time of the Domesday Survey the population of Middlesex, exclusive of London, was 2302. The extra-metropolitan area is 149,668 acres, with a population in 1901 of 798,738. The part of the ancient county transferred to the county of London under the Local Government Act 1888 was 31,484 acres in extent, and 771 acres were then transferred to Hertfordshire; while under the London Government Act 1899 the southern part of Hornsey was transferred to London. The area of the administrative county is 148,700 acres. The county contains six hundreds: the municipal boroughs are Ealing (200,33,931), Hornsey (72,056). The urban districts are Acton (37,744), Brentford (15,171), Chiswick (29,809), Edmondton (46,899), Enfield (42,738), Feltham (5280), Finchley (22,126), Friern Barnet (11,566), Greenford (819), Hampton (6813), Hampton Wick (2606), Hanwell (10,438), Harrow-on-the-Hill (10,220), Hayes (3000), Hendon (22,450), Heston and Isleworth (30,863), Kingsbury (757), Ruislip-Northwood (3850), Southall Norwood (13,200), Southgate (14,993), Staines (6688), Sunbury-on-Thames (4544), Teddington (14,037), Uxbridge (102,511), Uxbridgeham (20,091), Uxbridge (6885), Wealdstone (5001), Wembley (42,920), Willesden (114,811), Wood Green (34,233). The county is in the jurisdiction of the central criminal court, and the whole extra-metropolitan county is within the metropolitan police district, the name of "Greater London" covering it. There are one court of quarter sessions and eight petty sessional divisions. The number of civil parishes is 60. Middlesex (extra-metropolitan) is wholly in the diocese of London, excepting a small portion in that of Oxford, and includes 153 ecclesiastical parishes or districts, wholly or in part. The extra-metropolitan parliamentary divisions, each comprising one member, are, Enfield, Tottenham, Hornsey, Harrow, Uxbridge, Brentford and Ealing.

History.—The district which is now Middlesex was colonized in the 6th century by an offshoot of the East Saxon tribe, and derived its name from its position between the kingdoms of the East and West Saxons. In a charter dated 704 Middlesex is mentioned by name as a dependency of Essex, but soon after it acknowledged the supremacy of Mercia, and from 748 onwards the Mercian council was held at London, and from 780 onwards at Brentford. In the 9th century Middlesex formed part of the Danelagh, and in 993 Anlaf the Dane came with 93 ships to Staines. The only reference to Middlesex in the Saxon Chronicle occurs in 1011, when it was again overrun by the Danes. The Conqueror's march upon London was preceded by a general devastation of the surrounding country, the effects of which are illustrated in the Domesday Survey by the diminution in land values. At this time the district north of London formed the vast forest of Middlesex, the greater part of which was disafforested in the reign of Henry III. Enfield had woodlands for 2000 pigs; Ruislip for 1500 pigs; and Kingsbury, Hillingdon and Hendon for 1000 pigs each. Vineyards are mentioned at Holborn, Colham, Kempton and Kensington; fishponds at Harmondsworth and Harefield produced each 1000 eels.

As a shire Middlesex probably originated about the time of the frith of 886, when it is described as the land dependent upon London, and in 912 is referred to as "London and the land which owed obedience thereto." During the Saxon period the extensive manors held by the church of Canterbury, the bishop of London and his canons of St Paul's, and the abbey of Westminster were held as independent franchises, the courts for St Paul's being held at Stepney and Fulham, for Westminster at Westminster and Staines, and for Canterbury at Harrow. By charter of Henry I. (confirmed by Stephen and Henry II.) the citizens of London held Middlesex at

farm for £300, with power to elect a sheriff from among their number, and by charter from John the shrievalty of both London and Middlesex was granted to the mayor and citizens in fee. By charter of 1242 the common pleas for the county of Middlesex were ordered to be held at the stone cross in the Strand. Under a charter of 1447 the lord mayor was authorized to nominate one of the city aldermen as justice of the peace for Middlesex. The six modern hundreds of Edmondton, Elthorne, Gore, Isleworth, Ossulston, and Spelthorne have been scarcely changed since the Domesday Survey, except that Isleworth was then Honeslaw (Hounslow), while in the 12th century hidage a hundred of "Mimes" is mentioned, corresponding with the Domesday hundred of Edmondton. Middlesex has always been included in the diocese of London. The archdeaconry of Middlesex, which includes part of Essex, is mentioned in 1151, but the Middlesex portion was not subdivided into rural deaneries until 1857, when the deaneries of Fulham, Ealing, Uxbridge, Staines, Hampton, Enfield, Harrow and St Pancras were created. The deaneries of Chelsea, Hammersmith, Hampstead, Hornsey, Kensington, Paddington, St Marylebone, Westminster and Willesden were created later, but Staines was abolished.

In 1215 Middlesex was ravaged by William, earl of Salisbury, and Falkes de Breauté, and in the same year at Runcimed near Staines John was forced to issue the Magna Carta. In the Civil War of the 17th century Middlesex supported the Parliamentary cause, joining in 1642 with Hertfordshire and Essex in a petition that the votes of the bishops and popish lords might be disallowed in the House of Lords, and that the forts and castles of the kingdom might be placed in such hands as the Parliament could confide in. Sir Denzil Holles was defeated by the Royalists at Brentford in 1642, and in 1645 a fruitless treaty between Charles I. and the Parliament was concluded at Uxbridge. Brentford had famous election contests in 1768 and 1769.

The woollen and leather industries flourished in Middlesex in Norman times. London was the great place of slaughter, and hides were tanned at Enfield. Bricks were also manufactured from early times, and Heston was noted for its wheat. Paper was extensively manufactured in the 17th century, and much distress was caused in 1636 by a decree prohibiting the purchase of old rags for the Middlesex paper-mills for fear of the plague. In 1640 the manufacturers of mohair yarn in Middlesex appealed against a bill prohibiting the wearing of material made of the said yarn during the winter season. In 1655 a certificate of a hundred master tanners and other traders of Middlesex approved an invention for converting raw hides into leather by means of new liquor, with or without oak-bark.

Middlesex returned two members to parliament in 1295. (For the representation of London, see LONDON.)

See John Norden, *Speculum Britanniae: the firste parte, an historical and chorographical description of Middlesex* (London, 1593; reprinted 1637 and 1723); Daniel Lysons, *The Environs of London (1792-1796)*; *Victoria County History, Middlesex*.

MIDDLETON, EARLS OF. JOHN MIDDLETON, 1ST EARL OF MIDDLETON (c. 1610-1674), belonged to a Kincardineshire family which had held lands at Middleton since the 12th century. In early life he served as a soldier in France; later he fought against Charles I. both in England and in Scotland, being especially prominent at the battle of Philiphaugh and in other operations against the great Montrose. He held a high command in the Scottish army which marched to rescue the king in 1648, and he was taken prisoner after the battle of Preston. He joined Charles II. when that monarch reached Scotland in 1650, but he was soon at variance with the party which at that time was dominant in church and state and was only restored to favour after doing a public penance at Dundee. He was a captive for the second time after the battle of Worcester, where he commanded the Royalist cavalry, but he escaped from the Tower of London to Paris. In 1653 Middleton was chosen by Charles II. to head the projected rising in Scotland. He reached that country in February 1654, but the insurrection was a complete failure. Its leader, who cannot be held responsible for this result, remained in Scotland until 1655, when he rejoined Charles II., who made

him an earl in 1656. He returned to England with the king in 1660 and was appointed commander-in-chief of the troops in Scotland and lord high commissioner to the Scottish parliament, which he opened in January 1661. He was an ardent advocate of the restoration of episcopacy, this being one reason which led to serious dissensions between the earl of Lauderdale and himself, and in 1663 he was deprived of his offices. He was afterwards (1667) governor of Tangier, where he died in June 1674.

His eldest son CHARLES, 2ND EARL OF MIDDLETON (c. 1640-1719), held several offices under Charles II. and James II., being envoy extraordinary at Vienna and afterwards joint secretary for Scotland. In 1684 he became an English secretary of state, and with Richard Graham, Viscount Preston, he had the difficult task of managing the House of Commons for James II. He was loyal to James after the king fled to France, although he remained in England, where, as the leader of the moderate Jacobites, he sought to bring about a restoration by peaceful means. In 1693 the earl joined the exiled king at St Germain's, where he became his secretary of state; afterwards he held the same office at the court of James Edward, the old pretender, in Flanders and in Lorraine. He was partly responsible for the unsuccessful expedition of the Jacobites to Scotland in 1707, and he resigned his office as secretary in 1713. Middleton, who had been created earl of Monmouth by the pretender, died in 1719. His titles had been declared forfeited in 1695, but they were claimed by his son John, who died unmarried about 1746. The earl was a Protestant, although a lukewarm one, until 1701, when he yielded to the dying wish of James II. and joined the Roman Catholic Church.

One of Middleton's kinsmen was SIR CHARLES MIDDLETON, Bart. (1726-1813). Having served in the navy Middleton was comptroller of the navy from 1778 to 1790, "standing out through that period of inept administration as the pillar of the service." In April 1805, at a most critical time, he was, although eighty years of age, appointed first lord of the admiralty by Pitt and was created Lord Barham. It has been usual to regard Barham as a cipher at the admiralty board, but more recent research, especially an examination of the *Barham Papers*, has proved this to be the reverse of the truth. He enjoyed the absolute confidence of Pitt, and it was his experience, industry and energy which made possible the great campaign which ended at Trafalgar. He resigned office in January 1806 and died on the 17th of January 1813. His barony passed through his daughter Diana (1762-1823) to the Noels, earls of Gainsborough, by whom it is still held. The *Barham Papers* are being edited by Sir J. K. Laughton (vol. i. 1907; vol. ii. 1910). See also J. S. Corbett, *The Campaign of Trafalgar* (1910).

See A. C. Biscoe, *The Earls of Middleton* (1876).

MIDDLETON, ARTHUR (1742-1787), American politician and signer of the Declaration of Independence, was born at Middleton Place on the Ashley river, South Carolina, on the 26th of June 1742. His family was one of the most prominent in the colony. The grandfather, Arthur Middleton (1681-1737), was president of the Council in 1721-1730 and as such was acting governor in 1725-1730, and the father, Henry Middleton (1717-1784), was speaker of the Assembly in 1745-1747 and again in 1754-1755, a delegate to the Continental Congress in 1774-1776, and its president from October 1774 to May 1775, a member of the South Carolina Committee of Safety, and in 1775 president of the South Carolina Provincial Congress. Like most wealthy South Carolinians of the 18th century, Arthur Middleton was educated in England—at Hackney, at Westminster School, and at St John's College, Cambridge. He then returned to South Carolina, but soon afterwards went back to England to live, and travelled on the Continent. In 1773 he again returned to South Carolina, and in the controversies between the colonists and the home government became a leader of the Whigs. He was a member of the provincial Council of Safety in 1775-1776, and a delegate to the Continental Congress in 1776-1777. In 1778 he was elected governor of South Carolina, but owing to his dissatisfaction with the new state constitution he declined to serve. He was captured by the British at Charleston in May 1780, was exchanged in July 1781, was again a delegate to Congress in

1781-1783, and later served in the state legislature. He died on the 1st of January 1787 at Middleton Place, near Charleston.

His eldest son, HENRY MIDDLETON (1770-1846), was an orator of ability, was governor of South Carolina in 1810-1812, a representative in Congress in 1815-1819, and the United States minister to Russia from 1820 to 1830, negotiating in 1824 a convention "relative to navigation, fishing and trading in the Pacific Ocean, and to establishments on the North-West Coast." This was the first treaty between the United States and Russia.

MIDDLETON, CONYERS (1683-1750), English divine, was born at Richmond in Yorkshire on the 27th of December 1683. He graduated at Cambridge, took orders, and in 1706 obtained a fellowship, which he soon resigned upon contracting an advantageous marriage. In 1717 a dispute with Richard Bentley, who made an extortionate demand on the occasion of Middleton's being created D.D., involved him in an acrimonious controversy. He wrote several trenchant pamphlets, among them the "Remarks" and "Further Remarks" on Bentley's *Proposals for a New Edition of the Greek Testament*, an endeavour to visit his grievances upon the text of the New Testament. In 1723 he was involved in a lawsuit by personalities against Bentley, which had found their way into his otherwise judicious tract on library administration, written on the occasion of his appointment as university librarian. In 1726 he offended the medical profession by a dissertation contending that the healing art among the ancients was only exercised by slaves or freedmen. Between the dates of these publications he visited Italy, and made those observations on the pagan origin of church ceremonies and beliefs which he subsequently embodied in his *Letter from Rome* (1729). This cogent tract probably contributed to prepare the storm which broke out against him on his next publication (1731). In his remonstrance with Daniel Waterland on occasion of the latter's reply to Matthew Tindal's *Christianity as Old as the Creation*, Middleton takes a line which in his day could hardly fail to expose him to the reproach of infidelity. He gives up the literal truth of the primeval Mosaic narratives; and, in professing to indicate a short and easy method of confuting Tindal, lays principal stress on the indispensableness of Christianity as a mainstay of social order. This was to resign nearly everything that divines of the Waterland stamp thought worth defending. Middleton was warmly assailed from many quarters, and retreated with some difficulty under cover of a sheaf of apologetic pamphlets and a more regular attendance at church. His next important publication was a *Life of Cicero* (1741), largely told in that statesman's own words. Though Middleton's reputation was much enhanced by this piece of work, there is no doubt that he drew largely from the scarce book of William Beland, *De tribus luminibus Romanorum*. The work was undertaken at the instance of Lord Hervey, in correspondence with whom also originated his disquisition on *The Roman Senate*, published in 1747. The same year and the following produced the most important of all his writings, the *Introductory Discourse and the Free Inquiry* "concerning the miraculous powers which are supposed to have subsisted in the church from the earliest ages." In combating this belief Middleton indirectly established two propositions of capital importance. He showed that ecclesiastical miracles must be accepted or rejected in the mass; and he distinguished between the authority due to the early fathers' testimony to the beliefs and practices of their times, and their very slender credibility as witnesses to matters of fact. Some individual grudge seems to have prompted him to expose, in 1750, Bishop Sherlock's eccentric notions of antediluvian prophecy, which had been published 25 years before. On the 28th of July 1750 he died at Hildersham, near Cambridge.

Middleton's most ambitious work is obsolete from no fault of his, but his controversial writings retain a permanent place in the history of opinion. In his more restricted sphere he may not inappropriately be compared with Lessing. Like Lessing's, the character of his intellect was captious and iconoclastic, but redeemed from mere negation by a passion for abstract truth, too apt to slumber until called into activity by some merely personal stimulus. His diction is generally masculine and

harmonious. Pope thought him and Nathaniel Hooke the younger the only prose writers of the day who deserved to be cited as authorities on the language. Samuel Parr, while exposing his plagiarisms, heaps encomiums on his style. But his best qualities, his impatience of superstition and disdain of mere external authority, are rather moral than literary.

The best general view of his intellectual character and influence is to be found in Sir Leslie Stephen's *English Thought in the Eighteenth Century*, ch. vi. A handsome edition of his works, containing several posthumous tracts, but not including the *Life of Cicero*, appeared in 4 vols. in 1752 and in 5 vols. in 1755.

MIDDLETON, THOMAS (c. 1570-1627), English dramatist, son of William Middleton, was born about 1570, probably in London. There is no proof that he studied at either university, but he may be safely identified with one of the Thomas Middletons entered at Gray's Inn in 1593 and 1596 respectively. He began to write for the stage with *The Old Law*, in the original draft of which, if it dates from 1599 as is generally supposed, he was certainly not associated with William Rowley and Philip Massinger, although their names appear on the title-page of 1656. By 1602 he had become one of Philip Henslowe's established playwrights. The pages of Henslowe's *Diary* contain notes of plays in which he had a hand, and in the year 1607-1608 he produced no less than six comedies of London life, which he knew as accurately as Dekker and was content to paint in more realistic colours. In 1613 he devised the pageant for the installation of the Lord Mayor, Sir Thomas Middleton, and in the same year wrote an entertainment for the opening of the New River in honour of another Middleton. From these facts it may be reasonably inferred that he had influential connexions. He was frequently employed to celebrate civic occasions, and in 1620 he was made city chronologer, performing the duties of his position with exactness till his death.

The most notable event in his career was the production at the Globe theatre in 1624 of a political play, *A Game at Chess*, satirizing the policy of the court, which had just received a rebuff in the matter of the Spanish marriage, the English and Spanish personages concerned being disguised as the White Knight, the Black King, and so forth. The play was stopped, in consequence of remonstrances from the Spanish ambassador, but not until after nine days' performances, and the dramatist and the actors were summoned to answer for it. It is doubtful whether Middleton was actually imprisoned, and in any case the king's anger was soon satisfied and the matter allowed to drop, on the plea that the piece had been seen and passed by the master of the revels, Sir Henry Herbert. Middleton died at his house at Newington Butts, and was buried on the 4th of July 1627.

He worked with various authors, but his happiest collaboration was with William Rowley, this literary partnership being so close that F. G. Fleay (*Biog. Chron. of the Drama*) treats the dramatists together. The plays in which the two collaborated are *A Fair Quarrel* (printed 1617), *The World Lost at Tennis* (1620), an ingenious masque, *The Changeling* (acted 1624, printed 1653), and *The Spanish Gipsie* (acted 1623, printed 1653). The main interest of the *Fair Quarrel* centres in the mental conflict of Captain Ager, the problem being whether he should fight in defence of his mother's honour when he no longer believes his quarrel to be just. The underplot, dealing with Jane, her concealed marriage, and the physician, which is generally assigned to Rowley, was suggested by a story in Giraldi Cinthio's *Heulom-mithi*. *The Changeling* is the most powerful of all the plays with which Middleton's name is connected. The plot is drawn from the tale of Alsemero and Beatrice-Joanna in Reynolds's *Triumphs of God's Reveng against Murder* (bk. i., hist. iv.), but the story, black as it is, receives additional horror in Middleton's hands. The famous scene in the third act between Beatrice and De Flores, who has murdered Pirraquo at her instigation, is admirably described by Swinburn:

"That note of incredulous amazement that the man whom she has just instigated to the commission of murder 'can be so wicked' as to have served her end for any end of his own beyond the pay of a professional assassin, is a touch worthy of the greatest dramatist that ever lived. . . . That she, the first criminal, should be honestly

shocked as well as physically horrified by revelation of the real motive which impelled her accomplice into crime, gives a lurid streak of tragic humour to the lifelike interest of the scene; as the pure infusion of spontaneous poetry throughout redeems the whole work from the charge of vulgar subservience to a vulgar taste for the presentation or the contemplation of criminal horror."

Leigh Hunt thought that the character of De Flores, for effect at once tragical, probable and poetical, "surpassed anything with which he was acquainted in the drama of domestic life." The underplot of the piece, though it is based on the humours of a madhouse, has genuine comic flashes. *The Spanish Gipsie* has a double plot based on the *Fuerra de la sangre* and the *Gitanilla* of Cervantes. Much has been said on the collaboration of Middleton with Rowley, who was much in demand with fellow-dramatists, especially for his experience in low comedy. These plays, even in scenes where the evidence in favour of one or other of the collaborators is clear, rise to excellence which neither dramatist was able to achieve alone. It was clearly no mechanical partnership the limits of which can be said to be definitely assigned when the actual text has been parcelled out between the collaborators.

With Thomas Dekker he wrote *The Roaring Girl, or Moll Cut-Purse* (1611). The frontispiece represents Moll herself in man's attire, indulging in a pipe of tobacco. She was drawn or idealized from life, her real name being Mary Frith (1584-1659?), who was made to do penance at St Paul's Cross in 1612. "Worse things, I must confess," says Middleton in his preface, "the world has taxed her for than has been written of her; but 'tis the excellency of a writer to leave things better than he finds 'em." In the play she is the champion of her sex, and is equally ready with her sword and her wits. Middleton is also credited with a share in Thomas Dekker's *Honest Whore* (pt. 1., 1604). *The Witch*, first printed in 1778 from a unique MS., now in the Bodleian, has aroused much controversy as to whether Shakespeare borrowed from Middleton or vice versa. The dates of both plays being uncertain, there are few definite data. The distinction between the two conceptions has been finely drawn by Charles Lamb, and the question of borrowing is best solved by supposing that what is common to the incantations of both plays was a matter of common property. *The Mayor of Quinborough* was published with Middleton's name on the title-page in 1661. Simon, the comic mayor, is not a very prominent character in the plot, which deals with Vortiger, Hengist, Horsus and Roxena among other characters. One of its editors, Mr Havelock Ellis, thinks the proofs of its authenticity as Middleton's work very slender. It is generally supposed to have been a very early work subjected to generous revision.

The plays of Middleton still to be mentioned may be divided into romantic and realistic comedies of London Life. Dekker had as wide a knowledge of city manners, but he was more sympathetic in treatment, readier to idealize his subject. *Two New Playes. Viz., More Discoveries besides Women. Women beware Women*, of which the former was licensed before 1622, appeared in 1657. The plot of *Women beware Women* is a double intrigue from a contemporary novel, *Hyppolito and Isabella*, and the genuine history of Bianca Capello and Francesco de Medici. This play, which ends with a massacre appalling even in Elizabethan drama, may be taken as giving the measure—no mean one—of Middleton's unaided power in tragedy.

The remaining plays of Middleton are: *Blurt, Master-Constable. Or the Spaniards Night-walk* (1602); *Michalmas Term* (1607), described by A. C. Swinburn as an excellent Hogarthian comedy; *The Phoenix* (1607); a version of the Haroun-al-Raschid trick; *The Family of Love* (1608); *A Trick to catch the Old-one* (anonymously printed, 1608); *Your Fine Gallants* (licensed 1608); *A Mad World, my Masters* (1608); *A Chast Mayde in Cheapside* (printed 1630), notable for the picture of Tim, the Cambridge student, on his return home; *Anything for a Quiet Life* (c. 1617, printed 1662); *No Wit, No Help like a Woman's* (c. 1613, printed 1657); *The Widow* (printed 1652), on the title-page of which appear also the names of Ben Jonson and John Fletcher, though their collaboration may be doubted. Eleven of his masques are extant. A tedious poem, *The Wisdom of Solomon paraphrased*, by Thomas Middleton, was printed in 1597, and *Microcosmopolis, Six Shewing Satires by T. M. Gent.*, in 1599. Two prose pamphlets, *dealing with London*, by Father Hubbard's *Tale and The Black Book*, appeared in 1604 under his initials. His non-dramatic work, however, even if genuine, has little value.

AUTHORITIES.—His works were edited by Alexander Dyce (5 vols.) in 1840, with a valuable introduction quoting many documents, and by A. H. Bullen (8 vols.) in 1885. *The Best Plays of Thomas Middleton* were edited for the Mermaid series (1887) by Havelock Ellis with an introduction by A. C. Swinburne. See also Miss P. G. Wiggins' *Inquiry into the Authorship of the Middleton-Rowley Plays* (Boston, 1897), and the notice on Middleton in Professor A. W. Ward's *Hist. of Eng. Dram. Lit.* (ed. 1899; ii., 493-540), which contains a full account of Middleton's *Game at Chess*. A careful examination of the parallels between the plays of Shakespeare and Middleton is made by D. Hugo Jung in "Das Verhältnis Thomas Middleton's zu Shakspeare" (*Münchener Beiträge zur roman. u. engl. Phil.* vol. xxix., 1904).

MIDDLETON, a market town and municipal borough in the Middleton parliamentary division of Lancashire, England, on the Irk, near the Rochdale Canal, and on the Lancashire & Yorkshire railway, 6 m. N.N.E. from Manchester. Pop. (1901), 25,178. The church of St Leonards is of mixed architecture, with a low square tower. The oldest portion of the building (the tower arch) dates from the 12th century, but the main portion from 1412, and the south aisle from 1524. Two chapels in it contain memorials of, and are named after, two ancient Lancashire families, the Asshetons and the Hopwoods. The Queen Elizabeth grammar-school, a building in the Tudor style, was founded in 1572 by Nowell, dean of St Paul's, London. There are a handsome town-hall and municipal technical schools. An extensive system of tramways and electric light railways connects the town with its suburbs and adjacent industrial centres. The prosperity of the town dates from the introduction of manufactures at the close of the 18th century. The staple trade is the spinning and weaving of cotton, and the other industries include silk weaving, calico-printing, bleaching, dyeing, iron-founding and the manufacture of soap and chemicals. There are collieries in the neighbourhood. The town was incorporated in 1886, and the corporation consists of a mayor, 6 aldermen and 18 councillors. Area, 4775 acres.

MIDDLETOWN, a city and the county-seat of Middlesex county, Connecticut, U.S.A., in the township of Middletown, in the south central part of the state, on the west bank of the Connecticut river, about 30 m. from its mouth, and about 15 m. south of Hartford. Pop. (1890), 9013; (1900), 9589, of whom 2316 were foreign-born; (1910 census) 11,851. Within a radius of 2 m. from the city hall there was found in 1910 most of the township's population of 20,749. The city is served by two branches of the New York, New Haven & Hartford railroad, by a line of coast steamers, and by electric lines connecting with neighbouring cities and villages. The city is connected by a long highway bridge with the village of Portland in the township of Portland (pop. in 1910, 3425; area 26 sq. m.), which is known for its brown-stone quarries. Four miles south of Middletown is Chestnut Mountain (or Bull Hill), which commands a fine view; and about 3 m. east are the "Narrows" of the Connecticut river, where the water flows between high hills. Middletown has a number of handsome residences. In High Street stand the buildings of Wesleyan university (Methodist Episcopal), founded in 1831 by the Rev. Wilbur Fisk, who became the first president and the Rev. Laban Clark (1778-1868), who became the first president of the board of trustees. Women were first admitted in 1872, but coeducation was later discontinued, and the last freshman class of women students under the old system entered in 1909. The university offers classical and scientific courses, and in 1908-1909 had 36 instructors, 322 students (30 being women), and a library of 70,000 volumes. In 1875-1877 the work of the first agricultural experiment station in the United States was carried on here under state supervision in Wesleyan University, with Professor Wilbur Olin Atwater (1844-1907) as director; it was then removed to New Haven. Middletown is also the seat of the Berkeley divinity school (Protestant Episcopal), founded in 1849 as the theological department of Trinity College, Hartford, rechartered and removed to Middletown in 1854, and having in 1907 a faculty of 8, and 16 students; and the city has a free public library (1874) with 17,700 vols. in 1907. South-east of the city is the Connecticut hospital for the insane, and south-

west of the city, the Connecticut industrial school for girls (reformatory). The total value of the factory products in 1905 was \$5,604,676, an increase of 35 % over that for 1900. The municipality owns and operates the waterworks.

Middletown occupies the site of an Indian village, Mattabesec or Mattabesett (from *Massa-sepuet-et*, "at a great rivulet or brook"), the principal village of the Mattabesec Indians, an Algonquin tribe which included the Wongunk, Pyquaug and Montowese Indians and seems to have had jurisdiction over the whole of south-western Connecticut. The township of Middletown was settled by whites in 1650, and until 1653, when the present name was adopted, was known by the Indian name, Mattabesett. It was incorporated in 1651; and the city was chartered in 1784. Shipbuilding and commerce became the principal sources of wealth. In the middle of the nineteenth century Middletown was one of the leading cities of Connecticut, and as late as 1886 it was a port of entry; but the development of rival ports, especially New Haven, Hartford and Bridgeport, into railway centres, retarded the growth of manufacturing, and commerce declined after the Civil War.

MIDDLETOWN, a city of Orange county, New York, U.S.A., on the Wallkill river, 67 m. N.N.W. of New York City. Pop. (1890) 11,977; (1900) 14,522, including 1700 foreign-born and 480 negroes; (1905, state census) 14,516; (1910) 15,313. It is served by the Erie, the New York, Susquehanna & Western, and the New York, Ontario & Western railways, and is connected by an electric line with Goshen (pop. in 1910, 3081), the county-seat. It is situated in an attractive dairy and agricultural country; and in the city and vicinity there are many summer residences. Here are the state homoeopathic hospital for the insane, a state armoury, Thrall hospital, and Thrall library. Middletown is primarily a manufacturing city, and has the car shops of the New York, Ontario & Western railway. The value of its factory products increased from \$2,154,742 in 1900 to \$3,356,330 in 1905, or 55.8 %. The municipality owns and operates its waterworks. Middletown was settled about 1706 and owed its early commercial importance to its being a "half-way house" (whence its name) for travellers on the Minisink Road to western New York, and it was for a time a terminus of the Erie railroad. It was incorporated as a village in 1848, and first chartered as a city in 1888.

MIDDLETOWN, a city of Butler county, Ohio, U.S.A., on the Miami river, 34 m. N. of Cincinnati. Pop. (1890), 7681; (1900), 9215, of whom 769 were foreign-born and 314 were negroes; (1910) 13,152. It is served by the Cleveland, Cincinnati, Chicago & St Louis, the Cincinnati, Hamilton & Dayton, the Cincinnati Northern (New York Central system), and a branch of the Cincinnati, Lebanon & Northern (Pennsylvania system) railways. It is the trade centre of a rich and beautiful agricultural region in which tobacco, wheat and Indian corn are the principal crops. The river furnishes considerable water-power and the total factory product in 1905 was valued at \$8,357,993, an increase of 47.2 % over that in 1900. The waterworks are owned and operated by the municipality. Middletown was laid out in 1802 and was named from its location between Cincinnati and Dayton; it was incorporated in 1833.

MIDDLETOWN, a borough of Dauphin county, Pennsylvania, U.S.A., on the east bank of the Susquehanna river, 9 m. below Harrisburg. Pop. (1890), 5080; (1900), 5608 (340 foreign-born and 280 negroes); (1910), 5374. It is served by the Pennsylvania and the Philadelphia & Reading railways, and by an electric line to Harrisburg. The borough has a considerable trade with the surrounding agricultural country, and owing to the proximity of the Yorkhaven power-plant (across the river) and the excellent railway service, is a manufacturing centre. The municipality owns its electric lighting plant. Middletown was founded in 1755 by Friends (from Philadelphia and other places in Pennsylvania) and Scotch-Irish, and was so named because of its position midway between Lancaster and Carlisle. It was first incorporated as a borough in 1828.

MIDDLEWICH, an urban district in the Northwich parliamentary division of Cheshire, England, 166 m. N.W. of London,

on the London & North Western railway. Pop. (1901), 4669. It lies in open country near the river Dane, having water communications by the Trent and Mersey canal, and a branch giving access to the Shropshire Union canal. The church of St Michael and All Angels is of various periods and contains numerous monuments. In the streets not a few old buildings remain, making for picturesqueness, and a number of the fine timbered houses in which Cheshire abounds are seen in the immediate neighbourhood. Middlewich shares in the salt industry common to several towns, such as Northwich and Winsford, in this part of the county; there are also chemical works and a manufacture of condensed milk.

MIDHAT PASHA (1822-1884), Turkish statesman, the son of a civil judge, was born at Constantinople in 1822. His father, a declared partisan of reform, trained him for an administrative career, and at the age of twenty-two he was attached as secretary to Falk Effendi, whom he accompanied in Syria for three years. On his return to Constantinople Midhat was appointed chief director of confidential reports, and after a new financial mission in Syria was made second secretary of the grand council. His enemies, however, succeeded in ousting him from this post, and caused him to be entrusted with the apparently impossible task of settling the revolt and brigandage rampant in Rumelia. His measures were drastic and their success was startling and the government made him an official of the first rank and restored him to his place in the grand council. In similar vigorous fashion he restored order in Bulgaria in 1857. In 1860 he was made vizier and pasha, and entrusted with the government of Nisch, where his reforms were so beneficial that the sultan charged him, in conjunction with Fuad Pasha and Ali Pasha, to prepare the scheme for adapting them to the empire which was afterwards known as the law of the vilayets. After further administrative work in his province, he was ordered to organize the council of state in 1866, and was then made governor of Bagdad, where his success was as decisive as at Nisch, but attended with much greater difficulties. In 1871 the anti-reform influence of the grand vizier, Mahmoud Nedim, seemed to Midhat a danger to the country, and in a personal interview he boldly stated his views to the sultan, who was so struck with their force and entire disinterestedness that he appointed Midhat grand vizier in place of Mahmoud. Too independent, however, for the court, Midhat remained in power only three months, and after a short governorship of Salonica he lived apart from affairs at Constantinople until 1875.

From this time forward, however, Midhat Pasha's career resolved itself into a series of strange and almost romantic adventures. While sympathizing with the ideas and aims of the "Young Turkey" party, he was anxious to restrain its impetive, but the sultan's obduracy led to a coalition between the grand vizier, the war minister and Midhat Pasha, which deposed him in May 1876, and he was murdered in the following month. His nephew Murad V. was in turn deposed in the following August and replaced by his brother, Abdul Hamid II. Midhat Pasha now became grand vizier, reforms were freely promised, and the Ottoman parliament was inaugurated with a great flourish. In the following February, however, Midhat was dismissed and banished for supposed complicity in the murder of Abdul Aziz. He then visited various European capitals, and remained for some time in London, where he carefully studied the procedure in the House of Commons. Again recalled in 1878, he was appointed governor of Syria, and in August exchanged offices with the governor of Smyrna. But in the following May the sultan again ordered him to be arrested, and although he effected his escape and appealed to the powers, he shortly afterwards saw fit to surrender, claiming a fair hearing. The trial accordingly took place in June, when Midhat and the others were sentenced to death. It was, however, generally regarded as a mockery, and on the intercession of the British government the sentence was commuted to banishment. The remaining three years of his life were consequently spent in exile at Taif in Arabia, where he died, probably by violence, on the 8th of May 1884. To great ability, wide sympathies, and undoubted patriotism he added absolute

honesty, that rare quality in a vizier, for he left office as poor as when he entered it.

(G. F. B.)

MIDHURST, a market town in the north-western parliamentary division of Sussex, England, 12 m. N. by E. of Chichester by the London, Brighton & South Coast railway; served also by the London & South Western railway. Pop. (1901), 1674. It is pleasantly situated on slightly rising ground near the river Rother. The church of St Mary Magdalen and St Denis is a large Perpendicular building. The town retains several picturesque old houses, and in the vicinity, by the river, are the ruins of the 16th century mansion of Cowdray, burnt down in 1793. A grammar-school was founded at Midhurst in 1672 and attained some eminence. After being closed for many years it was reopened in 1880. In 1906 a magnificent sanatorium for consumptives was opened about 4 m. from Midhurst; it bears the name of King Edward VII., who laid its foundation stone and opened it.

The name of Midhurst (Middeherst, Mudhurst) first occurs in the reign of Henry I. when Savaric Fitz-Cana held it of the honour of Arundel, then presumably in the king's hands. The charter of Henry I., although no longer extant, is quoted in later confirmation charters of Richard I., Henry III., Edward III., and Richard II. Franco de Bohun inherited Midhurst from his uncle Savaric Fitz-Savaric, and the De Bohuns held the lordship until 1499 when Sir David Owen obtained it through his marriage with the daughter of the last male heir. He sold it to Sir William Fitz-William, from whom it passed to Sir Anthony Browne and descended to the viscounts Montague. Midhurst is definitely called a borough in the reign of Edward I., but the borough-court and market were probably in existence much earlier. It was governed by a bailiff, elected annually, until the office lapsed, probably early in the 19th century. In an act of 1883 it is mentioned as one of the towns which had long ceased to be municipal. No charter of incorporation is known. Midhurst returned two members to parliament from 1300-1301 till 1832, and from that date one member until 1885 when it was disfranchised. In the reign of Henry VI. a market was held by the burgesses every Thursday, and a fair on Whit-Tuesday, by grant from Sir John Bohun. In 1888 the fair-days were the 6th of April, the 9th of May and the 29th of October. The market-day was Thursday. Pleasure-fairs are still held on the 6th of April and the 29th of October, but there is no market.

MIDIAN (properly Madyān, so Sept.), in the Bible, one of the peoples of North Arabia whom the Hebrews recognized as distant kinsmen, representing them as sons of Abraham's wife Keturah ("incense"). Thus the sons of Keturah are the "incense-men," not indeed inhabitants of the far south incense-land, but presumably the tribes whose caravans brought the incense to Palestine and the Mediterranean ports. So the Midianites appear in connexion with the gold and incense trade from Yemen (Isa. lx. 6), and with the trade between Egypt and Syria (Gen. xxxvii. 28, 36). They appear also as warriors invading Canaan from the eastern desert, and ravaging the land as similar tribes have done in all ages when Palestine lacked a strong government (see GIDEON). Again, they are described as peaceful shepherds, and the pastures of the Midianites, or of the branch of Midian to which Moses's father-in-law (Jethro or Reuel, or Hobab) belonged, lay near Mount Horeb (Exod. iii. 1). The Kenites who had friendly relations with Israel, and are represented in Judg. i. 16, iv. 11, as the kin of Moses's father-in-law, appear to have been but one fraction of Midian which took a separate course from their early relations to Israel.¹ Balaam, according to one version of the story, was a Midianite (Num. xxii. seq.) and his association with Moab has been connected with the statement in Gen. xxxvi. 35, that the Edomite king Hadad defeated Midian in the land of Moab; (see BALAAM, EDOM).

¹ The admixture of Midianite elements in Judah and the other border tribes of Israel is confirmed by a comparison of the names of the Midianite clans in Gen. xxv. 4 with the Hebrew genealogies (1 Chron. ii. 46, Ephraim; iv. 17, Ephraim; Gen. xlvii. 9, Hanoch). Ephraim is also associated with 'Ofir near Hanākiya (Hanoch), three days north from Medina, also with Appar a Bedouin locality mentioned by Assur-bani-pal. Ephraim is probably the Hayapa transported by Sargon to Beth-Omri (Samaria).

A place Midian is mentioned in 1 Kings xi. 18, apparently between Edom and Paran, and in later times the name lingered in the district east of the Gulf of Akaba, where Eusebius knows a city Midiam in the country of the Saracens and Ptolemy (vi. 7) places Modiana. Still later Madyan was a station on the pilgrim route from Egypt to Mecca, the second beyond Aila (Elath). Here in the middle ages was shown the well from which Moses watered the flocks of Sho'aib (Jethro), and the place is still known as "the caves of Sho'aib." It has considerable ruins, which have been described by Sir R. Burton (*Land of Midian*, 1879).

This district which has on its east Taimā, a centre of civilization in the 5th century B.C., and on its south-east El-'Olā whose existence as a seat of culture is possibly even older, is identified by some scholars with the Muṣrān of the Minaean (south Arabian) inscriptions, on which see SABAEANS, YEMEN. That this part of north-west Arabia had frequent intercourse with Palestine appears certain from its commercial relations with Gaza; and the association of the Midianite Jethro with early Hebrew legislation, as also the possibility that Mizraim ("Egypt") in the Old Testament should be taken in some cases to refer to this district, have an important bearing upon several Old Testament questions. See MIZRAIM.

MIDLETON, WILLIAM ST JOHN PREMANTLE BRODRICK, 9TH VISCOUNT (1856–), English politician, was the son of the 8th viscount (1830–1907). He came of a Surrey family who in the 17th century, in the persons of Sir St John Brodrick and Sir Thomas Brodrick, obtained grants of land in the south of Ireland. Sir St John Brodrick settled at Middleton, between Cork and Youghal in 1641; and his son Alan Brodrick (1660–1728), speaker of the Irish House of Commons and lord chancellor of Ireland, was created Baron Brodrick in 1715 and Viscount Middleton in 1717 in the Irish peerage. In 1796 the title of Baron Brodrick in the peerage of the United Kingdom was created. The English family seat at Peper Harow, near Godalming, Surrey, was designed by Sir William Chambers. The 8th viscount was a Conservative in politics, who for a few years had a seat in the House of Commons, and who was responsible in the House of Lords for carrying the Infants Protection Act. His brother, the Hon. G. C. Brodrick, was for many years warden of Merton College, Oxford. As Mr St John Brodrick, the 9th viscount had a distinguished career in the House of Commons. After being at Eton and Balliol, Oxford, and serving as president of the Oxford Union, he entered parliament as conservative member for one of the Surrey divisions in 1880. From 1886 to 1892 he was financial secretary to the war office; under secretary for war, 1895–1898; under secretary for foreign affairs, 1898–1900; secretary of state for war, 1900–1903; and secretary of state for India, 1903–1905. He lost his seat for the Guildford division of Surrey at the general election of January 1906. In March 1907 he was made an alderman of the London County Council. He married, first in 1880, Lady Hilda (d. 1901), daughter of the 9th earl of Wemyss, by whom he had a family; and secondly in 1903, Madeleine Stanley, daughter of Lady St Helier by her first husband.

MIDLETON, or **MIDDLETON**, a market town of Co. Cork, Ireland, on the river Owenacurra, 13 m. E. of Cork by the Youghal branch of the Great Southern & Western railway. Pop. (1901), 3361. The river here enters a branch of Cork harbour. The surrounding hilly country is pleasant and fertile, and furnishes the town with a good agricultural trade. There are also whisky-distilleries. Ballinacurra, 1½ m. south on the estuary, serves as a small port. The grammar school was founded in 1606, and here among its students were John Philpot Curran and Isaac Butt. Middleton is governed by an urban district council.

MIDNAPORE, a town and district of British India, in the Burdwan division of Bengal. The town is 68 m. W. of Calcutta; it has a station on the Bengal Nagpur railway. Pop. (1901), 33,140. It is an important centre of trade, being the terminus of a navigable canal to Calcutta, and also the junction for the Sini branch of the Bengal-Nagpur railway. There are manufactures of brass and copper wire. It has an American mission, a municipal college, and a public library founded in 1852.

The DISTRICT OF MIDNAPORE has an area of 5186 sq. m. The general appearance is that of a large open plain, of which the greater part is under cultivation. In the northern portion the soil is poor, and there is little wood. The country along the western boundary, known as the Jungle Mahals, is undulating and picturesque; it is almost uninhabited. The eastern and south-eastern portions are swampy and richly cultivated. The chief rivers of the district are the Hugli and its three tributaries, the Rupnarayan, the Haldi and the Rasulpur. The Midnapore high-level canal used also for irrigation runs almost due east and west from the town of Midnapore to Ulubaria on the Hugli 16 m. below Calcutta, and affords a continuous navigable channel 53 m. in length. There is also a tidal canal for navigation, 26 m. in length, extending from the Rupnarayan river. The district is traversed as well by the Bengal-Nagpur railway towards Orissa, with a branch to Chota Nagpur. The jungles in the west of the district yield lac, tussur, silk, wax, resin, fire-wood, charcoal, &c., and give shelter to large and small game. The principal exports are rice, silk and sugar; and the chief imports consist of cotton cloth and twist. Salt, indigo, silk, mats and brass and copper utensils are manufactured. Both silk and indigo are decaying industries. The population in 1901 was 2,789,114, showing an increase of 6% in the decade.

The early history of Midnapore centres round the ancient town of Tamluk, which in the beginning of the 5th century was an important Buddhist settlement and maritime harbour. The first connexion of the English with the district dates from 1760, when Mir Kasim ceded to the East India Company Midnapore, Chittagong, and Burdwan (then estimated to furnish one-third of the entire revenue of Bengal) as the price of his elevation to the throne of Bengal on the deposition of Mir Jafar.

MIDRASH, a very common term in Jewish writings for "exposition" and a certain class of expository literature. The word also occurs twice in the Old Testament (2 Chron. xiii. 22, xxiv. 27; R.V. rather poorly "commentary").

1. *Introduction*.—The term (Heb. *midrāsh* from *dāraṣh* "to search out, enquire") denotes some explanation or exposition, which, in contrast to the more literal exegesis (technically called *pēshat* "simple"), endeavours to reach the spirit lying below the text. It may be defined as a didactic or homiletic development of some thought or theme, characterized by a more subjective, imaginative and ampliative treatment. Jewish Midrash falls broadly into two classes: *Halaka* (q.v.) or *Hālakā* (walking, way, conduct) and *Haggādah* (narrative, with a purpose), homily; Aramaic equivalent *Aggādah*; the incorrect form *Agadah* rests upon a mistaken etymology). The former dealt with legal and ritual matters; it flourished in the schools and developed into the most subtle casuistry. The latter covered all non-halakic exposition and was essentially popular. It embraced historical and other traditions; stories, legends, parables and allegories; beliefs, customs and all that may be called folk-lore. It fed itself, not upon the laws, but upon the narrative, the prophetic and the poetical writings of the Old Testament, and it had a more spiritual and ethical tone than the Halaka. In both classes, accepted tradition (written or oral) was reinterpreted in order to justify or to deduce new teaching (in its widest sense), to connect the present with a hallowed past, and to be a guide for the future; and the prevalence of this process, the innumerable different examples of its working, and the particular application of the term Midrash to an important section of Rabbinical literature complicates both the study of the subject and any attempt to treat it concisely.¹ Apart from the popular paraphrastic translations of the Old Testament (see TARGUM), the great mass of orthodox Rabbinical literature consists of (1) the independent Midrāshim, and (2) the Mishna which, with its supplement the Gemārā, constitutes the Talmud. Both contain Halaka and Haggada, although the Mishna itself is essentially Halaka, and the Midrashim are more especially Haggadic; and consequently further information bearing upon Midrash must be sought in the art. TALMUD. These two articles

¹ For a careful study of the meaning of the term, see W. Bacher, *Jew. Quart. Rev.* IV. 406–429.

handle one of the most famous bodies of ancient literature, which, in its turn, has given rise to innumerable Jewish and non-Jewish works, and has many points of value and interest which cannot be adequately discussed here. It must suffice, therefore, to deal rather broadly with the subject, and to refer for fuller details to the special encyclopaedias, viz.: Hamburger's *Real-Encyc. für Bibel und Talmud*, and the very elaborate articles in the *Jewish Encyclopedia*.

2. *Narrative Midrash*.—Of the three different kinds of historical writing—the genetic or scientific, the purely narrative and the pragmatic—it is the last which has prevailed among religious historians. It is extremely difficult to avoid the subjective element in dealing with matters of fact, and the religious treatment of history is influenced, however unconsciously, by the mental environment of the writers. In giving greater prominence to events of religious importance and to their bearing upon the spiritual needs of contemporaries they view and interpret the past in a particular light, and will see in the past those growths which only in their own time have become mature. A latent significance is found, a particular connexion is traced, and a continuity is established, the true nature of which must be tested by critical students. Now, it is subjective history which we find in the earliest references to Midrash. The Midrash of the prophet Iddo (2 Chron. xiii. 22) like the Visions and the Histories of Iddo and Semaiah (ix. 29, xii. 15) which are quoted for the lives of Solomon, Abijah and Jeroboam, are evidently quite distinct from the sources cited in the parallel portions of the earlier compilation, and the entire spirit of the narratives is different. Similarly, there is a conspicuous difference of treatment of the life of Joash in 2 Kings xi. seq., compared with 2 Chron. xxiii. seq., which refers to some Midrash of the Book of the Kings (xxiv. 27). Although it is uncertain whether this comprehensive Midrash also included the "books of the Kings" (xvi. 11, xxvii. 7, &c.), and the Midrash of Iddo and other related works, it is clear that the Book of Chronicles (*q.v.*) marks a very noteworthy advance upon the records in the (canonical) Book of Kings (*q.v.*). It is now recognized that the compiler of the former has used many novel narratives of a particular edifying and didactic stamp, and scholars are practically unanimous that these are subsequent to the age of the Israelite monarchy and present a picture of historical and religious conditions which (to judge from earlier sources) is untrustworthy. At the same time various details (as comparison with the Book of Kings shows) are relatively old and, on a priori grounds, it is extremely unlikely that the unhistorical elements are necessarily due to deliberate imagination or perversion rather than to the development of earlier traditions. The religious significance of the past is dominant, and the past is idealized from a later standpoint; and whether the narratives in Chronicles are expressly styled Midrash or not, they are the fruit of an age which sought to inculcate explicitly those lessons which, it conceived, were implied in the events of the past. The value of the book lay not in history for its own sake, but in its direct application to present needs. But the tendency to reshape history for the edification of later generations was no novelty when Chronicles was first compiled (about 4th cent. B.C.). Pragmatic historiography is exemplified in the earliest continuous sources (viz. of the "Deuteronomist" writers, *i.e.* allied to Deut., especially the secondary portions); and there are many relatively early narratives in which the details have been modified, and the heroes of the past are the mouthpiece for the thought of a later writer or of his age. Numerous instructive examples of the active tendency to develop tradition may be observed in the relationship between Genesis and the "Book of Jubilees," or in the embellishments of Old Testament history in the *Antiquities* of Josephus, or in the widening gaps in the diverse traditions of the famous figures of the Old Testament (Adam, Noah, Enoch, Abraham, Moses, Isaiah, Ezra, &c.), as they appear in non-canonical writings. In such cases as these one can readily perceive the different forms which the same material elements have assumed, and one may distinguish the unreliable accretions which are clearly later and secondary. Accordingly, when

there are narratives which cannot be tested in this manner, should they show all the internal marks of didactic expansion and date from an age much later than the times with which they deal, their immediate value will not necessarily lie in the details which appear to be of historical interest, but in their contribution to later forms of tradition and phases of thought. So far then, Midrash tends to include moralizing history, whether we call it narrative or romance, attached to names and events, and it is obviously exemplified whenever there are unmistakable signs of untrustworthy amplification and of some explicit religious or ethical aim colouring the narrative. This, however, is only one of the aspects which have to be taken into consideration when one advances to the Rabbinical Midrash.

For Old Testament "Midrash" see further K. Budde, *Zeitschr. f. alt-test. Wissenschaft*, xii. 37, seq., and commentaries on Chronicles (*q.v.*). The elaborate study by the Jewish scholar Zunz (*Die gottesdienstlichen Vorträge*, ch. viii.) is also valuable for bridging the gulf between the canonical and the non-canonical traditions and for its just attitude to the criticism of historical traditions. The rigid line between fact or fiction in religious literature, which readers often wish to draw, cannot be consistently justified, and in studying old Oriental religious narratives it is necessary to realize that the teaching was regarded as more essential than the method of presenting it. "Midrash" which may be quite useless for historical investigation may be appreciated for the light it throws upon forms of thought. Historical criticism does not touch the reality of the ideas, and since they may be as worthy of study as the apparent facts they clothe, they thus indirectly contribute to the history of their period. In any case, while the true historical kernel of the Midrashic narrative (*e.g.* dealing with Adam, Moses or Isaiah) will always be a matter of dispute, the teaching to which it is applied stands on an independent footing as also does the application of that teaching to other ages.

3. *Continuity of Literature and Material*.—Amid obscure vicissitudes in the 7th to 5th centuries, B.C., the Canonical books of the Old Testament gradually began to assume their present shape (see PALESTINE: *History*). The internal peculiarities show that the compilations are the much edited remains of a larger body of literature, and it may reasonably be supposed that the older sources did not at once perish. There is literary critical evidence for late insertions by exilic or later compilers; the compiler of Chronicles apparently refers to accessible works; and there is a close material relationship between the Old Testament and later literature. All this suggests that Old Hebrew writings, apart from those preserved in the Canon, persisted to a relatively late period. No a priori distinction can be made and no precise chronological line can be drawn between the books of the Canon (Canticles, Ecclesiastes, Esther, Ezekiel and Proverbs had been at one time or another subjects of debate among the Rabbis) and the Apocrypha (Ecclesiasticus, Judith, Maccabees and Tobit, were "allowed"); and the intimate relation between them appears in the character of the "Wisdom Literature" (*e.g.* Proverbs, and the Wisdom of Solomon), in the treatment of the stories of Esther and Daniel (the history of Susanna), and also in the twofold recensions Ezra and 1 Esdras. Historical or narrative Midrash is exemplified in the "canonical" books Daniel, Esther, Jonah and Ruth, and in the "apocryphal" stories of Daniel (viz. Susanna, where the point lies in the name Daniel "God is judge"), Esther, Judith, Tobit (the Ahioq cycle of stories), the story of Zerubbabel (1 Esd. iii. seq., the sequel of which belongs to the canonical Ezra), and the martyrdom of Eleazer (2 Macc. vi. seq., compare 4 Macc.). This is not the place to notice the course of Jewish literary activity in Palestine or Alexandria, whether along the more rigid lines of Pharisaic legalism (the development of the canonical "priestly" law), or the popular and less scholastic phases, which recall the earlier apocalyptic tendencies of the Old Testament and were cultivated alike by early Jewish and Christian writers. But after the fall of Jerusalem, partly through the need for systematizing the traditional post-biblical law, and partly through disputes with the Christians, orthodox Rabbinism received the stamp which has since characterized it. The traditional or oral law was codified in the Mishna (see TALMUD, § 1 seq.), the Canon was

¹ *E.g.* Judg. i. (see G. F. Moore, *Ency. Bib.*, "Historical Lit.," col. 2085, middle), 2 Sam. ix.—xx., &c.

fixed, and the fluctuations in the MSS. of the Old Testament (which, like the numerous variations in the Septuagint, complicated exact exegesis) gave way to what was virtually a single text. Moreover, the important body of apocryphal and pseudepigraphical literature, with all its links between Christianity and Judaism, fell into disfavour on both sides. This literature is especially valuable because it illustrates contemporary Halakha and Haggada, and it illuminates the circle of thought with which Jesus and his followers were familiar; it thus fills the gap between the Old Testament and the authoritative Rabbinical Midrashim which, though often in a form several centuries later, not rarely preserve older material.¹

A few miscellaneous examples of related Midrashic material may be cited:—

i. The book of Jubilees (a haggadic and halakic Midrash on Genesis, about 2nd century B.C.), contains the story of the war between Amorite Kings and Jacob (ch. xxiv.). This is known to the probably contemporary Testament of Judah and to much later Midrashim (*Mid. Wayyisā'u, Yalqut Shimoni*, also the apocryphal "book of Jasher"), and is evidently connected with the cryptic allusion to the capture of Shechem in Gen. xviii. 22 (R.V. marg.). Unless we suppose that the latter was suddenly expanded into the stories which thenceforth persisted, it may be inferred that an old extra-canonical tradition (for which a case can be made) connected to survive the compilation of Genesis (g.c.) and ultimately assumed the various expanded forms now extant. Naturally the probability of such a tradition—the merest hint of which happens to be preserved in Gen. loc. cit.—does not prejudice the problem of its origin or accuracy; in Jub. the story is just for Jacob's history, and is probably influenced by a recollection of more recent events in the Maccabean age.

ii. A curious account of war between Egypt and Canaan after Joseph's death occurs in Jub. xli., *Test. of Simeon*, viii., and Benjamin vii., and is connected with details (burial of Jacob's sons at Hebron) recorded by Josephus (*Ant. J.*). Josephus in turn has another story wherein Moses leads the Egyptians against Ethiopia (*Ant. J.* 10, for parallels see Moore, *Ency. Bib.* col. 2089 seq.), and this is found in the late chronicles of Jerahmeel and the Book of Jasher (cf. also *Mid. Dibre ha-yamim shel-Moses*; see *Jew. Ency.* viii. 573 seq.). The former may be linked with Gen. I. 9 (where the concourse of chariots and horsemen would invite speculation), and the latter with the Cushite wife of Moses; but although one may grant that the canonical sources do not by any means preserve all the older traditions, the contents of the latter cannot be recovered from the later persisting Midrashim.

iii. The allusion in Jud. v. 9 to the contention of the archangel Michael for the body of Moses belongs to a group of traditions which have been collected by R. H. Charles (*Assumption of Moses*, pp. 105 seq.), and it appears that the incident was familiar to Clement of Alexandria, Origen and other early writers. Moreover, Jud. v. 16 agrees very closely with the Latin version of the Testament of Moses, which has other parallels in Matt. xxiv. 29; Acts vii. 36, 38 seq. (*ibid.* pp. lxxi. seq.). Here may be added Jannes and Jambres, who withstood Moses (2 Tim. iii. 8); these or related names were known to the elder Pliny (xxx. i. 11), Apuleius (first half of 2nd century), Origen (who refers to a book of Jannes and Mambres), and various earlier and later Jewish sources; see I. Abrahams, *Ency. Bib.* col. 2327 seq.; H. St. J. Thackeray, *Relation of St Paul to contemporary Jewish thought* (London, 1900), pp. 215 seq.

iv. Jewish traditions of Abraham in Ur of the Chaldees recur in the Targums, Midrashic works, and earlier in the book of Jubilees (ch. xii., ed. Charles, p. 91; cf. also Judith v. 6 seq.). The legends of his escape from a fiery furnace may have a philological basis (as interpreted at "f")², but the allusion to the redemption of Abraham in Isa. xlii. 22 seems to indicate that older tradition was fuller than the present records in Genesis, and supplies another example of the link connecting the Old Testament with Rabbinical thought.

v. Not to multiply examples further, it may suffice to refer to (a) the apparent belief that the serpent tempted Eve to unchastity (2 Cor. xi. 2, seq.; see Thackeray pp. 50 seq.); (b) the descent of the angels upon earth (Gen. vi. I seq.; Jud. 6, 14 seq.; see Charles, *Jub.* p. 33 seq., Clermont-Ganneau, *Quart. Statements of the Pal. Explor. Exped.* 1903, pp. 233 seq., and the *Midr. Abot*, see *Jew. Ency.* viii. 572); (c) the relationship between the Midrashic developments of the story of Esther in Josephus, the Greek and Old Latin Versions, the Targums and later Jewish sources (see L. B. Paton, *Comm. on Esther*, pp. 20, 100 and *passim*); and finally (d) the numerous minor miscellaneous parallels noticed in recent annotated editions of the

¹ On the history of his intermediate stage see E. Schürer, *Hist. of Jew. People* (Edinburgh, 1886), *Germs. Gesch. Jüd. Volkes*; M. Friedländer, *Relig. Bewegungen innerhalb des Judentums im Zeitalter Jesu* (Berlin, 1905); W. Fairweather, *Background of the Gospels* (Edinburgh 1908). See also APOCRYPHAL LIT. and APOCRYPHAL LIT.

² See also the allusion to the wisdom of Moses in Acts vii. 22, upon which contemporary writings are pretty well informed.

pseudepigraphical literature (especially those of R. H. Charles). (See further TALMUD, § 5.)

4. *Midrashic Exposition*.—The Talmud poetically describes Midrash as a hammer which wakes to shining light the sparks which slumber in the rock; and the simile is a happy one when one considers the exegetical implements, the workmen and their workmanship. For the expository or interpretative Midrash was bound up with rules and methods which often appear crude and arbitrary, they are nevertheless those of the age and they helped to build up lasting monuments.³ It was believed that the Written Word had an infinite fullness; according to the *Midr. Bemidbar Rabba* every word of the Law had seventy different aspects, and Philo of Alexandria held that there are no superfluous words in Scripture. Consequently an exaggerated emphasis is often laid upon single words; as, for example, in the school of Rabbi 'Aqiba, where even individual letters were forced to reveal their meaning. Thus, since the Hebrew *eth*, which marks the accusative, is also the preposition "with," Deut. x. 20 ("thou shalt fear [eth-] Yahweh thy God") was interpreted to include the veneration of the doctors of the law *along with* Yahweh.⁴ Many examples of literal interpretation can of course be found, but arbitrary cases of the kind just noticed are due either to an obviously far-fetched interpretation or to the endeavour to find some authoritative support for teaching which it was desired to inculcate. Thus faulty proof rather than faulty inference is illustrated when the word "in-number" (Ex. xii. 4) was used to confirm the Halakha that the man who killed the Passover Lamb must know how many people were about to share it (*Jew. Ency.* viii. 570). Often the biblical text cannot be said to supply more than a hint or a suggestion, and the particular application in Halakha or Haggada must be taken on its merits, and the teaching does not necessarily fall because the exegesis is illegitimate. To take another specimen: the *Mekilta* on Ex. x. 25 infers from the unusual form of the word "it," that the prohibition of iron applies only to *it*, i.e. the altar, and not to stones used in building the temple. This Halakha is followed by a haggadic explanation of the prohibition: "iron abridges life while the altar prolongs it; iron causes destruction and misery, while the altar produces reconciliation between God and man; and therefore the use of iron cannot be allowed in making the altar."⁵ Such were the sparks that could be hammered out of the rock, and it is instructive to observe similar exegetical methods in the New Testament. Emphasis upon a single word is illustrated by Gal. iii. 16, where the argument rests upon the word "seed" (and not the plural "seeds") in the proof-text, and the same word in Rabbinical writings is used to support other arguments.⁶ By identical kinds of exegesis Lev. xix. 14 (not to put a stumbling block before the blind) is the ground for cautioning a father against striking an adult child, and Deut. xxv. 4 (the law of the muzzled ox) is used to show that God's labourer is worthy of his hire.⁷ Again, since through Eve sin entered into the world, woman must be subordinate to man (1 Tim. ii. 11-14), or, she who has thus extinguished "the light of the world" should atone by lighting the festal candles on the sabbath (*Talm. Shabb. 5b*). By the allegorical method Isa. lxi. is interpreted as applying to Jesus (Luke iv. 16-22), and frequently passages which originally had another application have a Messianic reference in

³ For the Rabbinical "rules" and examples of their working see F. Weber, *Jüd. Theologie* (Leipzig, 1897), pp. 109-125; C. A. Briggs *Study of Holy Scripture* (Edinburgh, 1899), ch. xviii.; *Jew. Ency.* xii. 30-33; S. Schechter, *Hastings's Dict. Bible*, v. 59, 63; and H. J. Strack, *Einführung in den Talmud* (Leipzig, 1908), pp. 119-131.

⁴ So 'Aquila, the disciple of 'Aqiba, translates the accusative particle by *etw*; see W. R. Smith, *Old Test. in the Jew. Church*, p. 63.

⁵ Oesterley and Box, *Religion and Worship of the Synagogue* (London, 1907), p. 80; pp. 44-97 deal with Midrashic and other Jewish literature.

⁶ *Mish. Sanhed.* iv. 5, see A. Geiger, *Zeit. f. morgenländ. Gesellschaft*, 1858, pp. 307 seq.; S. R. Driver, *Expositor*, ix. (1889), p. 18 seq.

⁷ The Talmud *M'd'ed Ozañ*, 70, and New Testament (1 Cor. ix. 9, 1 Tim. v. 18) respectively.

Christian and Rabbinical teaching. Similarly the application of Hos. ii. 23, not to the scattered tribes of Israel, but to the Gentiles, is common to the Mishna and to Romans ix. 25 seq. (Sanday and Headlam, *Comment. ad loc.*) The Apostle Paul, once a disciple of the famous Rabbi Gamaliel, uses in 1 Cor. x. 4 ("the spiritual rock that followed them") a familiar Jewish Haggada which, however, he reinterprets, even as, when he identifies the "rock" with Christ, he diverges from the Alexandrian Philo who had identified it with Wisdom or the Word of God. Moreover, not only are passages thus taken out of their context, but they are combined, especially when they contain the same words or phrases, or appear to have the same or similar thoughts or aims. The Talmud, with a reference to Prov. xxxi. 14 ("she bringeth her food from afar"), says "the words of the Torah are poor (or deficient) in one place but rich in another." Hence in the *Mid. Siphre* on Numbers xv. 39, "ye shall not seek after . . . your own eyes" is explained to refer to adultery, after the words of Samson "she is pleasing in my eyes" (Judg. xiv. 3); and on Deut. vi. 5 it charges man to love the Lord "with all thy soul . . . even if he should take away thy soul," the teaching being based upon Ps. xlv. 22.¹ Similarly, in the New Testament, after the same method, Mal. iii. 1 and Is. xl. 3 (linked by the phrase "to prepare the way") are combined in Mark i. 2 seq.; Abraham's faith (Gen. xv. 6) and temptation (xxii. 1) are associated in James ii. 21-23, as also in contemporary Jewish thought; and by other combined quotations Paul enunciates the universality of sin (Rom. iii. 2 Cor. vi. 16 seq.). Proceeding upon such lines as these, the Jews wove together their Midrashic homilies or sermons where, though we may find much that seems commonplace, there are illuminating parables and proverbs, metaphors and similes, the whole affording admirable examples of the contemporary thought and culture, both of the writers and—what is often overlooked—the level of their hearers or readers. Like many less ancient discourses, the Midrashim are apt to suffer when read in cold print, and they are sometimes judged from a standpoint which would be prejudicial to the Old Testament itself. But they are to be judged as *Oriental* literature and if they contain jarring extravagances and puerilities, one may recall that even in modern Palestine it was found that the natives understood *Robinson Crusoe* as a religious book more readily than the *Pilgrim's Progress* (J. Robertson, *Early Rel. of Israel*, 1802, p. 66). In making allowance for the defects (without which they would probably not have appealed to the age) it must be remembered that some of the Rabbits themselves recognized that the Midrashic Haggada was not always estimable.

An interesting example of combined quotation is illustrated in Matt. xii. 4-8, where the teaching of Jesus on the law of the Sabbath rests upon 1 Sam. xxi. 1-6, Num. xviii. 9 seq. and Hos. vi. 6. Apropos of this law the Rabbinical arguments are worth noticing. Apparently the severe rules laid down in Jubilees 1. 8-12 (see R. H. Charles, *ad loc.*) were exceptional. It was allowed that the Sabbath need not be too rigorously kept, and this was justified by Exod. xxxi. 13, where the singular use of the restrictive particle *ah* ("EV" "verily") supported the teaching that other Sabbaths need not be observed. Also, from the words "holy unto you" (v. 14) it was taught that "the Sabbath is given to you to desecrate in case of need, but thou art not given to the Sabbath." Hence the Sabbath might be broken when life was in danger. Moreover, it was argued that a battle need not be stopped from religious considerations (Eg. the Sabbath. This was justified by Deut. xc. 20 "until it fall" (*Talm. Shabb. 100*). Also, the Passover Lamb could be sacrificed on the Sabbath, and justification for this was found in Num. ix. 2 "in its season" (*Pezsh. 66a*). See further on this subject, and on the evasions of the Sabbath law, S. Schechter, *Studies in Judaism*, 297 seq.; *ibid.* in C. G. Montefiore, *Hibbert Lectures* (for 1892), Appendix; *ibid.* *Hastings' Dict. Bib.* v. 63, and also S. R. Driver, *Hastings' Dict. iv.* 320 seq. With the above interpretations, cf. A. H. McNeile on Matt. xii. 5, John vii. 23: "the *à priori* element in them perhaps suggests that [these verses] were due to later reflexion on the part of Christians who had realized the inadequacy of the law" (*Swete's Camb. Bibl. Essays*, 1909, p. 226). For other examples illustrating Rabbinical methods of exegesis in the New Testament, see McNeile, pp. 221, 336 ("Our Lord's use of the Old Testament"); Briggs, *op. cit.* pp. 436,

394, and Thackeray, *op. cit.* (ch. vii. "use of the Old Testament," ch. viii. "St Paul the Haggadist"). The latter observes (p. 203): "the arguments by which Paul tried to convince his opponents of the true meaning of the Old Testament as pointing forward to Christ, are those which they would themselves have employed for another purpose; and to some extent we need not doubt that they were selected for that very reason. They were the arguments which were best calculated to appeal to them." Quite in accordance with Rabbinical custom in the system of question and answer (Rom. x. 5, seq., 16 seq.), and the argument in the sequence: statement, objection and reply, appears already in the book of Malachi (g.v.).

5. *The Jewish Midrashim*.—The earlier stages in the growth of the extant Rabbinical Midrashim cannot be traced with any certainty. Although there are several allusions to early written works, other references manifest an objection to the writing down of Haggada and Halaka. Perhaps it was felt that to preserve uniformity of teaching in the schools it was undesirable to popularize the extant collections, or perhaps the references must be reconsidered in the light of those significant changes after the fall of Jerusalem which have been mentioned above (§ 3).² However this may be, the independent Hälakóth (where the oral decisions are interpreted or discussed on the basis of the Old Testament) were gradually collected and arranged according to their subject in the Mishnah and Tosephtá (*TALMUD*, § 1), while in the halakic Midrashim (where the decisions are given in connection with the biblical passage from which they were derived) they follow the sequence of the text of the Old Testament. The Haggada was likewise collected according to the textual sequence of the Old Testament. But the sermons or discourses of the *homiletic* Midrashim are classified according to the reading of the Pentateuch in the Synagogue, either the three year cycle, or else according to the sections of the Pentateuch and Prophetic books assigned to special and ordinary Sabbaths and festival days. Hence the latter are sometimes styled *Pesiqta* ("section"). The homiletic Midrashim are characterized by (a) a poem, an introduction based upon some biblical text (not from the lesson itself), which led up to (b) the exposition of the lesson, the first verse of which is more fully discussed than the rest. They conclude (c) with Messianic or consolatory passages on the future glory of Israel. A feature of some Midrashim (e.g. nos. 4, *sd*, *e*, and 7 below) is the halakic exordium which precedes the poems.³

Among the more important Midrashim are: i.—*Mékhilla* (Aram. "measuring," i.e. "rule") best known as the name of a now imperfect halakic Midrash on Exod. xii.—xxiii. 19 (also xxxi. 12-17 and xxxv. 1-3). It represents the school of R. (Rabbi) Ishmael, is a useful source for old Haggadad (especially on the narrative portions of Exodut), and is interesting for its variant readings of the Canonical Massoretic text.⁴ Edited by Blasius UgoLinus, *Theas. Antiq. Sacr. vii.* (Venice, 1744, with a poor Latin translation), more recently by J. H. Weiss (Vienna, 1865) and M. Friedmann (*ibid.* 1870), Germ. trans. by J. Winter and A. Wünsche Leipzig, 1909). See further J. Z. Lauterbach, *Jew. Ency.* vii. 444 seq.

ii.—*Siphre* (Aram. "the books" or "of Torah Kóhánim" ("the law of the priests"), a commentary on Leviticus, mainly halakic, the text being a source for various maxims. (On Lev. xix. 17 seq., neighbourly love and abstinence from vengeance constitute, according to R. Aqiba, the great principle of the Torah.) It is useful for the interpretation of the Mishnah treatises *Qódashim* and *Téharóth*. Latin trans. in UgoLinus, vol. xiv.; recent editions by I. H. Weiss (Vienna, 1862), and with the commentary of Shimson (Samson) of Siens (Warsaw, 1866); see *Jew. Ency.* xi. 330 seq.

iii.—*Siphre* (Aram. "the books") an old composite collection of Halaka on Numbers, after R. Ishmael's school; and on Deut. after that of R. Aqiba, through the haggadic portions belong to the former. Latin in UgoLinus; recent edition, with good introduction by Friedmann (Vienna, 1864); see *Jew. Ency.* xi. 332 seq.

The above works, although of 5th century or later date in their present form, contain much older material, which was perhaps first redacted in the earlier part of the 2nd century, A.D. They are of

² See, on this point, *Jew. Ency.* vii. 549 seq., 552, 576; Schechter, *op. cit.* p. 62; Strack, *op. cit.* pp. 10, 90.

³ See more fully *Jew. Ency.* vii. 553. Cf. for the structure, the hopeful concluding notes in the prophecies (e.g. Amos) and the discourse after the reading of the lesson from the prophets in Luke iv. 17 seq., Acts xiii. 15 seq.

⁴ See I. Abrahams in Swete's *Cambridge Bibl. Essays* (1909), pp. 174, 180.

¹ Cited by S. Schechter, *Hastings, Dict. Bible*, v. 64.

Palestinian origin, although the main redaction was made in Babylonia.¹

iv. *Tanḥūmā*, one of the oldest on the lessons of the Pentateuch, with many proems ascribed to R. Tanḥūmā ben ("son of") Abba, one of the most famous haggadists of Palestine (4th century), who systematized and fixed the haggadic literature. This collection of 158-161 homilies is also known as *T. Yedamānā*, from the opening words *u'd. Rabbēnū*, "our Rabbi teaches us"; on the critical questions connected with the titles and the present redaction (probably 5th century), see *Jew. Ency.* viii. 560 seq., xii. 44 sqq. Recent edition by Buber (Wilna, 1885).

v. *Midrash Rabbah* (or *Rabbah*), a large collection of very diverse origin and date, probably not completed before the 13th century. It covers the Pentateuch (1st ed., Constantinople, 1512) and the "Five Rolls" (Pesaro, 1519; the whole printed first at Venice, 1545); Germ. trans. by A. Wünsche, *Bibliotheca rabbinica* (Leipzig, 1880-1885). The several portions are named after the ordinary Jewish titles of the Old Testament books with the addition of *Rabbah* "great." These are (a) *Bēreshith* ("in the beginning," Gen. i. 1) *Rabbah*, on Genesis, the oldest and most valuable of haggadic Midrashim. Traditionally ascribed to R. Hōshaiāh (3rd century), but in the main a redaction of 6th century. Ed. J. Theodor; see *Jew. Ency.* iii. 62 seq.; viii. 557 seq. (b) *Shemōth* ("names" Exod. i. 1) *R.*, a composite and incomplete work of 11th and 12th century date, but valuable nevertheless for its Tanḥūmā homilies. Exod. i. xi. is a commentary on the text in continuation of (a); see *Jew. Ency.* viii. 562 (c) *Yisra'el* ("I will be called" R. Leviticus, compare also *T. Yedamānā*, from the opening words *u'd. Rabbēnū*). It is characterized by its numerous proems (e.g. on xix. 6: "do not care for the good pup of a bad dog, much less for the bad pup of a bad dog"). See *Jew. Ency.* viii. 560, xii. 478 seq. (d) *Beamidbar* ("in the desert of . . .") *R.*, 33 homilies on Numbers, mainly derived from 4 above (though in an earlier text), with a later haggadic exposition, perhaps of 12th century, on Num. i. 1-7. See *Jew. Ency.* i. 669 sqq., vii. 562. (e) *Dēbarim* ("words") *R.*, independent homilies on Deuteronomy, of about A.D. 10, but with a good collection of Tanḥūmā and excerpts from the old sources. See *Jew. Ency.* iv. 487 seq. (f) *Shir* ("song") *R.*, or after the opening words *Aggadath Haitha*, a life compilation of haggadah on Canticles, illustrating the allegorical interpretation of the book in reference to the relation between God and Israel (so already in the exegesis of R. Aqiba, cf. also 2 Esd. v. 24, 26, vii. 26). For this and other Mid. on this popular book, see *Jew. Ency.* vii. 564 seq., xi. 291 seq. (g) *Mid. Ruth* or *Ruth Rabbah*, a compilation including an exposition of 1 Chron. iv. 21-23, xi. 12-15 and interesting Messianic references. For this and similar *Mid.* or *Ruth*, see *Jew. Ency.* viii. 565, xi. 577 seq. (h) *Ekah* ("how") *Rabbah*, a compilation of about the 7th century on Lamentations, from sources cited also in the Palestinian Talmud. Thirty-six proems precede the commentary. See *Jew. Ency.* v. 85 seq. (i) *Mid. Kohelēth* or *Koh. Rabbah*, on Ecclesiastes; see *Jew. Ency.* vii. 529 seq., viii. 565. (j) *Mid. Megillath Esther*, dating, to judge from its indebtedness to Josippon (the pseudo-Josephus), after 10th century. On this and other similar works dealing with this ever-popular book, see *Jew. Ency.* v. 241, viii. 566, and Paton's Comment. on Esther, p. 104.

vi. *Pesiqṭā* ("section") or *P. de-Rab Kahana*, contains 33 or 34 homilies (on the principal festivals), the first of which opens with a sentence of R. Abba bar Kahana, who was confused with a predecessor, Rab Kahana. Although it goes back to early Haggada it has received later additions (as is shown by the technique of the proems). Edited by S. Buber (Lyck, 1868). Germ. trans. by A. Wünsche (Leipzig, 1885); see *Jew. Ency.* viii. 559 seq. Not to be confused with this is:—

vii. *Pesiqṭā Rabbāthi*.—A very similar but larger collection of 51 homilies, of which 28 have a halakic exordium prefixed to the Tanḥūmā-proems, perhaps of 9th century. Edited by M. Friedländer (Vienna, 1882). Quite another and later work is the *Pes. Zuhāra* or *Leqah Tōb* of Tobiah b. Eliezer of Mainz (trans. Uginolus, vol. xv. seq.; ed. Buber, 1880); see *Jew. Ency.* viii. 561 sqq.

viii. In addition to the more prominent Midrashim mentioned above there are numerous self-contained works of greater or less interest. Some are connected with Old Testament books; e.g. *Aggadath Bereshith*, 83 homilies on Genesis, each in three parts connected with the prophecies from the lectionary of the Pentateuch, and one from the Prophets, and a Psalm (ed. Buber, Cracow, 1903; see *Jew. Ency.* viii. 563); the *Mid. Tehillim* on the Psalms (Germ. trans. Wünsche, Trier, 1892-1893), &c. Others are historical, e.g. *Pirge* or *Baraita de-Rabbi Eliezer*, a fanciful narrative of events

selected from the Pentateuch, &c.; the eschatology is interesting. Though associated by name with a well-known 1st century Rabbi, it is hardly earlier than the 8th (Latin trans. by Vorstius, Leiden, 1644; see *Jew. Ency.* viii. 567). Further, the *Megillath Ta'anith* ("roll of fasts"), an old source with a collection of miscellaneous legends, &c. *Megillath Antiochos*, on the martyrdom under Hadrian; *Sefer Olam Rabbah*, on biblical history from Adam to the rebellion of Bar Kokba (Barcocheba); the "Book of Jasher"; the Chronicle of Jerahmeel"; &c. Liturgical Midrash is illustrated by the *Haggada shel Pesah*, part of the ritual recited at the domestic service of the first two Passover evenings. In *Mid. Ta'ame Hāsērah we-Yehērah*, Hebrew words written "defectively" or "fully" and other Messianic details, are haggadically treated. Finally Kabbalah (q.v.) is exemplified in *Ohivōth de R. Aqiba* on the alphabet, and *M. Tašhe* (or *Baraita de-R. Phinehas b. Yūyū*), on groups of numbers, &c.; of some interest for its relation to the book of Jubilees.

ix. Of collections of Midrash the chief are (a) *Yalqūt Shimonei*, which arranges the material according to the text of the Old Testament (extending over the whole of it), preserves much from sources that have since disappeared, and is valuable for the criticism of the text of the Midrashim (recent ed. Wilna, 1898) translation of the Yalqūt on Zechariah by E. G. King (Cambridge, 1882; see further *Jew. Ency.* xii. 585 seq.). (b) *Yal. ha-Makri*, perhaps later, covers only certain books, is useful for older sources and their criticism; portions have been edited by Spira (1894, on Isaiah); Buber (1899, on Psalms); Grünhut (1902, on Proverbs). (c) *Midrash ha-Gdāl* ("the great"), an extensive thesaurus, but later (quoting from Ibn Ezra, Maimonides, &c.); the arrangement is not so careful as in (a) and (b). See further *Jew. Ency.* viii. 568 seq.

Of modern collections special mention must be made of A. Jellinek's *Bet ha-Midrash* (Leipzig, 1853) and A. Wünsche's valuable translations; to those already mentioned must be added his *Aus Israels Lehrhallen* (excerpts of a more miscellaneous character (Leipzig, 1907 sqq.).

Sides dictionary articles on this subject (S. Schiller-Sinnessy, *Ency. Brit.*, 9th ed.; H. L. Strack, *Real-Ency. f. Protest. Theol. u. Kirche*; and especially J. Theodor and others in the *Jew. Ency.*), see D. Hoffmann, *Zur Einleitung in die halachischen Midraschim* (Berlin, 1888), and the great work by Zunz, *Die gottesdienstlichen Vorträge der Juden*, 2nd ed. by N. Brill (Frankfurt on Main, 1892). These, as also the citations in the course of this article, give fuller information. (See further TALMUD.) (S. A. C.)

MIDSHIPMAN, the title in the British and American navies of the "young gentlemen" who are serving in order to qualify themselves to hold a commission as lieutenant. The English midshipman was originally a petty officer, one of the crew under the immediate orders of the boatswain. After the restoration of King Charles II., in 1660, the king and his brother, James Duke of York, lord high admiral, decided to train officers for the sea service. They therefore decided to send a volunteer to each ship of a squadron in commission, with a "letter of service," which instructed the admirals and captains that the bearer was to be shown "such kindness as you shall judge fit for a gentleman, both in accommodating him in your ship and in furthering his improvement." He was to receive the pay of a midshipman, and one midshipman less was to be borne in the ship. Until 1729 the young gentlemen who entered the British navy were known as "king's letter boys." In that year the system was altered. A school, known as the naval academy, was founded at Portsmouth in which forty lads were to be trained for the sea service. In 1773 the school, having proved unsatisfactory, was reorganized and the number of boys to be trained there increased from forty to seventy. In 1806 it was again reorganized, under the name of the naval college, and was finally suppressed in 1837, when the practice of training the boys under instructors in the ships was introduced. A special school was re-established in 1857, and was finally placed in the "Britannia." In the meantime the number of midshipmen had increased far beyond one for a ship. A line-of-battle ship in the 18th century carried as many as twenty-four, and the title had come to be confined entirely to those who were being trained as officers. The immense majority of officers of the British navy never passed through the academy or the college. They entered the ships directly as "captains' servants" or "volunteers," and were rated midshipman, if there was a vacancy, at the age of fifteen. As they were expected to learn navigation, they were instructed by the master, and at the age of seventeen were supposed to be qualified to be masters' mates. To-day the midshipman is the officer of the British and American navies who has passed through the

¹ They contain (as I. Abrahams has pointed out to the present writer) a good deal of haggada, but far more halakic material than those which follow. The latter (nos. 4 sqq.) also contain halakic, but the chief contents are haggadic and homiletical.

² I. Abrahams points out to the writer that the rest is more summary. This difference is accounted for by the fact that Exod. xii. onwards and the rest of the Pentateuch have independent Midrashim: the Law proper was held by the Rabbis to begin at Exod. xii.

preliminary schools and has been appointed to a ship. The French equivalent is *aspirant*, and other European navies use that name, or *cadet*.

MIDSOMER NORTON, an urban district in the northern parliamentary division of Somersetshire, England, 12½ m. S.S.W. of Bath, on the Somerset & Dorset and the Great Western railways. Pop. (1901), 5800. The town is pleasantly situated in a hilly district, between two branches of the small river Somer. The church of St John the Baptist, principally Perpendicular, has in its tower three bells presented by Charles II. Both this town and the adjacent urban district of RADSTOCK (pop. 3355) have a considerable trade in coal, which is mined in the vicinity. The coalfield extends north-westward towards Bristol, and is of great importance to the manufactures of that city.

MIDWIFE (Mid. Eng. *midwif*, *mydwif* or *medewife*, from preposition *mid*, with, and *wife*, i.e. woman, in the sense of one who is *with* the mother, or from adjective *mid*, one who is the means of delivering the mother, a woman who assists other women in childbirth). As a class, midwives were recognized in Egypt in the time of the Jewish captivity. It was the universal practice in Europe until the middle of the 16th century, as it is to-day in the East, that women should be attended in confinement only by those of their own sex. From that period more attention was given to the practice of midwifery by the medical profession (see OBSTETRICS), while in continental Europe, towards the close of the 17th century, special schools were instituted for the proper training of midwives. But it was not until well on in the 19th century that any supervision or regulation was imposed on those who acted as midwives. Now in practically every European country midwives are under strict state control, they are required to undergo a course of thorough training, and their practice is carefully regulated by legislation.

In France midwives (*sages femmes*) are divided into a first and a second class. Those qualifying for both classes go through a two-year course of training and must qualify both in theory and practice of midwifery, as well as in anatomy, physiology and pathology. A midwife of the first class has a superior status and can practise in any part of France, while those of the second class are restricted in their practice to the department for which the certificate was issued. Their qualifications allow them also to vaccinate and to prescribe certain antiseptic preparations. They are not allowed to use instruments and must call in a medical man in difficult cases. All cases must be reported to a central officer. In Spain midwives are allowed to practise on the result of an examination after studies covering at least four half-years. The diploma is issued by the director-general of public instruction. In Germany midwives are appointed, recognized and authorized by the state. They can conduct confinements independently and without the aid of a medical man. They must be provided with a certificate from the police authorities, and must reside in special districts assigned to them by the authorities. In Austria midwives before they are allowed to practise must pass a strict examination, after having followed a six months' course at one of the state schools of midwifery. They are subject to elaborate "instructions for midwives" issued from time to time by the ministry of the interior. In Italy a midwife must pass an examination and obtain a diploma from a recognized authority; but in order to obviate the difficulty which the poorer classes in the smaller communes would find in obtaining properly-authorized midwives, a certificate of permission to practise may be given to a certain number who have practised without the sanction of the law satisfactorily during a term of five years. These certificates are distributed by the prefect. In Russia matters pertaining to the appointment, transfer, dismissal and pay of midwives are under the charge of the medical department of the ministry of the interior. In each town of a province or region there is stationed one senior midwife and a number of junior midwives in proportion to the number of districts in the province. The examination of midwives and the issue of certificates of competency is carried out by the Medico-Chirurgical Academy and certain of the universities. A duly-licensed midwife, on presentation of her licence, is at once excluded from the tax-paying class to which she may have belonged. The general code of Russian law lays down the conditions for the carrying out of the duties of midwives. In Norway all midwives are licensed after examination and are under the control and inspection of the board of health. Provision is made for infirm and aged midwives. They are usually paid by the parish, but also receive fees according to the means of the person attended. In Sweden a certificate of competency and of having passed an examination does not give a midwife a right

to practise until a note has been made on the certificate that the oath of office has been duly taken. All midwives are under the control of the board of health. When a midwife takes up her residence in a parish, or moves from one place to another, she must announce the fact within a month to the nearest appointed doctor and exhibit her certificate. In towns a midwife must put up a notice board outside her residence; she must not absent herself from home without leaving word as to where she may be found and at what hour she will probably return. In the country a midwife may be paid out of the poor rate. In Denmark, also, midwives are recognized by the state, and the practise of midwifery is almost entirely in the hands of women. In Holland a certain number of candidates are given free training by the state in return for their practising midwifery in scattered country districts at a fixed salary. Many of the states of the United States have also passed laws for the registration of midwives.

In England alone there was no regulation of any kind so late as 1902. Any person, however ignorant and untrained, could describe herself as a midwife and practise for gain. Several societies made continuous efforts towards the close of the 19th century to obtain legislation. A select committee on midwives' registration reported in 1892 that the evidence they had taken showed that there was at the time "serious and unnecessary loss of life and health and permanent injury to both mother and child in the treatment of children and that some legislative provision for improvement and regulation was desirable." A similar report, *inter alia*, to the same effect in 1893. Eventually a bill was drafted with the object of securing the examination and registration of midwives, but, although introduced several times into the House of Commons, it was not successful until 1902. The Midwives Act 1902 forbids any woman after the 1st of April 1905 to call herself "midwife" without a certificate, or to act as a midwife for gain without a certificate after the 1st of April 1910. Existing midwives (those who held certificates in midwifery from certain recognized institutions, or produced satisfactory evidence at the passing of the act that they had been for at least one year in bona fide practice as midwives, and bore good characters) were allowed to claim certificates within two years from the 1st of April 1903. The act created a central midwives' board, whose duties are, *inter alia*, to regulate the issue of certificates and the conditions of admission to the roll of midwives; to regulate the course of training and conduct of examinations; to regulate, supervise and restrict within due limits the practice of midwives; to publish annually a roll of duly certified midwives; to remove from the roll the name of any midwife who disobeys the rules and regulations laid down from time to time; to issue and cancel certificates, &c. There is an appeal to the High Court of Justice against removal of a name, but the appeal must be made within three months. Local authorities are required to exercise supervision over the midwives within their area; they must investigate charges of malpractice, negligence or misconduct; exercise the power of suspension and report convictions. They must supply the central board with the names and addresses of those practising within their area, and notify any death. The local authority must appoint a committee to carry out its powers or duties under the act, and may, if it think fit, delegate its powers to a lesser local authority, such as a district council. The act provides for penalties for obtaining a certificate by false representation or for wilful falsification of the roll. The act does not apply to Ireland or Scotland. (T. A. I.)

MIERES, a town of northern Spain, in the province of Oviedo, 12 m. by rail S.E. of Oviedo, on the river Caudal, a tributary of the Nalon. Pop. (1900), 13,083. Mieres is the chief town of a mountainous, fertile and well-wooded region in which coal, iron, and copper are extensively mined and sulphur and cinnabar are obtained in smaller quantities. The town contains large iron foundries and chemical works, and has an active trade in fruit, cider, timber and live stock.

MIEREVELT (MIEREVELD, or MIREVELDT), **MICHEL JANSZ VAN** (1567-1641), Dutch painter, was born at Delft, the son of a goldsmith, who apprenticed him to the copperplate engraver J. Wierix. He subsequently became a pupil of Willem Willemsz and Augusteyn of Delft, until Anthonie van Montfoort (Blocklandt), who had seen and admired two of Mierevelt's early engravings, "Christ and the Samaritan" and "Judith and Holofernes," invited him to enter his school at Utrecht. Devoting himself first to still life, he eventually took up portraiture, in which he achieved such success that the many commissions entrusted to him necessitated the employment of numerous assistants, by whom hundreds of portraits were turned out in factory fashion. The works that can with certainty be ascribed to his own brush are remarkable for their sincerity, severe drawing and harmonious colour, but comparatively few of the two thousand or more portraits that bear

his name are wholly his own handiwork. He settled down in his native town, but went frequently to The Hague, where he entered the guild of St Luke in 1625. So great was his reputation that he was patronized by royalty in many countries and acquired great wealth. The king of Sweden and the count palatine of Neuburg presented him with golden chains, Archduke Albrecht gave him a pension, and Charles I. vainly endeavored to induce him to visit the English court. Though Mierevelt is chiefly known as a portrait painter, he also executed some mythological pieces of minor importance. Many of his portraits have been reproduced in line by the leading Dutch engravers of his time. He died at Delft on the 27th of June 1641.

The Ryks Museum in Amsterdam has the richest collection of Mierevelt's works, chief of them being the portraits of William, Philip William, Maurice, and Frederick Henry of Orange, and of the count palatine Frederick V. At The Hague Museum are the portraits of four princes of the house of Orange, of Frederick V., king of Bohemia, and of Louise de Coligny as a widow. Other portraits by him are at nearly all the leading continental galleries, notably at Brunswick (3), Gotha (2), Schwerin (3), Munich (2), Paris (Louvre, 3), Dresden (4), Berlin (2), and Darmstadt (3). The town hall of Delft also has numerous examples of his work.

Many of his pupils and assistants rose to fame. The most gifted of them were Paulus Moreelse and Jan van Ravesteyn. His sons Pieter (1596-1623) and Jan (d. 1633), and his son-in-law Willem Jacobz Delft, probably painted many of the pictures which go under his name. His portrait was painted by Van Dyck and engraved by Delft.

MIERIS, the name of a family of artists who practised painting at Leiden for three generations in the 17th and 18th centuries.

1. **FRANS VAN MIERIS**, the elder (? 1635-1681), son of Jan van Mieris, a goldsmith and diamond setter, was born, according to Houbraken, at Leiden on the 16th of April 1635, and died there on the 12th of March 1681. His father wished to train him to his own business, but Frans preferred drawing to chasing, and took service with Abraham Torenvliet, a glazier who kept a school of design. In his father's shop he became familiar with the ways and dress of people of distinction. His eye was fascinated in turn by the sheen of jewelry and stained glass; and, though he soon gave up the teaching of Torenvliet for that of Gerard Douw and Abraham van den Tempel, he acquired a manner which had more of the finish of the exquisites of the Dutch school than of the breadth of the disciples of Rembrandt. It should be borne in mind that he seldom chose panels of which the size exceeded 12 to 15 in., and whenever his name is attached to a picture above that size we may surely assign it to his son Willem or to some other imitator. Unlike Gerard Douw when he first left Rembrandt, or Jan Steen when he started on an independent career, Mieris never ventured to design figures as large as life. Characteristic of his art in its minute proportions is a shiny brightness and metallic polish. The subjects which he treated best are those in which he illustrated the habits or actions of the wealthier classes; but he sometimes succeeded in homely incidents and in portrait, and not infrequently he ventured on allegory. He repeatedly painted the satin skirt which Ter Borch brought into fashion, and he often rivalled Ter Borch in the faithful rendering of rich and highly-coloured woven tissues. But he remained below Ter Borch and Metsu, because he had not their delicate perception of harmony or their charming mellowness of touch and tint, and he fell behind Gerard Douw, because he was hard and had not his feeling for effect by concentrated light and shade. In the form of his composition, which sometimes represents the framework of a window enlivened with greenery, and adorned with bas-reliefs within which figures are seen to the waist, his model is certainly Gerard Douw.

It is a question whether Houbraken has truly recorded this master's birthday. One of his best-known pieces, a party of ladies and gentlemen at an oyster luncheon, in the Hermitage at St Petersburg, bears the date of 1650. Celebrated alike

for composition and finish, it would prove that Mieris had reached his prime at the age of fifteen. Another beautiful example, the "Doctor Feeling a Lady's Pulse" in the gallery of Vienna, is dated 1656; and Waagen, in one of his critical essays, justly observes that it is a remarkable production for a youth of twenty-one. In 1657 Mieris was married at Leiden in the presence of Jan Pottheuck, a painter, and this is the earliest written record of his existence on which we can implicitly rely. Of the numerous panels by Mieris, twenty-nine at least are dated—the latest being an allegory, long in the Ruhl collection at Cologne, illustrating what he considered the kindred vices of drinking, smoking and dicing, in the year 1680.

Mieris had numerous and distinguished patrons. He received valuable commissions from Archduke Leopold, the elector-palatine, and Cosimo III., grand-duke of Tuscany. His practice was large and lucrative, but never engendered in him either carelessness or neglect. If there be a difference between the painter's earlier and later work, it is that the former was clearer and more delicate in flesh, whilst the latter was often darker and more livid in the shadows. When he died his clients naturally went over to his son Willem, who in turn bequeathed his painting-room to his son Frans. But neither Willem nor Frans the younger equalled Frans the elder.

2. **WILLEM VAN MIERIS** (1662-1747), son of Frans. His works are extremely numerous, being partly imitations of the paternal subjects, or mythological episodes, which Frans habitually avoided. In no case did he come near the excellence of his sire.

3. **FRANS VAN MIERIS**, the younger (1689-1763), also lived on the traditions of his grandfather's studio.

The pictures of all the generations of the Mieris family were successfully imitated by A. D. Snaphaan, who lived at Leipzig and was patronized by the court of Anhalt-Dessau. To those who would study his deceptive form of art a visit to the collection of Wörlitz near Dessau may afford instruction.

MIFFLIN, THOMAS (1744-1800), American soldier and politician, was born in Philadelphia, Pennsylvania, on the 10th of January 1744, of Quaker parentage. He graduated at the college of Philadelphia (now the university of Pennsylvania) in 1760. As a member of the Pennsylvania house of representatives in 1772-1775, he was an ardent Whig, and in 1774 was a member of the first Continental Congress. After the outbreak of the War of Independence he devoted himself chiefly to the enlisting and drilling of troops, and was chosen major of a regiment. In June 1775 he entered the continental service as Washington's first aide-de-camp, and in August was chosen quartermaster-general. He became a brigadier-general in May 1776 and a major-general in February 1777. On the 5th of June 1776 he was succeeded as quartermaster-general by Stephen Moylan. Moylan, however, proved incompetent, and Mifflin resumed the office on the 1st of October. In the autumn of 1777 Mifflin was a leader in the obscure movement known as the Conway Cabal, the object of which was to replace Washington by General Horatio Gates. On the ground of ill health Mifflin tendered his resignation on the 8th of October, and on the 7th of November Congress accepted his resignation as quartermaster-general, but continued him in rank as major-general without pay. On the same day he was appointed a member of the new board of war, and on the following day was asked to continue as quartermaster-general until his successor should be appointed. On the 21st of November he urged before the old board of war and ordinance that Gates should be made president of the new board of war "from a conviction that his military skill would suggest reformations in the different departments of the army essential to good discipline, order and economy, and that his character and popularity in the army would facilitate the execution of such reformations when adopted by Congress." The attacks on Washington failed, and in March 1778 Mifflin was finally superseded as quartermaster-general by General Nathaniel Greene. In October of the same year he was removed from the board of war. The sufferings of the troops at Valley Forge having been charged to his mismanagement as quartermaster-

master-general, Congress, in June 1778, ordered an investigation; but before this inquiry had proceeded far, Congress granted him \$1,000,000 to settle all claims against the office during his administration. In February 1779 he resigned his commission as major-general. During the war his eloquence was repeatedly of assistance to Congress in recruiting soldiers. He was a delegate in Congress in 1782-1784, and from November 1783 to November 1784 was president, in which office he received Washington's resignation of the command of the army and made a congratulatory address. In 1785-1788 he was speaker of the Pennsylvania general assembly (then consisting of only one house); he was a member of the Federal Constitutional Convention of 1787, and president of the state supreme executive council (or chief executive officer of the state) in 1788-1790. He was president of the Pennsylvania Constitutional Convention of 1780-1790; was the first governor of the state, from 1790 to 1799, after the adoption of the new state constitution; and during the Whisky Insurrection assumed personal command of the Pennsylvania militia. Towards the close of his last term as governor he was elected a member of the state assembly, but died during the first session, at Lancaster, on the 20th of January 1800.

See William Rawle, "Sketch of the Life of Thomas Mifflin," in *Memoirs of the Historical Society of Pennsylvania* vol. 2, part 2, Philadelphia, 1830; and J. H. Merrill, *Memoiranda relating to the Mifflin Family* (Philadelphia, 1890).

MIGNARD, PIERRE (1610-1695), called to distinguish him from his brother Nicholas—Le Romain, French painter, was born at Troyes in 1610, and came of a family of artists. In 1630 he left the studio of Simon Vouet for Italy, where he spent twenty-two years, and made a reputation which brought him a summons to Paris. Successful with his portrait of the king, and in favour with the court, Mignard pitted himself against Le Brun, declined to enter the Academy of which he was the head, and made himself the centre of opposition to its authority. The history of this struggle is most important, because it was identical, as long as it lasted, with that between the old guilds of France and the new body which Colbert, for political reasons, was determined to support. Shut out, in spite of the deserved success of his decorations of the cupola of Val de Grace (1664), from any great share in those public works the control of which was the attribute of the new Academy, Mignard was chiefly active in portraiture. Turenne, Molière, Bossuet, Maintenon (Louvre), La Vallière, Sévigné, Montespan, Descartes (Castle Howard), all the beauties and celebrities of his day, sat to him. His readiness and skill, his happy instinct for grace of arrangement, atoned for want of originality and real power. With the death of Le Brun (1690) the situation changed; Mignard deserted his allies, and succeeded to all the posts held by his opponent. These late honours he did not long enjoy; in 1695 he died whilst about to commence work on the cupola of the Invalides. His best compositions have been engraved by Audran, Edelínck, Masson, Poilly and others.

MIGNE, JACQUES PAUL (1800-1875), French priest and publisher, was born at St Flour, Cantal, on the 25th of October 1800. He studied theology at Orleans, was ordained priest in 1824 and placed in charge of the parish of Puisseaux, in the diocese of Orleans. In 1833 he went to Paris, and started *L'Univers religieux*, which afterwards became Louis Veuillot's ultramontane organ. On severing his connexion with the paper three years later, he opened at Petit Montrouge, near Paris, the great publishing house which brought out in rapid succession numerous religious works at popular prices. The best known of these are: *Scripturae sacrae cursus completus*, and *Theologiae cursus* (each in 28 vols., 1840-1845); *Collection des auteurs sacrés* (100 vols., 1846-1848); *Encyclopédie théologique* (171 vols., 1844-1866); *Patrologiae cursus completus*, Latin series in 221 vols. (1844-1855; 2d edition, 1878 seq.); Greek series, first published in Latin (85 vols., 1856-1861); with Greek text and Latin translation (165 vols., 1857-1866). Unfortunately these editions, brought out in great haste and often edited by superficial scholars, do not come up to the requirements of modern

criticism. By far the most noteworthy is the *Patrologia*, which was superintended by the learned Benedictine J. B. Pitra. Its vast scope leaves it still unique and valuable, where other editions of special works do not exist. The indices in 3 vols. are arranged so that one may easily find any reference in the patristic writings. In February 1868 a great fire destroyed the whole of Migne's printing premises, but he established a new house in Paris, which was purchased in 1876 by the publishers Garnier Frères, who still own all the works brought out by Migne. He died in Paris on the 25th of October 1875.

For a more complete account of Migne's life, see the article in the *Catholic Encyclopedia* (New York, 1906 seq.).

MIGNET, FRANÇOIS AUGUSTE ALEXIS (1796-1884), French historian, was born at Aix in Provence on the 8th of May 1796, and died at Paris on the 24th of March 1884. His father, a Vendean by birth, was an ordinary locksmith, who enthusiastically accepted the principles of the French Revolution and roused in his son the same love for liberal ideas. François had brilliant successes when studying at Avignon in the *lycée* where he was afterwards professor (1815); he returned to Aix to study law, and in 1818 was called to the bar, where his eloquence would have ensured his success had he not preferred the career of an historian. His abilities were shown in an *Éloge de Charles VII.*, which was crowned by the Académie de Nîmes in 1820, and a memoir on *Les Institutions de Saint Louis*, which in 1821 was crowned by the Académie des Inscriptions et Belles Lettres. He then went to Paris, where he was soon joined by his friend and compatriot, Adolphe Thiers, the future president of the French republic. He was introduced by J. A. Manuel, formerly a member of the Convention, to the Liberal paper, *Courrier français*, where he became a member of the staff which carried on a fierce pen-and-ink warfare against the Restoration. He acquired his knowledge of the men and intrigues of the Napoleonic epoch from Talleyrand. He wrote a *Histoire de la révolution française* (1824) in support of the Liberal cause. It was an enlarged sketch, prepared in four months, in which more stress was laid on fundamental theories than on the facts, which are more rigidly linked together than their historical sequence warrants. In 1830 he founded the *National* with Thiers and Armand Carrel, and signed the journalists' protest against the *Ordonnances de juillet*, but he refused to accept his share of the spoil after his party had won. He was satisfied with the modest position of director of the archives at the Foreign Office, where he stayed till the revolution of 1848, when he was dismissed, and retired permanently into private life. He had been elected a member of the Académie des Sciences Morales et Politiques, re-established in 1832, and in 1837 was made the permanent secretary; he was also elected a member of the Académie Française in 1836, and sought no further honours. He was well known in fashionable circles, where his witty conversation and his pleasant manners made him a favourite. The greater part of his time was, however, given to study and to his academic duties. Eulogies on his deceased fellow-members, the Academy reports on its work and on the prizes awarded by it, which it was part of Mignet's duty as secretary to draw up, were literary fragments thoroughly appreciated by connoisseurs. They were collected in Mignet's *Notices et portraits*. He worked slowly when in his study, and willingly lingered over research. With the exception of his description of the French Revolution, which was chiefly a political manifesto, all his early works refer to the middle ages—*De la féodalité, des institutions de Saint Louis et de l'influence de la législation de ce prince* (1822); *La Germanie au viii^e et au ix^e siècle, sa conversion au christianisme, et son introduction dans la société civilisée de l'Europe occidentale* (1834); *Essai sur la formation territoriale et politique de la France depuis la fin du xi^e siècle jusqu'à la fin du xiv^e* (1836); all of these are rough sketches showing only the outlines of the subject. His most noted works are devoted to modern history. For a long time he had been taken up with a history of the Reformation, but only one part of it, dealing with the Reformation at Geneva, has been published. His *Histoire de Marie Stuart* (2 vols., 1851)

is well worth reading; the author made liberal use of some important unpublished documents, taken for the greater part from the archives of Simancas. He devoted some volumes to a history of Spain, which had a well-deserved success—*Charles Quint, son abdication, son séjour, et sa mort au monastère de Yuste* (1845); *Antonio Perex et Philippe II.* (1845); and *Histoire de la rivalité de François I. et de Charles Quint* (1875). At the same time he had been commissioned to publish the diplomatic acts relating to the War of the Spanish Succession for the *Collection des documents inédits*; only four volumes of these *Négociations* were published (1835-1842), and they do not go further than the peace of Nijmegen; but the introduction is celebrated, and Mignet reprinted it in his *Mélanges historiques*.

See the eulogy of Mignet by Victor Duruy, delivered on entering the Académie Française on the 18th of June 1885, and the notice by Jules Simon, read before the Académie des Sciences Morales et Politiques on the 7th of November 1885.

MIGNON, ABRAHAM (1640-1697), Dutch painter, was born at Frankfort. His father, a merchant, placed him under the still-life painter Jacob Merrel, by whom he was taken to Holland about 1660. He then worked under de Heem at Utrecht, where in 1675 he married the daughter of the painter Cornelis Willaerts. Sibylle Merian (1647-1717), daughter of the engraver Matthew Merian, became his pupil and achieved distinction as a flower painter. He died at Wetzlar. Mignon devoted himself almost exclusively to flowers, fruit, birds and other "still life," though at times he also attempted portraiture. His flower pieces are marked by careful finish and delicate handling. His favourite scheme was to introduce red or white roses in the centre of the canvas and to set the whole group of flowers against a dark background. Nowhere can his work be seen to better advantage than at the Dresden Gallery, which contains fifteen of his paintings, twelve of which are signed. Six of his pictures are at the Louvre, four at the Hermitage, and other examples are to be found at the museums of Amsterdam, The Hague, Rotterdam, Brussels, Munich, Karlsruhe, Brunswick, Cassel, Schwerin, Copenhagen and Turin.

MIGNONETTE, or **MIGNONNETTE** (i.e. "little darling"), the name given to a popular garden flower, the *Reseda odorata* of botanists, a "fragrant weed," as Cowper calls it, highly esteemed for its delicate but delicious perfume. The mignonette is generally regarded as being of annual duration, and is a plant of diffuse decumbent twiggy habit, scarcely reaching a foot in height, clothed with bluntish lanceolate entire or three-lobed leaves, and bearing longish spikes—technically racemes—of rather insignificant flowers at the ends of the numerous branches and branchlets. The plant thus naturally assumes the form of a low dense mass of soft green foliage studded over freely with the racemes of flowers, the latter unobtrusive and likely to be overlooked until their diffused fragrance compels attention. It is probably a native of North Africa and was sent to England from Paris in 1742; and ten years later it appears to have been sent from Leiden to Philip Miller at Chelsea. Though originally a slender and rather straggling plant, there are now some improved garden varieties in which the growth is more compact and vigorous, and the inflorescence bolder, though the odour is perhaps less penetrating. The small six-petalled flowers are somewhat curious in structure: the two upper petals are larger, concave, and furnished at the back with a tuft of club-shaped filaments, which gives them the appearance of being deeply incised, while the two lowest petals are much smaller and undivided; the most conspicuous part consists of the anthers, which are numerous and of a brownish red, giving the tone of colour to the inflorescence. In the varieties named Golden Queen and Golden Machet the anthers have a decided tint of orange-yellow, which imparts a brighter golden hue to the plants when in blossom. A handsome prolific and double-flowered variety has also been obtained, which is a very useful decorative plant, though only to be propagated by cuttings; the double white flowers grow in large massive panicles (proliferous

racemes), and are equally fragrant with those of the ordinary forms.

What is called tree mignonette in gardens is due to the skill of the cultivator. Though practically a British annual, as already noted, since it flowers abundantly in the first season, and is utterly destroyed by the autumnal frosts, and though recorded as being annual in its native habitat by Desfontaines in the *Flora Atlantica*, the mignonette, like many other plants treated in England as annuals, will continue to grow on if kept in a suitable temperature. Moreover, the life of certain plants of this semi-annual character may be prolonged into a second season if their flowering and seeding are persistently prevented. In applying these facts to the production of tree mignonette, the gardener grows on the young plants under glass, and prevents their flowering by nipping off the blooming tips of the shoots, so that they continue their vegetative growth into the second season. The young plants are at first supported in an erect position, the laterals being removed so as to secure clear upright stems, and then at the height of one or two feet or more, as may be desired, a head of branches is encouraged to develop itself. In this way very large plants can be produced.

For ordinary purposes, however, other plans are adopted. In the open borders of the flower garden mignonette is usually sown in spring, and in great part takes care of itself; but being a favourite either for window or balcony culture, and on account of its fragrance a welcome inmate of town conservatories, it is also very extensively grown as a pot plant, and for market purposes with this object it is sown in pots in the autumn, and thinned out to give the plants requisite space, since it does not transplant well, and it is thereafter specially grown in pits protected from frosts, and marketed when just arriving at the blooming stage. In this way hundreds of thousands of pots of blooming mignonette are raised and disposed of year by year.

In classifying the odours given off by plants Rimmel ranks the mignonette in the class of which he makes the violet the type; and Fée adopts the same view, referring it to his class of "isomoids" along with the violet and wallflower.

The genus *Reseda* contains about fifty species, natives of Europe and West Asia. *R. luteola*, commonly called dyer's-weed and weld, yields a valuable yellow dye. *R. alba* is a fine biennial about 2 ft. high, with erect spikes of whitish flowers.

MIGNONS, LES. In a general sense the French word *mignon* means "favourite," but the people of Paris used it in a special sense to designate the favourites of Henry III. of France, frivolous and fashionable young men, to whom public malignity attributed dissolute morals. According to the contemporary chronicler Pierre de l'Estoile, they made themselves "exceedingly odious, as much by their foolish and haughty demeanour, as by their effeminate and immodest dress, but above all by the immense gifts the king made to them." The Guises appear to have stirred up the ill will of the Parisians against them. From 1576 the *mignons* were attacked by popular opinion, and historians accredited without proof the scandalous stories of the time. The best known of the *mignons* were the dukes of Joyeuse and of Épernon.

MIGNOT, CLAUDE FRANÇOISE [commonly called **MARIE**] (c. 1617-1711), French adventuress, was born near Grenoble, at Meylan. At the age of sixteen she attracted the notice of the secretary of Pierre des Portes d'Amblérieux, treasurer of the province of Dauphiny, and Amblérieux promised to promote their marriage. He married the girl himself, however, and left her his fortune. His will was disputed by his family, and Claudine went to Paris in 1653 to secure its fulfilment. She sought the protection of François de l'Hôpital, marshal of France, then a man of seventy-five. He married her within a week of their first meeting, and after seven years of marriage died leaving her part of his estate. By a third andmorganatic marriage in 1672 with John Casimir, ex-king of Poland, a few weeks before his death, she received a third fortune. Immediately on her marriage with Amblérieux she had begun to educate herself, and her wealth and talents assured her a welcome in Paris. She retired in her old age to a Carmelite convent in the city, where she died on the 30th of November 1711.

Her history, very much modified, was the subject of a play by Bayard and Paul Dupont, *Marie Mignot* (1829).

MIGRATION. Under this title will be considered movements of men with intention of changing their residence or domicile. Such migration (Lat. *migrare*) may be either external—that is, from one country to another, including emigration from mother country to colony; or it may be internal—that is, within

the limits of a single country. Under external migration are comprised *emigration* and *immigration*, denoting simply direction from and to. The emigrants are at the same time the immigrants; that is, the material of the movement is the same, but the effect upon the country giving up and the country receiving the migrant requires separate treatment. Hence it is proper to separate emigration from immigration. Temporary migration, or travel for purposes of business, enterprise or pleasure, will be considered only incidentally, and because in some cases it is difficult to distinguish between such movements and permanent migration.

Migration in general may be described as a natural function of social development. It has taken place at all times and in the greatest variety of circumstances. It has been tribal, national, class and individual. Its causes have been political, economic, religious, or mere love of adventure. Its causes and results are fundamental for the study of ethnology (formation and mixture of races), of political and social history (formation of states and survival of institutions), and of political economy (mobility of labour and utilization of productive forces). Under the form of conquest it makes the grand epochs in history (e.g. the fall of the Roman Empire); under the form of colonization it has transformed the world (e.g. the settlement of America); under free initiative it is the most powerful factor in social adjustment (e.g. the growth of urban population). It must suffice here to indicate the character of the principal movements in the past, and then describe certain aspects of modern migration. The early movements may be grouped as follows: (a) Prehistoric migrations. Among savage and nomadic nations the whole tribe often moves into new territory, either occupying it for the first time or exterminating or driving out the indigenous inhabitants. We have only vague knowledge of these early movements, laboriously gleaned from archaeology, anthropology and philology. The cause has been commonly said to be the pressure of population on the food-supply. A more probable explanation is the love of booty and the desire of the stronger to take possession of the lands of the weaker. (b) Greek and Roman colonization. Both of these ancient civilizations extended their influence through migration of individual families and the planting of colonies. The motive seems to have been primarily commercial—that is, the love of gain. It may have been partly a sort of "swarming" process, caused by pressure of population at home. In some cases it had a political motive, as the planting of military colonies or providing new homes for the proletariat. The consequences were of course momentous. (c) The German Conquest. Beginning about the 5th century, the Roman empire was overthrown by German tribes from the north of the river Danube and east of the river Rhine. This *Völkerwanderung*, as it is called by German historians, again transformed the face of Europe, resulting in the establishment of independent kingdoms and a great mixture of races and institutions. It was coincident with the building-out of the feudal system. The conquered in many cases could be left as serfs and tillers of the soil, while the conquerors seized the higher positions of administration and power. (d) The later middle ages saw many minor migratory movements, such as those accompanying the crusades, the pushing of German colonization among the Slavs, and the introduction of Flemish weavers into England. The religious reformation caused a considerable amount of expatriation, culminating in the expulsion of the Huguenots from France. (e) The period of discovery and colonization opened up a new era for migration. The first expeditions were for adventure and booty, especially the discovery of gold and silver. Then came the establishment of commercial posts or factories for the purposes of trade. Finally came colonization proper—that is, the settlement of new countries by Europeans intending to remain there permanently,

but still retaining their connexion with the mother country. This meant the opening up of the world to commerce and the extension of European civilization to vast areas formerly peopled by savages or half-civilized peoples. It meant a great outlet for the spirit of enterprise and adventure, relief from over-population, an enormous increase in wealth and power, and a struggle for supremacy among the nations of Europe. Colonization and social policy excited immense attention in Europe; and this extended into the 19th century (e.g. E. G. Wakefield's plans for colonization, and the various colonization societies of modern times). The colonial policy proper was broken down by the revolt of the North American colonies from Great Britain, and later of Mexico and Central and South America from Spain. (f) The movement of population, however, has continued under the form of emigration. This movement is characterized firstly by its magnitude; secondly, by the fact that the emigrant changes his political allegiance, for by far the greater part of modern emigration is to independent countries, and even where it is to colonies the colonies are largely self-governing and self-regarding; and thirdly, it is a movement of individuals seeking their own good, without state direction or aid. This is 20th-century emigration, differing from all preceding forms and having an importance of its own.

Statistics of Emigration.—The direction of the modern movement is from Europe to America, Australia and South Africa, as shown in the following table:—

Emigration from Certain States of Europe, 1890-1905.¹

Year.	Italy.	France.	Belgium.	Holland.	Spain ² .	Portugal.	Austria-Hungary.	Switzerland.	Germany.
1890	115,595	20,560	2976	3526	37,025	28,945	74,002	6693	97,103
1891	189,746	6,217	3456	4075	37,721	33,234	81,407	6521	120,089
1892	116,642	5,528	5174	6290	30,190	20,772	74,947	6689	116,339
1893	142,269	5,586	3881	4820	38,707	30,903	65,554	5229	87,677
1894	114,566	—	1267	1146	34,102	26,656	25,536	2803	40,904
1895	187,908	—	1318	1314	36,220	44,420	63,552	3107	37,498
1896	197,554	—	1429	1387	45,317	27,625	66,547	2441	32,152
1897	174,545	—	769	792	39,366	21,369	35,534	1778	23,249
1898	139,188	—	628	851	38,546	23,280	53,947	1604	20,966
1899	145,440	—	600	1347	47,958	17,539	99,299	1701	22,114
1900	171,735	—	876	1898	55,452	20,794	117,372	2650	20,921
1901	288,947	—	1019	1874	48,892	20,439	136,557	2968	20,874
1902	295,443	—	1695	2301	44,401	23,880	185,449	3617	30,915
1903	292,933	—	2101	2963	—	21,291	222,218	4669	35,453
1904	267,249	—	2260	2440	—	27,925	144,038	3727	27,265
1905	479,349	No information available	2546	2297	—	—	—	3780	27,403

Year.	Great Britain and Ireland.							
	Sweden.	Norway.	Russia. ³	Denmark.	England and Wales.	Scotland.	Ireland.	Total United Kingdom.
1890	30,128	10,991	85,548	10,298	139,979	20,653	57,484	218,116
1891	38,318	13,341	109,415	10,382	137,881	22,190	58,446	218,047
1892	41,275	17,049	74,681	10,442	133,815	23,252	52,902	210,042
1893	37,504	18,778	40,545	9,150	134,950	22,637	52,132	208,814
1894	9,678	5,642	17,792	4,105	99,509	14,432	42,008	156,310
1895	15,104	6,207	36,725	3,607	112,538	18,294	54,349	185,181
1896	12,919	6,679	32,127	2,876	102,837	16,866	42,222	161,925
1897	8,926	4,666	18,107	2,260	94,658	16,124	35,678	146,600
1898	7,321	4,859	27,853	2,340	90,679	15,570	34,395	140,644
1899	12,028	6,699	63,101	2,795	87,400	15,072	42,800	146,362
1900	16,434	10,931	92,833	3,799	102,448	20,472	45,905	168,825
1901	20,464	12,745	87,431	4,657	111,585	20,920	39,210	171,715
1902	33,477	20,343	110,453	6,823	137,121	26,285	42,256	205,662
1903	35,975	26,784	140,211	8,214	177,581	36,801	45,568	259,590
1904	—	22,264	—	9,034	175,733	37,445	58,257	271,435
1905	—	21,050	—	8,051	170,408	31,510	50,159	262,077

¹ The figures relate only to the emigrants of each nationality emigrating from their own country to countries outside of Europe.

² Exclusive of emigrants to Spanish colonies.

³ Russian emigrants from German ports.

Since 1820 over twenty million persons have emigrated from Europe to countries beyond the sea. The greater part of this emigration has been to the United States of North America. The history of emigration is well shown in the following table of emigration from Great Britain and Ireland. Down to 1853 the figures include all emigrants from British ports; after 1853 emigrants of British and Irish origin only.

Emigration from Great Britain and Ireland, 1815-1905.

	All Emigrants.				
	To British North America.	To United States.	To Australia.	To other Places.	Total.
1815-1820 (5 years)	70,438	50,359	—	2,731	123,528
1821-1830 (10 "	139,269	99,801	9,036	1,805	249,911
1831-1840 (10 "	322,485	308,247	67,882	4,536	703,150
1841-1850 (10 "	429,044	1,094,556	127,124	34,168	1,684,892
1851-1852 (2 "	75,478	511,618	109,413	8,221	704,730
1815-1852 (37 years)	1,036,714	2,064,581	313,455	51,461	3,466,211
Emigrants of British and Irish Origin.					
1853-1860 (8 years)	123,408	805,596	365,307	18,372	1,312,683
1861-1870 (10 "	130,310	1,132,626	267,358	41,535	1,571,829
1871-1880 (10 "	177,976	1,087,372	303,367	110,204	1,678,919
1881-1890 (10 "	301,922	1,713,953	372,744	169,916	2,558,535
1891-1900 (10 "	176,336	1,090,685	119,018	258,923	1,644,962
1901-1905 (5 "	181,504	290,679	27,120	85,607	584,910
1853-1905 (53 years)	1,091,456	6,120,911	1,454,914	684,576	9,351,857

The general direction of emigration from Europe is shown in the following table:—

Emigration from various Countries of Europe.

Country.	Country of Destination.							Total.
	United States.	British North America.	Brazil.	Argentine.	Australasia.	Africa.	All other.	
Great Britain and Ireland, 1905	122,370	82,437	—	—	15,139	26,307	15,824	262,077
Norway, 1905	19,638	1,386	—	—	—	25	6	21,059
Sweden, 1903	35,439	329	—	—	51	118	38	35,975
Germany, 1905	26,005	243	333	674	84	57	7	27,403
Denmark, 1905	7,158	453	—	—	55	19	366	8,051
Holland, 1905	—	2,282	—	—	—	15	—	2,297
Belgium, 1905	2,162	—	—	—	2	101	275	2,540
France, 1905	—	—	—	—	available.	—	—	—
Portugal, 1904	—	4,351	21,449	No information	—	1,954	—	27,925
Spain, 1902	—	Cannot be given.	1,120	8,767	—	20,460	—	44,401
Italy, 1905	316,797	5,930	30,079	88,840	765	13,072	3,866	479,349
Switzerland, 1905	4,349	—	53	471	—	—	—	5,049
Austria-Hungary, 1905	284,967	10,399	—	5,346	—	—	—	—

Statistics of Immigration.—The statistics of the United States are the most important and the most complete. The statistics since 1820 are shown in the following table:—

Immigration into the United States, 1820-1905.

Decade ending 30th June.	Aggregate Arrivals.	Annual Average.	Country of Destination.							Total.
			United States.	British North America.	Brazil.	Argentine.	Australasia.	Africa.	All other.	
1830	143,439	14,343	—	—	—	—	—	—	—	—
1840	599,125	59,912	—	—	—	—	—	—	—	—
1850	1,713,251	171,325	—	—	—	—	—	—	—	—
1860	2,598,214	259,821	—	—	—	—	—	—	—	—
1870	2,314,824	231,482	—	—	—	—	—	—	—	—
1880	2,812,191	281,219	—	—	—	—	—	—	—	—
1890	5,246,613	524,661	—	—	—	—	—	—	—	—
1900	3,844,422	384,442	—	—	—	—	—	—	—	—
1901-1905	3,833,076	766,615	—	—	—	—	—	—	—	—
Total	23,116,501	—	—	—	—	—	—	—	—	—
Prior to 1820 there was no official record of immigration, but it is estimated that the total number of immigrants from the close of the Revolutionary War was 250,000. During the decade from 1820 to 1830 the movement was very moderate. From 1830 to 1840 it steadily increased, but never reached 100,000 per annum. In 1846 came the Irish potato famine, and an enormous emigration began, followed by a very large German emigration from similar causes. The Civil War of the United States interrupted the movement, but			Scandinavians—	—	—	—	—	—	—	—
			Denmark	—	—	—	159,759	—	1-5	—
			Norway	—	—	—	331,258	—	3-2	—
			Sweden	—	—	—	660,193	—	6-4	—
			Total	—	—	—	1,151,210	—	11-1	—
			Czechs, Magyars, Slavs—	—	—	—	—	—	—	—
			Bohemia	—	—	—	77,247	—	0-7	—
			Hungary	—	—	—	256,347	—	2-5	—
			Poland	—	—	—	141,908	—	1-4	—
			Rumania	—	—	—	10,377	—	0-1	—
			Russia	—	—	—	500,797	—	4-8	—
			Total	—	—	—	986,676	—	9-5	—
			Swiss—Switzerland	—	—	—	135,736	—	1-3	—
			Greeks—Greece	—	—	—	7,325	—	0-1	—
			Turks—Turkey	—	—	—	3,411	—	0-1	—
			Europe, not specified	—	—	—	294	—	—	—
			Total Europe	—	—	—	9,197,014	—	88-9	—
			North America	—	—	—	776,071	—	7-5	—
			All other countries	—	—	—	366,454	—	3-6	—
			Grand Total	—	—	—	10,339,539	—	100-0	—

¹ Of these, 77,409 went to the Cape of Good Hope and Natal.

² Of these, 152,797 went to the Cape of Good Hope and Natal.

³ Of these, 69,052 went to the Cape of Good Hope and Natal.

it was speedily resumed on an enlarged scale owing especially to the improved means of ocean transportation. It culminated in the decade 1880-1890, and declined after the commercial crisis of 1893. Later there was another increase.

The relative movement of nationalities is best presented by the statistics of the United States. The nationality (country of origin of immigrants coming to the United States, 1871-1895) is shown in the following table:—

Nationality of Immigration to the United States.

	25 Years 1871-1895.	Per cent. of Total Immigration
Anglo-Saxons, Celts, and Welshmen—		
England and Wales	1,334,817	12-9
Scotland	286,807	2-8
Total	1,621,624	15-7
Irish—Ireland	1,334,635	12-9
Teutons—		
Austria	374,872	3-6
Germany	2,607,562	25-3
Netherlands	96,935	0-9
Total	3,078,469	29-8
Latins—		
Belgium	42,447	0-4
France	148,683	1-4
Italy	655,104	6-3
Spain	14,292	0-2
Portugal	17,108	0-2
Total	877,634	8-5

A very important transformation has taken place in the proportionate number coming from different countries during the last half of the 19th century. At first the Irish and Germans were most prominent. Of later years, the Italians, Czechs, Hungarians and Russians were, as will be seen from the following table, numerously represented.

Nationality of Immigrants to the United States, 1901-1905.

	Number.	%
Austria-Hungary	944,239	25.0
Belgium	16,884	0.44
Bulgaria, Servia and Montenegro	6,637	0.17
Denmark	35,918	0.9
France	31,119	0.8
Germany	176,995	4.6
Greece	49,962	1.3
Holland	18,501	0.48
Italy	959,768	25.0
Norway	103,065	2.7
Portugal	30,532	0.8
Rumania	35,185	0.4
Russia	658,735	17.0
Spain	10,243	0.27
Sweden	154,607	4.0
Switzerland	17,820	0.46
Turkey	10,909	0.3
United Kingdom—		
England	155,343	4.0
Ireland	184,096	4.8
Scotland	38,842	1.0
Wales	6,972	0.18
All other European countries	216	0.006
Total	3,645,018	95

The following table shows the relative number of different nationalities represented in the immigration to the United States:—

Country.	1861-70.	1871-80.	1881-90.	1891-1900.
	%	%	%	%
Great Britain	24.5	16.4	12.5	7.5
Ireland	18.8	15.5	12.5	10.0
Germany	34.0	25.5	27.7	14.0
Austria-Hungary	0.3	2.6	6.7	16.0
Norway and Sweden	4.7	7.5	10.8	8.6
Russia and Poland	0.2	1.9	5.1	14.0
Italy	0.5	2.0	5.9	18.0

Sex and Age.—Of all the immigrants (1871-1895), 61.25% were males and 38.75% were females.

This percentage remains fairly constant, but the proportion differs somewhat among different nationalities. The following table shows the proportions for 1905:—

	Males.	Females.
Austria-Hungary	207,034	77,933
France	5,574	3,889
Germany	21,586	15,357
Holland	3,082	1,758
Italy	216,268	51,273
Russia	111,795	66,065
Sweden and Norway	29,907	18,105
United Kingdom—		
England	29,993	18,160
Ireland	18,754	18,890
Scotland	9,264	5,022

The immigrants were in the most vigorous period of life, few children and few old people, as shown in the following table:—

Ages of Immigrants to the United States, 1881-1890.

Country of Origin.	Under 15.		From 15 to 40.		Over 40 years.	
	Number.	Per cent.	Number.	Per cent.	Number.	Per cent.
Germany	386,934	26.6	904,002	62.2	162,034	11.2
Ireland	92,308	14.1	515,089	78.6	48,085	7.3
England	151,315	23.5	420,303	65.2	73,062	11.3
Sweden and Norway	104,254	18.3	414,609	73.0	49,499	8.7
Italy	47,603	15.3	212,475	69.2	47,771	15.5
Russia (including Poland)	65,427	24.7	174,754	65.9	24,907	9.4
Austria	50,027	22.1	149,909	66.3	26,109	11.6
Scotland	36,192	24.2	97,819	65.2	15,858	10.6
Hungary	18,785	14.7	95,635	74.9	13,261	10.4

Occupation.—The immigrants are for the most part unskilled labourers. The statistics for the United States show the following figures for the years 1881-1890:—

Occupation of Immigrants to the United States.

	Males.	Females.	Total.
Professional	25,257	1,749	27,006
Skilled	514,552	25,850	540,411
Miscellaneous	1,833,325	243,810	2,077,135
Not stated	73,327	42,830	116,157
Without occupation	759,450	1,724,454	2,483,904
Total	3,205,911	2,040,702	5,246,613

Those "without occupation" are mostly women and children. The "miscellaneous" are day labourers. It is probable that about 20% of the adult males are "skilled."

Immigration to Other Countries.—In no other country is immigration conducted on so important a scale as in the United States. The statistics are very imperfect. The main figures have already been given in the table of emigration. Australia has an annual immigration of about 250,000, mostly of British origin. This is offset by a very heavy emigration, which sometimes exceeds the immigration in certain of the states. The immigration to Canada for the year 1905 was put down as 146,266, but a portion of this consisted of immigrants passing through to the United States. Brazil has had a large immigration (in 1895 equal to 169,524, but in 1904 only 12,447). The Argentine is credited with an immigration in 1905 of 177,117, and Uruguay with an immigration in 1903 of 6247. In all the South American immigration the countries principally represented are those of southern Europe, especially Italy. The majority of the immigrants are adult males and farm labourers.

Balance of Emigration and Immigration.—Even in the case of emigration from Europe to countries beyond the seas there is some return movement. Emigrants who have been successful in business return in order to end their days in the old country. Those who have not succeeded return in order to be cared for by friends and relatives, or simply from home-sickness. Thus, for Great Britain and Ireland, while the emigration of persons of British and Irish origin was, in 1905, 262,077, the immigration of persons of the same category was 122,712, leaving a net emigration of only 139,365. In the United States' statistics we cannot distinguish in the outgoing passenger movement emigrants from other persons. But if for a period of years we take the total inward passenger movement and subtract from it the total outward passenger movement, we ought to have the net immigration. By this method we arrive at the conclusion that while the gross immigration during the five years 1901-1905 was 3,833,076, the net immigration was only 1,779,976, showing an outward movement of 2,053,100, or about 7.12% of the total number of immigrants.

Temporary Emigration.—In many European countries there is not only emigration beyond seas, but a very considerable movement to neighbouring countries in search of work, and generally with the intention of returning. Thus in Italy, the "permanent" emigration (i.e. to countries beyond seas) numbered, in 1905, 447,083; the "temporary" emigration to European or Mediterranean countries amounted to 279,248. This temporary emigration is strongest in the spring, and consists principally of adult males (agriculturists, farm and day labourers, bricklayers and masons) in search of work. It resembles somewhat the movement of Irish labourers into Great Britain at harvest time. It is notorious that the Italians who emigrate to the United States largely return.

Effects of Emigration.—There are two views with regard to emigration: one unfavourable, viz., that it is a drain on population, reducing its economic strength and disturbing social and political relations; the second looking upon it as a relief from over-population and a congested labour market. As a matter of fact, emigration has not succeeded in diminishing the population of Europe, which, on the contrary, doubled during the 19th century. The one great exception is Ireland, where population declined from 8,175,124 in 1841 to 4,458,745 in 1901. From 1851 to 1901 the total emigration from Ireland was 3,881,246 or 72.5% of the average population. Emigration, by causing the young men and women, also reduced the Irish marriage and birth-rates, which were almost the lowest in Europe. But hitherto the countries of strongest emigration (England, Germany, &c.) have shown practically undiminished birth and marriage-rates and a steady growth in population.

The intensity of emigration is measured not by the absolute number of emigrants, but by the number of emigrants to the total population. Its effect is shown by comparing the number of emigrants with the excess of births over deaths per 1000 of the population. This is shown in the following table (1905):—

	Excess of births over deaths per 1000 inhabitants.	Emigrants per 1000 inhabitants.
Great Britain and Ireland	11.4	6.06
England and Wales	12.0	4.96
Scotland	12.2	8.45
Ireland	6.3	11.42
Germany	13.2	4.45
Switzerland	9.5	1.45
Sweden (1903)	10.6	6.89
Norway	12.6	9.11
Denmark	13.5	3.12
Italy	10.6	14.33
Austria-Hungary	12.2	6.29

It will be observed that, with the exception of Ireland and Italy, wherever there is a heavy emigration there is usually a considerable excess of births over deaths, i.e. natural increase more than makes up for the loss by emigration. Even taking Great Britain and Ireland together, the loss by emigration per annum has not been very large, as is shown by the following table:—

Annual Emigration per 1000 of the Average Population of Great Britain and Ireland.

1853-1855	8.4	1881-1890	7.1
1856-1860	4.3	1891-1895	5.1
1861-1870	5.2	1896-1900	3.7
1871-1880	5.1	1901-1905	5.5

Even in particular districts where emigration is heavy the loss is made up by births. For instance, in 1891 the emigration from the provinces of West Prussia and Posen was extraordinarily heavy—10.9 and 10.4 per mille respectively—but the excess of births over deaths was 19.6 per mille. Emigration may give temporary relief to congested districts, but it is not in itself a remedy for so-called over-population.

It is difficult to analyse closely the economic effect of emigration, because so much depends upon the character of the emigrants and the condition of the labour market. The following considerations have been urged at different times: Although emigration does not diminish population, yet, as the emigrants are in the most productive period of life (15 to 45), the country of emigration loses adults and replaces them with children. It thereby loses the cost of rearing that number of people to adult age, and is left with a disproportionate number of children and old people. The age distribution of the population of Ireland lends some support to this view. In the same vein it is urged that voluntary emigration takes away the cream of the working-classes. It is the man of energy, of some means, of ambition, who takes the chances of success in the new country, leaving the poor, the indolent, the weak and crippled at home. It is maintained that such emigration institutes a process of selection which is unfavourable to the home country.

On the other side, it is said that the men who are doing well at home are the ones least likely to emigrate, because they have least to gain. Modern means of transportation have made the voyage so cheap that almost any one is able to go. It is therefore the restless, the unsuccessful, or at least those not fitted for the strenuous competition of the older countries, who are tempted to go. Emigration affords a natural outlet for the superfluous labour force of a country. The supply of labour is somewhat reduced, but wages are kept up for those who remain. Those who go find means of bettering their own condition beyond the seas, where they become producers of food and raw material for the home country, and at the same time customers for her manufactured products. Emigration is, therefore an economic gain, both directly and indirectly. It is evident from these arguments that no general answer can be given to the question. In some cases it may be an evil; in most, when conducted under normal conditions, it would seem to offer little danger.

The same remark would hold true in regard to the social and political effects of emigration. In some cases, by taking away the strong, self-reliant and energetic, it may result in the deterioration of the home population. In other cases it allows restless spirits who have failed at home to try again elsewhere. Often in cases of political revolution the members of the defeated party have sought refuge elsewhere, as after the revolutionary movements of 1848. In case of conquest the conquered nationality takes to emigration on an extensive scale, as after the absorption of Alsace-Lorraine by Germany in 1871. The movement may be aided either by the state or by private associations. Of such character have been the state-aided emigration from Ireland, and the assisted emigration of paupers, criminals and other persons in the effort to relieve a congested population, or simply from the desire to get rid of undesirable members of the community. Such efforts fail if the new countries are unwilling to admit these persons. Finally, we have the expulsion of the Jews from Russia as an example of the effort of a community to get rid of an element which has made itself obnoxious to the local sentiment.

Effects of Immigration.—The effects of emigration are negative in character; those of immigration are positive. (a) On population: immigration, of course, is a direct addition to the population of new countries, and greatly accelerates the growth by natural increase, especially as the immigrants are in the most productive ages of manhood and womanhood. In the United States, for instance, out of a population of 76,303,387 (in 1900), there were 26,147,407 persons who were either foreign-born or who had one or both parents foreign-born. This does not mean that the population would have been twenty-six millions less if it had not been for immigration; for the rate of natural increase among the native-born might have maintained itself. Nevertheless, immigration has probably stimulated the growth of population. (b) Economic effects: The economic gain of immigration to new countries is evident. It adds directly to their available labour force, that is, to the number of adults engaged in the work of producing wealth.

According to the United States census of 1900, out of 29,073,233 (1900) persons engaged in gainful occupations, 5,851,399 or 20.1% were of foreign birth. If we add to these the native whites of foreign parentage (5,300,924) we have 11,152,323 persons of foreign extraction or 39.4% of the total labour force. The foreign whites alone constituted 10.4% of the total number of persons engaged in agricultural pursuits; 11.4% of those in professional services; 25.7% in domestic and personal services; 19.2% in trade and transportation; and 30.6% of those engaged in manufacturing and mechanical industries. In addition to these, the native whites of foreign parentage constituted, in agriculture, &c., 10.6%; in professional service, 20.6%; in domestic and personal service, 16.4%; in trade and transportation, 25.7% in manufacturing and mechanical, 25.4% of all those engaged in these occupations. The labour force of the United States is thus made up very largely of immigrants and the children of immigrants.

Attempts have sometimes been made to put a money value on the economic gain by immigration. The amount of money brought by the immigrants is not large, and is probably more than offset by the money sent back by immigrants for the support of families and friends at home or to aid them in following. The valuable element is the able-bodied immigrant himself as a factor of production. It is said, for instance, that an adult slave used to be valued at from \$800 to \$1000, but that an adult immigrant would be looked upon as worth that sum to the country. Or, it is said, a boy of ten, an immigrant represents what it would cost to bring up a child from infancy to the age, say, of 15. This has been estimated by Ernst Engel as amounting to \$550 for a German child. The most scientific procedure, however, is to calculate the probable earnings of the immigrant during the rest of his lifetime, and deduct therefrom his expenses of living. The remainder represents his net earnings which he will contribute to the well-being of the new country. W. Farr reckoned this to be, in the case of unskilled English emigrants, about £75. Multiplying the total number of adult immigrants by any one of these figures, we get the annual value of immigration. Such attempts to put a precise money value on immigration are futile. They neglect the question of quality and of opportunity. The immigrant is worth what it has cost to bring him up only if he is able-bodied, honest and willing to work. If he is diseased, crippled, dishonest or indolent, he may be a direct loss to the community instead of a gain. So, too, the immigrant is worth his future net earnings to the community only if there is a demand for his labour.

Social and Political Effects of Immigration.—The influx of millions of persons of different nationality, ten of a foreign language and generally of the lower classes, would seem to be a danger to the homogeneity of a community. The United States, for instance, has felt some inconvenience from the constant addition of foreigners to its electorate and its population. The foreign-born are more numerous represented among the criminal, defective and dependent classes than their numerical strength would justify. They also tend to segregate more or less, especially in large cities. Nevertheless, the process of assimilation goes on with great rapidity. Inter-marriage with the native-born occurs to a considerable extent. The influence of the physical environment leads to the adoption of the same mode of life. The most powerful influences, however, seem to be social. These are common school education and the adoption of one language (English); participation in political life, which is granted to all adult males after five years' residence; and the general influence of social standards embodied in laws, institutions and customs already established. Doubtless immigration in the last fifty years of the 19th century had a modifying effect on American life; but on the whole the power of a modern civilized community working through individual freedom to assimilate its elements is differing from it too radically has been displayed to render it doubtful.

Restriction of Immigration.—New countries have sought to escape certain evils of indiscriminate immigration. These evils were as follows: (a) The immigration of criminals, paupers, persons diseased in mind or body, and persons unable to support themselves. By the Acts of 1882 and 1893 such persons were refused admission to the United States, and, when rejected, the steamship companies that brought them were compelled to take them back. The number debared from 1896 to 1905 is shown in the following table:—

Causes.	1896	1897	1898	1899	1900	1901	1902	1903	1904	1905
Insane	10	6	12	19	32	16	27	23	33	92
Paupers	2010	1277	2261	2599	2974	2798	3944	5812	4798	7898
Diseased	2	1	258	348	393	309	7-9	1773	1560	2198
Assisted	—	3	79	82	2	50	—	9	38	19
Convicts	—	1	2	8	4	7	9	51	35	39
Prostitutes	—	—	—	—	7	3	3	13	9	24
Contract Labourers	776	328	417	741	833	327	275	1086	1501	1164
All other	1	1	1	1	1	6	7	2	20	445
Total debarr'd	2799	1617	3030	3798	4246	3516	4974	8769	7994	11,879

No law of international comity is violated by the refusal to receive these unfortunates. They should be taken care of at home. The English legislature in 1905 passed an act to prevent the landing of undesirable aliens, and the number refused admission in 1906 was 493. (b) Immigration sometimes increases the competition in the labour market, and thus lowers wages. One case is particularly aggravating, viz. when employers import foreign labourers in order to take the place of their men who are on strike. In 1885 the United States passed what is called the Contract Labour Law, forbidding the landing of any person who is under contract to perform labour in the United States. It is very difficult to discover such cases, but the number rejected is fairly large (see table above). (c) The immigration of men of alien race who refuse to assimilate with the natives is said sometimes to be a danger to the country. This at least is the excuse for the entire exclusion of Chinese labourers from the United States since 1882 (provisions made more severe in 1888 and 1892) (see also the article COOLIE).

Internal Migration.—In modern times there is constant movement of population within national lines, from section to section, and especially from rural districts to the cities. No record is kept of this, and we can trace it only through the census statistics of birthplace. In the United States, for instance, it was shown in 1890 that more than 21.5 per cent. of the native-born inhabitants were living in a state other than that in which they were born. Still further, it appears that about one-half of the native-born inhabitants had moved out of the county in which they were born. In 1890 there were 1,233,629 natives of the state of New York living in other states. The movement is principally westwards in direction and along parallels of latitude. For instance, New York has made large contributions to the population of Ohio, Michigan, Illinois, Wisconsin, Iowa and so on. Virginia has contributed largely to the population of West Virginia, Kentucky, Ohio, Indiana, Illinois and Missouri. In Europe there is a similar movement; but it is difficult to make comparisons, because of the differences in the administrative areas. In England in 1891, 71.6% of the population were residing in their native county; in Prussia, 69.7% in the *kreis*; in France, 81.7% in the department; in Austria, 80.2% in the *bezirk*; in Switzerland, 82.1% in the canton where they were born (Weber, *Growth of Cities*, p. 249). The most important phase of internal migration is the movement from the rural districts to the cities. The statistical results are shown in the following table extracted from the admirable work of Weber, just quoted:—

Percentage of Population living in Towns of 10,000 and over at Three Periods.

	About 1800 or 1801.	About 1850 or 1851.	About 1890 or 1891.
England and Wales	21.3	39.5	61.7
Scotland	17.0	32.2	50.0
Australia (7 colonies)			41.4
Belgium	13.5	20.8	34.8
Netherlands	29.5	29.0	31.3
Prussia (1816)	7.3	10.6	30.0
United States	3.8	12.0	27.6
France	9.5	14.4	25.9
Denmark	10.9	9.6	23.6
Italy	—	—	20.6
Ireland	7.8	10.1	18.0
Norway	4.3	5.3	16.7
Switzerland (1822)	3.3	7.3	15.8
Austria	4.4	5.8	15.8
Hungary	5.4	9.1	16.1
Sweden	3.9	4.7	13.7
Portugal	12.7	2.9	12.7
Russia	3.7	5.3	9.3

Everywhere the city population is increasing faster than the rural. In the United States the rate of increase per decade was as follows:—

Year.	United States.	In Towns of 8000 and over.	Rural Districts.
	%	%	%
1790-1800	35.1	60	34
1800-1810	36.4	69	35
1810-1820	33.0	63	33
1820-1830	33.6	62	31
1830-1840	32.7	68	30
1840-1850	35.9	99	30
1850-1860	35.6	75	30
1860-1870	22.6	59	15
1870-1880	30.1	40	27
1880-1890	24.9	61	15
1890-1900	20.8	37	14

In England and Wales the rural population increased in the aggregate during the first half of the 19th century, but at a gradually diminishing rate; in the second half of the century the population declined with varying regularity, until the decennium 1891-1900, when there was an increase. But notwithstanding this aggregate increase there are many rural districts which still show a steadily declining population. The urban population is increasing, as shown in the following table:—

Decennial Rate of Increase or Decrease.

Year.	Urban.	Rural.
	%	%
1851-1861	+21.9	+1.88
1861-1871	+28.1	-5.86
1871-1881	+28.1	-3.84
1881-1891	+25.6	-2.76
1891-1900	+15.22	+2.94

Somewhat the same phenomenon is seen in France. According to the census of 1891 not less than 55 out of the 87 departments had decreased in population; and out of the 32 that had increased, 7 showed a decrease in their rural parts when the large towns were deducted. In Germany the towns of 10,000 and over show a much more rapid increase than the rural districts; and the same fact is generally true of the other countries of Europe. This more rapid increase of population in cities is due only in part to migration from the country. Until the 19th century deaths generally exceeded births in cities, so that if it had not been for constant immigration the cities would not only not have grown, but would have decreased in population. Cities grow more rapidly now than formerly, because the excess of deaths over births has been turned into an excess of births over deaths. Thereby the cities are becoming less dependent upon immigration for increase of population than formerly, but the migration still goes on. The causes of migration from country to city are mainly economic. In early stages of culture men are scattered over the country, or at most gathered together in hamlets and villages. Each of these is self-sufficing, having its own artisans and handicraftsmen, and producing what it needs. With the beginning of exchange commercial centres spring up, situated on navigable streams and especially at points where land and water journeys are broken. With the growth of manufactures, industrial centres spring up where the division of labour can be fully provided for. In modern times two factors have accelerated this process, viz.: (1) the building of railways, which have developed commerce to a very great degree and favored the large towns at the expense of the small; and (2) the invention of machinery, which has greatly increased the possibility of division of labour and manufactures on a large scale. The old handicraftsmen has been superseded by machine labour and the village artisan by the factory hand. At the same time improvements in agriculture and the opening up of new countries have enabled the modern community to gain its food and raw material with a less expenditure of labour force, and the surplus agricultural population has gone to the city. The attractive influences upon individuals have been higher wages, greater scope for the ambitious, and the social advantages of city life.

The general laws of internal migration may be summarized (according to Ravenstein) as follows:—

1. The great body of migrants proceed only a short distance.
2. The process of absorption goes on as follows: The inhabitants of the country immediately surrounding a town of rapid growth flock into it; the gaps thus left in the rural population are filled up by migrants from more remote districts, until the attractive force of one of the rapidly-growing cities makes its influence felt, step by step, to the most remote corner of the land. Migrants enumerated in a certain centre of absorption will consequently grow less with the distance, proportionately to the native population which furnishes them.
3. The process of dispersion is the inverse of that of absorption, and exhibits similar features.

4. Each main current of migration produces a compensating countercurrent.

5. Migrants proceeding long distances generally go by preference to one of the great cities of commerce or industry.

6. The natives of towns are less migratory than those of the rural parts of the country.

7. Females are more migratory than males.

ANNOUNCES.—The statistics of migration are to be found in the official returns of different countries, especially the statistical tables relating to emigration and immigration published by the British Board of Trade, and the Reports (annual) of the Commissioner-General of Immigration of the United States. For general discussion see Philippovich, *Auswanderung und Auswanderungspolitik* (Leipzig, 1892). An exhaustive bibliography will be found in an article by same author, "Auswanderung," in *Handwörterbuch der Staatswissenschaften*; R. Mayo-Smith, *Emigration and Immigration*, with bibliography (New York, 1890). For internal migration see A. F. Weber, *Growth of Cities* (New York, 1899). See also Ravenstein, "The Laws of Migration," in *Journal of Royal Statistical Society* (1885 and 1889). Professor Flinders Petrie, in his Huxley Lecture for 1906 on *Migrations* (reprinted by the Anthropological Institute), deals with the mutations and movements of races from an anthropological standpoint with profound knowledge and originality.

(R. M.-S.; T. A. I.)

MIGRATION, in Zoology. In zoology considerable importance attaches to the problems of migration, by which is meant the wandering of living creatures into another, usually distant, locality in order to breed there; this implies a return, and the double phenomenon is annual. All other changes of the abode are either sporadic, epidemic, or fluctuating within lesser limits. Further, migration should not be confounded with "spreading," which proceeds steadily, and in epicycles, with a totally different result. It need not be emphasized that hard and fast lines between these phenomena do not exist; they are often a question of degree. For instance, when the common toad, which is a strictly terrestrial creature, wanders every spring to a frequently distant pool in order to spawn there, this is a true migration. The same applies, strictly speaking, to those insects which hibernate in the ground, at the root of the tree on which they feed and breed. The grey plover breeds in the arctic circle and winters in equatorial countries. To complicate matters further, it is not necessary that the migration be undertaken periodically, more than once, by the same individual. For instance, the common eel ascends the rivers as an elver in its youth; years after it returns to the sea, there to breed and to die, whilst other fishes come and go, year after year. Further, some of the larger birds, for instance swans and cranes, are still immature in their second year, and yet they migrate like their older relations. It seems permissible to use this fact as an indication that the breeding as such is not the prime reason of their wanderings. The fundamental impelling agent must have been the want of food, and what we usually understand by migration cannot suddenly have sprung into existence to its full extent, but is more likely the cumulative effect of the doings of countless generations. The faculty of shifting the abode was of course always there, the necessity of moving further on was also present, and those which went in the wrong direction came to grief, while the others flourished and returned with their progeny. They did not at first cover enormous distances, but just enough to find unoccupied ground. The annual repetition became an established habit, at last an ineradicable instinct. There can be but little doubt that the prime impulse was want of food. The new growing grass on the prairie or on the veldt attracts every year those creatures which live upon pasture. The inter-tropical belt of the world is so crowded with creatures that there is the keenest competition, whilst in the temperate and cold regions is a long winter quiescence unfit for the support of many creatures, whereas in the summer these same regions are covered with new vegetation, with its concomitant abundance of insects and other invertebrates. The tables are decked again, and these opportunities are not wasted.

The process of migration, in its most striking cases, is now very complicated. Many a bird goes actually to the arctic regions for the shortest of summers, but spends most of the year within the tropics. On the other hand there are many

species which do not go so far north, but stop to breed in the intermediate regions. We must not take the extremes when trying to unravel the development of the problem. The periodical migrations of mammals, with their more limited extent and greater leisure, are less perplexing.

It has been argued with some show of reason that the real home of a bird is that country in which it was born, in other words where the species breeds, but this is not in every case a valid conclusion. It applies to most creatures, but it can well bear exceptions if we leave sentiment aside. When it comes to a question of domicile, the ten weeks' sojourn of the swift, *Cypselus*, in England are more than weighted down by the nine months or more which these birds spend in southern countries, although we do not know whether they are resident there or roam about. The breeding time is the busiest period of a bird's life; then the numbers of each species are suddenly multiplied, and so is the stress of providing food, and the particular food which is best for the young may not be available in every country. The idea that the arctic circle is the original home of the numerous kinds of birds which breed in it, whence they are now periodically driven away by stress, has been coupled with the glacial epoch, that supposed solution of so many difficulties. We have only to assume that the old, permanent home of these migrants was in the arctic region, that the progressing glaciation drove them away, of course towards the equator, and that, when times improved again, the birds returned to their old home. This sounds very plausible, but it involves huge assumptions. The birds, not the individuals, but the species, are supposed to have inherited such a loving reminiscence of their old home, that after thousands of years—with most of the small birds meaning as many generations—they returned at the first opportunity. It implies that their long continued sojourn in foreign lands, where—under this assumption—thousands of generations must have been bred and have spent all their lives, was not sufficient to naturalize them, so to speak, in their words to supplant the instinctive love of the primary ancient home. That the last glacial epoch has driven the limit of many kinds of animals and plants farther south is as certain as that many have recovered the lost ground after the reversion of the glaciation, but it must have been a very slow and steady process of spreading. It may, and probably does, account for the present annual visitations of arctic lands, as a phenomenon which has been evolved *de novo*, which would have come to pass even if no birds had existed in pre-glacial times.

How do birds manage to find their way, thousands and thousands of miles across land and water? This question has been extolled as a mystery of mysteries. It has been stated that the old birds show the way to the young, a speculation which does not apply to those many cases in which old and young notoriously travel at different times. It has been assumed that they travel by sight, taking advantage of certain landmarks; another untenable idea, since—experience having to be excluded in a flock of birds which made the journey for the first time—it implies that the young must have inherited the reminiscence of those landmarks! Others have likened the bird to a kind of compass, because in eastern Siberia E. von Middendorff found some migration routes to coincide with the direction of the magnetic pole. The whole question reduces itself to a sense of direction, a faculty which is possessed by nearly all animals; in some it is present to an astonishing extent; but the manifestations of this sense vary only in degree. The cat which escapes out of the bag finds its way back, directly or after many adventures. The bee, after having loaded itself with pollen, returns by the proverbial line to the hive which may be a mile away, but, move the small entrance hole in the meantime an inch to the right or left, and the bee will knock its head against the hive and blunder about; move the hive a few yards and bee after bee returning will be puzzled to find its hive again. They, maybe with the help of landmarks, have accustomed themselves to steer a course. Such instances need not be multiplied. The principle is the same whether

the journey be one of a few yards or of many miles. Given the sense of direction, it is no more difficult to steer a course due north than it is to lay one south-east by east, provided always the impetus to be on the move. There is no mystery, except that we, the most intellectual of mankind, should so well nigh have lost this sense, and even this fact is simply an instance of the loss of a faculty through long-continued use.

Birds.—(The following account is to a great extent based upon A. Newton's article "Birds" in *Ency. Brit.*, 9th ed.)

In almost all countries there are some species which arrive in spring, remain to breed, and depart in autumn; others which arrive in autumn, stop for the winter and depart in spring; and others again—and these are strictly the "birds of passage"—which show themselves but twice a year, passing through the country without staying long in it, and their transient visits take place about spring and autumn. These three apparently different categories of migrants are all acted upon by the same impulse in spite of the at first sight dissimilar nature of their movements. The species which resort to Britain and to other temperate countries in winter are simply those which have their breeding quarters much nearer the poles, and in returning to them on the approach of spring are but doing exactly as do those species which, having their winter abode nearer the equator, come to us with the spring.

The birds-of-passage proper, like our winter visitants, have their breeding quarters nearer the pole, but like our summer visitants, they seek their winter abode nearer the equator, and thus perform a somewhat larger migration. As H. Seebohm puts it (*Geograph. Distrib. of the Family Charadriidae*, London):

"They all represent birds which breed in the north and winter in the south. Every migratory bird wintering in England goes north to breed, and every migratory bird breeding in England goes south to winter. It is a rule without exception in the northern hemisphere that each bird breeds in the extreme north point of its migrations. To make the rule apply to the southern hemisphere as well it must be modified as follows: each bird breeds in the coldest climate which it visits on its migrations. . . . It is a remarkable fact that whilst there are many birds breeding in the northern hemisphere and wintering in the southern, it is not known that any land-bird breeds in the southern and habitually winters in the northern! This is probably owing to the difference in the distribution of the land, there being no antartic breeding grounds. . . . Birds breeding in the tropics are always resident, except when they breed on mountains, where the climate causes them to descend into the valleys for the winter."

In many countries we find that while there are some species, such as in England the swallow or the fieldfare, of which every individual disappears at one period of the year or another, there are other species, such as the pied-wagtail or the woodcock, of which only the majority of individuals vanish—a few being always present—and these species form the so-called "partial migrants." In England the song-thrushes receive in the autumn a considerable accession in numbers from the birds which arrive from the north, though the migration is by no means so well marked as it is on the continent, where the arrival of the strangers sets all the fowlers at work. In most localities in Britain the newcomers depart after a short sojourn, and are accompanied by so many of the home-bred birds that in some parts of the island it may be safely declared that not a single song-thrush can be found from the end of November to the end of January, while in others examples can always be seen. Much the same may be said of the redbreast. Undeniably resident as a species, attentive scrutiny will reveal the fact that its numbers are subject to very considerable variation, according to the season of the year. At no time do our redbreasts collect in bands, but towards the end of summer they may be seen in the south of England successively passing onward, the travellers being mostly—if not wholly—young birds of the year; and so the great majority disappear, departing it may be safely presumed for more southern courts, since it does not break later than the markets of most towns, first in France and then in Italy, are well supplied with this species. But the migratory influence affects, though in a less degree, many if not most of the redbreasts that remain with us. Every bird of the northern hemisphere is to a greater or less degree migratory in some part or other of its range.

Want of food, and perhaps of the special, proper kind during the breeding season, seems to be the most obvious cause of migration, and none can wonder that those animals which possess the power of removing themselves from a place of scarcity should avail themselves of it, while it is unquestionable that birds possess this faculty in the greatest degree. Even among those species which we commonly speak of as sedentary it is only the adults which maintain the ground throughout the year. It has long been known that birds-of-prey customarily drive away their offspring from their own haunts so soon as the young are able to shift for themselves. The reason generally, and no doubt truly, given for this behaviour, which at first sight appears so unnatural, is the impossibility of both parents and progeny getting a livelihood in the same vicinity. The practice, however, is not limited to the birds-of-prey alone, but is much more universal. We find it to obtain with the red-

breast, and if we watch our feathered neighbours closely we shall perceive that most of them indulge in it. The period of expulsion, it is true, is in some birds deferred from the end of summer or the autumn, in which it is usually performed, until the following spring, when indeed from the maturity of the young it must be regarded as much in the light of a voluntary secession on their part as in that of an act of parental compulsion, but the effect is ultimately the same.

The mode in which the want of sustenance produces migration may best be illustrated by confining ourselves to the unquestionably migrant birds of our own northern hemisphere. As food grows scarce towards the end of summer in the most northern limits of the range of a species, the individuals affected thereby seek it elsewhere. Thus doing, they press upon the haunt of other individuals: these in like manner upon that of yet others, and so on, until the movement which began in the far north is communicated to the individuals occupying the extreme southern range of the species at that season; though, but for such an intrusion, these last might be content to stay some time longer in the enjoyment of their existing quarters.

This seems satisfactorily to explain the southward movement of all migrating birds in the northern hemisphere; but when we consider the return movement which takes place some six months later, doubt may be entertained whether scarcity of food can be assigned as its sole or sufficient cause, and perhaps it would be safest not to come to any decision on this point. On one side it may be urged that the more equatorial regions which in winter are crowded with emigrants from the north, though well fitted for the resort of so great a population at that season are deficient in certain necessities for the nursery. Nor does it seem too violent an assumption to suppose that even if such necessities are not absolutely wanting, yet that the regions in question would not supply sufficient food for both parents and offspring, the latter being at the lowest computed twice as numerous as the former—unless the numbers of both were diminished by the casualties of travel.¹ But on the other hand we must remember what has above been advanced in regard to the pertinacity with which birds return to their accustomed breeding-places, and the force of this passionate fondness for the old home cannot but be taken into account, even if we do not allow that in it lies the whole stimulus to undertake the perilous voyage.

A. R. Wallace in some remarks on the subject (*Nature*, x. 459) ingeniously suggests the manner in which the habit of migration has come to be adopted:²—

"It appears to me probable that here, as in so many other cases, 'survival of the fittest' will be found to have had a powerful influence. Let us suppose that in any species of migratory bird, breeding can as a rule be only safely accomplished in a given area; and further, that during a great part of the rest of the year sufficient food cannot be obtained in that area. It will follow that those birds which do not leave the breeding area at the proper season will suffer, and ultimately become extinct; which will also be the fate of those which do not leave the feeding area at the proper time. Now, if we suppose that the two areas were (for some remote ancestor of the existing species) coincident, but by geological and climatic changes gradually diverged from each other, we can easily understand how the habit of incipient and partial migration at the proper seasons would at last become hereditary, and so fixed as to be what we term an instinct. It will probably be found that every gradation actually exists in various parts of the world, from a complete coincidence to a complete separation of the breeding and the subsistence areas; and when the natural history of a sufficient number of species is thoroughly worked out we may find every link between species which never leave a restricted area in which they breed and live the whole year round, to those other cases in which the two areas are absolutely separated."

A few more particulars respecting migration are all that can here be given, and it is doubtful whether much can be built upon them. It has been ascertained by repeated observation that in the spring-movement of most species of the northern hemisphere the cock-birds are always in the van of the advancing army, and that they appear some days, or perhaps weeks, before the hens. It is not difficult to imagine that, in the course of a journey prolonged throughout some 50° or 60° of latitude, the stronger individuals

¹ If the relative proportion of land to water in the southern hemisphere were at all such as it is in the northern, we should no doubt find the birds of southern continents beginning to press upon the tropical and equatorial regions of the globe at the season when they were thronged with the emigrants from the north, and in such a case it would be only reasonable to expect that a complete coincidence would be the result. According to the explanation given of the southward movement of northern migrants. But, though we know almost nothing of the migration of birds of the other hemisphere, yet, when we regard the comparative deficiency of land in southern latitudes all round the world, it is obvious that the feathered population of such as nowadays exists can exert but little influence, and its effects may be practically disregarded.

² In principle F. W. Hutton had already foreshadowed the same theory (*Trans. New Zealand Inst.*, 1872, p. 235).

comes to our perception consists chiefly of the abortive or unsuccessful attempts, when birds are checked in their course, and being unable to proceed present themselves to our sight and hearing. Now for obvious reasons birds could not well fly at very great heights in very thin air, as experiments with pigeons released from balloons have shown, and the condor soaring far above the tops of the Andes is a myth. The few trustworthy instances in which birds have been observed through a telescope passing across the face of the moon have naturally yielded but vague calculations as to distance and height. W. E. D. Scott (*Bull. Nuttall Orn. Club*, vi. 97-100), computed heights varying from 1 to 2 m. F. M. Chapman's observations (*Auk*, 1888, pp. 37-39) resulted in a height of from 1500 to 15,000 ft.; average, say, 1 m. If the sky is clouded and the birds fly above the clouds the migration proceeds beyond our ken, and if for some reason or other they are below the clouds the phenomenon becomes to us very noticeable. It is well known "that on clear and bright nights birds are rarely heard passing overhead, while on nights that are overcast, mist and dark, especially if slight rain be falling, flocks may often be heard almost continuously." It is in such weather, continues Newton, that birds while migrating are most vociferous, doubtless with the result that thereby the company of fellow-travellers is kept together.

There yet remain a few words to be said on what may be termed Exceptional Migration, that is when from some cause or other the ordinary practice is broken through. The erratic movements of the various species of crossbill (*Loxia*) and some allied forms afford perhaps the best-known examples. In England no one can say in what part of the country or at what season of the year they may be met with a company of the common crossbill (*L. curvirostris*), and the like may be said of many other lands. The food of these birds consists mainly of the seeds of conifers, and as its supply in any one locality is intermittent or precarious, we may not unreasonably guess that they shift from place to place in its quest, and may thus find an easy way of accounting for their uncertain appearance. The great band of nutcrackers (*Nucifraga caryocatactes*) which in the autumn of 1844 pervaded western and central Europe (*Bull. Acad. Bruxelles*, xi. 298), may also have been actuated by the same motive, but we can explain the coming of all other birds no plausibly. The inroads of the waxwing (*B. cirrhatus*) have been the subject of interest for more than 300 years, and by persons prone to superstitious auguries were regarded as the forerunners of dire calamity. Sometimes years have passed without the bird being seen in central, western or southern Europe, and then perhaps for two or three seasons in succession vast flocks have suddenly appeared. Later observation has shown that this species is as inconstant in the choice of its summer as of its winter-quarters. One of the most extraordinary events known to ornithologists is the irruption into Europe in 1863 of the sand-grouse (*Symphotis Petraea*). Of this bird, hitherto known only as an inhabitant of the Tatar steppes, a single specimen was obtained at Sarepta on the Volga in the winter of 1848. In May 1859 a pair is said to have been killed in the government of Vilna, on the western borders of the Russian empire, and a few weeks later five examples were procured, and a few others seen, in western Europe—one in Jutland, one in Holland, two in England and one in Wales. In 1860 another was obtained at Sarepta; but in May and June 1863 a horde computed to consist of at least 700 individuals overran Europe—reaching Sweden, Norway, the Faeroes and Iceland in the north-west, and in the south extending to Sicily and Holland in the south of Spain. On the sandhills of Jutland and Holland some of these birds bred, but they were all killed off. A much greater visitation took place in 1888, which met with the same fate. The number of birds was quite incalculable, the wave extending from Norway to southern Spain.

In comparison with the periodic annual migrations of so very many birds, those of other creatures are scarce and insignificant, excepting fishes.

Mammals.—Few trustworthy observations have been recorded. The most regular and least limited migrations seem to be those of the eared seals. The walrus also goes each year to the north in the summer, further south in the winter. *Delphinapterus leucas*, one of the Cetacea, ascends the Amoor regularly on the breaking of the ice, a distance of 400 m. up the stream. Some bats are supposed to migrate. The American bison used to roam north and south, according to the season, in search of pasture; and similar periodic wanderings have often been recorded of various kinds of game on the South African veldt. They are all obviously a mere matter of convenience and have little to do with the breeding, except in the case of seal.

In one way so common as "migrations" are instructive. They are quite sporadic. When, owing to combination of some favourable circumstances they suddenly increase, enormous numbers forsake the highlands for the lowlands of Norway; not in a methodical way, but quite lawlessly; that means to say they radiate from their centres of dispersal. At any given spot, however, they seem to keep to the same direction, and no obstacles seem to divert their course. Those which arrive at the much indented coast are known even to rush into the sea, where of course they get drowned. There is no sense in this. The overcrowded condition of their

home impels them to leave, and this impulse continues blindly. They do not attempt to settle anywhere between their home and the sea. A year or two after the irruption not a lemming is there to be found, and where during their stampede they come across suitable districts, they find these already occupied by resident lemmings.

Such and similar irruptions have no doubt taken place often during the world's history; and yet such sporadic stampedes into a foreign country hardly ever lead to its regular settlement, especially when such a country possesses already a kindred fauna of its own.

Fishes.—Many fishes make periodic migrations for breeding purposes, which by their numbers and the distances travelled much resemble those of birds, but very little is known about these fishes. Take the incredible masses of herrings and their kindred; the collecting of the cod and its allies on their breeding-ground. According to D. S. Jordan (*A Guide to the Study of Fishes*, New York, 1905) some kinds are known mainly in the waters they make their breeding-homes, as in Cuba, southern California, Hawaii or Japan, the individuals being scattered at other times through the wide seas. The tunny, which has a world-wide distribution, arrives off the south coast of Portugal in the month of May; enormous numbers pass through the Straits of Gibraltar and support great fishing industries in the Mediterranean. In the month of August they return to the ocean (*A pesca do Atum no Algarve em 1898*, por D. Carlos de Braganza, Lisboa, 1899; with many maps).

Many fresh-water fishes, as trout and suckers (quoting Jordan) forsake the large streams in the spring, ascending the small brooks which are their haunts in the summer, and in greater safety. Still others, known as *anadromous* fishes, feed and mature in the sea, but ascend the rivers as the impulse of reproduction grows strong. Among such fishes are the salmon, shad, alewife, sturgeon and striped bass in American waters; *Clupea alosa*, the *Alilis shad*, and *C. finta*, the *Twait shad*, *Alepocephalus rostratus*, the "*maifisch*" of the Rhine, in Europe. "The most remarkable case of the anadromous instinct is found in the king-salmon or quinnat (*Onchorhynchus tshawytscha*), of the Pacific coast. This great fish spawns in November, at the age of four years and an average weight of twenty-two pounds. In the Columbia river it begins running with the spring freshets in March and prior to the spawning season without feeding; in the ascent of the river. By autumn the individuals have reached the mountain streams of Idaho, greatly changed in appearance, discoloured, worn and distorted. On reaching the spawning-beds, which may be 1000 m. from the sea in the Columbia, over 2000 m. in the Yukon, the female deposits her eggs in the gravel of some shallow brook. The male covers them and scrapes the gravel over them. Then both male and female drift, tail foremost, helplessly down the stream; none, so far as this is known, ever survive the reproduction act. The same habits are found in the five other species of salmon of the Pacific. The salmon of the Atlantic has a similar habit, but the distance travelled is everywhere much less, and most of the hook-jawed males drop down to the sea and recover, to repeat the act of reproduction."

Few fishes are *katadromous*, i.e. their usual habitat is in rivers and lakes, but they descend into the sea for breeding purposes. The common eel is the classical example.

Insects.—D. Sharp makes the following remarks (*Cambridge Nat. Hist.*, vi.): "Odonata are among the few kinds of insects that are known to form swarms that migrate. Of this kind have been frequently observed in Europe and in North America; they usually consist of a species of the genus *Libellula*, but species of various other genera also swarm, and sometimes a swarm may consist of more than one species.

"Locust swarms do not visit the districts that are subject to their invasions every year, but as a rule only after intervals of a considerable number of years. . . . The irregularity seems to depend upon three facts, viz. that the increase of locusts is kept in check by parasitic insects; that the eggs may remain more than one year in the ground, and yet hatch out when a favourable season occurs, and that the migratory instinct is only effective when great numbers of superfluous individuals are produced. . . . It is well established that locusts of the migratory species exist in countries without giving rise to swarms or causing any serious injuries. . . . When migration of locusts does occur it is attended by remarkable manifestations of instinct. Although several generations may elapse without a migration, it is believed that the locusts when they migrate do so in the direction taken by predecessors. They are said to take trial flights to ascertain the direction of a favourable wind, and that they alight and wait for a change of the wind. The most obvious sign of their disappearance is a spot that they have invaded. A swarm will alight on a locality, deposit there a number of eggs, and then move on. But after a lapse of a season or two there will be few or none of the species present in the spot invaded. In other cases they again migrate after growth to the land of their ancestors. It has been ascertained by the United States Entomological Commission that such return swarms do occur."

See J. A. Palmén, *Om Foglarnes Flyttningsträgar* (Helsingfors, 1874). The same in German: *Über die Zugstrassen der Vögel* (Leipzig, 1896). In this and the work of von Middendorff, already

cited, reference is made to almost every important publication on the subject of migration, which renders a notice of its very extensive literature needless here, and a pretty full bibliographical list is given in Giebel's *Thesaurus ornithologicae* (i. 146-155). Yet mention may be made of Schlegel's *Over het trekken der Vogels* (Harlem, 1828); Hodgson's "On the Migration of the *Nataores* and *Grallatores* as observed at Kathmandu" in *Asiatic Researches* (viii. 122-128), and Marcel de Serres's *Des Causes des migrations des animaux & particulièrement des oiseaux et des poissons* (Harlem, 1842). This last, though one of the largest publications on the subject, is one of the least satisfactory. S. F. Baird's excellent treatise "On the Distribution and Migrations of North American Birds," *Am. Journ. Sc. and Arts* (2nd ser. 1866), pp. 78-90, 187-192, 337-347; reprinted *Ibis* 1867, pp. 257-293. N. A. Severzoff, "Etudes sur le passage des oiseaux dans l'Asie centrale," *Bull. Soc. Nat.* (Moscow, 1880), pp. 234-287; Menzler, "Die Zugstrassen der Vögel in europäischen Russland," *op. cit.* (1880), pp. 291-369; Palmen, *Referat über den Stand der Kenntnisse des Vogelzugs*, Intern. Ornith. Congr., Budapest, 1891; W. W. Cooke and H. Merriam, *Report on Bird Migration in the Mississippi Valley*, U.S. Dep. Agric. Economic Ornithol., publ. 2 (Washington, 1888); Gaetke, *Die Vogelwarte Helgoland* (Braunschweig, 1891). In English: *Helgoland as an Ornithological Observatory* (Edinburgh, 1895); A. Newton, article "Migration," *Dict. Birds* (1893). (H. F. G.)

MIGUEL, MARIA EVARIST (1802-1866), usually known as **DOM MIGUEL**, whose name is chiefly associated with his pretensions to the throne of Portugal, was the third son of King John VI. of Portugal, and of Carlota Joaquina, one of the Spanish Bourbons; he was born at Lisbon on the 26th of October 1802. In 1807 he accompanied his parents in their flight to Brazil, where he grew up an uneducated and fanatical debauchee; in 1821, on his return to Europe, it is said that he had not yet learned to read. In 1822 his father swore fidelity to the new Portuguese constitution which had been proclaimed in his absence; and this led Carlota Joaquina, who was an absolutist of the extreme Bourbon type, and hated her husband, to seek his dethronement in favour of Miguel her favourite son. The insurrections which ensued (see PORTUGAL) resulted in her imprisonment and the exile of Miguel (1824), who spent a short time in Paris and afterwards lived in Vienna, where he came under the teaching of Metternich. On the sudden death of John VI. in May 1826, Pedro of Brazil, his eldest son, renounced the crown in favour of his daughter Maria da Gloria, on the understanding that she should become the wife of Miguel. The last named accordingly swore allegiance to Pedro, to Maria, and to the constitution which Pedro had introduced, and on this footing was appointed regent in July 1827. He arrived in Lisbon in February 1828, and, regardless of his promises, dissolved the new Cortes in March; having called together the old Cortes, with the support of the reactionary party of which his mother was the ruling spirit, he got himself proclaimed sole legitimate king of Portugal in July. His private life was characterized by the wildest excesses, and he used his power to oppose all forms of liberalism.

The public opinion of Europe became more and more actively hostile to his reign, and after the occupation of Oporto by Dom Pedro in 1832, the destruction of Miguel's fleet by Captain (afterwards Sir Charles) Napier off Cape St Vincent in 1833, and the victory of Saldanha at Santarem in 1834, Queen Christina of Spain recognized the legitimate sovereignty of Maria, and in this was followed by France and England. Dom Miguel capitulated at Evora on the 29th of May 1834, renouncing all pretensions to the Portuguese throne. He lived for some time at Rome, where he enjoyed papal recognition, but afterwards retired to Bronnbach, in Baden, where he died on the 14th of November 1866.

MIHRAB, a term in Mahomedan architecture given to the niche which in a mosque indicates the direction of Mecca, towards which the Moslems turn when praying.

MIKADO (Japanese for "exalted gate"), the poetical title associated by foreign countries with the sovereign of Japan; the Japanese title, corresponding to "emperor," is *tenno*, the term *kotei* being used of his function in relation to external affairs. By the constitution of 1889, the emperor of Japan transferred a large part of his former powers as absolute monarch to the representatives of the people, but as head of the empire

he appoints the ministers, declares war, makes peace and concludes treaties, acting generally as a constitutional sovereign but with all the personal authority attaching to his august position. The history of the mikados goes back to very early times, but from 1600 to 1868 the real power was in the hands of the shoguns, who nevertheless were in ceremonial theory always successively invested with their authority by the mikado. The revolution of 1867 restored the real power into the mikado's hands. (See JAPAN: *History*; and MUTSU-HIRO.)

MIKIRS, a hill tribe of India, occupying two or three detached tracts in Nowgong and Sibsagar districts of Eastern Bengal and Assam, known as the Mikir hills. In 1901 their total number was returned as 87,056. Mikir is the name given to them by the Assamese; they call themselves Arleeng, which means "man" in general. They have long settled down to agriculture, and are distinguished from the tribes around them by the absence of savagery. Their language, which has been studied by missionaries, seems to connect them with the Kuki-Chin stock on the Burmese frontier.

See Sir C. Lyall, *The Mikirs* (1908).

MIKLOSICH, FRANZ VON (1813-1891), Austrian philologist, was born at Luttenberg, Styria, on the 29th of November 1813. He graduated at the university at Graz as a doctor of philosophy, and was for a time professor of philosophy there. In 1838 he went to Vienna, where he took the degree of doctor of law. He devoted himself, however, to the study of Slavonic languages, abandoned the law, and obtained a post in the imperial library, where he remained from 1844 to 1862. In the former year he published a noteworthy review of Bopp's *Comparative Grammar*, and this began a long series of works of immense erudition which completely revolutionized the study of Slavonic languages. In 1849 Miklosich was appointed to the newly created chair of Slavonic philology at the university of Vienna, and he occupied it until 1886. He became a member of the Academy of Vienna, which appointed him secretary of its historical and philosophical section, a member of the council of public instruction and of the upper house, and correspondent of the French Academy of Inscription. His numerous writings deal not only with the Slav languages, but with Rumanian, Albanian, Greek, and the language of the gypsies. Miklosich died on the 7th of March 1891.

MILAN (Ital. *Milano*, Ger. *Mailand*, anc. *Mediolanum*, &c.), a city of Lombardy, Italy, capital of the province of Milan, 93 m. by rail E.N.E. of Turin. Pop. (1881), 321,839; (1906), 566,613. It is the seat of an archbishop, the headquarters of the II. army corps, the chief financial centre of Italy and the wealthiest manufacturing and commercial town in the country. It stands on the little river Olona, near the middle of the Lombard plain, 400 ft. above sea-level.

The plain around Milan is extremely fertile, owing at once to the richness of the alluvial soil deposited by the Po, Ticino, Olona and Adda, and to the excellent system of irrigation. Seen from the top of the cathedral, the plain presents the appearance of a vast garden divided into square plots by rows of mulberry or poplar trees. To the east this plain stretches in an unbroken level, as far as the eye can follow it, towards Venice and the Adriatic; on the southern side the line of the Apennines from Bologna to Genoa closes the view; to the west rise the Maritime, Cottina and Graia Alps, with Monte Viso as their central point; while northward are the Pennine, Helvetic and Rhaetian Alps, of which Monte Rosa, the Saasgrat and Monte Leone are the most conspicuous features. In the plain itself lie many small villages; and here and there a larger town like Monza or Saronno, or a great building like the Certosa of Pavia, makes a white point upon the greenery. The climate is changeable and trying; in summer it is intensely hot, in winter very cold. Snow is often seen, and the thermometer is frequently below freezing-point.

In shape Milan is a fairly regular polygon, and its focus is the splendid Piazza del Duomo, from which a number of broad modern streets radiate in all directions. These streets are connected by an inner circle of boulevards, constructed just outside the canal, which marks the site of the town moat. The

arches of Porta Nuova are almost the last trace of the inner circuit, constructed after the destruction of the city by Frederick Barbarossa, to which also belonged the Porta dei Fabbri, demolished in 1000. Curious reliefs from the Porta Romana are to be seen in the museum. Within this circle the majority of the streets are narrow and crooked, while those between it and the bastions, though broader on the whole, have but little regularity. An outer circle of boulevards, planted with trees and commanding the view of the suburbs, lies just beyond the present walls of the city, erected by the Spaniards in the 16th century; the entire length of these boulevards is traversed by an electric tramway 7 m. long.

Occupying one end of the Piazza del Duomo is the famous cathedral. It is built of brick cased in marble from the quarries which Gian Galeazzo Visconti gave in perpetuity to the cathedral chapter. It was begun in 1386. The name of the original architect is unknown, but it is certain that many German master-masons were called to Milan to assist the Italian builders. It was then the largest church in existence, and now, after St Peter's at Rome and the cathedral of Seville, the Duomo of Milan is the largest church in Europe; it covers an area of 14,000 sq. yds. and can hold 40,000 people. The interior is 486 ft. long, 189 ft. wide; the nave is 157 ft. high, and the distance from the pavement to the top of the tower is 356 ft. The style is Gothic, very elaborately decorated, but it shows many peculiarities, for the work was continued through several centuries and after many designs by many masters, notably by Amadeo, who carried out the octagonal cupola (the pinnacle of which dates from 1774), and by Tibaldi, who laid down the pavement and designed a baroque façade. This last feature was begun after Tibaldi's design in 1615, but was not finished till 1805, when Napoleon caused the work to be resumed. With its Renaissance windows and portals this façade, though good in itself, was utterly out of keeping with the general style of the church, and in 1900 the removal of the inharmonious features was begun, to be replaced in a style strictly in accordance with the Gothic style of the rest of the building from the designs of Giuseppe Brentano. In shape the church is cruciform, with double aisles to the nave and aisles to the transepts. The roof is supported by fifty-two pillars with canopied niches for statues instead of capitals; the great windows of the choir, reputed to be the largest in the world, are filled with stained glass of 1844. To the right of the entrance is the tomb of Archbishop Heribert, the champion of Milanese liberty, while beside him rests Archbishop Otto Visconti, the founder of that family as a reigning house. The large bronze candelabrum in the left transept is said to be 13th century work. In a crypt under the choir lies the body of the cardinal saint Carlo Borromeo, who consecrated the cathedral in 1577. It is contained in a rock-crystal shrine, encased in silver, and is vested in full pontifical robes blazoning with jewels. The roof of the cathedral is built of blocks of marble, and the various levels are reached by staircases carried up the buttresses; it is ornamented with a profusion of turrets, pinnacles and statues, of which last there are said to be no fewer than 4400, of very various styles and periods. In front of the cathedral rises a colossal bronze equestrian statue of Victor Emmanuel II.

There are two noteworthy palaces in the Piazza del Duomo. The first is the Palazzo Reale dating from 1772, but occupying the site of the earliest mansion of the Viscontis and the Sforza; its great hall is a handsome chamber with a gallery supported by caryatides. Built into the palace is the ancient church of San Gottardo, a Romanesque building which was built by Azzo Visconti in 1328-1339, and was the scene of the murder of Giovanni Maria Visconti in 1412. Its campanile is a beautiful example of early Lombard terra-cotta work. The second palace is that of the archbishops, the fine façade of which is the work of Fabio Magnone. It has an older north colonnade, by some attributed to Bramante, but, like many other buildings, without sufficient evidence, and a fine court with double colonnades by Tibaldi, to whom the back façade is due. The Palazzo della Ragione, erected in the Piazza dei Mercanti, just west of

the Piazza del Duomo, the central point of the medieval city, in 1223-1238 by the podestà, Oldrado da Tresseno, whose equestrian portrait in high relief adorns it, still exists in fine preservation. It is a brick edifice with a portico on the ground floor and a large hall on the upper. Close by to the south is the beautiful Loggia degli Osii, erected in 1316, with two loggie or open porticos, one above the other, in black and white marble.

Among the most interesting buildings in Milan is the ancient church of S. Ambrogio. Here St Ambrose baptized St Augustine; here he closed the doors against the emperor Theodosius after his cruel massacre at Thessalonica; here the Lombard kings and the early German emperors caused themselves to be crowned with the iron crown of Lombardy, and the pillar at which they took their coronation oaths is preserved under the lime-trees in the piazza. The church was built by St Ambrose early in the 4th century (on the site of a temple of Bacchus it is said), but as it stands it is a Romanesque basilica of the 12th century, recently well restored (like many other churches in Milan), with a brick exterior, like so many churches of Milan and Lombardy, curious galleries over the façade, and perhaps the most perfectly preserved atrium in existence. The woodwork of the choir belongs to the original 4th century church; it has carvings with scenes from the life of David. In a great silver reliquary (modern) in the crypt lie the bones of St Ambrose, above which rises the high altar, which retains its original decorations, the only intact example of its period (835). These consist of reliefs in gold and silver enriched with enamel and gems, and are the work of one Vuolfvinius, a German. The baldacchino, with sculptures of the 12th or early 13th century, is borne by four ancient columns of porphyry, with 9th-century capitals. In the tribune are fine mosaics of the 9th century, which, Burckhardt remarks, completely break with Byzantine tradition. In the side chapel of S. Satiro are even earlier mosaics (5th century); there are also fine frescoes by Borgognone and Bernardino. The lofty brick campanile (789-824) is among the earliest in Italy, and is decorated with coloured majolica disks. The court of the neighbouring canonica is by Bramante, and so also may be the design of the cloisters of the monastery of S. Ambrogio, now the military hospital. S. Lorenzo, in the south portion of the town, dates from before A.D. 538, thus being practically contemporary with S. Vitale at Ravenna (though Burckhardt considers it to belong to about A.D. 300, and to be a part of the *thermae* or palace of Maximian), but was burnt down and restored in 1071 (in the restoration Corinthian capitals were used as bases). Thirty-three years later part of it collapsed, and a second fire followed in 1124. It was restored, but collapsed again in 1573, and a great part of it had to be reconstructed, including the tower, in 1574-80. (The tower of S. Aquilino, possibly a part of the original structure, contains mosaics of the 5th or 6th century.) In plan the church is an octagon, supported at the corners by four square towers in brick-work, which belong to the original structure. The interior with its two orders is a very fine one, and its influence on Renaissance architects has been very considerable. S. Eustorgio, one of the largest Gothic churches in Milan, with some Romanesque survivals, dates, as it stands, with its campanile, from the end of the 13th century, and has a modern façade in the old style. It has some interesting medieval works of sculpture, and a fine chapel (Cappella Martinari), with a good dome and a beautiful frieze of angels, built by Michelozzo in 1462-1468, and containing the splendid sculptured tomb (a marble sarcophagus with reliefs, supported by statues) of Peter Martyr (*q.v.*), the masterpiece of Giovanni di Balduccio di Pisa (1339); the walls of the chapel are decorated with important frescoes by Vincenzo Foppa of Brescia. S. Sempliciano, too, though originally Romanesque, is now in the main Gothic, and has been much altered.

S. Vincenzo in Prato (833), now restored to its basilican form, with nave and two aisles divided by columns and three apses, and with small, flat arcading on the exterior, which is in brickwork; S. Satiro, founded in 879; S. Babila, also restored to its original form, &c., are interesting for their Romanesque architecture. The small domed structure on the left of S. Satiro is earlier than the church, while the campanile is part of the original structure, though preceded in date by that of S. Ambrogio, which is one of the earliest genuine campanili in Italy (789-824). The reconstruction of the church of S. Satiro was Bramante's earliest work in Milan (after 1476). The choir is painted in perspective (there was no room to build one), the earliest example of this device, which was so frequently used in baroque architecture. The octagonal sacristy (before 1488), with niches below and a gallery above, with stucco decorations by Bramante himself (the frieze with putti and medallions is ascribed to Caradossò), is a masterly work, and one of his best. The Cistercian abbey-church of Chiaravalle, 5½ m. south of Milan, is a fine brick building in the plan of a Latin cross, with nave and two aisles with round pillars, with a lofty, domed tower, the so-called Romanesque Transitional style, having comparatively slender round pillars and cross vaulting, while the exterior is still quite Romanesque. It was founded in 1135 by St Bernard and consecrated in 1221. It is interesting as the model for the plan of many other churches in Lombardy, e.g. S. Maria del Carmine and

S. Francesco in Pavia. S. Marco, modernized inside, still retains a beautiful façade of 1254 and a tower—in brick as elsewhere—and contains another tomb by Balduccio. S. Maria Incontra is unique as a double Gothic church, in the horizontal sense (1451-1487).

Of the secular buildings of the beginning of the 15th century, the most notable is the Palazzo Borromeo, which still preserves its Gothic courtyard. It has a good collection of Lombard pictures. At no great distance from S. Ambrogio, in the Corso Magenta, is the church of Santa Maria delle Grazie, built by the Dominicans about 1460, to which the Gothic façade and nave belong. The choir, crossing, and beautiful sixteen-sided dome, with the elegant external decorations in terra-cotta and marble, are by Bramante (c. 1492). Adjoining the church is the convent, long used as barracks. Leading from the fine cloisters, also the work of Bramante, is the former refectory, on the walls of which Leonardo da Vinci painted his celebrated "Last Supper," a work which is unfortunately in a bad state of preservation.

Farther along the Corso, but nearer the Piazza del Duomo, is San Maurizio, the interior of which is covered by exceedingly effective frescoes by Luini and his contemporaries. The interior was erected by Giovanni Dolcebuono, a pupil of Bramante, to whom is also due S. Maria presso S. Celso (the interior and the baroque façade are by Alessi). Thence the Via Bollo leads to the Piazza della Rosa, in which is situated the renowned Biblioteca Ambrosiana, erected in 1603-1609 by Fabio Manzoni, to whom the Palazzo del Senato is also due, rich in MSS. In the same building there is also a picture gallery, in which is Raphael's cartoon for his fresco the "School of Athens" in the Vatican. Situated just within the Naviglio, the canal encircling the inner town (adjacent to San Nazaro, which contains Bernardino Lanini's [fl. 1546] masterpiece, the "Martyrdom of St Catherine"), is the Ospedale Maggiore. This institution, which can accommodate 2400 patients, was founded in the reign of Francesco Sforza. The principal court (there are nine in all) is surrounded by fine arcades of the 17th century by Ricchini. The entire edifice is covered externally with terra-cotta, and the façade, designed by the Florentine Antonio Averulino (Filarete) and begun in 1457, is superior to any other of the kind in Milan.

The city is rich in works of art, for Milan, with the introduction of the early Renaissance style by Filarete and Michelozzo after 1450, became the home of a Lombard school of sculpture, among the chief masters of which may be mentioned Giovanni Antonio Amadeo, or Omodeo,¹ of Pavia (1447-1522), Cristoforo Solari, and, the last of them, Agostino Busti, known as Bambaia (c. 1480-1548), whose work may be seen in the cathedrals of Como and Milan and in the Certosa di Pavia. Subsequently, towards the close of the 15th century, the refined court of Lodovico Sforza attracted such celebrated men as Bramante, the architect, Gauffino Franchino, the founder of one of the earliest musical academies, and Leonardo da Vinci, from whose school came Luini, Boltraffio, Gaudenzio Ferrari, Marco d'Oggiono, &c. Later, Pellegrino Tibaldi and Galeazzo Alessi of Genoa (the former a man of very wide activity) were the chief architects, and Leone Leoni of Arezzo the chief sculptor. In still more recent times Beccaria (1738-1794) as a jurist, Monti (1754-1828) as a poet and Manzoni (1785-1873) as a novelist, have won for the Milanese a high reputation.

The picture gallery of the Brera, one of the finest in Italy, occupies an imposing palace with a good courtyard by Ricchini. It was built as a Jesuit college in 1651, but since 1776 has been the seat of the Accademia di Belle Arti, and contains besides the picture gallery a library of some 300,000 volumes, a collection of coins numbering about 60,000, and an excellent observatory founded in 1766. The Brera Gallery, the nucleus of which was formed in 1806, possesses Raphael's famous "Sposizio," and many pictures and frescoes by Luini, Gaudenzio Ferrari and Bramante; the collection of the works of Carlo Crivelli (fl. 1480) affords an instructive survey of his work, which connects the Paduan school with the Venetian, here particularly well represented by works of Paolo Veronese, Paris Bordone, Gentile Bellini, Cima da Conegliano, Bonifazio, Moroni and Carpaccio. Additions are continually made to it.

The Castel Sforzesco, or Castle of Milan, stands in the Parco Nuovo; it was built in 1450 by Francesco Sforza on the site of one erected by Galeazzo II. Visconti (1355-1378) and demolished in 1447 by the populace after the death of Filippo Maria Visconti. After suffering many vicissitudes and being partially destroyed more than once, it was restored—including especially the splendid entrance tower by Antonio Averulino (Filarete, 1451-1453), destroyed by a powder explosion in 1521—in the 15th-century style

in 1893 sqq., and it is now a most imposing pile. Some of the fine windows and their terra-cotta decorations are preserved. The archaeological museum is housed here on the ground floor; besides Roman and pre-Roman objects it contains fragments of the 9th century basilica of Santa Maria in Atrona, one of the first examples of vaulted Lombard architecture; the bas-reliefs of the ancient Porta Romana of Milan, representing the return of the Milanese in 1171 after the defeat of Barbarossa; the remains of the church of Santa Maria in Brera, the work of Balduccio da Pisa; the grandiose sepulchral monument of Bernabò Visconti formerly in the church of San Giovanni in Conca; the tomb of Regina della Scala, the wife of Bernabò; the funeral monument of the Rusca family; the great portal of the palace of Pignolo Portinari, seat of the Banco Mediceo at Milan, a work of Michelozzo; a series of Renaissance sculptures, including works by Amadeo Mantegazza, Agostino Busti (sur-named Bambaia), including fragments of the tomb of Gaston de Foix. Several of the rooms occupied by the archaeological museum bear traces of the decorations executed under Galeazzo Maria and Lodovico il Moro, and one of them has a splendid ceiling with trees in full foliage, painted so as to cover the whole vaulting, ascribed to Leonardo da Vinci. In the upper rooms is placed a large collection of Milanese and central Italian ceramics, stuffs, furniture, bronzes, ivories, enamels, glass and historical relics; together with a picture gallery containing works by Vincenzo Foppa, Gianpiero, Boltraffio, Crivelli, Pordenone, Morone, Cariani, Correggio, Antonello da Messina, Tiepolo, Guardi, Potter, Van Dyck and Ribeira.

The finest of the modern thoroughfares of Milan is the Via Dante, constructed in 1888; it runs from the Piazza de' Mercanti to the spacious Foro Bonaparte, and thence to the Parco Nuovo, the great public garden in which stands the Castello Sforzesco. This park was once a national drilling ground, which was taken over by the municipality with a view to erecting upon it a new residential quarter, rendered necessary by the phenomenal growth of the city during the last twenty-five years of the 19th century. This design was happily abandoned, and around the Parco Nuovo has grown up a new quarter of wide streets, spacious gardens and private villas.

To the north of the castle is the Arena, a kind of circus erected by Napoleon in 1805; while facing the castle on the opposite side of the park is the Arco della Pace, begun by Napoleon in 1806 from the designs of Cagnola to mark the beginning of the Simplon Road, but finished by the Austrians in 1833. Leading east-north-east from the Piazza del Duomo, the centre of Milanese traffic, especially of electric trams, is the Corso Vittorio Emanuele. Connecting the piazza with the neighbouring Piazza della Scala is the famous Galleria Vittorio Emanuele, a great arcade in the form of a Latin cross, with an octagon in the centre, crowned at the height of 160 ft. with a glass cupola; it is roofed with glass throughout, and is 300 yds. long, 16 yds. wide and 94 ft. high. It has splendid façades at each end, and was constructed in 1865-1867 at the cost of £320,000; it is the finest of its kind in Europe.

In the Via Morone near the Piazza della Scala is a collection of art treasures bequeathed to the town in 1879 by a Milanese patrician, the Cavaliere Poldi-Pezzoli. It comprises valuable pictures, textile fabrics, arms, armour and a number of antiquities, and is exhibited in the house once occupied by the founder. In the middle of the neighbouring Piazza della Scala stands Magni's monument of Leonardo da Vinci (1872). Opposite is the celebrated Teatro della Scala, built in 1778 on the site of a church founded by Beatrice della Scala, wife of Bernabò Visconti. After the San Carlo at Naples it is the largest theatre in Europe, and can seat 3600 spectators. Looking on to the piazza is the fine Palazzo Marino, the seat of the municipality since 1861; it was built by Galeazzo Alessi in 1558, to whom the side façade and the court are due, but was not completed until 1890, when the main façade was erected by Luca Beltrami. S. Fedele by Tibaldi (1566) is close by. Milan has a royal scientific and literary academy with a faculty of philosophy, a royal technical institute, a school of veterinary science, a royal school of agriculture, a polytechnic with the Bocconi commercial school (founded 1808) and numerous other learned and educational institutions. Milan has long been famous as one of the great musical centres of Europe, and numerous students resort here for their musical education. There are many philanthropic institutions, the most interesting of which is the Albergo Popolare, an establishment conducted on lines similar to the houses established in England

¹ See F. Malaguzzi Valeri, *G. A. Amadeo, scultore e architetto* (Bergamo, 1905).

by Lord Rowton in 1894. Sport and athletics are provided by a number of clubs, notably the Touring Club Italiano, founded in 1894.

The modern industrial development of Milan, with its suburbs and neighbouring towns, such as Monza, Gallarate, Saronno, Busto Arsizio and Legnano, has been noteworthy. Machine-making on a large scale is carried on by firms widely celebrated for the construction of locomotives, railway trucks and carriages, steam-bolers and motors, turbines, pumps, metal bridges and roofs. Minor industries are represented by workshops for the production of surgical, musical and geodetic instruments; of telephone and telegraph accessories; dynamos, sewing-machines, bicycles and automobiles. There is also a large carriage industry. In textile industries silk holds the first place. The amount of silk handled and woven in Milan is greater than that dealt with at Lyons. Spinning and twisting are as highly developed as the weaving industry. Milan is also the centre of the Italian cotton industry. Cotton-weaving, dyeing and printing are extensively carried on. Linen, flax, jute and wool are also spun and woven. The Milanese manufactures of articles in caoutchouc and of electric cables have acquired a world-wide reputation. In typography Milan is renowned principally for its musical editions and for its heliotype and zincotype establishments. There is, besides, a huge production of posters for advertisement. The manufacture of furniture of all kinds is still extensively carried on, Milan being the chief Lombard market and centre of exportation. The towns of Cantù, Meda, Lissone and Carugo supply Milanese firms with most of their merchandise, the furniture being made by the workmen at their own homes with materials supplied by the Milanese buyers, who also advance the capital necessary for working expenses. Theatrical costumes and appliances are also made in Milan, which is an important theatrical centre. House industry is still widely diffused in Milan itself, especially as regards working in gold, silver, vulcanite, bronze and leather. The motive power for much of the house industry is supplied by electricity. The electricity is partly furnished by hydraulic works at Paderno, 24 m. from Milan; the horse-power is continually being increased owing to new needs. Gas is also much used. Milan is also a centre of the export trade in cheese; chocolate, biscuits, &c., are also manufactured.

The municipal schools of Milan are as well organized as any in Italy, and the exhibit in connexion with them at the great international exhibition of 1906 was of interest. There were, in 1907, 76 buildings for schools and 47,968 pupils, while in the evening and holiday classes there were 10,724 older pupils; 2,109,920 free rations and 215,135 paid rations were distributed to 16,526 pupils, and douches were supplied. Pizzoli's Tavolo Psicoscopico for examining the mental qualities of the pupils is of interest. The international exhibition of 1906 held in Milan was of considerable importance, all the leading states of the world taking part in it. The retrospective exhibition of means of transport was interesting in view of the recent opening of the Simplon tunnel, the occasion of the exhibition. Among the most noteworthy exhibits were those of machinery, of automobiles and bicycles, of agriculture, of transports by sea, of modern art and architecture, of Italian home industries, of the city of Milan; besides which, all the countries exhibiting had their own separate pavilions.

Until 1898 the octroi circle did not extend beyond the walls; but in that year it was found necessary, owing to the growth of the city and of municipal expenditure, to include the external quarters or Corpi Santi (a name also applied to the extramural portions of Cremona and Pavia), with their large industrial population. Since that time municipal finance has been in a prosperous condition. The water supply from wells some 150 ft. deep in the sub-soil, is fairly good; one of the towers of the Castello Sforzesco is used as a distributing centre, while the sewerage system consists of 48 m. of sewers on the single channel principle, with collectors discharging into the Vettabia, a tributary of the Lambro.

In 1860 a large cemetery, the Cimitero Monumentale, was opened, but found to be insufficient, it is reserved for important monuments, that of Musocco, 3 m. from the city, being used for general purposes.

History—(For earlier history see *MEDIOLANUM*).—After the establishment of the Lombard capital at Pavia in 569 Milan remained the centre of Italian opposition to the foreign conquest. The Lombards were Arians, and the archbishops of Milan from the days of Ambrose had been always orthodox. Though the struggle was unequal, their attitude of resolute opposition to the Lombards gained for them great weight among the people, who felt that their archbishop was a power around whom they might gather for the defence of their liberty and religion. All the innate hatred of the foreigner went to strengthen the hands of the archbishops, who slowly acquired, in addition to their spiritual authority, powers military, executive and judicial. These powers they came to administer through their delegates, called viscounts. When the Lombard kingdom fell before the Franks under Charlemagne in 774, the archbishops of Milan were still

further strengthened by the close alliance between Charles and the Church, which gave a sort of confirmation to their temporal authority, and also by Charles's policy of breaking up the great Lombard fiefs and dukedoms, for which he substituted the smaller counties. Under the confused government of Charles's immediate successors the archbishop was the only real power in Milan. But there were two classes of difficulties in the situation, ecclesiastical and political; and their presence had a marked effect on the development of the people and the growth of the commune, which was the next stage in the history of Milan. On the one hand the archbishop was obliged to contend against the heretics or against fanatical reformers who found a following among the people; and on the other, since the archbishop was the real power in the city, the emperor, the nobles and the people each desired that he should be of their party; and to whichever party he did belong he was certain to find himself violently opposed by the other two. From these causes it sometimes happened that there were two archbishops, and therefore no central control, or no archbishop at all, or else an archbishop in exile. The chief result of these difficulties was that a spirit of independence and a capacity of judging and acting for themselves was developed in the people of Milan. The terror of the Hunnish invasion, in 899, further assisted the people in their progress towards freedom, for it compelled them to take arms and to fortify their city, rendering Milan more than ever independent of the feudal lords who lived in their castles in the country. The tyranny of these nobles drove the peasantry and smaller vassals to seek the protection for life and property, the equality of taxation and of justice, which could be found only inside the walled city and under the rule of the archbishop. Thus Milan grew populous, and learned to govern itself. Its inhabitants became for the first time Milanese, attached to the standard of St Ambrose—no longer subjects of a foreign conqueror, but a distinct people, with a municipal life and prospects of their own. For the further growth of the commune, the action of the great archbishop, Heribert (1018-1045), the establishment of the carrocchio, the development of Milanese supremacy in Lombardy, the destruction of Lodi, Como, Pavia and other neighbouring cities, the exhibition of free spirit and power in the Lombard league, and the battle of Legnano, see the articles *ITALY* and *LOMBARDS*. In 1157 an almost circular moat, still preserved in the inner canal or Naviglio, was constructed round the town; but in 1162 Frederick Barbarossa took and almost entirely destroyed the city, only a few churches surviving. The city with its walls was, however, rebuilt five years later by the allied cities of Berganio, Brescia, Mantua and Verona.

After the battle of Legnano, in 1174, although the Lombard cities failed to reap the fruit of their united action, and fell to mutual jealousy once more, Milan internally began to grow in material prosperity. After the peace of Constance (1183) the city walls were extended; the arts flourished, each in its own quarter, under a syndic who watched the interests of the trade. The manufacture of armour was the most important industry. During the struggles with Barbarossa, when freedom seemed on the point of being destroyed, many Milanese vowed themselves, their goods and their families to the Virgin should their city come safely out of her troubles. Hence arose the powerful fraternity of the "Umiliati," who established their headquarters at the Brera, and began to develop the wool trade, and subsequently gave the first impetus to the production of silk. From this period also date the irrigation works which render the Lombard plain a fertile garden. The government of the city consisted of (a) a parlamento or consiglio grande, including all who possessed bread and wine of their own—a council soon found to be unmanageable owing to its size, and reduced first to 2000, then to 1500 and finally to 800 members; (b) a credenza or committee of 12 members, elected in the grand council, for the despatch of urgent or secret business, (c) the consuls, the executive, elected for one year, and compelled to report to the great council at the term of their office.

The bitter and well-balanced rivalry between the nobles and the people, and the endless danger to which it exposed the city

owing to the fact that the nobles were always ready to claim the protection of their feudal chief, the emperor, brought to the front two noble families as protagonists of the contending factions—the Torriani of Valsassina, and the Visconti, who derived their name from the office of delegates which they had held under the archbishops. After the battle of Cortenova, in 1237, where Frederick II. defeated the Guelph army of the Milanese and captured their carroccio, Pagano della Torre rallied and saved the remnants of the Milanese. This act recommended him to popular favour, and he was called to the government of the city—but only for the distinct purpose of establishing the "catasta," a property tax which should fall with equal incidence on every citizen. This was a democratic measure which marked the party to which the Torriani belonged and rendered them hateful to the nobility. Pagano died in 1241. His nephew Martino followed as podestà in 1256, and in 1259 as signore of Milan—the first time such a title was heard in Italy. The nobles, who had gathered round the Visconti, and who threatened to bring Ezzelino da Romano, the Ghibelline tyrant of Padua, into the city, were defeated by Martino, and 900 of their number were captured. Martino was followed by two other Torriani, Filippo his brother (1263-1265) and Napoleone his cousin (1265-1277), as lords of Milan. Napoleone obtained the title of imperial vicar from Rudolph of Hapsburg. But the nobles under the Visconti had been steadily gathering strength, and Napoleone was defeated at Desio in 1277. He ended his life in a wooden cage at Castel Baradello above Como.

Otto Visconti, archbishop of Milan (1262), the victor of Desio, became lord of Milan, and founded the house of Visconti, who ruled the city—except from 1302 to 1310—till 1447, giving twelve lords to Milan. Otho (1277-1295), Matteo (1310-1322), Galeazzo (1322-1328), Azzo (1328-1339), Lucchino (1339-1349) and Giovanni (1349-1354) followed in succession. Giovanni left the lordship to three nephews—Matteo, Galeazzo and Bernabò. Matteo was killed (1355) by his brothers, who divided the Milanese, Bernabò reigning in Milan (1354-1385) and Galeazzo in Pavia (1354-1378). Galeazzo left a son, Gian Galeazzo, who became sole lord of Milan by seizing and imprisoning his uncle Bernabò. It was under him that the cathedral of Milan and the Certosa di Pavia were begun. He was the first duke of Milan, having obtained that title from the emperor Wenceslaus. His sons Giovanni Maria, who reigned at Milan (1402-1412), and Filippo Maria, who reigned at Pavia (1402-1447), succeeded him. In 1412, on his brother's death, Filippo united the whole duchy under his sole rule, and attempted to carry out his father's policy of aggrandizement, but without success.

Filippo was the last male of the Visconti house. At his death a republic was proclaimed, which lasted only three years. In 1450 the general Francesco Sforza, who had married Filippo's only child Bianca Visconti, became duke of Milan by right of conquest if by any right. Under this duke the castello was rebuilt and the canal of the Martesana, which connects Milan with the Adda, and the Great Hospital were carried out. Francesco was followed by five of the Sforza family. His son Galeazzo Maria (1466-1476) left a son, Gian Galeazzo, a minor, whose guardian and uncle Lodovico (il Moro) usurped the duchy (1479-1500). Lodovico was captured in 1500 by Louis XII. of France, and Milan remained for twelve years under the French crown. In the partial settlement which followed the battle of Ravenna, Massimiliano Sforza, a protégé of the emperor, was restored to the throne of Milan, and held it by the help of the Swiss till 1515, when Francis I. of France reconquered the Milanese by the battle of Marignano, and Massimiliano resigned the sovereignty for a revenue from France. This arrangement did not continue. Charles V. succeeded the emperor Maximilian, and at once disputed the possession of the Milanese with Francis. In 1522 the imperialists entered Milan and proclaimed Francesco Sforza (son of Lodovico). Francesco died in 1535, and with him ended the house of Sforza. From this date till the War of the Spanish Succession (1714) Milan was a dependency of the Spanish crown. At the close of that war it was handed over to Austria; and under Austria it remained till the Napoleonic campaign of

1796. For the results of that campaign, and for the history of Italian progress towards independence, in which Milan played a prominent part by opening the revolution of 1848, with the insurrection of the Cinque Giornate (March 17-22), by which the Austrians were driven out; the reader is referred to the article ITALY. The Lombard campaign of 1859, with the battles of Solferino and Magenta, finally made Milan a part of the kingdom of Italy.

LITERATURE.—Pietro Verri, *Storia di Milano*; Corio, *Storia di Milano*; Cantù, *Illustrazione grande del Lombardo Veneto*; the Milanese chroniclers in Muratori's *Rer. Ital. scriptores*; Sismondi, *Italian Republics*; Ferrari, *Rivoluzione d'Italia*; Litta, *Famiglie celebri*, ss. "Torriani," "Visconti," "Sforza" and "Trivulzi"; Muratori, *Annali d'Italia*; Hallam, *History of the Middle Ages*; and *Mediolanum* (4 vols., 1881); L. Beltrami, *Il Castello di Milano* (Milan, 1894); L. del Mayno, *Vicende militari del Castello di Milano* (Milan, 1894); F. Malaguzzi Valeri, *Milano*, 2 vols. (Bergamo, 1906); and C. M. Ady, *A History of Milan under the Sforza* (1907). (H. F. B.; T. As.)

MILANESI, GAETANO (1813-1895), Italian scholar and writer on the history of art, was born at Siena, where he studied law, and in 1838 he obtained an appointment in the public library. In 1856 he was elected member of the Accademia della Crusca, in which capacity he took part in the compilation of its famous but still unfinished dictionary, and two years later was appointed assistant keeper of the Tuscan archives, in Florence; then he took charge of the famous Medici archives, whence he collected a vast body of material on the history of Italian art, not all of which is yet published. In 1889 he became director of the archives, but retired in 1892, and died three years later. His most important publication is his edition of Vasari's works in nine volumes, with copious and valuable notes (Florence, 1878-1885). Of his other writings the following may be mentioned: *Il diario inedito di Alessandro Sossini* (in the *Archivio storico Italiano*, 1842); *Documenti per la storia dell' arte senese*, 3 vols. (Siena, 1854-1856) and *Discorsi sulla storia civile ed artistica di Siena* (Siena, 1862). He also edited a number of Italian classics.

See E. Ridolfi's article in the *Nuova antologia* (May 15, 1895); and A. Virgili's article in the *Atti della regia Accademia della Crusca* (Florence, 1898).

MILAN OBRENOVICH IV. (1854-1901), king of Servia, was born on the 22nd of August 1854, at Jassy. He was the grand-nephew of the famous Milosh, whose brother Jefrem (d. 1856) had a son, Milosh (1820-1861), who married Maria Katardzi, a Moldavian. Milan was their son. While still very young, he lost both his parents, and was adopted by his cousin, Michael Obrenovich, who returned to Servia on the expulsion of the Karageorgeviches in 1858 and became ruling prince on the death of his father, Milosh, in 1860. During the reign of Michael young Milan was educated in Paris, at the Lycée Louis-le-Grand, where he displayed considerable precocity, but he was only fourteen years of age when in 1868 his cousin was assassinated and he succeeded to the throne under a regency. In 1872 he was declared of age, and taking the reins of government into his own hands, soon manifested great intellectual power, coupled with a passionate headstrong character. Eugene Schuyler, who saw him about this time, found him "a very remarkable young man . . . singularly intelligent and well-informed." By a careful balancing of the Austrian and Russian parties in Servia, with a judicious leaning towards the former, Prince Milan was enabled in 1878, at the end of the Turkish War, to induce the Porte to acknowledge his independence, and was proclaimed king in 1882. (The history of his reign is told in detail under SERVIA.) Acting under Austrian influence, King Milan devoted all his energies to the improvement of means of communication and the development of natural resources, but the cost, which was unduly increased by reckless extravagance, led to proportionately heavy taxation. This, coupled with increased military service, rendered King Milan and the Austrian party most unpopular; and his political troubles were further increased by the defeat of the Servians in the war against Bulgaria, 1885-86. In 1885 (Sept.) the union of Rumelia and Bulgaria caused widespread agitation in Servia, and Milan precipitately declared war upon his kinsman Prince Alexander on the 15th of November. After

a short but decisive campaign, the Servians were utterly routed at the battles of Slivinska and Pirot, and Milan's throne was only saved by the direct intervention of Austria. Domestic difficulties now arose which rapidly assumed a political significance. In October 1875 King Milan had married Natalie, the sixteen-years-old daughter of Peter Ivanovich Ketchko, a Moldavian Boyar, who was a colonel in the Russian army, and whose wife, Pulcheria, was by birth Princess Sturdza. A son, Alexander, was born in 1876, but the king and queen showed signs of friction. Milan was anything but a faithful husband. Queen Natalie was greatly influenced by Russian sympathies; and the couple, ill-assorted both personally and politically, separated in 1886, when the queen withdrew from the kingdom, taking with her the young prince, Alexander, afterwards king, then ten years of age. While she was residing at Wiesbaden in 1888, King Milan succeeded in recovering the crown prince, whom he undertook to educate; and in reply to the queen's remonstrances, he exerted considerable pressure upon the metropolitan, and procured a divorce, which was afterwards annulled as illegal. King Milan now seemed master of the situation, and on the 3rd of January 1889 promulgated a new constitution much more liberal than the existing one of 1869. Two months later (March 6) he suddenly abdicated in favour of his son, a step for which no satisfactory reason was assigned, and settled as a private individual in Paris. In February 1891 a Radical ministry was formed, Queen Natalie and the ex-metropolitan Michael returned to Belgrade, and Austrian influence began to give way to Russian. Fear of a revolution and of King Milan's return led to a compromise, by which in May 1891 the queen was expelled, and Milan was allowed a million francs from the civil list, on condition of not returning to Serbia during his son's minority. Milan in March 1892 renounced all his rights, and even his Servian nationality. The situation altered, however, after the young King Alexander in April 1893 had effected his *coup d'état* and taken the reins of government into his hands. Servian politics began to grow more complicated, and Russian intrigue was rife. In January 1894 Milan suddenly appeared at Belgrade, and his son gladly availed himself of his experience and advice. On the 29th of April a royal decree reinstated Milan and Natalie, who in the meantime had become ostensibly reconciled, in their position as members of the royal family. On the 21st of May the constitution of 1869 was restored, and Milan continued to exercise considerable influence over his son. The queen, who had been residing chiefly at Biarritz, returned to Belgrade in May 1895, after four years' absence, and was greeted by the populace with great enthusiasm. In 1897 Milan was appointed commander-in-chief of the Servian army. In this capacity he did some of the best work of his life, and his success in improving the Servian military system was very marked. His relations with the young king also remained good, and for a time it seemed as though all Russian intrigues were being checked. The good relations between father and son were interrupted, however, by the latter's marriage in July 1900. Milan violently opposed the match, and resigned his post as commander-in-chief; and the young king banished him from Serbia and threw himself into the arms of Russia. Milan retired to Vienna, and there he died unexpectedly on the 11th of February 1901. Milan was an able, though headstrong man, but he lived a scandalously irregular life, and was devoid of moral principle. In considering his relations with his young son, it must be remembered that in the dynastic and political condition of Serbia natural feeling was inevitably subordinated in Milan to other considerations. (H. CH.)

MILÁ Y FONTANALS, MANUEL (1818-1884), Spanish scholar, born at Villafranca del Panadés, near Barcelona, on the 4th of May 1818, was educated first at Barcelona, and afterwards at the university of Cervera. In 1845 he became professor of literature at the university of Barcelona, and held this post till his death at Villafranca del Panadés on the 16th of July 1884. The type of the scholarly reclusé, Milá y Fontanals was almost unknown outside the walls of the university till 1850, when he was appointed president of the *juegos florales* at Barcelona.

On the publication of his treatise, *De Los trovadores en España* (1866), his merits became more generally recognized, and his monograph, *De La poesía heroico-popular castellana* (1873) revealed him to foreign scholars as a master of scientific method.

MILAZZO, a seaport on the north coast of Sicily, in the province of Messina, 22 m. W. of Messina by rail. Pop. (1901), 16,422. It is mainly built on the low isthmus of a peninsula, which stretches some 3 m. farther north and forms a good harbour: but the old town, which contains a castle, mainly the work of Charles V., lies on a hill above. Milazzo is the ancient *Mylae*, an outpost of Zancle, occupied before 648 B.C., perhaps as early as 716 B.C. (E. A. Freeman, *History of Sicily*, I, pp. 395, 587). It was taken by the Athenians in 426 B.C. The people of Rhegium planted here the exiles from Naxos and Catania in 395 B.C. as a counterpoise to Dionysius' foundation of Tyndaris; but Dionysius soon took it. In the bay Duilius won the first Roman naval victory over the Carthaginians (260 B.C.).

MILDENHALL, a market town in the Stowmarket parliamentary division of Suffolk, England, 7½ m. N.N.E. from London by a branch of the Great Eastern railway from Cambridge. Pop. (1901), 3,567. It lies on the edge of Mildenhall Fen, the great Fen district stretching northward and westward from here. The church of St Andrew has an Early English chancel with fine east window and chancel arch. The remainder is principally Perpendicular with a magnificent carved oak roof, ornate north porch and lofty tower with fan tracery within. There is a wooden market cross of the 15th century; the manor house is a picturesque gabled building of the 17th century, and there is a modern public hall. Flour milling is an industry. The discovery of Roman remains indicates a small settlement.

MILDEW (O. Eng. *meledaw* or *middeaw*, explained as "mealdew," cf. Ger. *Mehlthau*, with more probability, as "honeydew," Goth. *meilith*, honey, cf. Lat. *mel*, Gr. μέλι), a popular name given to various minute fungi from their appearance, and from the sudden, dew-like manner of their occurrence. Like many other popular names of plants, it is used to denote different species which possess very small botanical affinity. The term is applied, not only to species belonging to various systematic groups, but also to such as follow different modes of life. The corn-mildew, the hop-mildew and the vine-mildew are, for example, parasitic upon living plants, and the mildews of damp linen and of paper are saprophytes (Gr. σάπρος, rotten), that is, they subsist on matter which is already dead. As regards mildews in general, the conditions of life and growth are mainly suitable nutrition and dampness accompanied by a high temperature. The life history of the same species of mildew frequently covers two or more generations, and these are often passed on hosts of different kinds. In some cases again the same generation confines its attack to the same kind of host, while in others the same generation grows on various hosts (see FUNGI; HOP; and WHEAT).

MILES, NELSON APPLETON (1839-), American soldier, was born in Westminster, Massachusetts, on the 8th of August 1839. He was engaged in mercantile pursuits in Boston when the Civil War began, and he entered the army in September 1861 as a lieutenant in the 22nd Massachusetts volunteer infantry. He served with distinction in the Peninsular campaign, and at Antietam, Fredericksburg and Chancellorsville, where he received a wound which incapacitated him up to the opening of Grant's Virginia campaign of 1864. He had been commissioned in September 1862 colonel of the 61st New York volunteers, commanded a brigade at the Wilderness and Spotsylvania, and in May 1864 was rewarded for his gallant leadership by the grade of brigadier-general of volunteers. He fought in the Cold Harbor and Petersburg operations in 1864-65, was brevetted major-general of volunteers for his conduct at Reams Station, and at the close of the war was in temporary command of an army corps. In July 1866 he was made colonel of a regular infantry regiment, and in 1867 he was brevetted brigadier-general in the regular army for his services at Chancellorsville and major-general for his services at Spotsylvania. He was promoted to be brigadier-general U.S.A. (Dec. 1880), and to be

major-general (April 1890), and in 1895 succeeded General John McA. Schofield as commanding general of the United States army. He was conspicuously successful (1899-1886) in dealing with Indian outbreaks, fighting the Cheyenne, Kiowa and Comanche on Llano Estacado (1875) and the Sioux in Montana (1876), capturing the Nez Percés under Chief Joseph (1877), and defeating the Chiricahua Apaches under Geronimo (1886), and he commanded the United States troops sent to Chicago during the railway riots in 1894. He was in nominal direction of military operations during the war with Spain in 1898, though his personal share of the operations was confined to directing the almost unopposed Porto Rico expedition. He was raised to the rank of lieutenant-general in June 1900, and retired from active service in August 1903. In 1905-1906 he was adjutant-general and chief-of-staff under Governor William L. Douglas in Massachusetts. He wrote *Personal Recollections* (1896), *Military Europe* (1898) and *Observations Abroad* (1899).

MILETUS (mod. *Palatia*), an ancient city of Asia Minor, on the southern shore of the Latmic Gulf near the mouth of the Maeander. Before the Ionic migration it was inhabited by Carians (*Iliad* ii. 876; Herod. i. 146), and pottery, found by Th. Wiegand on the spot proves that the site was inhabited, and had relations with the Aegean world, in the latest Minoan age. The Greek settlers from Pylos under Neleus are said to have massacred all the men in the old city, and built for themselves a new one on the coast. Miletus occupied a very favourable situation at the mouth of the rich valley of the Maeander, and was the natural outlet for the trade of southern Phrygia (Hipponax, *Fr.* 45). It had four harbours, one of considerable size, and its power extended inland for some distance up the valley of the Maeander, and along the coast to the south, where it founded the city of Iasus. Its enterprise extended to Egypt, where it had much to do with the settlement of Naucratis (*q.v.*). Very little "Naucratis" pottery, however, was found on the site by Wiegand, and only in the Athena temple. The Black Sea trade, however, was the greatest source of wealth to the Ionian cities. Miletus, like the rest, turned its attention chiefly to the north, and succeeded in almost monopolizing the traffic. Along the Hellespont, the Propontis and the Black Sea coasts it founded more than sixty cities—among them Abydus, Cyzicus, Sinope, Dioscurias, Panticapaeum and Olbia. All these cities were founded before the middle of the 7th century; and before 500 B.C. Miletus was decidedly the greatest Greek city. During the time when the enterprise of the seafaring population raised Miletus to such power and wealth nothing is known of its internal history, though the analogy of all Greek cities, and some casual statements in later writers, suggest that the usual struggles took place between oligarchy and democracy, and that tyrants sometimes raised themselves to supreme power. Miletus was equally distinguished at this early time as a seat of literature. The Ionic epic and lyric poetry indeed had its home farther north; philosophy and history were more akin to the practical race of Miletus, and Thales, Anaximander, Anaximenes and Hecataeus all belonged to this city. The poet Timotheus and the famous Aspasia were also natives. The three Ionian cities of Caria—Miletus, Myus and Priene—spoke a peculiar dialect of Ionic.

The Mermaid kings of Lydia found in Miletus their strongest adversary. War was carried on for many years, till Alyattes III. concluded a peace with Thrasylbus, tyrant of Miletus; the Milesians afterwards seem to have acknowledged peaceably the rule of Croesus. On the Persian conquest Miletus passed under a new master; he headed the Ionian revolt of 500 B.C., and was taken by storm after the battle of Lade (see *IONIA*). Darius massacred most of the inhabitants, transported the rest to Ampe at the mouth of the Tigris, and gave up the city to the Carians. This disaster was long remembered in Greece and made the theme of a tragedy by Phrynichus. Henceforth the history of Miletus has no special interest. It revived indeed when the Persians were expelled from the coast in 479 B.C., became a member of the Delian League (*q.v.*), revolted to Sparta in 412, passed into Carian hands, and opposed Alexander on his southward march, succumbing only to a siege in form (334 B.C.). It was a

town of commercial importance throughout the Graeco-Roman period, and received special attention from Trajan. Its harbours, once protected by Lade and the other Tragasaeon islands, were gradually silted up by the Maeander, and Lade is now a hill some miles from the coast. Ephesus took its place as the great Ionian harbour in Hellenistic and Roman times. Miletus became the seat of a Christian bishopric and was strengthened by a Byzantine castle (*ἄστρον τῶν Ἱακωβίων*) built above the theatre; but its decay was inevitable, and its site is now a marsh.

Since 1899 Miletus has been the scene of extensive excavations directed by Dr Th. Wiegand for the Berlin Academy. The ruins lie about the base of a hillock projecting north-east into a bend of the Maeander. On the north is a well-preserved theatre of Roman times on the site of an older Greek building. When complete it had 54 rows of seats. It was as large as any theatre in Asia Minor, and is still imposing, the auditorium, though deprived of its upper ranks and colonnade, rising nearly 100 ft. Cyriac of Anconca described the building as practically complete in his day (1426). The front is over 150 yds. long. East of this was the ancient north harbour, now silted up, and on the hillside above it stood a large heroön of Hellenistic time remarkable for being, like the tomb of Brasidas at Amphipolis, within the walls. South of the harbour head lies the Hellenistic agora with ruins of large magazines of Doric style. South of these again lie a nymphaeum of the age of Titus, and a senate-house of theatrical form. On the east opens a great hall surrounded by porticoes and enclosing a high altar of Artemis, once richly adorned with reliefs. The Roman agora lies beyond this again. A straight street leads south-west from the north harbour to the Didyma Gate in the wall, which runs across the neck of the peninsula and was rebuilt by Trajan, when he undertook to raise the level of the outer quarters of the city; and streets cross this at right angles in the geometric Hellenistic manner. A Sacred Way lined with tombs, led to Didymi. Two temples have been discovered by Dr Wiegand, one, on the south-east, being a large sanctuary of Apollo Delphinus with triple colonnade enclosing a court with central tripod. This seems to have been the chief temple of the city and the place where public games, treaties, &c., were engraved. The other temple, an archaic sanctuary of Athena, lies west of the stadium.

See O. Rayet and A. Thomas, *Milet et le golfe Latmique* (1877); Th. Wiegand, "Vorläufige Berichte über die Ausgrabungen in Milet," in *Sitzungsberichte der Berlin Academy* (1900, foll.); A. von Salis, "Die Ausgrabungen in Milet und Didyma" in *Neue Jahrb. f. d. k. Alt.*, xxv. 2, 1910.

MILFORD, a township of New Haven county, Connecticut, U.S.A., on Long Island Sound, separated from the township of Stratford on the W. by the Housatonic river, and about 10 m. S.W. of New Haven. Pop. (1890), 3811; (1900), 3783, including 541 foreign-born and 173 negroes; (1910), 4366. Area, about 16 sq. m. Milford is served by the New York, New Haven & Hartford railroad, and by an electric line connecting with Bridgeport and New Haven. Within its borders are various popular beaches, including Woodmont (incorporated as a borough in 1903), Pond Point, Bay View, Fort Trumbull Beach (where a fortification, named Fort Trumbull, was erected in 1776), Myrtle Beach, Meadow's End, Walnut Beach and Milford Point. The township is traversed by the Wepowag river, which here empties into the Sound. Milford is a typical old New England town, and many of the permanent inhabitants are descendants from the first settlers. The burying-ground includes the tomb of Robert Treat (1622-1710), commander of the Connecticut troops in King Philip's War, leader of the company that founded Newark, New Jersey, governor of Connecticut (from 1683 to 1698) at the time its charter was demanded by Governor Andros in 1686-1687, and deputy-governor in 1676-1683 and 1698-1708; and also that of Jonathan Law (1674-1751), governor of Connecticut from 1742 to 1751. Spanning the Wepowag river near a gorge and not far from its mouth is a granite bridge and tower, built, as a memorial to the first settlers, in 1880, in connexion with the celebration of the 250th anniversary of the founding of the town. Milford has a beautiful green of about four acres, containing a soldiers' monument. It has also the Taylor Library (founded in 1804), and along the Sound are many summer residences. Named after Milford, England, it was founded in 1639 by Rev. Peter Prudden and his followers from New Haven and Wethersfield. The land was purchased from the Indians for 6 coats, 10 blankets, 1 kettle, 12 hatchets, 12 hoes,

24 knives and 12 small mirrors. A "church-state" was immediately organized after the model of that of New Haven, but two or three years later the town bestowed suffrage on six of its inhabitants who were not church members. These citizens were an obstacle to the town's admission to the New Haven Jurisdiction, which was formed in 1643, but in the following year a compromise was effected and Milford was admitted on condition that, in the future, suffrage should be granted only to church members and that none of the objectionable six should be elected to any office of the Jurisdiction. In 1664 Milford, with the other members of the Jurisdiction, was absorbed by Connecticut; this caused considerable dissatisfaction and some of the inhabitants under the lead of Robert Treat removed to New Jersey and assisted in the founding of Newark. The regicides Whalley and Goffe were concealed in Milford from 1661 to 1664.

See M. Louise Greene, "Early Milford," in the *Connecticut Magazine*, vol. v. (Hartford, 1899).

MILFORD, a township of Worcester county, Massachusetts, U.S.A., about 16 m. S.E. of Worcester. Pop. (1890), 8780; (1900) 11,376, of whom 3342 were foreign-born; (1910 census) 13,055. Within its area of about 15 sq. m. are a large rural population and the village of Milford, on the Charles river, about 33 m. S.W. of Boston, served by the Boston & Albany, the New York, New Haven & Hartford and the Grafton & Upton railways (the last named having its passenger department operated by electricity and its freight by steam, and connecting Milford with North Grafton), and by inter-urban electric lines. The village has a memorial hall, housing the public library, and in the township there is an excellent hospital, the gift of Eben. S. Draper. The village is a shipping point for an agricultural and manufacturing district. In 1905 the value of the township's factory products was \$3,300,504 (32.8% more than in 1900). The most important manufactures are boots and shoes; the industry was established in 1795, and for many years the special product was brogans for Southern negroes. In 1908 there were 12 large granite quarries in the township (north and north-east of the village). Milford granite is the typical stone of an area reaching into Rhode Island south of the southern boundary of Providence county; it is a biotite granite of post-Cambrian age, is generally pinkish-grey in colour (owing to the large proportion of feldspar among its constituents), and is widely used for building purposes. The township was the east precinct of Mendon until 1780, when it was incorporated; in 1835 parts of Holliston and Hopkinton were annexed; in 1886 a part was separated as Hopedale.

See Adin Ballou, *History of Milford* (Boston, 1882); and T. Nelson Dale, *The Chief Commercial Granites of Massachusetts, New Hampshire and Rhode Island* (Washington, 1908), Bulletin 354 of the U.S. Geological Survey.

MILFORD HAVEN, a market town, seaport, urban district and contributory parliamentary borough of Pembrokeshire, Wales, situated on the north shore of the celebrated harbour of the same name. Pop. (1901), 5102, including the adjacent village of Hakin. Milford Haven is the terminus of a branch-line of the South Wales section of the Great Western railway. The town possesses a pier and important dock accommodation, including a graving-dock 600 ft. long, and is the centre of a valuable and increasing fishing industry. The promenade of Hamilton Terrace commands a fine view of the broad expanse of the Haven with its various towns and forts.

The present town of Milford Haven, originally a hamlet in the parish of Steynton, is of modern growth, and was first called into existence by the exertions of the Hon. R. F. Greville, nephew of Sir William Hamilton, who in 1790 laid out a town on this spot, the advantages of which as a convenient port for the Irish traffic he clearly recognized. In the opening years of the 19th century a royal dockyard was established here, but in 1814 dockyard and arsenal were removed to Paterchurch near Pembroke. The growth of the town was further checked twenty years later by the development of Neyland, or New Milford, further east on the Haven, whither the Irish packet service was transferred; but towards the close of the 19th century the town recovered much of its former prosperity. The importance of the

place is wholly due to its excellent situation on the splendid land-locked harbour, which is here 2 m. broad.

Milford Haven itself, designated by the Welsh Aberdaugleddau, as the estuary of the united East and West Cleddy rivers, has played an important part on several occasions in the course of history. Throughout Plantagenet times it formed the chief point of embarkation for Ireland. It was from Milford Haven that Henry II. set sail for the conquest of Ireland in 1172, and to this harbour he made his return journey. In 1399 Richard II. landed at Milford Haven from Ireland, shortly before his surrender to Henry of Lancaster, afterwards Henry IV., in whose reign a French fleet with 12,000 men on board sailed to the Haven and disembarked with the object of assisting the rebellion of Owen Glendower. In 1485 Henry, earl of Richmond, disembarked here on his return from France, and was welcomed on landing by Sir Rhys ap Thomas and much of the chivalry of Wales. In 1588 the leading persons of Pembrokeshire, with Bishop Anthony Rudd of St David's at their head, petitioned Queen Elizabeth to fortify the Haven against the projected Spanish invasion, upon which the block-houses of Dale and Nangle at either side of the mouth of the harbour were accordingly erected. During the 19th century numerous forts have been constructed for the protection of the Haven and of the royal dockyard at Pembroke Dock.

MILICZ, or **MILITSCH** (d. 1374), Bohemian divine, was the most influential among those preachers and writers in Moravia and Bohemia who, during the 14th century, in a certain sense paved the way for the reforming activity of Huss. The date of his birth is not known, but he was in holy orders in 1350, in 1360 was attached to the court of the emperor Charles IV., whom he accompanied into Germany in that year, and about the same time also held a canonry in the cathedral of Prague along with the dignity of archdeacon. About 1363 he resigned all his appointments that he might become a preacher pure and simple; he addressed scholars in Latin, and (an innovation) the laity in their native Czech, or in German, which he learnt for the purpose. He was conspicuous for his apostolic poverty and soon roused the enmity of the mendicant friars. The success of his labours made itself apparent in the way in which he transformed the notorious "Benatki" street of Prague into a benevolent institution, "Jerusalem." As he viewed the evils inside and outside the church in the light of Scripture, the conviction grew in his mind that the "abomination of desolation" was now seen in the temple of God, and that antichrist had come, and in 1367 he went to Rome (where Urban V. was expected from Avignon) to expound these views. He affixed to the gate of St Peter's a placard announcing his sermon, but before he could deliver it was thrown into prison by the Inquisition. Urban, however, on his arrival, ordered his release, whereupon he returned to Prague, and from 1369 to 1372 preached daily in the Teyn Church there. In the latter year the clergy of the diocese complained of him in twelve articles to the papal court at Avignon, whither he was summoned in Lent 1374, and where he died in the same year, not long after being declared innocent and authorized to preach before the assembly of cardinals. He was the author of a *Libellus de Antichristo*, written in prison at Rome, a series of *Postillae* and *Lectioes quadragesimales* in Latin, and a similar series of *Postills* (devotional tracts) in Czech.

See Count Litzow, *Life and Times of Master John Hus* (1909), pp. 27-38.

MILITARY FRONTIER (Ger. *Militärgränze*, Slav. *Granitza*), a narrow strip of Austrian-Hungarian territory stretching along the borders of Turkey, which had for centuries a peculiar military organization, and from 1849 to 1873 constituted a crown-land. As a separate division of the monarchy it owed its existence to the necessity of maintaining during the 16th and 17th centuries a strong line of defence against the invasions of the Turks, and may be said to have had its origin with the establishment of the captaincy of Zengg (a coast town about 35 m. south-east of Fiume) by Matthias Corvinus and the introduction of Uskoks (g.s.) into Croatia. By the close of the 17th century there were three frontier "generalates"—Carlstadt, Warasdin and Petrinia

or Petrinja (the last also called the Banal). After the defeat of the Turkish power by Prince Eugene it was proposed to abolish the military constitution of the frontier, but the change was successfully resisted by the inhabitants of the district; in fact a new Slavonian frontier district was established in 1702, and Maria Theresa extended the organization to the march-lands of Transylvania (the Szekler frontier in 1764, the Wallachian in 1766).¹

As a reward for the service it rendered the government in the suppression of the Hungarian insurrection in 1848, the Military Frontier was erected in 1849 into a crown-land, with a total area of 15,182 sq. m. and a population of 1,220,503. In 1851 the Transylvanian portion (1177 sq. m.) was incorporated with the rest of Transylvania; and in 1871 effect was given to the imperial decree of 1869 by which the districts of the Warasdin regiments (St George and the Cross) and the towns of Zengg, Belovar, Ivanič, &c., were "provincialized" or incorporated with the Croatian-Slavonian crown-land. In 1872 the Banat regiments followed suit; and in 1873 the old military organization was abolished in the rest of the frontier. Not till 1881, however, were the Croatian-Slavonian march-lands completely merged in the kingdoms to which they naturally belonged.

The social aspect of the military frontier régime is interesting. The *sadruga* system of land tenure was artificially kept in existence (see SERBIA). Watch-towers with wooden clappers and the beacons which flashed the alarm along the whole frontier in a few hours are still features in the landscape.

MILITARY LAW, "the law which governs the soldier in peace and in war, at home and abroad. At all times and in all places the conduct of officers and soldiers as such is regulated by military law." The above is the definition as given in the opening chapter of the *Manual of Military Law*, which is issued under the authority of the English War Office, and which is the textbook used by all English courts martial. The definition is, however, somewhat too wide, as the British system does not exclude in time of peace the action of the civil courts. In time of peace all persons who belong to the military class in most European continental countries are judged by military law and by military courts. There is also in most continental countries an intermediate stage between war and peace, known as *état de siège*, which may be declared for a fixed period for a district, or even a city, by reason of domestic insurrection or the presence of an enemy. It requires legislative enactment. Thirdly comes a state of war, when the military authorities are supreme; and whilst they can call upon the civil power to act in concert with them, the military authority is final. This is a brief summary of the system of military law that prevails in most countries of the continent. The cardinal point of difference between the British and the continental systems lies in the fact that in the United Kingdom the soldier is not only a soldier, but a citizen also; and although he may be tried for civil offences by a military tribunal, the power is not exercised in all cases. Thus treason, treason-felony, murder, manslaughter, rape, are brought before a civil court in times of peace, if the offence is committed in the United Kingdom, or if it is committed anywhere else in the king's dominions, except Gibraltar, within a hundred miles from a place where the offender can be tried by a civil court. Minor civil offences, when not committed within military lines, or when the person affected by the offence is a civilian, or when it is a case for a jury, or where intricate questions of law may arise, may also be brought before a civil tribunal. But an offence, of whatever nature, committed on active service would be brought before a military tribunal.

The military law of England in early times existed, like the

forces to which it applied, in a period of war only. Troops were raised for a particular service, and were disbanded upon the cessation of hostilities. The crown, of its mere prerogative, made laws known as Articles of War, for the government and discipline of the troops while thus embodied and serving. Except for the punishment of desertion, which offence was made a felony by statute in the reign of Henry VI., these ordinances or Articles of War remained almost the sole authority for the enforcement of discipline until 1689, when the first Mutiny Act was passed and the military forces of the crown were brought under the direct control of parliament. Even the Parliamentary forces in the time of Charles I. and Cromwell were governed, not by an act of the legislature, but by articles of war similar to those issued by the king and authorized by an ordinance of the Lords and Commons, exercising in that respect the sovereign prerogative. This power of law-making by prerogative was, however, held to be applicable during a state of actual war only, and attempts to exercise it in time of peace were ineffectual. Subject to this limitation it existed for considerably more than a century after the passing of the first Mutiny Act. From 1689 to 1803, although in peace time the Mutiny Act was occasionally suffered to expire, a statutory power was given to the crown to make Articles of War to operate in the colonies and elsewhere beyond the seas in the same manner as those made by prerogative operated in time of war. In 1715, in consequence of the rebellion, this power was created in respect of the forces in the kingdom. But these enactments were apart from and in no respect affected the principle acknowledged all this time—that the crown of its mere prerogative could make laws for the government of the army in foreign countries in time of war. The Mutiny Act of 1803 effected a great constitutional change in this respect: the power of the crown to make any Articles of War became altogether statutory, and the prerogative merged in the act of parliament. So matters remained till the year 1879, when the last Mutiny Act was passed and the last Articles of War were promulgated. The Mutiny Act legislated for offences in respect of which death or penal servitude could be awarded, and the Articles of War, while repeating those provisions of the act, constituted the direct authority for dealing with offences for which imprisonment was the maximum punishment as well as with many matters relating to trial and procedure. The act and the articles were found not to harmonize in all respects. Their general arrangement was faulty, and their language sometimes obscure. In 1869 a royal commission recommended that both should be recast in a simple and intelligible shape. In 1878 a committee of the House of Commons endorsed this view and made certain recommendations as to the way in which the task should be performed. In 1879 the government submitted to parliament and passed into law a measure consolidating in one act both the Mutiny Act and the Articles of War, and amending their provisions in certain important respects. This measure was called the "Army Discipline and Regulation Act 1879." After one or two years' experience of its working it also was found capable of improvement, and was in its turn superseded by the Army Act 1881, which now forms the foundation and the main portion of the military law of England. It contains a proviso saving the right of the crown to make Articles of War, but in such a manner as to render the power in effect a nullity; for it enacts that no crime made punishable by the act shall be otherwise punishable by such articles. As the punishment of every conceivable offence is provided for by the act, any articles made thereunder can be no more than an empty formality having no practical effect. Thus the history of English military law up to 1879 may be divided into three periods, each having a distinct constitutional aspect: (1) that prior to 1689, when the army, being regarded as so many personal retainers of the sovereign rather than servants of the state, was mainly governed by the will of the sovereign; (2) that between 1689 and 1803, when the army, being recognized as a permanent force, was governed within the realm by statute and without it by the prerogative of the crown; and (3) that from 1803 to 1879, when it was governed either directly by statute or by the sovereign under

¹ By 1848 the following had come to be the division of the Military Frontier: (1) *The Carlstadt (Carlovatz)*, *Warasdin* and *Banal Generalate*; corresponding to the original three generalates. (2) *The Slavonian Generalate*: (district of Mitrovica). (3) *The Banat Generalate*: south and east of Temesvar, and (4) *The Transylvanian Generalate*. Twelve towns, known as "military communities," had communal constitutions not unlike those of the free towns of Hungary-Carolpago, Zengg, Petrinia, Kostajnica, Belovar, Ivanič, Brod, Peterwardein, Carlowitz, Semlin, Pancsova and Weisskirchen.

an authority derived from and defined and limited by statute. Although in 1879 the power of making Articles of War became in effect altogether inoperative, the sovereign was empowered to make rules of procedure, having the force of law, which regulate the administration of the act in many matters formerly dealt with by the Articles of War. These rules, however, must not be inconsistent with the provisions of the Army Act itself, and must be laid before parliament immediately after they are made. Thus in 1879 the government and discipline of the army became for the first time completely subject either to the direct action or the close supervision of parliament.

A further notable change took place at the same time. The Mutiny Act had been brought into force on each occasion for one year only, in compliance with the constitutional theory that the maintenance of a standing army in time of peace, unless with the consent of parliament, is against law. Each session therefore the text of the act had to be passed through both Houses clause by clause and line by line. The Army Act, on the other hand, is a fixed permanent code. But constitutional traditions are fully respected by the insertion in it of a section providing that it shall come into force only by virtue of an annual act of parliament. This annual act recites the illegality of a standing army in time of peace unless with the consent of parliament, and the necessity nevertheless of maintaining a certain number of land forces (exclusive of those serving in India) and a body of royal marine forces on shore, and of keeping them in exact discipline, and it brings into force the Army Act for one year.

Military law is thus chiefly to be found in the Army Act and the rules of procedure made thereunder, the Militia Acts, the Reserve Forces Acts and the Volunteer Acts, together with certain acts relating to the yeomanry, the Territorial and Reserve Forces Act 1907, and various royal warrants and regulations. In the Army (Annual) Act 1906 important amendments were made to the Army Act for the purpose of preventing soldiers convicted of offences against discipline under the act, and not discharged with ignominy, being subjected to the stigma attaching to imprisonment. This was effected by creating a new punishment, termed detention, the places in which soldiers undergo detention being termed detention barracks. The change, while principally one of nomenclature, removed an undoubted grievance. The Army Act itself is, however, the chief authority. Although the complaint has been sometimes made, and not without a certain amount of reason, that it does not accomplish much that it might in point of brevity, simplicity and clearness of expression, it is a very comprehensive piece of legislation, and shows some distinct improvements upon the old Mutiny Acts and Articles of War.

When a person subject to military law commits an offence he is taken into military custody, which means either arrest in his own quarters or confinement. He must without unnecessary delay be brought before his commanding officer, who upon investigating the case may dismiss the charge, if in his discretion he thinks it ought not to be proceeded with, or may take steps to bring the offender before a court martial. Where the offender is not an officer he may dispose of the case summarily, the limit of his power in this respect being seven days' imprisonment with hard labour, a fine not exceeding 10s. for drunkenness, certain deductions from pay, confinement to barracks for twenty-eight days, this involving severe extra drills, deprivations and other minor punishments. Where the offence is absence without leave for a period exceeding seven days, the commanding officer may award a day's imprisonment in respect of each day of such absence up to twenty-one. It is only in the case of the imprisonment exceeding seven days that the evidence before the commanding officer is taken on oath, and then only in the event of the accused so desiring it. The commanding officer is enjoined by regulation not to punish summarily the more serious kind of offences, but his legal jurisdiction in this respect is without limit as regards any soldier brought before him, and when he has dealt summarily with a case the accused is free from any other liability in respect of the offence thus disposed of. In any instance where

the commanding officer has summarily awarded imprisonment, fine or deduction from pay, the accused may claim a district court martial instead of submitting to the award.

Ordinary courts martial are of three kinds, viz. (1) a regimental court martial, usually convened and confirmed by the commanding officer of the regiment or detachment, presided over by an officer not under the rank of captain, composed of at least three officers of the regiment or detachment with not less than one year's service, and having a maximum power of punishment of forty-two days' detention; (2) a district court martial, usually convened by a general officer having authority to do so, consisting of not less than three officers, each with not less than two years' service, and having a maximum power of punishment of two years' imprisonment; (3) a general court martial, the only tribunal having authority to try a commissioned officer, and with a power of punishment extending to death or penal servitude, for offences for which these penalties are authorized by statute; it consists of not less than nine officers in the United Kingdom, India, Malta and Gibraltar and of five elsewhere, each of whom must have had over three years' service, five being not under the rank of captain. There is another kind of tribunal, viz. a field general court martial. It is convened (1) by any officer in command of a detachment or portion of troops beyond the seas when not on active service, or by any officer in immediate command of a body of forces on active service where it appears to him on complaint or otherwise that a person subject to military law has committed an offence. The officer must be satisfied that it is not practicable, with due regard to the public service, to try the person by an ordinary court martial. The quorum of the court is three, if consistent with military exigencies, and each member must have held a commission for not less than a year. The quorum may be reduced when the public service requires it. The procedure of ordinary courts martial is observed as far as possible, and the proceedings always should be in writing when possible. But in the circumstances in which these courts are assembled, it is not always possible to adhere to the technical rules which obtain in the ordinary tribunals, although the broad principles are not violated. The evidence on a field general court martial is taken on oath. The prisoner may cross-examine the witnesses for the prosecution, and may call any available witnesses for his defence. The prisoner is allowed to address the court in his own defence.

The Army Act prescribes the maximum punishment which may be inflicted in respect of each offence. That of death is incurred by various acts of treachery or cowardice before the enemy, or by, when on active service, interfering with or impeding authority, leaving without orders a guard or post, or when sentry sleeping or being drunk on a post, plundering or committing an offence against the person or property of an inhabitant, intentionally causing false alarms, or deserting. Whether upon active service or not, a soldier also becomes liable to the punishment of death who mutinies or incites to or joins in or connives at a mutiny, who uses or offers violence to or defiantly disobeys the lawful command of his superior officer when in the execution of his office. Penal servitude is the maximum punishment for various acts and irregularities upon active service not distinctly of a treacherous or wilfully injurious character, for using or offering violence or insubordinate language to a superior, or disobeying a lawful command, when upon active service. The same punishment is applicable when not upon active service to a second offence of desertion or fraudulent enlistment (i.e. enlistment by one who already belongs to the service), certain embezzlements of public property, wilfully releasing without authority a prisoner or wilfully permitting a prisoner to escape, enlisting when previously discharged from the service with disgrace without disclosing the circumstances of such discharge, or any other offence which by the ordinary criminal law of England is punishable with penal servitude. Imprisonment for two years is the maximum punishment for minor forms and degrees of those offences which if committed upon active service would involve death or penal servitude, such as using or offering violence or insubordinate language to a superior or disobeying a lawful command, and for the following offences: resisting an escort, breaking out of barracks, neglect of orders, a first offence of desertion or attempted desertion or aiding or conniving at desertion, or of fraudulent enlistment, absence without leave, failure to appear at parade, going beyond prescribed bounds, absence from school, malingering or producing disease or infirmity, maiming with intent to render a soldier unfit for service, an act of a fraudulent nature, disgraceful conduct of a cruel, indecent or unnatural kind, drunkenness, releasing a prisoner without proper authority or

himself make inquiry. But now, whenever any inquiry affects the character or military reputation of an officer or soldier, full opportunity must be given him of being present at the inquiry and of giving any evidence or making any statement, or cross-examining

Courts of inquiry.

adverse witnesses, or producing witnesses, on his own behalf. Evidence may now be ordered to be taken on oath if the assembling officer thinks the case requires it. No proceedings of a court of inquiry, no confession, statement or answer, is admissible in a court martial. But an officer or soldier tried by court martial in respect of matter which has been the subject of a court of inquiry is entitled to a copy of the proceedings on payment of the cost of the copy. The finding and sentence are only valid after confirmation by the proper military authority. A sentence of death or penal servitude can only be confirmed by the general or field officer in command of the forces with which the prisoner is present. The rule which allows the prisoner and his wife to tender their evidence on oath under the Criminal Evidence Act 1898 as regards evidence is applicable to field general courts martial. It is useful to note that the Army Act, sec. 70, enables His Majesty to make new provisions under the hand of a secretary of state for, amongst other things, the assembly and the procedure of courts of inquiry. The power to make changes by Army Order or rule is only limited by the principle that the rules must not be contrary to or inconsistent with the act.

In an authoritative report published by the Norwegian government, and compiled by a trained Norwegian lawyer who visited the various countries, the systems of twenty-two states are reviewed. The earliest military law still in force is found in Norway and Denmark, and dates from 1683, while England and Sweden date from 1881. Sweden has a military penal code, and England is ruled by the Army Act. There are two kinds of military courts of first instance: (1) those belonging to separate military bodies, such as divisions, brigades, regiments; (2) those having jurisdiction in a certain territory, and their seat determined. In times of war the courts must follow the military bodies. In Bavaria and Switzerland a military jury is attached to a court martial. In several states "auditors," i.e. judicial guides, are attached to courts martial. In some a military juriconsult (lawyer) is attached as judge, always a fixed post. This obtains in Sweden, Finland, Austria-Hungary, Switzerland and Portugal.

In Norway, Denmark, Sweden, Finland, Belgium, Great Britain, Germany, Austria, United States, Spain, Württemberg and Switzerland the presiding officer is chosen for the single trial. In other states the military judges are appointed for a certain term, usually six months. The quorum of judges required on military courts on the continent differs. Seven judges sit in Belgium, Holland, France, Spain, Portugal, Greece, Turkey and Württemberg; three only, in cases of ordinary offences committed by non-commissioned officers and soldiers in Switzerland, Russia, the United Kingdom, United States and Bavaria. In grave cases in the United Kingdom five to nine sit, nine in Russia, five to thirteen in the United States. In Norway and Denmark the court is of thirteen up to twenty-five, unless replaced by a commission and a military lawyer.

In Norway, Denmark, Sweden, Finland, and Bavaria and other places in Germany, special summary courts martial are held when necessary. Certain forms and legal guarantees are then dispensed with. Such are held in Belgium and Holland "in a town or place in state of siege." *La Prévôté* is a special court of a judge assisted by a registrar, for vagabonds, servants, sutlers, and with a very limited competence over soldiers who have committed a petty offence, held in time of war in France, Rumania and Greece.

The United Kingdom has a summary court martial when the regular court martial cannot be held without injuring the military service. In the United States there are the "field officers' court martial" and "military commission," consisting of three officers. The second is for judging spies and some other matters that escape the jurisdiction of the regular courts martial.

A special military tribunal in Germañy judges the officials attached to the army. *Courts of honour* exist in Russia, Germany, Bavaria, Württemberg, Austria-Hungary and Spain. Great Britain and the United States have the system of a "court of inquiry." This was only a commission of inquiry, but it is now public, the accused is present, and the witnesses are sworn.

Soldiers not on active service, says the Swedish report, should be answerable for infractions of common law under the jurisdiction of the civil courts. All infractions of military order or discipline committed by soldiers, whether on active service or no, should be judged by military courts. In time of war, it is equally admitted, military courts must judge all offences, even offences at common law, committed by soldiers forming part of an army on campaign. The difference lies in regard to offences committed in time of peace. Sweden, Great Britain, France, Italy and the United States, as a general rule, place offences against the common law (*infractions de droit commun*) in time of peace under the jurisdiction of the civil courts. In the United States offences against good order, in Great Britain personal offences (such as drunkenness), are judged by courts martial. In most other states the general rule is that soldiers, even in time of peace, if on actual service are judged by courts martial. In the case of complicity between a soldier and a civilian, sometimes one is judged by a military and the other by a civil court (in Germany, Switzerland and Spain), sometimes both by a military court (Belgium, Italy, Servia, Rumania and Greece); sometimes it depends on the nature of the crime—in the United Kingdom, United States, Sweden, Finland, Holland and Portugal. In Norway a mixed tribunal judges them.

The procedure in military courts differs according to the countries. In some systems (a) the examination and preparation of evidence are confided to a *juge d'instruction*; (b) in other systems they are confided to a special commission of inquiry; (c) again, in other places they are left to the court martial itself that will judge the case. The United Kingdom and the United States follow the last plan. There is no preparatory examination in these two countries. A commission of inquiry for the preparation of evidence is held in Norway, Denmark, Germany, Württemberg, Austria-Hungary, Servia, Belgium and Holland. An auditor directs these courts of inquiry. In Russia an officer acts as *juge d'instruction*; in grave cases he must be a military juriconsult. In Italy, Spain, Rumania, Greece and Turkey an officer acts as *juge d'instruction*.

The proceedings before a court martial are usually public, except in the case of matters that offend morality, compromise the public order, or where publicity is considered injurious to the interests of the service (cases of discipline, disclosing plans, &c.). This does not apply (except in Great Britain and the United States) to the proceedings before the courts charged with preliminary investigation. In several states, i.e. Norway, Denmark, Holland, Austria, Servia, Germany and Württemberg, the public prosecutor is also the counsel of the accused. The auditor who directs the court of inquiry fills these offices (except in cases of small importance in Germany and Württemberg). In other states there is a special office of public prosecutor. In Spain, Portugal, Rumania, Greece and Turkey he is an officer. In Russia, Belgium, Bavaria, Switzerland and Italy he is a military lawyer. In these countries the accused has the right to choose a counsel, or one is assigned him. In the United Kingdom and the United States, when the matter is grave, the direction of the case is put in the hands of a judge advocate. In the United States the judge advocate is the public prosecutor.

There is no superior tribunal to which to appeal in Denmark, Great Britain and the United States. In Denmark the cases are sent to the auditor-general, who can annul if there is error in form, and send back the case to be tried anew. In Great Britain and the United States judgment in ordinary cases must be confirmed by the commanding officer by whose order the court was called. He can lighten the sentence. In certain cases of great gravity it must go to the head of the state, after passing the revision of the judge advocate general, who in Great Britain is the constitutional adviser of the crown as regards courts martial from the view of legality. There is also in these two countries a special revision of judgments in the judge advocate general's office. This revisional power is the safeguard of military justice, as all decisions are reviewed, and if any illegality is pointed out the proceedings are consequently quashed. The effect of this disapproval is not merely to annul the

Competence of Military Courts.

Procedure.

Publicity.

Appeal, when allowed and to whom.

proceedings, but it also prevents the accruing of any disability or forfeiture. The British judge advocate's office has been much strengthened. It now consists of: (1) The judge advocate general (one of H.M. judges); (2) a deputy judge advocate general, who is a trained lawyer; (3) a deputy judge advocate, also a trained lawyer; (4) a military officer of the rank of colonel who has been called to the bar; (5) in South Africa (since 1899, and on a five-years' appointment from 1902) a colonel who has been called to the bar.

In Germany there is no appeal, except for officials attached to the army. In Austria-Hungary the sentence can be lightened by the commanding officer. It can also be returned for trial by a superior court if it appears to him too light. In Spain all judgments have to be confirmed, and if confirmation is refused, it is carried before the supreme court of the navy and army. The condemned has no power of appeal himself, but all cases of death or life sentences go before the supreme court of the navy and army. Russia only requires the confirmation of the commanding officer. In Rumania and Greece all condemned prisoners in time of peace can demand a court of revision, composed of a general and four superior officers. In time of war the court may be composed of three.

Certain forms of punishment, in all countries but the United States, can be given by the superior officer, without judicial intervention, for small purely military offences, where a summary

Disciplinary Punishments. procedure is required. The offender, if he prefers, may be carried before court-martial. The punishment is immediately carried into force, but the person punished can complain to higher military authority. In that case, if the complaint is not admitted, the punishment is enhanced. The commonest of these disciplinary punishments are deprivation of liberty, confined to barracks, arrests and prison. Certain special punishments obtain in certain countries—for instance, imprisonment in Turkey may be accompanied by a bread-and-water diet; and officers in Finland and Russia may be deprived of advancement.

In 1908 France took steps to abolish courts-martial in time of peace, all common law offences to be judged by the ordinary courts, and breaches of military discipline such as rebellion, insubordination, desertion and the like by mixed courts composed of civil and military magistrates.

See *Cloth, Military Forces of the Crown*; T. Gram, *Fonctionnement de la justice militaire dans les différents États de l'Europe.* (JNO. S.)

MILITIA (Fr. *milice*, Ger. *Militä*, from Lat. *miles*, soldier, *militia*, military service), a term used generally for organized military forces which are not professional in character and not permanently embodied. All ancient armies, with the exception of the personal guards of their leaders, were militias or national levies, remaining under arms for the war or the campaign and returning to their ordinary occupations at the close of each military episode. Militias such as those of the Greek city-states and that of Rome were of course highly trained to the use of arms; so were the barbarian "nations in arms"; which overcame the professionalized Roman armies of the Empire; and although in the Eastern Empire these new fighting elements were absorbed into a fully organized regular arm, in the West the tribal militia system gradually developed into feudalism. The noble and the knight indeed spent the greater part of their lives in the field and devoted themselves from their youth to the cult of arms, but the feudal tenant, who were bound to give forty days' war service and no more, and the burghers who, somewhat later in the history of civilization, formed the efficient garrisons of the walled towns were true militias. The English Yeomanry indeed almost ruled the battlefield.

In the 15th century the introduction of firearms began to weigh down the balance in favour of the professional soldier. Artillery was always the arm of the specialist. The development of infantry, "fire-power," with the early arquebus and musket, called for the highest skill and steadiness in the individual soldier, and cavalry too adopted the new weapon in the form of long and expensive wheel-lock pistols. In the new military organization there was no place for the unprofessional soldier. The rôle of the unprofessional combatant, generally speaking, was that of an insurgent—harassing small detachments of the enemy, cutting off stragglers, and plundering convoys. Towards the end of the first civil war in England (1645) the country-folk banded themselves together to impose a peace on the two warring armies, but their menace was without effect, and they were easily disarmed by Fairfax and Cromwell, who did not even trouble to hold them as prisoners. The calling out of the *arrière ban* of Franche-Comté in 1675 displayed its ludicrous inefficiency, and thereafter in France, which set the fashion to

Europe in all military matters, the "provincial militia," which Louvois and Barbezieux raised in place of the discredited *arrière ban*, was employed partly to find drafts for and partly to augment the regular army.

When a first line army was large enough to absorb the fighting strength of the country there was neither room nor need for a true militia force. This was the case with France under Napoleon's régime, but things were different elsewhere. In Great Britain the county militia (whose special history is briefly sketched below) was permanently embodied during the greater part of the Napoleonic Wars. Destitute as it was of technical and administrative services, of higher staffs and organization, and even of cavalry, this militia was a regular army in all but name. Combining continuous service with territorial recruiting as it did, it consisted of men of a better stamp than the casually recruited regular forces. In those days, the militia was a county force commanded by the lords-lieutenant and officered by men of influence; it was not administered by the War Office.

In other countries, Napoleon's invading armies had only to deal with regular or professional troops. Once these were crushed, nothing remained for the beaten side but to make peace with the conqueror on such terms as could be obtained. Militias existed in name as organizations, for the production of more or less unwilling drafts for the lot, but the fundamental militia obligation of defending the *fatherland* as distinct from defending the *state*, produced only local and occasional outbursts of guerrilla warfare. In the Crimean War, the 1850 war in Italy, the 1866 war in Germany, and other wars (the Hungarian War of 1848-49 excepted) the forces, other than the regular troops, engaged in first line were guerrilleros, insurgents, Garibaldians, &c., and behind the forces in first line there were draft-supplying agencies, but no true militia. Only the British militia and the Prussian landwehr represented the self-contained army of second line, and of these the former was never put to the test, while the latter, responding feebly to a political call to arms in 1850, was in consequence so entirely reorganized that it formed a mere rear rank to the line troops. This latter system, consecrated by the German successes of 1870, became the universal model for the continent of Europe, and organized and self-contained militias to-day are only to be found in states maintaining first line armies of "general service" professionals, or in states which maintain no first line troops whatever. In the first class are the auxiliary forces of the British Empire and the United States, in the second the Swiss, Norwegian, Dutch and Swedish forces.

MILITIA OF THE UNITED KINGDOM

The title of "militia" disappeared from the list of the British forces in 1908, on the conversion of the existing self-contained militia into an army "special reserve" which is restricted to the rôle of providing drafts for the first line.¹ The "self-contained" second line army of the present day is the Territorial Force (see UNITED KINGDOM: *Army*).

The county organization of England, with which throughout the militia was closely associated, began with the advent of the Saxons. The prototype of the militia was the *Fyrd*. In this force as reorganized by Alfred liability of service was general on the part of every able-bodied male between the ages of 16 and 60. Although the title of "The *Fyrd*" survived until long after the Norman Conquest, the force established by King Alfred was known as the general levy, which was bound to appear armed when ordered to aid in suppressing domestic riots as well as in defending the realm against invasion by foreign foes. Service was restricted to the counties, except in case of invasion, when it was extended to the whole kingdom. For centuries these remained with little alteration as the principles governing the national forces of the kingdom, and form in effect with certain developments the basis of the modern militia system. The Norman Conquest was immediately followed by the introduction of the feudal levy in addition to the general levy, the distinction between these forces being that while obligation to serve in the latter rested upon every male within certain limits

¹ Various dominions and colonies of the British Empire have militias, for which see UNITED KINGDOM: *Army*. For the Swiss *Militia* system, which is in many respects the archetype of modern militias, see SWITZERLAND; and for the organized militia of the United States see UNITED STATES.

age, service in the feudal levy depended upon tenure of land under the king as feudal lord. The general levy was not in any case liable for service overseas, but the king for a long time employed his feudal tenants in continental wars until they too, successfully resisted the demand. Personal service formed the basis of both levies, but service by deputy, or payment in lieu of personal service, and the calling out of a quota or *band* were known from very early times. The feudal levy was discontinued during the Commonwealth and abolished at the Restoration; but liability to serve in the general levy has never been extinguished, but remains in the statutory and practical form of liability to serve both in the general and local militia. Even at the abolition of these forces the statutory liability to service in them was not done away with. Inspections of arms and the assembly and training of the men raised under this national system were secured from time to time by means of "assizes of arms," "views of armour," "commissions of array," and "commissions of musters," dating from early in the 12th century down to the 16th century. The machinery employed to carry out the law formed the basis of the existing procedure for the enforcement of the ballot for the militia, which thus bears a strong resemblance to the means adopted from ancient times. These constitutional powers were frequently abused by "electing" or impressing men to serve out of the kingdom, but this was checked in the year 1327 by an Act of Parliament, which strictly regulated the scope and limits of military service within the kingdom at the charge of the parishes or counties, but provided for service abroad at the charge of the Crown. Commissions of musters were also developed into recruiting meetings for raising men and material for military service, under which the commissioners registered and mustered persons liable to serve, sorted them into bands and trained and exercised them at the charge of the county. These bands became known as *train* or *trained bands*, and were mustered annually. With them were associated lieutenants of counties, first appointed in 1549 by Edward VI., subsequently in Queen Mary's reign called lords lieutenant, and after the Restoration appointed as statutory officers for the militia, their commissions at the present day being issued under the Militia Act. There is no regular appointment of lieutenants, and no regular regimental organization, its existence until these bands or companies were called into active service, but the Acts of the Commonwealth supplied this defect, and initiated a permanent regimental system. One of the earliest attempts to reform the force since the time of King Alfred was made by Charles I. in 1629, when Orders in Council were issued instructing lords lieutenant to put the militia on a better footing and to fill up vacancies among the officers. Cromwell subsequently issued similar orders couched in strong terms, though under the Commonwealth the duties of lords lieutenant were not recognized, the militia being for all practical purposes dissolved. Service rendered by the militia in the "crowning mercy" of Worcester are a historic exception to the general decadence of second line troops in the 17th and 18th centuries (see GREAT REBELLION). At the Restoration an act was passed declaring that the control of the militia was the prerogative of the king. By the same statute the militia of each county was placed under the lieutenant, who was vested with the appointment of officers, but with a reservation to the Crown in the way of commissioning and dismissal. The cost of the annual training—for fourteen days—fell upon the local authority. Offences against discipline were dealt with by the civil magistrates, but with a power to the officers of fining and of imprisoning in default. Upon this footing the militia of England remained for nearly a century with the general approval of the community. It was recognized as an instrument for defence and for the preservation of internal order, while it was especially popular from the circumstance that from its constitution and organization the Crown could not use it as a means of violating the constitution or abridging the liberty of the subject. It was controlled and regulated in the county; it was officered by the landowners and their relatives, its ranks were filled with men not depending for their subsistence or advancement upon the favour of the Crown; its numbers and maintenance were beyond the royal control; its government was by statute. While the supreme command was distinctly vested in the Crown, every practical security was thus taken against its use by the Crown for any object not constitutional or legitimate. It was regarded as, and was, in fact, the army of the state as distinguished from the standing army, which was very much the army of the king personally. The latter consisted of hired soldiers, and was more than once recruited by a conscription, confined, however, to persons of the vagrant class not having a lawful employment, while the former was a militia composed of those having a fixed abode and status. The militia thus enjoyed for many years as compared with the regular forces a social as well as a constitutional superiority. To this, however, along with the general breakdown of militia systems under the new "professional" conditions of warfare, explained above, and perhaps the practice of trying military offences by civil courts, may be attributed the disrepute into which the militia fell and the inefficiency it displayed, with the exception of the trained bands of London, until it was reorganized in 1757. Under the act of 1662 all train bands were discontinued, and the county militia was done down with their auxiliaries, remained until 1794, when they were reorganized as the City of London Militia. In 1688 an act was passed raising the militia for one year, and for some time it was an

annually sanctioned force as the regular army is to-day. In 1690, on the occasion of the threatened French invasion, the militia was embodied; and again in 1715 and 1745 during the troubles caused by the Old and Young Pretenders. In a pamphlet of 1712 the English militia was estimated at 7450 horse and 84,391 foot soldiers. From 1715 until 1734, and again from that year until 1757, with the exception of 1745, no votes were taken in parliament for the militia.

The foregoing remarks apply only to the English militia and its predecessors. Ireland and Scotland did not furnish any regular militia until 1715 and 1797 respectively, although in Scotland militia existed long before 1797, e.g. in Perthshire in 1684; and in addition corps of fencibles were raised and embodied. The Irish militia when first raised in 1715 was restricted to Protestants between the ages of 16 and 60, who were bound to appear or provide substitutes. The force was not made subject to military law, but various military offences were punishable by fine or imprisonment. Several amendments and other acts followed until 1783, when a new act was passed providing for raising a force of militia, by ballot among men between the ages of 18 and 45, to serve for four years. Each county was liable to a fine of £5 for each man deficient, and enlistment in the army was prohibited. Other amendments followed from time to time, and notably one in 1797 abolishing religious restrictions for the supplementary militia, and another in 1802 removing the same restrictions in the case of the general militia. Finally, all the acts were consolidated in 1809 by an act which fixed establishments and provided for raising the men by ballot, but gave power to the lord-lieutenant to authorize voluntary enlistment by means of bounties, and also to suspend the raising of any regiment. The Scottish militia was at first raised by ballot among men between the ages of 19 and 30. In 1802 former acts were replaced by an Act providing for the organization of the militia on a basis similar to that on which the militia of England was organized by the Consolidation Act passed in that year.

To return to England, the immediate cause of the organic reform carried out in 1757 was the disclosure of the inefficiency of the militia during the rebellion of 1745. The act of 1662 followed the old law by requiring owners of property to furnish men, horses and arms in proportion to the value of their property, and the liability of persons of small property was to be discharged out of a rate levied in the parish. This was entirely altered in 1757, a liability on the part of the county or parish being substituted for a liability on the part of individuals. Each county was required to furnish a quota apportioned among the various parishes; men were to be chosen by lot to serve for three years (this being the first provision of a fixed term of service) or to provide, or pay £10 for the provision of, a substitute, and vacancies were to be filled from time to time by a like process of ballot. The ages of liability were from 18 to 45. The system thus legalized is practically the existing though suspended ballot system. The force was to be annually trained and exercised for a limited period, and in case of invasion or danger thereof, or in case of rebellion, the Crown could order it or any portion of it to be embodied; but only on condition of informing parliament (which was if not sitting to be summoned for the purpose). During the embodiment or annual training it was subject to the Mutiny Act, except that no punishment during training was to extend to "life or limb"; to prevent an unconstitutional use of the militia by the Crown, the estimate for its training was framed each year not by an executive minister of the sovereign, but by the House of Commons itself. Upon the initiative of a committee of the house, an act was passed providing for the pay and clothing of the militia for the year. The king directly appointed the permanent staff and was given a veto on the appointment and promotion of the officers, who were to have a property qualification.

Under this act 30,000 militiamen were raised by ballot and embodied from 1759 to 1765. This force was exclusively Protestant, and remained so until 1802. The service of the militia as thus arranged remained nearly in the same state until 1870. Pitt's reform, however, was followed by numerous amendments, new enactments, and other changes, of which the following is a summary in chronological order—

1758. Men volunteering to serve recognized as counting towards the quota.
1761. Raising of quota made compulsory on counties under penalty of fines.
- Mutiny Act applied to militia when out for training as well as when embodied.
1775. (American War.) Act passed empowering embodiment of militia in case of colonial as well as domestic rebellion.
1786. Charge on parishes for storage of arms, &c., transferred to counties.
1795. Enlistment into regulars encouraged.
1796. Supplementary militia formed, consisting of 63,878 men.
1798. (Irish Rebellion.) English militia volunteered for service in Ireland.
1799. Irish militia volunteered to serve in Great Britain.
1801. 150,000 militiamen volunteered to regular army.
1803. 45,492 men raised for militia by ballot, but of these 40,998 were substitutes.
1805. Militia affiliated to line for purposes of recruiting for regulars.

1806. Training Act to raise by ballot 200,000 men to be trained for one whole year, and then to discharge them from training for two years.
1808. Difficulties having arisen under above Act, local militia (which is in effect the old general levy) established in addition to general militia then embodied.
1811. English militia, hitherto not liable to serve out of the kingdom, now made liable to serve in any part of the United Kingdom under certain restrictions, which were subsequently (in 1859) removed.
- Method of obtaining men from militia for regulars further systematized.
1812. In this year there were 250 regiments of local militia, with an establishment of 240,388 men and 214,418 actually enrolled.
1813. During ten years, from 1803 to 1813, nearly 100,000 militiamen joined the regular army.
- Act passed to enable militia to serve abroad as militia with their own officers. Three strong battalions joined the British army in France.
1815. Militiamen recruited in great numbers the army which fought at Waterloo.
- Local militia ceased to be raised.
1816. Local militia and Ballot Act suspended.
- General militia disembodied.
- 1820-21-25. Militia called out for training.
1829. Act passed suspending ballot for the general militia.
1831. Militiamen raised by ballot in accordance with Order in Council, 27th of December 1830. This was the last occasion on which the ballot was put in force.

In the latter stages of the great French war the tendency of the government was to use the general militia rather as a reservoir producing drafts (in the end whole units) for service abroad, and the local militia as the real defensive force. During the height of the war (in 1812) the relative position of the various branches of the army was as follows: First line, the standing army; second line, the general or regular militia, which as the war went on were more and more used abroad; third line, the local militia, with the survivors of the volunteers, who at that time numbered about 68,000 men. After the peace of 1815 the militia was allowed practically to fall into abeyance, and although the permanent staff was maintained, it had no duties to perform. In 1848 the Prime Minister intimated in parliament his intention to re-establish the militia, but it was not until 1852, after an unsuccessful attempt to resuscitate the local militia, that the general militia of England was reorganized under a system of voluntary enlistment with the ballot in reserve, Scotland and Ireland being included in 1854. The property qualification of officers which had hitherto existed (with exception in favour of officers of the army and navy) was reduced, and after a further reduction in 1854, abolished in 1869. Larger powers respecting the militia were conferred upon the Crown, and during the Crimean War the Queen was authorized to embody the militia whenever a state of war existed with any foreign power. In that war the militia was embodied and did garrison duty not only in the United Kingdom but in the Mediterranean garrisons, thus enabling the authorities to send most of the available regular troops to the scene of hostilities. It further contributed many officers and some 30,000 men to the line. During the Indian Mutiny it filled scarcely less useful functions when again called out. The acceptance of voluntary offers of service in the Channel Islands and Isle of Man was definitely authorized in 1859, and extended to service in Malta and Gibraltar in 1875.

In 1871 an important constitutional change was made. It was part of the new army system inaugurated in that year that the control of the militia should be removed from the lord-lieutenant of the county and vested wholly in the Crown. It now virtually ceased to exist as a distinct body, and in 1881 it became a part of the regular forces with a limitation as to the time and area and other conditions of service. Militia battalions were united with the line battalions to form territorial regiments, the artillery and engineers being also closely associated with the regular services. Various amendments and new enactments followed, all in the direction of increasing the usefulness of the militia, rendering it more efficient and readier for service, though at the same time making it more and more a means for supplying recruits, both officers and men, to the regular army. The officers, who were commissioned by the Crown, were in 1872 made subject at all times to military law. Non-commissioned officers and men were only so subject when embodied or out for training, with extension in the case of men convicted of offences committed during training until the expiration of the punishment.¹ Enlistment was voluntary, compulsory service by ballot remained

legal, but suspended. The period of engagement was for six years, re-engagements for periods of four years up to the age of 45 being permitted. Bounties were paid to militiamen at various rates upon enlistment, conclusion of training, re-engagement, enlistment into reserve or special service section, and other special circumstances. Recruit training, maximum six months, as a rule did not exceed three months. Recruits were either drilled immediately upon enlistment at any time of the year, which was the most usual system, or else at preliminary drills (first instituted in 1860), immediately preceding the annual training of the corps. The annual training varied with the different branches of the service. The usual term for infantry was 27 days, but when on manœuvres this was generally extended to 34 days, 56 days being the legal maximum. Artillery and fortress engineers trained for 41 days and submarine mining corps for 55 days. Trainings took place for the most part in camp or barracks, and large numbers of militia battalions were latterly called on to take part in field manœuvres. The militia dépôts occupied as a rule the same barracks, and officers and men wore (with slight distinctions) the same uniform as the regulars. The militia occupied an important position in the mobilization scheme for national defence. The permanent staff (adjutant, quartermaster, and an establishment of non-commissioned officers and buglers or drummers, all regulars) was engaged during the non-training year in recruiting, care of arms, clothing and kit, and in drilling recruits. The general line of system as regards training are still followed with the Special Reserve, though the constitution of the new force is very different.

The militia ordinarily was liable only for service in the United Kingdom, but by legislation in 1809 may voluntarily serve in any part of the world, including India. During 1809-1900, 22,000 militiamen were thus accepted for service abroad, the bulk of them proceeding to the seat of war in South Africa.

The militia reserve consisted of men selected from the ranks of the militia for special enlistment for service in the regular army when called upon in emergencies, in the following proportions: to the establishments of the various corps: Artillery, one-third; engineers and infantry, one-fourth; medical staff corps, one-half. The militia reserve was first formed in 1867, and in 1900 numbered 30,000 men. During an emergency in 1878, 20,000 militia reservists joined the regular army. The term "militia" reserve was therefore a complete misnomer, and the force was purely an army reserve. The special service section of the militia was formed by royal warrant in 1898, and consisted of (1) militia units and (2) individual militiamen. A militia unit was considered as available for special service if not less than 75% of the officers and men present at training made a voluntary offer to engage for special service in any part of the world, and if in the infantry at least 500 and in the artillery at least 250 men were accepted as qualified. Individual militiamen engage to serve either with their militia unit if it were registered for service, or with the reserve with the reserve. Liability for special service was limited to twelve months. Men in the special service section could also belong to the militia reserve, and receive a bounty in addition to that given for the reserve. The result of this special section was not up to 1900 satisfactory. Very few units could qualify for registration, and the response of individual men was comparatively insignificant.

During and after the South African War, while militia recruiting for the regulars showed a constant increase compared with preceding years, the strength of the militia itself decreased year after year. Its militia character had been diminishing ever since the creation of the "militia reserve" and the dissolution of the force to the first regular army. For good or evil, then, it had become in the first place a draft-producing agency, and on the reorganization of the forces of the Crown into two lines by Mr Haldane the old "constitutional force" was frankly reorganized as a reserve for the line, enlistment and training conditions remaining somewhat similar to those in vogue in the militia, but the liability for service abroad becoming the first and most important condition in the "special reservists' " enlistment.

MILK (O. Eng. *meoluc*; from a common Indo-European root, cf. Lat. *mulgere*, Gr. *ἀμύλαω*), the fluid secreted by the mammary glands of the division of vertebrate animals called *Mammalia* (see **MAMMARY GLAND**), and primarily devised for the nourishment of their own young.

The milk of various domesticated animals is more or less used by man for food. The milk of the cow, which may be taken as typical of all others, and is indeed by far the most important and valuable of all (see **DAIRY AND DAIRY FARMING**), is, when newly drawn, an opaque white fluid, with a yellowish tinge, soft, bland and sweetish to the taste, and possessed of a faintly animal odour. This odour, according to Schreiner, is due to the presence of sulphuretted hydrogen, and disappears after a short exposure. The specific gravity of milk ordinarily ranges from 1.029 to 1.033, very seldom reaching 1.035 or falling so low as 1.027. In chemical constitution it consists of an emulsion

¹ This, though here mentioned as part of a process of "regularizing" the militia, was in fact a reform that was advisable under any conditions. The new Territorial Force was then created out of the Volunteer Force (which had no such liability for training or serving with regulars) was made subject to military law, officers at all times, men whenever under instruction.

of fatty globules (cream) in a watery alkaline solution of casein, and a variety of sugar, peculiar to milk, called lactose. The fat (which when separated we know as butter) and the lactose constitute the carbonaceous portion of the milk regarded as food. The casein, which forms the principal constituent of cheese, and a certain proportion of albumen which is present, form the nitrogenous, while the complex saline substances and water are the mineral constituents. These various substances are present in the proportions which render milk a perfect and typical food suitable to the wants of the young of the various animals for whom it is provided by nature. The milk of animals, so far as is known, contains them, although they are present in somewhat different proportions. It is probable that the milk of ruminants possesses certain physical and physiological distinctions from that of non-ruminant animals, which will account for the virtues attributed to the milk of the ass and mare. The following table exhibits the chemical constitution of the kinds of milk most frequently used by man:—

	Cow.		Goat.	Ewe. ¹	Mare.	Ass.	Human.
	Winter Blyth.	Cameron.	Voelcker.	Voelcker.	Cameron.	Chevalier and Henry.	Gerber.
Water . . .	86.87	87.00	84.48	83.70	90.310	91.65	88.02
Fat . . .	3.50	4.00	6.11	4.45	1.055	0.11	2.90
Casein and albumin . . .	4.75	4.10	3.94	5.16	1.953	1.82	1.60
Sugar . . .	4.00	4.28	4.68	5.73	6.285	6.08	7.30
Ash . . .	0.70	0.62	0.79	0.96	0.369	0.34	0.31

In addition to these constituents milk contains small proportions of the gases carbonic acid, sulphuretted hydrogen, nitrogen and oxygen, and minute quantities of other principles, the constant presence and essential conditions of which have not been determined. These consist of galactin and lactochrome, substances peculiar to milk, discovered by Winter Blyth, with certain animal principles such as leucin, pepton, kreatin, tyrosin, &c. The salts in milk consist, according to the average of numerous analyses by Fleischmann, of the following constituents:—

Phosphoric acid . . .	28.31	Potash	17.34
Chlorine	16.34	Magnesia	4.97
Lime	27.00	Ferric oxide	0.62
Soda	10.00		

Milk thus is not to be regarded as a definite chemical compound nor even as a mixture of bodies in fixed and invariable proportions. Not only does the milk of different races and breeds of cows vary within comparatively wide limits; the milk of the same animal is subject to extensive fluctuation. The principal causes of variation in the individual are age, period of lactation, nature and amount of food, state of health, and treatment, such as frequency of milking, &c. The following table indicates the range of normal variations:—

Water	90.00 to 83.65
Fat	2.80 " 4.50
Casein and albumin	3.30 " 5.55
Sugar	3.00 " 5.50
Ash	0.70 " 0.80

The average quantity of milk yielded by cows is also widely variable, both in individuals and breeds.

Milk and Disease.—Although the milk of a perfectly healthy cow may be absolutely sterile, it is difficult to obtain it in that condition. In the report of the joint committee appointed for the purpose by the county boroughs of Bradford, Hull, Leeds, Rotherham and Sheffield in 1908, the following conclusions were drawn: (1) Cows' milk freshly drawn from the udder by ordinary methods contains bacteria. They are more numerous in the first flow of the milk. (2) There is a great increase in contamination in the milk at each stage before it reaches the customer. This is due to (a) the dirty condition of the cows' udders, (b) the imperfect cleansing of the cans and of the hands of the milkers. The committee recommend:

¹ Ewe's milk is exceedingly variable, especially in its percentage of fat. The above analysis is one of nine by Dr Arthur Voelcker, in which the fat was found to range from about 2 to 12½%.

" (1) The washing of the udder and flanks with soap and water, and similar attention to the hands of the milker. (2) Efficient sterilization of all vessels by steam if possible, or by abundance of boiling water. (3) Rejection of the first draw of the milk from each teat. (4) Avoidance of any work raising dust immediately before or during milking. (5) Removal of the milk of each cow immediately from the shed. (6) Ventilation and cleanliness of the cowsheds. This provides for the reduction as far as possible of contamination during the milking process itself. As any bacteria present in the milk tend to multiply rapidly on the way to the consumer, it is mainly a question of the time which elapses before consumption. It is, therefore, further recommended (a) that the milk be rapidly cooled or chilled, as the lower the temperature the less do the bacteria multiply, (b) that contamination during railway transit be avoided by dust-proof lugged milk cans.

By treating milk at a temperature of 60° C. for one hour, 70° C. for ten minutes, and 95° C. for one minute, tubercle bacilli, if present, will certainly be killed. Cholera and typhoid organisms are less resistant, and are killed more quickly than tubercle bacilli at the above temperatures. Only a single pathogenic species can withstand the heat-boiling to which milk is ordinarily treated in domestic management, and this is the anthrax bacillus containing spores. The danger from this source is remote, as the microbe does not form spores within the animal body. Even in the worst cases, therefore, only vegetable forms, easily destroyed by boiling, can find their way into the milk from the body of the cow.

The lactic acid bacillus, always present in unboiled milk (to which the souring of milk is due), is easily destroyed by heat; but the *Bacillus mesentericus*, often found in it, forms spores, which are not destroyed by ordinary boiling, and germinate when the milk is kept at a moderately warm temperature, producing a brisk fermentation whereby a large volume of gas is liberated. The fundamental idea of Soxhlet's method for sterilizing milk is to boil it for forty minutes in small bottles holding just enough for one meal, and closing the same with an impervious stopper, which is only removed just before use. Milk so treated will keep at the ordinary room temperature, as the spores of the *B. mesentericus* do not develop below 15° C.; but if it is introduced into the alimentary canal of a child the spores will rapidly multiply, and in such cases large quantities of gas, giving rise to flatulency, will be formed, and possibly also poisonous decomposition products of albuminoid matter. To render milk sterile in the strict sense of the word it is necessary to raise it to a temperature of about 120° C. for twenty minutes. Under these conditions the lactose decomposes into dark-brown oxidation products, the fat loses its emulsified condition and separates out as cream which cannot be made to diffuse again even by shaking, and the albuminoids are converted into a form very difficult of digestion.

In short, there is the greatest difficulty in freeing milk on a large scale from germs without at the same time seriously prejudicing its flavour and nutritive value. Since, then, the destruction of the hardy germs is so difficult, the greater care should be taken, by washing the udder, hands and milk vessels, to secure extreme cleanliness in the preparation of milk intended for infant consumption. Sterilization then becomes an easier task, the milk drawn under these conditions being very poor in spore-forming bacteria. It is imperative that cream destined for butter-making should be free from pathogenic organisms. The organisms of cholera, typhoid fever and tuberculosis present in butter retain their vitality for a long time. As butter is consumed in the raw state, a trustworthy preliminary treatment of the cream is in the highest degree desirable. Schuppan has shown that it is possible to produce good butter from Pasteurized or even sterilized cream, and Weigmann introduced the plan of artificially souring cream by means of pure cultures of *B. acidilactici*.

Since Metchnikoff's introduction (see LONGEVITY) of the use of soured milk for dietetic purposes—the lactic acid bacillus destroying pathogenic bacteria in the intestine—great importance has been given to the multiplication of laboratory preparations containing cultures of the bacillus; and in recent years much benefit to health has, in certain cases, been derived from the discovery.

See also the articles ADULTERATION; DAIRY AND DAIRY FARMING; INFANCY; DIETETICS; FOOD AND FOOD PRESERVATION; in the last of which the preparation of condensed milk is described.

MILKWORT, in botany, the common name for plants of the genus *Polygala* (natural order Polygalaceae), a large genus widely dispersed in temperate and tropical regions and represented by a few species in Britain. The common species, *P. vulgaris*, is a small wiry perennial found on heaths and in meadows throughout the British Isles. The stems are 2 to 10 in. long and bear narrow rather tough leaves and small, $\frac{1}{2}$ to $\frac{3}{8}$ in. long, white, pink, blue, lilac or purple flowers. The flowers (see fig.) are peculiar in form and arrangement of parts; they have five free sepals the two inner of which (b) are large petaloid and winglike, forming the most conspicuous part of the flower; the petals are united below with the sheath of the eight stamens forming a tube split at the base behind; their form recalls that of the pea family. The name *Polygala* is from the Greek *πολύς*, much,

and γάλα, milk, the plant being supposed to increase the yield of milk in cows. Some species with showy flowers are known in cultivation as greenhouse, or hardy annual or perennial, herbs or shrubs. The root of *P. Senega*, snake-root, a North American species is official. Sea milkwort is the common name for *Glaux maritima*, a small succulent herb found on seashores and in estuaries in the British Isles; it belongs to the primrose order (Primulaceae).



After Berg & Schmidt, from Strachburger's *Lehrbuch der Botanik*, by permission of Gustav Fischer.

Polygala Senega.

A. Flower; a, small sepals; b, large sepals; c, keel, representing the anterior petal; d, its bifurcated edge; e, lateral petals.

B. The 8 stamens united into a sheath below; h, anthers (magnified).

MILL, JAMES (1773-1836), historian and philosopher, was born on the 6th of April 1773, at Northwater Bridge, in the parish of Logie-Pert, Forfarshire, the son of James Mill, a shoemaker. His mother, Isabel Fenton, of a good family which had suffered from connexion with the Stuart rising of 1745, resolved that he should receive a first-rate education, and sent him first to the parish school and then to the Montrose Academy, where he remained till the unusual age of seventeen and a half. He then entered the university of Edinburgh, where he distinguished himself as a Greek scholar. In October 1798 he was licensed as a preacher, but met with little success. From 1799 to 1802, in addition to holding various tutorships, he occupied himself with historical and philosophical studies. Finding little prospect of a career in Scotland, in 1802 he went to London in company with Sir John Stuart, then member of parliament for Kincardineshire, and devoted himself to literary work. From 1803 to 1806 he was editor of an ambitious periodical called the *Literary Journal*, which professed to give a summary view of all the leading departments of human knowledge. During this time he also edited the *St James's Chronicle*, belonging to the same proprietor. In 1804 he wrote a pamphlet on the corn trade, arguing against a bounty on the exportation of grain. In 1805 he published a translation (with notes and quotations) of C. F. Villers's work on the Reformation, an unsparing exposure of the alleged vices of the papal system. In 1805 he married Harriet Burrow, whose mother, a widow, kept an establishment for lunatics in Hoxton. He then took a house in Pentonville, where his eldest son, John Stuart Mill (q.v.), was born in 1806. About the end of this year he began his *History of India*, which he took twelve years to complete, instead of three or four, as he had expected.

In 1808 he became acquainted with Jeremy Bentham, and was for many years his chief companion and ally. He adopted Bentham's principles in their entirety, and determined to devote all his energies to bringing them before the world. Between 1806 and 1818 he wrote for the *Anti-Jacobin Review*, the *British Review* and the *Electric Review*; but there is no means of tracing his contributions. In 1808 he began to write for the *Edinburgh Review*, to which he contributed steadily till 1813, his first known article being "Money and Exchange." He also wrote on Spanish America, China, General Miranda, the East India Company, and the Liberty of the Press. In the *Annual Review* for 1808 two articles of his are traced—a "Review of Fox's History," and an article on "Bentham's Law Reforms," probably his first published notice of Bentham. In 1811 he co-operated with William Allen (1770-1843), quaker and chemist, in a periodical called the *Philanthropist*. He contributed largely to every number—his principal topics being Education,

Freedom of the Press, and Prison Discipline (under which he expounded Bentham's "Panopticon"). He made powerful onslaughts on the Church in connexion with the Bell and Lancaster controversy, and took a prominent part in the discussions which led to the foundation of London University in 1825. In 1814 he wrote a number of articles, containing an exposition of utilitarianism, for the supplement to the fifth edition of the *Encyclopaedia Britannica*, the most important being those on "Jurisprudence," "Prisons" and "Government."

In 1818 the *History of India* was published, and obtained a great and immediate success. It brought about a change in the author's position. The year following he was appointed an official in the India House, in the important department of the examiner of Indian correspondence. He gradually rose in rank till he was appointed, in 1830, head of the office, with a salary of £1900, raised in 1836 to £2000. His great work, the *Elements of Political Economy*, appeared in 1821 (3rd and revised ed. 1826).

From 1824 to 1826 Mill contributed to the *Westminster Review*, started as the organ of his party, a number of articles in which he attacked the *Edinburgh* and *Quarterly Reviews* and ecclesiastical establishments. In 1829 appeared the *Analysis of the Human Mind*. From 1831 to 1833 Mill was largely occupied in the defence of the East India Company, during the controversy attending the renewal of its charter, he being in virtue of his office the spokesman of the court of directors. For the *London Review*, founded by Sir William Molesworth in 1834, he wrote a notable article entitled "The Church and its Reform," which was much too sceptical for the time, and injured the *Review*. His last published book was the *Fragment on Mackintosh* (1835). He died on the 23rd of June 1836.

Mill had a thorough acquaintance with Greek and Latin literature, general history, political, mental and moral philosophy. His intellect was logical in the highest degree; he was clear and precise, an enemy of loose reasoning, and quick to refute prevailing fallacies. All his work is marked by original constructive thought, except in a few subjects, in which he confessedly expounded Bentham's views. At a time when social subjects were as a rule treated empirically, he brought first principles to bear at every point. His greatest literary monument is the *History of India*. The materials for narrating the acquisition by England of its Indian Empire were put into shape for the first time; a vast body of political theory was brought to bear on the delineation of the Hindu civilization; and the conduct of the actors in the successive stages of the conquest and administration of India was subjected to a severe criticism. The work itself, and the author's official connexion with India for the last seventeen years of his life, effected a complete change in the whole system of governing that country.

Mill played a great part also in English politics, and was, more than any other man, the founder of what was called "philosophic radicalism." His writings on government and his personal influence among the Liberal politicians of his time determined the change of view from the French Revolution theories of the rights of man and the absolute equality of men to the claiming of securities for good government through a wide extension of the franchise. Under this banner it was that the Reform Bill was fought and won. His *Elements of Political Economy*, which was intended only as a textbook of the subject, shows all the author's precision and lucidity. As Dr J. K. Ingram said, it has the "character of a work of art." It followed up the views of Ricardo, with whom Mill was always on terms of intimacy. Its interest is mainly historical, as an accurate summary of views which are now largely discarded. Among the more important of its theses are: (1) that the chief problem of practical reformers is to limit the increase of population, on the assumption that capital does not naturally increase at the same rate as population (ii. § 2, art. 3); (2) that the value of a thing depends entirely on the quantity of labour put into it; and (3) that what is now known as the "unearned increment" of land is a proper object for taxation. The work as a whole is a striking example of the weakness of treating

economic problems from a purely a priori standpoint by the deductive method.

By his *Analysis of the Mind* and his *Fragment on Mackintosh* Mill acquired a position in the history of psychology and ethics. He took up the problems of mind very much after the fashion of the Scottish school, as then represented by Reid, Stewart and Brown, but made a new start, due in part to Hartley, and still more to his own independent thinking. He carried out the principle of association into the analysis of the complex emotional states, as the affections, the aesthetic emotions and the moral sentiment, all which he endeavoured to resolve into pleasurable and painful sensations. But the salient merit of the *Analysis* is the constant endeavour after precise definition of terms and clear statement of doctrines. The *Fragment on Mackintosh* is a severe exposure of the flimsiness and misrepresentations of Sir James Mackintosh's famous *Dissertation on the Progress of Ethical Philosophy* (1830), and discusses the foundations of ethics from the author's utilitarian point of view.

BIBLIOGRAPHY—Leslie Stephen, *The English Utilitarians*, vol. ii. (1900), and article in *Dict. Nat. Biogr.*; A. Bain, *James Mill* (1882); G. S. Bower, *Hartley and James Mill* (1881); James McCosh, *Scottish Philosophy* (1885); J. S. Mill, *Autobiography* (1873); Th. Ribot, *La Psychologie anglaise* (1870; Eng. trans., 1873); J. Morley in *Fortnightly Review*, xxvii. (1882); Graham Wallas, *The Life of Francis Place* (1898).

MILL, JOHN (c. 1645–1707), English theologian, was born about 1645 at Shap in Westmorland, entered Queen's College, Oxford, as a servitor in 1661, and took his master's degree in 1669 in which year he spoke the "Oratio Panegyrica" at the opening of the Sheldonian Theatre. Soon afterwards he was chosen fellow and tutor of his college; in 1676 he became chaplain to the bishop of Oxford, and in 1681 he obtained the rectory of Bletchington, Oxfordshire, and was made chaplain to Charles II. From 1685 till his death he was principal of St Edmund's Hall; and in 1704 he was nominated by Queen Anne to a prebendal stall in Canterbury. He died on the 23rd of June 1707, just a fortnight after the publication of his Greek Testament.

Mill's *Nomen testamentum graecum, cum lectionibus variantibus MSS. exemplarum, versionum, editionum SS. patrum et scriptorū ecclesiasticorum, et in eadem notis* (Oxford, 1707), was undertaken at the advice and encouragement of John Fell (d. 1722), his predecessor in the field of New Testament criticism; it represents the labour of thirty years, and is admitted to mark a great advance on all that had previously been achieved. The text indeed is that of R. Stephanus (1550), but the notes, besides embodying all previously existing collections of various readings, add a vast number derived from his own examination of many new MSS. and Oriental versions (the latter unfortunately he used only in the Latin translations). Though the amount of information given by Mill is small compared with that in modern editions, it is probable that no one person, except perhaps Tischendorf, has added so much material for the work of textual criticism. He was the first to notice, though only incidentally, the value of the concurrence of the Latin evidence with the Codex Alexandrinus, the only representative of an ancient non-Western Greek text then sufficiently known; this hint was not lost on Bentley (see Westcott and Hort, *Introduction to New Testament*). Mill's various readings, numbering about thirty thousand, were attacked by Daniel Whitby (1638–1726) in his *Examen* as destroying the validity of the text; Antony Collins also argued in the same sense though with a different object. The latter called forth a reply from Bentley (*Philoleutherus Ippienensis*). In 1710 Kuster reprinted Mill's Testament at Amsterdam with the readings of twelve additional MSS.

MILL, JOHN STUART (1806–1873), English philosopher and economist, son of James Mill, was born on the 20th of May 1806 in his father's house in Pentonville, London. He was educated exclusively by his father, who was a strict disciplinarian, and at the age of three was taught the Greek alphabet and long lists of Greek words with their English equivalents. By his eighth year he had read Aesop's *Fables*, Xenophon's *Anabasis*, and the whole of Herodotus, and was acquainted with Lucian, Diogenes Laërtius, Isocrates and six dialogues of Plato (see his *Autobiography*). He had also read a great deal of history in English—Robertson's histories, Hume, Gibbon, Robert Watson's *Philip II.* and *Philip III.*, Hooke's *Roman History*, part of a translation of Rollin's *Ancient History*, Langhorne's *Plutarch*, Burnet's *History of My Own Times*, thirty volumes of the *Annual Register*, Millar's *Historical View of the English Government*, Mosheim's

Ecclesiastical History, M'Crie's *Knox*, and two histories of the Quakers. A contemporary record of Mill's studies from eight to thirteen is published in Bain's sketch of his life. It shows that the *Autobiography* rather understates the amount of work done. At the age of eight he began Latin, Euclid, and algebra, and was appointed schoolmaster to the younger children of the family. His main reading was still history, but he went through all the Latin and Greek authors commonly read in the schools and universities, besides several that are not commonly read by undergraduates. He was not taught to compose either in Latin or in Greek, and he was never an exact scholar; it was for the subject matter that he was required to read, and by the age of ten he could read Plato and Demosthenes with ease. His father's *History of India* was published in 1818; immediately thereafter, about the age of twelve, John began a thorough study of the scholastic logic, at the same time reading Aristotle's logical treatises in the original. In the following year he was introduced to political economy and studied Adam Smith and Ricardo with his father.

Not unnotably the training which the younger Mill received has aroused amazement and criticism; and it is reasonable to doubt whether the material knowledge which he retained in the result was as valuable to him as his father imagined. It is important, however, to note that the really important part of the training was the close association which it involved with the strenuous character and vigorous intellect of his father. From his earliest days he spent much time in his father's study and habitually accompanied him on his walks in North London. Much therefore of what he acquired was assimilated without difficulty, and the accuracy of his impressions was tested by his subsequently drafting a *résumé* of their conversations. He thus learned early to grapple with difficulties and to accustom himself to the necessity of precision in argument and expression. It was an inevitable result of such an education that Mill acquired many of his father's speculative opinions, and his father's way of defending them. But he did not receive the impress passively and mechanically. "One of the grand objects of education," according to the elder Mill, "should be to generate a constant and anxious concern about evidence." The duty of collecting and weighing evidence for himself was at every turn impressed upon the boy; he was taught to accept no opinion on authority. He was deliberately educated as an apostle, but it was as an apostle of reasoned truth in human affairs, not as an apostle of any system of dogmatic tenets. It was to prevent any falling off from this high moral standard till it should become part of his being that his father kept the boy so closely with himself. Mill expressly says that his childhood was not unhappy. It seems unhappy only when we compare it with the normal life of a boy and decline to imagine its peculiar enjoyments and aspirations. Mill complains that his father often required more than could be expected of him, but his tasks were not so severe as to prevent him from growing up a healthy and high-spirited boy, though he was not constitutionally robust, and his pursuits were so different from those of other boys of the same age.

From May 1820 till July 1821 Mill was in France in the family of Sir Samuel Bentham, brother of Jeremy Bentham. Away from his father he maintained his laborious habits. Copious extracts from a diary kept by him at this time are given by Bain; they show how methodically he read and wrote, studied chemistry and botany, tackled advanced mathematical problems, made notes on the scenery and the people and customs of the country. He also gained a thorough acquaintance with the French language. On his return in 1821 he added to his work the study of psychology, and that of Roman law, which he read with John Austin, his father having half decided on the bar as the best profession open to him. In 1822, however, when he had just completed his seventeenth year, this intention was abandoned, and he entered as a clerk in the examiner's office of the India House, "with the understanding that he should be employed from the beginning in preparing drafts of despatches, and be thus trained up as a successor to those who then filled the highest departments of the office."

Mill's work at the India House, which was henceforth his livelihood, did not come before the public; hence some have scouted his political writings as the work of an abstract philosopher, entirely unacquainted with affairs. From the first he was more than a clerk, and after a short apprenticeship he was promoted, in 1828, to the responsible position of assistant-examiner with a salary of £600 a year. The duty of the so-called examiners was to examine the letters of the agents of the Company in India, and to draft instructions in reply. The character of the Company's government was almost entirely dependent upon their abilities as statesmen. For twenty years, from 1836 (when his father died) to 1856, Mill had charge of the Company's relations with the native states, and in 1856 he became chief of the office with a salary of £2000. In the hundreds of despatches that he wrote in this capacity, much, no doubt, was done in accordance with established routine, but few statesmen of his generation had a wider experience of the responsible application of the principles of government. About this work he said little in the *Autobiography*, probably because his main concern there was to expound the influences that effected his moral and mental development.

About the time of his entering the India House Mill read Dumont's exposition of Bentham's doctrines in the *Traité de Législation*, which made a lasting impression upon him. When he laid down the last volume, he says, he had become a different being. It gave unity to the detached and fragmentary parts of his knowledge and beliefs. The impression was confirmed by the study of the English psychologists, as well as Condillac and Helvétius, and in 1822-1823 he established among a few friends the "Utilitarian" Society, taking the word, as he tells us, from Galt's *Annals of the Parish*. Two newspapers were open to him—the *Traveller*, edited by a friend of Bentham's, and the *Morning Chronicle*, edited by his father's friend Black. One of his first efforts was a solid argument for freedom of discussion, in a series of letters to the *Chronicle* apropos of the prosecution of Richard Carlile. But he watched all public incidents with a vigilant eye, and seized every passing opportunity of exposing departures from sound principle in parliament and courts of justice. Another outlet was opened up for him (April 1824) by the starting of the *Westminster Review*, and still another in the following year in the *Parliamentary History and Review*. This year also he found a congenial occupation in editing Bentham's *Rationale of Judicial Evidence*. All the time, his mind full of public questions, he discussed eagerly with the many men of distinction who came to his father's house. He engaged in set discussions at a reading society formed at Grote's house in 1825, and in set debates at a Speculative Society formed in the same year.

From the *Autobiography* we learn that in 1826 Mill's enthusiasm was checked by a misgiving as to the value of the ends which he had set before him. This expression was the result, no doubt, of his strenuous training and the comparative lack of congenial friendships. His father was reserved, undemonstrative even to the pitch of chilling sternness, and among young Mill's comrades contempt of feeling was almost a watchword. Himself absorbed in abstract questions and projects of general philanthropy, he had been careless of personal attachment. On the other hand without experience he could not have been prepared for the actual slowness of the reformer's work. In 1826 he looked back to four years of eager toil. What were the results? He had become convinced that his comrades in the Utilitarian Society, never more than ten, had not the stuff in them for a world-shaking propaganda; the society itself was dissolved; the *Parliamentary Review* was a failure; the *Westminster* did not pay its expenses; Bentham's *Judicial Evidence* produced little effect on the reviewers. His own reception at the Speculative Debating Society, where he first measured his strength in public conflict, was calculated to produce self-distrust. He found himself looked upon with curiosity as a precocious phenomenon, a "made man," an intellectual machine set to grind certain tunes. The outcome of this period of depression was a broadening of his outlook on the problems

which he had set himself to solve. He now saw that regard for the public good was too vague an object for the satisfaction of a man's affections. It is a proof of the dominating force of his father's character that it cost the younger Mill such an effort to shake off his stern creed about poetry and personal emotion. Like Plato, the elder Mill would have put poets under ban as enemies of truth, and he subordinated private to public affections. Lander's maxims of "few acquaintances, fewer friends, no familiarities" had his cordial approval. These doctrines the younger Mill now felt himself forced in reason to abandon. Too much in awe of his father to make him a confidant, he wrestled in the gloomy solitude of his own mind. He gained from the struggle a more catholic view of human happiness, at delight in the poetry of nature and the affections as well as the poetry of heroic unselfishness, a disposition to study more sympathetically the point of view of opponents, a more courteous style of polemic, a hatred of sectarianism, an ambition, no less noble and disinterested, but moderated to practical possibilities.

In the course of the next few years he wrote comparatively little, but he continued his reading, and also derived much benefit from discussions held twice a week at Grote's house in Threadneedle Street. Gradually also he had the satisfaction of seeing the debates in the Speculative Society becoming famous enough to attract men with whom it was profitable for him to interchange opinions, among others Maurice and John Sterling. He ceased to attend the society in 1820, but he carried away from it the strengthening memory of failure overcome by persevering effort, and the important doctrinal conviction that a true system of political philosophy was "something much more complex and many-sided than he had previously had any idea of, and that its office was to supply, not a set of model institutions but principles from which the institutions suitable to any given circumstances might be deduced."

The first sketch of Mill's political philosophy appeared in a series of contributions to the *Examiner* in the autumn of 1830 entitled "Prospects in France." He was in Paris soon after the July Revolution, and made the acquaintance of the leading spirits among the younger men; in his discussion of their proposals we find the germs of many thoughts afterwards more fully developed in his *Representative Government*. It is from this time that Mill's letters supply a connected account of his life (see Hugh Elliott, *Letters of John Stuart Mill*, 1910).

The letters in the *Examiner* may be taken as marking the close of his period of meditative search, and his return to hopeful aspiring activity. It was characteristic of his nature that he should be stirred to such delight by the Revolution in France, and should labour so earnestly to make his countrymen understand with what gravity and sobriety it had been effected. Their own Reform Bill came soon after and it is again characteristic of Mill—at once of his enthusiasm and of his steady determination to do work that nobody else seemed able or willing to do—that we find him in the heat of the struggle in 1831 writing to the *Examiner* a series of letters on "The Spirit of the Age" which drew from Carlyle the singular exclamation "Here is a new mystic!" How little this criticism was justified may be seen from the fact that Mill's inductive logic was the direct result of his aspirations after political stability as determined by the dominion of the wisest (*Examiner* letters). "Why is it," he asked, "that the multitude accept implicitly the decisions of the wisest, of the specially skilled, in physical science?" Because in physical science there is all but complete agreement in opinion. "And why this agreement?" Because all accept the same methods of investigation, the same tests of truth. Is it possible then to obtain unanimity as to the methods of arriving at conclusions in social and political matters, so as to secure similar agreement of opinion among the specially skilled, and similar general respect for their authority? The same thought appears in a review of Herschel's *Natural Philosophy*, written about the same time. Mill remarks that the uncertainty hanging over the very elements of moral and social philosophy proves that the means of arriving at the truth in those sciences are not yet

properly understood. "And whither," he adds, "can mankind so advantageously turn, in order to learn the proper means, and to form their minds to the proper habits, as to that branch of knowledge in which by universal acknowledgment the greatest number of truths have been ascertained, and the greatest possible degree of certainty arrived at?"

By 1831 the period of depression had passed; Mill's enthusiasm for humanity had been thoroughly reawakened, and had taken the definite shape of an aspiration to supply an unimpeachable method of search for conclusions in moral and social science. No mystic ever worked with warmer zeal than Mill. But his zeal encountered a check which baffled him for several years, and which left its mark in various inconsistencies and incoherencies in his completed system. He had been bred by his father in a great veneration for the syllogistic logic as an antidote against confused thinking. He attributed to his early discipline in this logic an impatience of vague language which in all likelihood was really fostered in him by his study of the Platonic dialogues and of Bentham, for he always had in himself more of Plato's fertile ingenuity in canvassing the meaning of vague terms than the schoolman's rigid consistency in the use of them. Be this as it may, enthusiastic as he was for a new logic that might give certainty to moral and social conclusions, Mill was no less resolute that the new logic should stand in no antagonism to the old. In his *Westminster* review of Whately's *Logic* in 1828 (invaluable to all students of the genesis of Mill's logic) he appears, curiously enough, as an ardent and brilliant champion of the syllogistic logic against highfliers such as the Scottish philosophers who talk of "superseding" it by "a supposed system of inductive logic." His inductive logic must "supplement and not supersede." But for several years he searched in vain for the means of concatenation.

Meantime, while recurring again and again, as was his custom, to this cardinal difficulty, Mill worked indefatigably in other directions where he saw his way clear. The working of the new order in France, and the personalities of the leading men, had a profound interest for him; he wrote on the subject in the *Examiner*. He had ceased to write for the *Westminster* in 1828; but during the years 1832 and 1833 he contributed many essays to *Tait's Magazine*, the *Jurist*, and the *Monthly Repository*. In 1835 Sir William Molesworth founded the *London Review* with Mill as editor; it was amalgamated with the *Westminster* (as the *London and Westminster Review*) in 1836, and Mill continued editor (latterly proprietor also) till 1840. Much of what he wrote then was subsequently incorporated in his systematic works: some of his essays were reprinted in his first two volumes of *Dissertations and Discussions* (1850). The essays on Bentham and Coleridge constituted the first manifesto of the new spirit which Mill sought to breathe into English Radicalism. But the reprinted papers give no just idea of the immense range of Mill's energy at this time. His position in the India Office, where alone he did work enough for most men, cut him off from entering parliament; but he laboured hard though ineffectually to influence the legislature from without by combating the disposition to rest and be thankful. In his *Autobiography* he admits that the attempt to form a Radical party in parliament at that time was chimerical.

It was in 1837, on reading Whewell's *Inductive Sciences* and re-reading Herschel, that Mill at last saw his way clear both to formulating the methods of scientific investigation and joining on the new logic as a supplement to the old. The *Logic* was published in 1843. In 1844 appeared his *Essays on Some Unsettled Questions in Political Economy*. These essays were worked out and written many years before, and show Mill in his first stage as a political economist. Four out of the five essays are elaborate and powerful solutions of perplexing technical problems—the distribution of the gains of international commerce, the influence of consumption on production, the definition of productive and unproductive labour, the precise relations between profits and wages. Though Mill appears here purely as the disciple of Ricardo, striving after more precise statement, and reaching forward to further consequences, we

can well understand in reading these essays how about the time when he first sketched them he began to be conscious of power as an original and independent thinker.

That originality and independence became more conspicuous when he reached his second stage as a political economist, struggling forward towards the standpoint from which his systematic work was written. It would seem that in his fits of despondency one of the thoughts that marred his dreams of human improvement was the apparently inexorable character of economic laws, condemning thousands of labourers to a cramped and miserable existence, and thousands more to semi-starvation. From this oppressive feeling he found relief in the thought set forth in the opening of the second book of his *Political Economy*—that, while the conditions of production have the necessity of physical laws, the distribution of what is produced among the various classes of producers is a matter of human arrangement, dependent upon alterable customs and institutions. There can be little doubt that this thought, whether or not in the clear shape that it afterwards assumed, was the germ of all that is most distinctive in his system of political economy. This system, which for many years subsequently was regarded as authoritative, has been subjected to vigorous criticism by later economists, and it is perhaps not too much to say that it now possesses mainly an historical interest. Its chief importance is perhaps the stress which it laid on the vital connexion which must subsist between true economic theory and the wider facts of social and national development.

While his great systematic works were in progress, Mill wrote very little on events or books of the day. He turned aside for a few months from his *Political Economy* during the winter of the Irish famine (1846-1847) to advocate the creation of peasant-proprietorships as a remedy for distress and disorder in Ireland. He found time also to write elaborate articles on French history and Greek history in the *Edinburgh Review* apropos of Michelet, Guizot and Grote, besides some less elaborate essays.

The *Political Economy* was published in 1848. Mill could now feel that his main work was accomplished; he remained, however, on the alert for opportunities of useful influence, and pressed on with hardly diminished enthusiasm in his search for useful truth. Among other things, he made a more thorough study of socialist writers, with the result that, though he was not converted to any of their schemes as being immediately practicable, he began to look upon some more equal distribution of the produce of labour as a practicability of the remote future, and to dwell upon the prospect of such changes in human character as might render a stable society possible without the institution of private property. This he has called his third stage as a political economist, and he says that he was helped towards it by the lady, Mrs Taylor,¹ who became his wife in 1851. It is generally supposed that he writes with a lover's extravagance about this lady's powers when he compares her with Shelley and Carlyle. But a little reflection will show that he wrote with his usual accuracy and sobriety when he described her influence on him. He expressly says that he owed none of his technical doctrine to her, that she influenced only his ideals of life for the individual and for society; the only work perhaps which was directly inspired by her is the essay on the enfranchisement of women (*Dissertations*, vol. ii.). It is obvious from what he says that his inner life became very different after he threw off his father's authority. This new inner life was strengthened and enlarged by Mrs Taylor.

During the seven years of his married life Mill published less than in any other period of his career, but four of his most

¹ Mrs Taylor (Harriet Hardy) was the wife of John Taylor, a wholesale druggist in the city of London. She was a confirmed invalid, and lived in the country, where Mill visited her regularly for twenty years, with the full consent of her husband, a man of limited mental powers, but of high character and unselfishness. Mill's friendship with Mrs Taylor and their marriage in 1851 involved a break with his family (apparently due to his resentment at a fancied slight, not to any bitterness on their part), and his practical disappearance from society. (On these points see Mary Taylor, Mrs Mill's grand-daughter, in Elliott's edition of the *Letters*.)

closely reasoned and characteristic works, the *Liberty*, the *Utilitarianism*, the *Thoughts on Parliamentary Reform*, and the *Subjection of Women*, besides his posthumously published essays on *Nature* and on the *Utility of Religion*, were thought out and partly written in collaboration with his wife. In 1856 he became head of the examiner's office in the India House, and for two years, till the dissolution of the Company in 1858, his official work, never a light task, kept him fully occupied. It fell to him as head of the office to write the defence of the Company's government of India when the transfer of its powers was proposed. Mill was earnestly opposed to the transfer, and the documents in which he substantiated the proud boast for the Company that "few governments, even under far more favourable circumstances, have attempted so much for the good of their subjects or carried so many of their attempts to a beneficial issue," and exposed the defects of the proposed new government, are models of trenchant and dignified pleading.

On the dissolution of the Company Mill was offered a seat in the new council, but declined, and retired with a pension of £7500. His retirement from official work was followed almost immediately by his wife's death at Avignon, whither they had come in the course of a tour. So great was the shock that for the rest of his life he spent most of his time at a villa at St Véran, near Avignon, returning to his Blackheath residence only for a short period in each year. He sought relief in active literary occupation, in politics, sociology and psychology. He published, with a touching dedication to his wife, the treatise on *Liberty*, which they had wrought out together. He then turned to politics, and published, in view of the impending Reform Bill, a pamphlet on parliamentary reform. The chief feature in this was an idea concerning which he and Mrs Mill often deliberated—the necessity of providing checks against uneducated democracy. His suggestion of a plurality of votes, proportioned to the elector's degree of education, was avowedly put forward only as an ideal; he admitted that no authentic test of education could for the present be found. An anonymous Conservative caught at the scheme in another pamphlet, proposing income as a test. Soon after Mill supported in *Fraser's*, still with the same object, Hare's scheme for the representation of minorities. In the autumn of the same year he turned to psychology, reviewing Bain's works in the *Edinburgh Review*. In his *Representative Government* (1860) he systematized opinions already put forward in many casual articles and essays. His *Utilitarianism* (published in *Fraser's* in 1861) was a closely-reasoned systematic attempt to answer objections to his ethical theory and remove misconceptions of it. He was especially anxious to make it clear that he included in "utility" the pleasures of the imagination and the gratification of the higher emotions, and to show how powerfully the good of mankind as a motive appealed to the imagination. His next treatise, *The Subjection of Women*, was not published till 1869.¹ His *Examination of Hamilton's Philosophy*, published in 1865, had engaged a large share of his time for three years before.

While mainly occupied in those years with philosophical studies, Mill did not remit his interest in current politics. He supported the North in the American crisis of 1862, using all his strength to explain what has since been universally recognized as the issue really at stake in the struggle, the abolition of slavery. It was characteristic of the closeness with which he watched current events, and of his zeal in the cause of "lucidity," that when the *Reader*, an organ of science and unpartisan opinion, fell into difficulties in 1865 Mill joined with some distinguished men of science and letters in an effort to keep it afloat. He supplied part of the money for carrying it on, contributed several articles, and assisted the editor, Fraser Rae, with his advice. The effort was vain, though such men as Herbert Spencer,

Huxley, Tyndall, Cairnes, Mark Pattison, F. Harrison, Sir Frederick Pollock and Lockyer were among the contributors.

In 1805 he agreed to stand as parliamentary candidate for Westminster, on conditions strictly in accordance with his principles. He would not canvass, nor pay agents to canvass for him, nor would he engage to attend to the local business of the constituency. He was with difficulty persuaded even to address a meeting of the electors. The story of this remarkable election has been told by James Beal, one of the most active supporters of Mill's candidature. In parliament he adhered to his life-long principle of doing only work that needed to be done, and that nobody else seemed equally able or willing to do. It may have been a consciousness of this fact which prompted a remark, made by the Speaker, that Mill's presence in parliament elevated the tone of debate. The impression made by him in parliament is in some danger of being forgotten, because he was not instrumental in carrying any great measure that might serve as an abiding memorial. But, although his first speech on the bill for the prevention of cattle diseases excited the opposition of country members, and a subsequent speech against the suspension of the Habeas Corpus Act in Ireland was very unfavourably received, Mill thoroughly succeeded in gaining the ear of the House. The only speech made by him during his three years in parliament that was listened to with impatience was, curiously enough, his speech in favour of counteracting democracy by providing for the representation of minorities. His attack on the conduct of Governor Eyre in Jamaica (*q.v.*) was listened to, but with repugnance by the majority, although his action in this matter in and out of parliament was far from being ineffectual. He took an active part in the debates on Disraeli's Reform Bill (moving an amendment to omit the word "man" and insert "person"), and helped to extort from the government several useful modifications of the Bill for the Prevention of Corrupt Practices. The reform of land tenure in Ireland, the representation of women, the reduction of the national debt, the reform of London government, the abrogation of the Declaration of Paris, were among the topics on which he spoke with marked effect. He took occasion more than once to enforce what he had often advocated in writing, England's duty to intervene in foreign politics in support of the cause of freedom. As a speaker Mill was somewhat hesitating, pausing occasionally as if to recover the thread of his argument, but he showed great readiness in extemporaneous debate. Viewed as a candidate for ministerial office, he might be regarded as a failure in parliament, but there can be no doubt that his career there greatly extended his influence.

Mill's subscription to the election expenses of Bradlaugh, and his attitude towards Governor Eyre, are generally regarded as the main causes of his defeat in the general election of 1868. But, as he suggests himself, his studied advocacy of unfamiliar projects of reform had made him unpopular with "moderate Liberals." He retired with a sense of relief to his cottage and his literary life at Avignon. His parliamentary duties and the quantity of correspondence brought upon him by increased publicity had absorbed nearly the whole of his time. The scanty leisure of his first recess had been devoted to writing his St Andrews rectorial address on higher education and to answering attacks on his criticism of Hamilton; of the second, to annotating in conjunction with Bain and Findlater, his father's *Analysis of the Mind*. Now he looked forward to a literary life, and his letters show how much he enjoyed the change. His little cottage was filled with books and newspapers; the beautiful country round it furnished him with a variety of walks; he read, wrote, discussed, walked, botanized. He was extremely fond of music, and was himself a fair pianist. His step-daughter, Miss Taylor (*d.* January 1907), was his constant companion after his wife's death. "Helen," he wrote to W. T. Thornton, an old colleague in the India House, "has carried out her long-cherished scheme (about which she tells me she consulted you) of a 'vibratory' for me, and has made a pleasant covered walk, some 30 ft. long, where I can vibrate in cold or rainy weather. The terrace, you must know, as it goes round two sides of the house, has got itself

¹ He was one of the founders, with Mrs P. A. Taylor, Miss Emily Davies and others, of the first women's suffrage society, which developed into the National Union of Women's Suffrage Societies, and his writings are still the most important theoretical statement of the case for women's suffrage. He presented to Parliament the first petition on the subject (see further Blackburn, *Women's Suffrage Record*).

dubbed the 'semi-crymatory.' In addition to this, Helen has built me a herbarium, a little room fitted up with closets for my plants, shelves for my botanical books, and a great table whereon to manipulate them all. Thus, you see, with my herbarium, my vibratory, and my semi-crymatory, I am in clover; and you may imagine with what scorn I think of the House of Commons, which, comfortable club as it is said to be, could offer me none of these comforts, or, more perfectly speaking, these necessities of life." Mill was an enthusiastic botanist all his life long, and a frequent contributor of notes and short papers to the *Phytologist*. One of the things that he looked forward to during his last journey to Avignon was seeing the spring flowers and completing a flora of the locality. His delight in scenery frequently appears in letters written to his friends during his summer and autumn tours.

Yet he did not relax his laborious habits nor his ardent outlook on human affairs. The essays in the fourth volume of his *Dissertations*—on endowments, on land, on labour, on metaphysical and psychological questions—were written for the *Fortnightly Review* at intervals after his short parliamentary career. One of his first tasks was to send his treatise on the *Subjection of Women* (written 1861, published 1869, many editions) through the press. The essay on *Theism* was written soon after. The last public work in which he engaged was the starting of the Land Tenure Reform Association. The interception by the state of the unearned increment, and the promotion of co-operative agriculture, were the most striking features in his programme. He wrote in the *Examiner* and made a public speech in favour of the association a few months before his death. The secret of the ardour with which he took up this question probably was his conviction that a great struggle was impending in Europe between labour and capital. He regarded his project as a timely compromise.

Mill died at Avignon on the 8th of May 1873. He was a man of extreme simplicity in his method of life. Though occasionally irritable in speech, in his written polemics he was remarkable for courtesy to opponents and a capacity to understand their point of view. His references to his friends were always generous, and he was always ready to assist those whose work needed help. For example, he desired to guarantee the cost of the first books of Bain and Herbert Spencer. A statue in bronze was placed on the Thames Embankment, and there is a good portrait by Watts (a copy of which, by Watts himself, was hung in the National Gallery).

The influence which Mill's works exercised upon contemporary English thought can scarcely be overestimated. His own writings and those of his successors (e.g. J. E. Cairnes and Alexander Bain) practically held the field during the third quarter of the 19th century and even later. In philosophy his chief work was to systematize and expound the utilitarianism of his father and Bentham (see UTILITARIANISM). He may, in fact, be regarded as the final exponent of that empirical school of philosophy which owed its impulse to John Locke, and is generally spoken of as being typically English. Its fundamental characteristic is the emphasis laid upon human reason, i.e. upon the duty incumbent upon all thinkers to investigate for themselves rather than to accept the authority of others. Knowledge must be based upon experience. In reasserting and amplifying the empirical conclusions of his predecessors, especially in the sphere of ethics, Mill's chief function was the introduction of the humanist element. This was due, no doubt, to his revulsion from the sternness of his upbringing and the period of stress through which he passed in early manhood, but also to the sympathetic and emotional qualities which manifested themselves in his early manhood. We have seen, for example, that he was led to investigate the subject of logic because he found in attempting to advance his humanitarian schemes in politics an absence of that fundamental agreement which he recognized as the basis of scientific advance. Both his logical and his metaphysical studies were thus undertaken as the pre-requisites of a practical theory of human development. Though he believed that the lower classes were not yet ripe for socialism, with the principles of which he (unlike James Mill and Bentham) was in general agreement, his whole life was devoted to the amelioration of the conditions of the working classes. This fact, no doubt, should be taken into account in any detailed criticism of the philosophic work; it was taken up not as an end but as ancillary to a social and ethical system. Reference to the articles on LOGIC, METAPHYSICS, &c., will show that subsequent criticism, however much it has owed by way of stimulus to Mill's strenuous rationalism, has been able to point to much that is inconsistent, inadequate and even superficial in his

writings. Two main intellectual movements from widely different standpoints have combined to diminish his influence. On the one hand there has arisen a school of thinkers of the type of Thomas Hill Green, who have brought to bear on his metaphysical views the idealism of modern German thinkers. On the other hand are the evolutionists, who have substituted for the utilitarian ideal of the "greatest happiness" those of "race-preservation" and the "survival of the fittest" (see ETHICS, ad. fin.; SPENCER). In the sphere of psychology, likewise—e.g. in connexion with Mill's doctrine of Association of Ideas (q.v.) and the phrase "Mental Chemistry," by which he sought to meet the problems which Associationism left unsolved—modern criticism and the experimental methods of the psycho-physiological school have set up wholly new criteria, with a new terminology and different fields of investigation (see PSYCHOLOGY).

A similar fate has befallen Mill's economic theories. The title of his work, *Principles of Political Economy*, with some of their Applications to Social Philosophy, though open to criticism, indicated a less narrow and formal conception of the field of the science than had been common amongst his predecessors. He aimed in fact at producing a work which might replace in ordinary use the *Wealth of Nations*, which in his opinion was "in many parts obsolete and in all imperfect." Adam Smith had invariably associated the general principles of the subject with their applications, and in treating those applications had perpetually appealed to other and often far larger considerations than pure political economy afforded. And the spirit in which Mill desired, whilst incorporating all the results arrived at in the special science by Smith's successors, to exhibit purely economic phenomena in relation to the most advanced conceptions of his own time in the general philosophy of society, as Smith had done in reference to the philosophy of his century. This design he certainly failed to realize. His book is very far indeed from being a "modern Adam Smith." It is an admirably lucid, and even elegant, exposition of the Ricardian economics, the Malthusian theory being of course incorporated with these; but, notwithstanding the introduction of many minor novelties, it is in its scientific substance little or nothing more.

With respect to economic method he shifted his position, yet to the end occupied an ancient ground. In the fifth of his early essays he asserted that the method *a priori* is the only mode of investigation in the social sciences, and that the method *a posteriori* "is altogether inefficacious in those sciences as a means of arriving at any considerable body of valuable truth." When he wrote his *Logic* he had learned from Comte that the *a posteriori* method—in the form which he chose to call "inverse deduction"—was the only mode of arriving at truth in general sociology; and his admission of this at once renders the essay obsolete. But, unwilling to relinquish the *a priori* method of his youth, he tries to establish a distinction of two sorts of economic inquiry, one of which, though not the other, can be handled by that method. Sometimes he speaks of political economy as a department "carved out of the general body of the science of society;" whilst on the other hand he has systematic work implies a doubt whether political economy is a part of "social philosophy" at all, and not rather a study preparatory and auxiliary to it. Thus, on the logical as well as the dogmatic side, he halts between two opinions. Notwithstanding his misgivings and even disclaimers, he yet remained as to method a member of the old school, and never passed into the new "historical" school.

BIBLIOGRAPHY.—Works: *System of Logic* (2 vols., 1843; 9th ed., 1875; "People's" ed., 1884); *Essays on some Unsettled Questions of Political Economy* (1844, ed. 1874); *Principles of Political Economy* (2 vols., 1848; many ed., especially ed. by W. J. Ashley, 1909); *On Liberty* (1859; ed. Courtney, 1892; W. B. Columbia, 1903; with introd. Pringle-Pattison, 1910); *Thoughts on Parliamentary Reform* (1870); *Dissertations and Discussions* (i., ii., 1859; iii., 1867; iv., 1896); *Considerations on Representative Government* (1863; 3rd ed., 1865); *Utilitarianism* (1863); *Examination of Sir W. Hamilton's Philosophy* (1865); *Aug. Comte and Positivism* (1865; ed. 1908); *Inaugural Address at the University of St Andrews* (1867); *England and Ireland* (1868); *Subjection of Women* (1869; ed. with introd. by Stanton Oct., 1906); *Chapters and Speeches on the Irish Land Question* (1870). The *Autobiography* appeared in 1873 (ed. 1908), and *Three Essays on Religion* (1874). Many of these have been translated into German, and there is a German edition by Th. Gomperz (12 vols., 1873-1880). A convenient edition in the New Universal Library appeared between 1905 and 1910.

Biographical and Critical.—Many of Mill's letters are published in Mrs Grote's life of her husband, in Duncan's *Life of Herbert Spencer*, in the *Memories of Caroline Fox*, and in Kingsley's letters. There are also editions of the correspondence with Gustave d'Eichthal and Comte (especially that of Lévy-Bruhl, 1899). By far the most illuminating collection is that of Hugh Elliott, *Letters of John Stuart Mill* (2 vols., 1910), which contains letters to John Sterling, Carlyle, E. Lytton Bulwer (Lord Lytton), John Austin, Alex. Bain, and many leading French and German writers and politicians. These letters are essential to an understanding of Mill's life and thought. Besides the *Autobiography* and many references in the writings of Mill's friends (e.g. Alex. Bain's *Autobiography*, 1904), see further

A. Bain, *John Stuart Mill, a Personal Criticism* (1882); Fox Bourne, *Life of J. S. Mill* (1873); John (Viscount) Morley, *Miscellaneous* (1877), ii. 230-327; J. E. Cairnes, *J. S. Mill* (1873), an economic theories; W. L. Courtney, *Metaphysics of J. S. Mill* (1879) and *Life* (1889); Douglas, *John Stuart Mill, a Study of his Philosophy* (1895), and *Ethics of J. S. Mill* (1897); Albee, *Hist. of Eng. Utilitarianism* (1902); Sir Leslie Stephen, *The English Utilitarians* (1900); J. MacCunn, *Six Radical Thinkers* (1907); Fred. Harrison, *Tennyson, Ruskin, Mill* (1896); John Watson, *Comte, Mill and Spencer* (1895); T. Whittaker, *Comte and Mill* (1905); Charles Douglas, *J. S. Mill, a Study of his Philosophy* (1895); J. Rickaby, *Free Will and Four English Philosophers* (1906); J. M. Robertson, *Modern Humanism* (1891); D. G. Ritchie, *Principles of State Interference* (1891); W. Graham, *English Political Philosophy from Hobbes to Maine* (1899). There are also a number of valuable French and German criticisms, e.g. Taine, *Positivisme anglais, étude sur Stuart Mill* (Paris, 1864); F. A. Lange, *Mills Ansichten über die soziale Frage* (Duisburg, 1866); Littré, *A. Comte et Stuart Mill* (3rd ed., Paris, 1877); Cauret, *Philosophie de Stuart Mill* (Paris, 1885); Gomperz, *John S. Mill, ein Nachruf* (Vienna, 1889); S. Sanger, *J. S. Mill, sein Leben und Lebenswerk* (Stuttgart, 1901); S. Becher, *Erkenntnistheoretische Untersuchungen zu Stuart Mills Theorie der Kausalität* (1906); E. M. Kantzer, *La Religion de J. S. Mill* (1906). See also histories of modern philosophy.

See further LOGIC (Historical Sketch); PSYCHOLOGY; ASSOCIATION OF IDEAS. (W. M.: J. M. M.)

MILL (O. Eng. *mýlen*, later *myln*, or *minn*, adapted from the late Lat. *molina*, cf. Fr. *moulin*, from Lat. *mola*, a mill, *molere*, to grind; from the same root, *mol*, is derived "meal," the word appears in other Teutonic languages, cf. Du. *molen*, Ger. *mühle*), the term given to the apparatus or machinery used in the grinding of corn into flour, and hence applied to similar mechanical devices for grinding, crushing to powder, or pulping other substances, e.g. coffee-mill, powder-mill. "Mill" was first used of the building containing the apparatus, frequently with a word attached descriptive of the motive power, e.g. wind-mill, water-mill, &c. It was not the early word used of the actual grinding mechanism. The old hand-mill was known as a "quern," a word which appears in this sense in many Indo-European languages; the ultimate root is *gar-*, to grind. "Quern" (see FLOUR) is only remotely connected with "churn" (q.v.). The word is also applied to many mechanical devices by which raw material is transformed into a condition ready for use or into a stage preparatory to other processes, e.g. saw-mill, rolling-mill, &c., or still more widely to buildings containing machinery used in manufactures, e.g. cotton-mill. In mining it is applied to various machines used in breaking and crushing the ore (see ORE-DRESSING).

In the engineering industries milling machines constitute a very important class of machine tools, the characteristic of which is that rotary cutters are employed for shaping the metal (see TOOLS). In coins the "milling" is the serrated edge, called "crenelling" by John Evelyn (*Discourse on Medals*, 1697, p. 225), which is formed on them to prevent clipping and filing. Coins made by the old process of hammering were apt to have irregular edges which invited mutilation; but the introduction of the screw press, which came to be known as a mill (cf. W. Lowndes, *Amendm. Silver Coinage*, 1695, p. 93), permitted the production of a regular edge with serrations, which in consequence were termed milling. This machine also enabled legends to be impressed round the edges of coins, such as the *Decus et tutamen* suggested by Evelyn (see W. J. Hocking, *Catalogue of the Coins, &c., in the Museum of the Royal Mint*, 1906). It was invented about the middle of the 16th century, and has generally been attributed to Guyot Brucher (d. 1556), who was succeeded at the Paris mint by his brother Antoine. Introduced into England by one Eloye Mestreil in 1561, it was used for twelve years, and was then abandoned owing to the opposition of the mint officials to Mestreil, who was executed for counterfeiting and striking money outside the precincts of the Tower of London; but it was again introduced by one Peter Blondeau in 1662, when it permanently superseded hammering. In the United States of America the term "milling" or "milled" is applied to the raised edge on the face of the coin; this is known in the British mint as "marking" (see MINT).

MILLAIS, SIR JOHN EVERETT (1829-1896), English painter, was born at Southampton on the 8th of June 1829, the son of

John William Millais, who belonged to an old Norman family settled in Jersey for many generations, and Emily Mary, née Evamy, the widow of a Mr Hodgkinson. After his birth the family returned to Jersey, where the boy soon began to sketch. At the age of eight he drew his maternal grandfather. He went to school for a short time, but showed no inclination for study, and was afterwards educated entirely by his mother. In 1835 the family removed to Dinan in Brittany, where he sketched the French officers, to their great amusement, and in 1837, on the family's return to Jersey, he was taught drawing by a Mr Bissel. In 1838 he came to London, and on the strong recommendation of Sir Martin Archer Shee, P.R.A., his future was decided. He was sent at once to Sass's school, and entered the Academy schools in 1840. He won a silver medal from the Society of Arts in 1839, and carried off all the prizes at the Royal Academy. He was popular amongst the students, and was called "the child," because he wore his boyish costume till long after the usual age. In 1840 and the immediately succeeding years he made the acquaintance of Wordsworth and other interesting and useful people. He was at this time painting small pictures, &c., for a dealer named Thomas, and defraying a great part of the household expenses in Gower Street, where his family lived. In 1846 he exhibited "Pizarro seeing the Inca of Peru" at the Royal Academy, and in 1847 "Elgiva seized by the Soldiers of Odo." In the latter year he competed unsuccessfully at the exhibition of designs for the decoration of the Houses of Parliament, sending a very large picture of "The Widow's Mite," which was afterwards cut up. In the beginning of 1848 he and W. Holman Hunt, dissatisfied with the theory and practice of British art, which had sunk to its lowest and most conventional level, initiated what is known as the Pre-Raphaelite movement, and were joined by Dante Gabriel Rossetti, and afterwards by five others, altogether forming the Pre-Raphaelite Brotherhood. Rossetti was then engaged, under the technical guidance of Hunt, upon his picture of "The Girlhood of Mary Virgin," which, with Hunt's "Light of the World" and Millais's "Christ in the House of His Parents," forms what has been called the trilogy of Pre-Raphaelite art. According to Millais, the Pre-Raphaelites had but one idea—"to present on canvas what they saw in Nature." Millais's first picture on his new principles was a banquet scene from Keats's "Isabella" (1849), and contains all the characteristics of Pre-Raphaelite work, including minute imitation of nature down to the smallest detail, and the study of all persons and objects directly from the originals. The tale was told with dramatic force, and the expression of the heads was excellent. His next important picture, "Christ in the House of His Parents," or "The Carpenter's Shop" (1850), represented a supposed incident in the childhood of our Lord treated in a simply realistic manner, and drew down upon him a storm of abuse from nearly all quarters, religious and artistic. The rest of his more strictly Pre-Raphaelite pictures—"The Return of the Dove to the Ark," "The Woodman's Daughter" and the "Mariana" of 1851, "The Huguenot" and "Ophelia" of 1852, "The Proscribed Royalist" and "The Order of Release" of 1853—met with less opposition, and established his reputation with the public. Indeed, this may be said to have been accomplished by the "Huguenot" and "Ophelia," the refined sentiment and exquisite execution of which appealed to nearly all who were unprejudiced. The public were also greatly influenced by the splendid championship of Ruskin, who, in letters to *The Times*, and in a pamphlet called "Pre-Raphaelitism," enthusiastically espoused the cause of the Brotherhood. In 1851 Millais, who had refused to read *Modern Painters*, where the supposed principles of the Brotherhood were first recommended, became acquainted with Ruskin, and in 1853 went to Scotland with him and Mrs Ruskin, the latter of whom sat for the woman in "The Order of Release." He made several designs for Ruskin, and painted his portrait. In 1855 Millais exhibited "The Rescue," a scene from a fire, which drew great attention, from the frantic expression of the mother and the brilliant painting of the glare. In the Paris Exhibition of this year he was represented by "The Order of Release," "Ophelia" and "The Return of the Dove." This was also the

year of his marriage with Mrs Ruskin (Euphemia Chalmers, daughter of Mr George Gray of Bowerswell, Perth), who had obtained a decree of the nullity of her previous marriage. The newly-wedded couple went to live at Annat Lodge, near Bowerswell, where "Autumn Leaves," described by Ruskin as "the first instance of a perfect twilight," was painted. This and "Peace Concluded" were singled out for special praise by Ruskin in his notes on the Academy Exhibition of 1856, which contained, with other works by Millais, the picture of "A Blind Girl," with a beautiful background of Icklesham and its common. The principal pictures of 1857 were "Sir Isambard at the Ford," and "The Escape of a Heretic," both of which were violently attacked by Ruskin, who was kinder to the "Apple-blossoms" and "Vale of Rest" of 1859, extolling the power of their painting, but still insisting on the degeneracy of the artist. The "Black Brunswicker" of 1860 was in motive very like the "Huguenot," but it was less refined in expression, and a great deal broader in execution, and may be said to mark the end of the period of transition from his minute Pre-Raphaelite manner to the masterly freedom of his mature style. From 1860 to 1869 the invention of Millais was much employed in illustration, especially of Trollope's novels, beginning with *Framley Parsonage* in the *Cornhill Magazine*. He made altogether eighty-seven drawings for Trollope, and was the cleverest and one of the most prolific of the book illustrators of the 'sixties. He contributed to Moxon's illustrated edition of *Tennyson's Poems*, and made occasional drawings for *Once a Week*, the *Illustrated London News*, *Good Words*, and other periodicals and books. In 1863 he was elected a Royal Academician. The most important pictures of this and the next few years were "The Eve of St Agnes," remarkable for the painting of moonlight, "Romans leaving Britain" (1865), "Jephthah" (1867), "Rosalind and Celia" (1868), "A Flood," and "The Boyhood of Raleigh" (1870). All these were executed in a very broad and masterly manner. In many of his pictures of this period, such as "The Boyhood of Raleigh," his children were his models, and formed the subject of many more, like "My First Sermon," "My Second Sermon," "Sleeping," "Awake," "Sisters," "The First Minuet," and "The Wolf's Den." He now painted many single figures with more or less sentiment, like "Stella," "Vanessa," and "The Gambler's Wife," with occasionally a more important composition, like "Pilgrims to St Paul's," and "Victory, O Lord" (exhibited 1871), representing Aaron and Hur holding up Moses' hands (Exod. xvii. 12). With it was exhibited the first and most popular of his pure landscapes, called "Chill October," which was followed at intervals by several others remarkable for literal truth to nature and fine execution. They were all from Perthshire, where he generally spent the autumn, and included "Scotch Firs" and "Winter Fuel" (painted in 1874), "Over the Hills and Far away," and "The Fringe of the Moor" (1875) and "The Sound of many Waters" (1876). A later series was painted in the neighbourhood of Murthly, a village in the parish of Little Dunkeld, Perthshire, where he rented a house and shooting from 1881 to 1891. It was to painting nature and the world around him that he principally devoted himself for the last twenty-five years of his life, abandoning imaginative or didactic themes. To this period belong a number of pictures of children, with fancy titles, like "Cherry Kipe," "Little Miss Muffet," "Bubbles," and others well known by reproductions in black and white and in colour for the illustrated papers; and also some charming studies of girlhood, like "Sweetest eyes were ever seen," and "Cinderella." Amongst his more serious pictures were "The Princes in the Tower" (1878), "The Princess Elizabeth" (1879), two pictures from Scott—"Effie Deans" and "The Master of Ravenswood"—painted for Messrs Agnew in 1877 and 1878, and "The North-West Passage," sometimes regarded as his masterpiece, representing an old mariner (painted from Edward John Trevelyan, the friend of Byron) listening to some tale of Arctic exploration in a room overlooking the sea and strewn with charts. "A Yeoman of the Guard" (1877) was perhaps his most splendid piece of colour, and was greatly admired at the Paris Exhibition

of 1878, where it was sent with "Chill October" and three others of his pictures. But perhaps the works of his later years by which he will be most remembered are his portraits—especially his three portraits of Gladstone (1879, 1885 and 1890), and those of John Bright, of Lord Tennyson, and of Lord Beaconsfield, which was left unfinished at his death. He also painted the marquess of Salisbury, Lord Rosebery, the dukes of Devonshire and Argyll, Cardinal Newman, Thomas Carlyle, Sir James Paget, Sir Henry Irving, George Grote, Lord Chief Justice Russell, J. C. Hoak, R.A., and himself (Uffizi Gallery, Florence). He drew Charles Dickens after his death. Amongst his finer portraits of women were those of Mrs Bischoffheim, the duchess of Westminster, Lady Campbell and Mrs Joffing.

No very serious interruption of his usual life as a prosperous English gentleman occurred in these years, except the death of his second son, George, in 1878. In 1875 he went to Holland, one of his few visits to the Continent. In 1879 he left Cromwell Place for a house at Palace Gate, Kensington, which he built, and where he died. In 1885 he was created a baronet, on the suggestion of Mr Gladstone. In 1892 his health began to break down. After a bad attack of influenza he was troubled with a swelling in his throat, which proved to be due to cancer. He suffered much from depression, but worked when he could, and derived much pleasure in painting several pictures, including "St Stephen," "A Disciple," "Speak! Speak!" (which was bought out of the Chantry Bequest), and "The Forerunner"—his last exhibited subject-picture. His finely-characterized portraits of Mr John Hare, the actor, and Sir Richard Quain belong also to his last years. In 1895, in consequence of the illness of Lord (then Sir Frederick) Leighton, he was called upon to preside at the annual banquet of the Royal Academy, and on the death of Lord Leighton he was elected to the presidential chair. He died on the 13th of August 1896, and was buried in St Paul's Cathedral. The Winter Exhibition of the Royal Academy in 1898 was devoted to his works. The list of his honours at home and abroad is a long one. Millais was one of the greatest painters of his time, and did more than any other to infuse a new and healthy life into British art. He had not the imagination of an idealist, but he could paint what he saw with a force which has seldom been excelled. As a man he was manly, frank and genial, devoted to his art and his family, and very fond of sport, especially hunting, fishing and shooting. He was greatly loved by a very large circle of friends. He was singularly handsome, and had a fine presence. The National Gallery of British Art possesses many of his finest works. He is also represented in the National Gallery, in the National Portrait Gallery, the Victoria and Albert Museum, and in the public galleries at Manchester, Liverpool and Birmingham.

AUTHORITIES.—J. G. Millais, *Life and Letters, &c.*; Ruskin's *Modern Painters*, Notes on Royal Academy Exhibitions, *Pre-Raphaelitism, &c.*; Catalogues of Grosvenor Gallery (summer of 1886); and of Royal Academy (winter of 1898); M. H. Spielmann, *Millais and his Works* (London, 1896); A. L. Baldry, *Sir J. E. Millais, his Art and Influence* (London, 1899). (C. Mo.)

MILLAR, ANDREW (1707–1768), British publisher, was born in 1707. About 1729 he started business as a bookseller and publisher in the Strand, London. His own judgment in literary matters was small, but he collected an excellent staff of literary advisers, and did not hesitate to pay what at the time were considered large prices for good material. "I respect Millar, sir," said Dr Johnson in 1755, "he has raised the price of literature." He paid Thomson £105 for *The Seasons*, and Fielding a total sum of £700 for *Tom Jones* and £1000 for *Amelia*. He was one of the syndicate of booksellers who financed Johnson's *Dictionary*, and on him the work of seeing that book through the press mainly fell. He also published the histories of Robertson and Hume. He died at his villa at Kew Green, near London, on the 8th of June 1768.

MILLAU, a town of southern France, capital of an arrondissement in the department of Aveyron, on the right bank of the Tarn at its confluence with the Dourbie, 74 m. N. of Béziers on the Southern railway. Pop. (1906), 16,853. Millau lies in a

rich valley 1200 ft. above the sea surrounded by the spurs of the Levezou, Causse Noir and Larzac ranges. The streets are narrow and some of the houses of great antiquity, but the town is surrounded by spacious boulevards. One of its squares is bordered on two sides by wooden galleries supported on stone columns. The only buildings of special interest are the Romanesque church of Notre Dame, restored in the 16th century, and the fine Gothic belfry of the old hôtel de ville. Millau is seat of a sub-prefect, and possesses tribunals of first instance and of commerce, a board of trade-arbitrators, a chamber of commerce and a communal college. The principal industry is the manufacture of gloves, and various branches of the leather industry are carried on. The chief articles of trade are skins, wool, wine and Roquefort cheese.

In the middle ages Millau was the seat of a viscounty held by the counts of Barcelona and afterwards by the counts of Armagnac. In the 16th century it became one of the leading strongholds of Calvinism in southern France. In 1620 it revolted against Louis XIII., and after its submission Richelieu caused its fortifications to be dismantled. The edict of Nantes hastened the decline of the town, which did not recover its prosperity till after the Revolution.

MILLBURY, a township of Worcester county, Massachusetts, on the Blackstone river, 5 m. S.S.E. of Worcester. Pop. (1890), 4428; (1900) 4460 (1176 foreign-born); (1905, state census) 4631; (1910) 4740. Area, 15.79 sq. m. Millbury is served by the New York, New Haven & Hartford, and the Boston & Albany railways, and by electric interurban railways. It lies for the most part in the valley of the Blackstone river, from which water-power is derived for its mills; among its manufactures are cotton, linen, felt and woollen goods, hemp thread, and foundry and machine-shop products. The municipality owns and operates the waterworks and electric-lighting plant. Millbury was formed in 1813 from the North Parish of Sutton; in 1851 a part of Auburn was annexed to the township.

MILLEDGEVILLE, a city and the county-seat of Baldwin county, in the central part of Georgia, U.S.A., on the Oconee river, at the head of navigation, 32 m. E.N.E. of Macon. Pop. (1890), 3322; (1900), 4219 (2663 negroes); (1910), 4385. It is served by the Georgia and the Central of Georgia railways. Milledgeville is situated in the Cotton Belt, and its principal industry is the preparation of cotton for the markets. The importance of the place, however, is mainly educational and historical. It is the seat of the Middle Georgia Military and Agricultural College, which occupies the old capital building, and of the Georgia Normal and Industrial College for girls (1889; enrolment 1908-1909, 653), which is a part of the University of Georgia, and occupies the site of the old state penitentiary. About 2 m. north-west of Milledgeville is the state juvenile reformatory; 2 m. south of the city are the state asylums for white and negro insane; and 3 m. north-west is the state prison farm. Milledgeville was founded in 1803, and was named in honour of John Milledge (1757-1818), a representative in Congress in 1792-1793 and 1795-1802, governor of Georgia in 1802-1806, a United States senator in 1806-1809, and a benefactor of the state university. In 1804 it was made the seat of the state government in place of Louisville (capital in 1795-1804; pop. in 1900, 1009), a dignity it held until 1868. The city was first chartered in 1836. Although admirably situated for trade and manufacturing, Milledgeville was surpassed in both by Macon, which became the commercial emporium of middle Georgia; but it was a favourite place of residence for the wealthy and cultivated class of Georgians before the Civil War. It was seized by General William T. Sherman on the 23rd of November 1864. In order to remove the state documents beyond reach of the enemy, Governor Joseph E. Brown called upon the convicts in the penitentiary for aid, granting them pardons in return for their services.

MILLENNIUM (a pseudo-Latin word formed on the analogy of *biennium*, *triennium*, from Lat. *mille*, a thousand, and *annus*, year), literally a period of a thousand years. The term is specially used of the period of 1000 years during which Christ,

as has been believed, would return to govern the earth in person. Hence it is used to describe a vague time in the future when all flaws in human existence will have vanished, and perfect goodness and happiness will prevail. The attribution of a mystic significance to the millennium-period, though perhaps not prominent in that theory of Christian eschatology to which the names Millenarianism and Chiliasm (from Gr. *χίλιας*, a thousand) are given, is quite common in non-Christian religions and cosmological systems.

Faith in the nearness of Christ's second advent and the establishing of his reign of glory on the earth was undoubtedly a strong point in the primitive Christian Church. In the anticipations of the future prevalent amongst the early Christians (c. 50-150) it is necessary to distinguish a fixed and a fluctuating element. The former includes (1) the notion that a last terrible battle with the enemies of God was impending; (2) the faith in the speedy return of Christ; (3) the conviction that Christ will judge all men, and (4) will set up a kingdom of glory on earth. To the latter belong views of the Antichrist, of the heathen world-power, of the place, extent, and duration of the earthly kingdom of Christ, &c. These remained in a state of solution; they were modified from day to day, partly because of the changing circumstances of the present by which forecasts of the future were regulated, partly because the indications—real or supposed—of the ancient prophets always admitted of new combinations and constructions. But even here certain positions were agreed on in large sections of Christendom. Amongst these was the expectation that the future kingdom of Christ on earth should have a fixed duration—according to the most prevalent opinion, a duration of one thousand years. From this fact the whole ancient Christian eschatology was known in later times as "chiliasm"—a name which is not strictly accurate, since the doctrine of the millennium was only one feature in its scheme of the future.

1. This idea that the Messianic kingdom of the future on earth should have a definite duration has—like the whole eschatology of the primitive Church—its roots in the Jewish apocalyptic literature, where it appears at a comparatively late period. At first it was assumed that the Messianic kingdom in Palestine would last for ever (so the prophets; cf. Jer. xxiv. 6; Ezek. xxxvii. 25; Joel iv. 20; Dan. vi. 17); Sibly, iii. 49 seq., 766; Psalt. Salom. xvii. 4; Enoch lxii. 24), and this seems always to have been the most widely accepted view (John xii. 34). But from a comparison of prophetic passages of the Old Testament learned apocalyptic writers came to the conclusion that a distinction must be drawn between the earthly appearance of the Messiah and the appearance of God Himself amongst His people and in the Gentile world for the final judgment. As a necessary consequence, a limited period had to be assigned to the Messianic kingdom. According to the Apocalypse of Baruch (xl. 3) this kingdom will last, "donec finiatur mundus corruptionis." In the Book of Enoch (xc. 12) "a week" is specified, in the Apocalypse of Ezra (vii. 28 seq.) four hundred years. This figure, corresponding to the four hundred years of Egyptian bondage, occurs also in the Talmud (*Sanhedrin* 99a). But this is the only passage; the Talmud has no fixed doctrine on the point. The view most frequently expressed there (see Von Otto in *Hilgenfeld's Zeitschrift*, 1877, p. 527 seq.) is that the Messianic kingdom will last for one thousand (some said two thousand) years. "In six days God created the world, on the seventh He rested. But a day of God is equal to a thousand years (Ps. xc. 4). Hence the world will last for six thousand years of toil and labour; then will come one thousand years of Sabbath rest for the people of God in the kingdom of the Messiah." This idea must have already been very common in the first century before Christ. The combination of Gen. i., Dan. ix. and Ps. xc. 4 was peculiarly fascinating.

Nowhere in the discourses of Jesus is there a hint of a limited duration of the Messianic kingdom. The apostolic epistles are equally free from any trace of chiliasm (neither 1 Cor. xv. 23 seq. nor 1 Thess. iv. 16 seq. points in this direction). In Revelation however, it occurs in the following shape (ch. xx.). After

Christ has appeared from heaven in the guise of a warrior, and vanquished the antichristian world-power, the wisdom of the world and the devil, those who have remained steadfast in the time of the last catastrophe, and have given up their lives for their faith, shall be raised up, and shall reign with Christ on this earth as a royal priesthood for one thousand years. At the end of this time Satan is to be let loose again for a short season; he will prepare a new onslaught, but God will miraculously destroy him and his hosts. Then will follow the general resurrection of the dead, the last judgment, and the creation of new heavens and a new earth. That all believers will have a share in the first resurrection and in the Messianic kingdom is an idea of which the author of Revelation knows nothing. The earthly kingdom of Christ is reserved for those who have endured the most terrible tribulation, who have withstood the supreme effort of the world-power—that is, for those who are actually members of the church of the last days. The Jewish expectation is thus considerably curtailed, as it is also shorn of its sensual attractions. "Blessed and holy is he that hath part in the first resurrection; on such the second death hath no power; but they shall be priests of God and of Christ, and shall reign with Him a thousand years." Other ancient Christian authors were not so cautious. Accepting the Jewish apocalypses as sacred books of venerable antiquity, they read them eagerly, and transferred their contents bodily to Christianity. Nay more, the Gentile Christians took possession of them, and just in proportion as they were neglected by the Jews—who, after the war of Bar-Cochba, became indifferent to the Messianic hope and hardened themselves once more in devotion to the law—they were naturalized in the Christian communities. The result was that these books became "Christian" documents; it is entirely to Christian, not to Jewish, tradition that we owe their preservation. The Jewish expectations are adopted for example, by Papias, by the writer of the epistle of Barnabas, and by Justin. Papias actually confounds expressions of Jesus with verses from the Apocalypse of Baruch, referring to the amazing fertility of the days of the Messianic kingdom (Papias in Iren. v. 33). Barnabas (*Ep.* 15) gives us the Jewish theory (from Gen. i. and Ps. xc. 4) that the present condition of the world is to last six thousand years from the creation, that at the beginning of the Sabbath (the seventh millennium) the Son of God appears, to put an end to the time of "the unjust one," to judge the ungodly and renew the earth. But he does not indulge, like Papias, in sensuous descriptions of this seventh millennium; to Barnabas it is a time of rest, of sinlessness, and of a holy peace. It is not the end, however; it is followed by an eighth day of eternal duration—"the beginning of another world." So that in the view of Barnabas the Messianic reign still belongs to *οὐτος ὁ αἰών*. Justin (*Dial.* 80) speaks of chiliasm as a necessary part of complete orthodoxy, although he knows Christians who do not accept it. He believes, with the Jews, in a restoration and extension of the city of Jerusalem; he assumes that this city will be the seat of the Messianic kingdom, and he takes it as a matter of course that there all believers (here he is at one with Barnabas) along with patriarchs and prophets will enjoy perfect felicity for one thousand years. That a philosopher like Justin, with a bias towards an Hellenic construction of the Christian religion, should nevertheless have accepted its chiliasm elements is the strongest proof that these enthusiastic expectations were inseparably bound up with the Christian faith down to the middle of the 2nd century. And another proof is found in the fact that even a speculative Jewish Christian like Cerinthus not only did not renounce the chiliasmic hope, but pictured the future kingdom of Christ as a kingdom of sensual pleasures, of eating and drinking and marriage festivities (Euseb. *H. E.* iii. 28, vii. 25).

After the middle of the 2nd century these expectations were gradually thrust into the background. They would never have died out, however, had not circumstances altered, and a new mental attitude been taken up. The spirit of philosophical and theological speculation and of ethical reflection, which began to spread through the churches, did not know what to make of the old hopes of the future. To a new generation they seemed paltry,

earthly and fantastic, and far-seeing men had good reason to regard them as a source of political danger. But more than this, these wild dreams about the glorious kingdom of Christ began to disturb the organization which the churches had seen fit to introduce. In the interests of self-preservation against the world, the state and the heretics, the Christian communities had formed themselves into compact societies with a definite creed and constitution, and they felt that their existence was threatened by the white heat of religious subjectivity. So early as the year 170, a church party in Asia Minor—the so-called Alogi—rejected the whole body of apocalyptic writings and denounced the book of Revelation as a book of fables. All the more powerful was the reaction. In the so-called Montanistic controversy (c. 160-220) one of the principal issues involved was the continuance of the chiliasmic expectations in the churches. The Montanists of Asia Minor defended them in their integrity, with one slight modification: they announced that Jerusalem, the city of Montanus, would be the site of the New Jerusalem and the millennial kingdom. After the Montanistic controversy chiliasmic views were more and more discredited in the Greek Church; they were, in fact, stigmatized as "Jewish" and consequently "heretical." It was the Alexandrian theology that superseded them; that is to say, Neo-Platonic mysticism triumphed over the early Christian hope of the future, first among the "cultured," and then, when the theology of the "cultured" had taken the faith of the "uncultured" under its protection, amongst the latter also. About the year 260 an Egyptian bishop, Nepos, in a treatise called *Ἐλεγχος ἑλληνογενεῶν*, endeavoured to overthrow the Origenistic theology and vindicate chiliasm by exegetical methods. Several congregations took his part; but ultimately Dionysius, bishop of Alexandria, succeeded in healing the schism and asserting the allegorical interpretation of the prophets as the only legitimate exegesis. During this controversy Dionysius became convinced that the victory of mystical theology over "Jewish" chiliasm would never be secure so long as the book of Revelation passed for an apostolic writing and kept its place among the homologies of the canon. He accordingly raised the question of its apostolic origin; and by reviving old difficulties, with ingenious arguments of his own, he carried his point. At the time of Eusebius the Greek Church was saturated with prejudice against the book and with doubts as to its canonicity. In the course of the 4th century it was removed from the Greek canon, and thus the troublesome foundation on which chiliasm might have continued to build was got rid of. The attempts of Methodius of Tyre at the beginning of the 4th century and Apollinarius of Laodicea about 360 to defend chiliasm and assail the theology of Origen had no result. For many centuries the Greek Church kept Revelation out of its canon, and consequently chiliasm remained in its grave. It was considered a sufficient safeguard against the spiritualizing eschatology of Origen and his school to have rescued the main doctrines of the creed and the *regula fidei* (the visible advent of Christ; eternal misery and hell-fire for the wicked). Anything beyond this was held to be Jewish. It was only the chronologists and historians of the church who, following Julius Africanus, made use of apocalyptic numbers in their calculations, while court theologians like Eusebius entertained the imperial table with discussions as to whether the dining-hall of the emperor—the second David and Solomon, the beloved of God—might not be the New Jerusalem of John's Apocalypse. Eusebius was not the first who dabbled in such speculations. Dionysius of Alexandria had already referred a Messianic prediction of the Old Testament to the emperor Gallienus. But mysticism and political servility between them gave the death-blow to chiliasm in the Greek Church. It never again obtained a footing there; for, although, late in the middle ages, the book of Revelation—by what means we cannot tell—did recover its authority, the Church was by that time so hopelessly trammelled by a magical cultus as to be incapable of fresh developments. In the Semitic churches of the East (the Syrian, Arabian and Ethiopian), and in that of Armenia, the apocalyptic literature was preserved much longer than in the Greek Church. They were very conservative of ancient traditions in general, and hence

chiliasm survived amongst them to a later date than in Alexandria or Constantinople.

But the Western Church was also more conservative than the Greek. Her theologians had, to begin with, little turn for mystical speculation; their tendency was rather to reduce the gospel to a system of morals. Now for the moralists chiliasm had a special significance as the one distinguishing feature of the gospel, and the only thing that gave a specifically Christian character to their system. This, however, holds good of the Western theologians only after the middle of the 3rd century. The earlier fathers, Irenaeus, Hippolytus, Tertullian, believed in chiliasm simply because it was a part of the tradition of the church and because Marcion and the Gnostics would have nothing to do with it. Irenaeus (v. 28, 29) has the same conception of the millennial kingdom as Barnabas and Papias, and appeals in support of it to the testimony of disciples of the apostles. Hippolytus, although an opponent of Montanism, was nevertheless a thorough-going millenarian (see his book *De Antichristo*). Tertullian (cf. especially *Adv. Marcion.*, 3) aimed at a more spiritual conception of the millennial blessings than Papias had, but he still adhered, especially in his Montanistic period, to all the ancient anticipations. It is the same all through the 3rd and 4th centuries with those Latin theologians who escaped the influence of Greek speculation. Commodian, Victorinus Petta-
vensis, Lactantius and Sulpicius Severus were all pronounced millenarians, holding by the very details of the primitive Christian expectations. They still believe, as John did, in the return of Nero as the Antichrist; they still expect that after the first resurrection Christ will reign with his saints "in the flesh" for a thousand years. Once, but only once (in the Gospel of Nicodemus), the time is reduced to five hundred years. Victorinus wrote a commentary on the Apocalypse of John; and all these theologians, especially Lactantius, were diligent students of the ancient Sibylline oracles of Jewish and Christian origin, and treated them as divine revelations. As to the canonicity and apostolic authorship of the Johannine Apocalypse no doubts were ever entertained in the West; indeed an Apocalypse of Peter was still retained in the canon in the 3rd century. That of Ezra, in its Latin translation, must have been all but a canonical book—the numbers of extant manuscripts of the so-called 4 Ezra being incredibly great, while several of them are found in copies of the Latin Bible at the beginning of the 16th century. The Apocalypse of Hermas was much read till far through the middle ages, and has also kept its place in some Bibles. The apocalyptic "Testamenta duodecim patriarcharum" was a favourite reading-book; and Latin versions of ancient apocalypses are being continually brought to light from Western libraries (e.g. the *Assumptio Moisi*, the *Ascensio Jesajae*, &c.). All these facts show how vigorously the early hopes of the future maintained themselves in the West. In the hands of moralistic theologians, like Lactantius, they certainly assume a somewhat grotesque form, but the fact that these men clung to them is the clearest evidence that in the West millenarianism was still a point of "orthodoxy" in the 4th century.

This state of matters, however, gradually disappeared after the end of the 4th century. The change was brought about by two causes—first, Greek theology, which reached the West chiefly through Jerome Rufinus and Ambrose, and second, the new idea of the church wrought out by Augustine on the basis of the altered political situation of the church. Augustine was the first who ventured to teach that the catholic church, in its empirical form, was the kingdom of Christ, that the millennial kingdom had commenced with the appearing of Christ, and was therefore an accomplished fact. By this doctrine of Augustine's, the old millenarianism, though not completely extirpated, was at least banished from the official theology. It still lived on, however, in the lower strata of Christian society; and in certain undercurrents of tradition it was transmitted from century to century. At various periods in the history of the middle ages we encounter sudden outbreaks of millenarianism, sometimes as the tenet of a small sect, sometimes as a far-reaching movement. And, since it had been suppressed, not, as in the East, by

mystical speculation, its mightiest antagonist, but by the political church of the hierarchy, we find that wherever chiliasm appears in the middle ages it makes common cause with all enemies of the secularized church. It strengthened the hands of church democracy; it formed an alliance with the pure souls who held up to the church the ideal of apostolic poverty; it united itself for a time even with mysticism in a common opposition to the supremacy of the church; nay, it lent the strength of its convictions to the support of states and princes in their efforts to break the political power of the church. It is sufficient to recall the well-known names of Joachim of Floris, of all the numerous Franciscan spiritualists, of the leading sectaries from the 13th to the 15th century who assailed the papacy and the secularism of the church—above all, the name of Occam. In these men the millenarianism of the ancient church came to life again; and in the revolutionary movements of the 15th and 16th centuries—especially in the Anabaptist movements—it appears with all its old uncompromising energy. If the church, and not the state, was regarded as Babylon, and the pope declared to be the Antichrist, these were legitimate inferences from the ancient traditions and the actual position of the church. But, of course, the new chiliasm was not in every respect identical with the old. It could not hold its ground without admitting certain innovations. The "everlasting gospel" of Joachim of Floris was a different thing from the announcement of Christ's glorious return in the clouds of heaven; the "age of the spirit" which mystics and spiritualists expected contained traits which must be characterized as "modern"; and the "kingdom" of the Anabaptists in Münster was a Satanic caricature of that kingdom in which the Christians of the 2nd century looked for a peaceful Sabbath rest. Only we must not form our ideas of the great apocalyptic and chiliasmic movement of the first decades of the 16th century from the rabble in Münster. There were pure evangelical forces at work in it; and many Anabaptists need not shun comparison with the Christians of the apostolic and post-apostolic ages.

The German and Swiss Reformers also believed that the end of the world was near, but they had different aims in view from those of the Anabaptists. It was not from poverty and apocalypticism that they hoped for a reformation of the Church. In contrast to the fanatics, after a brief hesitation they threw millenarianism overboard, and along with it all other "opiniones Judaicae." They took up the same ground in this respect which the Roman Catholic Church had occupied since the time of Augustine. How millenarianism nevertheless found its way, with the help of apocalyptic mysticism and Anabaptist influences into the churches of the Reformation, chiefly among the Reformed sects, but afterwards also in the Lutheran Church, how it became incorporated with Pietism, how in more recent times an exceedingly mild type of "academic" chiliasm has been developed from a belief in the verbal inspiration of the Bible, how finally new sects are still springing up here and there with apocalyptic and chiliasmic expectations—these are matters which cannot be fully entered upon here.

See Schröter, *Lehrbuch der neuestenamenlichen Zeitsgeschichte* (1874), §§ 28, 29; Corrodi, *Kritische Geschichte des Chiliasmus* (1781); R. H. Charles, *The Doctrine of a Future Life* (1899); *Book of the Secrets of Enoch* (1896), pp. xxvii–xxx, ch. xxxii. 2–xxxiii. 2; *Apocalypse of Baruch* (1896), xxix. 3–8 (notes); *Book of Enoch* (index, s.v. "Messianic Kingdom"); Bousset, *Religion des Judentums* (1903), 273–276; C. A. Briggs, *The Messiah of the Apostles*, p. 284 seq.; Sabatier, *Les Origines littéraires et la composition de l'Apocalypse de St Jean* (1887); Spitta, *Die Offenbarung des Johannes untersucht* (1889). See also ESCHATOLOGY and works there quoted.

(A. HA.)

MILLER, HUGH (1802–1856), Scottish geologist and man of letters, was born in humble circumstances at Cromarty, on the 10th of October 1802; his father, Hugh Miller, a seaman, was drowned when he was but five years old. His primary education was acquired at a dame's school and afterwards at the parish school, and at the age of six he had learned that "the art of reading is the art of finding stories in books." At the age of twelve he began to write verses. Two of his mother's brothers, James and "Sandy" Wright, hard-working men at Cromarty,

offered to assist him to enter the ministry, but he felt no call to the sacred office, and from 1820 to 1822 he was apprenticed to a stone-mason. During the next few years he obtained employment as a journeyman mason in Edinburgh, Inverness and various other parts of Scotland. The writing of verses occupied his leisure hours, and in 1826 he sent to the *Scotsman* an "Ode on Greece" which was refused. It was not until 1829 that he met with his first success in the publication of *Poems written in the Leisure Hours of a Journeyman Mason*. These were printed and issued from the office of the *Inverness Courier*. Miller now turned his attention to prose and contributed many essays to the *Inverness Courier*. As remarked by Sir A. Geikie, "These made so favourable an impression that they were soon afterwards reprinted separately. They marked the advent of a writer gifted with no ordinary powers of narration and with the command of a pure, nervous and masculine style."

At the age of thirty-two he was still a stone-mason, but in the latter part of 1834 he was offered a post as accountant in the Commercial Bank of Scotland, and was almost immediately transferred to the Cromarty branch. His prose writings had now attracted much notice, and he next issued in 1835 *Scenes and Legends of the North of Scotland, or the traditional history of Cromarty*, in which he introduced some memoranda on the geology. This work met with a cordial reception. Miller, while still a stone-mason, had observed the abundant fossils in the Jurassic shales on the shores of Ethie, but it was not until 1830 that he first obtained remains of fossil fishes in the Old Red Sandstone. These for many years he collected and studied as far as he could, and in 1837 some of his specimens were brought to the notice of R. I. Murchison and Professor Agassiz. In the following year he was in communication with Murchison and his career as a geologist was definitely opened.

In 1837 Miller married Lydia Falconer Frazer (1817-1876), a lady of good position and great natural ability, whom he had met six years previously. He set up his household in Cromarty, on a salary of sixty pounds a year, aided by the small sums then earned by literary work; and his wife took a few pupils. Mrs Miller eventually became well known under the pseudonym of Mrs Harriet Myrtle as author of the *Ocean Child* (1857) and other story-books for children.

Soon after his marriage, Miller became greatly stirred by the internal dissensions in the Church of Scotland, of which he was a staunch member, and he published two pamphlets which brought him to the notice of some of the prominent members of the liberal church party. In 1839 he went by invitation to Edinburgh to edit a new Whig newspaper, the *Witness*, which was intended to support the views of those who after the disruption in 1843 formed the Free Church. The paper rapidly attained a large circulation; and this was no doubt largely due to his own literary and scientific essays. In 1840 he contributed a series of articles on *The Old Red Sandstone*, and these were reprinted in book form in the following year. The charm of this work was widely appreciated, as was also the natural sagacity shown in the descriptions and restorations of some of the fossil fishes. His *Footprints of the Creator* was published in 1849, and *My Schools and Schoolmasters* in 1854. He was engaged on the final proofs of his *Testimony of the Rocks* on the day of his death. During the last year of his life he suffered from inflammation of the lungs; and the strain of ill-health proving too severe, he died by his own hand in Edinburgh on the 23rd of December 1856. By request of his wife, *The Cruise of the Betsy, with Rambles of a Geologist* (1858) previously printed only in the *Witness* newspaper was published under the editorship of the Rev. W. S. Symonds.

In memory of Hugh Miller a monument was erected by public subscription in 1860 at Cromarty; and the cottage in which he was born was acquired at a later period by his son Hugh. In it have been placed part of his library, a set of the *Witness* newspaper, some letters addressed to him, and a number of geological specimens, including many referred to in his *Old Red Sandstone*. On the 22nd of August 1902 the centenary of his birth was celebrated at Cromarty, and was attended by scientific representatives from all parts of the world.

His elder son, Hugh Miller (1850-1896), passed through the Royal School of Mines and joined the Geological Survey in England in 1873; afterwards he was transferred to Scotland and surveyed the country around Cromarty and other parts of Ross-shire and Sutherlandshire. He was author of *Landscape Geology*, 1891.

See *The Life and Letters of Hugh Miller*, by Peter Bayne (2 vols., 1871); *Hugh Miller; his work and influence*, address by Sir A. Geikie, at the centenary celebration. (H. B. Wo.)

MILLER, JOAQUIN (CINCINNATUS HEINE) (1841-), American poet, was born in Indiana, on the 10th of November 1841, and was educated for the law. After some experiences of mining and journalism in Idaho and Oregon, he settled down in 1866 as judge in Grant county, Oregon, and during his four years' tenure of this post he began to write verse. In 1870 he travelled in Europe, and in 1871 he published his first volume of poetry, full of tropical passion, *Songs of the Sierras*, on which his reputation mainly rests. His *Songs of the Sunlands* (1873) followed in the same vein, and after other volumes had appeared, his *Collected Poems* were published in 1882. He also wrote plays, *The Danites in the Sierras* having some success as a sensational melodrama. On his return from Europe he became a journalist in Washington, but in 1887 returned to California. His pen-name, "Joaquin Miller," by which he is known, was assumed by him when he published his first book, in consequence of his having written an article in defence of Joaquin Murietta, the Mexican brigand.

Revised editions of his *Complete Poetical Works* appeared at San Francisco in 1902.

MILLER, JOE (JOSEPH or JOSIAS) (1684-1738), English actor, first appears in the cast of Sir Robert Howard's *Committee* at Drury Lane in 1709 as Teague. Trinculo in *The Tempest*, the First Grave-digger in *Hamlet* and Marplot in *The Busybody*, were among his many favourite parts. He is said to have been a friend of Hogarth. He died on the 16th of August 1738. After his death, John Mottley (1692-1750) brought out a book called *Joe Miller's Jest, or Wit's Vade Mecum* (1739), a collection of contemporary and ancient coarse witticisms, only three of which are told of Miller. Owing to the quality of the jokes in Mottley's book, their number increasing with each of the many subsequent editions, any time-worn jest has, somewhat unjustly, come to be called "a Joe Miller."

MILLER, SAMUEL FREEMAN (1816-1890), American jurist, was born in Richmond, Kentucky, on the 5th of April 1816, of Pennsylvania-German stock. He was brought up on a farm, was a clerk in a drug-store, graduated from the medical department of Transylvania University in 1838, and practised medicine in Barbourville, Kentucky, until 1847. In that year he was admitted to the bar, and entered politics as a Whig. His anti-slavery sympathies induced him to settle in Iowa, where in 1850 he freed his slaves and began to practise law in Keokuk, and he soon became a leader of the Republican party in the state. In 1862 he succeeded Justice Peter V. Daniel (1784-1860), as a justice of the U.S. Supreme Court, and served until his death in Washington, D.C., on the 13th of October 1890, when he was senior justice. Miller was a man of great mental force and individuality, and his judgments carried great weight. In 1877 he was a member of the electoral commission, which adopted his motion that Congress could not "go behind the returns" as properly accredited by state officials. He was a prominent member of the Unitarian Church and for three years was president of its national conference. He published a volume of *Lectures on the Constitution of the United States* (New York, 1891).

See Wm. A. Maury, in *The Juridical Review of Edinburgh* (for January 1891), and Chas. M. Gregory, in *Yale Law Journal* (for April 1908).

MILLER, WILLIAM (1782-1849), leader of the Second Adventists in America, was born on the 5th of February 1782 at Pittsfield, Massachusetts. He was a recruiting officer at the beginning of the War of 1812, and after Plattsburg he was promoted captain, retiring from the army in 1815. About 1816 he settled in Low Hampton, Washington county, New York.

He now joined the Baptist Church at Low Hampton, and, after two years of minute study of the Bible, about 1818 became a Second Adventist. In 1831 he began to lecture, arguing that the "two thousand three hundred days" of Daniel viii. 14 meant 2300 years, and that these years began with Ezra's going up to Jerusalem in 457 B.C., and therefore came to an end in 1833, and urging his hearers to make ready for the final coming of Christ in that year. To his many followers, after the year 1843 had passed, he proclaimed that 1844 was the year, that his error was due to following Hebrew instead of Roman chronology, and that the 22nd of October was to be the day. There was renewed excitement among Miller's followers; many of them left their business, and in white muslin robes, on horse tops and hills, awaited the epiphany. In spite of disappointment, many still believed with him that the time was near. He returned to Low Hampton and died there on the 20th of December 1840. The Adventists or Millerites, who were formed into a single body in a convention called by him in April 1845, have since separated into several sects: the Evangelical Adventists (1147 in the United States in 1908), who believe in everlasting punishment; the Seventh Day Adventists (64,332), who observe the seventh day, and practise the sacrament of foot-washing; the Advent Christians (26,500), the Churches of God in Jesus Christ (2872), and the Life and Advent Union (3800). Their total number in the United States in 1908 was about 99,300. Miller published in 1833 a pamphlet which was the basis of his lectures; these were published in 1842 as *Evidence from Scripture and History of the Second Coming of Christ about the Year 1843*.

See Sylvester Bliss, *Memoirs of William Miller* (Boston, 1853); James White, *Sketches of the Christian Life and Public Labors of William Miller* (Battle Creek, 1875); and Edward Eggleston's novel, *End of the World* (1872).

MILLER, WILLIAM (1795-1861), British soldier, who took a prominent part in the South American Wars of Liberation, entered the British artillery service in 1811, and till 1814 he was continuously on active service with Wellington's army in the Peninsula. In the latter year he accompanied the ill-fated New Orleans expedition. After the general peace he travelled for two years about Europe, and then went to South America. The war which culminated in the expulsion of the Spaniards was just breaking out, and he took command in the Chilean artillery, with which he served during the Chilean part of the war. As a major he commanded the marines on Cochrane's vessel, the "O'Higgins." In 1821 he landed in Peru, to assist General San Martín against the Spanish General Canterac. He was made general of brigade, and became very intimate with Simón Bolívar. He rendered the most conspicuous services at Junín (Aug. 6, 1824), and his regiment, the "Hussars of Junín," covered itself with glory in the decisive victory of Ayacucho (Dec. 9, 1824). From 1830 to 1839 he filled various high military and political offices in Peru. In the latter year he was involved in the fall of Santa Cruz, and went into exile. For some years he filled the post of British Consul-General of the Pacific Coast. He died on board H.M.S. "Naïad" at Callao, on the 31st of October 1861.

See the *Memoirs* published by his brother John Miller (London, 1827).

MILLER, WILLIAM (1796-1882), Scottish line-engraver, was born in Edinburgh on the 28th of May 1796. After studying in London under George Cook, a pupil of Basire's, he returned to Edinburgh. He executed plates after Thomson of Duddingston, Macculloch, D. O. Hill, Sir George Harvey, and other Scottish landscapists, but his chief works were his transcripts from Turner. The first of these was the *Clovelly* (1824), of *The Southern Coast*, a publication undertaken by George Cook and his brother William B. Cook, to which Miller also contributed the *Combe Martin* and the *Portsmouth*. He was engaged on the illustrations of *England and Wales*, 1827-1838; of *The Rivers of France*, 1833-1835; of *Roger's Poems*, 1834; and very largely on those of *The Prose and Poetical Works of Sir Walter Scott*, 1834. In *The Provincial Antiquities and Picturesque Scenery of Scotland*, 1826, he executed a few excellent plates after Thomson and Turner. Among his larger engravings of Turner's works may be mentioned "The Grand Canal, Venice"; "The Rhine. Oesterey and

Feltzen"; "The Bell Rock"; "The Tower of London"; and "The Shepherd." The art of William Miller was warmly appreciated by Turner himself, and Ruskin pronounced him to be on the whole the most successful translator into line of the paintings of the greatest English landscapist. His renderings of complex Turnerian sky-effects are especially delicate and masterly. Towards the end of his life Miller abandoned engraving and occupied his leisure in the production of water-colours, many of which were exhibited in the Royal Scottish Academy, of which he was an honorary member. He resumed his burin, however, to produce two final series of vignettes from drawings by Birket Foster illustrative of Hood's *Poems*, published by Moxon in 1871. Miller, who was a Quaker, died on the 20th of January 1882.

MILLER, WILLIAM HALLOWES (1801-1880), British mineralogist and crystallographer, was born at Velindre near Llandovery, Carmarthenshire, on the 6th of April 1801. He was educated at St John's College, Cambridge, where he graduated in 1826 as fifth wrangler, and became a fellow in 1829. For a few years he was occupied as a college tutor and during this time he published treatises on hydrostatics and hydrodynamics. He also gave special attention to crystallography, and on the resignation of W. Whewell he succeeded in 1832 to the professorship of mineralogy, a post which he occupied until 1870. His chief work, on *Crystallography*, was published in 1838. He was elected F.R.S. in 1838. In 1852 he edited a new edition of H. J. Brooke's *Elementary Introduction to Mineralogy*. He assisted in 1843 the committee appointed to superintend the construction of the new Parliamentary standards of length and weight (see *Phil. Trans.*, 1856). He died in Cambridge on the 20th of May 1880.

MILLERAND, ALEXANDRE (1859-), French socialist and politician, was born in Paris on the 10th of February 1859. He was educated for the bar, and made his reputation by his defence, in company with Georges Laguerre, of Ernest Reche and Duc-Quercy, the instigators of the strike at Decazeville in 1883; he then took Laguerre's place on M. Clemenceau's paper, *La Justice*. He was elected to the Chamber of Deputies for the department of the Seine in 1885 as a radical socialist. He was associated with MM. Clemenceau and Camille Pelletan as an arbitrator in the Carmaux strike (1892). He had long had the ear of the Chamber in matters of social legislation, and after the Panama scandals had discredited so many politicians his influence grew. He was chief of the Socialist left, which then numbered sixty members, and edited until 1896 their organ in the press, *La Petite République*. His programme included the collective ownership of the means of production and the international association of labour, but when in June 1899 he entered Waldeck-Rousseau's cabinet of "republican defence" as minister of commerce he limited himself to practical reforms, devoting his attention to the improvement of the mercantile marine, to the development of trade, of technical education, of the postal system, and to the amelioration of the conditions of labour. Labour questions were entrusted to a separate department, the *Direction du Travail*, and the pension and insurance office was also raised to the status of a "direction." The introduction of trades-union representatives on the Supreme Labour Council, the organization of local labour councils, and the instructions to factory inspectors to put themselves in communication with the councils of the trades-unions, were valuable concessions to labour, and he further secured the rigorous application of earlier laws devised for the protection of the working-classes. His name was especially associated with a project for the establishment of old age pensions, which became law in 1905. He became in 1898 editor of *La Lanterne*. His influence with the extreme Socialists had already declined, for it was said that his departure from the true Marxist tradition had disintegrated the party.

For his administration in the Waldeck-Rousseau cabinet see A. Lavy, *L'Œuvre de Millerand* (1902); his speeches between 1899 and 1907 were published in 1907 as *Travail et travailleurs*.

MILLERITE, a mineral consisting of nickel sulphide, NiS. Crystals belong to the rhombohedral system and have the form

of slender needles arranged in divergent groups or of delicate fibres loosely matted together. The colour is brass-yellow and the lustre metallic. Before the chemical composition of the mineral had been determined it had been known as "capillary pyrites" or "hair pyrites" (Ger., *Haarkies*), and was not distinguished from the capillary forms of pyrites and marcasite: the name millerite was given by W. Haidinger in 1845, in honour of W. H. Miller. The hardness is 3-3½ and the specific gravity 5.65. There are perfect cleavages parallel to the faces of the rhombohedron (100); and gliding planes parallel to the faces of the rhombohedron (110), on which secondary twinning may be readily produced artificially by pressure.

Typical specimens of millerite are found in the coal measures in the neighbourhood of Merthyr Tydvil in South Wales, where the delicate needles and fibres occur with crystals of quartz and pearl-spar in the fissures of septarian nodules of clay-ironstone. Radiating groups of needles are found with ankerite in cavities in haematite in the Sterling mine at Antwerp in Jefferson county, New York. At the Gap mine in Lancaster county, Pennsylvania, the mineral occurs as fibrous encrusting masses with a velvety lustre. The most perfect crystals are those formerly found with calcite, diopside and a bright green chrome-garnet in a nickel mine at Orford in Sherbrooke county, Quebec. (L. J. S.)

MILLER'S THUMB (*Cottus gobio*), a small fish, abundant in all rivers and lakes of northern and central Europe with clear water and gravelly bottom. The genus *Cottus*, to which the miller's thumb belongs, is easily recognized by its broad, flat head, rounded and scaleless body, large pectoral and narrow ventral fins, with two dorsal fins, the anterior shorter than the posterior; the praeperculum is armed with a simple or branched spine. The species of the genus *Cottus* are rather numerous, and are confined to the north temperate zone of the globe, the majority being marine, and known by the name of "bullheads." The miller's thumb is confined to fresh water; and only one other freshwater species is found in Europe, *C. poeciliopus*, from rivers of Hungary, Galicia, and the Pyrenees; some others occur in the fresh waters of northern Asia and North America. The miller's thumb is common in all suitable localities in Great Britain, but is extremely rare in Ireland; in the Alps it reaches to an altitude exceeding 7000 ft. Its usual length is from 3 to 5 in. Generally hidden under a stone or in a hollow of the bank, it watches for its prey, which consists of small aquatic animals, and darts when disturbed with extraordinary rapidity to some other place of refuge. The female deposits her ova in a cavity under a stone, whilst the male watches and defends them until the young are hatched and able to shift for themselves.

MILLET, FRANCIS DAVIS (1846-), American artist, was born at Mattapoisett, Massachusetts, on the 3rd of November 1846. He was a drummer boy with the Union forces in the Civil War; graduated from Harvard College in 1869; and in 1871 entered the Royal Academy of Fine Arts, Antwerp, where he studied under Van Lerius and De Keyser. In 1873 he was made secretary of the Massachusetts commission to the Vienna Exposition. During the Russo-Turkish War of 1877-78 he was correspondent of the *London Daily News* and *Graphic*, and of the *New York Herald*. On his return he was made a member from the United States of the International Art Jury at the Paris Exposition of 1878. He was director of decorations at the Columbian Exposition, Chicago, 1893, and in 1898 he went to Manila as war correspondent for *The Times* and for *Harper's Weekly*. In 1880 he became a member of the Society of American Artists, and in 1885 was elected to full membership in the National Academy of Design, New York, and was for one term its vice-president; he became a member also of the American Water Color Society and of the Institute of Painters in Oil Colours, London. As a decorative artist his work may be seen at Trinity Church, Boston; the Bank of Pittsburg; and the Capitol at St Paul, Minnesota. His pictures are in many public collections: among them are "A Cosy Corner," in the Metropolitan Museum of Art, New York; "At the Inn," in the

Union League Club, New York; and "Between two Fires," in the Tate Gallery, London. He also wrote essays and short stories, and an English version of Tolstol's *Sebastopol* (1887); and among his publications are *The Danube* (1891), *Capillary Crime and other Stories* (1892), and *Expedition to the Philippines* (1899).

MILLET (or MILÉ), **JEAN FRANÇOIS** (c. 1642-1679), commonly called FRANCISQUE, was born at Antwerp about 1642, and is generally classed amongst the painters of Flanders on account of the accident of his birth. But his father was a Frenchman, a turner in ivory of Dijon, who took service with the prince of Condé and probably returned after a time to his native country. He remained long enough in Antwerp to apprentice his son to an obscure member of a painter family called Laurent, pupil of Gabriel Franck. With Laurent, Francisque left Antwerp for Paris, and there settled in 1666 after marrying his master's daughter. He was received a member of the Academy of Painting at Paris in 1673, and after gaining consideration as an imitator of the Poussins he died in 1679, bequeathing his art and some of his talents to one of his sons. Francisque probably knew, as well as imitated, Nicolas Poussin, Gaspar Dughet and Sebastian Bourdon; and it is doubtless because of his acquaintance with these travelled artists that, being himself without familiarity with the classic lands of Italy and Greece, he was able to imagine and reproduce Italian and Arcadian scenery with considerable grace and effectiveness. It is indeed surprising to observe, even at this day how skillfully he executed these imaginary subjects, enlivened them with appropriate figures, and shed over them the glow of a warm yet fresh and sparkling tone. Twelve of his most important landscapes, which remained in the palace of the Tuileries, were destroyed by fire; and though many of his pieces may still be found catalogued in Continental and English collections, others in great number remain unknown and unacknowledged.

His son **JEAN FRANÇOIS MILLET**, the younger (1666-1723), also called Francisque, was born in Paris, and was made a member of the Academy of Painting in 1709. He is not quite so independent in his art as his father; but he had clever friends, and when he wanted figures to his landscapes, he consulted Watteau, and other followers of the "court shepherdess" school. In the museum of Grenoble is a "Paysage" by him which is prettily adorned with Watteau's figures.

MILLET, JEAN FRANÇOIS (1814-1875), French painter, who came of a peasant family, was born on the 4th of October 1814 in the hamlet of Gruchy, near Gréville (La Manche), in the wild and picturesque district called La Hague. His boyhood was passed working in his father's fields, but the sight of the engravings in an old illustrated Bible set him drawing, and thenceforth, whilst the others slept, the daily hour of rest was spent by Millet in trying to render the familiar scenes around him. From the village priest the lad learnt to read the Bible and Virgil in Latin, and acquired an interest in one or two other works of a high class which accompanied him through life; he did not, however, attract attention so much by his acquirements as by the stamp of his mind. The whole family seems, indeed, to have worn a character of austerity and dignity, and when Millet's father finally decided to test the vocation of his son as an artist, it was with a gravity and authority which recalls the patriarchal households of Calvinist France. Two drawings were prepared and placed before a painter at Cherbourg named Mouchel, who at once recognized the boy's gifts, and accepted him as a pupil; but shortly after (1835) Millet's father died, and the eldest son, with heroic devotion, took his place at home, nor did he return to his work until the pressing calls from without were solemnly enforced by the wishes of his own family. He accordingly went back to Cherbourg, but after a short time spent there with another master (Langlois) started with many misgivings for Paris. The council-general of the department had granted him a sum of 600 francs, and the town council promised an annual pension of 400, but in spite of friendly help and introductions Millet went through great difficulties. The system of the *École des Beaux Arts*

was hateful to him, and it was not until after much hesitation that he decided to enter an official studio—that of Delaroche. The master was certainly puzzled by his pupil; he saw his ability, and, when Millet in his poverty could no longer pay the monthly fees, arranged for his free admission to the studio, but he tried in vain to make him take the approved direction, and lessons ended with "Eh, bien, allez à votre guise, vous êtes si nouveau pour moi que je ne veux rien vous dire." At last, when the competition for the Grand Prix came on, Delaroche gave Millet to understand that he intended to secure the nomination of another, and thereupon Millet withdrew himself, and with his friend Marolle started in a little studio in the Rue de l'Est. He had renounced the beaten track, but he continued to study hard whilst he sought to procure bread by painting portraits at 10 or 15 francs apiece and producing small "pastiches" of Watteau and Boucher. In 1840 Millet went back to Gréville, where he painted "Sailors Mending a Sail" and a few other pictures—reminiscences of Cherbourg life.

His first success was obtained in 1844, when his "Milkwoman" and "Lesson in Riding" (pastel) attracted notice at the Salon, and friendly artists presented themselves at his lodgings only to learn that his wife had just died, and that he himself had disappeared. Millet was at Cherbourg; there he remarried, but having amassed a few hundred francs he went back to Paris and presented his "St Jerome" at the Salon of 1845. This picture was rejected and exists no longer, for Millet, short of canvas, painted over it "Oedipus Unbound," a work which during the following year was the object of violent criticism. He was, however, no longer alone; Diaz, Eugène Tourneux, Rousseau, and other men of note supported him by their confidence and friendship, and he had by his side the brave Catherine Lemaire, his second wife, a woman who bore poverty with dignity and gave courage to her husband through the cruel trials in which he penetrated by a terrible personal experience the bitter secrets of the very poor. To this date belong Millet's "Golden Age," "Bird Nesters," "Young Girl and Lamb," and "Bathers"; but to the "Bathers" (Louvre) succeeded "The Mother Asking Alms," "The Workman's Monday," and "The Winner." This last work, exhibited in 1848, obtained conspicuous success, but did not sell till Ledru Rollin, informed of the painter's dire distress, gave him 500 francs for it, and accompanied the purchase with a commission, the money for which enabled Millet to leave Paris for Barbizon, a village on the skirts of the forest of Fontainebleau. There he settled in a three-roomed cottage for the rest of his life—twenty-seven years, in which he wrought out the perfect story of that peasant life of which he alone has given a "complete impression." Jules Breton has coloured the days of toil with sentiment; others, like Courbet, whose eccentric "Funeral at Ormans" attracted more notice at the Salon of 1850 than Millet's "Sowers and Binders," have treated similar subjects as a vehicle for protest against social misery; Millet alone, a peasant and a miserable one himself, saw true, neither softening nor exaggerating what he saw. In a curious letter written to M. Sensier at this date (1850) Millet expressed his resolve to break once and for all with mythological and undraped subjects, and the names of the principal works painted subsequently will show how steadfastly this resolution was kept. In 1852 he produced "Girls Sewing," "Man Spreading Manure"; 1853, "The Reapers"; 1854, "Church at Gréville"; 1855—the year of the International Exhibition, at which he received a medal of second class—"Peasant Grafting a Tree"; 1857, "The Gleaners"; 1859, "The Angelus," "The Woodcutter and Death"; 1860, "Sheep Shearing"; 1861, "Woman Shearing Sheep," "Woman Feeding Child"; 1862, "Potato Planters," "Winter and the Crows"; 1863, "Man with Hoe," "Woman Carding"; 1864, "Shepherds and Flock, Peasants Bringing Home a Calf Born in the Fields"; 1860, "Knitting Lesson"; 1870, "Butter-making"; 1871, "November—recollection of Gruchy." Any one of these works will show how great an influence Millet's previous practice in the nude had upon his style. The dresses worn by his figures are not clothes, but drapery through which the forms and movements of the body are strongly felt, and

their contour shows a grand breadth of line which strikes the eye at once. Something of the imposing unity of his work, was also, no doubt, due to an extraordinary power of memory, which enabled Millet to paint (like Horace Vernet) without a model; he could recall with precision the smallest details of attitudes or gestures which he proposed to represent. Thus he could count on presenting free from afterthoughts the vivid impressions which he had first received, and Millet's nature was such that the impressions which he received were always of a serious and often of a noble order, to which the character of his execution responded so perfectly that even a "Washerwoman at her Tub" will show the grand action of a Medea. The drawing of this subject is reproduced in *Souvenirs de Barbizon*, a pamphlet in which M. Piédagnel has recorded a visit paid to Millet in 1864. His circumstances were then less evil, after struggles as severe as those endured in Paris. A contract by which he bound himself in 1860 to give up all his work for three years had placed him in possession of 1000 francs a month. His fame extended, and at the exhibition of 1867 he received a medal of the first class, and the ribbon of the Legion of Honour, but he was at the same moment deeply shaken by the death of his faithful friend Rousseau. Though he rallied for a time he never completely recovered his health, and on the 20th of January 1875 he died. He was buried by his friend's side in the churchyard of Chailly. His pictures, like those of the rest of the Barbizon school, have since greatly increased in value.

See the article *BARBIZON*; also A. Sensier, *Vie et œuvre de J. F. Millet* (1874); Piédagnel, *Souvenirs de Barbizon*, &c. (1876); D. C. Thomson, *The Barbizon School* (1891); Richard Muther, *J. F. Millet* (1905); Gensel, *Millet and Rousseau* (1902). (E. F. S. D.)

MILLET (Fr. *millet*; Ital. *miglietto*, diminutive of *miglio* = Lat. *mille*, a thousand, in allusion to its fertility), a name applied with little definiteness to a considerable number of often very variable species of cereals, belonging to distinct genera and even subfamilies of Gramineae. Common millet is *Panicum miliaceum* (German *Hirse*). It is probably a native of Egypt and Arabia but has been cultivated in Egypt, Asia and southern Europe from prehistoric times. It is annual, requires rich but friable soil, grows to about 3 or 4 ft. high, and is characterized by its bristly, much branched nodding panicles. One variety has black grains. It is cultivated in India, southern Europe, and northern Africa, and ripens as far north as southern Germany, in fact, wherever the climate admits of the production of wine. The grain, which is very nutritious, is used in the form of groats, and makes excellent bread when mixed with wheaten flour. It is also largely used for feeding poultry, for which purpose mainly it is imported. Hungarian grass, *Setaria italica* (also called *Panicum italicum*), a native of eastern Asia is one of the most wholesome and palatable Indian cereals. It is annual, grows 4 to 5 ft. high, and requires dry light soil. German Millet (Ger. *Kolbenhirse*, *Mohar*) is probably merely a less valuable and dwarf variety of *S. italica*, having an erect, compact, and shorter spike. The grains of both are very small, only one half as long as those of common millet, but are exceedingly prolific. Many stalks arise from a single root, and a single spike often yields 2 oz. of grain, the total yield being five times that of wheat. They are imported for poultry feeding like the former species and for cage-birds, but are extensively used in soups, &c., on the Continent. Numerous other species belonging to the vast genus *Panicum*—the largest among grasses, of which the following are among the most important—are also cultivated in tropical or subtropical countries for their grain or as fodder



Setaria italica.

grasses, or both, each variety of soil, from swamp to desert, having its characteristic forms.

Polish millet is *P. sanguinalis*; *P. frumentaceum*, shamalo, a Decan grass, is probably a native of tropical Africa; *P. decompositum* is the Australian millet, its grains being made into cakes by the aborigines. *P. maximum* is the Guinea grass, native of tropical Africa; it is perennial, grows 8 ft. high, and yields abundantly of highly nutritious grain. *P. spectabile* is the coarxim of Angola, but has been acclimatized in Brazil and other tropical countries. Other gigantic species 6 or 7 ft. high form the field-crops on the banks of the Amazon. Of species belonging to allied genera, *Pennisetum typhoides*, bajree, sometimes also called Egyptian millet or pearl millet, is largely cultivated in tropical Asia, Nubia and Egypt. Species of *Paspalum*, *Elesusine* and *Milium*, are also cultivated as millets. For Indian millet, see DURRA.

MILLIGAN, WILLIAM (1821-1892), Scottish theologian, was born on the 15th of March 1821, the eldest son of the Rev. George Milligan and his wife Janet Fraser. He was educated at the High School, Edinburgh, and, from the age of fourteen, at the university of St Andrews, where he graduated in 1839. In 1843 at the disruption he took the side of those who remained in the Establishment, and in 1844 became minister of Cameron in Fifeshire. In 1845, his health having given way, he went to Germany, and studied at the university of Halle. After his return to Scotland and his resumption of his clerical duties he began to write articles on Biblical and critical subjects for various reviews. This led to his appointment in 1860 to the professorship of Biblical criticism in the university of Aberdeen. In 1870 he was appointed one of the committee for the revision of the translation of the New Testament. His fervent piety, and his wide interest in educational and social questions, extended his influence far beyond the circle of theologians. His contributions to periodical literature for many years were numerous and valuable; but his reputation chiefly rests on his works on the *Resurrection* (1890) and *Ascension of our Lord* (1892), his Baird lectures (1886) on the *Revelation of St John*, and his *Discussions* (1893) on that book. All these volumes are distinguished by great learning and acuteness, as well as by breadth and originality of view. He died on the 11th of December 1892.

MILLINER, originally a dealer in goods from the city of Milan in Italy, whence the name. Such goods were chiefly steel work, including cutlery, needles, also arms and armour and textile fabrics, ribbons, gloves and "Milan bonnets." The "milliners" of London, though never formed into a Livery Company seem to have been associated with the "Cappers and Hurers," which later were amalgamated with the "Haberdashers" (*q.v.*). Minshew's derivation of the word from *millie*, thousand ("as having a thousand small wares to sell"), though a typical instance of guessing etymologies, shows the miscellaneous character of their trade in the 16th and 17th centuries. The modern use of the word is confined chiefly to one who makes and sells bonnets and hats for women; but articles of "millinery" include ribbons, laces, &c., usually retailed by haberdashers.

MILLIPEDE, the popular name of the best known members of a group of the Arthropoda, scientifically known as Diplopoda, and formerly united with the Chilopoda (see CENTIPEDE), the Pauropoda and the Symphyla as an order of the class Myriapoda. This classification, however, has of late years been abandoned on account of the recognition of closer affinity between the Chilopoda (centipedes) and the Hexapoda (insects) than between the Chilopoda and Diplopoda. By modern writers the above-mentioned groups of "tracheate" Arthropoda are either regarded as independent classes of this phylum Arthropoda, or associated in two superclasses, the Opisthogaonea or Opisthogaoneata for the Chilopoda and Hexapoda; and the Prosgogaonea or Prosgogaoneata for the Diplopoda, Pauropoda and Symphyla. The structural character upon which these superclasses are based is the position of the generative apertures which open anteriorly in the Prosgogaonea and posteriorly in the Opisthogaonea. Although the Pauropoda and Symphyla are not, strictly speaking, Diplopoda, these three groups of prosgogaoneate arthropods are here for convenience considered together.

CLASS DIPLOPODA.

Structure.—The anterior extremity is provided with a distinct head which by its general form and the nature of its appendages is as sharply marked off from the body as is the case in the Hexapoda. It always bears at least three pairs of appendages, the eyes when present and, in the Oniscomorpha a peculiar sense organ.

The inferior edge of the head plate overhangs the mouth and is termed the labrum. The exoskeleton of a typical somite consists of the following elements: a dorsal plate, a ventral plate, and a pleural plate on each side. To the external margin of the ventral plate or sternum is articulated a pair of legs and between the leg and the pleural plate is situated the spiracle of the tracheal system. But the segmentation of the Diplopoda presents two marked peculiarities. The first is the fact that, with the exception of a few of the anterior leg-bearing segments and perhaps one or two of those at the posterior end of the body, a single dorsal plate or tergum with its pleural plates overlies two sternal plates, two pairs of legs and two pairs of spiracles. Hence the segments appear to be double and to be furnished with twice as many legs as is normal in the Arthropoda—a peculiarity which has suggested the term "Diplopod" or "double-footed;" for this group, it is generally believed that each tergal plate results from the coalescence of the terga of two originally distinct adjoining segments; but the same effect would be produced by the enlargement of one of a pair of terga and the complete excalation of the other. It is in favour of the latter view that there is only a single pair, and not two pairs, of stink-glands on each so-called double tergal plate. Unfortunately the history of the development of the segments does not clear up the difficulty since the terga of the double segments are single from the first, and no evidence either of fusion or excalation is supplied. The second of the two peculiarities above-mentioned is the great development of the tergal sclerite as compared with the sternal. Only very rarely (*i.e.* in *Platydesmus*) is there a broad sternal area. In the majority of cases the lateral edges of the tergum are bent downwards and inwards towards the mid ventral line; the sternum at the same time is so much reduced that the basal segments of the legs of opposite sides are almost in contact. The

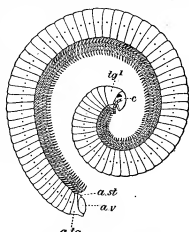

After Pocock in Max Weber's Zool. Ergebnisse, 8c., IV., Pl. XXI., fig. 8, 1894.

FIG. 1.—*Spirastrostreptus vitatus*, an Oriental species of the Spirostreptoidea, lateral view, showing the repugnatorial pores on the sides of the segments.

lg', head with eyes and antennae.
lg', tergal plate of first segment.
ag, tergal plate of last or anal segment.
av, sternal plate of ditto.
st, anal valve.

It is generally believed that each tergal plate results from the coalescence of the terga of two originally distinct adjoining segments; but the same effect would be produced by the enlargement of one of a pair of terga and the complete excalation of the other. It is in favour of the latter view that there is only a single pair, and not two pairs, of stink-glands on each so-called double tergal plate. Unfortunately the history of the development of the segments does not clear up the difficulty since the terga of the double segments are single from the first, and no evidence either of fusion or excalation is supplied. The second of the two peculiarities above-mentioned is the great development of the tergal sclerite as compared with the sternal. Only very rarely (*i.e.* in *Platydesmus*) is there a broad sternal area. In the majority of cases the lateral edges of the tergum are bent downwards and inwards towards the mid ventral line; the sternum at the same time is so much reduced that the basal segments of the legs of opposite sides are almost in contact. The

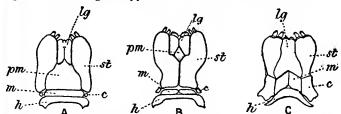

After Silvestri, Ann. Mus. Genova, (2), xvi, figs. 17, 19, 25.

FIG. 2.—The Gnathochilarium or jaws of second pair of various Chilongawa.

A, of *Spirastrostreptus*. B, of *Julus*. C, of *Glomeris*.
c, cardio.
st, stipes.
lg, linguae.
m, mentum.
pm, promentum.
h, hypostoma.

pleural plate on each side usually disappears either by suppression or by fusion with the tergum. The sterna with their attached legs often remain free. But quite commonly the coalescence of the skeletal elements is carried to such an extreme that each segment is a solid ring with two pairs of movable appendages. The last segment is differently constructed from the others. It is always limbless, and usually consists of a complete tergal ring, a single sternal plate, and a pair of movable anal valves which are normally closed, but are capable of being opened for the passage of faeces. These anal valves are possibly the homologues of the plural scutes of a normal segment. The appendages are modified

as a single pair of antennae, two or three pairs of jaws and a variable number of walking-legs, of which one or more pairs may be transformed into gonopods. The antennae are short and very similar to the legs. They are preoral in position, and usually consist of seven segments, the seventh or distal segment being small, as a rule, and furnished with a sense organ which is probably olfactory or tactile in function. The mandibles or jaws of the first pair are the most anterior of the postoral appendages. They are large, powerful, and usually consist of three or two segments, a basal or

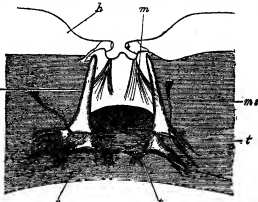

After Voges.

FIG. 3.—Inner view of ventral area of a single segment of *Julus*, much enlarged to show the structure and arrangement of the tracheal organs. The two pairs of tracheae are seen *in situ*, the posterior pair overlapping the anterior.

h, Posterior margin of the body-*t*, Fine tracheae given off from it (ring (ring)). *ms*, Respiratory muscle attached to tracheal sac.
r, Anterior border.
st, Tubular chamber of tracheae. *m*, Ventral body muscle.

cardo, which is sometimes absent, a second or stipes, and a third or mala, the latter being supplied with a strong tooth and pectinate lamellae. In all Diplopods, with the exception of the Pselaphognatha, there are only two pairs of jaws, those of the second pair forming a large plate, the gnathochilarium, which acts as a lower lip. It consists of several distinct sclerites, two external on each side, the proximal known as the cardo, the distal as the stipes, the latter being tipped with one or two lobes (mala) and far exceeding the cardo in size. Between the external plates there is a median proximal plate (mentum) generally of large size and often itself subdivided, and a pair of distal plates (linguae). Behind the base of the gnathochilarium there is a single large transverse plate, the hypostoma. In the Pselaphognatha, the jaws representing the gnathochilarium are differently constructed and an additional pair, the maxillulae, has been recently detected between the gnathochilarium and the mandibles. Behind the gnathochilarium, which from embryological data appears to result from the modification of a single pair of appendages, a legless somite has been detected in some embryos. Possibly the plate referred to above as the hypostoma is its sternal element.

The heart is a median dorsal vessel composed of a series of chambers each giving off a pair of arteries and furnished with a pair of orifices or ostia. According to Newport, the anterior chamber lying in the second segment is prolonged into an aortic trunk from which arise three pairs of lateral arteries dipping down on each side of the alimentary canal and uniting beneath it in a common ventral vessel. The heart is enveloped in a delicate pericardial membrane and is supported by lateral alary muscles. The alimentary canal is a simple tube extending usually straight through the body from mouth to anus. Only in the Oniscomorpha is it looped, thus suggesting the origin of this short-bodied group of millipedes from longer, more vermiform ancestors. A pair of so-called salivary glands opens into the fore-gut near its anterior extremity and one or two pairs of malpighian tubules communicate with the hind-gut at its junction with the broad mesenteric portion of the canal. Respiration is effected by means of tracheal tubes which communicate with the exterior by means of spiracles situated just above the bases of the walking limbs. Each spiracle leads into a longer or a shorter pouch whence the tracheae, which are of two kinds, arise. In the majority of the orders the tracheae are tufted, that is to say, they form two bundles of short simple tubules springing from the innermost corners of each pouch. In the Oniscomorpha, however, each pouch gives rise to a number of long tubes which extend through the body and somewhat resemble those of the Chilopoda except that they neither branch nor are extensive. As in the Chilopoda and Hexapoda the tracheae are strengthened and kept expanded by a slender spiral filament.

The ventral nerve cord consists of two strands so closely approximated as to be practically fused, with a small ganglionic enlargement for each pair of legs. Hence in the double segments there are two such ganglia, which in addition to the cranial nerve give off

on each side a large branching nerve to other organs in the segment. In the Opisthospermophora (*Julus*, *Spirostreptus*) and the Oniscomorpha (*Glomeris*, *Sphaerotherium*) the ganglia are spaced at equal distances on the cord, but in the Merochaeta (*Polydesmus*) they are grouped in pairs to correspond to the spacing of the legs. The apodous penultimate and anal segments are innervated from the last ganglion of the cord, as are also the gonopods of the males of

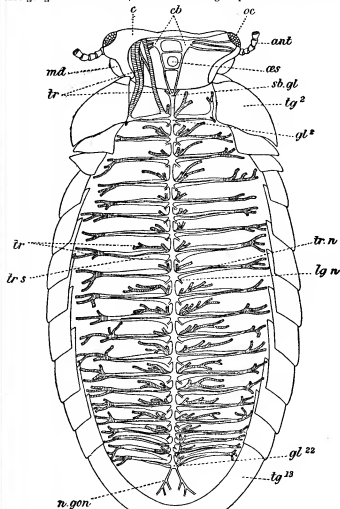

After G. C. Bourne, *J. Linn. Soc.* six., Pl. 29, 1886.

FIG. 4.—Diagram of the nervous and circulatory system of *Sphaerotherium obtusum*, a South African species of Oniscomorpha.

c, Head. g^2 and g^{22} , Second and twenty-second ganglia of chain, the posterior nerve of each ganglion, lg^2 , supplies the leg, the anterior, tr, n , the tracheal sac and other organs.
oc, Eye-cluster.
ant, Antenna.
md, Basal segment of mandible.
 lg^2 and lg^{13} , Part of the terga of the second and thirteenth segments.
cb, Cerebral ganglia supplying the eyes and antennae.
oes, Oesophagus, cut through.
sb, gl, Suboesophageal or first ganglion of ventral chain.
n, gon, Nerve to gonopods.
tr, Tracheal tubes with spiral filament.
tr, s, Tracheal sac.

the Oniscomorpha. The first (suboesophageal) ganglion of the cord supplies the mandibles and gnathochilarium and is connected by the oesophageal commissures with the bilobed cerebral nerve whence arises the nerves for the eyes, when present, and the antennae.

Eyes are sometimes absent, as in all the genera of Merochaeta and in many genera of other groups, as in *Siphonophora*, one of the Colobognatha, and several of the Julioidea (*Typhloblanius*). In other cases they are represented by one or two ocelli on each side (Stemmiuloidea); or by a vertical series of ocelli as in the Glomerioidea and *Polyzonium* amongst the Colobognatha. But in the majority of the orders they are represented by triangular or subspherical aggregations of ocelli recalling in a certain degree those of the Lithobiomorpha amongst the Chilopoda. They are simple in structure and consist externally of a cuticular corneal thickening or lens and internally of a reticular layer of enlarged epidermic cells, the

internal or proximal ends of which are continuous with the fibres of the optic nerve. The ovary is unpaired and extends almost the entire length of the body beneath the alimentary canal. The oviducts are sometimes separate tubes (*Lyssiopetalum*), sometimes confluent and divided just before terminating in the two orifices behind the base of the legs of the second pair (*Julus*). The testes and seminal ducts occupy the same position and extent as the ovary and oviducts. The ducts are sometimes coiled, sometimes divided, sometimes united. The two testes are sometimes united by transverse branches across the middle line, and are sometimes branched posteriorly. They bear short caecal diverticula in which the semen is developed. There are no accessory glands associated with the generative organs; but in some forms, e.g. *Polyxenus*, there is a pair of receptacula seminis extending backwards alongside the ovary and opening into the oviduct.

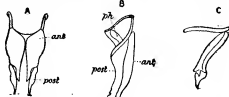

After Pocock, *J. Linn. Soc.* xxi, Pl. 25.

FIG. 5.—Gonopods of *Trigonulus andersoni*, one of the Opisthospermophora (Spiroboloidea).

A, Anterior view, and B, lateral views of the apparatus. *ant*, anterior, and *post*, posterior portions of the coxopod ensheathing the phallopod, of which the proximal portion, *ph*, is shown.

C, Phallopod removed from the coxopod.

The secondary sexual characters of the males are of great taxonomic importance. The seminal ducts, like the oviducts, open behind the legs of the second pair. Associated with them in the Limacomphora (*Glomeridesmus*), there is a pair of very long retractile penes. In the Spirostreptoidea and Juloidea the penes are much shorter and have coalesced. Sometimes they are undeveloped (Spiroboloidea). In other cases, the Merochaeta, Oniscomorpha, &c., the ducts traverse the coxae of the legs of the second pair. But in all these groups, with the exception of the Oniscomorpha, semen is transferred from the genital orifices, with or without the aid of the penes, either into the first or second pairs of appendages of the seventh segment which are modified in various ways, and are termed phallopods. When the posterior legs are so modified the anterior are as a rule even more profoundly altered to form a protective sheath, or the phallopod; and as a further precaution the entire apparatus is usually withdrawn within the seventh segment. In the Oniscomorpha the semen is transferred into a pair of receptacles developed upon the coxae of the legs of the last pair, which are chelate. The male appendages that are modified in the above described ways are comprehensively spoken of as gonopods. Other secondary sexual characters, like the stridulating organs of the males of some Oniscomorpha, the suctional pads on the legs of Spirostreptoidea, the development of angular processes upon the mandible or first tergal plate, or of fine ridges in the gnathochilarium—all of which are concerned in enabling the male to maintain a secure hold upon the female—are of great taxonomic use in distinguishing the genera and species.

The most important glands in the Diplopoda are the repugnatorial or stink-glands, which, except in the Oniscomorpha, Limacomphora and AscospERMOPHORA, open by pores upon the sides of more or fewer of the segments. They secrete a fluid with an unpleasant odour, breaking up in one case into cyanide of potassium, and are practically the only means of protection, apart from the hard exoskeleton, which Diplopods possess. In some millipedes silk glands also exist and open upon papillae upon the posterior border of the last tergal plate. They are found in the AscospERMOPHORA, Stemmiuloidea and ProterospERMOPHORA, and are used for spinning nests for the eggs and protective cases for the young during exuviation.

Classification.—The existing members of the class Diplopoda may be classified as follows:—

Subclass I. PSELAPHOGNATHA.

Order: *Penicillata* (*Polyxenus*).

2. CHILOGNATHA.

Order: *Oniscomorpha* (*Glomeris*, *Zephronia*).

“ *Limacomphora* (*Glomeridesmus*).

“ *Colobognatha* (*Polyzenus*, *Siphonophora*).

“ *AscospERMOPHORA* (*Chordeuma*).

“ *ProterospERMOPHORA* (*Lyssiopetalum*).

“ *Merochaeta* (*Polydesmus*).

“ *Opisthospermophora*.

Suborder: *Stemmiuloidea* (*Stemmiulus*).

“ *Spiroboloidea* (*Spiroboloidea*).

“ *Spirostreptoidea* (*Spirostreptus*).

“ *Juloidea* (*Julus*, *Nemasoma*).

Subclass PSELAPHOGNATHA.

Diplopods with the soft integument strengthened by weakly chitinized sclerites and furnished above and on the head with transverse rows of short, stout, somewhat squamiform bristles; laterally, on each side of the principal segments, with a thick tuft of long bristles and with a large, silky, white tuft projecting backwards from the posterior extremity. Mandibles one-jointed. Behind them a pair of small, one-jointed maxillae, attached to a median membranous “lingua.” Behind the “lingua” and maxillulae, a large, double, transverse plate with a long, external sclerite bearing distally in *Polyxenus* an inner short-lobate process and an outer long spiny palpiiform branch. The latter, however, is absent in *Lophoproctus*. These sclerites probably represent the gnathochilarium of the Chilognatha, but the homology between the skeletal elements of the jaws in question is not clearly understood. It has been suggested that they represent two pairs of jaws, but embryological proof of this does not exist.

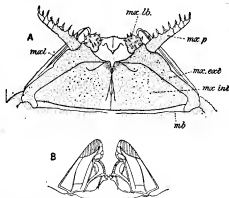

A, after Carpenter, *Q.J.M.S.* 49, Pl. 28, fig. 1.
B, after Latzel, *Die Myr. Ost. Ung. Mon.* II, Pl. II, 1884.

FIG. 6.—Jaws of *Polyxenus lagurus*.

A, Jaws of second and third pairs. *mx.lb.*, maxillula; *mx.p.*, palpiiform branch of maxilla; *mx.lb.*, lobate process of maxilla; *mx.ext.*, external plate of maxilla perhaps corresponding to the stipes of the gnathochilarium of the Chilognatha; *mx.int.*, internal plate of maxilla, perhaps corresponding to the mentum and pronotum of the gnathochilarium (by Carpenter *mx.int.* is regarded as an appendage posterior to the maxilla); *mb.*, membrane.

—B, Mandibles of *Polyxenus lagurus*.

Order *Penicillata* (= *Ancyrotricha*).

Head large, usually with lateral eyes. Antennae eight-jointed, attached near the middle of the front of the head. On the dorsal side of the body there are eleven segments, simple and compound. The first four of these bear one pair of legs each, the succeeding four two pairs of legs, the ninth segment one pair, making a total of thirteen pairs of legs. The tenth and eleventh and anal segment are legless. There is a narrow sternal area separating the bases of the legs of the two sides. There are no repugnatorial glands. In the male none of the legs are modified as gonopods, but the coxa of each of the legs of the second pair is furnished with a conical penis, which during copulation, it may be supposed, is inserted into the genital orifice of the female, which occupies a corresponding position in that sex. The young when first hatched has only three pairs of legs and five segments. The millipedes of this order are all of small size, measuring at most only a few millimetres in length. The best-known genera are *Polyxenus* and *Lophoproctus*, both of which occur in Europe. Other forms have been discovered in the West Indies, North and South America, and Ceylon; and it is probable that the group has an almost cosmopolitan range. They live under stones or the loosened bark of trees. The carboniferous fossil, *Palaeocampa*, is usually referred to this subclass.

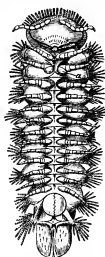

After Bode.

FIG. 7.—Ventral view of *Polyxenus lagurus* much enlarged, actual length a little over $\frac{1}{16}$ th of an inch.

Diplopods with firmly chitinized exoskeleton, sometimes thickly, sometimes sparsely covered with short, simple hairs, but never decorated with tufts or rows of peculiarly modified bristles.

a, Position of generative openings.

Mandibles, two- or three-jointed; maxillulae absent, the jaws of the second pair being represented by the gnathochilarium described above.

Order Oniscomorpha.

Body short and broad, hemispherical in transverse section; convex above, flat below, and capable of being spherically coiled. The exoskeleton of a typical compound segment consists of a vaulted tergum, a pair of free pleural sclerites, two pairs of small tracheal sclerites and two pairs of legs, the latter attached to the ventral membrane, which has no sternal plates. The tergal plates are twelve or thirteen in number, whereof the first is very small, the second enormously expanded laterally, and the last, also enlarged and probably representing at least three segments, extends laterally and posteriorly like a hood over the posterior end of

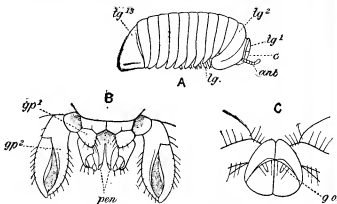

After Pocock, in Max Weber's *Zool. Ergebnisse*, &c., IV., Pl. xi.

FIG. 8.—*Sphaeropoeps hercules*, a Sumatran species of the Oniscomorpha.

A, Lateral view of the entire animal. *c*, head; *ant*, antenna; *lg*¹, *lg*² and *lg*¹², tergal plates of first, second and thirteenth segments; *lg*, extremities of some of the anterior legs.

B, Gonopods of the male. *gp*¹ and *gp*², anterior and posterior pairs of gonopods, both being chelate claspers; *pen*, processes arising from the basal segments of the gonopods of the second pair, which act as penes.

C, Vulvae or genital plates attached to the basal segments of the legs of the second pair in the female. *g.o.*, genital orifice.

body without forming a chitinous ring round the anal valves and sternum. In the male the legs of the penultimate pair are sometimes modified as claspers; those of the last pair are always enlarged and prehensile, and bear on their coalesced basal segments a pair of sperm-carrying processes analogous to the phallopods of other groups. Apart from these organs the male has no penis, the seminal ducts perforating the coxae of the legs of the second pair. This order contains two well-marked suborders, the Glomeroida and the Zephronioida. The Glomeroida, comprising the families *Glomeridae*, *Gervaisiidae*, *Onomeridae*, have the antennae approximated on the head, the eyes uniserial and twelve (rarely eleven) tergal plates. To this group belong the common pill-millipedes of Europe and North Africa. In North America the *Onomeridae* alone are found. The Zephronioida, with the single family *Zephroniidae*, have the antennae at the sides of the head, the eyes composed of a spherical cluster of ocelli, and always thirteen tergal plates. This group is common in the tropical and southern continents of the Old World, having representative genera in South Africa, Madagascar, India, Malaysia, Australia and New Zealand. They are much larger forms than the Glomeroida, large specimens reaching two or three inches in length. In addition to the characters mentioned above the Oniscomorpha differ from all other Diplopods in having long tubular tracheae and the alimentary canal bent upon itself.

Order Limacomorpha.

Resembling the Oniscomorpha in the shape and structure of a typical segment, except that the tracheal plates are unrepresented; in the facts that the last tergal plate does not form a complete ring round the anal area, and that the last pair of legs in the male are modified; but differing from them in that the body consists of nineteen or twenty segments, is elongate, and tapers anteriorly and posteriorly, the second and last tergal plates being small; in the presence in the male of a pair of long hairy protrusible penes between the legs of the second and third pairs, and in the structure of the gonopods, which, instead of being chelate, terminate in a slender, tapering tarsal segment. This order contains two families: *Zephroniodesmidae* (*Zephroniodesmus*) and *Glomeridesmidae* (*Glomeridesmus*), the former from tropical Asia, the latter from tropical America. The largest of these millipedes reach a length of only about 7 mm. Nothing special is known of their habits.

Order Colobognatha.

Body elongate, capable of being spirally coiled, consisting of a large and indefinite number of segments, each being furnished with a distinct often large sternal area, and with the pleural sclerite or membrane distinct from the tergum. The last tergal plate forms a complete ring round the anal valves. Legs with coxal pouches; those of the seventh segment transformed into gonopods of a very simple type in the male, which is also furnished with a double penis completely or partially confluent with the coxae of the legs of the second pair. Head always small, frequently triangular or pyriform, in the latter case the gnathites reduced in size and complexity. Repugnatorial pores present and lateral. The genera of this order

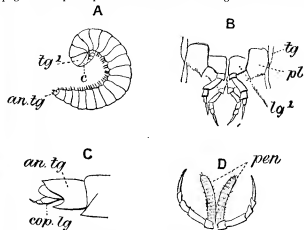

After Pocock, *J. Lim. Soc.* xxiv., Pl. 37.

FIG. 9.—*Glomeridesmus marmoreus*, one of the Limacomorpha.

A, Lateral view. *c*, head with antennae; *tg*¹, tergal plate of first segment; *an.tg*, tergal plate of last or anal segment.

B, Lower view of one of the segments. *lg*, inferior edge of the tergal plate; *pl*, pleural sclerite; *lg*¹, basal segment of leg.

C, Posterior extremity of body. *an.tg*, tergal plate of anal segment; *cop.lg*, gonopod or copulatory leg.

D, Legs of the third pair with extruded penes, *pen*, in front of them.

are divisible into three families: the *Platydesmidae* (*Platydesmus*, *Pseudodesmus*), *Polyzonidae* (*Polyzonium*, *Siphonotus*), *Siphonophoridae* (*Siphonophora*). Of these the *Platydesmidae* have departed least and the *Siphonophoridae* most from the typical Diplopod in the structure of the mouth parts. The group is for the most part tropical, one genus only, *Polyzonium*, extending as far north as Central Europe.

Order Ascospemphora.

Body elongate, consisting of from twenty-six to thirty-two segments, but not varying within specific limits; the pleurae coalesced with the terga, the sterna free. More or fewer of the anterior ten pairs of legs may be modified in the males, but no true phallopods are differentiated, the function of seminal receptacles being performed (according to C. Verhoeff) by the exsertile coxal pouches of the two pairs of legs of the eighth segment. The seminal ducts in the male perforate the coxae of the legs of the second pair. There are no repugnatorial pores, and the terga are furnished with three pairs of symmetrically placed hairs or bristles. On the posterior border of the last tergal plate there is a pair of spinning papillae. The millipedes of this order, also called *Coelochaeta*, are referable to several families: *Chordeumidae* (*Chordeuma*), *Craspedosomidae* (*Craspedosoma*), *Heterochordeumidae* (*Heterochordeuma*), &c. The *Heterochordeumidae* belong to the Oriental region, extending from India to New Zealand. The others are particularly abundant in genera and species in North and Central America and Europe; but are unknown in Africa, south of the Sahara.

Order Proterospermophora.

Differing from the *Ascospemphora* in that the number of segments is large and variable; they are furnished with repugnatorial pores, and not with the three pairs of setae. In the males the anterior appendages of the seventh segment are modified as phallopods, and the seminal ducts perforate the coxae of the legs of the second pair.

This order, containing the family *Lyssiopetalidae* (*Lyssiopetalum*), is widely distributed in Europe and North America. Large examples of some of the species, e.g. *L. zanthinum*, reach a length of 4 or 5 ins.

Order Merochaeta.

Resembling the Proterospermophora in having only the anterior appendages of the seventh segment converted into phallopods and the seminal ducts perforating the coxae of the second legs in the males; but differing essentially in that the sterna are

solidly welded to the rest of the exoskeleton of the segments, which are either nineteen or twenty in number, in the absence of eyes and of spinning papillae, and in having six-jointed legs. This order is cosmopolitan in distribution and consists of a very large number of genera which by some authors are referred to the single family *Polydesmidae*; by others to numerous families. Many species are brightly coloured, and some individuals of the Oriental genus

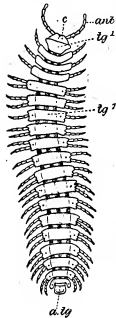

After Pocock, in Max Weber's *Zool. Ergebnisse*, *etc.*, IV, Pl. 22.

FIG. 10.

Platyphachus mirandus, a Sumatran species of *Polydesmidae*, to show the form characteristic of the order Merochaeta.

- c, Head.
ant, Antenna.
tg¹, Tergal plate of first body segment.
tg², Ditto of seventh.
a.g., Tergal plate of anal segment.

The figure also shows the repugnatorial pores which are present upon the majority of the segments, the laterally expanded tergal plates, and the presence of two pairs of legs for each of the segments except the two last, the fourth first and the seventh; the latter, since the figured specimen was a male, has the anterior leg converted into a phallopod which is concealed beneath the body.

Platyphachus may reach a length of 5 ins. The segments are usually provided with lateral laminate or tubercular expansions bearing the repugnatorial pores, which are only very rarely absent.

Order Opisthospermophora.

Resembling the Proterospemphora in possessing a large and variable number of segments, each of which, with the exception of the last and the anterior four or five, is furnished with a pair of repugnatorial pores, but differing essentially from them in that the posterior pair of appendages of the seventh segment are converted into phallopods, and the anterior into protective colopods in the male, and that the seminal ducts in this sex do not perforate the coxae of the legs of the second pair but are usually associated with a distinct penis situated immediately behind them. The genera of this order present greater diversity of structure than is found in the other orders and are referred to four suborders, which by some zoologists are erected to ordinal rank, namely, the Stemmiuloidea (Monochaeta); the Spirobuloidea (Anochaeta); the Spirostreptoidea (Diplochaeta); and the Julioidea (Zygochaeta).

In the Stemmiuloidea the sterna are free and the pleurae partially so; the terminal segment of the legs is bisegmented; there are two pairs of spinning papillae on the last tergite; the penis is a single long tube, and the eyes are represented by one or two large lenses on each side of the head. The genus *Stemmiulus*, constituting the Oriental, Ethiopian and Neotropical regions. In the possession of silk-glands this suborder resembles the Ascospemphora and Proterospemphora, and should perhaps rank as an order apart from the Opisthospermophora.

The Spirobuloidea, containing one family, the *Spirobuloidea* (*Spirobulus*, *Rhinocricus*, &c.), have the sterna and pleurae coalesced, the tarsi undivided; no spinning papillae, no penis, the eyes represented by an aggregation of ocelli; and the first five segments each with a single pair of legs, the sixth carrying two pairs. This group attains its maximum of development in the tropics, where species and genera are numerous and specimens of large size, i.e. 6 ins. or over, are met with.

The Spirostreptoidea resemble the Spirobuloidea in many particulars, but the fourth segment is footless, and the fifth has two pairs of limbs; the male has a distinct and double penis, and in both sexes the stipes of the gnathochilarium extend to the proximal end of the mentum, which is relatively small. The distribution of this order, which contains several families: *Spirostreptidae* (*Spirostreptus*, *Rhynchoproctus*), *Cambalidae* (*Cambala*, *Julomorpha*), &c., is practically the same as that of the Spirobuloidea. Specimens over 6 ins. in length are met with in the tropics of Africa and Asia.

The Julioidea differ from the Spirostreptoidea in having the third segment limbless, the first, second and fourth with a single pair of appendages, and the stipes of the gnathochilarium much expanded and meeting for a considerable distance in the middle line behind the very small pronotum.

The best marked family of this group is the *Julidae*, which is widely distributed in the northern hemisphere. Its species and genera (*Julus*, *Pachyulus*) are abundant in Europe. Another European family, the *Nemasomidae*, is founded for the genus *Nemasoma*, which is remarkable for having the sterna free.

Habits, &c.—Millipedes are principally cryptozoic, living under

stones or logs of wood in damp, secluded localities. They feed almost wholly upon decaying vegetable matter, and drink a considerable quantity of water. Some of the tropical species emerge in numbers from their hiding-places after heavy rains, and crawl over the ground and bushes in search of moisture in broad daylight. Their method of progression over level ground is quite peculiar. The body is held in a straight line and is propelled by a succession of wave-like movements of the legs, which are moved in groups, the groups on the right and left side exactly corresponding. Some forms, e.g. *Stemmiulus*, have been described as attempting to evade capture by a hopping action caused by vigorous jerking and wriggling of the body. Many of the species are very conspicuously coloured and the association of brilliant colouring with the existence of the nauseous secretion of the repugnatorial glands suggests that the coloration is aposematic or of warning significance.

Copulation between the sexes takes place before oviposition. In the Opisthospermophora the males and females coil together with the ventral surface of the anterior ends of their bodies opposed, the male holding the female securely by the head while the extended phallopods carrying the semen are brought into contact with her genital orifice. In the *Polydesmidae* pairing is effected in the same way except that the male and female instead of intercoiling remain extended, the male clasping the female with his legs. In the Onisco-morpha the sexes also pair front to front, not head to head, however, but head to tail, so that the gonopods in the anal segment of the male can be applied to the second pair of postoral appendages in the female. Some males of this group, e.g. *Sphaerotherium*, have a stridulating organ on their posterior gonopods and stridulate when finding the females.

The method of disposing of the young, which usually have only three pairs of legs at hatching, differs in various groups. In *Julus* and *Polydesmus* the female burrows below the surface and makes a subspherical nest of small blocks of earth which are motened with the salivary secretion and moulded to the proper shape between her jaws and anterior legs. When the receptacle is nearly finished she deposits her eggs in it, and, closing the aperture, leaves the whole to its fate. On the other hand, a female specimen of the South African species, *Archispirostreptus syrtrocephalus*, that lived in the London Zoological Gardens, buried herself, coiled round the eggs, and remained with her young for some time after they were hatched. Again, millipedes, like the Stemmiuloidea, and Ascospemphora, which possess silk-glands, spin silken cases for the protection of their eggs. Immature specimens of these groups spin similar silken cases at the time of exuviation; and cases, resembling the nests, are likewise made for purposes of moulting by immature forms of some exotic species of *Polydesmidae*, e.g. by the tropical African *Oxydesmus*. There is good reason to think, however, that the animal makes use of its own voided excrement in the formation of these receptacles.

A considerable number of Chilognatha of doubtful systematic position have been recorded from beds of the carboniferous formation. The best known are *Acantherpestes* and *Euphorbia*. Specimens referred to existing genera have been discovered in amber beds of Oligocene age.

CLASS PAUROPODA.

As in the Diplopoda there is a distinct head bearing a pair of antennae and two pairs of jaws. On each side of the head there is an eye-like spot which may conceivably represent a degenerate eye, although the external cuticle shows no corneal thickening nor the epidermis reticular specialization, and optic nerves are absent from the brain. The antennae are structurally unique in the Arthropoda. There are four short basal segments from the distal of which arise two one-jointed branches, an external thinner and an internal thicker. The external or postaxial branch is tipped with a single long annulate flagelliform bristle with a rounded apical knob; and the internal or preaxial branch with two similar but shorter bristles and a globular, usually pedunculated, sense organ between them. The mandibles or jaws of the first pair are large and one-jointed. Those of the second pair are very short, piriform, and attached to the ventral side of the head by a long, rod-like sclerite. Between the two pairs of jaws there is a horny framework forming a kind of lower lip to the mouth. The correspondence between these mouth parts and those of the Diplopoda is not understood. No doubt the mandibles are homologous in the two groups; but whether the jaws of the second pair in the Pauropoda correspond to the maxillulae of the Pselaphognatha, or to part of the gnathochilarium in the Chilognatha, or whether the chitinous framework alone or in conjunction with the pair of jaws answers to the gnathochilarium



From Balfour, after Metchnikov.

FIG. 11.—Larva of *Strongylosoma Guerinii*, one of the *Polydesmidae*, just hatched.

are questions to which no answer can as yet be given. Judging from the segmentation and the appendages the body is composed of twelve somites, including the last or anal, which, like the penultimate somite, is limbless. Each somite in front of the penultimate

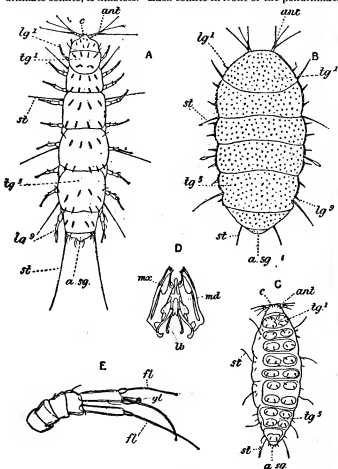

A and B, after Kenyon, *Tufts Coll. Studies*, iv., 1905; C, after Hansen, *Vid. Meddel.*, 1901, Pl. VI., fig. 30; D and E, after Kenyon.

FIG. 12.—PAUROPUS.

A. *Pauropus husleyi* (?). c, head; ant, antenna; lg^1 and lg^2 , first and fifth double tergal plates; lg^9 , first walking-leg (=2nd post-cephalic appendage); lg^9 , ninth walking-leg; a.sg, anal segment; st, setae.

B. *Eurypauropus spinosus*. Lettering as in A.

C. *Brachypauropus superbus*. Lettering as in A and B; (lg^1) = first and second terga; lg^9 , = ninth and tenth terga.

D. Jaws of *Pauropus husleyi*; md, mandible; mx, maxilla; lb, labial framework.

E. Antenna of *Eurypauropus spinosus*; fl, flagella; gl, sensory organ.

bears a single pair of legs, nine pairs of which are fully developed ambulatory limbs, while those of the first segment are reduced to



After Lubbock.

FIG. 13.—Enlarged view of *Pauropus husleyi*, from ventral side. A pair of bud-like processes. The first and last pairs of ambulatory limbs consist of five segments; in the remaining pairs the terminal segment may be subdivided into two, so that there may be six segments in all. The ambulatory limbs are usually terminated by three claws, a principal and two subsidiary, each claw being accompanied by a membranous pad. Between these limbs, which are relatively longer and stronger than in the Diplopoda and evenly spaced on each side of the body, extends a soft-skinned sternal area. The distensible pleural region of the body is also membranous, but the dorsal area is covered by chitinous plates or terga,

usually six in number, excluding that of the anal segment; each of the anterior five of these overlies two limb-bearing somites, the first covering the somite of the rudimentary limbs and of the first pair of locomotor legs, the second those of the second and third pairs of locomotor legs, and so on. This condition is an adumbration of the far completer fusion of somites seen in the Diplopoda. The sixth tergal plate belongs to the limbless penultimate somite. The duplex character of the first five terga is suggested in *Pauropus* by the presence of two rows of sensory bristles; there being only one such row upon the sixth tergum. In the aberrant genus *Brachypauropus* the evidence is practically completed by the correspondence in number between the terga and pairs of legs, there being a divisional line between the two rows of setae. On each side of the body there are five long pubescent tactile setae situated on the second to the sixth terga in *Pauropus*, and on the pleural area corresponding to these terga in *Brachypauropus*.

The cerebral mass of the nervous system is large and when viewed from above is seen to consist of two lobes defined by a median groove. In the absence of eyes no optic nerves are given off. Beneath these are two antennal lobes whence arise, close together, the antennal nerves. Two short commissural cords connect the cerebral mass with the subesophageal ganglion, a composite mass formed of the nervous centres which supply the two pairs of jaws and the rudimentary legs of the first pair. Behind this large ganglion the cord, which shows superficially no trace of its double origin, presents a ganglionic swelling for each pair of legs. No circulatory or respiratory organs have been detected.

The alimentary canal consists of a short, narrow fore-gut, a large, straight mid-gut, and a moderately long hind-gut which is itself composed of two parts, an anterior narrow tube which opens into

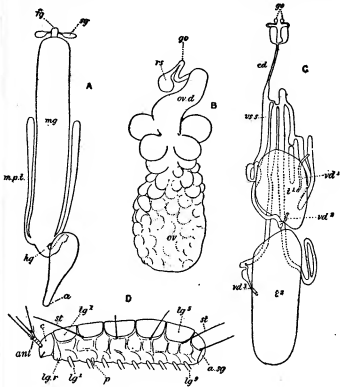

After Kenyon, *Tufts Coll. Studies*, iv., 1905.

FIG. 14.—PAUROPODA.

A. Alimentary canal of *Pauropus*; fg, fore-gut; sg, salivary gland; mg, mid-gut; hg, anterior portion of hind-gut; a, anus; m.p.t., Malpighian tubule.

B. Female genital organs of *Eurypauropus*; ov, ovary; ovid, oviduct; rs, receptaculum seminis; go, genital orifice.

C. Male genital organs of *Pauropus*; β and β , anterior and posterior portions of testes; w^1 , w^2 , w^3 , vasa deferentia; $vs.$, vesicula seminalis; cd, common duct; go, genital orifices.

D. Lateral view of *Pauropus*; c, head; ant, antenna; lg^1 , lg^2 , first and fifth tergal plates; a.sg, anal segment; st, lateral bristles; lg^9 , rudimentary leg; lg^1 and lg^9 , first and ninth fully formed walking legs; p, penis.

a dilated, piriform, posterior portion, narrowing gradually to terminate in the anus. Opening into the anterior extremity of the fore-gut there is a pair of "salivary" glands. Malpighian tubes have been found in some forms, i.e. females of *Eurypauropus spinosus*, but not in any examples, male or female, of *Pauropus husleyi*. Where present they open at the point of union of the mid-

and hind-guts. The generative organs in the female are very simple, and much like those of the Diplopoda. In the male they are highly complex, and unlike those of any known Arthropod in certain particulars. The wide, unpaired ovary extends nearly to the posterior end of the body. Anteriorly it passes into an oviduct which is unpaired throughout its length. The posterior portion of the duct is wide. The anterior, an abruptly narrowed tube, curves round the nerve-cord and opens by a single sub-medial orifice in the third segment. Just within the orifice there opens into the oviduct the short duct of a spherical receptaculum seminis. In the male the testis is never paired. Sometimes it is single, sometimes divided into an anterior and a posterior mass, and sometimes further constricted. It lies above the intestine in the posterior half of the body in the adult, but at least in the young in some cases, where as many as four divisions have been detected, its position is more lateral. Leading from the sperm masses there may be as many as three slender short ducts which soon expand into wider tubes. These tubes, regarded as seminal vesicles, after forming a complex of loops, coils and caecal prolongations, ultimately unite beneath the intestine in a single tube which passing forwards divides on each side of the alimentary canal to terminate in the two penes situated just behind the base of the second pair of complete legs, that is to say, in the leg of the third segment. Just at the root of the penis there is an accessory gland on the duct, and a little farther back a much larger glandular swelling.

The Paupropoda are divided into three rather sharply defined groups or families which may be briefly characterized as follows:—
Paupropodidae.—Head not covered by the first tergal plate. Anal segment not covered by the sixth tergal plate. Terga of the first ten body segments fused in couples. Tactile setae situated on the lateral portions of the terga which are neither sculptured nor spinous. (*Paupropus*, *Stylopaupropus*.)

Brachypaupropodidae.—Head and anal segment free and the terga smooth as in the last; but each of the double terga of the *Paupropodidae* divided into an anterior and posterior plate by a transverse band of membrane and each of these into a pair of plates by a longitudinal integumental strip. The tactile setae arising from the pleural area of the segments. (*Brachypaupropus*.)

Eurypaupropodidae.—Body wide and onisciform, the head and the anal segment concealed dorsally by the first and penultimate terga respectively. Terga fused as in the *Paupropodidae*, but thickly spinous or sculptured. The tactile setae situated beyond the edge of the terga, as in the *Brachypaupropodidae*. (*Eurypaupropus*.)

The genus *Paupropus* is probably world-wide in distribution, since it has been discovered in Europe, North and South America and in Siam. The two best known *Brachypaupropus* were found respectively in Italy and Austria. *Eurypaupropus* has representatives in North America and Europe. Examples of *Paupropus* are extremely agile, recalling the centipede *Lithobius* in their movements; those of *Eurypaupropus*, on the contrary, are extremely slow and quite comparable in lack of agility to the common mill-millipede. They are usually found in woods, under stones, fallen branches, dead leaves or other damp situations. They are believed to be vegetable feeders and are oviparous. The young upon hatching has four segments and three pairs of legs representing the first three pairs of ambulatory legs of the adult. The two last segments are apodous, of the first bears one pair of legs, and the second and third pairs. The young passes through four successive moults, and gradually acquires its full complement of segments and limbs.

CLASS SYMPHYLA.

Prosgonate Arthropods, differing in many important particulars from the Diplopoda and Scolopendrellae. The axis of the head lies in the same straight line as that of the body, as in the Chilopoda, and not at right angles to it as in the Diplopoda and Paupropoda. There are no eyes. The antennae are very long and many-jointed. Four pairs of gnathites attached to the under-side of the head have been detected. The first pair (mandibles) are two-jointed, as in many Diplopods. The second pair (maxillulae) are minute, one jointed and articulated to a median lobe or hypopharynx which is supported by two chitinous skeletal rods. The third pair (maxillae) consist of a long, basal segment terminating distally in two lobes; near the distal end of the basal segments there is externally minute one- or two-jointed processes, regarded as a palpus. Between the maxillulae lies a large, double plate (labium) maxillae of second pair which is pushed proximally to two rod-like basal segments and terminates distally in two pairs of short lobes. The body is long and narrow and bears on its dorsal side fifteen tergal plates. The first of these, immediately succeeding the head, is very short; the remainder are large and sub-equal in size. The adult animal is furnished with twelve pairs of walking legs, which, with the exception of the first pair, are alike in size and segmentation. Each consists of five segments, the distal of which is long and terminates with two powerful claws. The proximal segment bears internally a slender, cylindrical process which may be termed the paropod. It has been asserted that the segment bearing this paropod is in reality the second and that the true basal segment or coxa is embedded in the ventral integument. The legs of the first and second pairs never have the paropod, but they are invariably present in the remaining ten pairs. The legs of the first pair

are never more than four-jointed; they are always smaller than the others, and are sometimes reduced to mere bud-like processes. They belong to the first segment behind the head. The segment represented by the last tergal plate has no ambulatory limbs; but articulated to its posterior border is a pair of large, backwardly directed sclerites, which are perforated by the ducts of two spinning glands. These segments are regarded by some authors as the appendages of the last

After Latzel, *Die Myr. Ost. Ung. Mon. II. Pl. L. 1884.*

A. Mandibles or jaws of first pair of *Scolopendrella*; *md*¹, *md*², first and second segments; *t*, tendon; *c*, part of ventral skeleton of head.

B. Jaws of second pair; *mxl*, maxillula; *hyp*, hypopharynx.

C. Jaws of third and fourth pairs; *mx*, maxilla; *pmx*, maxillary palp; *lb*, *mx*, maxillary lobes; *lb*st, sternal plate of jaw of fourth pair or labium; *lb*¹, *lb*², first and second segments of labium. (Figs. A, B, C modified from Hansen, *Q.J.M.S.*, 47, pl. 1.)

D. Posterior end of body from below; *lg*¹¹, leg of 11th pair; *lg*¹², rudimentary leg of 12th pair of immature specimen; *sc*, exsertile sac; *ent*., parapod; *pap*, sensory papilla; *cerc*, cercus or spinning sclerite; *dl*, duct of silk gland; *a*, anus.

FIG. 15.

segment, and have been compared to the cercopods of insects. Attached also to the sides of the last segment in front of the spinning manilla there is a sub-conical papilla bearing an apical seta arising from a small clypeal depression. It has been suggested that these papillae also represent a pair of appendages. In that case the last segment must be double and bear two pairs of appendages. Thus there may be as many as fourteen pairs of trunk appendages. There are, however, only twelve pairs known to exist with certainty. These are represented by as many segments on the ventral side; but are numerically less by two than the terga. It is not known whether this very unusual phenomenon is to be accounted for by the addition of two supernumerary terga or by the exclamation of two pairs of appendages. The legs of the first pair are basally in contact; the rest are separated by a triangular sternal area.

At the base of the legs, with the exception of those of the first and last pair, there is a slit-like orifice recalling the coxal sacs of certain Diplopoda (e.g. *Lyssiopetalum*, *Platydesmus*). In internal anatomy the Symphyla closely resemble the Diplopoda. The alimentary canal is straight and simple, with a pair of "salivary" glands opening into the fore-gut, and a pair of malpighian tubes joining the hind-gut close to its communication with the mid-gut. There is a dorsal heart with segmental ostia and valves, and also a supra-neural vessel. The silk glands, which occur in both sexes, are situated as in *Lyssiopetalum*. The generative glands and ducts, which are paired, lie between the alimentary canal above and the normally constructed nerve-cord below, and are accompanied in the male by a pair of seminal vesicles; and the orifice lies ventrally in the third segment behind the head. A peculiarity in which the Symphyla differ from all "tracheate" arthropoda is the presence of a single pair of tracheal tubes opening by a pair of spiracles on the lower surface of the head behind the antennae.

The newly hatched young has a smaller number of appendages than the adult, the full complement of legs being reached only after successive moults.

The known species of Symphyla are referred to two genera, *Scolopendrella* and *Scutigrella*, which together constitute the family *Scolopendrellidae*. The chief difference between the two lies in the form of the tergal plates, which in *Scolopendrella* have the posterior



FIG. 16.—1. *Scutigrella* sp. highly magnified (slightly modified from Packard); a, spinning sclerites; b, b, legs of first pair; c, antennae. 2. One of the functional legs further enlarged (from Wood Mason), showing the five joints and terminal pair of claws; b, parapod.

angles produced and angular, whereas in *Scutigrella* they are rounded. Both genera are widely distributed and are represented in Europe, South America, Siam, &c. Large specimens reach a limit of between six and seven millimetres. They live in earth, beneath stones, dead leaves or fallen branches, and resemble diminutive centipedes (*Scolopendra* or *Lithobius*) both in appearance and movements. The Symphyla have frequently been compared with the Thysanurus Hexapoda, the parapods with their adjacent cersitile vesicles in *Scolopendrella* being very similar to the abdominal appendages and vesicles of such an insect as *Macchilis*; while the posterior spinning sclerites or cerci of the former bear much resemblance to the cercopods of *Japyx*. It must be remembered, however, that the spinning glands of certain Diplopods occupy the same position as those of the Symphyla and open upon papilliform processes of the last tergal plate, which are certainly not appendages. Hence, if the papillae are the homologues of the cerci in *Scolopendrella*, these cerci cannot be morphologically comparable to the cercopods of *Japyx* or other insects. But even if the full force of the arguments in favour of relationship between the Symphyla and the Hexapoda be admitted, the Symphyla, nevertheless, differ essentially from the Hexapoda in the anterior position of the generative orifice, and in the presence of twelve pairs of similar ambulatory limbs. (R. I. P.)

MILLOM, a market town in the Egremont parliamentary division of Cumberland, England, in the extreme south-west of the county, on the Furness railway. Pop. of urban district (1901), 10,426. The church of Holy Trinity, Early Norman and Decorated in date, is chiefly of interest for its curious pillars, alternately round and octagonal, and for a window in the north aisle, which has five lights, and is known, on account of its unique shape, as the "fish-window." A massive roodstone stands in the churchyard. Millom Castle, dating from shortly after the Conquest, was fortified in the 14th century by Sir John Huddleston, whose descendants held it until 1774. For centuries, they exercised the power of life and death; a stone stands where the gallows were formerly erected, and indicates that here they exercised *jura regalia*. Though strongly built, the castle was never of great size, and it has been largely dismantled. A fine carved staircase, however, still exists in the main chapel. In 1648 the Parliamentary forces besieged Millom Castle, and early in the 19th century its park was converted into farmland. In the neighbourhood of Millom there are blast furnaces and highly productive mines of red haematite ore. The deposit lies partly under the foreshore of the river Duddon, and a company has expended upwards of £120,000 upon a sea-wall and embankment to protect the mine from the sea.

MILLS, JOHN (d. 1736), English actor, was a member of the company at Drury Lane from 1695 almost uninterruptedly to the time of his death, playing and creating hundreds of parts. He was at his best in tragedy. His wife was an actress, and their son William—"the younger Mills"—was also an actor of some merit.

MILLS, ROGER QUARLES (1832-), American legislator, was born in Todd county, Kentucky, on the 30th of March 1832. He went to Texas in 1839, studied law, and was admitted to the bar by a special act of the legislature before he was twenty-one. He entered the Confederate army in 1861, took part as a private in the battle of Wilson's Creek, and as colonel commanded the Tenth Texas Infantry at Arkansas Post, Chickamauga (where he commanded a brigade during part of the battle), Missionary Ridge and Atlanta. He served in the national House of Representatives as a Democrat from 1873 to 1892 and in the Senate from 1892 to 1899. He made the tariff his special study, and was long recognized as the leading authority in Congress. As chairman of the Ways and Means Committee of the House of Representatives in 1887-1889 during President Cleveland's first administration, he led the fight for reform. From his committee he reported in April 1888 the "Mills Bill," which provided for a reduction of the duties on sugar, earthenware, glassware, plate glass, woollen goods and other articles, the substitution of *ad valorem* for specific duties in many cases, and the placing of lumber (of certain kinds), hemp, wool, flax, borax, tin plates, salt and other articles on the free list. This bill was passed by the Democratic House on the 21st of July, and was then so amended by a Republican Senate as to be unacceptable to the house. The tariff thus became the chief issue in the presidential campaign of 1888. In 1891 Mills was a candidate in the

Democratic caucus for Speaker of the house, but was defeated by Charles F. Crisp (1845-1896) of Georgia. During the free silver controversy he adhered to the Cleveland section of the Democratic party, and failed to be re-elected when his term in the Senate expired in 1899. He then retired to Corsicana, Texas, where he engaged in business and the practice of law.

MILLSTONE GRIT, in geology, a series of massive sandstones, grits and conglomerates with alternate shales, the whole resting directly upon the Carboniferous Limestone or upon intervening shales (Yoredale, Limestone Shales), usually in stratigraphical continuity. Its occasional coal-seams show that conditions of coal-formation had already begun. In Great Britain its outcrop extends from the Bristol Coalfield through South and North Wales to its fullest development in the north-midland counties, Lancashire and Yorkshire, and thence to Scotland, where the Roslin Sandstone of the Lothians and the Moor Rock of Lanark and Stirling are considered its equivalents. Characterized by grits and sandstones of the same general type, though individually variable, as sandbanks formed on the shoaling of the Carboniferous sea, yet often persistent over wide areas, the formation, estimated as 5000 ft. thick in Lancashire, contains typically the following grits in descending order: First, or Rough Rock; second, or Haslingden Flags (Lancashire); third, or Chatsworth Grit (the last two being the Middle Grits of Yorkshire); fourth and fifth, or Kinderscout Grits and the Shale Grits. The first and third, the most persistent, are often coarse and pebbly, like the Kinderscout Grits. In the north of England these grits lose their identity. In South Wales the Millstone Grit, immediately succeeding the Carboniferous Limestone, consists of 450 ft. of grit and shale, its upper member being the massive pebbly Farewell Rock. It extends into the Bristol Coalfield, though not recognized in the Devonshire Culm. In Ireland certain grey grits and flags are assigned to it.

In northern France and Belgium it loses its individuality and is merged in the Coal-measures. It reappears east of the Rhine, but is unrecognizable in the somewhat different Carboniferous succession of eastern Europe. In America the Pottsville Conglomerate, 1500 ft. thick in the south Appalachians, with workable coals, and widely unconformable upon the Mississippian, introduces the Pennsylvanian (Upper Carboniferous) system, and approximately represents the Millstone Grit of western Europe, as does the red conglomerate of Nova Scotia.

The shales of the Millstone Grit include thin beds of marine goniatites (*Glyphioceras bilingue*, *Gastrioceras carbonarium*), *Pterinopetia papyracea*, and *Lingula mytiloides*, while the grits contain *Lepidodendron*, *Stigmara* and calamites. In Scotland plants and estuarine fishes differ markedly above and below the Roslin Sandstone.

The English Millstone Grit produces a characteristic scenery of wild moorland plateaux, or alternations of shale-valleys and rugged grit-ridges. The grits furnish valuable building-stones and grindstones. They also afford an excellent water supply. (C. B. W.*)

MILLVILLE, a city of Cumberland county, New Jersey, U.S.A., on the Maurice river, 40 m. S. by E. of Philadelphia. Pop. (1890) 10,002; (1900) 10,583 (598 foreign-born); (1905, state census) 11,884; (1910) 12,451. It is served by the West Jersey & Seashore railway, by electric lines to Philadelphia, Bridgeton, Vineland and Fairton, and by schooners and small freight boats. Peaches and small fruit are cultivated extensively in the surrounding country. In the north part of the city is a large public park, in which a beautiful lake 3 m. long and about 1 m. wide has been formed by damming the river. Glass and moulding sand is found in the vicinity, and the city is engaged principally in the manufacture of glass (especially druggists' ware). The value of the city's factory products increased from \$2,513,433 in 1900 to \$3,719,417 in 1905, or 48%; and of the total value in 1905, \$2,332,614, or 62.7%, was the value of the glass products. Millville was incorporated as a town in 1801, was chartered as a city in 1866, and its charter was revised in 1877.

MILMAN, HENRY HART (1791–1868), English historian and ecclesiastic, third son of Sir Francis Milman, Bart., physician to George III., was born in London on the 10th of November 1791. Educated at Eton and at Brasenose College, Oxford, his university career was brilliant. He gained the Newdigate prize with a poem on the *Apollo Belvidere* in 1812, was elected a fellow of Brasenose in 1814, and in 1816 won the English essay prize with his *Comparative Estimate of Sculpture and Painting*. In 1816 he was ordained, and two years later was presented to the living of St Mary's, Reading. Milman had already made his appearance as a dramatic writer with his tragedy *Fazio* (produced on the stage under the title of *The Italian Wife*). He also wrote *Samor, the Lord of The Bright City*, the subject of which was taken from British legend, the "bright city" being Gloucester; but he failed to invest it with serious interest. In subsequent poetical works he was more successful, notably the *Fall of Jerusalem* (1820) and the *Martyr of Antioch* (1822). The influence of Byron is seen in his *Belshazzar* (1822). A tragedy, *Anne Boleyn*, followed in 1826; and Milman also wrote "When our heads are bowed with woe," and other hymns; an admirable version of the Sanskrit episode of Nala and Damayanti; and translations of the *Agamemnon* of Aeschylus and the *Bacchae* of Euripides. In 1821 he was elected professor of poetry at Oxford, and in 1827 he delivered the Bampton lectures on the character and conduct of the apostles as an evidence of Christianity. His poetical works were published in three volumes in 1839.

Turning to another field, Milman published in 1829 his *History of the Jews*, which is memorable as the first by an English clergyman which treated the Jews as an Oriental tribe, recognized sheikhs and amirs in the Old Testament, sifted and classified documentary evidence, and evaded or minimized the miraculous. In consequence, the author was violently attacked and his inevitable pre-empt was delayed. In 1835, however, Sir Robert Peel made him rector of St Margaret's, Westminster, and canon of Westminster, and in 1849 he became dean of St Paul's. By this time his unpopularity had nearly died away, and generally revered and beloved, he occupied a dignified and enviable position, which he constantly employed for the promotion of culture and in particular for the relaxation of subscription to ecclesiastical formularies. His *History of Christianity to the Abolition of Paganism in the Roman Empire* (1840) had been completely ignored; but widely different was the reception accorded to the continuation of his work, his great *History of Latin Christianity* (1855), which has passed through many editions. In 1838 he had edited Gibbon's *Decline and Fall of the Roman Empire*, and in the following year published his *Life of Gibbon*. Milman was also responsible for an edition of Horace, and when he died he had almost finished a history of St Paul's Cathedral, which was completed and published by his son, A. Milman (London, 1868), who also collected and published in 1879 a volume of his essays and articles. Milman died on the 24th of September 1868, and was buried in St Paul's Cathedral. By his wife, Mary Ann, a daughter of Lieut.-General William Cockell, he had four sons and two daughters. His nephew, Robert Milman (1816–1876), was bishop of Calcutta from 1867 until his death, and was the author of a *Life of Torquato Tasso* (1850).

See A. C. Tait, *Sermon in Memory of H. H. Milman* (London, 1868), and Arthur Milman, *H. H. Milman* (London, 1900). See also the *Memoirs of R. Milman, bishop of Calcutta*, by his sister, Frances Maria Milman (1879).

MILNE-EDWARDS, HENRY (1800–1885), French zoologist, the son of an Englishman, was born in Bruges on the 23rd of October 1800, but spent most of his life in France. At first he turned his attention to medicine, in which he graduated at Paris in 1823; but his passion for natural history soon prevailed, and he gave himself up to the study of the lower forms of animal life. One of his earliest papers (*Recherches anatomiques sur les crustacés*), which was presented to the Academy of Sciences in 1820, formed the theme of an elaborate and eulogistic report by G. Cuvier in the following year. It embodied the results of two dredging expeditions undertaken by him and his friend J. V.

Audouin during 1826 and 1828 in the neighbourhood of Granville, and was remarkable for clearly distinguishing the marine fauna of that portion of the French coast into four zones. Much of his original work was published in the *Annales des sciences naturelles*, with the editorship of which he was associated from 1834. Of his books may be mentioned the *Histoire naturelle de crustacés* (3 vols., 1837–1841), which long remained a standard work; *Histoire naturelle des coralliaires*, published in 1858–1860, but begun many years before; *Leçons sur la physiologie et l'anatomie comparée de l'homme et des animaux* (1857–1881), in 14 volumes; and a little work on the elements of zoology, originally published in 1834, but subsequently remodelled, which enjoyed an enormous circulation. He was appointed in 1841 professor of entomology at the muséum d'histoire naturelle, where twenty-one years later he succeeded Geoffroy Saint-Hilaire in the chair of zoology. The Royal Society in 1856 awarded him the Copley medal in recognition of his zoological investigations. He died in Paris on the 29th of July 1885. His son, Alphonse Milne-Edwards (1835–1900), who became professor of ornithology at the muséum in 1876, devoted himself especially to fossil birds and deep-sea exploration.

MILNER, ALFRED MILNER, VISCOUNT (1854–), British statesman and colonial administrator, was born at Bonn on the 23rd of March 1854, the only son of Charles Milner, M.D., whose wife was a daughter of Major-General Ready, sometime governor of the Isle of Man. His paternal grandfather, an Englishman, settled in Germany and married a German lady; and their son, Charles Milner, practised as a physician in London and became later Reader in English at Tübingen University. Alfred Milner was educated first at Tübingen, then at King's College, London, and under Jewett as a scholar of Balliol College, Oxford, from 1872 to 1876. He graduated in 1877, with a first class in classics, having won the Hertford, Craven, Eldon and Derby scholarships, and was elected to a fellowship of New College. At Oxford he formed a close friendship with Arnold Toynbee, and was associated with his schemes of social work; and subsequently he wrote a tribute to his friend, *Arnold Toynbee: a Reminiscence* (1895). In 1881 he was called to the bar at the Inner Temple and joined the staff of the *Pall Mall Gazette* under John Morley, becoming assistant editor under W. T. Stead. In 1885 he abandoned journalism, and became Liberal candidate for the Harrow division of Middlesex at the general election, but was defeated. He acted as private secretary to Mr (afterwards Lord) Goschen, and in 1887, when Goschen became chancellor of the exchequer, was appointed his principal private secretary. It was by Goschen's influence that in 1889 he was made under-secretary of finance in Egypt. He remained in Egypt four years, his period of office coinciding with the first great reforms, after the danger of bankruptcy had been avoided. Milner returned to England in 1892, and was appointed chairman of the Board of Inland Revenue, being made C.B. in 1894 and K.C.B. in 1895. Shortly after his return to England he published his *England in Egypt*, which at once became the authoritative account of the work done since the British occupation.

Sir Alfred Milner remained at the Board of Inland Revenue until 1897. He was regarded as one of the clearest-headed and most judicious officials in the British service, and his position as a man of moderate Liberal views, who had been so closely associated with Goschen at the Treasury, Cromer in Egypt and Hicks-Beach (Lord St Aldwyn) and Sir W. Harcourt while at the Inland Revenue, marked him out as one in whom all parties might have confidence. The moment for testing his capacity in the highest degree had now come. In April Lord Rosmead resigned his posts of high commissioner for South Africa and governor of Cape Colony. The situation resulting from the Jameson raid (see TRANSVAAL and SOUTH AFRICA) was one of the greatest delicacy and difficulty, and Mr Chamberlain, now colonial secretary, selected Milner as Lord Rosmead's successor. The choice was cordially approved by the leaders of the Liberal party, and warmly recognized at a farewell dinner presided over by Mr Asquith (March 28th, 1897). The

appointment was avowedly made in order that an acceptable British statesman, in whom public confidence was reposed, might go to South Africa to consider all the circumstances, and to formulate a policy which should combine the upholding of British interests with the attempt to deal justly with the Transvaal and Orange Free State governments.

Sir Alfred Milner reached the Cape in May 1897, and after the difficulties with President Kruger over the Aliens' Law had been patched up he was free by August to make himself personally acquainted with the country and peoples before deciding on the lines of policy to be adopted. Between August 1897 and May 1898 he travelled through Cape Colony, the Bechuanaland Protectorate, Rhodesia and Basutoland. The better to understand the point of view of the Cape Dutch and the burghers of the Transvaal and Orange Free State, Milner also during this period learned both Dutch and the South African "Taal." He came to the conclusion that there could be no hope of peace and progress in South Africa while there remained the "permanent subjection of British to Dutch in one of the Republics." He also realized—as was shown by the triumphant re-election of Mr Kruger to the presidency of the Transvaal in February 1898—that the Pretoria government would never on its own initiative redress the grievances of the "Uitlanders." In a speech delivered at Graaf Reinet, a Bond stronghold, on the 3rd of March 1898, he made it clear that he was determined to secure freedom and equality for the British subjects in the Transvaal, and he urged the Dutch colonists to induce the Pretoria government to assimilate its institutions, and the temper and spirit of its administration, to those of the free communities of South Africa. The effect of this pronouncement was great, and it alarmed the Afrikaners, who at this time viewed with apprehension the virtual resumption by Cecil Rhodes of his leadership of the Progressive (British) party at the Cape. That Milner had good grounds for his view of the situation is shown in a letter written (March 11) by Mr J. X. Merriman to President Steyn of the Free State: "The greatest danger (wrote Mr Merriman) lies in the attitude of President Kruger and his vain hope of building up a State on a foundation of a narrow unenlightened minority, and his obstinate rejection of all prospect of using the materials which lie ready to his hand to establish a true republic on a broad liberal basis. Such a state of affairs cannot last. It must break down from inherent rottenness." Though this was recognized by the more far-seeing of the Bond leaders, they were ready to support Kruger, whether or not he granted reforms, and they sought to make Milner's position impossible. His difficulties were increased when at the general election in Cape Colony the Bond obtained a majority. Acting strictly in a constitutional manner, Milner thereupon (Oct. 1898) called upon Mr W. P. Schreiner to form a ministry, though aware that such a ministry would be opposed to any direct intervention of Great Britain in the Transvaal. Convinced that the existing state of affairs, if continued, would end in the loss of South Africa by Britain, Milner came to England in November 1898. He returned to the Cape in February 1899 fully assured of the support of Mr Chamberlain, though the government still clung to the hope that the moderate section of the Cape and Free State Dutch would induce Kruger to deal justly with the Uitlanders. He found the situation more critical than when he had left, ten weeks previously. Johannesburg was in a ferment, while General Sir William Butler, who acted as high commissioner in Milner's absence, had allowed it to be seen that he did not take a favourable view of the Uitlander grievances. On the 4th of May Milner penned a memorable despatch to the Colonial Office, in which he insisted that the remedy for the unrest in the Transvaal was to strike at the root of the evil—the political impotence of the injured. "It may seem a paradox," he wrote, "but it is true that the only way for protecting our subjects is to help them to cease to be our subjects." The policy of leaving things alone only led from bad to worse, and "the case for intervention is overwhelming." Milner felt that only the enfranchisement of the Uitlanders in the Transvaal

would give stability to the South African situation. He had not based his case against the Transvaal on the letter of the Conventions, and regarded the employment of the word "sovereignty" merely as an "etymological question," but he realized keenly that the spectacle of thousands of British subjects in the Transvaal in the condition of "helots" (as he expressed it) was undermining the prestige of Great Britain throughout South Africa, and he called for "some striking proof" of the intention of the British government not to be ousted from its predominant position. This despatch was telegraphed to London, and was intended for immediate publication; but it was kept private for a time by the home government. Its tenor was known, however, to the leading politicians at the Cape, and at the instance of J. H. Hofmeyr a conference was held (May 31–June 5) at Bloemfontein between the high commissioner and the president of the Transvaal. Milner then made the enactment by the Transvaal of a franchise law which would at once give the Johannesburgers a share in the government of the country his main, and practically his only, demand. The conference ended without any agreement being reached, and the diplomatic discussion which followed (see TRANSVAAL) gradually became more and more contentious. When war broke out, October 1899, Milner rendered the military authorities "unfailing support and wise counsels," being, in Lord Roberts's phrase "one whose courage never faltered."

In February 1901 he was called upon to undertake the administration of the two Boer states, both now annexed to the British Empire, though the war was still in progress. He thereupon resigned the governorship of Cape Colony, while retaining the post of high commissioner. The work of reconstructing the civil administration in the Transvaal and Orange River Colony could only be carried on to a limited extent while operations continued in the field. Milner therefore returned to England to spend a "hard-begged holiday," which was, however, mainly occupied in work at the Colonial Office. He reached London on the 24th of May 1901, had an audience with the king on the same day, was made a G.C.B. and privy councillor, and was raised to the peerage with the title of Baron Milner of St James's and Cape Town. Speaking next day at a luncheon given in his honour, answering critics who alleged that with more time and patience on the part of Great Britain war might have been avoided, he asserted that what they were asked to "conciliate" was "panoplied hatred, insensate ambition, invincible ignorance." Meanwhile the diplomacy of 1899 and the conduct of the war had caused a great change in the attitude of the Liberal party in England towards Lord Milner, whom Mr Leonard Courtney even characterized as "a lost mind." A violent agitation for his recall, in which Sir Henry Campbell-Bannerman joined, was organized, but without success, and in August he returned to South Africa, where he plunged into the herculean task of remodelling the administration. In the negotiations for peace he was associated with Lord Kitchener, and the terms of surrender, signed at Pretoria on the 31st of May 1902, were drafted by him. In recognition of his services he was, on the 15th of July, made a viscount.

Immediately following the conclusion of peace Milner published (June 21) the Letters Patent establishing the system of crown colony government in the Transvaal and Orange River colonies, and exchanging his title of administrator to that of governor. The reconstructive work necessary after the ravages of the war was enormous. He provided a steady revenue by the levying of a tax of 10% on the annual net produce of the gold mines, and devoted special attention to the repatriation of the Boers, land settlement by British colonists, education, justice, the constabulary, and the development of railways. While this work of reconstruction was in progress domestic politics in England were convulsed by the tariff reform movement and Mr Chamberlain's resignation. Milner, who was then spending a brief holiday in Europe, was urged by Mr Balfour to take the vacant post of secretary of state for the colonies. This offer he declined (Oct. 1, 1903), considering it more important to complete his work in South Africa, where economic depression

was becoming pronounced. He was back in Johannesburg in December 1903, and had to consider the crisis in the gold-mining industry caused by the shortage of native labour. Reluctantly he agreed, with the assent of the home government, to the proposal of the mineowners to import Chinese coolies on a three years' contract, the first batch of Chinese reaching the Rand in June 1904.

In the latter part of 1904 and the early months of 1905 Lord Milner was engaged on the elaboration of a scheme to provide the Transvaal with a system of "representative" government, a half-way house between crown colony administration and that of self-government. Letters patent providing for representative government were issued on the 31st of March 1905.¹ For some time he had suffered in health from the incessant strain of work, and he determined to retire. He left Pretoria on the 2nd of April and sailed for Europe on the following day. Speaking at Johannesburg on the eve of his departure, he recommended to all concerned the promotion of the material prosperity of the country and the treatment of Dutch and British on an absolute equality. Having referred to his share in the war, he added: "What I should prefer to be remembered by is a tremendous effort subsequent to the war not only to repair the ravages of that calamity but to re-start the colonies on a higher plane of civilization than they have ever previously attained." He left South Africa while the economic crisis was still acute and at a time when the voice of the critic was audible everywhere; but, in the words of the colonial secretary (Mr Alfred Lyttelton) he had in the eight eventful years of his administration "laid deep and strong the foundation upon which a united South Africa would arise to become one of the great states of the empire." On his return home his university honoured him with the honorary degree of D.C.L.

Experience in South Africa had shown him that underlying the difficulties of the situation there was the wider problem of imperial unity. In his farewell speech at Johannesburg he concluded with a reference to the subject. "When we who call ourselves Imperialists talk of the British Empire we think of a group of states bound, not in an alliance—for alliances can be made and unmade—but in a permanent organic union. Of such a union the dominions of the sovereign as they exist to-day are only the raw material." This thesis he further developed in a magazine article written in view of the colonial conference held in London in 1907. He advocated the creation of a permanent deliberative imperial council, and favoured preferential trade relations between the United Kingdom and the other members of the empire; and in later years he took an active part in advocating the cause of tariff reform and colonial preference.

In March 1906 a motion censuring Lord Milner for an infraction of the Chinese labour ordinance, in not forbidding light corporal punishment of coolies for minor offences in lieu of imprisonment, was moved by a Radical member of the House of Commons. On behalf of the Liberal government an amendment was moved, stating that "This House, while recording its condemnation of the flogging of Chinese coolies in breach of the law, desires, in the interests of peace and conciliation in South Africa, to refrain from passing censure upon individuals." The amendment was carried by 355 votes to 135. As a result of this left-handed censure, a counter-demonstration was organized, led by Sir Bartle Frere, and a public address, signed by over 370,000 persons, was presented to Lord Milner expressing high appreciation of the services rendered by him in Africa to the crown and empire.

See also E. B. Iwan-Müller, *Lord Milner and South Africa* (London, 1902); W. B. Worfield, *Lord Milner's Work in South Africa* (London, 1906); W. T. Stead, "Sir Alfred Milner," in *The Review of Reviews*, vol. xii. (1899); and the bibliography to SOUTH AFRICA.

MILNER, JOSEPH (1744-1797), English evangelical divine, was born at Leeds and educated at Leeds grammar-school and Cambridge. After taking his degree he went to Thorparch,

¹ Owing to the advent of a Liberal ministry in England, December 1905, this scheme remained inoperative (see TRANSVAAL: *History*).

Yorkshire, as curate and assistant schoolmaster. Subsequently he became head master of Hull grammar-school, and in 1768 he was chosen afternoon lecturer at Holy Trinity church, Hull. He became a strong supporter of the evangelical movement of the period, and greatly contributed to its success in Hull. In addition to his work as head master, he took charge of North Ferriby parish, about 9 m. from Hull. His published works include essays and numerous sermons, but his best known work is the *History of the Church of Christ* (London, 1794-1809). He lived to complete the first three volumes, and two more were added by his brother, Isaac Milner (1750-1820), dean of Carlisle, who re-edited the whole work in 1810.

MILNGAVIE (locally pronounced Millguy), a police burgh of Dumbartonshire, Scotland. Pop. (1901), 3481. It lies 6 m. N.N.W. of Glasgow by the North British railway. The chief industries include bleach-fields, dye-works, a distillery and a paper mill; but the town is largely a residential quarter for Glasgow business men. Close to the town are two reservoirs, Mugdock (62 acres) and Craigmaddie (88 acres), in which is stored the water from Loch Katrine. Mugdock Castle, 1½ m. N. of Milngavie, is an old stronghold of the Grahams; in Baldernock parish, about 2 m. E., stands a cromlech, called "the Auld Wives' Lift" (400 ft. high), commanding a fine view of the lands between the Forth and Clyde. Dougalston Loch, ¼ m. S.E., contains several rare aquatic plants.

MILÓ, or **MILON**, of Crotona, Greek athlete, lived about the end of the 6th century B.C. He was six times crowned at the Olympic games and six times at the Pythian for wrestling, and was famous throughout the civilized world for his feats of strength—such as carrying an ox on his shoulders through the stadium at Olympia. In his native city he was much honoured, and he commanded the army which defeated the people of Sybaris in 511. The traditional account of his death is often used to point a moral: he found a tree which some woodcutters had partially split with a wedge, and attempted to rend it asunder; but the wedge fell out, and the tree closed on his hand, imprisoning him till wolves came and devoured him. His name became proverbial for personal strength (Diod. Sic. xii. 9; Pausanias vi. 14; Strabo vi. 263; Herodotus iii. 137).

MILÓ, TITUS ANNIUS, Roman political agitator, was the son of C. Papius Celsus, but was adopted by his mother's father, T. Annius Lucius. He joined the Pompeian party, and organized bands of mercenaries and gladiators to support the cause by public violence in opposition to P. Clodius, who gave similar support to the democratic cause. Milo was tribune of the plebs in 57 B.C. He took a prominent part in bringing about the recall of Cicero from exile, in spite of the opposition of Clodius. In 53, when Milo was candidate for the consulship and Clodius for the praetorship, the two leaders met by accident on the Appian Way at Bovillae and Clodius was murdered (January 52). Milo was impeached; his guilt was clear, and his enemies took every means of intimidating his supporters and his judges. Cicero was afraid to speak, and the extant *Pro Milone* is an expanded form of the unspoken defence. Milo went into exile at Massilia, and his property was sold by auction. He joined M. Caelius Rufus in 48 in his rising against Caesar, but was slain near Thurii in Lucania. His wife was Fausta, daughter of the dictator Sulla.

MILÓ OF GLOUCESTER, lord of Brecknock and earl of Hereford (d. 1143), was the son of Walter of Gloucester, who appears as sheriff of that county between 1104 and 1121. Milo succeeded his father about the latter year. He was high in the service of Henry I. between 1130 and 1135, and combined the office of sheriff with that of local justiciar for Gloucestershire. After the death of Henry I. he declared for Stephen, at whose court he appears as constable in 1136. But in 1139, when the empress Matilda appeared in England, he declared for her, and placed the city of Gloucester at her disposal; he was further distinguished by sacking the royalist city of Worcester and reducing the county of Hereford. In 1141, at Matilda's coronation, he was rewarded with the earldom of

Hereford. He remained loyal to the empress after her defeat at Winchester. John of Salisbury classes him with Geoffrey de Mandeville and others who were *non tam comites regni quam hostes publici*. The charge is justified by his public policy; but the materials for appraising his personal character do not exist.

See the *Continuation of Florence of Worcester* (ed. B. Thorpe, 1848-1849); the Cartulary of Gloucester Abbey (Rolls series); and J. H. Round's *Geoffrey de Mandeville* (1892).

MILORADOVICH, MICHAEL ANDRIJEVICH, COUNT (1770-1825), Russian general, saw service under Suvarov in the wars against Turkey and Poland, and in the campaign of Italy and Switzerland (1799) earned much distinction as a commander of advanced troops. In 1805, having attained the rank of lieutenant-general, he served under Kutusov in the campaign of Austerlitz, taking part in the actions of Enns and Krems and in the decisive battle of the 2nd of December, in which his column held the Pratzen heights. In the Turkish War he distinguished himself at Giurgevo (1807). Promoted general of infantry in 1810, he commanded a corps at Borodino, and subsequently inflicted the defeat of Tarutino (or Winkovo) on Murat, king of Naples (October 18, 1812). His corps was one of those most active in the pursuit of Napoleon's *Grande Armée*, and in 1813 he led the rear-guard of the Allies after their earlier defeats. At the victory of Kulm he was present in command of a Russian-Prussian corps, which he led at Leipzig and in the campaign of 1814. From 1818 to the time of his death he was military governor of St Petersburg. He perished in the popular outbreak in the capital, on the 26th (14th O.S.) of December 1825.

MILOSH OBRENOVIĆ I. (1780-1860), prince of Serbia, founder of the Obrenovich dynasty, was born in 1780 of poor Servian peasants. When he later became prince of Serbia he used to tell how for a penny a day he drove cattle from Serbia to Dalmatia. His half-brother, Milan Obrenovich, who had developed into a successful exporter of cattle and pigs into Austria, associated him in his own export trade and otherwise supported him. Partly from gratitude and partly because the family name of his half-brother was already honourably known in the country, Milosh adopted that name as his own, and called himself Obrenovich, instead of Theodorovich. Kara-george, the leader of the first Servian revolution against the Turks, appointed Milosh Obrenovich in 1807 a voyvode, i.e. district commander of the national army and civil administrator. As such he distinguished himself in many battles, and was reputed a wise and energetic administrator and a just judge. When in 1813 the Turks under the Grand Vizier Khurshid occupied Serbia, and Kara-george and almost all his voyvodes left the country for Austria, Milosh, although strongly advised to follow their example, refused to do so. He remained in the country, surrendered to the Turks, and was recognized by them as the voyvode of Rudnik (Central Serbia). As he was then practically the only chief of the nation, the Turks called him to Belgrade, where he was kept through the year 1814 as a hostage. But he found means to prepare a new rising of the Servians against the Turks, and on Palm Sunday 1815 he appeared with his voyvode's standard before the people round the small church of Takovo, and started the second and successful insurrection. Not so much by his victories on the battlefields as by his clever exploitation of the international difficulties of Turkey, and of the known weakness of the Turkish pashas for "bakshesh"—no doubt also by his statesmanlike moderation—he succeeded in less than two years in obtaining from the Porte the practical recognition of the Servian people's right to self-government. The National Assembly in 1817 elected him prince of Serbia.

From that year began the organization of Serbia by the Servians as an autonomous province of the Ottoman Empire. But its existence as such rested on no safe and legal basis, except on the readiness of the Servians to defend it with all their might and on the goodwill of the sultan and his "Sublime Porte." Milosh therefore worked hard to obtain some sort

of international recognition of the semi-independent status of Serbia. Russia came to his assistance, and by the Treaty of Adrianople of 1829 the Porte engaged formally to grant Serbia full autonomy. This engagement was somewhat developed in the Hatti-sherif of 1830, which added to Serbia three districts (Krushevats, Alexinats, Zaechar), acknowledged her full autonomy, recognized Milosh as hereditary prince of Serbia, and declared that the Turks in Serbia could have properties and live only in fortified places where there were Turkish garrisons, and not in other towns and villages. Milosh won for his family the hereditary right to the throne of Serbia without the co-operation of Russia. The creation of a hereditary dynasty in Serbia was outside the Russian Balkan policy of that time, and this great and independent success of Milosh was the first cause of Russia's dissatisfaction with him. The second cause was that, yielding to the pressure exercised on him by his own people, he gave the country a constitution without asking "the protector of Serbia," the tsar, for his approval of the step. The third cause was that Milosh consistently resented the interference of Russia in the internal affairs of the principality. The climax of his misdeeds, from the Russian point of view, was that on the occasion of his visit to the Sultan Mahmud II, in 1836 he persuaded the British ambassador, Lord Ponsoby, that it would be useful to establish a British consulate in Belgrade. The first British consul in Serbia, Colonel Hodges, became speedily an intimate friend of Prince Milosh, who—probably under his new friend's influence—began to agitate to replace the exclusive protectorate of Russia by the joint protectorate of all the great Powers of Europe. The cabinet of St Petersburg now decided to remove Milosh from the throne of Serbia, and, supported by the Russian consul-general, the leaders of the Servian opposition, who posed as champions of a constitutional system, succeeded in forcing him to abdicate in 1839. After his abdication Milosh lived mostly on his estates in Rumania, or in Vienna. In December 1858 the National Assembly of Serbia, having dethroned Prince Alexander Kara-georgevich, recalled Milosh to the throne of Serbia. Milosh came, accompanied by his son Michael, and began to reign in his own old fashion; but death closed his activity on the 14th (27th N.S.) of September 1860. He was buried in the cathedral of Belgrade. (C. M.)

MILTIADES, the name of two Athenian statesmen and generals of a family (the Philadae) of Aeginetan origin, which claimed descent from Aecaeus.

1. **MILTIADES** (6th century B.C.), the son of Cypselus, a prominent opponent of Peisistratus. According to Herodotus (vi. 36, 37) he led a colony to the Thracian Chersonese at the request of the Dolonians, who, hard pressed by the Absinthians (or Apsinthians), were advised by the Delphian oracle to invite to their country the man who should first show them hospitality after leaving the temple. Since, however, the Athenians had from c. 600-500 B.C. held Sigeum in the Troad, whence they had fought against Mitylene, it is probable that the Dolonians appealed for help to Athens, and that Peisistratus took the opportunity of getting rid of one of his chief opponents by sending Miltiades. He became "tyrant" of the Chersonesus, which he fortified by a wall across the isthmus from Cardia to Pactya. He was captured by the people of Lampsacus, but released on the intercession of Croesus of Lydia. He was succeeded by Stesagoras, son of his half-brother, Cimon.

2. **MILTIADES** (died c. 488 B.C.), the victor of Marathon, was another son of Cimon. On the death of Stesagoras, he was sent to the Chersonese (? about 518-516) by Hippias—no doubt to support Hegesistratus at Sigeum (see PEISISTRATUS). He entrapped and imprisoned the chief men of Chersonesus, which was then in a turbulent condition, and strengthened himself by an alliance with Hegesipyle, daughter of the Thracian prince Olorus (Herod. vi. 39). He led a contingent in the Scythian expedition of Darius Hystaspis and, according to Herodotus, advised the leaders who were left at the Danube bridge to destroy it and leave Darius to his fate. This story is improbable, as Darius left Miltiades in possession of the Chersonese for some

twenty years longer, though Persian forces were frequently in the neighbourhood. Miltiades was, according to Herodotus, expelled by Scythian invaders, but was brought back by the Dolonians, and subsequently captured Lemnos and Imbros for Athens from the so-called Pelagias inhabitants, who were Persian dependents. Having thus (probably) incurred the enmity of Darius, Miltiades fled to Athens on the approach of the Persians under Datis and Artaphernes, leaving his son Metiochus a prisoner in Persian hands, and was at once impeached unsuccessfully on the charge of tyranny in the Chersonese.¹ Possibly the story of his having tried to destroy the Danube bridge was invented or exaggerated at this time as an argument in his favour (see Grote, *History of Greece*, i vol., ed. 1907, p. 119 note). Since, however, Herodotus almost certainly relied on Alcmaeonid tradition, which was hostile to Miltiades, the whole story is uncertain; the statement that he fled before a Scythian invasion is especially improbable. If Miltiades really recommended the destruction of the bridge, we may infer that the Herodotean story of his flight before the Scythians is a misunderstanding of the fact that his residence in Chersonese after the Scythian invasion was insecure and not continuous.

On the approach of the Persians Miltiades was made one of the ten Athenian generals, and it was on his advice that the polemarch Callimachus decided to give battle at Marathon (*q.v.*). Subsequently he used his influence with the Athenians to induce them to give him a fleet of seventy ships without any indication of his object (Herod. vi. 132-136). Cornelius Nepos (*Miltiades*, c. vii.), probably on good authority (? Ephorus), states that he had a commission to regain control over the Aegean. No doubt his object was to establish an outer line of defence against future Persian aggression. Herodotus says that, having besieged Paros vainly for nearly a month, he made a secret visit to Timo, a priestess of Demeter in Paros, with a view to the betrayal of the island, and being compelled to flee wounded himself severely in attempting to leap a fence (but see Ephorus in *Fragm. hist. gr.* 107).

On his return to Athens he was impeached by Xanthippus, who was allied by marriage to the Alcmaeonids, on the ground that he had "deceived the people," and only escaped on the strength of his past services with a fine of 50 talents. The facts of the trial and the charge are difficult to recover, nor do we know why the siege was raised. Some authorities hold that he was bribed to this course, and hence that the charge was one of treason; others suggest that he retired in the belief that a Persian fleet was approaching. All that is known is that he died of his wound (480-488), without paying the fine, which was paid subsequently by his son Cimon (*q.v.*). He appears to have been a man of strong determination and great personal courage, of a type characteristic of the pre-Cleisthenic constitution. His absence in the Chersonese during the first years of the new democracy (508-493?) and his patrician lineage account naturally for the difference which existed between him and the popular leaders—Themistocles and Aristides.

See the passages of Herodotus and Cornelius Nepos, quoted above, and histories of Greece. On the Parian expedition and the trial, R. W. Macan, *Herodotus iv.-vi.*, vol. 2, appendix xi.; on the foreign policy of Miltiades see THEMISTOCLES. (J. M. M.)

MILTON, JOHN (1608-1674), English poet, was born in Bread Street, Cheapside, London, on the 9th of December 1608. His father, known as Mr John Milton of Bread Street, scrivener, was himself an interesting man. He was a native of Oxfordshire, the son of a Richard Milton, yeoman of Stanton-St-John's, one of the sturdiest adherents to the old Roman Catholic religion in his district, and was educated at Christ Church, Oxford, where he turned Protestant. According to the poet's earliest biographer, John Milton senior was disinherited in the beginning of Queen Elizabeth's reign for reading the Bible. With a good education and good abilities, especially in music, he may have lived for some time in London by musical teaching and practice.

¹ So Herodotus; but the story is difficult to believe in view of the fact that the family of Miltiades was distinctively *μυοτίπιδας*. Possibly the trial is merely a hostile version of the ordinary test of a man's qualification for office (*δοκιμασία*).

Not till 1595, at all events, when he must have been long past the usual age of apprenticeship, do we hear of his preparation for the profession of a scrivener; and not till February 1599-1600, when he was about thirty-seven years of age, did he become a qualified member of the Scriveners' Company. It was then that he set up his "house and shop" at the sign of the Spread Eagle in Bread Street, and began his business of drawing up wills, marriage-settlements, and the like, with such related business as that of receiving money from clients for investment and lending it out to the best advantage. It was at the same time that he married, not, as stated by Aubrey, a lady named Bradshaw, but Sarah Jeffrey, one of the two orphan daughters of a Paul Jeffrey, of St Swithin's, London, "a citizen and merchant-taylor," originally from Essex, who had died before 1583. At the date of her marriage she was about twenty-eight years of age. Six children were born to the scrivener and his wife, of whom three survived infancy—Anne, who married Edward Phillips; John, the poet; and Christopher (1615-1693), who was knighted and made a judge under James II.

The first sixteen years of Milton's life, coinciding exactly with the last sixteen of the reign of James I., associate themselves with the house in Bread Street. His father, while prospering in business, continued to be known as a man of "ingenious" tastes, and acquired distinction in the London musical world of that time. He contributed a madrigal to Thomas Morley's *Triumph of Oriana* (1601), four motets to Sir William Leighton's *Tears and Lamentations of a Sorrowful Soul* (1614), and some hymn tunes—one of which, "Yor," is still in common use—in Thomas Ravenscroft's *Whole Book of Psalms* (1621). Music was thus a part of the poet's domestic education from his infancy. Again and again Milton speaks with gratitude and affection of the ungrudging pains bestowed by his father on his early education. "Both at the grammar school and also under other masters at home," is the statement in one passage, "he caused me to be instructed daily." When Milton was ten years of age his tutor was Thomas Young (1587-1655), a Scottish divine, who afterwards became master of Jesus College, Cambridge. Young's tutorage lasted till 1622, when he accepted the pastorage of the congregation of English merchants in Hamburg. Already, however, for a year or two his teaching had been only supplementary to the education which the boy was receiving by daily attendance at St Paul's public school, close to Bread Street. The headmaster of the school was Alexander Gill, an elderly Oxford divine, of high reputation for scholarship and teaching ability. Under him, as usher or second master, was his son, Alexander Gill the younger, also an Oxford graduate of scholarly reputation, but of blustering character. Milton's acquaintanceship with this younger Gill, begun at St Paul's school, led to subsequent friendship and correspondence. Far more affectionate and intimate was the friendship formed by Milton at St Paul's with his schoolfellow Charles Diodati, the son of an Italian physician, Dr Theodore Diodati, a naturalized Englishman settled in London, and much respected, both on his own account and as being the brother of the famous Protestant divine, Jean Diodati of Geneva. Young Diodati, who was destined for his father's profession, left the school for Trinity College, Oxford, early in 1623; but Milton remained till the end of 1624. In that year his elder sister, Anne, married Edward Phillips, a clerk in the Government office called the Crown Office in Chancery.

Milton had then all but completed his sixteenth year, and was as scholarly, as accomplished and as handsome a youth as St Paul's school had sent forth. We learn from himself that his exercises "in English or other tongue, prosing or versing, but chiefly this latter," had begun to attract attention even in his boyhood. Of these poems the only specimens that now remain are two copies of Latin verses, preserved in a commonplace book of his (printed by the Camden Society in 1877), and his "Paraphrase on Psalm CXIV" and his "Paraphrase on Psalm CXXXVI." At the age of sixteen years and two months, Milton was entered as a student of Christ's College, Cambridge.

in the grade of a "Lesser Pensioner," and he matriculated two months later, on the 9th of April 1625. The master of Christ's was Dr Thomas Bainbridge; and among the thirteen fellows were Joseph Meade, still remembered as a commentator on the Apocalypse, and William Chappell, afterwards an Irish bishop. It was under Chappell's tutelage that Milton was placed when he first entered the college. At least three students who entered Christ's after Milton, but during his residence, deserve mention. One was Edward King, a youth of Irish birth and high Irish connexions, who entered in 1626, at the age of fourteen, another was John Cleveland, afterwards known as royalist and satirist, who entered in 1627; and the third was Henry More, subsequently famous as the Cambridge Platonist, who entered in 1631, just before Milton left. Milton's own brother, Christopher, joined him in the college in February 1630-1631, at the age of fifteen.

Milton's academic course lasted seven years and five months, bringing him from his seventeenth year to his twenty-fourth. The first four years were his time of undergraduateship. It was in the second of these—the year 1626—that there occurred the quarrel between him and his tutor, Chappell, which Dr Johnson, making the most of a lax tradition from Aubrey, magnified into the supposition that Milton may have been one of the last students in either of the English universities that suffered the indignity of corporal punishment. The legend deserves no credit; but it is certain that Milton, on account of some disagreement with Chappell, left college for a time, though he did not lose his term; and that when he did return, he was transferred from the tutelage of Chappell to that of Nathaniel Tovey. From the first of the Latin elegies one infers that the cause of the quarrel was some outbreak of self-assertion on Milton's part. We learn indeed, from words of his own elsewhere, that it was not only Chappell and Bainbridge that he had offended by his independent demeanour, but that, for the first two or three years of his undergraduateship, he was generally unpopular, for the same reason, among the younger men of his college. They had nicknamed him "the Lady"—a nickname which the students of the other colleges took up, converting it into "the Lady of Christ's"; and, though the allusion was chiefly to the peculiar grace of his personal appearance, it conveyed also a sneer at what the rougher men thought his unusual prudishness, the haughty fastidiousness of his tastes and morals. A change in this state of things had certainly occurred before January 1628-1629, when, at the age of twenty, he took his B.A. degree. By that time his intellectual pre-eminence had come to be acknowledged. His reputation for scholarship and literary genius, extraordinary even then, was more than confirmed during the remaining three years and a half of his residence in Cambridge. A fellowship in Christ's which fell vacant in 1630 would undoubtedly have been his had the election to such posts depended then absolutely on merit. As it was, the fellowship was conferred, by royal favour on Edward King, his junior in college standing by sixteen months. In July 1632 Milton completed his career at the university by taking his M.A. degree. Tradition still points out Milton's rooms at Christ's College. They are on the first floor on the first stair on the north side of the great court.

Of Milton's skill at Cambridge, in what Wood calls "the collegiate and academical exercises," specimens remain in his *Prolesiones quaedam oratoriae*. They consist of seven rhetorical Latin essays, generally in a whimsical vein, delivered by him, either in the hall of Christ's College or in the public university schools. To Milton's Cambridge period belong four of his Latin "Familiar Epistles," and the greater number of his preserved Latin poems, including: (1) the seven pieces, written in 1626, which compose his *Elegiarum liber*, two of the most interesting of them addressed to his friend, Charles Diodati, and one to his former tutor, Young, in his exile at Hamburg; (2) the five short Gunpowder Plot epigrams, now appended to the *Elegies*; and (3) the first five pieces of the *Sylvarum liber*, the most important of which are the hexameter poem "In quintum novembris" (1626), and the piece entitled *Naturam*

non pati senium (1628). Of the English poems of the Cambridge period the following is a dated list: "On the Death of a fair Infant" (1625-1626), the subject being the death of the first-born child of his sister Anne Phillips; "At a Vacation Exercise in the College" (1628), the magnificent Christmas ode; "On the Morning of Christ's Nativity" (1629); the fragment called "The Passion" and the "Song on May Morning," both probably belonging to 1630; the sonnet "On Shakespeare," certainly belonging to that year, printed in the Shakespeare folio of 1632; the two facetious pieces "On the University Carrier" (1630-1631); the "Epitaph on the Marchioness of Winchester" (1631); the sonnet "To the Nightingale," probably of the same year; the sonnet "On arriving at the Age of twenty-three," dating itself certainly in December 1631.

Just before Milton quitted Cambridge, his father, then verging on his seventieth year, had practically retired from his Bread Street business, leaving the active management of it to a partner, named Thomas Bowler, a former apprentice of his, and had gone to spend his declining years at Horton in Buckinghamshire, a small village near Colnbrook, and not far from Windsor. Here, in a house close to Horton church, Milton mainly resided for the next six years—from July 1632 to April 1638.

Although, when he had gone to Cambridge, it had been with the intention of becoming a clergyman, that intention had been abandoned. His reasons were that "tyranny had invaded the church," and that, finding he could not honestly subscribe the oaths and obligations required he "thought it better to preserve a blameless silence before the sacred office of speaking, begun with servitude and forswearing."¹ In other words, he was disgusted with the system which Laud was establishing and maintaining in the Church of England. "Church-outed by the prelates," as he emphatically expresses it, he seems to have thought for a time of the law, but he decided that the only life possible for himself was one dedicated wholly to scholarship and literature. His compunctions on this subject, expressed already in his sonnet on arriving at his twenty-third year, are expressed more at length in an English letter of which two drafts are preserved in Trinity College, Cambridge, sent by him, shortly after the date of that sonnet, and with a copy of the sonnet included, to some friend who had been remonstrating with him on his "belatedness" and his persistence in a life of mere dream and study. There were gentle remonstrances also from his excellent father. Between such a father and such a son, however, the conclusion was easy. What it was may be learnt from Milton's fine Latin poem *Ad patrem*. There, in the midst of an enthusiastic recitation of all that his father had done for him hitherto, it is intimated that the agreement between them on their one little matter of difference was already complete, and that, as the son was bent on a private life of literature and poetry, it had been decided that he should have his own way, and should in fact, so long as he chose, be the master of his father's means and the chief person in the Horton household. For the six years from 1632 this, accordingly, was Milton's position. In perfect leisure, and in a pleasant rural retirement, with Windsor at the distance of an easy walk, and London only about 17 m. off, he went through, he tells us, a systematic course of reading in the Greek and Latin classics, varied by mathematics, music, and the kind of physical science we should now call cosmography.

It is an interesting fact that Milton's very first public appearance in the world of English authorship was in so honourable a place as the second folio edition of *Shakespeare* in 1632. His enthusiastic eulogy on Shakespeare, written in 1630, was one of three anonymous pieces prefixed to that second folio. Among the poems actually written by Milton at Horton the first, in all probability, after the Latin hexameters *Ad patrem*, were the exquisite companion pieces *L'Allegro* and *Il Penseroso*. There followed, in or about 1633, the fragment called *Arcades*. It was part of a pastoral masque performed by the young people of the noble family of Egerton before the countess-dowager

¹ See the preface to Book II. of his *Reason of Church Government* (1641-1642), which is of great biographical interest.

of Derby, at her mansion of Harefield, about 10 m. from Horton. That Milton contributed the words for the entertainment was, almost certainly, owing to his friendship with Henry Lawes, who supplied the music. Next in order among the compositions at Horton may be mentioned the three short pieces, "At a Solemn Music," "On Time," and "Upon the Circumcision"; after which comes *Comus*, the largest and most important of all Milton's minor poems. The name by which that beautiful drama is now universally known was not given to it by Milton himself. He entitled it, more simply and vaguely, "A Masque presented at Ludlow Castle, 1634, on Michaelmas night, before John Earl of Bridgewater, Lord President of Wales" (1637). The earl of Bridgewater, the head of the Egerton family, had been appointed president of the council of Wales; among the festivities on his assumption of the office, a great masque was arranged in the hall of Ludlow Castle, his official residence. Lawes supplied the music and was stage manager; he applied to Milton for the poetry; and on Michaelmas night, the 29th of September 1634, the drama furnished by Milton was performed in Ludlow Castle before a great assemblage of the nobility and gentry of the Welsh principality, Lawes taking the part of "the attendant spirit," while the parts of "a first brother," "second brother" and "the lady," were taken by the earl's three youngest children, Viscount Brackley, Mr Thomas Egerton and Lady Alice Egerton.

From September 1634 to the beginning of 1637 is a comparative blank in our records. Stragglings incidents in this blank are a Latin letter of date December 4, 1634, to Alexander Gill the younger, a Greek translation of "Psalm CXIV," a visit to Oxford in 1635 for the purpose of incorporation in the degree of M.A. in that university, and the beginning in May 1636 of a troublesome lawsuit against his now aged and infirm father. The lawsuit, which was instituted by a certain Sir Thomas Cotton, bart., nephew and executor of a deceased John Cotton, Esq., accused the elder Milton and his partner Bower, or both, of having, in their capacity as scribes, misappropriated divers large sums of money that had been entrusted to them by the deceased Cotton to be let out at interest.

The lawsuit was still in progress when, on the 3rd of April 1637, Milton's mother died, at the age of about sixty-five. A flat blue stone, with a brief inscription, visible on the chancel-pavement of Horton church, still marks the place of her burial. Milton's testimony to her character is that she was "a most excellent mother and particularly known for her charities through the neighbourhood." The year 1637 was otherwise eventful. It was in that year that his *Comus*, after lying in manuscript for more than two years, was published by itself, in the form of a small quarto of thirty-five pages. The author's name was withheld, and the entire responsibility of the publication was assumed by Henry Lawes. Milton seems to have been in London when the little volume appeared. He was a good deal in London, at all events, during the summer and autumn months immediately following his mother's death. The plague, which had been on one of its periodical visits of ravage through England since early in the preceding year, was then especially severe in the Horton neighbourhood, while London was comparatively free. It was probably in London that Milton heard of the death of Edward King, who had sailed from Chester for a vacation visit to his relatives in Ireland, when, on the 10th of August, the ship in perfectly calm water struck on a rock and went down, he and nearly all the other passengers going down with her. There is no mention of this event in Milton's two Latin "Familiar Epistles" of September 1637, addressed to his friend Charles Diodati, and dated from London; but in November 1637, and probably at Horton, he wrote his matchless pastoral monody of *Lycidas*. It was his contribution to a collection of obituary verses, Greek, Latin and English, inscribed to the memory of Edward King by his numerous friends, at Cambridge and elsewhere. The collection appeared early in 1638. The second part contained thirteen English poems, the last of which was Milton's monody, signed only with his initials "J. M."

Milton was then on the wing for a foreign tour. He had long set his heart on a visit to Italy, and circumstances now favoured his wish. The vexatious Cotton lawsuit, after hanging on for nearly two years, was at an end, as far as the elder Milton was concerned, with the most absolute and honourable vindication of his character for probity, though with some continuation of the case against his partner, Bower. Moreover, Milton's younger brother Christopher, though but twenty-two years of age, and just about to be called to the bar of the Inner Temple, had married; and the young couple had gone to reside at Horton to keep the old man company.

Before the end of April 1638 Milton was on his way across the channel, taking one English man-servant with him. At the time of his departure the last great news in England was that of the National Scottish Covenant. To Charles the news of this "damnable Covenant," as he called it, was enraging beyond measure; but to the mass of the English Puritans it was far from unwelcome, promising, as it seemed to do, for England herself, the subversion at last of that system of "Thorough," or despotic government by the king and his ministers without parliaments, under which the country had been groaning since the contemptuous dissolution of Charles's third parliament ten years before. Through Paris, where Milton received polite attention from the English ambassador, Lord Scudamore, and had the honour of an introduction to the famous Hugo Grotius, then ambassador for Sweden to the French court, he moved on rapidly to Italy, by way of Nice. After visiting Genoa, Leghorn and Pisa, he arrived at Florence, in August 1638. Enchanted by the city and its society, he remained there two months, frequenting the chief academies or literary clubs, and even taking part in their proceedings. Among the Florentines with whom he became intimate were Jacopo Gaddi, founder of an academy called the *Svogliati*, young Carlo Dati, author of *Vite de' pittori antichi*, Pietro Frescobaldi, Giorgio Cottellini, the founder of the Academy of the Apatisti, the grammarian Benedetto Buommattei, Valerio Chimentelli, afterwards professor of Greek at Pisa, Antonio Francini and Antonio Malatesti. It was in the neighbourhood of Florence also that he "found and visited" the great Galileo, then old and blind, and still nominally a prisoner to the Inquisition for his astronomical heresy.¹

By way of Florence and Siena, he reached Rome some time in October, and spent about another two months there, not only going about among the ruins and antiquities and visiting the galleries, but mixing also, as he had done in Florence, with the learned society of the academies. Among those with whom he formed acquaintance in Rome were the German scholar, Lucas Holstenius, librarian of the Vatican, and three native Italian scholars, named Alessandro Cherubini, Giovanni Salzilli and a certain Selvaggi. There is record of his having dined once, in company with several other Englishmen, at the hospitable table of the English Jesuit College. The most picturesque incident, however, of his stay in Rome was his presence at a great musical entertainment in the palace of Cardinal Francesco Barberini. Here he had not only the honour of a specially kind reception by the cardinal himself, but also, it would appear, the supreme pleasure of listening to the marvellous Leonora Baroni, the most renowned singer of her age.

Late in November he left Rome for Naples. Here he met the aged Giovanni Battista Manso, marquis of Villa (1560-1645), the friend and biographer of Tasso, and subsequently the friend and patron of Marini. He had hardly been in Naples a month, however, when there came news from England which not only stopped an intention he had formed of extending his tour to Sicily and thence into Greece, but urged his immediate return home. "The sad news of civil war in England," he says, "called me back; for I considered it base that, while my fellow-countrymen were fighting at home for liberty, I should be travelling at my ease for intellectual culture" (*Defensio secunda*). In December 1638, therefore, he set his face northwards

¹ This interview forms the subject of one of W. S. Lander's *Imaginary Conversations*.

again. His return journey, however, probably because he learnt that the news he had first received was exaggerated or premature, was broken into stages. He spent a second January and February (1638-1639) in Rome, in some danger, he says, from the papal police, because the English Jesuits in Rome had taken offence at his habit of free speech, wherever he went, on the subject of religion. From Rome he went to Florence, his second visit to the city, including an excursion to Lucca, extending over two months; and not till April 1639 did he take his leave, and proceed, by Bologna and Ferrara, to Venice. About a month was given to Venice; and thence, having shipped for England the books he had collected in Italy, he went on, by Verona and Milan, over the Alps, to Geneva. In this Protestant city he spent a week or two in June, forming interesting acquaintanceships there too, and having daily conversations with the great Protestant theologian Dr Jean Diodati, the uncle of his friend Charles Diodati. From Geneva he returned to Paris, and so to England. He was home again in August 1639, having been absent in all fifteen or sixteen months.

Milton's Continental tour, and especially the Italian portion of it, which he describes at some length in his *Defensio secunda*, remained one of the chief pleasures of his memory through all his subsequent life. Nor was it without fruits of a literary kind. Besides two of his Latin *Epistolae familiares*, one to the Florentine grammarian Buommattei, and the other to Lucas Holstenius, there have to be assigned to Milton's sixteen months on the Continent his three Latin epigrams *Ad Leonoram Romae canentem*, his Latin scanzos *Ad Salsillum poetam romanum aegrotantem*, his fine Latin hexameters entitled *Mansus*, addressed to Giovanni Battista Manso, and his five Italian sonnets, with a canzone, in praise of a Bolognese lady.

His bosom friend and companion from boyhood, Charles Diodati, died in Blackfriars, London, in August 1638, not four months after Milton had gone away on his tour. The intelligence did not reach Milton till some months afterwards, probably not till his second stay in Florence; and, though he must have learnt some of the particulars from his friend's uncle in Geneva, he did not know them fully till his return to England. How profoundly they affected him appears from his *Epitaphium Damonis*, then written in memory of his dead friend. The importance of this poem in Milton's biography cannot be overrated. It is perhaps the noblest of all his Latin poems; and, though written in the artificial manner of a pastoral, it is unmistakably an outburst of the most passionate personal grief. In this respect *Lycidas*, artistically perfect though that poem is, cannot be compared with it; and it is only the fact that *Lycidas* is in English, while the *Epitaphium Damonis* is in Latin, that has led to the notion that Edward King of Christ's College was peculiarly and pre-eminently the friend of Milton in his youth and early manhood.

We should not have known, but for an incidental passage in the *Epitaphium Damonis*, that, at the time of his return from Italy, he had chosen a subject for a great poem from the Arthurian legend. The passage (lines 160-178) is one in which, after referring to the hopes of Diodati's medical career so suddenly cut short by his death, Milton speaks of himself and of his own projects in his profession of literature. Milton wrote that he was meditating an epic of which King Arthur was to be the central figure, but which should include somehow the whole cycle of British and Arthurian legend. This epic was to be in English, and he had resolved that all his poetry for the future should be in the same tongue.

Not long after Milton's return the house at Horton ceased to be the family home. Christopher Milton and his wife went to reside at Reading, taking the old gentleman with them, while Milton himself preferred London. He had first taken lodgings in St Bride's Churchyard, at the foot of Fleet Street; but, after a while, probably early in 1640, he removed to a "pretty garden house" of his own, at the end of an entry, in the part of Aldersgate Street which lies immediately on the city side of what is now Maidenhead Court. His sister, whose first

husband had died in 1631, had married a Mr. Thomas Agar, his successor in the Crown Office; and it was arranged that her two sons by her first husband should be educated by their uncle. John Phillips, the younger of them, only nine years old, had boarded with him in the St Bride's Churchyard lodgings; and, after the removal to Aldersgate Street, the other brother, Edward Phillips, only a year older, became his boarder also. Gradually a few other boys, the sons of well-to-do personal friends, joined the two Phillipses, whether as boarders or for daily lessons, so that the house in Aldersgate Street became a small private school.

The Arthurian epic had been given up, and his mind was roving among many other subjects, and balancing their capabilities. How he wavered between Biblical subjects and heroic subjects from British history, and how many of each kind suggested themselves to him, one learns from a list in his own handwriting among the Milton MSS. at Cambridge. It contains jottings of no fewer than fifty-three subjects from the Old Testament, eight from the Gospels, thirty-three from British and English history before the Conquest, and five from Scottish history. It is curious that all or most of them are headed or described as subjects for "tragedies," as if the epic form had now been abandoned for the dramatic. There are four separate drafts of a possible tragedy on the Greek model under the title of *Paradise Lost*, two of them merely enumerating the dramatic personae, but the last two indicating the plot and the division into acts. In 1641 he wrote in the *Reason of Church Government* that he was meditating a poem on high moral or religious subjects. But the fulfilment of these plans was indefinitely postponed. Milton became absorbed in the ecclesiastical controversies following on the king's attempt to force the episcopal system on the Scots.

Of the first proceedings of the Long Parliament, including the trial and execution of Strafford, the impeachment and imprisonment of Laud and others, and the breakdown of the system of Thorough by miscellaneous reforms and by guarantees for parliamentary liberty, Milton was only a spectator. It was when the church question emerged distinctly as the question paramount, and there had arisen divisions on that question among those who had been practically unanimous in matters of civil reform, that he plunged in as an active adviser. There were three parties on the church question. There was a high-church party, contending for episcopacy by divine right, and for the maintenance of English episcopacy very much as it was; there was a middle party, defending episcopacy on grounds of usage and expediency, but desiring to see the powers of bishops greatly curtailed, and a limited episcopacy, with councils of presbyters round each bishop, substituted for the existing high episcopacy; and there was the root-and-branch party, as it called itself, desiring the entire abolition of episcopacy and the reconstruction of the English Church on something like the Scottish Presbyterian model. Since the opening of the parliament there had been a storm of pamphlets from these three parties. The manifesto of the high-church party was a pamphlet by Joseph Hall, bishop of Exeter, entitled "Humble Remonstrance to the High Court of Parliament." In answer to Hall, and in representation of the views of the root-and-branch party, there had stepped forth, in March 1640-1641, five leading Puritan parish ministers, the initials of whose names, clubbed together on the title-page of their joint production, made the uncouth word "Smectymnuus." These were Stephen Marshall, Edmund Calamy, Thomas Young, Matthew Newcomen and William Spurston. Thomas Young was the Scottish divine who had been Milton's tutor in Bread Street; he had returned from Hamburg in 1628, and had been appointed to the vicarage of Stowmarket in Suffolk. The famous Smectymnuan pamphlet in reply to Hall was mainly Young's. What is more interesting is that his old pupil Milton was secretly in partnership with him and his brother-Smectymnuans. Milton's hand is discernible in a portion of the original Smectymnuan pamphlet; and he continued to aid the Smectymnuans in their subsequent rejoinders to Hall's defences

of himself. In May 1641 he put forth a defence of the Smectymnan side in *Of Reformation touching Church Discipline in England and the Causes that hitherto have hindered it*. He reviewed English ecclesiastical history, with an appeal to his countrymen to resume that course of reformation which he considered to have been prematurely stopped in the preceding century, and to sweep away the last relics of papacy and prelacy. Among all the root-and-branch pamphlets of the time it stood out, and stands out still, as the most thorough-going and tremendous. It was followed by four others in rapid succession, — *Of Prelatical Episcopacy and whether it may be deduced from the Apostolical Times* (June 1641), *Animadversions upon the Remonstrant's Defence against Smectymnus* (July 1641), *The Reason of Church Government urged against Prelacy* (Feb. 1641-1642), *Apology against a Pamphlet called a Modest Confutation of the Animadversions, &c.* (March and April 1641-1642). The first of these was directed chiefly against that middle party which advocated a limited episcopacy, with especial reply to the arguments of Archbishop Usher, as the chief exponent of the views of that party. Two of the others, as the titles imply, belong to the Smectymnan series, and were castigations of Bishop Hall. The greatest of the four, and the most important of all Milton's anti-episcopal pamphlets after the first, is that entitled *The Reason of Church Government*. It is there that Milton takes his readers into his confidence, speaking at length of himself and his motives in becoming a controversialist. Poetry, he declares, was his real vocation; it was with reluctance that he had resolved to "leave a calm and pleasing solitariness, fed with cheerful and confident thoughts, to embark in a troubled sea of noises and hoarse disputes"; but duty had left him no option. The great poem or poems he had been meditating could wait; and meanwhile, though in prose-polemics he had the use only of his "left hand," that hand should be used with all its might in the cause of his country and of liberty. The *Apology* was in answer to a *Modest Confutation of a Slanderous and Scurrilous Libel*, the joint work of Hall and his son, attacking Milton's personal character.

The parliament had advanced in the root-and-branch direction so far as to have passed a bill for the exclusion of bishops from the House of Lords, and compelled the king's assent to that bill, when, in August 1642, the further struggle between Charles and his subjects took the form of civil war. The Long Parliament moved on more and more rapidly in the root-and-branch direction, till, by midsummer 1643, the abolition of episcopacy had been decreed, and the question of the future non-prelatical constitution of the Church of England referred to a synod of divines, to meet at Westminster under parliamentary authority. Of Milton's life through those first months of the Civil War little is known. He remained in his house in Aldersgate Street, teaching his nephews and other pupils; and the only scrap that came from his pen was the semi-jocose sonnet bearing the title "When the Assault was intended to the City." In the summer of 1643, however, there was a great change in the Aldersgate Street household. About the end of May, as his nephew Edward Phillips remembered, Milton went away on a country journey, without saying whither or for what purpose; and, when he returned, about a month afterwards, it was with a young wife, and with some of her sisters and other relatives in her company. He had, in fact, been in the very headquarters of the king and the Royalist army in and round Oxford; and the bride he brought back with him was a Mary Powell, the eldest daughter of Richard Powell, of Forest Hill, near Oxford. She was the third of a family of eleven sons and daughters, of good standing, but in rather embarrassed circumstances, and was seventeen years and four months old, while Milton was in his thirty-fifth year. However the marriage came about, it was a most unfortunate event. The Powell family were strongly Royalist, and the girl herself seems to have been frivolous, and entirely unsuited for the studious life in Aldersgate Street. Hardly were the honeymoon festivities over, when, her sisters and other relatives having returned to Forest Hill and left her alone with her husband, she pined for home

again and begged to be allowed to go back on a visit. Milton consented, on the understanding that the visit was to be a brief one. This seems to have been in July 1643. Soon, however, the intimation from Forest Hill was that he need not look over to have his wife in his house again. The resolution seems to have been mainly the girl's own; but, as the king's cause was then prospering in the field, Edward Phillips was probably right in his conjecture that the whole of the Powell family had repented of their sudden connexion with so prominent a Parliamentarian and assailant of the Church of England as Milton. While his wife was away, his old father, who had been residing for three years with his younger and lawyer son at Reading, came to take up his quarters in Aldersgate Street.

Milton's conduct under the insult of his wife's desertion was most characteristic. Always fearless and speculative, he converted his own case into a public protest against the existing law and theory of marriage. *The Doctrine and Discipline of Divorce, Restored to the good of both Sexes from the Bondage of Canon Law and other Mistakes* was the title of a pamphlet put forth by him in August 1643, without his name, but with no effort at concealment, declaring the notion of a sacramental sanctity in the marriage relation to be a clerically invented superstition, and arguing that inherent incompatibility of character, or contrariety of mind, between two married persons is a perfectly just reason for divorce. If the date, the 1st of August, is correct, the pamphlet must have been written almost immediately on his wife's departure and before her definite refusal to return. There was no reference to his own case, except by implication; but the boldness of the speculation roused attention and sent a shock through London. It was a time when the authors of heresies of this sort, or of any sort, ran considerable risks. The famous Westminster Assembly of Divines, called by the Long Parliament, met on the 1st of July 1643. Whether Milton's divorce tract was formally discussed in the Assembly during the first months of its sitting is unknown; but it is certain that the London clergy, including not a few members of the Assembly, were then angrily discussing it in private. That there might be no obstacle to a more public prosecution, Milton put his name to a second and much enlarged edition of the tract, in February 1644, dedicated openly to the parliament and the assembly. Then, for a month or two, during which the gossip about him and his monstrous doctrine was spreading more and more, he turned his attention to other subjects.

Among the questions in agitation in the general ferment of opinion brought about by the Civil War was that of a reform of the national system of education and especially of the universities. To this question Milton made a contribution in June 1644, in a small treatise, *Of Education*, in the form of a letter to Samuel Hartlib, a German then resident in London and interesting himself busily in all philanthropic projects and schemes of social reform. In the very next month, however, July 1644, he returned to the divorce subject in a pamphlet addressed specially to the clergy and entitled *The Judgment of Martin Bucer concerning Divorce*. The outcry against him then reached its height. He was attacked in pamphlets; he was denounced in pulpits all through London, and especially by Herbert Palmer in a sermon preached on the 13th of August, before the two Houses of Parliament; strenuous efforts were made to bring him within definite parliamentary censure. In the cabal formed against him for this purpose a leading part was played, at the instigation of the clergy, by the Stationers' Company of London, which had a plea of its own against him on the ground that his doctrine was not only immoral, but had been put forth in an illegal manner. His first divorce treatise, though published immediately after the "Printing Ordinance" of the parliament of the 14th of June 1643, requiring all publications to be licensed for press by one of the official censors, and to be registered in the books of the Stationers' Company, had been issued without license and without registration. Complaint to this effect was made against Milton, with some others

liable to the same charge of contempt of the printing ordinance, in a petition of the Stationers of the House of Commons in August 1644; and the matter came before committee both in that House and in the Lords.

It is to this circumstance that the world owes the most popular and eloquent, if not the greatest, of all Milton's prose writings, his famous *Areopagitica*, a *Speech of Mr John Milton for the Liberty of Unlicensed Printing, to the Parliament of England*. It appeared on the 25th of November 1644, deliberately unlicensed and unregistered, and was a remonstrance addressed to the parliament, as if in an oration to them face to face, against their ordinance of June 1643 and the whole system of licensing and censorship of the press. Nobly eulogistic of the parliament in other respects, it denounced their printing ordinance as utterly unworthy of them, and of the new era of English liberties which they were initiating, and called for its repeal. Though that effect did not follow, the pamphlet virtually accomplished its purpose. The licensing system had received its death-blow; and, though the Stationers returned to the charge in another complaint to the House of Lords, Milton's offence against the press ordinance was condoned. He was still assailed in pamphlets, and found himself "in a world of disesteem"; but he lived on through the winter of 1644/5 undisturbed in his house in Aldersgate Street. To this period there belong, in the shape of verse, only his sonnets ix. and x., the first to some anonymous lady, and the second "to the Lady Margaret Ley," with perhaps the Greek lines entitled *Philosophus ad regem quemdam*. His divorce speculation, however, still occupied him; and in March 1644/5 he published simultaneously his *Tetrachordon: Expositions upon the four chief places of Scripture which treat of Marriage, and his Calasiterion, a Reply to a nameless Answer against the Doctrine and Discipline of Divorce*. In these he replied to his chief recent assailants, lay and clerical, with merciless severity.

Through the latter part of 1644, Milton had been saved from the penalties which his Presbyterian opponents would have inflicted on him by the general championship of liberty of opinion by Cromwell and the army Independents. Before the middle of 1645 he, with others who were on the black books of the Presbyterians as heretics, was safer still. Milton's position after the battle of Naseby may be easily understood. Though his first tendency on the Church question had been to some form of a Presbyterian constitution for the Church, he had parted utterly now from the Scots and Presbyterians, and become a partisan of Independency, having no dread of "sects and schisms," but regarding them rather as healthy signs in the English body-politic. He was, indeed, himself one of the most noted sectaries of the time, for in the lists of sects drawn out by contemporary Presbyterian writers special mention is made of one small sect who were known as *Miltonists* or *Divorcers*.

So far as Milton was concerned personally, his interest in the divorce speculation came to an end in July or August 1645, when, by friendly interference, a reconciliation was effected between him and his wife. The ruin of the king's cause at Naseby had suggested to the Powells that it might be as well for their daughter to go back to her husband after their two years of separation. It was not, however, in the house in Aldersgate Street that she rejoined him, but in a larger house, which he had taken in the adjacent street called Barbican, for the accommodation of an increasing number of pupils.

The house in Barbican was tenanted by Milton from about August 1645 to September or October 1647. Among his first occupations there must have been the revision of the proof sheets of the first edition of his collected poems. It appeared as a tiny volume, copies of which are now very rare, with the title, *Poems of Mr John Milton, both English and Latin, compos'd at several times. Printed by his true Copies. The songs were set in Musick by Mr Henry Lawes. . .* The title-page gives the date 1645, but the 2nd of January 1645/6 seems to have been the exact day of its publication. Whether because his pedagogic duties now engrossed him or for other reasons, very

few new pieces were added in the Barbican to those that the little volume had thus made public. In English, there were only the four sonnets now numbered xi.-xiv., the first two entitled "On the Detraction which followed upon my writing certain Treatises," the third "To Mr Henry Lawes on his Airs," and the fourth "To the Religious Memory of Mrs Catherine Thomson," together with the powerful anti-Presbyterian invective or "tailed sonnet" entitled "On the New Forcers of Conscience under the Long Parliament"; and in Latin there were only the ode *Ad Joannem Rousium*, the *Apologus de Rustico et Hero*, and one interesting "Familiar Epistle" (April 1647) addressed to his Florentine friend Carlo Dati.

Some family incidents of importance belong to this time of residence in Barbican. The fall of Oxford in 1646 compelled the whole of the Powell family to seek refuge in London, and most of them found shelter in Milton's house. His first child, a daughter named Anne, was born there on the 29th of July that year; on the 1st of January 1646/7 his father-in-law Richard Powell died there, leaving his affairs in confusion; and in the following March his own father died there, at the age of eighty-four, and was buried in the adjacent church of St Giles, Cripplegate.

From Barbican Milton removed, in September or October 1647, to a smaller house in that part of High Holborn which adjoins Lincoln's Inn Fields. His Powell relatives had now left him, and he had reduced the number of his pupils, or perhaps kept only his two nephews. But, though thus more at leisure, he did not yet resume his projected poem, but occupied himself rather with three works of scholarly labour which he had already for some time had on hand. One was the compilation in English of a complete history of England, or rather of Great Britain, from the earliest times; another was the preparation in Latin of a complete system of divinity, drawn directly from the Bible; and the third was the collection of materials for a new Latin dictionary. Milton had always a fondness for such labours of scholarship and compilation. Of a poetical kind there is nothing to record, during his residence in High Holborn, but an experiment in psalm-translation, in the shape of Ps. lxxx.-lxxxviii. done into service-metre in April 1648, and the sonnet to Fairfax, written in September of the same year.

The crushing defeat of the Scottish army by Cromwell in the three days' battle of Preston (1648) and the simultaneous suppression of the English Royalist insurrection in the south-east counties by Fairfax's siege and capture of Colchester, left King Charles at the mercy of the victors. Milton's sonnet "On the Lord General Fairfax, at the siege of Colchester," attested the exultation of the writer at the triumph of the parliamentary cause. His exultation continued through what followed. When the king was beheaded (1649) the first Englishman of mark out of parliament to attach himself openly to the new republic was John Milton. This he did by the publication of his pamphlet entitled "Tenure of Kings and Magistrates, proving that it is lawful, and hath been held so in all ages, for any who have the power, to call to account a Tyrant or wicked King, and, after due conviction, to depose and put him to death, if the ordinary Magistrate have neglected or denied to do it." It was out within a fortnight after the king's death, and was Milton's last performance in the house in High Holborn. The chiefs of the new republic could not but perceive the importance of securing the services of a distinguished man who had so opportunely and so powerfully spoken out in favour of their tremendous act. In March 1649, accordingly, Milton was offered, and accepted, the secretaryship for foreign tongues to the council of state of the new Commonwealth. The salary was to be £288 a year (worth about £1000 a year now). To be near his new duties in attendance on the council, which held its daily sittings for the first few weeks in Derby House, close to Whitehall, but afterwards regularly in Whitehall itself, he removed at once to temporary lodgings at Charing Cross. In the very first meetings of council which Milton attended he must have made personal acquaintance with President Bradshaw, Fairfax, Cromwell himself, Sir Henry Vane, Whitelock,

Henry Marten, Haselrig, Sir Gilbert Pickering and the other chiefs of the council and the Commonwealth, if indeed he had not known some of them before. After a little while, for his greater convenience, official apartments were assigned him in Whitehall itself.

At the date of Milton's appointment to the secretaryship he was forty years of age. His special duty was the drafting in Latin of letters sent by the council of state, or sometimes by the Rump Parliament, to foreign states and princes, with the examination and translation of letters in reply, and with personal conferences, when necessary, with the agents of foreign powers in London, and with envoys and ambassadors. As Latin was the language employed in the written diplomatic documents, his post came to be known indifferently as the secretaryship for foreign tongues or the Latin secretaryship. In that post, however, his duties, more particularly at first, were very light in comparison with those of his official colleague, Walter Frost, the general secretary. Foreign powers held aloof from the English republic as much as they could; and, while Frost had to be present in every meeting of the council, keeping the minutes, and conducting all the general correspondence, Milton's presence was required only when some piece of foreign business turned up. Hence, from the first, his employment in very miscellaneous work. Especially, the council looked to him for everything in the nature of literary vigilance and literary help in the interests of the struggling Commonwealth. He was employed in the examination of suspected papers, and in interviews with their authors and printers; and he executed several great literary commissions expressly entrusted to him by the council. The first of these was his pamphlet entitled *Observations on the Articles of Peace* (between Ormonde and the Irish). It was published in May 1649, and was in defence of the republic against a complication of Royalist intrigues and dangers in Ireland. A passage of remarkable interest in it is one of eloquent eulogy on Cromwell. More important still was the *Eikonoklastes* (which may be translated "Image-Smasher"), published by Milton in October 1649, by way of counterblast to the famous *Eikon Basilike* ("Royal Image"), which had been in circulation in thousands of copies since the king's death, and had become a kind of Bible in all Royalist households, on the supposition that it had been written by the royal martyr himself (see GAUDEN, JOHN). In the end of 1649 there appeared abroad, under the title of *Defensio regia pro Carolo I.*, a Latin vindication of the memory of Charles, with an attack on the English Commonwealth. As it had been written, at the instance of the exiled royal family, by Salmasius, or Claude de Saumaise, of Leiden, then of enormous celebrity over Europe as the greatest scholar of his age, it was regarded as a serious blow to the infant Commonwealth. Milton threw his whole strength into a reply through the year 1650, interrupting himself only by a new and enlarged edition of his *Eikonoklastes*. His Latin *Pro populo anglicano defensio* (1651), ran at once over the British Islands and the Continent, and was received by scholars as an annihilation of Salmasius. Through the rest of 1651 the observation was that the two agencies which had co-operated most visibly in raising the reputation of the Commonwealth abroad were Milton's books and Cromwell's battles.

Through the eventful year 1651, in addition to the other duties of his secretaryship, Milton acted as licenser and superintending editor of the *Mercurius politicus*, a newspaper issued twice a week, of which Marchamont Nedham was the working editor and proprietor. Milton's hand is discernable in some of the leading articles.

About the end of 1651 Milton left his official rooms in Whitehall for a "garden house" he had taken on the edge of St James's Park in what was then called Petty France, Westminster, but is now York Street. The house, afterwards 19 York Street, was occupied by James Mill and William Hazlitt in succession, and was not pulled down till 1877. Milton had now more to do in the special work of his office, in consequence of the increase of correspondence with foreign powers. But he had for some time been in ailing health; and a dimness of eyesight which had

been growing upon him gradually for ten years had been settling rapidly, since his labour over the answer to Salmasius, into total blindness. Before or about May 1652, when he was but in his forty-fourth year, his blindness became total, and he could go about only with some one to lead him. Hence a rearrangement of his secretarial duties. Such of these duties as he could perform at home, or by occasional visits to the Council Office near, he continued to perform; but much of the routine work was done for him by an assistant, a well-known German, George Rudolph Weckerlin, succeeded later by Philip Meadows and, eventually, by Andrew Marvell. Precisely to this time of a lull in Milton's secretaryship on account of his ill-health and blindness we have to refer his two great companion sonnets "To the Lord General Cromwell" and "To Sir Henry Vane the Younger."

In 1652 died his only son, who had been born at Whitehall in the March of the preceding year. His wife died in 1653/4, just after she had given birth to his third daughter, Deborah. With the three children thus left him—Anne, but six years old, Mary, not four, and the infant Deborah—the blind widower lived on in his house in Petty France in such desolation as can be imagined. He had recovered sufficiently to resume his secretarial duties; and the total number of his dictated state letters for the single year 1652 is equal to that of all the state letters of his preceding term of secretaryship put together. To the same year there belong also three of his Latin "Familiar Epistles." In December 1652 there appeared *Joannis Philippi Angli responsio ad apologiam anonymi cujusdam tenebrionis*, being a reply by Milton's younger nephew, John Phillips, but touched up by Milton himself, to one of several pamphlets that had appeared against Milton for his slaughter of Salmasius.

In December 1653 Cromwell's formal sovereignty began under the name of the Protectorate, passing gradually into more than kingship. This change from Government by the Rump and its council to government by a single military lord protector and his council was regarded by many as treason to the republican cause, and divided those who had hitherto been the united Commonwealth's men into the "Pure Republicans," represented by such men as Bradshaw and Vane, and the "Oliverians," adhering to the Protector. Milton, whose boundless admiration of Cromwell had shown itself already in his Irish tract of 1649 and in his recent sonnet, was recognized as one of the Oliverians. He remained in Oliver's service and was his Latin secretary through the whole of the Protectorate. For a while, indeed, his Latin letters to foreign states in Cromwell's name were but few—Thurloe, as general secretary, officiating as Oliver's right-hand man in everything, with a Philip Meadows under him, at a salary of £200 a year, as deputy for the blind Milton in foreign correspondence and translations. The reason for this temporary exemption of Milton from routine duty may have been that he was then engaged on an answer to the pamphlet from the Hague entitled *Regii sanguinis clamor ad coelum adversus parricidas anglicanos* (March 1652). Salmasius was now dead, and the Commonwealth was too stable to suffer from such attacks; but no Royalist pamphlet had appeared so able or so venomous as this in continuation of the Salmasian controversy. All the rather because it was in the main a libel on Milton himself did a reply from his pen seem necessary. It came out in May 1654, with the title *Joannis Miltoni Angli pro populo anglicano defensio secunda* (Second Defence of John Milton, Englishman, for the People of England). The author of *Regii sanguinis clamor* was Dr Peter du Moulin the younger, a naturalized French Presbyterian minister, then moving about in English society, close to Milton; but, as that was a profound secret, and the work was universally attributed on the Continent to an Alexander More or Morus, a French minister of Scottish descent then a professor at Middelburg, who had certainly managed the printing in consultation with the now deceased Salmasius, and had contributed some portion of the matter—Milton made More the responsible person and the one object of his invective. The savage attack on More's personal character, however, is but part of the *Defensio secunda*. It contains passages of singular autobiographical and historical value, and includes laudatory sketches of such eminent

Commonwealth's men as Bradshaw, Fairfax, Fleetwood, Lambert and Overton, together with a long panegyric on Cromwell himself and his career, which remains to this day unapproached for elaboration and grandeur by any estimate of Cromwell from any later pen.

From about the date of the publication of the *Defensio secunda* to the beginning of 1655 the only specially literary relics of Milton's life are his translations of Ps. i.-viii. in different metres, done in August 1654, his translation of Horace's *Ode*, i. 5, done probably about the same time, and two of his Latin "Familiar Epistles." The most active time of his secretaryship for Oliver was from April 1655 onwards. In that month, in the course of a general revision of official salaries under the Protectorate, Milton's salary of £88 a year hitherto was reduced to £200 a year, with a kind of redefinition of his office, recognizing it, we may say, as a Latin secretaryship extraordinary. Philip Meadows was to continue to do all the ordinary Foreign Office work, under Thurloe's inspection; but Milton was to be called in on special occasions. Hardly was the arrangement made when a signal occasion did occur. In May 1655 all England was horrified by the news of the massacre of the Vaudois Protestants (Waldenses) by the troops of Emanuele II., duke of Savoy and prince of Piedmont, in consequence of their disobedience to an edict requiring them either to leave their native valleys or to conform to the Catholic religion. Cromwell and his council took the matter up with all their energy; and the burst of indignant letters on the subject despatched in that month and the next to the duke of Savoy himself, Louis XIV. of France, Cardinal Mazarin, the Swiss cantons, the states-general of the United Provinces, and the kings of Sweden and Denmark, were all by Milton. His famous sonnet "On the Late Massacre in Piedmont" was his more private expression of feeling on the same occasion. This sonnet was in circulation, and the case of the Vaudois Protestants was still occupying Cromwell, when, in August 1655, there appeared the last of Milton's Latin pamphlets. It was his *Pro se defensio* . . . in answer to an elaborate self-defence which More had put forth on the Continent since Milton's attack on his character. In that year also appeared Milton's *Scriptum domini protectoris . . . contra hispanos*.

Through the rest of Cromwell's Protectorate, Milton's life was of comparatively calm tenor. He was in much better health than usual, bearing his blindness with courage and cheerfulness; he was steadily busy with important despatches to foreign powers on behalf of the Protector, then in the height of his great foreign policy; and his house in Petty France seems to have been, more than at any previous time since the beginning of his blindness, a meeting-place for friends and visitors, and a scene of pleasant hospitalities. The four sonnets now numbered xix.-xxii., one of them to young Lawrence, the son of the president of Cromwell's council, and two of the others to Cyriac Skinner, once his pupil, belong to this time of domestic quiet, as do also no fewer than ten of his Latin "Familiar Epistles." His marriage with Katherine Woodcock on the 12th of November 1656 brought him a brief period of domestic happiness; but, after only fifteen months, he was again a widower, by her death in childbirth in February 1657/8. The child dying with her, only the three daughters by the first marriage remained. The touching sonnet which closes the series of Milton's *Sonnets* is his sacred tribute to the memory of his second marriage and to the virtues of the wife he had so soon lost. Even after that loss we find him still busy for Cromwell. Andrew Marvell, in September 1657 succeeded Meadows, much to Milton's satisfaction, as his assistant secretary; but this had by no means relieved him from duty. Some of his greatest despatches for Cromwell, including letters, of the highest importance, to Louis XIV., Mazarin and Charles Gustavus of Sweden, belong to the year 1658.

There is, unfortunately, no direct record to show what Cromwell thought of Milton; but there is ample record of what Milton thought of Cromwell. "Our chief of men," he had called Cromwell in his sonnet of May 1652; and the opinion remained unchanged. He thought Cromwell the greatest and best man

of his generation, or of many generations; and he regarded Cromwell's assumption of the supreme power, and his retention of that power with a sovereign title, as no real suppression of the republic, but as absolutely necessary for the preservation of the republic, and for the safeguard of the British Islands against a return of the Stuarts. Nevertheless, under this prodigious admiration of Cromwell, there were political doubts and reserves. Milton was so much of a modern radical of the extreme school in his own political views and sympathies that he cannot but have been vexed by the growing conservatism of Cromwell's policy through his Protectorate. To his grand panegyric on Oliver in the *Defensio secunda* of 1654 he had ventured to append cautions against self-will, over-legislation and over-policing; and he cannot have thought that Oliver had been immaculate in these respects through the four subsequent years. The attempt to revive an aristocracy and a House of Lords, on which Cromwell was latterly bent, cannot have been to Milton's taste. Above all, Milton dissented in toto from Cromwell's church policy. It was Milton's fixed idea, almost his deepest idea, that there should be no such thing as an Established Church, or state-paid clergy, of any sort or denomination or mixture of denominations, in any nation, and that, as it had been the connexion between church and state, begun by Constantine, that had vitiated Christianity in the world, and kept it vitiated, so Christianity would never flourish as it ought till there had been universal disestablishment and disendowment of the clergy, and the propagation of the gospel were left to the zeal of voluntary pastors, self-supported, or supported modestly by their flocks. He had at one time looked to Cromwell as the likeliest man to carry this great revolution in England. But Cromwell, after much meditation on the subject in 1652 and 1653, had come to the opposite conclusion. The conservation of the Established Church of England, in the form of a broad union of all evangelical denominations of Christians, whether Presbyterians, or Independents, or Baptists, or moderate Old Anglicans, that would accept state-pay with state-control, had been the fundamental notion of his Protectorate, persevered in to the end. This must have been Milton's deepest disappointment with Cromwell's rule.

Cromwell's death on the 3rd of September 1658 left the Protectorship to his son Richard. Milton and Marvell continued in their posts, and a number of the Foreign Office letters of the new Protectorate were of Milton's composition. In October 1658 appeared a new edition of his *Defensio prima*, and, early in 1659, a new English pamphlet, entitled *Treatise of Civil Power in Ecclesiastical Causes showing that it is not lawful to compel in Matters of Religion*, in which he advocated the separation of Church and State. To Richard's Protectorate also belongs one of Milton's Latin "Familiar Epistles."

The last of his known official performances in his Latin secretaryship are two letters in the name of William Lenthall, as the speaker of the restored Rump, one to the king of Sweden and one to the king of Denmark, both dated the 15th of May 1659. Under the restored Rump, if ever, he seemed to have a chance for his notion of church-disestablishment; and accordingly, in August 1659, he put forth, with a prefatory address to that body, a pamphlet entitled *Considerations touching the likeliest means to remove Hirdlings out of the Church*. The restored Rump had no time to attend to such matters. They were in struggle for their own existence with the army chiefs; and to prevent the restoration of the monarchy, to argue against it and fight against it to the last, was the work to which Milton set himself; the preservation of the republic in any form, and by any compromise of differences within itself, had become his one thought, and the study of practical means to this end his most anxious occupation. In a *Letter to a Friend concerning the Raptures of the Commonwealth*, written in October 1659, he had propounded a scheme of a kind of dual government for reconciling the army chiefs with the Rump; through the following winter, marked only by two of his Latin "Familiar Epistles," his anxiety over the signs of the growing enthusiasm throughout the country for the recall of Charles II. had risen to a passionate vehemence which found vent in a pamphlet entitled *The Ready and Easy Way to Establish*

a *Free Commonwealth, and the Excellence thereof compared with the Inconveniences and Dangers of readmitting Kingship to this Nation*. An abridgment of this pamphlet was addressed by him to General Monk in a letter entitled "The Present Means and Brief Delineation of a Free Commonwealth" (March 1660). Milton's proposal was that the central governing apparatus of the British Islands for the future should consist of one indissoluble grand council or parliament, which should include all the political chiefs, while there should be a large number of provincial councils or assemblies sitting in the great towns for the management of local and county affairs.

Not even when the king's cause was practically assured would Milton be silent. In *Brief Notes upon a late Sermon*, published in April 1660, in reply to a Royalist discourse by a Dr Matthew Griffith, he made another protest against the recall of the Stuarts, even hinting that it would be better that Monk should become king himself; and in the same month he sent forth a second edition of his *Ready and Easy Way*, more frantically earnest than even the first, and containing additional passages of the most violent denunciation of the royal family, and of prophecy of the degradation and disaster they would bring back with them. This was the dying effort. On the 25th of April the Convention Parliament met; on the 1st of May they resolved unanimously that the government by King, Lords and Commons should be restored; and on the 29th of May, Charles II. made his triumphal entry into London. The chief republicans had by that time scattered themselves, and Milton was hiding in an obscure part of the city.

How Milton escaped the scaffold at the Restoration is a mystery now, and was a mystery at the time. The Commons voted that he should be taken into custody by the serjeant-at-arms, for prosecution by the attorney-general on account of his *Eikonoklastes* and *Defensio prima*, and that all copies of those books should be called in and burnt by the hangman. There was a story that Milton had once protected Davenant and now owed his immunity to him; but it is more likely that he was protected by the influence of Marvell, by Arthur Annesley, afterwards earl of Anglesey, and by other friends who had influence at court. At all events, on the 29th of August 1660, when the Indemnity Bill did come out complete, with the king's assent, Milton did not appear as one of the exceptions on any ground or in any of the grades. From that moment, therefore, he could emerge from his hiding, and go about as a free man. Not that he was yet absolutely safe. There were several public burnings by the hangman at the same time of Milton's condemned pamphlets; and the appearance of the blind man himself in the streets, though he was legally free, would have caused him to be mobbed and assaulted. Though the special prosecution ordered against him by the Commons had been quashed by the subsequent Indemnity Bill, the serjeant-at-arms had taken him into custody. Entries in the Commons journals of the 17th and 19th of December show that Milton complained of the exorbitant fees charged by the serjeant-at-arms for his release, and that the matter was referred to a committee at the instance of Andrew Marvell.

Milton did not return to Petty France. For the first months after he was free he lived as closely as possible in a house near what is now Red Lion Square, Holborn. Thence he removed, apparently early in 1661, to a house in Jewin Street, in his old Aldersgate Street and Barbican neighbourhood. In Jewin Street Milton remained for two or three years, or from 1661 to 1664. This is the time of which he says:—

". . . though fallen on evil days,
On evil days though fallen, and evil tongues,
In darkness, and with dangers compassed round,
And solitude."

The "evil days" were those of the Restoration in its first or Clarendonian stage, with its revenges and reactions, its return to high Episcopacy and suppression of every form of dissent and sectarianism, its new and shameless royal court, its open proclamation and practice of anti-Puritanism in morals and in literature no less than in politics. For the main part of this world of

the Restoration Milton was now nothing more than an infamous outcast, the detestable blind republican and regicide who had, by too great clemency, been left unchanged. The friends that adhered to him still, and came to see him in Jewin Street, were few in number, and chiefly from the ranks of those nonconforming denominations, Independents, Baptists or Quakers, who were themselves under similar obloquy. Besides his two nephews, the faithful Andrew Marvell, Cyriack Skinner and some others of his former admirers, English or foreign, we hear chiefly of a Dr Nathan Paget, who was a physician in the Jewin Street neighbourhood, and of several young men who would drop in upon him by turns, partly to act as his amanuenses, and partly for the benefit of lessons from him—one of them a Quaker youth, named Thomas Ellwood. With all this genuine attachment to him of a select few, Milton could truly enough describe his condition after the Restoration as one of "solitude." Nor was this the worst. His three daughters, on whom he ought now to have been able principally to depend, were his most serious domestic trouble. The poor motherless girls, the eldest in her seventeenth year in 1662, the second in her fifteenth and the youngest in her eleventh, had grown up, in their father's blindness and too great self-absorption, ill-looking-after and poorly educated; and the result now appeared. They "made nothing of neglecting him"; they rebelled against the drudgery of reading to him or otherwise attending on him; they "did combine together and counsel his maid-servant to cheat him in her marketings"; they actually "had made away some of his books, and would have sold the rest."

It was to remedy this state of things that Milton consented to a third marriage. The wife found for him was Elizabeth Minshull, of a good Cheshire family, and a relative of Dr Paget. They were married on the 24th of February 1662/3, the wife being then only in her twenty-fifth year, while Milton was in his fifty-fifth. She proved an excellent wife; and the Jewin Street household, though the daughters remained in it, must have been under better management from the time of her entry into it. Meanwhile, he had found some solace in renewed industry of various kinds among his books and tasks of scholarship, and more particularly he had been building up his *Paradise Lost*. He had begun the poem in earnest, we are told, in 1658 at his house in Petty France, not in the dramatic form contemplated eighteen years before, but deliberately in the epic form. He had made but little way when there came the interruption of the anarchy preceding the Restoration and of the Restoration itself; but the work had been resumed in Jewin Street and prosecuted there steadily, by dictations of twenty or thirty lines at a time to whatever friendly or hired amanuensis chanced to be at hand. Considerable progress had been made in this way before his third marriage; and after that the work proceeded apace, his nephew, Edward Phillips, who was then out in the world on his own account, looking in when he could to revise the growing manuscript.

It was not in the house in Jewin Street, however, that *Paradise Lost* was finished. Not very long after the third marriage, probably in 1664, he removed to another house, with a garden, in "Artilery Walk, leading to Bunhill Fields." Here *Paradise Lost* was certainly finished before July 1665—Aubrey says in 1663—for when Milton and his family, to avoid the Great Plague of London, went into temporary country-quarters in a cottage in Chalfont St Giles, Buckinghamshire, the finished manuscript was taken with him, in probably more than one copy. This we learn from Thomas Ellwood, who had taken the cottage for him, and was allowed to take a copy of the manuscript way with him for perusal, during Milton's stay at Chalfont (*Life of Thomas Ellwood*, 1714). The delay in the publication of the poem may be explained partly by the fact that the official licenser hesitated before granting the necessary imprimatur to a book by a man of such notorious republican antecedents, and partly by the paralysis of all business in London by the Great Fire of September 1666. It was not till the 27th of April 1667 that Milton concluded an agreement, still preserved in the British

¹ Milton's cottage here is still standing, and is open to visitors.

Museum, with Samuel Simmons, printer, of Aldersgate Street, London, to dispose of the copyright for £5 down, the promise of another £5 after the sale of the first edition of 1300 copies, and the further promise of two additional sums of £5 each after the sale of two more editions of the same size respectively. It was as if an author now were to part with all his rights in a volume for £17, 10s. down, and a contingency of £52, 10s. more in three equal instalments. The poem was duly entered by Simmons as ready for publication in the Stationers' Registers on the 20th of the following August; and shortly after that date it was out in London as a neatly printed small quarto, with the title *Paradise Lost: A Poem written in Ten Books: By John Milton*. The reception accorded to *Paradise Lost* has been quoted as an example of the neglect of a great work, but the sale of an edition of 1300 copies in eighteen months proves that the poem found a wide circle of readers. "This man cuts us all out, and the ancients too" is the saying attributed to Dryden on the occasion; and it is the more remarkable because the one objection to the poem which at first, we are told, "stumbled many" must have "stumbled" Dryden most of all. Except in the drama, rhyme was then thought essential in anything professing to be a poem; blank verse was hardly regarded as verse at all; Dryden especially had been and was the champion of rhyme, contending for it even in the drama. That, notwithstanding this obvious blow struck by the poet at Dryden's pet literary theory, he should have welcomed the poem so enthusiastically and proclaimed its merits so emphatically, says much at once for his critical perception and for the generosity of his temper. According to Aubrey, Dryden requested Milton's leave to turn the poem into a rhymed drama, and was told he might "tag his verses if he pleased." The result is seen in Dryden's opera, *The State of Innocence and the Fall of Man* (1675). One consequence of Milton's renewed celebrity was that visitors of all ranks again sought him out for the honour of his society and conversation. His obscure house in Artillery Walk, Bunhill, we are told, became an attraction now, "much more than he did desire," for the learned notabilities of his time.

Accounts have come down to us of Milton's personal appearance and habits in his later life. They describe him as to be seen every other day led about in the streets in the vicinity of his Bunhill residence, a slender figure, of middle stature or a little less, generally dressed in a grey cloak or overcoat, and wearing sometimes a small silver-hilted sword, evidently in feeble health, but still looking younger than he was, with his lighthair, and his fair, rather than aged or pale, complexion. He would sit in his garden at the door of his house, in warm weather, in the same kind of grey overcoat, "and so, as well as in his room, received the visits of people of distinguished parts, as well as quality." Within doors he was usually dressed in neat black. He was a very early riser, and very regular in the distribution of his day, spending the first part, to his midday dinner, always in his own room, amid his books, with an amanuensis to read for him and write to his dictation. Music was always a chief part of his afternoon and evening relaxation, whether when he was by himself or when friends were with him. His manner with friends and visitors was extremely courteous and affable, with just a shade of stateliness. In free conversation, either at the midday dinner, when a friend or two happened, by rare accident, to be present, or more habitually in the evening and at the light supper which concluded it, he was the life and soul of the company, from his "flow of subject" and his "unaffected cheerfulness and civility," though with a marked tendency to the satirical and sarcastic in his criticisms of men and things. This tendency to the sarcastic was connected by some of those who observed it with a peculiarity of his voice or pronunciation. "He pronounced the letter *v* very hard," Aubrey tells us, adding Dryden's note on the subject: "*libera canina*, the dog-leetter, a certain sign of a satirical wit." He was extremely temperate in the use of wine or any strong liquors, at meals and at all other times; and when supper was over, about nine o'clock, "he smoked his pipe and drank a glass of water, and went to bed." He suffered much from gout, the effects of which had become apparent in a stiffening of his hands and finger-joints, and the recurring attacks of which in its acute form were very painful. His favourite poets among the Greeks were Homer and the Tragedians, especially Euripides; among the Latins, Virgil and Ovid; among the English, Spenser and Shakespeare. Among his English contemporaries, he thought most highly of Cowley, who had ceased to attend any church, belonged to no religious communion, and had no religious observances in his family. His reasons for this were a matter for curious surmise among his friends, because of the profoundly religious character of his own mind; but he does not seem ever to have

furnished the explanation. The matter became of less interest perhaps after 1669, when his three daughters ceased to reside with him, having been sent out "to learn some curious and ingenious sorts of manufacture that are proper for women to learn, particularly embroideries in gold or silver." After that the household in Bunhill consisted only of Milton, his wife, a single maid-servant, and the "man" or amanuensis who came in for the day.

The remaining years of Milton's life, extending through that part of the reign of Charles II, which figures in English history under the name of the "Cabal Administration," were by no means unproductive. In 1669 he published, under the title of *Accedence commenced Grammar*, a small English compendium of Latin grammar that had been lying among his papers. In 1670 there appeared, with a prefixed portrait of him by Faithorne, done from the life, his *History of Britain . . . to the Norman Conquest*, being all that he had been able to accomplish of his intended complete history of England; and in the same year a Latin digest of Ramist logic, entitled *Artis logicae plenior institutio*, of no great value, and doubtless from an old manuscript of his earlier days. In 1671 there followed his *Paradise Regained* and *Samson Agonistes*, bound together in one small volume, and giving ample proof that his poetic genius had not exhausted itself in the preceding great epic. In 1673, at a moment when the growing political discontent with the government of Charles II, and the conduct of his court had burst forth in the special form of a "No-Popery" agitation and outcry, Milton ventured on the dangerous experiment of one more political pamphlet, in which, under the title "Of True Religion, Heresy, Schism, Toleration, and what best means may be used against the growth of Popery," he put forth, with a view to popular acceptance, as mild a version as possible of his former principles on the topics discussed. In the same year appeared the second edition of his *Poems . . . both English and Latin*, which included, with the exception of the Sonnets to Cromwell, Fairfax, Vane and the second address to Cyriack Skinner, all the minor poems.

Thus we reach the year 1674, the last of Milton's life. One incident of that year was the publication of the second edition of *Paradise Lost*, with the poem rearranged as now—into twelve books, instead of the original ten. Another was the publication of a small volume¹ containing his Latin *Epistolae familiares*, together with the *Prolusiones oratoriae* of his student-days at Cambridge—these last thrown in as a substitute for his Latin state-letters in his secretaryship for the Commonwealth and the Protectorate, the printing of which was stopped by order from the Foreign Office. A third publication of the same year, and probably the very last thing dictated by Milton, was a translation of a Latin document from Poland, relating to the recent election of the heroic John Sobieski to the throne of that kingdom, with the title *A Declaration or Letters Patents of the Election of this present King of Poland, John the Third*. It seems to have been out in London in August or September 1674. On Sunday the 8th of the following November Milton died, in his house in Bunhill, of "gout struck in," at the age of sixty-five years and eleven months. He was buried, the next Thursday, in the church of St Giles, Cripplegate, beside his father; a considerable concourse attending the funeral.

Before the Restoration, Milton—what with his inheritance from his father, what with the official income of his Latin secretaryship—must have been a man of very good means indeed. **Family.** Since then, however, various heavy losses, and the cessation of all official income, had greatly reduced his estate, so that he left but £500 (worth about or over £2500 now) besides furniture and household goods. By a word-of-mouth will, made in presence of his brother Christopher, he had bequeathed the whole to his widow, on the ground that he had done enough already for his "undutiful" daughters, and that there remained for them his interest in their mother's marriage portion of £1000, which had never been paid, but which their relatives, the Pownells of Forest Hill, were legally bound for, and were now in

¹Joannis Miltonii Angli epistoliarum familiarium liber unus; quibus accesserunt ejusdem (jam olim in collegio adolescentis) prolusiones quaedam oratoriae (1674; translation by J. Hall, 1829).

circumstances to make good. The daughters, with the Powells probably abetting them, went to law with the widow to upset the will; and the decision of the court was that they should receive £100 each. With the £600 thus left, the widow, after some further stay in London, retired to Nantwich in her native Cheshire. There, respected as a pious member of a local Baptist congregation, she lived till 1727, having survived her husband fifty-three years. By that time all the three daughters were also dead. The eldest, Ann Milton, who was somewhat deformed, had died not long after her father, having married "a master-builder," but left no issue; the second, Mary Milton, had died, unmarried, before 1694; and only the third, Deborah, survived as long as her step-mother. Having gone to Ireland, as companion to a lady, shortly before her father's death, she had married an Abraham Clarke, a silk-weaver in Dublin, with whom she returned to London about 1684, when they settled in the silk-weaving business in Spitalfields, rather sinking than rising in the world, though latterly some public attention was paid to Deborah, by Addison and others, on her father's account. One of her sons, Caleb Clarke, had gone out to Madras in 1703, and had died there as "parish-clerk of Fort George" in 1719, leaving children, of whom there are some faint traces to us as late as 1727, the year of Deborah's death. Except for the possibility of further and untraced descent from this Indian grandson of Milton, the direct descent from him came to an end in his granddaughter, Elizabeth Clarke, another of Deborah's children. Having married a Thomas Foster, a Spitalfields weaver, but afterwards set up a small chandler's shop, first in Holloway and then in Shoreditch, she died at Islington in 1754, not long after she and her husband had received the proceeds of a performance of *Comus* got up by Dr Johnson for her benefit. All her children had predeceased her, leaving no issue. Milton's brother Christopher, who had always been on the opposite side in politics, rose to the questionable honour of a judgeship and knighthood in the latter part of the reign of James II. He had then become a Roman Catholic—which religion he professed till his death in retirement at Ipswich in 1692. Descendants from him are traceable a good way into the 18th century. Milton's two nephews and pupils, Edward and John Phillips, both of them known as busy and clever hack-authors before their uncle's death, continued the career of hack-authorship, most industriously and variously, though not very prosperously, through the rest of their lives: Edward in a more reputable manner than John, and with more of enduring allegiance to the memory of his uncle. Edward died about 1695; John was alive till 1706. Their half-sister, Ann Agar, the only daughter of Milton's sister by her second husband, had married, in 1673, a David Moore, of Sayes House, Chertsey; and the most flourishing of all the lines of descent from the poet's father was in this Agar-Moore branch of the Miltons.

Of masses of manuscript that had been left by Milton, some portions saw the light posthumously. Prevented, in the last year of his life from publishing his *Latin State Letters* in the *Posthumous* same volume with his Latin *Familiar Epistles*, he had committed the charge of the *State Letters*, prepared for the press, together with the completed manuscript of his Latin *Treatise of Christian Doctrines*, to a young Cambridge scholar, Daniel Skinner, who had been among the last of his amanuenses, and had, in fact, been employed by him especially in copying out and arranging those two important MSS. Negotiations were on foot, after Milton's death, between this Daniel Skinner and the Amsterdam printer, Daniel Elzevir, for the publication of both MSS., when the English government interfered, and the MSS. were sent back by Elzevir, and thrown aside, as dangerous rubbish, in a cupboard in the State Paper Office. Meanwhile, in 1676, a London bookseller, named Pitt, who had somehow got into his possession a less perfect, but still tolerably complete, copy of the *State Letters*, had brought out a surreptitious edition of them, under the title *Litterae pseudo-senatus anglicani, Cromwellii . . . nomine et jussu conscriptae a Joanne Miltone*. No other posthumous publications of Milton's appeared till 1681, when another bookseller put forth a slight tract entitled *Mr John Milton's Character of the Long Parliament and Assembly of Divines*, in 1641, consisting of a page or two, of rather dubious authenticity, said to have been withheld from his *History of Britain* in the edition of 1670. In 1682 appeared *A Brief History of Moscow, and of other less-known Countries lying eastward of Russia as far as Cathay . . . undoubtedly Milton's*, and a specimen of

those prose compilations with which he sometimes occupied his leisure. Of the fate of his collections for a new Latin *Dictionary*, which had swelled to three folio volumes of MS., all that is known is that, after having been used by Edward Phillips for his *Enchiridion* and *Speculum*, they came into the hands of a committee of Cambridge scholars, and were used for that Latin dictionary of 1693, called *The Cambridge Dictionary*, on which Ainsworth's *Dictionary* was based. In 1698 there was published in three folio volumes, under the editorship of John Toland, the first collective edition of Milton's prose works, professing to have been printed at Amsterdam, though really printed in London. A very interesting folio volume, published in 1743 by "John Nickolls, junior," under the title of *Original Letters and Papers of State addressed to Oliver Cromwell*, consists of a number of intimate Cromwellian documents that had somehow come into Milton's possession immediately after Cromwell's death, and were left by him confidentially to the Quaker Ellwood. Finally, a chance search in the London State Paper Office in 1823 having discovered the long-lost parcel containing the MSS. of Milton's Latin *State Letters* and his Latin *Treatise of Christian Doctrine*, as these had been sent back from Amsterdam a hundred and fifty years before, the *Treatise on Christian Doctrine* was, by the command of George IV., edited and published in 1825 by the Rev. C. R. Sumner, keeper of the Royal Library, and afterwards bishop of Winchester, under the title of *Joannis Miltoni Angli de doctrina christiana libri duo posthumi*. An English translation, by the editor, was published in the same year. Those state papers of Milton which had not been already printed were edited by W. D. Hamilton for the Camden Society, in 1859.

Milton's literary life divides into three almost mechanically distinct periods: (1) the time of his youth and minor poems, (2) his middle twenty years of prose polemics, and (3) the time of his later Muse and greater poems.

Had Milton died in 1640, when he was in his thirty-second year, and had his literary remains been then collected, he would have been remembered as one of the best Latinists of his generation and one of the most exquisite **Character-istics** minor English poets. In the latter character, more particularly, he would have taken his place as one of that interesting group or series of English poets, coming in the next forty years after Spenser, who, because they all acknowledged a filial relationship to Spenser, may be called collectively the Spenserians. In this group or series, counting in it such other true poets of the reigns of James I. and Charles I. as Phineas and Giles Fletcher, William Browne and Drummond of Hawthornden, Milton would have been entitled, by the small collection of pieces he had left, and which would have included his *Ode on the Nativity*, his *L'Allegro* and *Il Penseroso*, his *Comus* and his *Lycidas*, to recognition as indubitably the very highest and finest. There was in him that peculiar Spenserian something which might be regarded as the poetic faculty in its essence, with a closeness and perfection of verbal finish not to be found in the other Spenserians, or even in the master himself. Few as the pieces were, and owning discipleship to Spenser as the author did, he was a Spenserian with a difference belonging to his own constitution—which prophesied, and indeed already exhibited, the passage of English poetry out of the Spenserian into a kind that might be called the Miltonic. This Miltonic something, distinguishing the new poet from other Spenserians, was more than mere perfection of literary finish. It consisted in an avowed consciousness already of the *os magna soniturum*, "the mouth formed for great utterances" that consciousness resting on a peculiar substratum of personal character that had occasioned a new theory of literature. "He who would not be frustrate of his hope to write well hereafter on laudable things ought himself to be a true poem" was Milton's own memorable expression afterwards of the principle that had taken possession of him from his earliest days; and this principle of moral manliness as the true foundation of high literary effort, of the inextricable identity of all literary productions in kind, and their coequality in worth, with the personality in which they have their origin, might have been detected, in more or less definite shape, in all or most of the minor poems. It is a specific form of that general Platonic doctrine of the invincibility of virtue which runs through his *Comus*.

That a youth and early manhood of such potential promise should have been succeeded by twenty years of all but incessant prose polemics has been a matter of regret with many. But this

is to ignore his political and social side. If Burke, whose whole public career consisted in a succession of speeches and pamphlets, is looked back upon as one of the greatest men of his century on their account, why should there be regret over the fact that Milton, after having been the author of *Comus* and *Lycidas*, became for a time the prose orator of his earlier and more tumultuous generation? Milton was not only the greatest pamphleteer of his generation—head and shoulders above the rest—but there is no life of that time, not even Cromwell's, in which the history of the great Revolution in its successive phases, so far as the deep underlying ideas and speculations were concerned, may be more intimately and instructively studied than in Milton's. Then, on merely literary grounds, what an interest in those prose remains! Not only of his *Aeropagica*, admired now so unreservedly because its main doctrine has become axiomatic, but of most of his other pamphlets, even those the doctrine of which is least popular, it may be said confidently that they answer to his own definition of "a good book," by containing somehow "the precious life-blood of a master-spirit." From the entire series there might be a collection of specimens, unequalled anywhere else, of the capabilities of that older, grander and more elaborate English prose of which the Elizabethans and their immediate successors were not ashamed. Nor will readers of Milton's pamphlets continue to accept the hackneyed observation that his genius was destitute of humour. Though his prevailing mood was the severely earnest, there are pages in his prose writings, both English and Latin, of the most laughable irony, reaching sometimes to outrageous farce, and some of them as worthy of the name of humour as anything in Swift. Here, however, we touch on what is the worst feature in some of the prose pamphlets—their measureless ferocity, their boundless licence in personal scurrility.

While it is wrong to regard Milton's middle twenty years of prose polemics as a degradation of his genius, and while the fairer contention might be that the youthful poet of *Comus* and *Lycidas* actually promoted himself, and became a more powerful agency in the world and a more interesting object in it for ever, by consenting to lay aside his "singing robes" and spend a portion of his life in great prose oratory, who does not exult in the fact that such a life was rounded off so miraculously at the close by a final stage of compulsory calm, when the "singing robes" could be resumed, and *Paradise Lost*, *Paradise Regained* and *Samson Agonistes* could issue in succession from the blind man's chamber? Of these three poems, and what they reveal of Milton, no need here to speak at length. *Paradise Lost* is one of the few monumental works of the world, with nothing in modern epic literature comparable to it except the great poem of Dante. This is best perceived by those who penetrate beneath the beauties of the merely terrestrial portion of the story, and who recognize the coherence and the splendour of that vast symbolic phantasmagory by which, through the wars in heaven and the subsequent revenge of the expelled archangel, it paints forth the connexion of the whole visible universe of human cognisance and history with the grander, pre-existing and still envioning world of the eternal and inconceivable. To this great epic *Paradise Regained* is a sequel, and it ought to be read as such. The legend that Milton preferred the shorter epic to the larger is quite incorrect. All that is authentic on the subject is the statement by Edward Phillips that, when it was reported to his uncle that the shorter epic was "generally censured to be much inferior to the other," he "could not hear with patience any such thing." The best critical judgment now confirms Milton's own, and pronounces *Paradise Regained* to be not only, within the possibilities of its briefer theme, a worthy sequel to *Paradise Lost*, but also one of the most artistically perfect poems in any language. Finally, the poem in which Milton bade farewell to the Muse, and in which he reverted to the dramatic form, proves that to the very end his right hand had lost none of its power or cunning. *Samson Agonistes* is the most powerful drama in the English language after the severe Greek model, and it has the additional interest of being so contrived that, without any deviation from the strictly objective incidents of the Biblical story which it

enshrines, it is yet the poet's own epitaph and his condensed autobiography.

Much light is thrown upon Milton's mind in his later life, and even upon the poems of that period, by his posthumous Latin *Treatise of Christian Doctrine*. It differs from all his other prose writings of any importance in being cool, abstract and didactic. Professing to be a system of divinity derived directly from the Bible, it is really an exposition of Milton's metaphysics and of his reasoned opinions on all questions of philosophy, ethics and politics. The general effect is to show that, though he is rightly regarded as the very genius of English Puritanism, its representative poet and idealist, yet he was not a Puritan of what may be called the first wave, or that wave of Calvinistic orthodoxy which broke in upon the absolutism of Charles and Laud, and set the English Revolution agoing. He belonged distinctly to that larger and more persistent wave of Puritanism which, passing on through Independency, and an endless variety of sects, many of them rationalist and freethinking in the extreme, developed into what has ever since been known as English Liberalism. The treatise makes clear that, while Milton was a most fervid theist and a genuine Christian, believing in the Bible, and valuing the Bible over all the other books in the world, he was at the same time one of the most intrepid of English thinkers and theologians. (D. MA.; X.)

Considerable interest attaches among collectors to the variety of prints representing portraits of Milton. So far as the original contemporary portraits are concerned, which have **Portraits.** inspired the large number of engravings, the following may be mentioned: (1) The existing Janssen painting, 1618 ("aetatis suae 10"), which belonged to Mrs Milton. (2) An unknown painting of 1623 (? 1620), from which was taken an engraving in the *Gentleman's Magazine* for September 1787 ("aet. suae 12"). (3) The "Onslow" painting of Milton when a Cambridge scholar (lost), which belonged to Mrs Milton and in 1794 was in Lord Onslow's possession; a copy by Van der Gucht was made for Lord Harcourt and is still at Nuneham. (4) William Marshall's engraved frontispiece to Moseley's edition of the poems (1645). (5) William Faithorne's engraving of Milton from life, at the age of sixty-two, in Milton's *History of Britain* (1670). (6) Faithorne's original drawing for the above, belonging in 1909 to Sir R. H. Hobart. (7) The Bayfordbury (or Tonson) drawing (probably by Faithorne, or (?) by White or Richardson) at Bayfordbury Park near Hertford. (8) A drawing by George Vertue in Dr Williamson's collection. (9) A clay bust (?) by Pierce or Simon) at Christ's College. (10) A miniature by Cooper (1653), which is, however, considered by Dr G. C. Williamson not to be of Milton at all. (11) A painting by Pieter Van der Plas (d. 1704) in the National Portrait Gallery. (12) An oil painting at Christ's College. (13) The "Woodcock" miniature of Milton when about forty-eight. In Poets' Corner, Westminster Abbey, a bust by Rysbrack was put up in 1737. A monument in St Giles, Chipplegate, by John Bacon, R.A., was erected by Samuel Whitbread in 1793; and a modern statue by Horace Montford also stands there. A memorial window in St Margaret's, Westminster, with an inscription by J. G. Whittier, was presented by G. W. Childs, of Philadelphia.

BIBLIOGRAPHY.—MSS. of the poems of Milton's earlier period in his own handwriting are preserved in the library of Trinity College, Cambridge. These are not enumerated among the gifts made by Sir Henry Newton Puckering in 1691, but presumably belonged to him, and came to the library at his death in 1700, as they were found by Charles Mason, a fellow of the college, among papers and books which had been his. They were bound in a folio volume by the care of Thomas Clarke, afterwards Master of the Rolls, in 1736. Besides the poems, with many interlineations and corrections, the MSS. contains suggestions, and in some cases fully developed plans, for works generally dramatic in form. This manuscript volume, invaluable as an index to Milton's methods of work, was reproduced in facsimile (Cambridge, 1896) by W. Aldis Wright. The first complete edition of *The Poetical Works of Mr John Milton* . . . was printed by Jacob Tonson in 1695. In 1732 Richard Bentley put forward a curious edition of *Paradise Lost* in which long passages were rejected and placed in the margin on the ground that they were interpolations made possible by Milton's blindness. The Latin and Italian poems, with a translation by William Cowper,

were printed by W. Hayley in 1808. The most important of the numerous later editions of Milton's poetical works are by H. J. Todd (6 vols., 1801); J. Mitford ("Aldine edition," 3 vols., 1832); T. Keightley (2 vols., 1859), whose notes are most original and interesting; D. Masson ("Library" or "Cambridge" edition, 5 vols., 1874; of which a new edition appeared in 1890, with memoir, introduction, notes and an essay on Milton's English and versification); John Bradshaw (new "Aldine edition," 2 vols., 1892); also a careful reprint retaining the peculiarities of the earlier printed copies, by H. C. Beeching ("Oxford edition," 1904); and another, with variant readings, by W. Aldis Wright (Cambridge University Press, 1903). The prose works were first partially collected in 1697. They were edited by J. Toland (3 vols., 1698), by C. Symmons (7 vols., 1806), by Pickering (8 vols., 1851) with the poetical works, and by J. A. St John for Bohn's "Libraries" (5 vols., 1848-1853). There are numerous annotated editions of separate works.

The earliest life of Milton is contained in Wood MS. D. 4 in the Bodleian Library, Oxford, and was printed in the *Eng. Hist. Review* for January 1902, also by E. S. Parsons in *Colorado College Studies*, No. X (1903). The author, who sympathized with the poet's political views, is unknown, but the name of Milton's friend, Dr Nathan Paget, is suggested. His account formed the basis of the life given by W. Aldis Wright in *Cambridge University Press*, Wood. It was also indebted to John Aubrey, whose *Brief Lives* were not printed until later. The life by his nephew Edward Phillips was prefixed to the *Letters of State* printed in 1694, and reprinted by William Godwin in his *Lives of E. and J. Phillips* (1815). Samuel Johnson's famous *Life of Milton* (1779), which contains some valuable criticism, is written from a somewhat unfriendly standpoint. The records of Milton's official life, available in the State Papers, were first made use of by H. J. Todd in a third edition (1829) of his *Milton*. All the available information was gathered in Professor Masson's *Life of John Milton; narrated in Connexion with the Political, Ecclesiastical and Literary History of his Time* (6 vols., 1859-1880, with index, 1894; new ed. of vol. 1, 1881) which contains ample reference to original authorities. Shorter works are *Milton and seine Zeit* (2 pts., 1877, 1879), by Alfred Stern; *Milton* (1879), by Mark Pattison in the "English Men of Letters" series, and *Life of John Milton* (1890) by Dr Richard Garnett in the "Great Writers" series, with a bibliography by J. P. Anderson.

The sources of *Paradise Lost* have given rise to much discussion. It has been supposed to owe something to *Adamo*, a comedy by Giovanni Battista Andreini (1578-1652), to the *Paraphrase* associated with the name of Caedmon which was printed at Amsterdam in 1655 by Francis Junius, and to the *Lucifer* and other plays of Joost van den Vondel. Parallels between Vondel and Milton were pointed out by Mr Edmund Gosse in *Literatures of Northern Europe* (1879), and the comparison was carried further in Mr G. Edmundson's *Milton and Vondel: A Study of Literature* (1885), a book which aroused much discussion. A valuable contribution to Miltonic criticism was made in 1893 by Mr Robert Bridges in an essay on *Milton's Prosody*. This was reprinted in 1901, with some additional matter and an essay on "Classical Metres in English Verse" by W. J. Stone. Amongst other critical essays should be mentioned essays by Macaulay (*Edinburgh Review*, 1825); Walter Bagehot (*Literary Studies*, vol. i., 1879); S. T. Coleridge (*Seven Lectures on Shakespeare and Milton* 1856); Edward Dowden (*Transcripts and Studies*, 1888); Edmond Scherer (*Études sur la littérature contemporaine*, vol. vi., 1882); Augustine Birrell (*Orbiter dicta*, second series 1887); Walter Raleigh (*Milton*, 1900); E. Allodoli, *Giovanni Milton e la Prato*, 1909).

Concordances of Milton's Poetical Works were compiled by G. L. Prendergast (Madras, 1856-1857); by C. J. Cleveland (1867), based on a verbal index used in an American edition 1853, of the *Poetical Works*; by John Bradshaw (1894), by L. E. Lockwood, *Lexicon to the English Poetical Works of John Milton* (New York, 1907).

The tercentenary of Milton's birth was celebrated in 1908 in Cambridge, London and elsewhere. An exhibition of the portraits of Milton, authentic and supposed, with a great collection of valuable editions of the poet's works, was held in June and July at Christ's College, Cambridge. The catalogue of this exhibition, drawn up by Dr G. C. Williamson, forms a valuable bibliography and iconography of the poet. A collection of Milton autographs, early editions and portraits was also held in December at the British Museum, and the anniversary itself was celebrated by a special meeting of the British Academy, at which papers by Professors W. J. Courthope, Edward Dowden and others were read. There was a religious service at St Mary-le-Bow, Cheapside, and a banquet at the Mansion House.

MILTON, a township of N.E. Norfolk county, Massachusetts, U.S.A., about 7 m. S. of Boston, the Neponset river forming a large part of its N. and N.W. boundary. Pop. (1890), 4278; (1900), 6578 (1840 being foreign-born); (1905, state census), 7054; (1910) 7924. It is served by the New York, New Haven & Hartford railway, and is primarily a residential suburb of Boston, with which it is connected by electric lines. The township covers an area of about 13 sq. m., and includes the villages of

Milton, East Milton and Mattapan. The country is rolling and hilly, the Blue Hills (with the exception of a part included in Braintree in 1712 and now in Quincy) lying in Milton. On Great Blue Hill, the highest (635 ft. above tide-level), great fires were kindled at the news of the repeal of the Stamp Act, of the adoption of the Declaration of Independence, and of the surrenders of Burgoyne and Cornwallis; beacon fires were burned during the American War of Independence; an "observatory" for tourists was built at an early date; and in 1885 the Blue Hill Observatory for meteorological investigation was established by Abbott Lawrence Rotch (b. 1861), who made important investigations concerning clouds, and attracted attention by his use of kites for obtaining meteorological data. Milton Academy (a non-sectarian school) was founded in 1798, opened in 1805, and suspended in 1867; a new academy was opened in 1885. There is a public library, which was opened in 1871, and in 1909 had more than 20,000 volumes. Cunningham Park is under the control of the trustees of a fund left for the benefit of the township, and contains a gymnasium, skating-pond, tennis courts, &c., open to townspeople only. Hutchinson Field, another public park, is a part of the estate of the last royal governor, Thomas Hutchinson; Governor Jonathan Belcher also lived in Milton for a time. There are two granite quarries in the township immediately north-west of the Blue Hills; the granite is of the "dark Quincy" variety—dark bluish grey in colour—and is used chiefly for monuments. Milton, originally a part of Dorchester, was first settled in 1640, and was called Uncataquisset. The township was separated from Dorchester and incorporated in 1662. It owes its name either to its early paper and grist mills (Milton being abbreviated from Milltown) or to Milton Abbey, Dorset, whence members of the Tucker family came, it is supposed, to Milton about 1662. In 1712 the Blue Hill lands were divided between Milton and Braintree, and in 1868 part of Milton was included in the new township of Hyde Park. In Milton, on the 9th of September 1774, at the house of Daniel Vose, a meeting, adjourned from Dedham, passed the bold "Suffolk Resolves" (Milton then being included in Suffolk county), which declared that a sovereign who breaks his compact with his subjects forfeits their allegiance, that parliament's repressive measures were unconstitutional, that tax-collectors should not pay over money to the royal treasury, that the towns should choose militia officers from the patriot party, that they would obey the Continental Congress and that they favoured a Provincial Congress, and that they would seize crown officers as hostages for any political prisoners arrested by the governor; and recommended that all persons in the colony should abstain from lawlessness.

See A. K. Teele, *History of Milton, Mass., 1640 to 1887* (Milton, 1887).

MILTON, a borough of Northumberland county, Pennsylvania, U.S.A., on the Susquehanna river at the mouth of Limestone Run, about 66 m. N. of Harrisburg. Pop. (1890), 5317; (1900), 6175 (166 foreign-born); (1910), 7460. It is served by the Pennsylvania, and the Philadelphia & Reading railways, and is connected with Lewisburg and Watsonport by an electric line. Milton has an attractive public park, is in an agricultural region, and has various manufactures. It was founded in 1792, and incorporated as a borough in 1817. In 1880 it was in great part destroyed by fire.

MILWAUKEE, a city and the county-seat of Milwaukee county, Wisconsin, U.S.A., the largest city of the state, at the mouth of the Milwaukee river on the W. shore of Lake Michigan, about 85 m. N. of Chicago. Pop. (1900), 285,315; (1910), 373,857. The Milwaukee river entering the city from the north is joined about ½ m. from its mouth by the Menominee flowing from the west and a short distance from the lake by the Kinnikinnic flowing from the south. These rivers are navigable for lake traffic into the heart of the city. Milwaukee Bay, into which their combined waters empty, is an inlet of Lake Michigan, about 6 m. across. By the construction of extensive piers and breakwaters a fine harbour of refuge has been created; and its inner harbour is deep enough for the largest lake-steamer.

From the shore of the lake the land rises, rather abruptly in most places, to a height of from 75 to 100 ft. From a broad plateau overlooking the lake the land slopes gradually westward to the river, again rising on the north, west and south to a height of 125 ft. or more. The rivers separate the city into three distinctly marked divisions of varying character known as the east, west and south sides. The manufactories are largely on the "flats" along the rivers and on the south side. The extensive use as building material of cream-coloured brick made in the vicinity gives the city its nickname, "the Cream City."

The city has many beautiful parks and squares, the most picturesque of which is Juneau Park, along the lake bluff. It contains statues of Leif Ericsson and Solomon Juneau. Other parks are Lake Park, also on the lake shore, at North Point, where stands the waterworks pumping station with its tall tower; Riverside and Kilbourn Parks, east and west respectively of the upper Milwaukee river, in the northern part of the city, Washington Park on the west side, containing a menagerie and a herd of deer; Sherman Park on the west side, and Kosciusko, Humboldt and Mitchell Parks on the south side. McKinley Park on the lake shore south of the city, and Whitefish Bay 6 m. north of the city, are popular bathing resorts. In addition to the statues in Juneau Park there is a statue of Kosciusko in the park of that name; one of Washington and a soldiers' monument on Grand Avenue; a statue of Henry Bergh in front of the city hall; one of Robert Burns in the First Ward Park, and, in Washington Park, a replica of Ernst Rietschel's Schiller-Goethe monument in Jena, given to the city in 1908 by the Germans of Milwaukee. Of the several cemeteries, that of Forest Home, south-west of the city, is the largest and most beautiful. The city is well sewered, and has an excellent water-supply system owned by the municipality and representing an investment of more than \$5,000,000. The water is obtained from Lake Michigan through an intake far out in the lake. Through a tunnel $\frac{1}{2}$ m. long, constructed in 1888, water is pumped by means of one of the largest single pumps in the world from the lake into the upper Milwaukee river, which is thus completely flushed by fresh water every twenty-four hours.

Milwaukee is one of the most healthful of the larger cities of the United States. Its average annual death-rate for 1900-1904 was 13.6. The proximity of Lake Michigan cools the atmosphere in summer and tempers the cold in winter. As a result, the extremes of heat and cold are not as great as those in most inland cities. The mean monthly temperatures vary between 20° in January and 70° in July, with extremes of 100° and -25°. The mean annual precipitation is 31.4 in.

Suburbs.—Milwaukee proper occupies 22½ sq. m., a small area as compared with other cities near it in population—Detroit (36 sq. m.) and Washington, D.C. (64 sq. m.). As a result, the population has overflowed into several populous suburbs industrially a part of a "greater" Milwaukee. Of these by far the most important are the township of Wauwatosa (pop., 1905, 11,132; 1910, 11,536), and the city of the same name, separated from the township in 1897 and having in 1910 a population of 33,467; the city and township are on the Menominee river, immediately adjoining the city on the west. The first settlement was made here in 1835. Wauwatosa has important manufactures, including machinery, brick, lime, beer, chemicals and wooden-ware, and extensive market gardens and nurseries and valuable stone quarries. It has a Carnegie library, and is the seat of an Evangelical Lutheran theological seminary (1865), of Lutheran homes for the aged and orphan, of the Milwaukee county hospital for the insane, of the Milwaukee sanatorium for nervous diseases, and of the north-western branch of the national soldiers' home, which has grounds covering 385 acres and with main building and barracks affording quarters for over 2000 disabled veterans, and has a hospital, a theatre, and a library of 15,000 volumes. Within the limits of Wauwatosa also are the State Fair grounds. Other suburbs are West Allis pop., 1905, 2,306; U. S. census 1910, 6645, an incorporated rapidly growing manufacturing city on the west; Cudahy (pop., 1910, 36,911), a manufacturing village south of Milwaukee, largely devoted to meat packing; South Milwaukee (pop. 1910, 6002), an incorporated city with several large manufactories, and North Milwaukee (pop., 1910, 1860), a village immediately adjoining the city on the north.

Public Buildings, Institutions, &c.—The principal public building in the city is the Federal building (1895-1898), the post office, custom-house and local headquarters for the United States courts. The public library and museum, on the north side of Grand Avenue, in

addition to an excellent collection of natural history, palaeontology, &c., contained in 1909 a library of about 190,000 volumes. The city hall on the east side is surmounted by a tall clock-tower containing one of the largest bells in the world. The Layton Art Gallery contains one of the best collections of paintings west of the Alleghenies. The chamber of commerce, and the Pabst, Mitchell, North-Western Life Insurance, Germania Sentinel and Wells buildings, are among the principal business structures. In Milwaukee are St. John's Roman Catholic Cathedral and All Saints Protestant Episcopal Cathedral—the city is the see of a Roman Catholic archbishopric (established in 1892) and of a Protestant Episcopal bishopric. Among other church structures are Plymouth (Congregational, Westminster Presbyterian, Church of Gesu (Roman Catholic) and Trinity Lutheran. The hotels include the Pfister on the east side and the Plankinton, the Republican and the Schiltz on the west side. Among the theatres are the Davidson, Majestic, Schubert, Bijou, Alhambra and the Pabst German. During the summer there are open-air theatres in several private parks or "gardens." The social clubs include the Milwaukee, Deutscher-Concordia, University and Marquette clubs. The predominance of Germanic influence in the city is evidenced by at least 75 hospitals (3 of the *Turnverein* societies. There are 12 hospitals (3 of the *Turnverein* societies), 6 orphan asylums, 4 homes for the aged, a foundlings' home and a state industrial school for girls.

The educational institutions are numerous. Marquette University was established in 1906 by a union of Marquette College (1881), a Roman Catholic school of high rank, and existing schools of medicine, pharmacy, dentistry and law; in 1908 it added a department of engineering, and in that year it had 81 instructors and 630 students. Milwaukee-Dowder College (for girls), in the north-east part of the city was established in 1895 by a consolidation of Milwaukee College for girls, and Dowder College, formerly at Fox Lake, Ill. Other institutions are Concordia College (1881, Lutheran), a state normal school (1880), the Wisconsin College of physicians and surgeons (1893), the national German-American teachers' seminary (normal), Milwaukee academy (1864), Milwaukee University school, Milwaukee school of engineering (1904), Milwaukee *Turnverein* school of physical culture, one of the largest schools of the sort in the United States, St. John's Catholic institute, Our Lady of Mercy academy (Roman Catholic), Wisconsin academy of music, the Wisconsin school of art students' league, a Catholic normal school, St. Rose's manual training school, the industrial chemical institute (the only technical school for brewers in the United States) and several business and commercial schools. At St. Francis, adjoining the city on the south, is the seminary of St. Francis of Sales (Roman Catholic), and St. Joseph's institute for deaf mutes (Roman Catholic). The Milwaukee public school system comprises four high schools, a high school of trades, and in addition to the ordinary grades, a kindergarten department and day schools for the blind and deaf.

Transportation.—Milwaukee is favourably situated commercially, with excellent facilities for shipping both by lake and rail afforded by four trunk lines and a dozen lines of lake steamboats. It is served by the Chicago & North-Western, the Chicago, Milwaukee & St. Paul, the Minneapolis, St. Paul & Sault Ste Marie, the Grand Trunk, and the Père Marquette railways. The latter named connects with the main line at Ludington, Michigan, by means of a railway ferry across Lake Michigan; the Grand Trunk has a railway ferry from Milwaukee to Grand Haven. The city's extensive street railway system connects with interurban electric lines leading to Waukesha, Oconomowoc and Watertown on the west, Sheboygan and Fond du Lac on the north, and Chicago and intermediate points along the lake shore on the south.

Trade and Commerce.—Commercially Milwaukee is one of the most important of the inland cities of the United States, although its trade is largely domestic. It is a distributing point for a considerable part of Wisconsin, and several states farther west, its wholesale and retail trade being about \$350,000,000 annually. The country produce sold in Milwaukee averages about \$75,000,000 a year in value. The chief commodities of trade are coal, grain, lumber, flour and various products of the city's own manufactories. Milwaukee is an important grain shipping port—in 1908 it shipped 28,618,519 bushels of grain and 3,752,033 barrels of flour, and its 25 elevators have a capacity of over 12,000,000 bushels. It is one of the largest distributing centres in the country for coal, which is received by lake, and stored in enormous coal docks for transshipment by rail throughout the west and north-west. The city is a port of entry, and in 1908 its imports were valued at \$3,080,437, and its exports at only \$75,525.

Manufactures.—In 1905 the total value of Milwaukee's factory products was \$138,545, 25.3% more than in 1900. In the manufacture of malt liquors and breweries Milwaukee leads first among the cities of the United States and of the world. The total value of these products for 1905 was \$29,909,248, of which \$22,134,580 was the value of malt liquors and \$3,774,668 was the value of malt. In 1905 Milwaukee manufactured 77.1% of the malt liquors manufactured in the state and 7.4% of the entire product of the United States. Other products exceeding \$1,000,000 in value were: leather (\$14,074,397), Milwaukee being second in the manufacture of leather among the cities of the United States; foundry and machine

shop products (\$10,232,723); iron and steel (\$7,010,793); flour and grist-mill products (\$6,320,428); slaughtering and meat-packing products (\$5,958,515); men's clothing (\$4,759,548); boots and shoes (\$2,929,405); electrical machinery, apparatus and supplies (\$2,257,229); chewing and smoking tobacco (\$1,966,930) and cigars and cigarettes (\$1,540,019); furniture (\$1,767,290); trunks and valises (\$1,623,310); hosiery and knit goods (\$1,535,176); confectionery (\$1,379,668); stoves and furnaces (\$1,288,931); leather gloves and mittens (\$1,297,633); structural iron work (\$1,037,217); wooden packing boxes (\$1,024,750); and paints (\$1,015,774). Among Milwaukee's largest industrial establishments are the Pabst and the Schlitz breweries, on the west side of the city, the machine shops (35 acres) of the Allis-Chalmers Company at West Allis, employing about 5000 men and making engines of all kinds; and the plant of the Illinois Steel Company, at Bay View on the south side, which covers 154 acres. The four mills of Milwaukee have a capacity of about 12,000 barrels a day. Two of the city's tanneries are among the largest in America. In the Menominee river valley the peculiar cream-coloured Milwaukee brigs are made. North of the city on the Milwaukee river are extensive cement works.

Newspapers.—The first newspaper in Milwaukee, the *Advertiser*, began publication in 1836. The first German newspaper was established in 1844. In 1909 there were eleven daily newspapers, as follows: *Evening Wisconsin* (1847; Republican), *Free Press* (1901; Independent Republican), *Journal* (1882; Independent Democrat), *News* (1886; Independent), and *Sentinel* (1837; Republican), the oldest paper in continuous publication, *Daily Commercial Letter* (Commercial), *Reporter* (legal and commercial), *Dziennik Milwaukeecki* (Polish), *Kuryer Polski* (1888; Republican; Polish), *Germania Abendpost* (1872; Independent; German); and *Der Herald* (1854; Independent; German). Of more than a hundred other publications thirty-two, to monthly or quarterly and 22 weekly, were published in German. There are 5 Polish weekly publications, 3 Bohemian, 1 Italian and one periodical for the blind.

Population.—The population of Milwaukee in 1840 was only 1712. During the following decade there was a steady flow of immigrants from the eastern states and from Europe, with the result that in 1850, two years after the admission of Wisconsin to the Union, the population was 20,061. The population at the succeeding decennial censuses was as follows: (1860), 45,246; (1870), 71,440; (1880), 115,587; (1890), 204,468; (1900), 285,315. In 1905, according to the state census, the population was 312,948. The fact that out of a population of 285,315 in 1900, 88,991 were foreign-born, and 235,889 were of foreign parentage, that 53,854 were born in Germany, that 124,211 had both parents born in Germany, and that 26,834 additional had one or the other parent born in Germany, stamps the character of Milwaukee's population. The negro population in 1900 was only 862. The proportion of illiterates is small. Of the male population, aged 14 years or more, only 3206 (2968 foreign-born whites; 194 native-born whites) were illiterate in 1900.

Government.—Milwaukee is governed under a city charter of 1874, providing the form of city government most common in America, a mayor (elected biennially) and a single board of aldermen. There are the usual administrative boards whose members are appointed by the mayor, some of them with the approval of the board of aldermen, though the board of school directors is elected by direct popular vote. Two boards of civil service commissioners, one for fire and police departments and one for all other departments, have supervision over the city's civil service.

The assessed valuation of taxable property, in the city, in August 1906 was \$201,585,127, of which \$157,611,560 represented realty and \$43,973,567 personalty. The valuation is about 60% of the actual value. The tax rate for all purposes in that year was \$2-26 per \$100. According to a special report of the census the cost of the city government of Milwaukee in 1906 was smaller per capita than that of any other city in the country with a population of over 300,000. At the close of the year 1906 the total debt was \$8,835,049, and the funded debt was \$8,106,500.

History.—The first Europeans known to have visited the site of Milwaukee were Father Jacques Marquette, the Jesuit missionary, and his companion, Louis Joliet, who on their return in the autumn of 1673 to the mission of St Francis Xavier at De Pere from their trip down the Mississippi, skirted the west shore of Lake Michigan in their canoes from Chicago northward. Milwaukee Bay is distinctly marked in the map attributed to Marquette, the original of which is now in the Jesuit College at

Montreal, Canada; it was discovered in a convent in Montreal by Felix Martin (1804-1886), of the Society of Jesus, and was copied by Parkman. In 1679 La Salle and his party probably stopped here on their way south, and in the Jesuit *Relations* of that year the name Milwaukee first appears, as "Millioke." This, and the various other spellings of the name, attempted to reproduce the Indian name of the village here, which Kelton thinks was pronounced Minewagi and meant "there is a good point" or "there is a point where huckleberries grow," in allusion to the fertile soil. Doubtless the *coureurs du bois* who at this time began to frequent the Wisconsin forests, touched at the bay many times within the succeeding years as the place was known to be a favourite rendezvous of the Fox (or Outagamie) Indians. In 1699-1700 Father St Cosme, a Recollet friar, was here, finding bands of Mascoutens, Fox, Winnebago and Potawatomi. He called the river "Melwarik," "Melwarck" and "Meliwarik."

For more than half a century no definite reference to the place can be found. In 1760 its advantageous situation attracted the adventurous trader, Alexander Henry, the first Englishman known to have visited the spot. Three years later (1763) there was a French fur-trading post here, but it is uncertain just when it was established or how long it was maintained. In 1795 Jacques Vieu, a Frenchman in the employ of the North-Western Fur Company, established a permanent post here, which seems to have continued, under his direction, with practically no interruption until 1820, when it was superseded by that of Astor's American Fur Company. Vieu built a dwelling and a warehouse and conducted extensive trading operations. In 1818 there joined the settlement a young Frenchman named Laurent Solomon Juneau (1793-1836), who married one of Vieu's daughters and eventually bought out his business. Juneau and several others who arrived at about the same time built homes on the east side of the river near the foot of the present Wisconsin Street. Vieu's house and store was at this time on the south side. Milwaukee was on the direct route of travel between Fort Dearborn (Chicago) and the flourishing settlement at Green Bay, and at once after the treaties between the United States and the Menominee in 1831 and 1833 for the extinguishing of the Indian titles, settlers began to come to the neighbourhood. A map of 1830 shows a small settlement on "Milwaukee Bay"; and the treaty of the 8th of February 1831 speaks of the "Milwaukee or Manawauky River." Morgan L. Martin (1805-1887) of Green Bay, a lawyer and judge, and a delegate to Congress in 1845-1847 from Wisconsin territory, explored the harbour facilities in 1833 and made a map of the place which he called "Milwaukee." He entered into an agreement later in the same year with Juneau and Michael Dousman for its development. A saw-mill was built in 1834, and settlers began to arrive. The east side was platted in the summer of 1835, and very soon afterward the plat of a settlement on the west side was also recorded, Byron Kilbourn being the chief projector and proprietor of the latter. The rival settlements, officially known as Milwaukee East Side and Milwaukee West Side, bore the popular designations of "Juneautown" and "Kilbourn town." A third settlement, begun on the south side by George H. Walker and known as "Walker's Point," was subsequently platted independently. The rivalry between the east and west side towns was intense, the plats were so surveyed that the streets did not meet at the river, and there were bitter quarrels over the building of bridges. Milwaukee county was set off from Brown county in 1834, and in 1836 the establishment of townships was authorized. Under this act the east and west sides were independently incorporated in February 1837. A realization that the continuation of independent and rival corporations retarded growth eventually led to a compromise by which the two were united as two wards of the same village in 1839, the autonomy of each being still recognized by an odd arrangement whereby each maintained practically independent management of its finances and affairs. Walker's Point, the south side, was annexed as a third ward in 1845, and in 1846 the three wards were incorporated as the city of Milwaukee, of which Solomon Juneau was elected first

mayor. The influence of this early rivalry may be seen in several provisions of the existing city charter.

About 1840 a strong tide of immigration from Germany set in, continuing steadily for a half-century. It was greatly accelerated by the German revolutionary movements of the late 'forties, which added to the city's population a considerable element of educated Germans of the upper class. From this time the Teutonic character of the population was marked. The first newspaper, the *Advertiser*, began publication in 1836; the first bank was established in 1837. In 1839 George Smith and Alexander Mitchell established the Fire and Marine Insurance Company Bank. As "Mitchell's Bank" this institution was known for forty years as one of the strongest banking houses west of the Alleghenies, its notes passing at par during panics in which even the government issues were depreciated. Through it the Chicago Milwaukee & St Paul and other western railways were financed. Beer was first brewed in Milwaukee in 1840. Milwaukee was connected with Chicago by telegraph in 1849, and by railway in 1856. Previous to this, however, in 1851, the first train ran over the Chicago Milwaukee & St Paul railway to Waukesha, and in 1857 through trains were run over the same road to the Mississippi at Prairie du Chien.

See J. S. Buck, *Pioneer History of Milwaukee* (4 vols., Milwaukee, 1876-1886); A. C. Wheeler, *Chronicles of Milwaukee* (Milwaukee, 1861); E. S. Mack, "The Founding of Milwaukee" in *Proceedings of the State Historical Society for 1906* (Madison, 1907); and L. M. Larson, *Administrative History of Milwaukee* (Madison, Wisconsin, 1908).

MIMETITE, a mineral consisting of lead chloro-arsenate, $(\text{PbCl})\text{Pb}_2(\text{AsO}_4)_3$, crystallizing in the hexagonal system and closely resembling pyromorphite (*q.v.*) in appearance and general characters. The arsenic is usually partly replaced by equivalent amounts of phosphorus, and there may thus be a gradual passage from mimetite to pyromorphite. The two species can, as a rule, only be distinguished by chemical analysis, and because of their close resemblance the less frequently occurring chloro-arsenate was named mimetite or mimetites, from Gr. *μιμητις*, imitator. Crystals of pyromorphite though usually optically uniaxial are sometimes biaxial, but in mimetite this anomalous character is almost always present; a cross-section of a hexagonal prism of mimetite shows a division into six optically biaxial sectors or a complex lamellated structure. In colour mimetite is usually yellow or brown, rarely white or colourless; the lustre is resinous to adamantine. The hardness is $3\frac{1}{2}$, and the specific gravity 7.0-7.25. Like pyromorphite, mimetite is found in the upper parts of veins of lead ore, where it has been formed by the oxidation of galena and mispickel. When found in large amount it is of importance as an ore of lead. The best crystallized specimens are those from Johanngeorgenstadt in Saxony and Wheal Unity in Cornwall. It was formerly found in considerable amount at Dry Gill in Cumberland, as six-sided barrel-shaped crystals of a brownish-red or orange-yellow colour and containing a considerable proportion of phosphoric acid; this variety has been called campylite, from Gr. *καμπύλος*, curved, on account of the remarkable curvature of the faces of the crystals. (L. J. S.)

MIMICRY, in zoology, the deceptive and advantageous resemblance presented by defenceless and edible species of animals to other species of animals living in the same locality, which are harmful or distasteful and are consequently avoided by all or by a majority of the enemies of the class to which the mimetic and usually the mimicked species belong. Mimicry is a special form of protective resemblance, differing from ordinary protective resemblance as exemplified by the similarity of the resting goat-sucker to a piece of bark or of leaf- and stick-insects to the objects after which they are named, in that the imitated object belongs to the animal kingdom and not to the vegetable kingdom or to inorganic nature. Although, like protective resemblance, quite independent of affinity between the organisms concerned in the likeness, mimicry occurs most commonly between animals structurally similar, and therefore related, to one another, the relationship may be close or remote. For instance, the commonest and best-known cases are found in insects where

both mimic and model may belong to the same genus, sub-family, family or order, or to different orders. More rarely it occurs between members of distinct classes of the same sub-kingdom, *i.e.* between spiders and ants or spiders and beetles; yet even in this case both mimic and model have in common certain fundamental structural points to which the finishing touches completing the mimetic likeness are superadded. Still more rarely mimicry exists between totally unrelated species like caterpillars and snakes or spiders and snails. But in no case does it appear that the modifications in shape and colour, which contribute to bring about a mimetic resemblance, are greater and more elaborate than those which result in the simpler examples of ordinary protective resemblance.

The principle of protective resemblance, for which the term mimicry, as above defined, was originally employed, was first explained by H. W. Bates. Subsequently the meaning of the word was extended by F. Müller to include cases of mutual resemblance between two or more noxious species inhabiting the same area. Hence the resemblances belonging to the first category are commonly termed "Batesian mimicry," and those belonging to the second category "Müllerian mimicry," or more properly "Müllerian resemblance." The difference between the two phenomena is essential and evident; but without experimental information as to palatability it is impossible to know with certainty to which of the two a particular case of mimicry is to be assigned. Over and over again extended knowledge on this point and inferences drawn from other facts have shown the certainty or probability of examples of mimicry being in reality "Müllerian," which were previously accepted without question as "Batesian." A simple illustration will serve to explain these two aspects of mimicry and to show the advantage in the struggle for existence that mimicry confers upon the species concerned.

There is a common English Syrphid fly (*Eristalis tenax*) known as the drone-fly from its resemblance to a large hive or honey bee. Honey bees are protected from a large number of insect enemies because they sting and are distasteful. Insect-eating birds soon learn to associate distastefulness with the size, form and colour of the bees, and consequently leave them alone after one or more trials. But flies of the drone-fly kind cannot sting, and, so far as is known, are perfectly innocuous and edible. The advantage to the fly of its deceptive resemblance to the bees is theoretically perfectly evident and practically can be demonstrated by experiment. It is in the first place a matter of common knowledge that human beings who have been taught to avoid handling bees invariably fear to touch drone-flies, unless specially trained to distinguish the one from the others. Moreover, Professor Lloyd Morgan found that young birds that had tasted and rejected workers of the hive bee as unpalatable subsequently refused to taste not only drones, which have no sting, but also drone-flies. So far as our information at present extends the resemblance between these two insects is a simple case of mimicry in the Batesian sense of the word. That is to say, an edible species is protected by resembling one that is inedible. But if it be discovered, as is possible, that the drone-fly is also inedible, the mimicry must be ascribed to the Müllerian category, and the reason for it becomes less evident. In what way, it may be asked, are two or more distasteful species of insects, occurring in the same locality, benefited by resembling each other? The ingenious explanation suggested by Fritz Müller for similar cases met with in butterflies is probably the true answer. This explanation depends upon what is now an experimentally demonstrated fact that insectivorous birds, and probably other animals, have no instinctive knowledge of what insects are edible and what inedible. This knowledge is acquired by experience; and since it is not, at all events as a rule, taught by the first taste to any individual bird, it is reasonable to infer that a considerable amount of injury, sufficient to disable if not to kill, is annually inflicted upon insects belonging to species protected by distastefulness or kindred qualities. Now insects that possess noxious attributes, and the same is true of other animals, usually have a conspicuous warning coloration which appeals to the eyes of enemies and helps them to remember more easily the cause of an

unpleasant experience, helps in fact to establish a psychical association between a particular style of coloration and a nasty taste or a painful wound. This being so, it is evident that if all the distasteful species in a given area are differently coloured, some individuals of all the species will be annually sacrificed to the experimental tasting of inexperienced foes before the numerous lessons have been learnt. But if all the species in question resemble each other the resemblance will be mutually beneficial to them because the association between the two attributes they have in common, namely distastefulness and a particular scheme of colour, will be rapidly established. One lesson only, instead of many, has to be learnt; and once learnt at the expense of a few individuals of one or two species it will thereafter be applied indiscriminately to all. This type of mimicry has been well defined by Professor E. B. Poulton as the unification of warning colours.

Since belief in the adequacy of the two theories, above outlined, to account for the facts they profess to explain, depends ultimately upon the testimony that can be brought forward of the usefulness of warning characters, of the deception of mimicry and of the capacity for learning by experience possessed by enemies, it is necessary to give some of the evidence that has been accumulated on these points.

(1) In South America there are butterflies formerly grouped as Heliconiidae which are conspicuously coloured, slow of flight and abundant in individuals so as to be susceptible of easy capture. They possess scent glands. By observation and experiment it was discovered independently by Messrs Bates, Wallace and Bell that they are not attacked by birds nor by many other enemies that prey upon unprotected Lepidoptera. (2) As the result of a series of trials made in Calcutta F. Finn came to the conclusion that young birds have no instinctive knowledge of the unpalatability of distasteful insects, but that experimental tasting soon teaches them to recognize and avoid species they have previously rejected with dislike, and that having once learnt the lesson they long remember it.

(3) That birds may also be deceived by insects that mimic those they have found to be unactable has been shown by the above-quoted experiment with the drone-fly and the honey-bees made by Professor Lloyd Morgan. He also found that chickens that had been given meal moistened with quinine and placed upon glass slips banded black and yellow, afterwards refused to touch meal moistened with water and spread upon the same slips, although they had previously eaten it with readiness off plain coloured slips. With two exceptions, these chickens that had learnt to associate black and yellow banding with a bitter taste also refused to touch the chicken of the cinnamon moth (*Agrotis inaequalis*) which mimics with these colours. Moreover, young birds that had been taught by experience that these caterpillars are unactable also left wasps untouched. (4) Guy Marshall once offered to a baboon a distasteful butterfly (*Acraea anemosa*), holding the insect in such a way as to display its bright red and black markings to the monkey. It was taken but rejected after being tasted. A specimen of another butterfly (*Precis sesamius*) which mimics the *Acraea* was then offered in the same manner. The baboon took it, held it in her hands for a few moments, and then let it escape uninjured without trying to taste it. But when another butterfly of the same species, but with the wings cut off, was offered to her she promptly ate it without showing any sign of dislike. The results of this experiment with the baboon and of those with the birds are precisely what would be expected if the theory of mimicry is true. Experiments to test distastefulness have also been made with various kinds of insectivorous Arthropoda, like spiders and mantises. These experiments have shown that Arthropods also have their likes and dislikes in the matter of insect-food and frequently refuse to eat insects which are warningly coloured and are distasteful to vertebrate enemies. If they appear, however, to have no appreciation of mimetic and warning colours, and have therefore not influenced in any way the evolution of mimetic resemblances dependent upon hues and patterns. Nevertheless, as explained below, it seems to be highly probable that ant-mimicking insects and spiders, when the resemblance is dependent to a greater extent upon size, shape and movement than upon tint, have acquired their mimetic likeness especially to protect them from the attacks of such insect-enemies as predaceous wasps of the family Pompilidae, flies of the family Asilidae, and from so-called parasitic hymenoptera of the family Ichneumonidae, as well as from other insect-eating Arthropods.

The term mimicry has also been applied to resemblances of a different kind from the two enumerated above—resemblances, that is to say, by which predaceous species are supposed to be enabled to approach or mix without detection with animals they prey upon or victimize in other ways. To this end the resemblance may be actually to the species victimized or preyed upon or else to a species which the species preyed upon does not fear. This phenomenon is termed "aggressive mimicry" as opposed to

the Batesian and Müllerian phenomena, which are termed "protective mimicry." A few possible cases of aggressive mimicry are enumerated in the following summary of some of the recorded cases of mimicry in different classes of the animal kingdom; but the phenomenon is of comparatively rare occurrence, and the supposed instances may be susceptible of other interpretations, excluding them altogether from mimicry, or bringing them under the Batesian or Müllerian interpretation of the phenomenon.

Among mammalia there are no certain cases of mimicry known. It has been claimed that the resemblance between some of the Oriental tree-shrews of the genus *Tupaia* and squirrels comes under the category of aggressive mimicry, the tupaia being enabled by their likeness to approach and pounce upon small birds or other animals which, mistaking them for the vegetable-feeding squirrels, make no effort to get out of the way. But this hypothesis cannot be accepted as furnishing a satisfactory explanation of the likeness. For in the first place there seems to be no good reason for thinking that the Tupaia feed to any considerable extent upon prey of that kind, and in the second place the resemblance is due to characters which may be merely adaptations to a similar mode of life. A long and bushy tail, for instance, is a useful balancer and is a not uncommon feature in mammals which lead an active arboreal life. Similarly the dull coloration of the two sets of animals is very possibly procryptic and serves to hide both shrews and squirrels from enemies. Hence there seem to be good reasons for regarding the likeness in question as due to similarity in habitat and not as mimetic.

In East and South Africa there is a genus of Mustelidae known as *Ictonyx* (*Zorilla*) which possesses a foetid odour and is warningly coloured with black and white bands after the manner of skunks. There also occurs in South Africa another member of this family (*Poecilogale albinucha*), which is very similarly coloured. It is possible that this resemblance is mimetic in the Batesian sense of the word, and that the *Poecilogale*, if inoffensive, profits by its likeness to the highly offensive and warningly coloured *Ictonyx*. But, on the other hand, *Poecilogale* may itself be a protected form since subcaudal stink-glands are commonly found in species of the weasel tribe. If this be the case the two species probably furnish an instance of true Müllerian mimicry. In South America there is considerable superficial resemblance between the little bush dog (*Speothos venaticus*) of Guiana and Brazil and the large weasel-like animal of the same countries—the tayra (*Galera barbara*). The tayra is, when adult, black beneath and on the legs, and not uncommonly has a considerable quantity of grayish hair on the head. In these particulars, as well as in size and shortness of leg, the dog resembles the weasel; and since there are good reasons for believing that the latter is protected alike by ferocity and stink-glands, it is quite possible that the dog, of unusual coloration and form for the Canidae, is protected from the attacks of pumas, jaguars and ocelots by its likeness to the tayra.

A few cases of mimicry have been recorded in birds. The common cuckoo and some other species inhabiting Africa and Asia closely resemble sparrow-hawks. Some cuckoos are singular for their habit of using the nests of smaller birds to lay their eggs in, so that the young may be reared by foster-parents; and it has been suggested that the object of the likeness exhibited to the hawk is to enable the cock cuckoo either to frighten the small birds away from their nests or to lure them in pursuit of him, while the hen bird quietly and without molestation disposes of her egg. The fact that both sexes of the cuckoo resemble the hawk does not necessarily prove this suggested explanation to be false, but if it is true the smaller passerine birds are duped by the similarity to the bird of prey, it may be that the cuckoos themselves escape molestation from larger hawks on account of their resemblance to the sparrow-hawk. Another species of this group, the black cuckoo of India, apparently mimics the black drongo-shrike (*Dicrurus ater*), the resemblance between the two species being very close. The drongo is a fierce and powerful bird which will not tolerate a strange bird of the size of a cuckoo near its nest, yet on account of its resemblance to the drongo, the hen cuckoo is enabled, it has been claimed, to lay her egg in the nest of the drongo, which mistakes the cuckoo for one of its own kind. In this case also both sexes of the cuckoo mimic the drongo, whereas according to the theory it would be necessary for the hen bird alone to do so. This suggests that the resemblance to the pugnacious drongo may be beneficial in protecting the defenceless cuckoo from enemies.

Some observations, however, of Guy Marshall on the inability of certain birds suggest that the resemblance between cuckoos and hawks on the one hand and cuckoos and drongos on the other may be a suitable field of another explanation. It is well known that the theory of mimicry as propounded by Bates. He suggested that a South African drongo (*Dicrurus (Buchanga) assimilis*) was rejected after one or two attempts to eat it by a hungry mongoose (*Herpestes galera*) which had been starved for purposes of the experiment. The drongo is blue and black and is, he believes, warningly coloured. The same mongoose also refused to eat a kestrel (*Circus cinereus ruficollis*) and a hobby (*Falco subbuteo*), although it devoured certain

other birds that were given to it. It is clearly possible, therefore, that cuckoos which mimic drongos and hawks may be protected from those enemies which find these birds distasteful.

One of the most perfect cases of mimicry in birds is presented by a Madagascar thrush or babbler (*Tylas eduardi*), which resembles feather for feather a shrike (*Xenopirostris pollieni*), from the same island. The *Tylas* has departed from the normal coloration of its group to take on that of a shrike, a comparatively powerful and pugnacious bird. Analogous cases are supplied by the mimicry that exists between some of the orioles (*Mimeta*) and the friar-birds (*Phileon* or *Trospidorhynchus*) of the Austro-Malayan Islands. The friar-birds are noisy and pugnacious species of the group of honeyeaters, and mob hawks and other birds of prey, which leave them unmolested. The general style of coloration of orioles is gaudy yellow and black, rendering them invisible in sunlit foliage, and quite different from the more sombre hues of the friar-birds; but in the islands of Bourou, Timor, and Ceram the orioles have not only assumed the tints of friar-birds in general, but in each of the islands named a species of oriole has acquired the little peculiarities in colour of plumage possessed by the friar-bird of the same locality. There seem to be no reasons for doubting that these are cases of genuine protective mimicry.

Apparently the only instances of mimicry known amongst reptiles occur amongst snakes; and in all the cases quoted by Wallace harmless snakes mimic venomous species in tropical America the genus *Elops*, which is not innocuous and warningly coloured, is a model for several innocuous snakes. In Guatemala *Elops fulvus* is mimicked by *Pliocercus equalis*; in Mexico *Elops corallinus* by *Homalocercus semicinctus*, and in Brazil, *Elops lemniscatus* by *Oxyrhops trigeminus*. In South Africa the harmless egg-eating snake (*Dasyplepis scaber*) is very like the Cape adder (*Bitis atropus*); and in Ceylon the harmless Colubrine *Lycodon aulicus* is alleged to mimic *Bungarus ceylonicus*, an ally of the deadly krait of India. Considering, however, the numbers of venomous and innocuous snakes that occur in most tropical countries, it might be supposed that mimicry in this order of reptiles would be of common occurrence than appears to be the case. It must be remembered, however, that apart from size and colour all snakes resemble each other in a general way in their form and actions. They present a strong family likeness which is not found in any other terrestrial vertebrate animals with exception of some lizards and possibly Caecilians amongst the Amphibia. So close indeed is the similarity that many fear, of all snakes and do not discriminate between poisonous and non-poisonous ones. Hence it may be that innocuous snakes are in many instances sufficiently protected by their likeness in shape to poisonous species that close and exact resemblance in colour to particular species is superfluous.

As a possible instance of mimicry in fishes, A. T. Masterman recalls the fact that two species of weever (*Trachinus draco* and *T. vipera*), have the same habitat in British waters as certain species of soles (e.g. *Solea vulgaris*). The weevers are poisonous and the venom is concentrated principally in the blackness of the pectoral fin. These spines are sharp and connected by a black membrane which projects, when the fish is disturbed, as a danger signal, it is believed, above the surface of the sand in which the fishes lie hid awaiting prey. For protective purposes soles, which are edible, also lie buried in or on the sand which they match in colour, with the exception of the right or upper pectoral fin which has a large black patch. When disturbed the soles raise this black fin and, as a rule, hold it rigid so that it becomes a very conspicuous object. If the view that the sole is protected by the blackness of the pectoral fin resembling the blackness of the dorsal fin of the weever, be correct, these fishes furnish an instance of Batesian mimicry. Furthermore, there is a common littoral fish in the Mediterranean (*Uranoscopus scaber*), belonging to the same family as *Trachinus*, exhibiting the same habits and living on the same ground, which also has a jet black erectile dorsal fin, and is believed to be poisonous. It is probable that the resemblance between *Uranoscopus* and *Trachinus* with respect to the colour of the dorsal fin is mutually beneficial to the two fishes. If so, the likeness must be regarded as an instance of Müllerian mimicry.

Instances of ant-mimicry, however—and especially amongst insects—that mimicry, both Batesian and Müllerian, occurs in greatest profusion and perfection. In insects of the order Orthoptera, departure from the normal in form and colour, carrying with it similarity to other living things, usually takes the line of protective resemblance to parts of plants. This is well exemplified by the leaf-insects (*Phyllium*) and stick-insects (*Bacra*), where the likeness to the models around which they are named is so perfect, that various species of tropical Mantidae which resemble flowers for the purpose of alluring insects when striking distance and perhaps also for concealing their identity from enemies. Some cases of genuine mimicry, however, are known in the order. Perhaps the best is that of the Sudanese Locustid (*Myrmecophana fallax*), which is strikingly ant-like. The head is large, the neck slender, the antennae short and the legs longish, and the appearance of the long stalk-like waist of the ant is produced by a patch of whitish hair on each side of the forepart of the abdomen which has the effect of cutting away the parts of

the segments so covered, leaving a narrow dark-coloured median area to represent the waist. This at least is the method of disguise suggested by examination of the dried insect; but representatives of the same or an allied species found in Mashedanland were observed in the living state to be green with the antlike parts represented in black pigment. These parts were quite conspicuous against the green of the plant frequented by the insects, wherever the green portions were rendered invisible by the same background ant-mimicry has also been recorded in the case of the larva of one of the Indian species of Mantidae. Again, several species of this order have become profoundly modified in form in imitation of inedible beetles. In the Philippines, a cricket (*Scaptus pachyrhynchoides*), has taken on the shape and coloration of a species of *Apocrytus*, a hard and inedible weevil (*Curculionidae*); and *Phoraspis*, a kind of grasshopper, similarly resembles ladybirds (*Coccinellidae*). A species of beetle (*Caria dilatata*) of this family in Borneo is mimicked by a species of a genus allied to *Gammatorix* not only in shape and coloration but also in the habit of remaining still when disturbed. In the same island a species of *Gryllacris* mimics *Pheropophus aquatus*, a "Bombardier" beetle which ejects a puff of volatile formic acid when attacked; and *Condyolodera tricondyloides* mimics different species of tiger-beetles (*Cicindelidae*) at different stages of its growth. Finally the larva of one of the Bornean Mantidae, which is a floral simulator in its pupal and adult stages, closely resembles in its black and red coloration the larva of the stinking and warningly coloured beetle *Eulysia amara*.

Comparatively few cases of mimicry in the Neuroptera have been observed. There are records, however, of species of *Mantissa* mimicking the wasp *Polistes* in North America and Borneo and *Belonogaster* in South Africa; and other species of the genus imitate parasitic hymenoptera of the genera *Bracon* and *Mesolestus*.

Coleoptera (beetles) supply instances of mimicry of ants, wasps and Ichneumonids, and some defenceless forms of this order mimic other forms that are protected. A good instance of wasp-mimicry is furnished by a large heteromorous beetle (*Cobolobombus fasciaticornis*) from Borneo which is remarkably like a large wasp (*Mynimima aviculata*) from the same island. The front wings of the wasp have a conspicuous white patch near the tip and a patch similar in size and colour is present on the wings of the beetle, which, unlike the majority of beetles, habitually keeps its wings extended, and since the elytra are exceptionally short the wings are not covered by them when folded. The resemblance also extends to the general form of the body and to the length and thickness of the wings and antennae. The elytra are equally reduced, and apparently for the same purpose, in an Australian Longicorn beetle (*Esthesis ferrugineus*), which, like so many wasp-like Hymenoptera, has the body banded red and black. This beetle probably mimics the Australian hornet (*Abispa australis*). In the European Longicorn (*Clytus arietis*), on the other hand, the elytra arc of normal length and are banded with yellow stripes. The beetle, moreover, is of slender build and all its actions are suggestively wasp-like. This may, however, be an instance of Müllerian rather than of Batesian mimicry, the beetle being itself inedible; for Sheffield has a conviction that the Bornean representatives of the sub-family (Clytinae), to which *Clytus arietis* belongs, are all highly distasteful and are warningly coloured, as are members of this sub-family from other parts of the world.

In the Philippine Islands several species of Longicorns of the genus *Dolops* mimic hard inedible weevils (*Curculionidae*) of the genus *Pachyrhynchus*. The antennae of these weevils are short and end in a knob; those of the Longicorns are very much larger, but the weak middle joint is produced by the protrusion of a cone swelling upon the third joint, the terminal portion of the antenna being so extremely fine as to be almost invisible. Similar modification of the antennae in the Longicorn *Estigmenda variabilis* brings about the resemblance between this beetle and a beetle, *Estigmene chinensis*, one of the Phytophaga of the family Hispididae. Numerous instances of mimicry in this order of insects have recently been recorded from Borneo by R. W. C. Shelford, a large number of them being in all probability Müllerian.

Instances of ant-mimicry, unique in the method employed to bring about the resemblance, are supplied by some insects of the Homopterous group of the Rhynchota, belonging to the family Membracidae. In one of these (*Theronotus trimodosus*), the dorsal area of the forepart of the thorax is developed into a plate which projects backwards over the body of the insect, which retains its normal form, and conceals all but the head, wings and legs. This shield if shaped in such a manner as to resemble closely the body of an ant, the median portion of the shield being deeply notched in imitation of the waist and the central part of the subglobose like the abdomen of the ant. This insect comes from Central America. Still more curious is the mimicry of another of these insects from Venezuela which is found in company with a leaf-cutting ant (*Oecodoma cephalotes*) of that country. When pursuing their operations of leaf-storage, these ants present the appearance of a crawling crowd of leaf-particles, fragments of leaves being carried by the insects in such a way as to conceal to a great extent the insect underneath, of which little more than the dark coloured legs project beyond the membrane. The immature form of the above-mentioned species of Membracidae mimics both ant

and leaf-particulate. The legs and lower part of the body are dark coloured, but the dorsal surface of the thorax and abdomen is coloured green and is raised so as to form a crest with jagged edges exactly reproducing the irregular margin of a fragment of leaf cut out by the mandibles of the ant. In Borneo the Homoptera *Issus bruchoides* mimics a species of Curculionid beetle of the genus *Acidis*.

The Hemipterous group of the Rhynchota ant-mimicry is illustrated by the larva of a British species of Reduviidae (*Nabis laiventris*) in which the forepart of the abdomen is furnished on each side with a patch of white hairs leaving a central narrow dark portion in imitation of the waist of the ant; and also by an East African species (*Myrmoplasta mira*) in which its general form exhibits a close resemblance to an ant (*Polyrhachis gages*) which occurs in the same neighbourhood. Another instance in this group is supplied by a Bornean species of Reduviidae which mimics a species of the genus *Bracon*, one of the parasitic Hymenoptera.

Typical dipterous insects (flies) closely resemble in general form aculeate Hymenoptera belonging to the families of bees and wasps. The changes in colour and structure required to complete the resemblance to particular species are comparatively slight and much less complicated than those needed to produce a likeness to other protected insects. Hence we find that the majority of flies that mimic insects of other orders have bees or wasps for their models. Many of the Syrphidae are banded black and yellow and present a general resemblance to wasps, especially when they alight, the resemblance being enhanced by a twitching action of the abdomen imitating the similar action so familiar in species of stingless Hymenoptera. These flies are characterized by a peculiar method of flight. They commonly hang poised in the air, then dart with lightning swiftness to another spot and poise themselves again. This habit, the origin of the name "hover-flies," is probably connected with their mimetic coloration. If they flew like ordinary flies their resemblance to Hymenoptera would be obscured by the rapidity of their flight and they might be caught on the wing by insectivorous birds or other insects; but when poised they display their coloration. When the latter is lost during flight, the rapidity of their movement defies pursuit. The particular likeness to a honey-bee presented by one member of the family (*Eristalis*), has been frequently referred to. But the likeness probably goes deeper than superficial resemblance that appeals to the eye; for spiders which distinguish flies from bees by touch and not by sight, treat drone-flies after touching them, not in the fearless way they evince towards blue-bottles (*Calliphora*), but in the cautious manner they display towards bees and wasps, warily refraining from coming to close quarters until their prey is securely ensnared in silk. This forcibly suggests that the drone-fly mimics a honey-bee not only in appearance but also in the feel of its hairs or the nature of its buzz. Other flies of the genus *Volucella*, which resemble in their form the formidable humble-bee in colour and form, and it was formerly supposed that the purpose of this similarity was to enable the flies to enter with impunity the nests of the humble-bees and to lay their eggs amongst those of the latter insects. But it has been ascertained that the species of *Volucella* which behave in this manner also visit for a like purpose the nests of wasps, which they do not resemble. Hence it is probable that this case of mimicry is purely of a protective and not of an aggressive nature and serves to save the flies from destruction by insectivorous enemies. The same explanation no doubt applies to the mimicry by flies in Borneo and Africa, of hairy bees of the family Xylocopidae by Asilid flies of the genus *Hyperechia*, and also to other cases of mimicry of Hymenoptera as well as of inedible beetles of the family Lycidae by Diptera. Numerous other cases of mimicry between Diptera and Hymenoptera might be cited.

The Lepidoptera furnish more instances of mimicry, both Batesian and Müllerian, than any other order of insects. In the majority of cases both model and mimic belong alike to the Lepidoptera, and it is often uncertain whether both are inedible (Müllerian mimicry) or whether inedibility is the attribute only of the model (Batesian mimicry). A large number of cases that were formerly regarded as belonging to the latter category are now suspected of belonging rather to the former. Sometimes Lepidoptera mimic protected members of other orders of insects—such as Coleoptera, Hymenoptera and Hemiptera; but perhaps the most singular illustrations of the phenomenon known in the order are exemplified by the larvae of the hawk-moth *Chaerocampa*, which imitate the heads of snakes. Professor Poulton long ago suggested, and supported the suggestion by experimental evidence on a lizard, that the larvae of two British species, *C. elenor* and *C. porcellus*, are protected by the resemblance to snakes. The anterior end of the anterior extremities of their bodies which are ornamented with large eye-like spots. When the larvae are disturbed the similarity is produced with startling suddenness by the telescopic contraction of the anterior segments in such a manner as to suggest a triangular, pointed head with two large dorsal eyes. Subsequent observers (A. Weismann, Lady Verney) have shown by experimenting upon birds that this suggestion is correct; and Guy Marshall found that baboons which are afraid of snakes are also afraid of the snake-like larva of the South African *Chaerocampa ostris*. Finally Shelford states that the anterior end of a Bornean species

(*C. myodon*) offers a striking and detailed resemblance to the head of a snake (*Dendrophis picta*).

Instances of ant-mimicry in this order are sometimes confined to the larval stage. The early larval stage of the "Lobster Moth" (*Stauropus fagi*) for example, presents a general resemblance, due to a combination of shape, colour, attitude and movements, to black ants, the swollen head and the caudal disk with its two tentacles respectively resembling the head and antennae-bearing head of the model. A parallel case of mimicry exists at Singapore between the larva of a Noctuid moth and the common red tree-ant (*Oecophylla smaragdina*). In this case also the posterior end of the larva resembles the anterior end of the ant. Another instance of mimicry affecting the larval form is supplied by the moth *Endromis versicolor*, the caterpillars of which resemble the inedible larva of saw-flies. The resemblance that certain moths—e.g. *Trochilium apiforme*, *crabroniforme*—present to bees and wasps is effected in the main by the loss of the scales from the wings, leaving these organs transparent. It is important to note that the scales are present when the moths first emerge from the pupa-case, but are loosely attached and fall off with the first flight.

Of the multitudes of cases of mimicry between different species of Lepidoptera, a few only can be selected for description. These cases, however, have a peculiar interest and importance for they have been studied in fuller detail than any others and the discovery of a particular instance in South America first suggested to Bates the theoretical explanation of this biomimetic phenomenon. On the Amazons and in other parts of South America there are butterflies of the group Ithomiinae which are distasteful to all the characters of especially protected species, being in general brightly colored, slow of flight, careless of exposure and abundant in individuals. The wings are transparent and are black-bordered and black-barred, the anterior wing having two black bars and the posterior one. This type of colouring is also found in genera of quite distinct sub-families of butterflies, namely in Danaïnae and Pierinae, as well as in some diurnal moths, all of which occur in the same district as the Ithomiinae. The following species may be cited as instances of this type of pattern: *Melthoa confusa*, *Thyrida pisonei*, *Eutresis imitatrix* and *Digerena dero* (Ithomiinae); *Isura idonea* and *I. phaneraea* (Danaïnae); *Antionomopsis oris* (Pierinae); *Anthomyia buckleyi* (moth of the family Pericopidae) and *Castania linus* (moth of the family Castniidae). So alike in form, colour and mode of flight are these Lepidoptera that when on the wing it is almost or quite impossible to distinguish one from the other, and the resemblance between members belonging to different sub-families cannot be assigned to affinity. Microscopical examination of the wings, moreover, has shown that the transparency of the wings, common to all, has been acquired by a different modification of the scales in each of the genera exhibiting the Ithomiine type of coloration. That the Danaïnae, to which the Ithomiinae are distasteful is known, *Isura*, for example, belonging to the former, has protuberant scales on the wing processes at the end of the abdomen; and *Thyridia* has scent-producing tufts of hair on the edge of the posterior-wing. Bates offered no satisfactory explanation of the resemblance between these two genera and others of the same protected sub-families; but he did not hesitate to ascribe the resemblance to them presented by the Pierine, *Dismorphia* (*Lepialis*) *orise*, to mimicry, believing *Dismorphia* to be unprotected and noting that it departed widely in the matter of coloration from typical members of the sub-family to which it belongs. Although mimicry in the Lepidoptera has been carried to a greater extreme in *Scythris* than in any other genus of the world, remarkable instances of it have taken place in the Ethiopian and Oriental regions. A classical and highly complex case first investigated and explained by R. Trimen is that of *Papilio dardanus* which is widely distributed in Africa and is represented by several sub-species or geographical races. The most primitive of these is *antimoris* from Abyssinia, which is non-mimetic and has the two sexes nearly alike. The males of the other sub-species are much like the males of *antimoris*; but the females are widely different and mimic various species of inedible butterflies belonging to the protected groups of the Danaïnae and Acraeinae. One of these sub-species, *melpis*, which ranges from the west coast to Victoria Nyanza, is polymorphic and occurs under three forms, namely (a) *hippocoon*, which mimics the Danaïne *Amauris nivioides*; (b) *trophonius*, which mimics the Danaïne *Limnys chryssippus*; (c) *planoides*, which mimics the Acraeinae *Planeta poggei*. Oddly enough one or more of these forms may occur in other sub-species. For example, the sub-species *cenea* which occurs in south and south-east Africa not only has the form *cenea* mimicking two Danaïnes, *Amauris echeria* and *A. albimaculata*, but also the *hippocoon* form which resembles the local races of *Amauris nivioides*, known as *dominica* and *trifasciata*, and *polytrichus* from the Kivu. Elsewhere also has the *planoides* and *cenea* forms and another form *trimeni*, which is intermediate between the unmodified female of *antimoris* and *hippocoon*, and like the latter is mimetic of *Amauris nivioides dominicana*. Finally the sub-species *tibullus* from the east coast has the *cenea*-form, the *trimeni*-form and probably the *planoides*-form. The study of this intricate case is not yet completed and it is at present unknown whether it is an instance of Batesian or Müllerian mimicry. Special attention may be drawn to two phenomena connected with it, both of not uncommon occurrence in

mimetic Lepidoptera. The first is the occurrence of mimicry only in the female sex. The reason for this is to be found in the greater need of protection of the female which is slower in flight than the male and is exposed to special danger of attack when resting to lay her eggs. The second noteworthy phenomenon is the mimicry of more than one protected species by members of a single species. This is a not uncommon occurrence, and in the case of Batesian mimicry the explanation is probably this. When an edible species gains protection by mimicking a distasteful one, there is a likelihood of its increasing in numbers until it equals or surpasses its model in this respect. Were this to take place the purpose of the mimicry would be abortive, because enemies would probably not refrain from slaughter if even every alternate capture proved palatable. It is advantageous therefore that the numbers of the mimetic species should be fewer than those of the model; and this appears to be achieved in some cases by the individuals of the mimetic species dividing themselves between two or more models.

Spiders furnish numerous instances of mimicry. Though simple in kind, many of these are as perfect illustrations of the phenomenon as any found in the animal kingdom.

Amongst the orbweavers of the family Argypoidae there are species belonging to the genera *Cyclosa* and *Cyrtophora* which closely resemble the small black gastropods as they cling to the underside of leaves with their legs drawn up. Other members of the same family—like *Aranes coccinella*, and *Paraplectana thorntoni*—imitate beetles of the family Coccinellidae which are known to be distasteful; and certain genera of the family Salticidae (*Homalattus* and *Rhaxis*) closely resemble small hard-shelled beetles.

The most perfect cases, however, are exhibited by those species which imitate ants. The structural modifications required to convert a spider into the image of an ant are of a more complicated character than those that serve the same purpose in an insect. All insects have the same regional division of the body into head, thorax and abdomen, the same number of legs, a pair of antennae and a segmented abdomen. Spiders, on the other hand, have a separate "head," an unsegmented abdomen and an additional pair of legs. In the majority of ant-imitating spiders the forepart of the cephalothorax is constricted on each side to resemble the neck of the insect, and in many cases the similarity is increased by the presence of a stripe of white hairs which has the optical effect of cutting out an extra piece of integument, exactly as occurs in analogous cases in insects. Narrowing of the posterior portions of the spider's cephalothorax and sometimes of the anterior end of the abdomen reproduces the slender waist of the ant, and frequently transverse bands of hairs represent the segmentation of this region in the insect. The legs become slender and those of the front pair are separated from the rest and carried in front of the head to simulate the antennae of the ant. Added to this the spiders commonly copy to the life the mode of progression and the restless activities of their models.

The likeness presented varies considerably in degree from a general resemblance to several species, such as is seen in the Salticid spider (*Pechhamia picata*) of North America, to a close similarity to particular species. To this category belong *Myrmarchae plateloides*, one of the Salticidae, and *Amyciaea forticeps*, one of the Thomisidae which in India imitates and live with the vicious little red ant (*Oecophylla smaragdina*); also *Myrmarchae providens*, which mimics the red and black Indian ant (*Sima rufonigra*); and the South American species of Clubionidae, *Pachycnoida alyrum*, which is an accurate copy of the large black ant (*Myrmecodynia villosa*).

Sometimes it is only the males of a species of spider that mimic ants, as in the case of *Ideobaha mutiloides* and *I. myrmicaeformis*, two South American species of the family Argypoidae, in which the females are protected by strong spine-armature. The males are without these protective spines and are exposed to special dangers as they wander in search of the webs of the females. In South Africa too the males of a species of Eresidae (*Seothyra*) resemble and are found in company with a large ant (*Camponotus fulvopilosus*), which is common on the veld. Like the males of *Ideobaha*, those of *Seothyra* wander about by day in search of the females which live concealed in burrows. Many other spiders belonging to the Theridiidae and Linyphiidae also mimic ants; but it is needless to enumerate and the most perfect examples of this phenomenon being found in the families Clubionidae and Salticidae.

Ant-mimicking spiders have been seen now and again to devour their models. It has therefore been suggested by some and taken for granted by others that the resemblance comes under the category of aggressive mimicry and that the ants are deluded by this resemblance into regarding the spiders as members of their own species. That the ants do not destroy them is certain; but that they are deceived by the superficial similarity of the spiders to themselves is highly improbable, for these insects are capable of distinguishing an enemy ant belonging to the same species if it comes from another colony. Moreover, the above-suggested explanation does not coincide with the explanation of the likeness to ants shown by certain insects such as *Myrmecophana fallax*, the ant and leaf-like Membracid Homopteron and the larvae of the lobster-moth (*Stauropus fagi*), which are plant-eaters. It is probable that one explanation—namely, that of protection—covers all cases of ant-mimicry; and this explanation lies in all probability in the immunity from the attacks

of most insectivorous enemies that ants enjoy, and especially from predaceous wasps of the family Pompilidae which annually destroy thousands upon thousands of spiders to feed their larvae; and since more than one observer has testified to the fear and abhorrence these wasps have of ants, it is needless to look farther for the benefit ant-mimicry is to spiders. These wasps, moreover, also provision their nurseries with caterpillars, grasshoppers and other insects. Hence it may be inferred that the insects which imitate ants profit in the same way that spiders do from this form of mimicry.

In the above-cited historical instance of mimicry amongst some South American Lepidoptera which formed the foundation of Bates' theory, species of butterflies, belonging to the Ithomine genus *Ithra* and the Danae genus *Thyridia*, both unpalatable forms, resemble each other. This is a very simple case of the possession of the same type of coloration by two or more protected insects inhabiting the same district. The significance of this phenomenon, as already stated, was first explained by Fritz Müller; but although the term "Müllerian mimicry" has been assigned to this and similar instances, they are not strictly speaking cases of mimicry at all but of warning coloration. Poisonous or noxious animals usually have some special advertising attribute, sometimes the display of conspicuous coloration, as in the skunk; sometimes the emission of some odour, as in the rattlesnake; sometimes the possession of the two, as in the common porcupine and the large black scorpions of Africa and India. Such characters have been termed by Professor Poulton "aposematic." Neither of the above-mentioned animals is mimicked; but where two or more noxious animals, inhabiting the same district, resemble each other, both being aposematically or warningly coloured, the likeness is said to be "synosematically." Synosemasy is Müllerian mimicry. Finally, the likeness of an edible species to a warningly coloured inedible one in the same locality is termed "pseudoposematically," in allusion to the pretentiousness or falsity of the warning signal. Pseudoposemasy is Batesian mimicry.

An important phenomenon connected with insect mimicry is the convergence of several species in the same area towards a common type of coloration and shape, exhibited by one or more than one protected form. The resemblance shows various grades of completeness; and the convergent mimics may be themselves noxious, or edible and innocuous. In other words the insects entering into the combination may furnish instances of Batesian and of Müllerian mimicry. Very commonly different species of aculeate Hymenoptera, inhabiting the same district, form the centres of mimetic attraction for insects of various orders, so that a considerable percentage of the insect-launa can be arranged in groups according to the pattern of the particular model that the species resemble. The illustrations of this law have been discovered by G. C. Marshall in Mashonaland. He found on the same day on a bud of vetch, specimens of black ants (*Camponotus sericeus* and *C. cosmicus*), black ant-like Hemipterous insects (*Megapetus atratus*) and the ant-like Orthopteron (*Myrmecophana fallax*) (cf. supra). In this little coterie the ants are beyond question the models towards which the bug and the grasshopper have converged in appearance. Since many of the insects of the order Hemiptera are distasteful, the mimicry of the bug (*Megapetus*) is in this case probably Müllerian or synosematically; the grasshopper (*Myrmecophana*), on the other hand, is probably edible and the mimicry is Batesian or pseudoposematically. This is a simple case consisting of a small number of component species. Others are more complex, numerous species being involved. In Mashonaland, for instance, a large number of genera and species of Hymenoptera belonging to the Apidae, Eumenidae, Sphegidae, Pompilidae, Scollidae, Tiphiidae and Mutillidae, resemble each other in having black bodies and dark blue wings. The same style of coloration is found in Coleoptera of the families Cetoniidae and Cantharidae; in Diptera of the families Asilidae, Bombyliidae, Tabanidae and Tachinidae; in Hemiptera of the family Reduviidae and in Lepidoptera of the family Zygaenidae. In this instance the Hymenoptera, of which the coloration is synosematically, form together a composite model which the other insects have mimicked. Of the latter, the Lepidopteron (*Taxia homocidus*) is distasteful, as also are the beetles of the family Cantharidae (e.g. *Lytta moesta*). Probably the bugs too (e.g. *Harporator tristis*) are protected. The mimicry of these insects therefore is synosematically; but some, at all events, of the flies like the Bombylid *Exoprosopa umbrosa*, probably form pseudoposematically elements in the group. Into another category Hymenoptera enter not as models but as mimics, the models being inedible Malacoedermatous beetles mostly belonging to the genus *Lycus* and characterized by orange coloration set off by a large black patch upon the posterior end of the elytra and a smaller black spot upon the thorax. Towards this Lycoid centre have converged Coleoptera (beetles) of the sub-order Lamellicornia (Corycids), Phytobagids, Heteromera (Cantharidae) and Longicornia; Hemiptera of the families Pyrrhocoridae, Lygaeidae and Reduviidae; Lepidoptera of the families Arctiidae and Zygaenidae; Diptera of the family Asilidae; and lastly Hymenoptera of the families Braconidae, Pompilidae, Crabronidae and Eumenidae. With the exception of the Asilid fly and perhaps some of the Longicorn and Phytophagous beetles, which are probably protected Batesian mimics, all the other species constituting the above-mentioned assemblage are, it is believed, Müllerian or synosematically mimics. In the three cases

ited above, with the exception of the first, the synapomorphic mimics are vastly in excess of the pseudoposematic; this appears to be the general rule elsewhere. Frequently the groups are composed solely of protected species, so far as is at present known; and sometimes solely, in all probability, of unprotected species with exception of course of the model. An example of the latter occurs in Singapore where the vicious red spinning-ant (*Oecophylla smaragdina*) is mimicked by the larva of a Noctuid moth and by spiders belonging to two distinct families, namely, *Salticoides platealoides* (Salticidae) and *Amyciaea forticeps* (Thomisidae), there being no reason to suppose that either the moth larva or the spiders are protected forms. Mimetic aggregations of species similar to those mentioned above have been found in other countries; but the instances cited are sufficient to show how widespread are the influences of mimicry and how profoundly it has modified the insect fauna of various parts of the world.

BIBLIOGRAPHY.—H. W. Bates, *Trans. Linn. Soc. (Lond., 1862)*; id. *The Naturalist on the Amazons (1879)*; T. Belt, *The Naturalist in Nicaragua (2nd ed. 1888)*; F. A. Dixey, *Rep. Brit. Assoc. (1894)* p. 692; id. *Tr. Ent. Soc. (Lond., 1894)*, p. 249; id., *op. cit.* (1896); p. 65; id., *op. cit.* (1897), p. 317; also *Proc. Ent. Soc. (Lond., 1897)*, pp. xx-xxxix; and xxxiv-xlvii; F. Finn, *Journ. Asiatic Soc. Bengal*, lxxv, (1895); lxxv, (1896) and lxxvi, (1897); E. Haase, *Bibliotheca zoologica*, (1891-1893, Stuttgart); English trans. by C. M. Child, 1896); G. A. K. Marshall, *Trans. Ent. Soc. (Lond., 1902)*, pp. 287-584 (annotated by E. B. Poulton); A. T. Masterman, *Journ. Linn. Soc.*, xxx, 230-244 (1908); R. Meldola, *Proc. Ent. Soc. Lond.* (1877), p. 12; id. *Ann. Mag. Nat. Hist.* (5th s.) (1882); C. Lloyd Morgan, *Habit and Instinct (Lond., 1896)*; id. *Animal Behaviour*, pp. 164-165 (Lond., 1900); F. Müller, *Kosmos* (May 1879), p. 100; (trans.) *Proc. Ent. Soc. Lond.* (1879), xx.; A. Newton, *A Dictionary of Birds*, p. 572-575 (Lond., 1893-1896); E. G. Peckham, *Occasional Pap. Nat. Hist. Soc. Wisconsin*, i. (1889); R. I. Pocock, *Journ. Linn. Soc. Zool.*, pp. 256-270 (1909); id. *Proc. Zool. Soc. Lond.*, 944-950 (1909); E. B. Poulton, *Proc. Zool. Soc. Lond.* (1887), 191-274; id. *The Colours of Animals*, 216-244 (1890); id. "Natural Selection the Cause of Mimetic Resemblance and Common Warning Colour," *Journ. Linn. Soc. Zool.*, xxvi, (1898); revised and amplified in *Essays on Evolution*, pp. 220-270 (1908); id. "Mimicry and Natural Selection," *Verhandl. d. V. internat. zool. Congr. Berlin* (Jena, 1902); revised in *Essays on Evolution*, 271-292; id. "The Place of Mimicry in a Scheme of Defensive Coloration," *Essays on Evolution*, pp. 293-382 (1908); W. P. Pycraft, *The Story of Bird Life*, pp. 32-43 ("Mimicry"), (1899); W. Roeloffs, *C.R. Soc. Ent. Belg.* (2), No. 59 (1878); R. Shelford, *Proc. Zool. Soc.* (1902), ii. part 2, 230-284; R. Trimen, *Trans. Linn. Soc.*, xxvi, p. 497 (1870); A. R. Wallace, *Proc. Zool. Soc. (1863)*, pp. 26-28; id. *Trans. Linn. Soc.*, xxv, pp. 19-22 (1866); id. *The Malay Archipelago*, ii. (Lond., 1859); id. *Contributions to the Theory of Natural Selection*, pp. 103-106 (Lond., 1875); id. *Darwinism*, pp. 239-265 (Lond., 1889); A. Weismann, *The Evolutionary Theory*, Eng. trans. (Lond., 1904). (R. I. P.)

MIMNERMUS of Colophon, Greek elegiac poet, flourished about 630-600 B.C. His life fell in the troubled time when the Ionic cities of Asia Minor were struggling to maintain themselves against the rising power of the Lydian kings. One of the extant fragments of his poems refers to this struggle, and contrasts the present effeminacy of his countrymen with the bravery of those who had once defeated the Lydian king Gyges. But his most important poems were a set of elegies addressed to a flute-player named Nanno, collected in two books called after her name. Mimnermus was the first to make the elegiac verse the vehicle for love-poetry. He set his own poems to the music of the flute, and the poet Hipponax says that he used the melancholy *vibros kradsis*, "the fig-branch strain," said to be a peculiar melody, to the accompaniment of which two human purificatory victims were led out of Athens to be sacrificed during the festival of Thargelia (Hesychyus, s.v.).

Edition of fragments in T. Bergk, *Poetice lyrici Graeci*; see also G. Vanzolini, *Mimnermo* (1883), a study of the poet, with notes and a metrical version of the fragments.

MIMOSA (so named from the movements of the leaves in many species which "mimic" animal sensibility), a genus of the natural order Leguminosae, which gives its name to the large sub-order *Mimosaceae* (characterized by usually small regular flowers with valvate corolla), to which belongs also the nearly allied genus *Acacia*. They are distributed throughout almost all tropical and subtropical regions, the acacias preponderating in Australia and the true mimosas in America. The former are of considerable importance as sources of timber, gum and tannin, but the latter are of much less economic value, though a few, like the taly (*M. ferruginea*) of Arabia and Central Africa, are important trees. Most are herbs or undershrubs, but some South American species are tall woody climbers. They are often prickly

The roots of some Brazilian species are poisonous, and that of *M. pudica*, has irritating properties. The mimosas, however, owe their interest and their extensive cultivation, partly to the beauty of their usually bipinnate foliage, but still more to the remarkable development in some species of the sleep movements manifested to some extent by most of the pinnate Leguminosae, as well as many other (especially seedling) plants. In the so-called "sensitive plants" these movements not only take place under the influence of light and darkness, but can be easily excited by mechanical and other stimuli.

When stimulated—say, at the axis of one of the secondary petioles—the leaflets move upwards on each side until they meet, the movement being propagated centripetally. It may then be communicated to the leaflets of the other secondary petioles, which close (the petioles, too, converging), and thence to the main petiole, which sinks rapidly downwards towards the stem, the bending taking place at the pulvinus (*p* in figure) or swollen base of the leafstalk. When shaken in any way, the leaves close and droop simultaneously, but if the agitation be continued, they reopen as if they had become accustomed to the shocks. The common sensitive plant of hot-houses is *M. pudica*, a native of tropical America, but now naturalized in corresponding latitudes of Asia and Africa, but the hardly distinguishable *M. sensitiva* and others are also cultivated. Species of the closely allied genus *Schrankia* are known as sensitive-briar in the southern United States.

MIMULUS, in botany, a genus (nat. order Scrophulariaceae), of showy, hardy or half-hardy, herbaceous, rarely shrubby plants, natives of the extra-tropical or mountainous parts of both old and new worlds excepting Europe, but chiefly American. The plants have opposite, undivided leaves, and axillary, generally solitary flowers with a two-lipped, gaping corolla. The herbaceous species thrive best in damp situations; the shrubby species, of which *M. gluiniflorus* (formerly called *Diplacus*) is best known, are adapted for pot culture in the greenhouse. *M. luteus*, the monkey-flower of gardens, has yellow flowers with two dark marks in the mouth of the corolla; *M. Langsdorffii*, an American species, has become naturalized by river-sides in many parts of Britain.

M. moschatulus, musk, a native of north-western America, with small, nearly regular, yellow flowers, diffuse hairy stem and hairy scented leaves, is a well known and favourite perennial for pot culture and outside borders.

MINA, FRANCISCO ESPOZ Y (1781-1836) Spanish guerrillero leader and general, was born at Ydozin in Navarre on the 17th of June 1781. His father, Juan Esteban Espoz y Mina, and his mother Maria Teresa Hundain y Ardaiz, belonged to the class of yeomen. Mina remained working on the small family inheritance till 1808. When Napoleon endeavoured to seize Spain in that year he enlisted in the regiment of Doyle, and then passed to the guerrilla band commanded by his nephew Xavier Mina. When Xavier was captured by the French on the 21st of March 1810, seven men of the band elected to follow Francisco; and on the 1st of April of the same year the Junta of Aragon gave him the command of the guerrilleros of Navarre. His first act was to arrest and shoot at Estella, one Echevarria, who, under pretence of being a patriotic guerrillero, was in fact a brigand. The national government at Cadiz gave him rank, and by the 7th of September 1812, he had been promoted to be commander-in-chief in Upper Aragon, and on the left bank of the Ebro. In the interval he claimed that he had fought 143 actions big and little, had been repeatedly wounded with bullet, sword and lance, had taken 13 fortified posts, and 14,000 prisoners, and had never been



surprised by the French. Though some maintain that he was not at his best as a leader in battle, as a strategist he was very successful, and he displayed great organizing capacity. The French authorities were compelled to allow him to levy customs dues on all goods imported into Spain, except contraband of war, which he would not allow to pass without fighting. The money thus obtained was used to pay his bands a regular salary. He was able to avoid levying excessive contributions on the country and to maintain discipline among his men, whom he had brought to a respectable state of efficiency in 1812. Mina claimed that he immobilized 26,000 French troops which would but for him have served with Marmont in the Salamanca campaign. In the campaign of 1813 and 1814 he served with distinction under the duke of Wellington. After the restoration of Ferdinand he fell into disfavour. On the 25th and 26th of September he attempted to bring about a rising at Pamplona in favour of the Liberal party, but failed, and went into exile. His political opinions were democratic and radical, and as a yeoman he disliked the *hidalgos* (nobles). The revolution of 1820 brought him back, and he served the Liberal party in Galicia, Leon and Catalonia. In the last district he made the only vigorous resistance to the French intervention in favour of Ferdinand VII. On the 1st of November 1825 he was compelled to capitulate, and the French allowed him to escape to England by sea. In 1830 he took part in an unsuccessful rising against Ferdinand. On the death of the king he was recalled to Spain, and the government of the regent Christina gave him the command against the Carlists in 1835, though they feared his Radicalism. By this time, years, exposure and wounds had undermined his health. He was also opposed to Thomas Zumalacarre (q.v.), an old officer of his in the War of Independence, and an even greater master of irregular mountain warfare. His health compelled him to resign in April 1835, and his later command in Catalonia was only memorable for the part he took in forcing the regent to grant a constitution in August 1836. He died at Barcelona on the 24th of December 1836. Mina was a brave and honest man, who would have conducted the war against the French in 1810-12 with humanity if they had allowed him, but as they made a practice of shooting those of his men whom they took, he was compelled to retaliate. He finally forced the French to agree to an exchange of prisoners.

AUTHORITIES.—In 1825 Mina published *A Short Extract from the Life of General Mina*, in Spanish and English, in London. Mention is made of him in all histories of the affairs of Spain during the first third of the 19th century. His full Memoirs were published by his widow at Madrid in 1851-1852. (D. H.)

MINARET (from the Arabic *manārat*; *manar* or *minar* is Arabic for a lighthouse, a tower on which *nar*, fire, is lit), a lofty, turret peculiar to Mahomedan architecture. The form is derived from that of the Pharos, the great lighthouse of Alexandria, in the top storey of which the Mahomedan conquerors in the 7th century placed a small praying chamber. The lighthouse form is perpetuated in the minarets which are found attached to all Mahomedan mosques, and probably had considerable influence on the evolution of the Christian church tower (see an exhaustive study in Hermann Thiersch, *Pharos Antike, Islam und Occident*, 1909). The minaret is always square from the base to the height of the wall of the mosque to which it is attached, and very often octangular above. The upper portion is divided into two or three stages, the wall of the upper storey being slightly set back behind the one below, so as to admit of a narrow balcony, from which the *azan*, or call to prayer, is chanted by the *muazzin* (*muazzin*, *moeddin*). In order to give greater width to the balcony it is corbelled out with stalactitic vaulting. The balconies are surrounded with stone balustrades, and the upper storeys are richly decorated; the top storey being surmounted with a small bulbous dome. The earliest minaret known is that which was built by the caliph Walid (A.D. 705) in the mosque of Damascus, the next in date being the minaret of the mosque of Tulun, at Cairo (A.D. 879), with an external spiral flight of steps like the observatory towers in Assyrian architecture. This minaret as also the example of El Hakim (996), is raised on great square towers. The more remarkable of the other Cairene minarets are those of Imam esh-Shafi' (1218), Muristan al Kalaun (1280),

Hassan (1354), Barkuk (A.D. 1382) and Kait Bey (A.D. 1468). Of the same type are the two minarets added to the mosque of Damascus in the 15th century. In Persia the minarets are generally circular, with a single balcony at the top, corbelled out and covered over. In India, at Ghazni, there are no balconies, and the upper part of the tower tapers upwards; the same is noticeable at Delhi, where the minaret of Kutab is divided into six storeys with balconies at each level. In the well-known tomb of the Taj Mahal the four minarets are all built in white marble, in three storeys with balconies to each storey, and surmounted by open lanterns. The minarets of Constantinople are very lofty and wire-drawn, but contrast well with the domes of the mosques, which are of slight elevation as compared with those at Cairo.

MINAS [MINOÏDES] (c. 1790-1860), Greek scholar, was a native of Macedonia. During the Greek War of Independence he migrated to Paris, where he tried to enlist the sympathies of Europe on behalf of his countrymen and to promote the study of ancient and modern Greek. But his chief claim to recognition consists in his discovery of two important MSS. (amongst others) in the monastery of Mt Athos during his exploration of the libraries of Turkey and Asia, at the instance of M. Villemain, minister of public instruction in France. One of these contained the last part of a treatise on the *Refutation of all Heresies*, now generally admitted to be the work of Hippolytus (q.v.), the other the greater portion of the *Fables of Babrius*.

MINAS GERAES (i.e. "general mines"), popularly MINAS, an inland state of Brazil, bounded N. by Goyaz and Bahia, E. by Bahia, Espírito Santo and Rio de Janeiro, S. by Rio de Janeiro and São Paulo, and W. by São Paulo, Matto Grosso and Goyaz. It is very irregular in outline and covers an area of 221,861 sq. m. upon the great Brazilian plateau. Among the Brazilian states it is fifth in size and first in population—3,184,099 in 1890, and 3,594,471 in 1900.

The surface of Minas Geraes is broken by mountain ranges and deeply eroded rivercourses, the latter forming fertile valleys shut in by partly barren uplands, or campos. The reckless destruction of forests along the watercourses also adds to the barren aspect of the country. The principal mountain ranges are the Serra da Mantiqueira on its southern frontier and its N. extension, the S. do Espinhaço, which runs parallel to the Serra do Mar, or coast-range, and separates the inland or campo region from a lower forested zone between the two ranges. Most of the wooded district south of the Mantiqueira belongs to the states of São Paulo and Rio de Janeiro, but east of the Espinhaço it belongs to Minas Geraes and extends eastward to the Serra das Aymores, on the frontier of Espírito Santo. This zone has an abundant rainfall, dense forests and a fertile soil. It is drained by the Doce, Mucury, Jequitinhonha and Pardo, which have their sources on the eastern slopes of the Espinhaço and cut their way through the Aymores to the sea. The tributaries of the Rio Doce cover the slopes of the Serra do Espinhaço for a distance north and south of about 200 m. The southern part of this region is well populated, and is covered with coffee and sugar plantations. On the western frontier a northern extension of the great central chain of Goyaz forms the water-parting between the drainage basins of the São Francisco and Tocantins, and is known at different points as the Serra do Paranã, Serra de São Domingos and Serra das Divisões. South-east of this chain, between the headwaters of the Paranã and São Francisco, are the Serra da Canastra and Serra da Matta da Corde, an irregular chain of moderate elevation running north and south. The highest elevations in the state, so far as known, are Itatiaia (8898 ft.) in the Serra da Mantiqueira, and Caraça (6414 ft.), near Ouro Preto, in the Serra do Espinhaço. The hydrography of the campo region of Minas Geraes is extremely complicated. The Mantiqueira-Espinhaço chain shuts out the streams flowing directly east to the Atlantic, and the boundary ranges on the west shut out the streams that flow into the Tocantins, though their sources are on the actual threshold of the state. Between these two mountain chains the head streams of the Paranã and São Francisco are intermingled—the one flowing inland and

southward to the great La Plata estuary, the other northward and eastward across the arid highlands of Brazil to the Atlantic coast in $10^{\circ} 30'$ S. lat. Less than 100 m. from the city of Rio de Janeiro and about 60 m. from the coast is the source of the Rio Grande, the larger of the two rivers that form the Paraná. It rises near the peak of Itatiaia, on the northern slopes of the Mantiqueira, and flows north-west and west across the Minas plateau, receiving several large tributaries from the south. North and parallel with its course is a low watershed, which separates its drainage basin both from that of the São Francisco and from that of the Parahyba, the northern confluent of the Paraná. The latter rises on the western slopes of the Serra da Matta da Corde, and one of its northern tributaries has its source in a "knot" of the Serra dos Pyreneos, from which streams flow eastward to the São Francisco and northward to the Tocantins. The central and greater part of the state, however, is included in the drainage basin of the upper São Francisco. Its source is in the Serra da Canastra, and its general course across the state is north by east, during which it receives the Paracatú, Uruçua, Pardo and Carinhonha from the west and the Verde Grande and das Velhas from the east. Part of these rivers are navigable for small steamers, and the São Francisco must some day be of great importance in the development of Central Brazil. All these rivers of the Brazilian plateau are interrupted by falls and rapids. The climate of Minas Geraes is characterized by high sun temperatures and cool nights, the latter often dropping below the freezing point on the higher campos. The mean annual temperature is about 85° in the São Francisco valley, 77° on the campos of the S.E., and 70° on the campos of the W. The year is divided into two seasons—wet and dry—the former lasting from November to May. This division is not so clearly marked in the south, especially in the "matta" (forest) regions, where the rainfall ranges from 59 to 65 in. There is much malaria in the wooded districts of the east and on the higher campos, where the daily extremes of temperature are great, lung and bronchial diseases are common. Some of the high plains, however, as at Barbacena, serve as health resorts for the coast districts.

Minas Geraes is a mining state, though the mining industry has lost much of its importance through the decline in the output of gold and diamonds. Gold is widely diffused, and abandoned "washings" all over the state show how general the industry was at one time. There were in 1908 five deep mines worked by English companies and one by a French company. One of these, the Morro Velho mine, belonging to an English company, is not only the deepest gold-mine in existence (over 2000 ft.), but it has been worked since 1725, and since 1835 by its present owners. Silver is not mined by itself, but is found in combination with gold. In 1908 a rich goldfield was discovered in the northern part of the state, 5 m. from Montes Claros, in the valley of the Verde Grande River, and attracted large numbers of miners. There are many rich deposits of iron ores in the state, but they only produce a small quantity of charcoal iron for local consumption. Manganese ore is mined for export, and bismuth is reported to have been discovered. Minas Geraes is most widely known for its diamonds, which are found in widely separated parts of the state. The largest and most productive field is that of Diamantina (*q.v.*) on the head-waters of the Jequitinhonha River, where diamonds were discovered about 1725, and where the celebrated "diamond reservation"—an oval-shaped territory 8 leagues wide by 16 leagues long (Mawe), with Tejuco, now Diamantina, very nearly in the centre—was established in 1730. The mines became crown property, gold-mining was forbidden, and no one was permitted to enter the reservation without a licence. The state monopoly was abolished in 1832, and mining has since been carried on by private enterprise. John Mawe estimates that the annual product was 1000 oz. during the first twenty years, and Castelnau estimates the value of the total output down to 1849 at 300,000,000 fr. No estimate can be made of the contraband, which must have been large. A great decline in the output occurred during the last half of the 19th century, but a new field was discovered in 1908 at Abbadia dos Dourados, in the western part of the state.

Other valuable stones, the topaz, chrysolite, aquamarine, amethyst and tourmaline are found.

Agriculture and grazing have become the main dependence of the population—the former in the lower, forested region of the south-east, where coffee and sugar-cane are the principal products, and the latter on the higher campos and river valleys, and on the mountain slopes, where large herds of cattle are to be found, and milk, butter and cheese are produced. The shipping of fresh milk to Rio de Janeiro and butter-making are comparatively new industries. The river valleys of the campo region are also cultivated to some extent. Among the general products are Indian corn, tobacco, mandioca, beans, pork and cotton. Wheat has been produced in some localities, but not on a paying basis, and experiments have also been made with tea. There is a large variety of fruits, and the cultivation of grapes for wine-making is developing into a profitable industry. Railway communication with Minas Geraes includes the following lines: the Central do Brazil (formerly known as the Dom Pedro II.), which starts from Rio de Janeiro and penetrates nearly to Pirapora (its objective point), at the head of navigation of the São Francisco River, with branches into neighbouring districts; the Leopoldina, from Rio de Janeiro into the forested region of eastern Minas; the Minas and Rio, from Cruzeiro, on the São Paulo branch of the Central do Brazil, into southern Minas; the Mogyana, from Campinas, São Paulo, and runs to Uberaba in western Minas, and is intended to cross into Goyas; and the Bahia & Minas, from the port of Caravellas, in southern Bahia, which runs a short distance into Minas Geraes, and is planned to extend to Philadelphia and beyond. Another line from the port of Victoria, Espírito Santo, northward to Diamantina, Minas Geraes, was under construction in 1908. River transport has some local value on the upper São Francisco and its larger tributaries, and this will be greatly increased when the Central do Brazil railway reaches the head of navigation on that river.

The population of Minas Geraes is chiefly of Portuguese origin, which has been constantly strengthened by immigrants from the mother country. A considerable admixture from other nationalities has resulted from the influx of mining adventurers, and some German colonies have been established in the state. The negro population is large, and there is a still larger contingent of mixed races. The capital is Belo Horizonte (*q.v.*), or Cidade de Minas; other important cities and towns are: the former capital, Ouro Preto, Barbacena, Diamantina, Baependy (pop. 22,817 in 1890), on the head-waters of the Rio Verde, the centre of a rich tobacco-producing district; Curvello (8071), north of Sabará in the Rio das Velhas Valley, the centre of a cotton-growing district and cotton manufactures; Entre Rios (7681), in the coffee district of south-east Minas; Januária (5888), a river port of the São Francisco in northern Minas; Juiz de Fora; Marianna (4751), an episcopal town east of Ouro Preto, Mar de Espanha (18,712), the centre of a productive and populous agricultural municipality of south-east Minas; Paracatú (21,418), an important commercial centre of western Minas near the Goyaz frontier; Queluz (12,600), on the Central do Brazil railway; Congonhas do Campo (10,902), in the municipality of Queluz, celebrated for its miracle-working image, its great church and chapels, and the pilgrimages to its shrine; Sabará (4059), a railway junction on the Central do Brazil, and port on the Rio das Velhas; Congonhas de Sabará (14,066), in the municipality of Sabará, where the celebrated Morro Velho gold-mine is situated; São João d'El-Rei (15,820) an important commercial mining and pastoral centre, near the Rio das Mortes, connected with the Central do Brazil railway by a branch called the Oeste de Minas; and Uberaba (12,231), a commercial town of the western campos of Minas, connected with São Paulo by the Mogyana and São Paulo railways.

Minas Geraes was first explored by Fernando Dias Paes Leme between 1664 and 1677, though he was not the first European to penetrate it. The discovery of gold in 1602–1605 by bands of adventurers from the São Paulo settlements, led to every occupation and profession being abandoned in the mad rush for the new mines. Minas Geraes at first formed part of the

capitania of São Paulo, but in 1720 it became a separate government and was brought more directly under the Portuguese crown. The arbitrary restrictions imposed upon the colonists aroused dissatisfaction among them and eventually led to conspiracy in 1780, inspired by a fear that the Portuguese government was about to enforce the collection of its "fifths" of the mining output, which had largely fallen into arrears. Among the conspirators was one José Alves Maciel, who had just returned from France where he had met Thomas Jefferson and had become infected with French revolutionary ideas. A number of residents became involved, among them the poet Thomaz Antonio Gonzaga. Reckless talk in public places led to the arrest of the conspirators. Only one was executed, a poor, uneducated subaltern militia officer Joaquim José da Silva Xavier, nicknamed *O Tiradentes* (the Tooth-puller), the others being imprisoned or banished. Tiradentes has since been glorified as the pro-martyr of Brazilian independence. In 1822 Minas became a province of the empire created by Dom Pedro I, though a revolutionary outbreak had occurred in Ouro Preto the year before. In 1842 a long series of quarrels in Rio de Janeiro culminated in a revolution in Minas Geraes and São Paulo, which was suppressed at Santa Luzia, Minas Geraes, on the 20th of August of that year. The abolition of slavery in 1888 caused much discontent among the planters and in the following year Minas Geraes promptly adhered to the declaration of the republic in Rio de Janeiro.

MINBAR, or **MIMBAR**, a term in Mahomedan architecture for the pulpit in a mosque from which the Friday or Mahomedan Sabbath sermon is given (see *PULPIT*).

MINBU, a district and division of Upper Burma. The district has an area of 3299 sq. m., and a population (1901) of 233,377, showing an increase of 8% in the decade and a density of 71 inhabitants to the sq. m. The district may be said to consist of low plain-land towards the Irrawaddy, and of undulating country inland rising higher and higher westwards towards the Arakan hills. Between the plain and the Arakan Yoma range is a distinct line of hills running north and south, and usually called the Nwa-Madaung hills. The submontane valleys are largely cultivated, but are deadly except to those born in them. The chief streams besides the Irrawaddy are the Mòn, the Maw, and the Salin, which are largely used for irrigation. At Minbu town the Irrawaddy is 3 miles wide, with many islands and sandbanks. There are considerable fisheries along the Irrawaddy and on the Paunglin lake, which is a lagoon fed from the Irrawaddy. The rights are sold yearly by public auction, and realize an average of £1000. Oil has been discovered near the mud volcanoes of Minbu, but it seems to lie at too great a depth to be profitably worked.

There is a large area of reserved forest in the district. The chief crops raised are rice, gram, millet, beans, peas, sesamum and tobacco. The betel-vine is largely cultivated along the Mòn River. The district, which was in a chronically disturbed state before the annexation, was not reduced till two years afterwards, many officers losing their lives, among them Phayre, the first deputy-commissioner. The annual rainfall varies greatly over the district. It is very considerable on and under the Arakan Yomas, and very slight towards the Irrawaddy. The thermometer rises to over 100° in the hot months, and the mean of minimum in December is about 49°. **MINBU**, the district headquarters, stands on the Irrawaddy. It had a population of 5780 in 1901. The river steamers in the dry season can come no nearer than two miles to the south of the town.

The division includes the districts of Thayetmyo, Pakòkku, Minbu and Magwe. It has a total area of 17,172 sq. m. and a population (1901), of 1,076,280, showing an increase of 8% in the decade and giving a density of 63 inhabitants to the square mile. It bestrides the Irrawaddy. (J. G. Sc.)

MINCHINGHAMPTON, a town in the Stroud parliamentary division of Gloucestershire, England, 4 m. S.E. of Stroud. Pop. (1901), 3737. It lies high on a slope of the Cotswold Hills; Minchinhampton Common being a fine open upland. The church of Holy Trinity, largely reconstructed, contains many brasses

and memorials. The manufacture of woollen cloth is the long-established staple of Minchinhampton. Prehistoric remains have been discovered on the common, and earthworks are also seen; while the name of Woeful Dene Bottom, a neighbouring valley, perhaps indicates the scene of a defeat of the Danes (c. 918).

MINDEN, a town of Germany, in the Prussian province of Westphalia, 44 m. by rail to the W.S.W. of Hanover, on the left bank of the Weser, which is spanned by two bridges. Pop. (1905), 25,428. The older parts of the town retain their narrow and crooked streets. The cathedral tower dating from the 11th century, illustrates the first step in the growth of the Gothic spire in Germany. The nave was erected at the end of the 13th century, and the choir in 1377-1379. Among the chief edifices are the old church of St Martin; the town hall, with a Gothic façade; the law courts and the government offices, constructed, like many of the other buildings, of a peculiar veined brown sandstone found in the district. The town has a statue of Frederick William I., the great elector of Brandenburg. Minden contains a gymnasium and several hospitals, besides other charitable institutions. Its industries include linen and cotton weaving, dyeing, calico printing, brewing, ship-building and the manufacture of tobacco, glass, soap, chocolate, leather, lamps, chicory and chemicals. There is also some activity in the building of small craft.

Minden (Mindun, Mindo), apparently a trading place of some importance in the time of Charlemagne, was made the seat of a bishop by that monarch, and subsequently became a flourishing member of the Hanseatic League. In the 13th century it was surrounded with walls. Punished by military occupation and a fine for its reception of the Reformation, Minden underwent similar trials in the Thirty Years' War. In 1648 the bishopric was converted into a secular principality under the elector of Brandenburg. From 1807 to 1814 Minden was included in the kingdom of Westphalia, and in the latter year it passed to Prussia. In 1816 the fortifications, which had been razed by Frederick the Great after the Seven Years' War, were restored and strengthened, and as a fortress of the second rank it remained the chief military place of Westphalia down to 1873, when the works were finally demolished. About 3 m. to the south of Minden is the so-called "Porta Westfalica," a narrow defile by which the Weser quits the mountains. The bishopric of Minden embraced an area of about 400 sq. m. and had about 70,000 inhabitants.

The battle of Minden was fought on the 1st of August 1759 between the Anglo-Allied army commanded by duke Ferdinand of Brunswick and the French under Marshal Coudates, the latter being defeated. The most brilliant episode of the battle was the entire defeat of the French cavalry by the British infantry (with whom there were some Hanoverian troops), but Minden, though it is one of the brightest days in the history of the British army, has its dark side also, for the British cavalry commander Lord George Sackville (see *SACKVILLE*, *VISCOUNT*) refused to obey the order to advance, several times sent by Duke Ferdinand, and thereby robbed the victory of the decisive results which were to be expected from the success of the infantry. For an account of the battle and of the campaign of which it is the centre, see *SEVEN YEARS' WAR*.

See *Stoy, Kurzer Abriss der Geschichte Mindens* (Minden, 1879); *Bölsche, Skizzen aus Mindens Vergangenheit* (Minden, 1897); *Holscher, Beschreibung des vormaligen Bistums Minden* (Münster, 1877).

MINEHEAD, a market town and seaside resort in the Wellington parliamentary division of Somersetshire, England, 188 m. W. by S. of London by the Great Western railway. Pop. of urban district (1901), 2511. The town has three parts: the Upper, built on the sides of a lofty foreland known as North Hill; the Lower; and the Quay Town, with many ancient houses, stretching for about a mile beside the harbour. It is much visited for the sake of its mild climate, the grand cliffs, moors and hills of the neighbourhood, and the beach, admirably suited for bathing. St Michael's, the parish church, has a striking Perpendicular tower, an arch of carved oak dividing its nave and

chancel, a magnificent rood-loft, and a 13th-century monument doubtfully described as the tomb of Bracton, the famous lawyer, whose birthplace, according to local tradition, was Bratton Court in the vicinity. Coaches for Porlock and Lynton start from the town.

There is no evidence of the existence of Minehead (*Mannheve, Manehaf, Myneheved*) in Roman or Saxon times. The town owed its origin and growth to its position on the shores of the Bristol Channel, and its good harbour developed an overseas trade with Bristol, South Wales and the Irish ports. The De Mohun family were overlords of the town from 1086 to the 14th century, when they were followed by the Luttrells, who are the present owners. It is possible that Minehead had a corporate existence during the 15th century, as certain documents executed by the portreeve and burgesses at that date are preserved, but no record of the grant of a charter has been found. A charter of incorporation given by Elizabeth in 1558 vested the government in a portreeve, a steward and twelve burgesses, the continuance of the corporation being subject to the port and harbour being kept in repair. This condition being unfulfilled, the charter lapsed in the reign of James I., and an attempt to obtain its renewal in the 18th century failed. The corporation was replaced by two constables chosen annually in the court leet of the manor until 1894, when an urban district council was appointed. The borough returned two members to parliament from 1558 until disfranchised by the Reform Act of 1832. A weekly market on Tuesdays and a fair (Sept. 29 to Oct. 2) were held by the lord of the manor from the 15th century, but the date of the grant has not been found. In 1465 a second annual fair on the 1st of May was granted by Edward IV., which is still held on the Wednesday in Whitsun week. The other fair has been discontinued, and the market day has been changed to Wednesday. During the 16th, 17th and 18th centuries Minehead had a considerable coastwise trade in wool, grain and wine, but began to decline owing to the migration of the woollen industry to the north of England, and to the decay of the herring fishery. A renewal of prosperity began when it acquired a reputation as a watering-place.

See *Victoria County History: Somerset*; F. Hancock, *Parish and Borough of Minehead* (1903).

MINEO, a town of the province of Catania, Sicily, 34 m. S.W. of Catania by rail. Pop. (1901), 9282. It occupies the site of the ancient *Menaenae*, founded by Ducetius in 459 B.C. There is some doubt as to whether this town was also the birthplace of Ducetius, owing to confusions in nomenclature (see E. A. Freeman, *History of Sicily*, ii. 361). Remains of ancient fortifications still exist, though it seems uncertain whether they are of Greek or of Byzantine origin (*Notizie degli Scavi*, 1899, p. 70). Four miles to the north is the Lacus Palicorum, a small lake in a crater, which still sends up carbonic acid gas. By it was the temple of the Palici, twin Sicel gods, the most holy place in Sicily, where an oath taken was especially binding, and an inviolable asylum for fugitive slaves. There is now nothing to suggest twin deities; in ancient times there were probably two craters, whereas now there is only one. It was here that Ducetius, a few years later, founded a new seat for his power, the city of Palica.

MINERAL DEPOSITS. The subject of mining (*q.v.*) can only be properly understood after the general features of mineral deposits have been elucidated. In this article deposits of all kinds of useful minerals are included, whether they are metalliferous or earthy. In general practice it is customary to treat the former under the name "ore-deposits" and the latter as the "non-metallics." This is warranted because in a large degree different geological problems are presented and different methods of mining are pursued. Nevertheless there are other important similar or common features and they may be classed together without great disadvantage.

The word "ore" is used in several meanings, each of which depends for its special significance upon the connexion. In purely scientific applications "ore" implies simply a metalliferous mineral, and in this sense it appears in works on mineralogy and petrology. In former years and in

connexion with practical mining an ore was defined as a compound of metal or of metals with one or more non-metallic elements, called mineralizers, of which oxygen and sulphur were the chief. The ore must, in addition, be sufficiently rich to be mined at a profit. Native metals not being compounds were not considered ores. The product of the copper mines on Keweenaw Point, Lake Superior, was, and to a great extent is still, called copper rock rather than copper ore, and native gold in quartz is often described as gold quartz rather than gold ore, but these restrictions are gradually disappearing. An ore may therefore be defined as a metalliferous mineral or aggregate of metalliferous minerals mingled with a greater or less amount of barren materials called the "gangue," and yet rich enough to be mined at a profit. When not proved to be sufficiently rich to be remunerative, the aggregate is called "mineral." The "mineral" of to-day may be changed by the advent of a railway or the rise in the price of metal into the "ore" of to-morrow. The question has repeatedly appeared in litigation involving contracts or property rights.

Since the greater number of the ores are believed to have been precipitated from aqueous solution, or to have been otherwise formed through the agency of water, the term "ore-deposit" has resulted; and inasmuch as nearly all the other useful minerals owe their origin to the same agent, the term "mineral deposit" is equally well justified. A few, however, have been produced in a different way, such as certain iron ores of igneous origin; certain igneous rocks used for building stone, as in the case of granite; and the accumulations of vegetable material in coal beds. These latter, the igneous masses and the vegetable accumulations, being placed in two divisions by themselves, we may group the larger number into two main classes, depending on their precipitation from solution or from suspension. In the case of solution we will further subdivide on the place, and therefore in large part on the cause, of precipitation, since these are the questions chiefly involved in actual development.

Especially in connexion with ore-deposits widening experience has modified the older conceptions of relative values in the several types. In the early days of geology, Cornwall and Saxony were the two regions where the most active and influential students of ore-deposits were trained and where the principal books relating to mining originated. The pronounced and characteristic fissure veins of England and Germany became the standards to which the phenomena met elsewhere were referred, and by means of which they were described. This particular form, the fissure vein along a fault, assumed a predominating importance, both in the thought and in the literature of the day. Widening experience, however, especially in the Cordilleran region of North America, in the Andes of South America, in Australia and in South Africa, has brought other types into equally great and deserved prominence. Comprehensive treatment to-day therefore departs somewhat from earlier standards.

As far as analyses and estimates permit, the common useful metals occur in the earth's crust in approximately the following percentages:—

		<i>Occurrence.</i>
1. Aluminium	8.13	7. Copper . . . 0.0000x
2. Iron . . .	4.71	8. Lead . . . 0.0000x
3. Manganese	0.07	9. Zinc . . . 0.0000x
4. Nickel . . .	0.01	10. Silver . . . 0.00000x
5. Cobalt . . .	0.0005	11. Gold . . . 0.0000000x
6. Tin . . .	0.000x-0.000x	12. Platinum 0.00000000x

By the letter *x* is meant some undetermined digit in the corresponding place of decimals. Apart from aluminium, iron, manganese and nickel, the figures show how small is the contribution made by even the commoner metals to that portion of the mass of the globe which is open to observation and investigation.

As compared with the earth's crust at large certain of the metals are known to be locally present in favourable, usually igneous, rocks in richer amounts, according to the following determinations which have been made upon large samples of carefully selected materials. Copper, 0.009%; lead,

0-0011-0-008; zinc, 0-0048-0-009; silver, 0-0007-0-00016; gold, 0-00002-0-00004. Iron and aluminium seldom fail, and vary from 1 to 2% as a minimum, up to 25% as a maximum.

In order that the several metals may constitute ores, their percentages must be the following—the percentages of each vary with favourable or unfavourable conditions at the mine, and can therefore be expressed only in a general way; ores favourable to milling and concentration may go below these limits, and the mingling of two metals of which one facilitates the extraction of the other may also reduce the percentages:—

Aluminium	30	Nickel	2-5
Copper	2-10	Platinum	0-00005
Gold	0-003-0-00016	Silver	0-03-0-16
Iron	35-65	Tin	1-5-3
Lead	2-25	Zinc	5-25
Manganese	40-50		

Cobalt is a by-product in the metallurgy of nickel and is usually in much inferior amount to the latter.

When we compare the first and second tabulations with the third it is at once apparent that with the possible although only occasional exception of iron the production of an ore-body from the normal rocks which constitute the outer mass of the earth requires the local concentration of each of the metals by one or several geological processes, and to a degree that is only occasionally developed in the ordinary course of nature. It is, therefore, an instance of somewhat exceptionally good fortune when one is discovered, and it is only the part of ordinary prudence to develop and utilize it as one would treat a resource which is limited and subject to exhaustion.

The minerals which constitute ore-bodies are divided into two *Classes of great classes: the ores proper*, which contain the *Mineral* metals; and the *barren minerals or gangue*, which reduce the yield.

The ores are generally and naturally subdivided into two groups: first, the sulphides and related compounds containing arsenic, antimony, tellurium and selenium; and, second, the oxidized compounds embracing oxides, carbonates, sulphates, silicates, phosphates, arsenates, chromates, &c. With the oxides are placed, because of related geological occurrence, a few rare compounds with chlorine, bromine and iodine into which silver more than any other metal enters, and to the same group we may add a few metals which occur in the native state. Iron, manganese, aluminium and tin differ from the rest of the metals in their original occurrence in the oxidized form, whereas the others with the exception of gold, platinum, and possibly copper, in their first precipitation in ore-bodies are in the form of sulphides or related compounds. Only by subsequent changes, characteristic of the upper parts of the deposits, do they pass by oxidation into the minerals of the second group.

With regard to the nature and source of the water which serves to gather up the widely disseminated metals and concentrate them in ore-bodies two contrasted views are now current, not necessarily antagonistic but applied in different degrees by different observers. The older view attributes the water primarily to the rainfall, and therefore it is called meteoric water. After falling upon the surface the meteoric water divides into three parts. The first, and smallest, evaporates; the second, the largest portion, joins the surface drainage and is called the run-off; while the third, intermediate in amount, sinks into the ground and mingles with the ground-waters. The ground-waters rise in springs, usually fed from no great depth, and themselves pass into the surface drainage after a small subterranean journey. While as a rule the ground-water level is fairly definite, yet it sometimes displays even in the same mining district great irregularity.

The section of active circulation and work of the descending meteoric waters between the surface and the ground-water level was called by Franz Posepny (1836-1895) the vadose or shallow region ("Genesis of Ore-deposits," *Trans. Amer. Inst. Min. Eng.*, xxiii., xxiv., 1893; reprinted as a book, 2nd ed., 1902). It has been long recognized by miners as the home of the oxidized ores, and the place of the work of the descending waters. The

deep-waters are relatively motionless and their movements as far as visible are comparatively slow. But the really important feature of the ground-water as regards the filling of veins is the depth to which it extends. This remained a somewhat indefinite matter until L. M. Hoskins showed mathematically that cavities in the firmest rocks become impossibilities at about 10,000 metres. Down to some such limiting depth as an extreme the ground-water was believed by many to descend; to migrate laterally; to experience the normal increase of temperature with depth; the effect of pressure; the increased efficiency as a solvent peculiar to the conditions; and finally with a burden of dissolved gangue and ore to rise again, urged on by the "head" of the descending column. In its ascent it was supposed to fill the veins. Mining experience has, however, indicated that the known ground-waters are comparatively shallow and seldom extend lower than 500-600 metres. It is conceivable that during faulting and the formation of great dislocations this upper reservoir might be tapped into greater depths and set in limited circulations through deeper-seated rocks. But so far as these objections have weight they have greatly restricted the vertical range of the meteoric ground-waters as they were formerly believed to exist.

In contrast with the meteoric waters outlined above, other waters are believed by many geologists to be given off by the deep-seated intrusive rocks, and are generally called magmatic. We are led to this conclusion by observing the vast quantities of steam and minor associated vapours which are emitted by volcanoes; by the difficulty of accounting in any other way for the amount and composition of certain hot springs; and by the marked and characteristic association of almost all ore-deposits in the form of veins with eruptive rocks. That igneous masses have been connected with the formation of veins is further brought out by the following general consideration, which has hitherto received too little attention. Aside from pegmatites, veins rich enough to be mined and even large veins of the barren gangue-minerals are exceptional phenomena when we compare the regions containing them with the vast areas of the earth which have been carefully searched for them and which have failed to reveal them. As components of the earth's crust the useful metals except iron and aluminium are extremely rare. Some sharply localized, exceptional, and briefly operative cause must have brought the veins into being. The universal circulation of the ground-water of meteoric origin fails to meet this test, since if it is effective we ought at least to find veins of quartz and calcite fairly universal in older rocks. In North America, moreover, by far the greater number of veins which have been studied date from the Mesozoic and Tertiary times. The ore deposits of older date are chiefly of iron and manganese and can be satisfactorily explained in many cases by the reactions of the vadose region, or by crystallization from molten masses.

In summary it may be stated that the meteoric waters are of great importance and of unquestioned efficiency in the shallow vadose region, or, as named by C. R. van Hise, "the zone of weathering." In it the disintegration of rocks exposes them to the searching action of solutions, and the portions of ore-bodies already deposited undergo great modifications. The deeper and far more immovable ground-water probably extends to but moderate depth and is chiefly affected as regards movement by the head of waters entering heights of land and by local intrusions of igneous rocks. It is very doubtful if the normal increase of temperature with depth produces much effect. The meteoric waters are of altogether predominant importance in all surface concentrations of a mechanical character. The magmatic waters, on the other hand, seem to be of paramount importance and of great efficiency in producing the deposits of ores in the contact zones next eruptives, and in the formation of veins which are reasonably to be attributed to uprising heated waters in regions of expiring vulcanism. They start with their burden of dissolved metals and minerals under great heat and pressure, amid conditions favouring solution, and migrate to the upper world into cooling and greatly contrasted conditions which favour precipitation. Undoubtedly they are responsible for many low-grade deposits

which have later been enriched by the action of descending meteoric waters. They are more copiously yielded, so far as we may judge, by acidic magmas than by basic ones.

The natural waterways are furnished by the cavities in rocks. They vary in size from very minute pores, where movement is slow because of friction, but where solution takes place, through others of all dimensions up to great fault-zones. The smallest cavities are the natural pores of minerals; cleavage cracks; the voids along the contacts of different minerals; cracks from crushing during dislocation; cellular lavas; volcanic necks; voids among the grains, pebbles, or boulders of fragmental rocks; joints; caves, and faults. So far as waters have deposited ores and yielded ore-bodies by subterranean circulations the latter are guided by some such controlling influence as these in all cases, and they will be selected as the governing principle in a large part of the scheme of classification. The types will be reviewed in the following order:—

I.—OF IGNEOUS ORIGIN.

- A. Eruptive masses of non-metalliferous rock.
- B. Basic segregations from fused and cooling magmas.
- C. Deposits produced in contact metamorphism, most commonly by the action of intrusive masses on limestones.
- D. Pegmatites.

II.—PRECIPITATED FROM SOLUTION.

- A. Surface deposits.
- B. Impregnations in naturally open-textured rocks.
- C. Impregnations and replacements of naturally soluble rocks.
- D. Deposits along broken anticlinal summits and in synclinal troughs.
- E. Deposits in shear zones.
- F. Deposits in faults.
- G. Deposits in volcanic necks.

III.—DEPOSITED FROM SUSPENSION.

- A. Placers.
- B. Residual deposits.

IV.—CARBONACEOUS DEPOSITS FROM VEGETATION.

I. OF IGNEOUS ORIGIN.—A. *Eruptive Masses of Non-metalliferous Rock*.—Among the non-metallic objects of mining and quarrying which are of igneous nature, building stone is the chief. Granites, syenites, and other light-coloured rocks are the most important. These rocks occur as intrusive masses called bosses when of limited extent and diameter, and batholiths when of vast, irregular area. The main point of importance is the jointing and cleavage, which should in each case yield blocks as nearly rectangular as possible so as to save tool wastage. Dark, basic igneous rocks in dikes, sills and surface flows are employed for macadam, and are often of excellent quality for this purpose.

B. *Basic Segregations from Fused and Cooling Magmas*.—A few ore-bodies, of which the best-known involve iron, are believed to result directly in the igneous processes by which molten rock cools and crystallizes. Thus magnetite, one of the common iron ores, is a widely distributed component in the eruptive rocks, rarely if ever failing in any variety. It is one of the first minerals to crystallize, and it possesses a much higher specific gravity than the other constituents. There is reason, therefore, to believe that, forming in some molten magmas in relatively large quantity, it sinks to or toward the bottom of the mass until the latter is at least greatly enriched with it, if not actually changed to iron ore. If the molten rock, after passing through a stage of partial crystallization, moves toward the surface of the earth, the body of ore may occupy almost any position in other than the bottom. The flowing of the magma in original movements or from pressure sustained in subsequent metamorphic processes, or both, may give the ore the lenticular shape which is quite characteristic of magnetite bodies the world over. Almost all iron ores of recognized eruptive origin contain titanium oxide in amounts from a few units to over 40%. They are most frequently found in dark basic rocks. These ores are not at present of much commercial value because of the difficulties of treating titaniferous varieties in the modern blast furnace practice, but there is little doubt in the near future they will be extensively mined.

Non-titaniferous magnetites, which often form lenses in gneissoid rocks of more acidic character than those with which the titaniferous are associated, are likewise believed by some observers to be of igneous origin, but there are equally positive believers in sedimentary deposition followed by metamorphism.

Besides magnetite, chromite is a characteristically igneous mineral and is always found in the richly magnesian rocks. Whether the relatively large masses which appear in serpentine are direct crystallizations from fusion, or whether they have segregated from a finely disseminated condition during the change of the original eruptive to serpentine, is a matter of dispute, but the general trend of later opinion is toward an original igneous origin. Although not strictly

an ore, corundum is another mineral which is the direct product of igneous action.

A form of ore-body which marks a connecting and transitional member between those just treated and those of the next group is furnished by the sulphides of iron, nickel and copper which are found in the outer borders of basic igneous intrusives. These ores differ somewhat as to the relative importance to be attributed to reactions purely of the nature of crystallization from fusion or those brought about by the agency of gases or other highly heated solvents in the cooling stages. The most important example is afforded by the mingled ores of nickel and copper which are developed in their largest form in the region of Sudbury, Ontario, Canada, and are now the principal source of nickel for the world.¹ The ores are chalcopyrite and pyrrhotite, the latter containing throughout a mass at Sudbury the mineral pentlandite, a rich nickel-iron sulphide. The local source of the nickel. With the base metal there are also found minute traces of the metals of the platinum group. Wherever these ore-bodies have been observed they invariably occur in the borders of intrusive masses. The sulphides constitute an integral part of the rocky mass, which shows almost no signs of alteration or vein production in the ordinary sense. Only some slight rearrangements have subsequently taken place through the agency of water, but this is a small factor in the total.

C. *Ore-Bodies produced by Contact Metamorphism*.—Great bodies of igneous rock have often been forced in a molten and highly heated condition through other rocks when at a distance below the surface of the earth. After coming to rest they have remained during the cooling stages for long periods in contact with the surrounding walls. All molten igneous magmas are more or less richly charged with aqueous vapour, doubtless in a dissociated state; with carbonic acid and with other gases, especially those involving sulphur. During the cooling stages the gases are emitted and carry with them silica, iron, alumina and metallic elements in less amount, of which copper is the commonest, but among which are also numbered lead, zinc, gold and silver. If the rock standing next the intrusive mass is limestone, the silica and iron, and to a less degree the alumina, combine with the lime to the elimination of the carbonic acid and produce extensive zones of lime silicates, of which garnet is the most abundant. Disseminated throughout these garnet-zones are large and small masses of pyrite and chalcopyrite, sometimes in amounts sufficient to yield large ore-bodies. Again in the limestone outside the garnet-zones, but none the less closely associated with them, are bodies of sulphides containing copper. The copper ores of Bisbee and Morenci, Arizona, of Aranzaco near Concepcion del Oro, Mexico, and of many other parts of the world not yet studied in detail are of this type. The eruptive which most frequently produces contact zones is of a type of a few thousand feet in height, since among eruptives these are the ones most richly charged with gases. When the copper ores are of low-grade in their original deposition it often happens that processes of secondary enrichment, which are later described, are required to bring them up to a richness which warrants mining. Less often than copper appear lead, zinc or gold ores in the same relations.

D. *Pegmatites*.—One other phase of eruptive activity needs also to be briefly mentioned before passing to the discussion of the ore-bodies, which have hitherto chiefly occupied students of the subject. In the regions surrounding intrusive masses of granite we almost always see dikes or veins of coarsely crystalline quartz, felspar and mica radiating outward, it may be, for very long distances. They are believed to be produced by emissions from the eruptive similar to those which yield the garnet-zones just mentioned. The veins are technically called pegmatites. They are characteristic of granite and of minerals containing the rare earths, and less commonly are known to yield gold and copper.

II. PRECIPITATED FROM SOLUTION.—A. *Surface Deposits*.—The chief ore-body under this type is furnished by iron. The peculiar chemical property possessed by this metal of having two oxides, a ferrous, which is relatively soluble, and a ferric, which is insoluble, leads to its frequent precipitation from bodies of standing or comparatively quiet waters. Ferruginous minerals of all sorts, but more particularly pyrite and siderite, pass into solution in the descending oxidizing carbonated surface waters, either as ferrous sulphate, or as salts of organic acids, or ferrous carbonate, the last-named dissolved in an excess of carbonic acid. On being exposed to the atmosphere when the solutions come to rest, or to the breaking up of organic acids, or to alkaline reagents, or sometimes to fresh-water alkali, the hydrated sesquioxide $2\text{Fe}_2\text{O}_3 \cdot 3\text{H}_2\text{O}$ is precipitated as the familiar beds of bog ore. The ore usually forms earthy aggregates or irregularly pyritic cakes, but may also, as in the interesting case of the Swedish lake deposits, yield surface bog iron, which is very rich in iron and are apt to have much sand and clay intermingled. If subsequently buried under later sediments they may become dehydrated and changed to red hematite, as in the case of some of the Clinton iron ores of the eastern United States. These widely extended beds in the lower strata of the Upper Silurian are often oolitic red hematites, consisting of concentric shells of iron oxide and

¹ A. H. Barlow, "On the Sudbury Deposits," *Geol. Survey of Canada Ann. Rept.*, vol. xiv., part II; J. P. Coleman, *Ann. Report of the Ontario Bureau of Mines*, vol. xiv., part III. (1905).

chalcidonic silica, deposited around grains of sand. The most extensive of all ore-beds of this type and the mainstay of the German and Belgian smelting industry, are the Jurassic ores, locally called minette, of Luxembourg and the neighbouring territories. Three principal and several subordinate beds are distinguished, which furnish a product ranging from 30 to 40% of iron and between 1 and 2% of phosphoric oxide (P_2O_5). They are generally believed to have been deposited on the bottoms of embayments of the Jurassic sea. The iron was furnished by the drainage of the land and was precipitated, according to Van Werweke, as silicate, carbonate, sulphide and as several forms of oxide. More than two billions of tons are believed to be available. Very similar deposits occur in the Cleveland district, England, in the Middle Lias.

In the presence of much organic matter which creates reducing conditions, concretions and even beds of spathic ore or black-band may result and afford the ores of this type extensively utilized in the Scottish iron industry and formerly of some importance in the eastern United States.

The brown hematites often have more or less manganese, and manganese ores themselves may result by closely related reactions, since manganese is very similar to iron in its chemical properties. Aluminium is yielded by deposits of bauxite, the hydrated oxide, which in the States of Georgia and Alabama, of the United States, are the result of surface precipitations. In the depths it is believed that pyritous shales exist. The oxidation of the pyrite supplies sulphuric acid which takes into solution the alumina of the shales. Rising to the surface along a marked series of faults, the aluminium sulphate meets calcium carbonate in an overlying limestone, and the aluminium hydrate is precipitated as concretions at the vents of the springs.

Of scientific importance but as yet not of commercial value are the siliceous sinters deposited around the vents of hot springs which yield appreciable amounts of both the precious and the base metals. While surface precipitations in every particular, they are yet chiefly important in casting light on the processes of vein formation in the depths.

Non-metallic minerals which are deposited from solution on the surface of the earth are the salines, rock-salt, related potassium salts, gypsum and the rarer nitrates. The alkaline chlorides and gypsum are derived, in nearly all cases, from impounded bodies of sea-water, which, exposed to evaporation with or without constant renewal, finally yield beds of rock-salt and related minerals. Shallow estuaries cut off from the sea, it may be by the sudden rising of a bar during a heavy storm or brines impounded in deep bays with a shallow connexion as in the "bar theory" of Ochsenshiel, have given rise to the great stores of these minerals which are so extensively mined. The potassium compounds have only been found as yet in large quantities in the Stassfurt region of Germany, and seem to be due to the fact that in this locality the mother-liquors of the rock-salt deposits failed to escape, and were evaporated to dryness. The nitrates are chiefly obtained in northern Chile and are the result of the reaction of nitrogenous organic matter, upon alkaline minerals and under conditions where there is enough but not too much water.

Another very important mineral found in surface deposits formed from solution is asphalt. It has happened in various parts of the world, but especially in the island of Trinidad, in the Caribbean Sea, that petroleum with an asphalt base has reached the surface, and has evaporated, and has become a hard, so as to leave a residuum fit for street-paving or other purposes. So-called pit-h-lakes are afforded which may be of great commercial value.

Again, if large sheets, crusts, stalactites and stalagmites are deposited from calcareous water by the escape of the solvent carbonic acid, beautiful ornamental stones are afforded, generally known as Mexican onyx.

B. Impregnations in Open-textured Rocks.—In a number of instances in various parts of the world naturally open-textured rocks have been discovered so richly impregnated with the metalliferous minerals as to be ores. The enriching minerals have been introduced in solution, and the solvent has found its way through the rock because of its nature, character, and not because geological movements have opened it. Porous sandstones are one of the most common cases. Deposits of silver ores have been extensively mined at St George in southern Utah, consisting of films of argentic and cerargyrite, which have been precipitated upon fossil leaves, sticks, and in the sandstone itself. Over wide areas in the northern United States, copper in various minerals has been discovered in sandstones of Permian or Triassic age. At Silver Cliff, Colorado, silver ores have impregnated a volcanic tuff, while at the Boleo mines in Lower California tuffs yield copper ores. In at least two of the great copper mines on Lake Superior the native metal impregnates a conglomerate, and in a number of others it has enriched a cellular basalt, filling the low-basalt shells and cells.

In the Comstock district between Bonn and Aachen, sandstones of the Triassic Bunter Sandstein contain knots of galena, distributed over wide areas as impregnations. Organic matter is believed to have precipitated the galena by a reducing action upon percolating solutions of lead.

All these porous rocks have been fed by solutions which have entered along waterways, clearly due to faults or some extensive

breaks which have provided introductory conduits. The solutions have then been tapped off from the main passages by the porous rock. They are, therefore, closely connected with faults.

Non-metallic minerals in the form of petroleum and asphalt may also impregnate sedimentary beds or other rocks of open texture. Many oil wells derive their supplies from lenticular beds of sandstone in the midst of impervious shales, and others, as those in the Mexican fields near Tampico, from volcanic tuffs. Asphalt may saturate both sandstones and limestones in such richness as to furnish a natural paving material when crushed, heated and laid. Brines are also yielded by porous strata and supply much of the salt of the world.

C. Impregnations and Replacements of Naturally Soluble Rocks.—Ore-deposits of great importance appear in different regions which can only be interpreted as having been formed by the replacement of some or all of a rock with the metallic minerals. The most common rock to yield in this way is limestone, because of its soluble nature, but important cases occur of others composed of silicates. Replacement implies the precipitation of the ore and gangue, molecule by molecule, in the position of the original minerals but without, as in pseudomorphs, the necessary reproduction of crystalline forms. Some waterway must of course introduce the ore-bearing solution, but it may be carried in greater or less degree, the resulting ore-bodies. Lead and zinc ores, often carrying some silver, are those most widely distributed, as they were also the earliest recognized in deposits of this character. More than any other metals their association with limestone is pronounced. The replacements may be found near the supply fissure as in the great zinc deposits near Aachen, or the supply fissures may be obscure as at Leadville, Colorado. While ores occur in the limestone, they are often close along its contact with some relatively impervious stratum, which seems partly to have directed the circulations, partly to have checked or stagnated them, while precipitation took place. With the lead and zinc sulphides, pyrites and chalcopyrite are commonly associated in greater or less degree, the copper increasing locally. All the sulphides are exposed to oxidation above the ground-waters and mining in the upper levels has been often directed against the carbonate and sulphate of lead, or the mingled carbonate and hydrated silicate of zinc.

A non-metallic deposit formed by replacement and of much scientific interest is furnished by sulphur when derived from gypsum, as in the Sicilian and other localities of Europe.

D. Deposits along Anticlinal Summits and in Synclinal Troughs.—When strata experience folding they are violently strained at the bends, and, if stiff or brittle like limestone, often crack in limited fissures, which in anticlines open upward and in synclines downward. In this way joints in relatively great numbers. Soft rocks, such as shales, are moulded by the strains and often fracturing. Very gentle folds seem to have yielded such abundance of cracks in the lead and zinc district of the Upper Mississippi Valley as to cause the so-called "gash veins" which have been worked for many years. The crevices are not all vertical, but often run horizontally and are due to the parting and buckling of individual beds. The resulting ore-bodies are chiefly limited to a single great stratum, and are believed to have been formed by the infiltration of galena, blende and pyrite from overlying formations.

When strata are stiff enough to buckle under violent folding and part so as to produce openings of a crescentic cross-section which afterwards become filled, there result the "saddle-roofs" so remarkably illustrated in the gold veins of Victoria, Australia, and in pitching anticlines of a much larger character in Nova Scotia.

Of far the greatest importance of all the ore-bodies in troughs are the iron ores of the Lake Superior region, now the most productive of all the iron-mining districts. In a series of sedimentary formations, generally of Huronian age, and with associated eruptives, there occur strata consisting of a cherty iron carbonate, which were probably originally marine deposits akin to glauconite. They rest upon relatively impervious rocks, and are often penetrated by basaltic dikes. The entire series has been folded, so that the cherty carbonates, shattered by the strains, have come to rest in troughs of relatively tight impervious rocks. The descending surface water has never altered them, have taken the iron into solution, and have redeposited it in the troughs as a slightly hydrated red hematite. The silica has usually been precipitated elsewhere.

The most important of the non-metals which occur along anticlinal summits are petroleum and natural gas, but it is true only in a very limited sense that they are introduced in solution. The general cause of the accumulation is, however, the same as that of the metallic minerals, i.e. that storage cavities are afforded. In the most productive oil-fields it is the general experience to find the oil and gas impounded in porous rocks, either sandstones or limestones, at the crests of anticlines and beneath impervious shales which form the roof of the storage cavity.

E. Deposits in Shear-Zones.—Sometimes happening both in massive rocks and in sediments that strains of compression have been eased by local crushing along comparatively narrow belts without appreciable or measurable displacement of the sides such as would be required by a pronounced fault. The word shear-zone has become quite widely used in recent years as a descriptive term applicable to these cases.

MINING, but it may be remarked here that once formed they undergo all the foldings, faultings and disturbances which have affected the sedimentary rocks of other kinds.

BIBLIOGRAPHY.—The following are general works on the deposits of the useful minerals, in addition to Pospelov's volume already mentioned: In English—J. A. Phillips, revised by Henry Louis, *Treatise on Ore-Deposits* (London, 1896); J. F. Kemp, *Ore-Deposits of the United States and Canada* (New York, 1900); Prime's translation of Von Cotta's *Ore-Deposits* (New York, 1870); H. Ries, *Economic Geology of the United States* (New York, 1906); W. H. Weed's translation of Beck's *The Nature of Ore-Deposits* (New York, 1905); *Genesis of Ore-Deposits* (American Institute of Mining Engineers, 1901); G. P. Merrill, *The Non-Metallic Minerals* (New York, 1904). In German—B. von Cotta, *Die Lehre von den Erzlagertstätten* (Freiberg, 1859); A. von Groddeck, *Die Lehre von den Lagerstätten der Erze* (Leipzig, 1879); R. Beck, *Lehre von den Erzlagertstätten* (Berlin, 1904); A. W. Stelzner and A. Bergsät, *Die Erzlagertstätten* (Leipzig, 1905-1906). In French—E. Fuchs and L. de Launay, *Traité des gîtes minéraux et métallifères* (Paris, 1893); G. Moreau, *Étude industrielle des gîtes métallifères* (Paris, 1894). (J. F. K.)

MINERALOGY, the science which describes and classifies the different kinds of mineral matter constituting the material of the earth's crust and of those extra-terrestrial bodies called meteorites. The study of minerals is thus a branch of natural history, but one in which certain of the exact sciences find an application. The determination of the composition and constitution of minerals is a chemical problem; their optical and other physical properties are determined according to the principles of physics; the study of their crystalline form and structure belongs to crystallography; their modes of occurrence, origins, associations and changes come within the province of geology and petrology; while a consideration of the localities at which they are found requires some acquaintance with geography. Finally, there is the economic side, dealing with the mining and application of useful minerals, the extraction of metals from their ores, and the uses of minerals for building, decoration and jewelry.

In this article we shall treat only of the general characters of minerals; their special characters will be found in the articles on the individual minerals.

After a brief historical sketch the subject will be treated under the following headings:—

I. Characters of Minerals.

1. Morphological Characters.
 - a. Crystalline Form.
 - b. State of Aggregation: Structure.
2. Physical Characters.
 - a. Optical Characters (Colour, &c.).
 - b. Magnetic, Electrical and Thermal Characters.
 - c. Characters depending on Cohesion (Hardness, &c.).
 - d. Specific Gravity.
 - e. Touch, Taste and Smell.
3. Chemical Characters.
 - Synthesis of Minerals.

II. Occurrence and Origin of Minerals.

Alteration of Minerals: Pseudomorphs.

III. Nomenclature and Classification of Minerals.

History.—Owing to their numerous applications for useful and decorative purposes, minerals have attracted the attention of mankind from the earliest times. The stone and bronze implements of prehistoric man and many of his personal ornaments and charms were directly or indirectly of mineral origin. The oldest existing treatise on minerals is that written about 315 B.C. by Theophrastus (*περὶ τῶν λίθων—On Stones*, English version by John Hill, 1746), of which only a portion is now in existence. Minerals were then classed as metals, stones and earths. The last five books of Pliny's *Historia naturalis*, written about A.D. 77, treat of metals, ores, stones and gems. Some of the Arabian philosophers devoted themselves to the study of minerals, and about 1262 Albertus Magnus wrote his *De mineralibus*. In the 16th century Georgius Agricola published several large volumes, dealing more especially with the mining and metallurgy of metalliferous minerals, in which more exact descriptions were given of the external characters: he mentioned several minerals by names (e.g. blende, fluor, quartz) which are now in common use. About the same period there appeared

the systematic treatise on minerals of K. Gesner (1565), and that on precious stones by Anselm Boethius de Boodt (1609). The remarkable researches of Erasmus Bartholinus on Iceland-spar were published in 1669, and J. F. Henckel's *Pyrritologia* in 1725. Later came the *Systema naturae* of C. Linnaeus (1735). Although the importance of chemical properties was recognized by the Swedish chemists—J. G. Wallerius (1747) and A. F. Cronstedt (1758)—the external characters of minerals formed the basis of the mixed systems of classification of A. G. Werner (1774) and of other authors, and even as late as the *Natural History System of Mineralogy* of F. Mohs (1820).

It was not until the end of the 18th and beginning of the 19th century, when the foundations of crystallography were laid by Romé de l'Isle and R. J. Haüy, and chemistry had assumed its modern phase, that any real advance was made in scientific mineralogy. It was then recognized that chemical composition and crystalline form were characters of the first importance, and that external (natural history) characters were often more or less accidental. During this period numerous mineral substances were analysed by Scheele, Klaproth, Charles Hatchett, Vauquelin, Kirwan, Berzelius, Rose and other chemists, and many new mineral-species and chemical elements discovered. After W. H. Wollaston's invention of the reflecting goniometer in 1809, exact measurements of the crystalline forms of many minerals were made. The principles of isomorphism and dimorphism enunciated by E. Mitscherlich in 1819 and 1821 respectively cleared up many difficulties encountered in the definition of mineral-species. About the same time also the discovery by E. L. Malus of the polarization of light gave an impetus to the optical examination, by Sir David Brewster and others, of natural crystals. Later, the investigation of rocks in thin section under the microscope led to the exact determination, particularly by A. Des Cloizeaux (1867), of the optical constants of rock-forming minerals.

For a detailed account of the history of mineralogy (including crystallography), see F. von Kobell, *Geschichte der Mineralogie von 1650-1860* (München, 1864). The recent history of mineral-species may be well traced in the six editions of J. D. Dana's *System of Mineralogy* (1837-1892).

I.—Characters of Minerals.

A distinction is to be made between essential and non-essential characters. Essential characters are those relating to chemical composition, crystalline form, crystallo-physical properties and specific gravity; these are identical, or vary only within certain defined limits, in all specimens of the same mineral-species. Non-essential characters—such as colour, lustre, hardness, form and structure of aggregates—depend largely on the presence of impurities, or on the state of aggregation of imperfectly formed crystalline individuals. In an absolutely pure and perfectly developed crystal all the characters may be said to be essential, but such crystals are of exceptional occurrence in nature, and certain of the characters are subject to modification under different conditions of growth. For example: a well-formed crystal of haematite ("specular iron ore"), with its smooth black faces and brilliant metallic lustre, is strikingly different in appearance from a piece of massive haematite ("red iron ore"), which is dull and earthy and bright red in colour; the former is so hard that it can only with difficulty bescratched with a knife, while the latter is quite soft and soils the fingers. Both specimens will, however, be found on analysis to have the same chemical composition (Fe₂O₃), the same crystalline structure (as determined by the optical characters under the microscope in the case of the massive variety), and very nearly the same specific gravity (especially if this be determined upon finely powdered material, the effect of cavities being thus eliminated). The essential characters being identical, the difference between the two specimens lies in the state of aggregation of the material: with "specular iron ore" we have a single crystal, while with the "red iron ore" we are dealing with a confused aggregate of minute crystalline individuals, which have interfered with each other's growth to such an extent that no crystal-faces have been developed. Such differences do

not therefore depend on the nature of the material, but only on the conditions which prevailed during its growth. (See *e.g.* QUARTZ and CALCITE.)

In the following enumeration of the more salient characters of minerals it is to be noted that many of the terms used for non-essential characters are purely descriptive and have no exact definition; on the other hand, essential characters can be expressed numerically and are therefore perfectly definite.

1. Morphological Characters.

a. Crystalline Form.—This most important character of minerals can, of course, be determined only when the material available is in the form of crystals (*i.e.* crystallized), which is not always the case. Massive aggregates of crystalline material are of much more frequent occurrence; when small fragments or thin sections of such material are transparent, the crystalline symmetry may be determined, within certain limits, by the help of the optical characters (see below). External crystalline form must not, however, be considered alone apart from all other characters, for crystals of substances quite different chemically, *e.g.* silver iodide, zinc oxide and zinc sulphide, are sometimes almost identical in crystalline form; further, in groups of isomorphously related minerals the degree of symmetry will usually be the same and the angles vary only slightly, and unless the crystals are perfectly developed and suitable for exact goniometric measurement no crystallographic distinction can be made between two such species.

All the six systems of crystals and most of the thirty-two symmetry-classes are represented amongst minerals (see CRYSTALLOGRAPHY). Crystals of the same mineral-species may differ very widely in general form or habit; *e.g.* crystals of calcite (*q.p.*) may be rhombohedral, prismatic, scalenohedral or tabular in habit. Other descriptive terms of the habit of crystals are pyramidal, acicular or needle-shaped (from the Lat. *acicula*, a needle), capillary or hair-like (from the Lat. *capillus*, hair), &c.; and these peculiarities of habit may sometimes be characteristic of certain minerals. Sometimes also there are characteristic kinds of groupings of crystals: thus parallel, divergent or radiating (*e.g.* scolecite), rosette-shaped (*e.g.* haematite—*Eisenrosen*), reticulated (*e.g.* rutile), or matted. The faces of natural crystals may be smooth, rough, striated, curved or drusy,¹ *i.e.* studded with small crystal faces and angles.

b. State of Aggregation: Structure.—According to the particular state of aggregation of a number of imperfectly developed crystals, which have grown together, various kinds of structure may be presented even by the same mineral species. The descriptive terms applied to these structures are almost self-explanatory: thus the structure may be granular (*e.g.* marble), fibrous (asbestos), radio-fibrous or stellated (wavellite), columnar (beryl), laminar or lamellar (talc), bladed (cyanite), &c., according to the relative shape and sizes of the individual crystals composing the aggregate. When the constituent crystals are invisible to the unaided eye the material is described as compact; incoherent aggregates are powdery or earthy. Minerals which are really amorphous, *i.e.* without any crystalline structure, are comparatively few in number (*e.g.* opal); many which are apparently amorphous are really microcrystalline (*e.g.* turquoise). The term massive is often used loosely for a crystalline mineral not showing crystal-faces. Crystal-aggregates often assume more or less accidental and imitative external forms to which the following descriptive terms are applied: dendritic or arborescent (*e.g.* copper, pyrolusite), mossy (copper), leafy (gold), wiry or filiform (silver), capillary (millierite), coralloidal (aragonite), globular (aragonite, with concentric structure; wavellite, with radiated structure), mamillary or with breast-like protuberances (arsenic), nodular (malachite), warty (menilite), botryoidal or resembling a bunch of grapes (from *Bōtrypis*, a bunch of grapes) (dolomite), reniform or kidney-shaped (menilite), amygdaloidal or almond-shaped (agate), stalactitic (calcite, chalcodendrite), &c.

¹ This is from a German word, *druse*, originally meaning "brush," and applied by miners to hollow stones, lined with minute projecting crystals.

2. Physical Characters.

a. Optical Characters.—The action of crystallized matter on transmitted light is a character of the highest importance in mineralogy. Even when the substance is opaque in large masses, it may be sufficiently transparent when in small splinters or in thin sections for the determination of the optical characters. The refractive indices, strength of the double refraction, optic axial angle, extinction angles on certain faces, &c., are characters capable of exact measurement and numerical expression, and are constant for each mineral-species. (See CRYSTALLOGRAPHY.)

In their "diaphanity," or degree of transparency, minerals differ very widely even in the same species. Some, such as metals and most metallic sulphides are always opaque; while others may vary in different specimens from perfect transparency to perfect opacity (in the latter case, however, minute fragments will, as a rule, still be transparent). A good example of this is afforded by the varieties of quartz: rock-crystal is water-clear, chalcedony is translucent, and jasper opaque.

The "colour" of minerals is the character which first arrests attention; but being a character which may vary almost indefinitely in one and the same kind of mineral, it affords a typical example of a non-essential character. Thus, fluor-spar and quartz, when in well-formed and chemically pure crystals, are quite colourless and transparent; but it would be easy to collect a series of each of these minerals in which almost every shade of colour is represented. Crystals of fluor-spar of an emerald-green, purple, golden-yellow, bright pink or other colour are at first sight very different in appearance, and yet the difference is due solely to the presence of traces of colouring matters so small in amount that their exact nature is difficult or impossible to determine. The value of diamond, corundum and other gemstones depends largely on these accidental differences in colour. Such substances, which are essentially colourless and owe their colour to the presence of colouring matter as an impurity, are said to be "allochromatic"; any colour they may possess is non-essential. In some other substances, known as "idiochromatic," the colour is a definite and essential character; for example, the yellow colour of gold, the red of cinnabar, &c.; but even here, owing to differences in the state of aggregation and the presence of various impurities, they may be wide variations in colour. Colour is thus a character of little determinative value, especially in minerals which are allochromatic; but it is sometimes a useful guide when taken in conjunction with other characters. An elaborate list of colour-names for descriptive use was drawn up by A. G. Werner in 1774.

An important character of transparent crystals is that of unequal absorption in different directions; so that light will, as a rule, be differently coloured according to the direction in which it has travelled through the crystal: this is known as dichroism or pleochroism (see CRYSTALLOGRAPHY). Certain minerals (*e.g.* zircon, almandine and those containing cerium) when examined with a spectroscope by transmitted light exhibit characteristic absorption spectra.

The colours of minerals may also be due to the interference of rays of white light at the surfaces of thin crevices or minute inclusions, either tabular or fibrous in form, in the mineral; for example, the play of colours of opal; the change of colours of labradorite; the bands of rainbow colours (Newton's rings) seen along cleavage cracks and irregular internal fractures (*e.g.* in quartz); the iridescent tarnish due to a superficial film of a decomposition product (*e.g.* "peacock copper ore"); or the bluish opalescence of moon-stone and cat's-eye.

The true colour of a mineral is best revealed by its "streak," *i.e.* the colour of its powder. This is obtained by scratching the mineral, or by crushing a fragment of it on a sheet of white paper, or rubbing it upon unglazed porcelain. The streak of allochromatic minerals is white, while that of idiochromatic minerals is coloured and is often of determinative value. Ores of iron may, for example, generally be distinguished by their streaks: that of magnetite being black; haematite, blood-red;

limonite, yellow; and chalybite, white. The streak of a mineral may be either shining (e.g. argentite) or dull.

Another character depending on light is that of lustre, which is often very characteristic in certain minerals, though it may be considerably modified by the state of aggregation. For example, the usual adamantine lustre of diamond is not exhibited by the compact aggregate known as carbonado; while earthy masses of any mineral will be devoid of lustre. Descriptive terms applied to the kinds of lustre are: metallic (e.g. pyrites), adamantine (diamond), vitreous (quartz), resinous (pyromorphite), greasy (elaolite), waxy (chalcedony), pearly (talc, heulandite and other minerals with a perfect cleavage), silky (satin-spar), &c. The degrees of intensity of lustre are described as splendid, shining, glistening, glimmering and dull, and depend usually on the smoothness of the crystal-faces.

The phenomena of phosphorescence (*q.v.*), fluorescence (*q.v.*) and radio-activity (*q.v.*) are strikingly exhibited by some minerals. (See FLUOR-SPAR, DIAMOND, &c.)

b. Magnetic, Electrical and Thermal Characters.—These, as far as related to crystalline form, are discussed under crystallography (*q.v.*). Magnetite ("lode-stone") is the only mineral which is strongly magnetic with polarity; a few others, such as pyrrhotite and native platinum, possess this character to a much less degree. Many minerals are, however, attracted by the pole of a strong electro-magnet, while a few (diamagnetic) are repelled.

Most minerals with a metallic lustre are good conductors of heat and electricity; others are bad conductors. For example, graphite is a good conductor, while diamond is a bad conductor. Non-conductors of electricity become electrified by friction, some positively (e.g. quartz and topaz), others negatively (e.g. sulphur and amber). The length of time during which different gem-stones retain their charge of frictional electricity was made use of by R. J. Haüy as a determinative character. For the pyro-electrical and thermo-electrical characters of crystals see CRYSTALLOGRAPHY. Some minerals—for example, salt, sylvite and blende—are highly diathermanous, *i.e.* transparent for heat-rays.

The specific heat and melting point of minerals are essential characters capable of exact measurement and numerical expression, but they are not often made use of. Different minerals differ widely in their "fusibility": the following scale of fusibility was proposed by F. von Kobell:—

1. Stibnite . (525° C.)	5. Orthoclase . (1175° C.)
2. Natrolite . (965° C.)	6. Bronzite . (1300° C.)
3. Almandine (1265° C.)	7. Quartz . (1430° C.)
4. Actinolite . (1290° C.)	

The melting points given above in parentheses were determined by J. Joly. Stibnite readily fuses to a globule in a candle-flame, while quartz is infusible even on the thinnest edges before the ordinary blowpipe.

c. Characters depending on Cohesion.—Some minerals (e.g. a sheet of mica) are highly elastic, springing back to their original shape after being bent. Others (e.g. talc) may be readily bent, but do not return to their original form when released; these are said to be pliable or flexible. Settle minerals (e.g. chlorargyrite) may be cut with a knife without being fractured: related characters are malleability (e.g. argentite) and ductility (e.g. silver). The tenacity, or degree of fragility of different minerals varies widely: they may be brittle, tough, soft or friable. The fractured surface produced when a mineral is broken is called the "fracture," and the kind of fracture is often of determinative value; descriptive terms are: conchoidal (e.g. quartz, which may often be recognized by its glassy conchoidal fracture), sub-conchoidal, uneven, even, splintery (e.g. jade), hackly or with short sharp points (e.g. copper), &c.

In many cases when a crystallized mineral is broken it separates in certain definite directions along plane surfaces. This property of "cleavage" (see CRYSTALLOGRAPHY) is an important essential character of minerals, and one which is often of considerable assistance in their recognition. For example, calcite, with its three directions of perfect cleavage parallel to the faces of a rhombohedron, may always be readily

distinguished from aragonite or quartz; or again, the perfect cubical cleavage of galena renders this mineral always easy of recognition.

"Hardness," or the resistance which a substance offers to being scratched by a harder body, is an important character of minerals, and being a test readily applied it is frequently made use of. It must, however, be remembered that the hardness of an incoherent or earthy aggregate of small crystals will be very different from that of a single crystal. A comparative "scale of hardness" was devised by F. Mohs in 1820 for the purpose of giving a numerical statement of the hardness of minerals.

Mohs's Scale of Hardness.

1. Talc.	6. Orthoclase.
2. Gypsum.	7. Quartz.
3. Calcite.	8. Topaz.
4. Fluor-spar.	9. Corundum.
5. Apatite.	10. Diamond.

These minerals, arbitrarily selected for standards, are successively harder from talc the softest, to diamond the hardest of all minerals: a piece of talc is readily scratched by gypsum, and so on throughout the scale. A mineral which is capable of scratching calcite and itself be as easily scratched by fluor-spar is said to have a hardness of 3½. Some care is required to avoid error in the determination of hardness: it is best to select a smooth crystal-face, cleavage-surface or fracture on which to rub a sharp corner of the scratching mineral; the powder should be wiped off and the surface examined with a lens to see if a scratch has really been produced or only powder rubbed off the corner of the mineral with which the scratching was attempted. With a little practice a fair idea of the hardness of a mineral may be obtained with the use of a knife or file, which will scratch all minerals with a hardness of 6 or less. Thus iron-pyrites ($H = 6\frac{1}{2}$) and copper-pyrites ($H = 3\frac{1}{2}$), apatite ($H = 5$) and beryl ($H = 7\frac{1}{2}$), or gem-stones and their paste imitations may be readily distinguished by this test. Talc and gypsum can be readily scratched with the finger-nail.

Planes of parting, etching figures, pressure- and percussion-figures are sometimes characters of importance in describing and distinguishing minerals. (See CRYSTALLOGRAPHY.)

d. Specific Gravity.—The density or specific gravity of minerals is an essential character of considerable determinative value. In minerals of constant composition it has a definite value, but in isomorphous groups it varies with the composition: it also, of course, varies with the purity of the material. It is a character which has the advantage of numerical expression: minerals range in specific gravity from 1.01 for copalite to 22.84 for iridium. The exact determination of the specific gravity of minerals is therefore a matter of some importance. Three methods are in common use, *viz.* hydrostatic weighing, the pycnometer, and the use of heavy liquids. The first two methods are only applicable when a weighable amount of pure material can be selected or picked out; this is, however, generally a laborious operation, since impurities are often present and usually several species of minerals are closely associated, and in selecting material it is often necessary to determine some other character to make certain that only one kind is being selected. For exact determinations the pycnometer method is usually to be recommended, using for material the pure fragments which have been selected for quantitative chemical analysis. With a single pure crystal or a faceted gem-stone the method of hydrostatic weighing is usually applicable, providing the stone is pot too small. The most ready method, however, is that afforded by the use of a heavy liquid, and the most convenient liquid for this purpose is methylene iodide. This is a clear, mobile liquid with a specific gravity of 3.33, and by the addition of benzene, drop by drop, the specific gravity may be reduced to any desired amount. With such a liquid the specific gravity of the minutest fragment, the purity of which has previously been scrutinized under the microscope, may be rapidly determined. The liquid is diluted with benzene until the fragment just remains suspended, neither floating nor sinking; the specific gravity of the fragment will then be the same as that of the liquid, and the latter may be determined by hydrostatic weighing or, more conveniently, by

means of indicators. Small recognizable crystals of the following minerals may be kept at hand as a set of indicators: gypsum (sp. gr. 2.32), colemanite (2.42), orthocase (2.56), quartz (2.65), calcite (2.72), aragonite (2.93), rubellite (3.02), apatite (3.20), diopside (3.32), &c. With a series of tubes containing mixtures of methylene iodide and benzene of different densities and suitable indicators, specific gravities may be rapidly and accurately determined. Values intermediate between those of the indicators may be estimated by a diffusion column of the liquid, or by noting the rate at which the benzene evaporates and the specific gravity of the liquid increases. For use with minerals of specific gravity greater than 3.33 various other heavy liquids have been suggested; the best being thallium silvery nitrate ($\text{TlAg}(\text{NO}_3)_2$), which melts at 75°C . to a clear liquid with a density of 4.8, and is miscible with water.

e. Touch, Taste and Smell.—In their action on the senses of touch, taste and smell a few minerals possess distinctive characters. Talc is unctuous or soapy to the touch; tripolite and trachyte are respectively meagre and harsh. Some porous minerals (e.g. clays and hydrophane) adhere to the tongue. Gem-stones may often be distinguished from their glass imitation by the fact that they feel colder, since they are better conductors of heat. Bitumen and clays, when moistened, have a characteristic smell; pyrites and some other sulphides when rubbed emit a sulphurous odour. Minerals which are soluble in water have taste: e.g. saline (salt), alkaline (natron), bitter (epsomite), astringent (chalcantite), &c.

3. Chemical Characters.

Chemical composition is the most important character of minerals, and on it all modern systems of classification are based. A mineral-species cannot, however, be defined by chemical composition alone, since many instances are known in which the same chemical element or compound is dimorphous or polymorphous (see CRYSTALLOGRAPHY). Thus both the minerals diamond and graphite consist of the element carbon; both calcite and aragonite consist of calcium carbonate; and rutile, anatase and brookite consist of titanium dioxide. In such cases a knowledge of some other essential character, preferably the crystalline form, is necessary, before the mineral can be determined.

All the known chemical elements have been found in minerals; and of many of them minerals are the only source. On the other hand, nitrogen, which is frequently present in organic substances, is rare in minerals; carbon has a wide distribution in mineral carbonates. It is estimated that the minerals of the earth's crust consist of about 47% by weight of oxygen, 27 of silicon and 8 of aluminium; silicates, and especially aluminosilicates, therefore predominate, these being the more important rock-forming minerals.

The chemical composition of minerals is determined by the ordinary methods of analytical chemistry. Since, however, minerals of different kinds usually occur intimately associated, it is often a matter of some difficulty to select a sufficiency of pure material for analysis. For this reason the exact composition and the empirical formulae of several minerals, particularly amongst the silicates, still remain doubtful. There are even cases on record in which the chemical composition and the crystalline form have been determined on different minerals in the belief that they were the same. Whenever possible, therefore, the chemical analysis should be made on small pure crystals which have been previously determined crystallographically. For the qualitative chemical examination of minerals, when only a small amount of material is available, the methods of blowpipe analysis and microchemical analysis are often convenient. (See G. J. Brush, *Manual of Determinative Mineralogy*, 16th ed., by S. L. Penfield, New York, 1903; H. Behrens, *Manual of Microchemical Analysis*, London, 1894.)

The principle of isomorphism (see CRYSTALLOGRAPHY) is of the highest importance in mineralogy, and on it the classification of minerals largely depends. In some minerals (e.g. quartz) isomorphous or vicarious replacement is not known to occur;

but in the majority of minerals one or other of the predominant elements (generally the base, rarely that of the acid radicle) may be isomorphously replaced by equivalent amounts of other chemically-related elements. In some isomorphous groups of minerals replacement takes place to only a limited extent, and the element which is partly replaced always predominates; while in other groups the replacement may be indefinite in extent, and between the ends of the series the different members may vary indefinitely in composition, with no sharp demarcation between species. Thus in the group of rhombohedral carbonates the different species are usually sharply defined. In well-formed crystals of calcite the calcium is replaced by only small amounts of magnesium, iron, lead, &c.; in chalybite, however, iron is often more largely replaced by calcium, magnesium, manganese, &c., and the "brown spars" are not always readily distinguishable. In the dimorphous group of orthorhombic carbonates isomorphous replacement is less frequent, and the different species (aragonite, cerussite, &c.) are quite sharply defined. In other groups of minerals, particularly amongst the silicates, isomorphous replacement of the basic elements is so general that the several members of the series vary almost indefinitely in chemical composition, and will scarcely be the same for any two specimens, though it may be reduced to the same type of formula. For example, the formula of all varieties of garnet may be expressed generally as $\text{R}_3\text{R}'_2(\text{SiO}_4)_3$, where $\text{R}' = \text{Ca, Mg, Fe, Mn}$, and $\text{R}'' = \text{Al, Fe, Mn, Cr, Ti}$. Tourmaline affords another good example. In the plagioclase feldspars (see PLAGIOCLASE) we have an example of the isomorphous mixing of two end-members, albite ($\text{NaAlSi}_3\text{O}_8$) and anorthite ($\text{CaAl}_2(\text{SiO}_4)_2$) in all proportions and with no sharp line between the several sub-species. In some other similar cases the end-members of the series are purely hypothetical: e.g. in the scapolite group (mixtures of $\text{Ca}_2\text{Al}_2\text{Si}_2\text{O}_{12}$ and $\text{Na}_4\text{Al}_2\text{Si}_2\text{O}_{12}\text{Cl}$) and in the micas and chlorites. In such instances, where the formulae of the two end-members differ in type, "mass effect" may have some influence on the isomorphism.

In addition to isomorphous series, there are amongst minerals several instances of double salts, which contain the same constituents as the members of isomorphous series: e.g. dolomite (*q.v.*) and barytocalcite (*q.v.*).

The manner in which water enters into the composition of minerals is often difficult to determine. In some cases, e.g. in the zeolites (*q.v.*), it is readily expelled at a low temperature, even at the ordinary temperature over sulphuric acid, and may be reabsorbed from a moist atmosphere or replaced by some other substance: it is then regarded as "water of crystallization." In other cases, when expelled only at a higher temperature, it is to be regarded as "water of constitution," forming either a basic salt (e.g. malachite, $\text{Cu}(\text{OH})_2\text{CO}_3$) or an acid salt (e.g. diopside, H_2CuSiO_4 , and mica, *q.v.*). When present as hydroxyl it is often isomorphously replaced by fluorine (e.g. topaz, $[\text{Al}(\text{F},\text{OH})_2]\text{SiO}_4$). Sometimes the water is partly water of crystallization and partly water of constitution.

As to the actual chemical constitution of minerals the little that is at present known is mainly speculative. Dimorphous minerals, which have the same empirical formula may be expected to differ in constitution; and experiments have been made, for example on pyrites and marcasite, with the object of discovering a difference, but the conclusions of various investigators are not in agreement. More promising results have been obtained (by F. W. Clarke and others) by the action of various reagents on silicates, particularly on the more readily decomposed zeolites, and several substitution-derivatives have been prepared.

Synthesis of Minerals.—The production of minerals by artificial means is a branch of chemical mineralogy which has been pursued with considerable success, especially by French chemists. Most minerals have been obtained artificially in a crystallized condition, and many related compounds, not as yet found in nature, have also been prepared. Crystals of artificially prepared minerals, though usually quite small in size, possess all the essential characters of natural crystals, differing from these only in origin. The following are the principles of some of the

methods which have been used: simple sublimation (*e.g.* arsenolite); interaction of gases (*e.g.* haematite, from steam and ferric chloride; cassiterite, from steam and stannic chloride or fluoride); action of gases on liquids and solids; slow cooling of fused masses, either with or without the presence of *agents minéralisateurs* (*e.g.* minerals in furnace slags); from aqueous solution sometimes at a high temperature and under pressure (*e.g.*, quartz); electrolysis; or even by subjecting dry amorphous material to enormous pressure. The chemical reactions by which various minerals have been obtained are often of considerable help in speculating as to their mode of origin in nature, though it must be born in mind that the same mineral may have been formed, both naturally and artificially, by more methods than one. In this direction important results have been obtained experimentally by J. H. van't Hoff and his pupils on the formation of oceanic salt deposits, and by J. H. L. Vogt with slags. Many minerals used as gem-stones have been prepared artificially, *e.g.* diamond and ruby (see *GEMS: Artificial*).

II.—Occurrence and Origin of Minerals.

While some minerals are of rare and sporadic occurrence in rock-cavities and mineral-veins, others are widely distributed as important constituents of rocks. The same mineral species may have several distinct modes of occurrence and origin, and be associated with different minerals in each case; facts which are well illustrated by quartz (*q.v.*).

Minerals of Igneous Rocks.—The rock-forming minerals of primary origin in igneous rocks have crystallized out from the magma, or fused silicate-mass, which on consolidation gave rise to the rock-mass. Magmas sometimes contain a considerable amount of water and are then in a state of aqueo-igneous fusion, rather than of dry fusion: in such cases very coarsely crystalline rocks (pegmatites) often result, and under these conditions minerals of many kinds are formed as well-developed crystals. Those minerals which are present in large amount in igneous rocks are distinguished as essential constituents, since it is on these that the classification of igneous rocks is largely based: the most important are quartz, feldspars, pyroxenes, amphiboles, micas and olivines. Feldspars of different composition are present in almost all kinds of igneous rocks, while quartz and olivine are characteristic of acid (*e.g.* granite, rhyolite) and basic (*e.g.* basalt, peridotite) rocks respectively. When the magma contains alkalis in relatively large amount the "felspathoid" minerals, nepheline and leucite, are formed (*e.g.* in nepheline-syenite, leucite-basalt, &c.). Other minerals occurring as primary constituents, but only in small amounts, are distinguished as accessory; thus small crystals of magnetite, apatite, zircon, &c., are of frequent occurrence disseminated in igneous rocks (see *PETROLOGY*). Sometimes these accessory constituents are concentrated by magmatic differentiation, important ore-deposits sometimes resulting in this manner (*e.g.* of chromite, or nickel-bearing pyrrhotite). The alteration of igneous rocks by weathering and other processes results in the alteration of some or all of the primary minerals with the production of others, which are spoken of as secondary minerals: thus feldspars are often partly or wholly altered to kaolin, olivine to serpentine, pyroxene and mica to epidote, chlorite, &c.

Minerals are also formed by the vapours given off by igneous magmas. The gases emitted by volcanoes and solfataras may deposit directly by sublimation, or by their chemical interaction, such minerals as sulphur, sal-ammoniac, haematite, which occur, for instance, as incrustations on Vesuvian lava: the boric acid of the Tuscan lagoons has also originated in this way. The effects produced by the exhalations of deep-seated magmas are more complex in character, since the vapours, being more confined, have more opportunity of acting chemically not only on the surrounding rocks but also on the igneous rock-mass itself before its final consolidation. A good example of the "pneumatolytic" action produced by the vapours from a mass of granitic magma is afforded by veins of tin-ore, in which the ore (cassiterite) is associated with minerals containing boron and fluorine, such as topaz, tourmaline, lepidolite, fluor-apatite

and fluor-spar. The production of such minerals may be accounted for by assuming the presence of stannic fluoride in the vapours, which by reacting on water vapour would deposit cassiterite with the liberation of hydrofluoric acid, and this would again react on other minerals. The topaz and tourmaline crystals often found in the cavities of granites and pegmatites have doubtless been formed in this manner. In a similar way the exhalations of basic magmas have given rise to chlor-apatite with associated sphene and ilmenite, as, for example, in the extensive apatite veins in connexion with gabbro in southern Norway.

Minerals of Metamorphic Rocks.—By the baking action of a deep-seated igneous mass on the surrounding rocks or on included rock-fragments, various new minerals are developed. By this process of thermal or contact-metamorphism well-crystallized examples of many minerals have often been formed; *e.g.* in calcareous rocks (limestones), especially those containing some magnesium and silica, vesuvianite, garnet, diopside, tremolite, wollastonite, &c., are developed; in argillaceous rocks (slates), chloritoid and staurolite are characteristic products; and in arenaceous rocks (sandstones), cordierite and sillimanite often result. The effects of pressure (dynamo-metamorphism) on rocks of various kinds, especially those of igneous origin, also result in the production of new minerals: *e.g.* pyroxene is transformed to amphibole, orthoclase to muscovite, plagioclase to zoisite, olivine to tremolite, &c. In gneisses and crystalline schists, quartz, feldspar, mica, talc, amphibole, &c. are important constituents.

Minerals of Sedimentary Rocks.—By the weathering and disintegration of igneous and metamorphic rocks the various minerals set free and the products of decomposition of others supply the material of sedimentary rocks; thus sandstones consist largely of quartz, shales of kaolin and other clay minerals. Those minerals (*e.g.* gem-stones and gold) which resist the action of weathering processes are found as water-worn pebbles and grains in detrital deposits. Other sedimentary rocks consist of minerals deposited from solution either by chemical or organic agencies, from sea-water, lakes or springs: *e.g.* the calcite of limestones, deposits of bog-iron-ore (limonite), gypsum, rock-salt, &c.

Minerals Segregated in Veins and Rock-cavities.—Water percolating through rock-masses takes up mineral matter in solution, and the solutions so formed may further react on the minerals composing the rocks. Such solutions will deposit some of their dissolved material in rock-cavities with the production of various minerals. For instance, the amygdaloidal cavities of basic volcanic rocks (*e.g.* basalt, melaphyre), especially when the rocks are somewhat weathered, are frequently partly or completely filled with agate or beautifully crystallized zeolites, calcite, &c. The crevices and joint-planes of limestone become in this way coated with crystals of calcite, and those of siliceous rocks with quartz, giving rise to the abundantly occurring quartz-veins. In sedimentary rocks, pyrites, flint and other minerals become segregated round a nucleus of organic matter. The beautiful crystal-lined crevices in the crystalline rocks of the Alps have much the same origin, and so have the various types of ore-deposits, including metalliferous veins or lodes. In the latter cases, however, the solutions are no doubt sometimes of deep-seated origin and often connected with igneous and metamorphic processes. Metalliferous veins are storehouses of crystallized minerals of almost every kind, some being the ores themselves and others, such as quartz, calcite, barytes, fluor-spar, being gangue minerals. By the weathering of the metallic minerals of mineral-veins numerous other finely crystallized minerals result: for example, in the upper oxidized portion of veins of lead-ore (galena), crystals of anglesite, cerussite and pyromorphite are often met with; in veins of copper-ore the alteration of chalcocypite gives rise to malachite, cheslyite and cuprite.

Alteration of Minerals: Pseudomorphs.—Crystals which have been formed under one set of conditions of temperature and pressure and in the presence of certain solutions, will in many

cases be unstable under another set of conditions. The crystals may then be corroded or even completely redissolved, or the substance may undergo a chemical or physical change and give rise to the formation of other minerals which are stable under the new conditions. The results of such changes and alterations of minerals are very frequently to be observed in nature, and several instances have already been cited in the preceding section. A good example of the secondary products which may result by the decomposition of a mineral is afforded by pyrites (FeS₂), of which two types of alteration may be distinguished. By oxidation in the presence of pure water it gives rise to ferrous sulphate (melanterite), free sulphur and sulphuric acid; the melanterite by further alteration gives various basic ferric sulphates (copiapite, &c.); and the sulphuric acid by acting on surrounding rocks (limestone, clay, &c.) gives rise to the formation of gypsum, alunite and other sulphates. By the action of water containing oxygen and calcium carbonate in solution, pyrites suffers another kind of alteration: the sulphur is carried away in solution as gypsum and the iron is left behind as a ferric hydroxide (limonite) which preserves the original form of the crystals. We have then a pseudomorph (from *ψευδής*, false and *μορφή*, form) of limonite after pyrites; *i.e.* limonite with the external form of a crystal of pyrites.

Pseudomorphs are frequently met with in nature, and they are of considerable importance in studying the changes which minerals undergo. Several kinds of pseudomorphs are to be distinguished. When the alteration has involved no change in chemical composition of the material, but only in the internal crystalline structure and physical properties, the altered crystal is called a "paramorph." For example, crystals of aragonite are often altered to a confused granular aggregate of crystalline individuals of calcite, the change being accompanied by an increase in specific gravity but without change in external form: such a change may be effected artificially by simply heating a crystal of aragonite. Other examples of paramorphs are rutile with the form of anatase, and hornblende with the form of augite. An "epimorph" results from the encrustation of one mineral by another; the first may be afterwards partly or wholly dissolved out, leaving the second as a hollow shell (*e.g.* chalybite after fluor-spar). As instances of pseudomorphs in which there has been some chemical change the following may be cited: by the gain of chemical constituents, *e.g.* malachite after cuprite; by the loss of material, *e.g.* native copper after cuprite; or by an interchange of constituents, *e.g.* galena after pyromorphite and limonite after pyrites. In other cases there may be no evident chemical relationship between the two minerals, as, for example, in pseudomorphs of native copper after aragonite or quartz after calcite. Different minerals may also take the form of various organic remains.

III.—Nomenclature and Classification of Minerals.

A mineral species, or simple mineral, is completely defined by the statement of its chemical composition and crystalline form. When we are dealing with a definite chemical compound the limitation of species is easy enough; thus corundum, cassiterite, galena, blende, &c. are quite sharply defined mineral species. But with isomorphous mixtures the division into species, or into sub-species and varieties, must be to a certain extent arbitrary, there being no sharp lines of demarcation in many isomorphous groups of minerals. Thus in the mineral tourmaline the chemical composition varies indefinitely between wide limits, but no corresponding difference can be traced in the crystalline form or in the external characters save colour and specific gravity. Some authors have therefore questioned the advisability of separating minerals into species each with distinctive names, and they have attempted to devise chemical names for the different kinds of minerals. Owing, however, to the frequency of polymorphism and isomorphism amongst mineral substances such a system presents many practical difficulties. Thus the three modifications of titanium dioxide are more simply and conveniently referred to as rutile, anatase and brookite, while

to give a purely chemical designation to such a mineral as tourmaline would be quite impracticable. Further, later investigations often show that such chemical names require revision, and hence confusion may arise.

The practice of giving distinct names to different kinds of minerals dates from very early times (*e.g.* diamond). The common termination *ite* (originally *itis* or *ites*) was adopted by the Greeks and Romans for the names of stones, the names themselves indicating some character, constituent, or use of the stone, or the locality at which it was found. For example, haematite, because of the blood-red colour; siderite, containing iron; alabaster (originally alabastritis), a stone from which a vessel called an *alabastron* was cut; magnesite, from the locality Magnesia. The custom of naming minerals after persons is of modern origin; *e.g.* prehnite, biotite, haüyne, zoisite. Unfortunately there is a lack in uniformity in the termination of mineral names, many long-established names being without the termination *ite*, *e.g.* beryl, blende, feldspar, garnet, gypsum, quartz, zircon, &c. The termination *ine* is also often used, *e.g.* nepheline, olivine, serpentine, tourmaline, &c.; and many others were introduced by R. J. Haüy without much reason, *e.g.* anatase, diopside, epidote, analcime, sphene, &c. (see A. H. Chester, *A Dictionary of the Names of Minerals*, New York, 1896).

The number of known mineral species differs, of course, according to different authors; roughly there may be said to be about a thousand. The total number of mineral names (apart from chemical names), many of them being applied to trivial varieties or given in error, amount to about 5000.

Minerals may be classified in different ways to suit different purposes; thus they may be classified according to their uses, modes of occurrence, system of crystallization, &c. The earlier systematic classifications, being based solely on the external characters of minerals, were on natural history principles and too artificial to be of any value. J. J. Berzelius, in 1815, was the first to propose a purely chemical system of classification: his primary divisions depended on the basic (electro-positive) element and the sub-divisions on the acid (electro-negative) element. Such a method of classification, though still in use for metallic ores, must be quite arbitrary or give rise to much duplication; since, apart from isomorphous replacement, many minerals contain more than one metal. The systematic classifications in use at the present day are modifications in detail of the crystallo-chemical system published by G. Rose in 1852. Here there are four main divisions, *viz.* elements; sulphides, arsenides, &c.; halogen compounds; and oxygen compounds: the last, and largest, division is subdivided into oxides and according to the acid (carbonates, silicates, sulphates and chromates, phosphates and arsenates, &c.); in each section isomorphous minerals are grouped together. The classifications adopted by different authors differ much in detail, especially in the large section of the silicates, which presents many difficulties and for which no satisfactory classification has yet been devised.

As an example of a systematic classification of minerals the following may be given. Except in a few details it is the classification of Dana's *System of Mineralogy* (6th ed., 1892). Only those minerals which are described under their respective headings in these volumes are included: the list therefore serves, at the same time, as an enumeration of the more common and important species and varieties of minerals, and as a system of classification it is necessarily incomplete. Species belonging to the same isomorphous group are bracketed together: varieties are given in parentheses after the species to which they belong. The chemical composition of each species is given by the formula; and the crystal-system by the initial letters C (cubic), T (tetragonal), O (orthorhombic), M (monoclinic), A (anorthic), H (hexagonal) and R (rhombohedral): when the crystal class is definitely known to be some other than the holosymmetric this is indicated by a number corresponding to those used in the article CRYSTALLOGRAPHY, *e.g.* C₂ for the tetrahedral class of the cubic system.

I.—NATIVE ELEMENTS.

1. NON-METALS.			
Diamond	C		C2
(Bort, Carbonado)			
Graphite	C		
Sulphur	S		R
2. SEMI-METALS.			
Arsenic	As		R
Antimony	Sb		R
Bismuth	Bi		R
3. METALS.			
Gold	Au		C
Silver	Ag		C
Copper	Cu		C
Platinum	Pt		C

II.—SULPHIDES, ARSENIDES, TELLURIDES, ETC.

1. OF THE SEMI-METALS.			
Realgar	AsS		M
Stibnite	Sb ₂ S ₃		O
Bismuthite	Bi ₂ S ₃		R
Tetradymite	Bi ₂ TeS		O
Molybdenite	MoS ₂		R
2. OF THE METALS.			

A. Monosulphides, Etc.

Argentite	Ag ₂ S		C
Galena	PbS		C
Copper-glance	Cu ₂ S		O
Blende	ZnS		R2
Cinnabar	HgS		C3
Covellite	CuS		H
Greenockite	CdS		R2
Millerite	NiS		R
Nicolite	NiAs		R
Pyrrhotite	Fe ₉ S ₁₀		R

B. Intermediate Division.

Erubescite	Cu ₂ FeS ₄		C
Chalcocyanite	Cu ₂ FeS ₄		T2

C. Disulphides, Etc.

Pyrites	FeS ₂		C3
Smaltite	CoAs ₂		C3
Cobaltite	CoAsS		C3
Marcasite	FeS ₂		O
Mispickel	FeAsS		O
Sylvanite	AuAgTe		M

III.—SULPHO SALTS.

Freieslebenite	(Pb, Ag) ₂ (Sb, Sn)		M
Bournonite	PbCuSbS ₄		O
Pyraryrite	Ag ₂ SbS ₃		R2
Froustite	Ag ₂ AsS ₃		R2
Tetrahedrite	Cu ₅ SbS ₄		C2
Stephanite	Ag ₂ SbS ₃		O2
Stannite	Cu ₂ FeSnS ₄		T2
Argyrodite	Ag ₂ GeS ₃		C

IV.—HALOIDS.

1. ANHYDROUS.			
Salt	NaCl		C
Sylvite	KCl		C4
Cerargyrite	AgCl, Br, I		C
Fluor-spar	CaF ₂		C
Cryolite	Na ₃ AlF ₆		M
2. OXYCHLORIDES.			
Atacamite	Cu ₂ Cl(OH) ₂		O

V.—OXIDES.

1. OXIDES OF SILICON.			
Quartz	SiO ₂		R3
(Agate, Amethyst, Aventurine, Bloodstone, Cairngorm, Carnelian, Cat's-eye, Chalcedony, Chrysochrose, Heliotrope, Jasper, Mocha-stone, Onyx, Rock-crystal, Sard, Sardonyx.)			
Tridymite	SiO ₂		O(?)
Opal	SiO ₂ +nH ₂ O		Amorphous
2. OXIDES OF THE SEMI-METALS.			
3. OXIDES OF THE METALS.			

A. Anhydrous Oxides.

a. Monoxides.			
Cuprite	Cu ₂ O		C4
Zincite	ZnO		R2
Melconite	CuO		M
b. Sesquioxides.			
Corundum	Al ₂ O ₃		R
(Asteria, Emery, Ruby, Sapphire.)			
Haematite	Fe ₂ O ₃		R
Ilmenite ¹	FeTiO ₃		R4

¹ Often classed with the titanates.

c. Intermediate Oxides.²

Spinel	MgAl ₂ O ₄		C
Magnetite	Fe ₃ O ₄		C
Franklinite	(Fe, Zn, Mn)(Fe, Mn) ₂ O ₄		C
Chromite	(Fe, Mg)(Cr, Fe) ₂ O ₄		C
Chrysoberyl	BeAl ₂ O ₄		O
(Alexandrite, Cymophane)			

d. Dioxides.

Cassiterite	SnO ₂		T
Rutile	TiO ₂		T
Anatase	TiO ₂		T
Brookite	TiO ₂		T
Pyrolusite	MnO ₂		?
Pitchblende ³	(U, Th) ₂ O ₇		C

B. Hydrrous Oxides.

(Diaspore)	AlO(OH)		O
Goethite	FeO(OH)		O
Manganite	MnO(OH)		O
Limonite	Fe ₂ O ₃ .3H ₂ O		Amorphous
Bauxite	Al ₂ O ₃ .2H ₂ O?		"
Brucite	Mg(OH) ₂		R
Psilomelane	xMnO ₂ +yBaO+H ₂ O		Amorphous
(Wad)			

VI.—OXYGEN SALTS.

I. CARBONATES.

A. Anhydrous.

Calcite	CaCO ₃		R
(Satin-spar)			
Dolomite	CaMg(CO ₃) ₂		R4
Ankerite	Ca(Mg, Fe)(CO ₃) ₂		R
Magnesite	MgCO ₃		R
Chalybite	FeCO ₃		R
Rhodochrosite	MnCO ₃		R
Calamine	ZnCO ₃		R
Aragonite	CaCO ₃		O
Alstonite	(Ca, Ba)CO ₃		O
Witherite	BaCO ₃		O
Strontianite	SrCO ₃		O
Cerussite	PbCO ₃		O
Barytocalcite	CaBa(CO ₃) ₂		M
Parisite	(CeF) ₂ Ca(CO ₃) ₂		H
Phosgenite	(PbCl) ₂ CO ₃		T

B. Basic Carbonates.

Malachite	Cu ₂ (OH) ₂ CO ₃		M
Azurite	Cu ₃ (OH) ₂ (CO ₃) ₂		M

2. SILICATES.

A. Anhydrous Silicates.

a. Disilicates, R'Si₂O₆; Polysilicates, R'Si_nO_{6n-2}.			
Petalite	LiAl(Si ₃ O ₈) ₂		M
Orthoclase	KAlSi ₃ O ₈		M
(Moon-stone)			
Microcline	KAlSi ₃ O ₈		A
(Amazon-stone)			
Albite	NaAlSi ₃ O ₈		A
Oligoclase	Ab ₂ An ₁ to Ab ₃ An ₁		A
(Sun-stone)			
Andesine	Ab ₂ An ₁ to Ab ₁ An ₁		A
Labradorite	Ab ₁ An ₁ to Ab ₁ An ₂		A
Bytownite	Ab ₁ An ₂ to Ab ₁ An ₃		A
Anorthite	CaAl ₂ Si ₂ O ₈		A

b. Metasilicates, R'SiO₃.

Leucite	KAl(SiO ₃) ₂		Pseudo-C
Pollux	H ₂ CsAl ₂ (SiO ₃) ₃		C
Enstatite	MgSiO ₃		O
Bronzite	(Mg, Fe)SiO ₃		O
Hypersthene	(Fe, Mg)SiO ₃		O
Diopside	CaMg(SiO ₃) ₂		M
Augite	Ca(Mg, Fe)(SiO ₃) ₂		M
(Diallage)	with (Mg, Fe)(Al, Fe) ₂ SiO ₆		M
Acmite	NaFe ⁺⁺⁺ (SiO ₃) ₂		M
Spodumene	LiAl(SiO ₃) ₂		M
(Hiddenite, Kunzite)			
Jadite	NaAl(SiO ₃) ₂		M
Wollastonite	CaSiO ₃		M
Rhodnite	MnSiO ₃		A
Tremolite	CaMg ₂ (SiO ₃) ₂		M
[Actinolite]	Ca(Mg, Fe) ₂ (SiO ₃) ₂		M
(Asbestos, Nephrite)			

Amphibole Group.

Hornblende	Ca(Mg, Fe) ₂ (SiO ₃) ₄		M
	with NaAl(SiO ₃) ₂		
	and (Mg, Fe)(Al, Fe) ₂ (SiO ₃) ₂		M
Crocidolite	NaFe(SiO ₃) ₂ .FeSiO ₃		M
Beryl	Be ₃ Al ₂ (SiO ₃) ₆		H
(Aquamarine, Emerald)			

c. Intermediate.

Iolite	H ₂ (Mg, Fe) ₄ Al ₂ Si ₈ O ₂₁		O
--------	--	--	---

² Often classed as aluminates.

³ Usually classed as a uranate.

d. Orthosilicates, R₂SiO₄.			
Nepheline	K ₂ NaAlSi ₃ O ₈	H5	
Sodalite	Na ₄ (AlCl)Al ₃ (SiO ₃) ₂	C	
{Lazurite	Na ₄ (Na,S,Al)Al ₃ (SiO ₃) ₂	C	
{Lapis-lazuli			
{Grossularite	Ca ₃ Al ₂ (SiO ₄) ₃	C	
{Cinnamon-stone			
Pyrope	Mg ₃ Al ₂ (SiO ₄) ₃	C	
Almandine	Fe ₃ Al ₂ (SiO ₄) ₃	C	
{Andradite	Ca ₃ Fe ₂ (SiO ₄) ₃	C	
{Demantoid			
Olivine	(Mg,Fe) ₂ SiO ₄	O	
{Chrysolite, Peridot			
Phenacite	Be ₂ SiO ₄	R4	
Willemite	Zn ₂ SiO ₄	R4	
Diopside	H ₂ CuSiO ₄	R4	
Scapolite	mCa ₂ Al ₂ Si ₂ O ₇ Cl	T3	
vesuvianite	nNa ₂ Al ₂ Si ₂ O ₇ Cl	T3	
Zircon	H ₂ Ca(Al,Fe)Si ₂ O ₇	T	
{Hyacinth, Jacinth, Jargon			
Thortite	TbSiO ₄	T	
Danburite	CaB ₂ (SiO ₄) ₂	O	
Topaz	Al(F,OH)Si ₂ O ₆	O	
Andalusite	AlSiO ₃	O	
Sillimanite	AlSiO ₃	A	
Cyanite	AlSiO ₃	A	
{Datolite	CaAlBSiO ₅	M	
Eucalase	HBeAlSiO ₅	M	
Zoisite	Ca ₂ (AlOH)Al(SiO ₃) ₂	O	
Epidote	Ca ₂ (AlOH)(Al,Fe) ₂ (SiO ₃) ₂	M	
Axinite	H ₂ Ca ₂ BA ₂ (SiO ₄) ₂	A	
Prehnite	H ₂ Ca ₂ Al ₂ (SiO ₄) ₂	O2	
e. Subsilicates.			
Humite	Mg ₂ [Mg(F,OH)] ₂ (SiO ₄) ₂	O	
Hemimorphite	H ₂ ZnSiO ₅	O2	
Tourmaline	(H ₁ ,Na ₂ ,Mg) ₃ (Al,Fe) ₃ (BOH) ₄	R2	
Staurolite	Si ₂ O ₈	R2	
	HFeAl ₂ Si ₂ O ₈		
B. Hydrous Silicates.			
Apophyllite	H ₂ KCa ₂ (SiO ₃) ₄ +4H ₂ O	T	
Heulandite	H ₂ CaAl ₂ (SiO ₃) ₄ +5H ₂ O	M	
Phillipsite	(K ₂ ,Ca)Al ₂ (SiO ₃) ₄ +4H ₂ O	M	
Harmotome	H ₂ (K ₂ ,Ba)Al ₂ (SiO ₃) ₄ +5H ₂ O	M	
Stibite	(Ca,Al)(SiO ₃) ₄ +6H ₂ O	M	
Chabazite	(Ca,Na)Al ₂ (SiO ₃) ₄ +4H ₂ O, &c. R		
Analcite	NaAl(SiO ₃) ₂ +H ₂ O	C	
Natrolite	Na ₂ Al ₂ Si ₂ O ₇ +2H ₂ O	O	
Scorcielite	CaAl ₂ Si ₂ O ₇ +3H ₂ O	M3	
Muscovite	H,KAl ₂ (SiO ₃) ₂	O	
Lepidolite	KLiAl(OH,F) ₂ Al(SiO ₃) ₂	M	
Biotite	(H,K)(Mg,Fe,Al) ₂ (SiO ₃) ₂ &c. M		
Phlogopite	(H,K)(Mg,F) ₂ AlMgAl(SiO ₃) ₂	M	
Clintonite	H ₂ (Fe,Mg)Al ₂ SiO ₇ &c. M		
Chlorite	H ₂ (Mg,Fe) ₂ Al ₂ Si ₂ O ₇ &c. M		
Serpentine	H ₂ MgSi ₂ O ₆	M	
Talc	H ₂ Mg ₃ (SiO ₄) ₂	M	
Meerschaum	H ₂ MgSi ₂ O ₆	Amorphous	
Kaolin	H ₂ Al ₂ Si ₂ O ₆		
{Bole, Clay			
Pyrophyllite	HAi(SiO ₃) ₂	M?	
Allophane	Al ₂ SiO ₅ +5H ₂ O	Amorphous	
Chrysocolla	CuSiO ₃ +2H ₂ O		
c. Titanosilicates, Titanates.			
Sphene	CaTiSiO ₅	M	
Perovskite	CaTiO ₃	Pseudo-C	
3. NIOBATES, TANTALATES.			
Columbite	(Fe,Mn)(Nb,Ta) ₂ O ₆	O	
4. PHOSPHATES, ARSENATES, &c.			
A. Anhydrous Phosphates, &c.			
Monazite	(Ce,La,Di)PO ₄	M	
Byrrhonite	NaBePO ₄	O	
Apatite	[Ca(F,Cl)]Ca ₂ (PO ₄) ₂	H2	
{(Phosphorite)			
Pyromorphite	(Pb,C)Pb ₂ (PO ₄) ₃	H2	
Mincette	(Pb,C)Pb ₂ (AsO ₄) ₃	H2	
Vanadinite	(Pb,C)Pb ₂ (VO ₄) ₃	H2	
Amblygonite	Li(AlF)PO ₄	A	
B. Basic Phosphates, &c.			
Olivine	Cu ₂ (OH)AsO ₄	O	
Desclozite	(Pb,Zn) ₂ (OH)VO ₄	M	
Clinoclasite	Ca ₂ (OH) ₂ AsO ₄	M	
C. Hydrous Phosphates, &c.			
Vivianite	Fe ₂ (PO ₄) ₃ +8H ₂ O	M	
Erythrite	Fe ₂ (AsO ₄) ₃ +8H ₂ O	M	
Anabergite	Ni ₂ (AsO ₄) ₃ +8H ₂ O	M	
Wavellite	Al ₂ (OH) ₂ (PO ₄) ₃ +4H ₂ O	O	
Turquoise	[Al(OH) ₂ Cu(OH)] ₂ PO ₄ Amorph.		
Pharmacosiderite	Fe ₂ (OH) ₂ AsO ₄ +5H ₂ O	C2	
Childrenite	(Fe,Mn)Al(OH) ₂ PO ₄ +H ₂ O	O	
Liroconite	Cu ₂ Al(OH) ₂ (AsO ₄) ₂ +20H ₂ O	M	
{Torbernite	Cu(UO ₂) ₂ (PO ₄) ₂ +12H ₂ O	T	
{Autunite	Ca(UO ₂) ₂ (PO ₄) ₂ +12H ₂ O	O	
5. BORATES.			
Boracite	Mg ₂ Cl ₂ B ₁₀ O ₂₀	Pseudo-C2	
Colemanite	Ca ₂ B ₄ O ₇ +5H ₂ O	M	
Borax	Na ₂ B ₄ O ₇ +10H ₂ O	O	
6. NITRATES.			
Nitre	KNO ₃	M	
7. SULPHATES AND CHROMATES.			
A. Anhydrous Sulphates, &c.			
Barytes	BaSO ₄	O	
Celestite	SrSO ₄	O	
Anglesite	PbSO ₄	O	
Anhydrite	CaSO ₄	O	
Crocoite	PbCrO ₄	O	
B. Basic Sulphates.			
Brochantite	Cu ₂ (OH) ₂ SO ₄	M	
C. Hydrous Sulphates.			
Gypsum	CaSO ₄ +2H ₂ O	M	
Alunite	KAl(SO ₄) ₂ (OH)	R	
Jarosite	KFe ₃ (SO ₄) ₂ (OH) ₆	R	
D. Sulphates with Chlorides, Carbonates, &c.			
Connellite	Cu ₂ (Cl,OH) ₂ SO ₄ +15H ₂ O	H	
Leadhillite	Pb ₃ SO ₄ (CO ₃) ₂ (OH) ₂	O	
8. TUNGSTATES, MOLYBDATES.			
Wolframite	(Fe,Mn)WO ₄	M	
{Schreibite	CaWO ₄	T3	
{Wulfenite	PbMoO ₄	T4	
VII.—HYDROCARBON COMPOUNDS.			
1. SIMPLE HYDROCARBONS.			
Hatchettine, Ozocerite.			
2. OXYGENATED HYDROCARBONS.			
Amber, Resin, Copal, Batlivillite, Dopplerite.			
3. APPENDIX TO HYDROCARBONS.			
Petroleum, Asphaltum, Bitumen, Eclaterite, Albertite, Coal, Anthracite, Jet, Lignite.			
REFERENCES.—Elementary introductions to the study of minerals are: E. S. Dana, <i>Minerals and how to study them</i> (New York, 1895); A. J. Moses and C. L. Parsons, <i>Elements of Mineralogy, Crystallography and Biopneic Analysis from a Practical Standpoint</i> (4th ed., New York, 1911); L. Fletcher, <i>An Introduction to the Study of Minerals</i> (British Museum Guide, 1897), a better work on popular lines is: R. Brauns, <i>The Mineral Kingdom</i> , Eng. trans. by L. J. Spencer (Stuttgart, 1908, &c.). Textbooks for students are: H. A. Miers, <i>Mineralogy, an Introduction to the Scientific Study of Minerals</i> (London, 1902); E. S. Dana, <i>Textbook of Mineralogy</i> (3rd ed., New York, 1898); and in German: C. F. Naumann, <i>Elemente der Mineralogie</i> (15th ed., by F. Zirkel, Leipzig, 1907); G. Tschermak, <i>Lehrbuch der Mineralogie</i> (6th ed., Vienna, 1905). The standard works of reference for descriptive mineralogy are: J. D. Dana, <i>System of Mineralogy</i> (6th ed., by E. S. Dana, New York, 1892); C. Hintze, <i>Handbuch der Mineralogie</i> (Leipzig, 1898, &c.), the latter gives full details respecting the localities of minerals; P. Groth, <i>Chemische Kristallographie</i> (Leipzig, 1906, &c.). For special branches of mineralogy reference may be made to the following works: R. Brauns, <i>Chemische Mineralogie</i> (Leipzig, 1896); H. Rosebusch, <i>Mikroskopische Physiographie der Mineralien und Gesteine</i> , Band I, <i>Die petrographisch-wichtigen Mineralien</i> , 4th ed., by H. Rosebusch and E. A. Wülfing (Stuttgart, 1904-1905); J. P. Iddings, <i>Rock Minerals</i> (New York, 1906); P. Groth, <i>Tabellarische Übersicht der Mineralien</i> (4th ed., Braunschweig, 1898); C. P. Merrill, <i>The Non-metallic Minerals, their Occurrence and Uses</i> (New York, 1904); G. J. Brush, <i>Manual of Determinative Mineralogy</i> (16th ed., by S. L. Penfield, New York, 1903); M. Bauer, <i>Edelsteinkunde</i> (2nd ed., Leipzig, 1909), and Eng. trans. <i>Precious Stones</i> , by L. J. Spencer (London, 1904).			
The more important topographical works are: R. P. Greg and W. G. Lettsom, <i>Manual of the Mineralogy of Great Britain and Ireland</i> (London, 1858); J. H. Collins, <i>Handbook to the Mineralogy of Cornwall and Devon</i> (Truro, 1871); M. F. Heddie, <i>Mineralogy of Scotland</i> (2 vols., Edinburgh, 1901); A. Lacroix, <i>Minéralogie de la France et de ses colonies</i> (3 vols., Paris, 1893, &c.); O. Luettcke, <i>Die Minerale von Carlsberg</i> (Berlin, 1893); Frenzel, <i>Mineralogisches Lexikon für das Königreich Sachsen</i> (Leipzig, 1874); A. Kennott, <i>Die Minerale der Schweiz</i> (Leipzig, 1866); V. von Zepharovich, <i>Mineralogisches Lexikon für das Kaiserthum Österreich</i> (3 vols., Vienna, 1859-1893); N. von Kokscharov, <i>Moterialien zur Mineralogie Russlands</i> (11 vols., St. Petersburg, 1853-1882); T. Wada, <i>Minerals of Japan</i> (Tokyo, 1904); A. Liversidge, <i>The Minerals of New South Wales</i> , &c. (London, 1888); O. B. Böggid, <i>Mineralogie Groenlandia</i> (Copenhagen, 1905); <i>A Catalogue of American U.S.A. and Canada Localities of Minerals</i> is given in Dana's <i>System of Mineralogy</i> .			
The following scientific journals are devoted to mineralogy: <i>Neues Jahrbuch für Mineralogie</i> , &c. (Stuttgart, since 1807); <i>Tschermaks Mineralogische und petrographische Mittheilungen</i> (Vienna, since 1872); <i>The Mineralogical Magazine and Journal of the Mineralogical Society</i> (London, since 1876); <i>Zeitschrift für</i>			

Krystallographie und Mineralogie, ed. by P. Groth (Leipzig, since 1877); *Bulletin de la société française de minéralogie* (Paris, since 1878); *Rivista di mineralogia e cristallografia* (Padova, since 1887). (L. J. S.)

MINERAL WATERS. No absolute line of demarcation can be drawn between ordinary and mineral waters. There is usually in the latter an excess of mineral constituents or of temperature, but some drinking waters contain more mineral constituents than others that are called mineral waters, and many very pure waters, both cold and warm, have been regarded for ages as mineral springs.

As to the origin of mineral waters, there is much in what the elder Pliny said, that waters are such as the soil through which they flow. Thus in limestone and chalk districts an excess of lime is usually present; and the waters of a particular district have much resemblance to each other—as in the Eifel, in Auvergne, and in the Pyrenees. But this is only a partial explanation, for waters are by no means necessarily uniform throughout a particular geological formation. We do not know with any certainty the depth from which various mineral waters proceed, nor the various distances from the surface at which they take up their different mineral constituents.

The source of the temperature of thermal waters remains a subject of much uncertainty. Among the assigned causes are the internal heat of the globe, or the development of heat by chemical or electrical agencies in the strata through which they arise.

Their occasional intermittence is doubtless often dependent on the periodical generation of steam, as in the case of the Geysers. A few geological facts are certain, which bear on the origin of mineral waters. Such springs are most abundant in volcanic districts, where many salts of soda and much carbonic acid are present. They occur most frequently at meetings of stratified with unstratified rocks, in saddles, and at points where there has been dislocation of strata.

The diffusion of mineral waters is very extended. Pliny was quite correct in observing that they are to be found on alpine heights and arising from the bottom of the ocean. They are found at the snow in the Himalayas and they rise from the sea at Baiae and Ischia. They are to be found in all quarters of the globe, but more particularly in volcanic regions, as in the Eifel and Auvergne, in the Bay of Naples, and parts of Greece, in Iceland, New Zealand and Japan. But there are few countries in which they are not to be found, except in very flat ones, and in deltas of rivers—for instance, in the north of France, where they are very few, and in Holland, from which they are absent. France, Germany, Italy and Spain, as well as Greece, Asia Minor, and the Caucasus, are all rich in mineral waters. The British Isles have a fair though not very large proportion of them. There are a few in Sweden and Norway. They are abundant in the United States, less so in Canada. They are found in the Azores and in the West India Islands. Of their occurrence in the interior of Africa or of Australia we know little; and the same is true of South America. But they are met with in Algiers, in Egypt, and in the Holy Land. The vast Indian peninsula has for its size a comparatively small supply.

Mineral waters, when analysed, are found to contain a great many substances, although some of them occur only in very minute quantities: soda, magnesia, calcium, potash, alumina, iron, boron, iodine, bromine, arsenic, lithium, caesium, rubidium, fluorine, barium, copper, zinc, manganese, strontium, silica, phosphorus, besides extractive matters, and various organic deposits known under the name of glairin or baregin. Of gases, there have been found carbonic acid, hydrosulphuric acid, nitrogen, hydrogen, oxygen and ammonia. Of all these by far the most important in a therapeutic point of view are sodium, magnesia and iron, carbonic acid, sulphur, and perhaps hydrosulphuric acid. These substances, detected separately by chemists, are in their analyses combined by them into various salts, if not with absolute certainty, undoubtedly with a close approximation to it. Those combinations are very numerous, and some waters contain ten to twenty of them; but there are

always some predominating ones which mark their character, while many of them, such as caesium, rubidium, or fluorine, occur in mere traces, and cannot be assumed to be of any real importance. Mineral waters therefore resolve themselves into weaker or stronger solutions of salts and gases in water of higher or lower temperature. For medical purposes they are used either externally or internally. As the quantity of salts present commonly bears but a very small proportion to that of the fluid containing them, water becomes a very influential agent in mineral-water treatment, about which it is therefore necessary to say something.

For the action of mineral-water baths see **BALNEOTHERAPEUTICS**. According to the most generally received opinion, the cutaneous surface does not absorb any portion of the salts in a mineral-water bath, although it may absorb a little gas (and alkaline water, for instance, at most acting as a slight detergent on the skin), and that neither salts nor gases have any action on the system, except as stimulants of the skin, with partial action on the respiratory organs.

It seems to be ascertained that drinking considerable amounts of cold water reduces the temperature of the body, diminishes the frequency of the pulse, and increases the blood pressure temporarily. Water when introduced into the stomach, especially if it be empty, is quickly absorbed; but, although much of the water passes into the veins, there is no proof that it ever produces in them, as is sometimes supposed, a state of fluidity or wateriness. Therapeutically, the imbibition of large quantities of water leads to a sort of general washing out of the organs. This produces a temporary increase of certain excretions, augmented diuresis, and a quantitative increase of urea, of chloride of sodium, and of phosphoric and sulphuric acids in the urine. Both the sensible and the insensible perspirations are augmented. A draught of cold water undoubtedly stimulates the peristaltic action of the intestines. On the whole water slightly warm is best borne by the stomach, and is more easily absorbed by it than cold water; and warm waters are more useful than cold ones when there is much gastric irritability. In addition to the therapeutic action of mineral waters, there are certain very important subsidiary considerations which must not be overlooked. An individual who goes from home to drink them finds himself in a different climate, with possibly a considerable change in altitude. His diet is necessarily altered, and his usual home drinks are given up. There is change in the hours of going to bed and of rising. He is relieved from the routine of usual duties, and thrown into new and probably cheerful society. He takes more exercise than when at home, and is more in the open air, and this probably at the best season of the year. So important has this matter of season and climate been found that it is an established axiom that waters can be used to the greatest advantage during the summer months and in fine weather, and during the periods most convenient for relaxation from business. Summer is therefore the bath season, but of late years provision has been made in many places, with the aid of specially constructed rooms and passages, for carrying out cures satisfactorily during the winter season, e.g. at Aix-la-Chapelle, Wiesbaden, Baden Baden, Baden in Switzerland, Dax, Vichy and Bath. The ordinary bath season extends from the 15th of May to the 20th or 30th of September. The season for baths situated at considerable elevations commences a month later and terminates some ten days earlier. Mineral waters may be employed at home, but patients seldom so use them; and this necessarily limits the time of their use. It is common to declare that the treatment should last for such or such a period. But the length of time for which any remedy is to be used must depend on its effect, and on the nature of the particular case. It is found, however, that the continued use of mineral waters leads to certain disturbances of the system, which have been called crises, such as sleeplessness, colics and diarrhoea, and to skin eruptions known as *la poussée*. This cause, and also certain peculiarities of the female constitution, have led to the period of three weeks to a month being considered the usual period for treatment. A certain after-treatment is often prescribed—such as persistence

in a particular diet, visiting springs or climates of a different and usually of a tonic character, or continuing for a certain time to drink the waters at home. It may be added that the advantage of having recourse to mineral waters is often felt more after than during treatment.

Since improved methods of bottling have been discovered, and the advantage of an additional supply of carbonic acid has been appreciated, the export of waters from their sources has increased enormously, and most of the principal waters can now be advantageously used at home. It may be added that many of the artificial imitations of them are excellent.

The history of the use of mineral waters can only just be

a good deal of nitrogen in some of them; the quantity of hydro-sulphuric acid, even in strong sulphuric waters, is wonderfully small; but the volume of carbonic acid present is often very large—for instance, in the case of Kissingen, Schwalbach and Selters. The immediate effect of the carbonic acid which they contain is that of pleasant stimulation to the stomach and system. Extremely little appears to be known of its actual operation on the system: a part of what is swallowed is returned by eructation, and a part passes on to the intestines; whether any appreciable quantity reaches the blood is doubtful. There is no question that carbonic acid increases diuresis. Practically it is found to aid digestion, helping the functions of the stomach, and in

TABLE I.—Typical Mineral Waters.

	Indifferent. Gastein, 95°-118°.	Earthy. Leuk, 123 8°.	Salt. Kissingen.	Salt. Sea-Water.	Sulphur. Aix-la- Chapelle, 113°-140°.	Iron. Schwalbach.	Alkaline. Vichy, 105 8°.	Alkaline- Saline. Carlsbad, 119°-135°.	Table Water. Selters.	Purging Water. Hunyadi Janos.
<i>Solids.</i>										
Bicarbonate of soda . . .	—	—	—	—	0-6449	0-0206	4-883	1-92	1-2	—
" potash . . .	—	—	—	—	—	—	0-352	—	—	—
" magnesia . . .	0-0017	0-013	0-017	0-45	0-0506	0-2122	0-303	0-18	—	—
" calcium . . .	0-0195	0-012	1-06	2-38	0-157	0-2213	0-434	0-428	—	—
Sulphate of soda . . .	0-0208	0-050	—	—	0-2831	0-0079	0-292	2-37	—	15-9
" potash . . .	0-0135	0-038	—	—	0-1527	0-0037	—	0-16	—	—
" magnesia . . .	—	0-308	0-588	2-96	—	—	—	—	0-46	16-0
" calcium . . .	—	1-520	0-389	0-25	—	—	—	—	—	—
Sulphide of sodium . . .	—	—	—	—	0-0136	—	—	—	—	—
Chloride of sodium . . .	0-0428	—	5-52	25-21	2-616	—	0-534	1-03	2-2	1-3
" potash . . .	—	—	0-286	—	—	—	—	—	—	—
" magnesia . . .	—	—	0-303	3-39	—	—	—	—	—	—
Carbonate of iron . . .	0-0005	0-023	—	—	—	0-0837	—	0-003	0-01	—
Silicic acid . . .	0-0496	0-036	—	—	—	0-0320	—	—	—	—
<i>Gases.</i>										
Carbonic acid . . .	—	—	3-19	—	—	5-35	2-6	0-76	2-24	0-45
Hydro-sulphuric acid . . .	—	—	—	—	trace	—	—	—	—	—

alluded to. They have been employed from the earliest periods, and traces of Roman work have been found at most of the European baths which are now in favour—at almost all the thermal ones. Occasionally new springs are discovered in old countries, but the great majority of them have been long known. Warm waters, and those containing small quantities of mineral constituents, appear to have remained more steadily in favour than any other class within the appropriate sphere of mineral waters, which is limited to the treatment of chronic disease.

The attempt has been made to range mineral waters according to their therapeutic action, according to their internal or external use, but most generally according to their chemical constituents so far as they have been from time to time understood; and a judicious classification undoubtedly is a help towards their rational employment. But their constituents are so varied, and the gradations between different waters are so finely shaded off, that it has been found impossible to propose any one definite scientific classification that is not open to numberless objections. Thus a great many of the sulphur waters are practically earthy or saline ones. Yet because they contain very minute amounts of such a gas as hydro-sulphuric acid, an ingredient so palpable as always to attract attention, it is considered necessary to class them under the head of sulphur. The general rule is to attempt to class a water under the head of its predominant element; but if the amount of that be extremely small, this leads to such waters as those of Mont Dore being classified as alkaline or arsenated, because they contain a very little soda and arsenic. The classification in the following table, which is that usually adopted in Germany, has the merit of comparative simplicity, and of freedom from theoretical considerations which in this matter influence the French much more than the German writers. The more important constituents only are given. The amount of solid constituents is the number of parts to one thousand parts of the water; the temperature of thermal springs is added. The waters are classified as indifferent, earthy, salt, sulphuretted, iron, alkaline, alkaline-saline—with subvarieties of table waters and purging waters.

In addition to their solid constituents, gas is present in many waters in considerable quantity. There is a little oxygen and

a slight degree the peristaltic action of the intestines. The increased flow of urine may be caused by its favouring the absorption of water by the stomach. In some baths carbonic acid is so abundant that precautions have to be taken to prevent

TABLE II.—Indifferent Waters.

Locality.	Height in Ft.	Temp. Fahr.	For what prescribed.
Evian, Lake of Geneva	1100	—	Nervous cases, dyspepsia, urinary affections. For mild rheumatic treatment; a health resort.
Badenweiler, Baden	1425	—	
Buxton, England	980	82	Gout and rheumatism (nitrogen present).
Schlangenbad, Nassau	800	80-87	Nervous cases, female disorders, skin.
Sacedon, Spain	1500	85	Rheumatism, gout, cutaneous affections.
Wildbad, Württemberg	1320	90-101	Gout and rheumatism, neuralgia, thickenings.
Pfeffers, Switzerland	2115	99	Do. do. do.
Ragatz, do.	1570	95	Do. do. do.
Panticosa, S. Pyrenees	5110	85-95	(Do. (nitrogen present); special action in phthisis.
Teplitz, Bohemia	648	101-120	Gout, rheumatism, old injuries, joints or bones.
Gastein, Austria	3315	95-118	Do. do.; soothes nervous system.

its tendency to accumulate on account of its heavy specific gravity. Carbonic acid gas, used as a bath, proves stimulating to the skin and to the general system; but its employment has not answered the expectations formed of it.

Indifferent Waters scarcely vary in chemical qualities from ordinary drinking water; but they are usually of higher temperature. Their therapeutic action, which is mainly exercised through baths,

¹ In this and the following tables a selection is given of some of the best-known mineral waters in various European countries that possess establishments. Their chief peculiarities of elevation, of temperature and constituents are briefly noted. The curative effects, necessarily alluded to very generally, are those usually attributed to them.

has been explained on the theory of peculiarities of their electric or thermal condition, about which we know nothing definite, and on the presence in some of them of a large quantity of nitrogen. It has also been ascribed to the various organic substances in some of them, such as glairin, which when collected is sometimes useful as a cataplasm. These waters are not often much drunk, but any efficiency they may have in dyspepsia and perhaps in neuralgic diarrhoeas must be attributed to the favourable action of hot water on the digestion. The waters of this class, especially the hotter ones in the form of baths, are extremely useful in resolving the effects of inflammation, in thickenings of the joints and in chronic rheumatism and gout. They also are often effective, especially the cooler ones, in neuralgia and in some hysterical affections. They are sometimes prescribed in urinary affections, in which case they probably assist by dilution. The effects of many of these waters are aided by the baths often being situated at considerable elevations and in out-of-the-way spots, whence the Germans called them *Wildbäder*. They are very widely diffused, being found in all quarters of the globe, especially in volcanic districts. There are many in New Zealand; in America the hottest are in the west and in California.

Earthy Waters.—These differ chiefly from the indifferent waters in containing an appreciable quantity of salts, among which sulphate or carbonate of lime or of magnesia predominates. The great majority of them are of high temperature. They produce the same effects as the indifferent waters, but are perhaps less efficacious in neuralgic affections, while they are more employed in some of the chronic scaly eruptions. There was formerly a tendency to consider these waters useful in urinary affections; but at the present day it is only the colder ones that have come into repute for the expulsion of gravel and biliary calculi, and in the treatment of affections of the bladder generally. Some of them have also of late years been considered to exercise a favourable influence on scrofula, and to be useful in the early stages of pulmonary phthisis. This has been attributed to the salts of lime present in them, although it is known that most of its salts pass through the system unaltered. Many of these baths, such as Leuk and Bormio, enjoy the advantages of great elevation, but Bath, otherwise one of the best of them, lies low.

TABLE III.—Earthy Waters.

	Locality.	Height in Ft.	Temp. ° Fahr.	Therapeutic Action.
Cold.	Contrexéville, Vosges	1050	—	{Special action in cal- culous affections.
	Lixp Springs, N. Germany	—	—	{Supposed to be use- ful in phthisis.
	Wildungen, do.	—	—	{Special use in urinary complaints; contains iron.
	Weissenberg, Switz- zerland	2600	—	{Resorted to for pul- monary affections.
Warm.	Pougues, France	600	—	{Dyspepsia, diabetes, hepatic and urinary concretions.
	Baden, Switzerland	1180	117-122	{Rheumatism, gout, paralysis, scaly eruptions.
	Leuk, do.	4400	93-123	{Do., some female complaints.
	Bormio, North Italy	4400	86-104	{Do. do.; old sprains.
	Lucca, Italy	—	108-122	{Do. do. do.
	Bath, England	—	108-122	{Do. do. do.
	D. de Bourges, France	1400	139	{Do.; chlorosis, neural- gia.
Bax, de Sighor, Pyr- enees	1800	64-123		

Salt Waters are so called from containing a predominant amount of chloride of sodium. They also generally contain chlorides of magnesia and of lime, and occasionally small amounts of lithium, bromine and iodine. They further often contain a little iron, which is an important addition. The great majority of the drinking wells have a large supply of carbonic acid. There are cold and hot salt springs. Sometimes they are used for drinking, sometimes for bathing; and the double use of them is often resorted to.

The normal quantity of common salt consumed daily by man is usually set down at about 300 grains. The maximum quantity likely to be taken at any well may be 225 grains, but commonly not more than half of that amount is taken. The increase to the usual daily amount is therefore probably not much more than one-third. Still it may be presumed that the action of a solution of salt on an empty stomach is different from that of the same amount of salt taken with food. Salt introduced into the stomach excites the secretion of gastric juice and favours the peristaltic actions, and the same taken in considerable quantity is distinctly aperient. We thus see how it is useful in dyspepsia, in atony of the stomach and intestines, and sometimes in chronic intestinal catarrh. Salt when absorbed by the stomach appears again in the urine, of which it

increases the amount both of fluid and of solid constituents, especially of the urea. It seems, therefore, to be pretty certain that considerable quantities of salt taken into the circulation increase the excretion of nitrogenous products through the urine, and on the whole accelerate the transformation of tissue. Salt is thus useful in scrofula by stimulating the system, and also in anaemia, especially when iron is also present. In some German stations, as at Soden, carbonated salt waters are considered to be useful in chronic laryngitis or granular pharyngitis.

Baths of salt water, as usually given, rarely contain more than 3% of chloride of sodium, some of the strongest perhaps from 8 to 10%. Their primary action is as a stimulant to the skin, in which action it is probable that the other chlorides, especially that of calcium, and still more the carbonic acid often present, co-operate. In this way, and when aided by various processes of what may be termed water poultices and packing, they are often useful in removing exudations, in chronic metritis and in some tumours of the uterus, and generally in scrofula and rachitis, and occasionally in some chronic skin affections.

The French accord high praise to some of their thermal salt waters in paralysis, and some German ones are used in a similar way in spinal affections. The salt waters are sometimes so strong that they must be diluted for bathing. In other cases concentrated solutions of salt are added to make them sufficiently strong. These waters are widely diffused, but on the whole Germany is richest in them, especially in such as are highly charged with salt. The Kissingen springs may be considered as typical of the drinking wells, and sea-water of bathing waters. The air of salt-works and pulverization of the water are employed in German baths as remedial agents.

Salt springs are found in many quarters of the world, but the chief carbonated groups for drinking purposes occur in Germany, and at Saratoga in America, where very remarkable wells indeed are to be found. France and England have no springs of this class. The stronger wells, used chiefly for bathing, occur where

TABLE IV.—Salt Springs.

	Locality.	Temp. ° Fahr.	Therapeutic Action.
Cold.	{Soden, near Frankfurt}	—	{Dyspepsia, anaemia, scrofula, special for throat and phthisis.
	Homburg, do.	—	{Dyspepsia, slighter hepatic affections, chlorosis, gout.
	{Kissingen, Bavaria Pyrmont, North Germany}	—	{In all essentials the same. Better known for its iron; has a good salt drinking spring.
	{Kreuznach, near Bingen}	—	{A salt well without carbonic acid; used in scrofula and anaemia; bathing more important.
	Wiesbaden, Nassau	155	{Used in dyspepsia and gout; the bathing is most import- ant.
	Baden-Baden	156	{Still milder water; uses simi- lar; gout.
Warm.	{Bourbonne, Haute-Marne}	114-149	{Rheumatism, neuralgia, effects of malaria.
	Balaruc, South France	116-6	{Do.; special for treatment of paralysis.
	{Salins, Moutiers, Savoy (1480 ft.)}	96	{Scrofula, anaemia, loss of power, sexual disorders.
	{Brides, Savoy (1700 ft.)}	95	{Act on liver and digestive canal; used for obesity.
	Aqui, North Italy	169	{Rheumatism; special treat- ment with the bath deposit.
	Abano, do	185	{Chiefly as baths; mud of bath used for sciatica.
	{Caldas de Mombuy, near Bar- celona}	153-158	{Rheumatism, sciatica, old in- juries.
	Cestona, Guipuz- coa, Spain	88-94	{Rheumatism, indigestion, bron- chitis.

Almost all the above stations have several springs of various strengths: the cold may be said to vary from 14 to 5.8% of chloride of sodium; the warm are generally weaker, perhaps varying from 6.8 to 1.6.

There are salt-bearing strata, as in Germany, Galicia, Italy, Switzerland, France and England. Very powerful waters of this class are those of St Catherines in Canada.

The presence of minute portions of iodine or bromine in salt waters is by no means infrequent, and they appear in considerable quantity in some few. It is, however, extremely doubtful whether any known spring contains a sufficient quantity of iodine, still more of bromine, to act specially on the system, even if that action were not necessarily superseded by the presence of the large quantity of

other salts with which they are associated. Some of the best-known springs of the kind are: Challes, Wildegg, Castrocario, Hall, Adelhaid's Quelle, Krakenheil, Kreuznach, Woodhall Spa.

Iron or Chalybeate Waters.—Iron usually exists in waters in the state of protoxide or its carbonate, less frequently as sulphate or crenate, and very rarely, if at all, as chloride. The quantity present is usually extremely small. It may be said to vary from 0.12 to 0.03 in the 1000 parts of water. Some wells considered distinct chalybeates contain less than 0.03. Many wells, especially in Germany, have a rich supply of carbonic acid, which is unfortunately wanting in French and English ones.

It has long been the prevalent idea that want of iron in the blood is the main cause of chlorosis and of other anaemic conditions, and that these conditions are best relieved by a supply of that metal. Since the detection of it in haemoglobin this view has been still more popular. It is pretty certain that the blood contains 37 to 47 grains and the whole system 70 to 74 grains of iron; and it has been calculated that in normal conditions of the system somewhat more than one grain of iron is taken daily in articles of food, and that the same amount is passed in the faeces; for although the stomach takes the iron up it is excreted by the alimentary canal mainly, it being doubtful whether any is excreted in the urine. It

TABLE V.—*Stronger Salt Waters.*

Locality.	Chloride of Sodium in 1000 parts of water.	Therapeutic Application.
Rheinfeld, Aargau, Switzerland	311	Scrofula, effects of inflammation, chronic exudations, some chronic exanthemas, rheumatism, uterine infiltrations.
Salzungen, North Germany	256	
Ischl, Austria (1440 ft.)	256	Do. do.
Hall, Tyrol (1700 ft.)	255	Do. do.
Reichenhall, near Salzburg (1800 ft.)	224	Do. do.
Bex, Rhone Valley (1400 ft.)	156	Do. do.
Castrocario, Tuscany	36	Do. do.
Droitwich, near Worcester	233.6	Do. do.
Sa Water.	30.4	
Rehme, Westphalia (92° F.)	24-85	Do.; special use in locomotor ataxia.
Naheim, Wetterau (80°-103° F.)	29	Do. do.

TABLE VI.—*Iron Waters.*

Locality.	Height in Ft.	Carb. of Iron.	Therapeutic Use.
Rippoldsau, Black Forest	1886	0.12	For anaemic conditions; laxative.
Homburg, near Frankfurt	—	0.10	
Elster, Saxony	1465	0.08	Do. do.
Liebenstein, North Germany	911	0.08	Do. do.
Schwalbach, Nassau	900	0.08	Do.; much of a ladies' bath.
Bocklet, near Kissingen	600	0.08	Do. do.
Griesbach, Black Forest	1614	0.07	Do.; laxative; a ladies' bath.
Franzensbad, Bohemia	1293	0.07	Do. do.
Pyrmont, Germany	—	0.07	Do. do.
Spa, Belgium	1000	0.06	Do.; laxative.
Petersthal, Black Forest	1333	0.04	Do.; sought for its air.
St. Moritz, Engadine, Switzerland	5464	0.03	Do. do.
Forges-les-Eaux, France	—	0.06	Do. do.
La Malou, Hérault, France (temp. 88°)	—	0.08	Do. do.
Recaro, North Italy	1943	0.04	Do. do.
Tunbridge Wells, England	—	0.06	Do.; deficient in carbonic acid.
Muspratt Spring, Harrogate (chloride)	600	0.15	

is possible by drinking several glasses to take in more than a grain of carbonate of iron in the day, equivalent to half that amount of metallic iron. It has further been ingeniously reckoned from practice that 10 to 15 grains of metallic iron suffice to supply the deficiency in the system in a case of chlorosis. It is thought probable that a portion of the iron taken up in water is in certain pathological states not excreted, but retained in the system, and goes towards making up the want of that metal. But whether this or

any other explanation be satisfactory, there is no question as to the excellent effects often produced by drinking chalybeate waters (especially when they are carbonated), and by bathing in those which are rich in carbonic acid after they have been artificially heated. As regards the drinking cure we must not, however, forget that carbonate and chloride of sodium, and also the sulphate, are often present and must be ascribed a share in the cure. Thus chloride of sodium is a powerful adjuvant in the strong Stahl Quelle of Homburg and in the Putnam Well at Saratoga. A whole category of female complaints is treated successfully with these waters. Indeed, anaemia from any source, as after fever or through loss of blood, and enlargements of the spleen, are benefited by them. The stimulating action of the copious supply of carbonic acid in steel baths is a very important adjuvant; no one now believes in direct absorption of iron from the bath. Iron waters are scarcely ever thermal. They are extremely common in all countries—frequently along with sulphuretted hydrogen in bogs and near coal-measures. But such springs and non-carbonated wells generally are weak, and not now held in much esteem.

It may be added that some of the strongest known iron wells are sulphated or aluminated. They are styptic and astringent, and can only be used diluted. They are sometimes useful as an application to ulcers and sores. Such springs have often been brought into notice, but never retain their popularity. They are known in the Isle of Wight, in Wales, in Scotland, as well as in Elba, &c.; and of late years the Bedford Alum and Oak Orchard Springs, U.S., have been brought into notice, the latter containing 10 grains of free sulphuric acid in the pint. All such springs have been considered useful in scrofula, anaemia and chronic diarrhoeas.

Sulphur Springs.—Waters having the odour of hydrosulphuric acid, however slightly, are usually called sulphur ones. They owe their smell sometimes to the presence of the free acid, sometimes to sulphides of sodium, calcium or magnesium, and sometimes to both. Sulphuretted hydrogen is absorbed more freely by cold than by hot water, and is therefore most abundant in cold springs. The sulphides decompose and give off the gas. Most of these springs occur near coal or shale measures, or strata containing fossils, or in moors and in places generally where organic matter is present in the soil or strata. Many of them contain so little mineral impregnation that they might as well be classed among the indifferent or earthy waters. One group contains a considerable amount of chloride of sodium, another of sulphate of lime, while a third has little mineral impregnation, but contains sulphides.

Sulphuretted hydrogen is a strong poison, and its action on the system has been pretty well ascertained. It has been assumed that the gas in mineral waters acts similarly, though in a modified degree; but there is next to nothing absolutely known of the action of the small quantities of the gas that are present in mineral waters, and which certainly have no toxic effect. It has been assumed that this gas has some special action on the portal system and so on the liver. On the connexion of metallic poisoning with the liver has been founded the idea that sulphur waters are useful in metallic intoxication. Drinking large quantities of these waters, especially of such as contain sulphates or chlorides of sodium or magnesium, combined with hot baths and exercise, may help to break up albuminates, but there is no proof of the action of the sulphur.

For similar reasons, and primarily to counteract mercurial poison, sulphur waters have been considered useful in syphilis. But it may be well to remember that at most baths mercury is used along with them. No doubt they are frequently, like other warm waters, useful in bringing out old eruptions, acting in this way as a test for syphilitic poison, and in indicating the treatment that may be applied.

TABLE VII.—*Cold Sulphur Springs.*

Locality.	Sulphuretted Hydrogen dissolved in Water.	Sulphide of Sodium.
Eilsen, Schaumburg-Lippe	42.3	—
Meinberg, Lippe-Detmold	23.1	—
Gurnigel, Switzerland (3600 ft.)	15.1	0.008
Leuk, do. (3593 ft.)	44.5	—
Challes, Savoy (900 ft.)	—	0.478
Enghien, near Paris	—	0.106
Uriage, Isère, France (1500 ft.)	7.34	—
Harrogate, England	—	0.207
Strathpeffer, Scotland	—	0.206
Lisdoonvarna, Clare, Ireland	—	0.026

required. Sulphur waters, both hot and cold, are used in gout and rheumatism in dyspepsia, in hepatic and cutaneous affections; and of late years inhalation of them has been popular in phthisis and in laryngeal affections. They have long been popular remedies in cutaneous affections. While so much doubt has been cast on the action of the sulphur of these waters, it may be admitted that the sulphides are probably decomposed in the stomach and sulphuretted hydrogen generated. That gas is probably a slight stimulant

Bourboulé, Mont Dore, Royat, Salies (Bigorres), Plombières, Baden-Baden.

Of late years *lithium* has been discovered in the waters of Baden-Baden; and various other places boast of the amount of that substance in their springs. Indeed a new bath has been established at Assmannshausen on the Rhine in consequence of the discovery of a weak alkaline spring containing some lithium. Not very much is known of the action of lithium in ordinary medicine, and it undoubtedly does not exist in medicinal doses even in the strongest

springs. Among these springs are those of Baden-Baden, Assmannshausen, Elster, Royat, Ballston Spa, and Saratoga (U.S.).

AMERICAN MINERAL WATERS.—The number of springs in the United States and Canada to which public attention has been called on account of their supposed therapeutic virtues is very large, amounting in all to more than three hundred. Of this number comparatively few are in Canada, and of these not more than six (St. Catharines, Caledonia, Lehigh, Caxton, Charlottesville and Sandwich) have attained general celebrity. The first three belong to the saline class, the Caxton is alkaline-saline, and the last two are sulphur waters. The St. Catharines is remarkable for the very large amounts of sodium, calcium and magnesium chlorides which it contains, its total salts (450 grains in the pint) being more than three times the quantity contained in the brine-baths of Kreuznach in Prussia. The Charlottesville and Sandwich springs likewise surpass the noted sulphur-waters of Europe in their excessive percentages of sulphuretted hydrogen, the former containing more than 3 and the latter 4.72 cub. in. of this gas in the pint.

The mineral springs in the United States are very unequally distributed, by far the larger number of those which are in high medical repute occurring along the Appalachian chain of mountains, and more especially on or near this chain where it passes through the States of Virginia, West Virginia and New York. The Devonian and Silurian formations which overlie the Eozoic rocks along the course of the Appalachian chain have been greatly fissured—the faulting of the strata being in some places of enormous magnitude—by the series of upheavals which gave rise to the many parallel mountain ridges of the Appalachians. In many places the springs occur directly along the lines of fault. The two classes of mineral waters are likewise very unequally represented, the alkaline springs, and those containing Glauber and Epsom salts, being much inferior to their European representatives. On the other hand, the very numerous and abundant springs of Saratoga compare very favourably with the Selters and similar saline waters, and among the many American chalybeate springs the subclass represented by the Rockbridge Alum is unequalled in regard to the very large percentages of alumina and sulphuric acid which it contains. Besides its greater amount of mineral constituents (135 grains per pint) the Ballston spring surpasses the similar saline waters of Homburg, Kissingen, Wiesbaden and Selters, in its percentage of carbonic acid (53 cub. in.). It is also remarkable for the very large proportion of carbonate of lithia, amounting to 0.701 grains. Thermal springs are specially numerous in the territories west of the Mississippi and in California. Those in the east mostly occur in Virginia along the southern portion of the Appalachian chain; in the middle and New England States Lebanon is the only important thermal spring. Subjoined is a list of thirty American springs, the design being to represent as many of the more noted spas as possible, while, at the same time, enumerating at the best representatives of the classes and subclasses into which mineral waters are divided according to the German method of classification.

BIBLIOGRAPHY.—(1) German: E. Osann, *Darstellung der Heilquellen Europas* (3 vols., Berlin, 1839-1843); J. Seegen, *Handbuch der Heilquellenlehre* (Vienna, 1862); B. M. Lersch, *Hydrochemie* (1870), and many other works; Helfft, *Handbuch d. Balneotheorie* (8th ed., Berlin, 1874); Valentiner, *Handbuch d. Balneotheorie* (Berlin, 1876); L. Lehmann, *Bäder u. Brunnen Lehre* (Bonn, 1877); J. Braun, *System, Lehrbuch d. Balneotheorie*, 4th ed., by Fromm (Berlin, 1880); Leichter, *Handbuch d. Balneotheorie*, 1880. (2) French: *Dictionnaire des eaux minérales*, &c., by MM. Durand-Fardel, &c. (2 vols., Paris, 1860); J. Lefort, *Traité de chimie hydrologique* (2nd ed., Paris, 1873); C. James, *Guide pratique aux eaux minérales* (Paris), many editions; Macé, *Guide aux villes d'eaux*, &c. (Paris, 1881); Joanne and Le Pileur, *Les Bains d'Europe* (Paris). (3) Swiss: Meyer Ahrens, *Heilquellen der Schweiz* (Zürich, 1867); Gsell Fels, *Die Bäder und Kurorte der Schweiz* (Zürich, 1880). (4) Italian: G. Jervis, *Guida alle acque minerali d'Italia* (Turin, 1876, &c.); E. F. Harless, *Die Heilquellen und Kurbäder Italiens* (Berlin, 1848). (5) Spanish: Ruiz, *Tratado de las fuentes minerales de España* (Madrid, 1853); Don J. de Antea, Sanchez has recently published a work on Spanish waters. (6) English: T. Short, *History of the Mineral Waters* (London, 1734); J. Rutty, *Methodical Synopsis of Mineral Waters* (London, 1757); Granville, *Spas of England* (1841); E. Lee, *Mineral Springs of England* (London, 1841); J. Macpherson, *Our Baths and Wells* (1871); id., *Baths and Wells of Europe* (1873); and H. Weber's Eng. ed. of Braun (London, 1875). A great portion of the literature is to be found in monographs on particular places. (7) American: J. Bell, *The Mineral and Thermal Springs of the United States and Canada* (1855); J. I. McCormick, *The Mineral Waters of the United States and Canada* (1867); C. F. Chandler, *Lecture on Water* (1871); G. E. Walton, *The Mineral Springs of the United States and Canada* (1875); I. Burney Yeo, *The Therapeutics of Mineral Springs* (1904).

MINERVA, an Italian goddess, subsequently identified with Athena. She presided over all handicrafts, inventions, arts and sciences. Her oldest sanctuary at Rome was in the temple built by Tarquin on the Capitol, where she was worshipped with Jupiter and Juno. She had also a temple on the Aventine,

	Designation and Locality.	Therapeutic Application.
Indifferent (Thermal).	Lebanon, Columbia co., N.Y. (73° F.)	Scrofulous ulcers and ophthalmia, ozoena, chronic diarrhoea and dysentery, secondary and tertiary syphilis.
	Healing, Bath co., Va. (88° F.)	Chronic and subacute rheumatism, gout, neuralgia, nephritic and calculous diseases.
	Warm, Bath co., Va. (98° F.)	Chronic rheumatism, gout, diseases of liver, neuralgia, contractions of joints.
	Hot, Bath co., Va. (110° F.)	Dartrous diseases of skin, functional diseases of uterus, chronic mercurial and lead poisoning.
	Paso Robles, San Luis Obispo co., Cal. (122° F.)	Calculus, gravel, catarrh of stomach or bladder, dyspepsia.
	Hot, Garland co., Ark. (93-150° F.)	Gravel, dyspepsia (diuretic, diaphoretic).
Calcareous and Earthy.	Gettysburg, Adams co., Penn.	Neuralgia (restorative).
	Sweet, Monroe co., W. Va. (74° F.)	Purgative, diuretic.
	Berkeley, Morgan co., W. Va. (74° F.)	Diabetes mellitus, gravel, inflammation of bladder, dropsy, albuminuria (diuretic).
	Alleghany, Montgomery co., Va.	Aperient and alterative.
Sulphur.	Lower Blue Lick, Nicholas co., Ky.	Do. do.
	Sharon, Schoharie co., N.Y.	Dartrous skin diseases, diseases of the bladder, jaundice, dyspepsia.
	White Sulphur, Greenbrier co., Va.	Do.; scrofula and syphilis.
Epsom Salt.	Salt Sulphur, Monroe co., W. Va.	Anaemia, gravel, calculus (strongly diuretic).
	Bedford, Bedford co., Penn.	Rheumatism, gout, scrofula, neuralgia.
	St Catharines, Ontario, Canada	Rheumatism, gout.
Common Salt.	Caledonia, Ontario, Canada	Dyspepsia, jaundice, abdominal plethora.
	Hathorne, Saratoga, N. Y.	Do. do. do.
	Ballston, Saratoga co., N. Y.	Ulcers, diseases of the skin, passive haemorrhages, atonic diarrhoea (has 10 grains of free sulphuric acid in the pint).
Iron.	Oak-Orchard Acid, Genesee co., N. Y.	Chlorosis and anaemia generally; tonic.
	Rawley, Rockingham co., Va.	Do. do. do.
	Sweet Chalybeate, Alleghany co., Va.	Scrofula, chronic diarrhoea.
Glauber Salt.	Rockbridge Alum, Rockbridge co., Va.	Anaemia, chlorosis, chronic diarrhoea, dropsy.
	Cooper's Well, Hinds co., Miss.	
	Crab Orchard, Lincoln co., Ky. Midland, Midland co., Mich.	
Alkaline.	Bladen, Choctaw co., Ala. (carbonated alkaline)	
	Congress, Santa Clara co., Cal. (saline-alkaline)	
	St Louis, Gratiot co., Mich. (simple alkaline)	Dyspepsia, neuralgia, chronic and subacute rheumatism.

which was the meeting-place for dramatic poets and actors, whose organization into guilds under her patronage dated from the time of Livius Andronicus (*q.v.*). The dedication day of the temple was the 19th of March, the great festival of Minerva, called *quinquatrus*, because it fell on the fifth day after the ides. All the schools had holidays at this time, and the pupils on reassembling brought a fee (*minerva*) to the teachers. In every house also the *quinquatrus* was a holiday, for Minerva (like Athena Ergane) was patron of the women's weaving and spinning and the workmen's craft. At a later time the festival extended over five days, the last four being chiefly occupied with gladiatorial shows—because Minerva was the goddess of war (Ovid, *Fasti*, iii. 809–834; Juvenal x. 115, with Mayor's note). The erection of a temple to her by Pompey out of the spoils of his eastern conquests shows that she was the bestower of victory, like Athena Niké, and the dedication of a vestibule in the senate house by Augustus recalls Athena the goddess of counsel (*Θοῦλαία*). Under Domitian, who claimed her special protection, the worship of Minerva attained its greatest vogue in Rome. The emperor Hadrian founded an educational institution, named after her the *Athenaeum*. The 23rd of March had always been the day of the *tubistrium*, or purification of the trumpets used in the sacred rites, so that the ceremony came to be on the last day of Minerva's festival, but it is very doubtful whether it was really connected with her. There was another temple of Minerva on the Caelian Hill, where she was worshipped under the name of *Capta*, the "captive," the origin of which is unknown. Here a festival called the lesser *quinquatrus* was celebrated on the 13th–14th of June, chiefly by the flute-players (Livy ix. 30; Ovid, *Fasti*, vi. 651). As the Romans learnt the use of the flute from the Etruscans, the fact of Minerva being the patron goddess of flute-players is in favour of her Etruscan origin, although it may merely be a reminiscence of the Greek story which attributed the invention of the flute to Athena. A carved image of the goddess called the *Palladium*, said to have been brought from Troy to Lavinium, and thence to Rome by the family of the *Nautii*, was kept in the temple of *Vesta* and carefully guarded as necessary to the prosperity of the city. The older form of the name *Minerva* is *Menerva* (= *Menes-va*, Gr. *μῆνος*); it probably means "thinker."

MINGHETTI, MARCO (1818–1886), Italian economist and statesman, was born at Bologna on the 18th of November 1818. In 1846 he signed the petition to the Conclave for the election of a Liberal pope, and was appointed member of the state council summoned to prepare the constitution for the papal states. With Antonio Montanari and Rodolfo Audinot he founded at Bologna a paper, *Il Felsineo*. In the first constitutional cabinet, presided over by Cardinal Antonelli, Minghetti held the portfolio of public works, but after the allocation by Pius IX. against the Italian war of independence he resigned, and joined the Piedmontese army as captain on the general staff. Returning to Rome in September 1848, he refused to form a cabinet after the assassination of Pellegrino Rossi, and spent the next eight years in study and travel. Summoned to Paris by Cavour in 1856 to prepare the memorandum on the Romagna provinces for the Paris congress, he was in 1859 appointed by Cavour secretary-general of the Piedmontese Foreign Office. In the same year he was elected president of the assembly of the Romagna after the rejection of pontifical rule by those provinces, and prepared their annexation to Piedmont. Appointed Piedmontese minister of the interior, he resigned office shortly after Cavour's death, but was subsequently chosen to be minister of finance by Farini, whom he succeeded as premier in 1863. With the help of Visconti-Venosta he concluded (Sept. 15, 1864) the "September Convention" with France, whereby Napoleon agreed to evacuate Rome, and Italy to transfer her capital from Turin to Florence. The convention excited violent opposition at Turin, in consequence of which Minghetti was obliged to resign office. He took little part in public life until 1869, when he accepted the portfolio of agriculture in the Menabrea Cabinet. Both in and out of office he exercised his influence against an Italo-French alliance and for an immediate

advance upon Rome, and in 1870 was sent to London and Vienna by the Lanza-Sella Cabinet to organize a league of neutral powers on the outbreak of the Franco-Prussian War. In 1873 he overthrew the Lanza-Sella Cabinet and regained the premiership, which, with the portfolio of finance, he held until the fall of the Right from power on the 18th of March 1876. During his premiership he inaugurated the *rapprochement* between Italy, Austria and Germany, and reformed the naval and military administration; and before his fall he was able, as finance minister, to announce the restoration of equilibrium between expenditure and revenue for the first time since 1860. After the advent of the Left, Minghetti remained for some years in Opposition, but towards 1884 joined Depretis in creating the "Trasformismo," which consisted in bringing Conservative support to Liberal cabinets. Minghetti, however, drew from it no personal advantage, and died at Rome on the 10th of December 1886 without having returned to power.

His writings include: *Della economia pubblica e delle sue attinenze con la morale e col diritto* (Bologna, 1859), and *La Chiesa e lo Stato* (Milan, 1878).

MINGRELIA, a former principality of Transcaucasia, which became subject to Russia in 1804, and since 1867 has belonged to the government of Kutais. The country corresponds to the ancient Colchis; and Sukhum Kaleh on the Black Sea coast, which was the capital under the Dadian dynasty (1323–1604), is to be identified with the ancient Dioscurias, a colony of Miletus. The Mingrelians, who are closely akin to the Georgians, numbered 241,000 in 1902, and belong to the Orthodox Greek Church (see further KUTAIS and CAUCASIA).

MINIATURE. The word "miniature," derived from the Latin *minium*, red lead, has been technically employed, in the first instance, to describe a picture in an ancient or medieval manuscript; the simple decoration of the early codices having been "miniated" or delineated with that pigment. The generally small scale of the medieval pictures has led secondly to a pseudo-etymological confusion of the term with "minuteness" and to its application to "paintings in little"; it is now used mainly in this sense, and is ordinarily applied to a painting on a very small scale, usually a portrait, and by analogy to anything on a very small scale.

1. *Miniatures in Ancient and Medieval MSS.*—The part played by the miniature in the scheme of the ornamentation of MSS., in the early centuries of the Christian era and in the middle ages, is dealt with in the article on ILLUMINATED MSS. In the present article will be discussed the development and changes which it underwent, in different ages and in different countries, both in its technical treatment and in its leading characteristics. The subject divides itself into two distinct portions, the classical and the medieval, between which there lies the great separating space of the early middle ages, which affords but scanty material to connect them. When, however, we have advanced into the middle ages, we are no longer at a loss; and we can follow the later development of the miniature through all its changes in the various schools of western Europe down to its transition into the modern picture.

The importance of the study of the miniature has perhaps hardly received in the past the recognition which it merits. The history of painting cannot be perfectly understood without a knowledge of the rise and progress of the art of miniature-painting in MSS.; and examples of the art still survive in an abundance which frescoes and paintings in the large cannot rival. Modern methods of photography have brought within the reach of the student material which in earlier generations was not accessible; and consequently a juster conception can be formed of the position which the miniature holds in the history of art than was possible before.

The earliest examples that have descended to us are closely connected in style and treatment with the pictorial art of the later Roman classical period. In fact they are separated from that period by only two or three centuries, and they still follow its traditions. The oldest specimens of all are the series of coloured drawings or miniatures cut from an illustrated MS.

of the *Iliad* and now in the Ambrosian Library at Milan, which there is good reason for placing as early as the 3rd century. In these pictures there is a considerable variety in the quality of the drawing, but there are many notable instances of fine figure-drawing, quite classical in sentiment, showing that the earlier art still exercised its influence. Such indications, too, of landscape as are to be found are of the classical type, not conventional in the sense of medieval conventionalism, but still attempting to follow nature, even if in an imperfect fashion; just as in the Pompeian and other frescoes of the Roman age.

Of even greater value from an artistic point of view are the miniatures of the Vatican MS. of Virgil, known as the "Schedae Vaticanae," of the 4th century. They are in a more perfect condition and on a larger scale than the Ambrosian fragments, and they therefore offer better opportunity for examining method and technique. The drawing is quite classical in style, and the idea is conveyed that the miniatures are direct copies from an older series. The colours are opaque; indeed, in all the miniatures of early MSS. the employment of body colour was universal. The method followed in placing the different scenes on the page is highly instructive of the practice followed, as we may presume, by the artists of the early centuries. It seems that the background of the scene was first painted in full, covering the whole surface of the page; then, over this background were painted the larger figures and objects; and over these again the smaller details in front of them were superimposed. Again, for the purpose of securing something like perspective, an arrangement of horizontal zones was adopted, the upper ones containing figures on a smaller scale than those below.

It was reserved for the Byzantine school to break away more decidedly from the natural presentment of things and to develop convention. Yet in the best early examples of this school the classical sentiment still lingers, as the relics of the miniatures of the Cottonian Genesis, in the British Museum, and the best of the miniatures of the Vienna Dioscorides testify; and in the miniatures of the later Byzantine MSS., which were copied from earlier examples, the reproduction of the models is faithful. But on comparing the miniatures of the Byzantine school generally with their classical predecessors, one has a sense of having passed from the open air into the cloister. Under the restraint of ecclesiastical domination Byzantine art became more and more stereotyped and conventional. The tendency grows to paint the flesh-tints in swarthy hues, to elongate and emaciate the limbs, and to stiffen the gait. Browns, blue-greys and neutral tints are in favour. Here we first find the technical treatment of flesh-painting which afterwards became the special practice of Italian miniaturists, namely the laying on of the actual flesh-tints over a ground of olive, green or other dark hue. Landscape, such as it was, soon became quite conventional, setting the example for that remarkable absence of the true representation of nature which is such a striking attribute of the miniatures of the middle ages.

And yet, while the ascetic treatment of the miniatures obtained so strongly in Byzantine art, at the same time the Oriental sense of splendour shows itself in the brilliancy of much of the colouring and in the lavish employment of gold. In the miniatures of Byzantine MSS. are first seen those backgrounds of bright gold which afterwards appear in such profusion in the productions of every western school of painting.

The influence of Byzantine art on that of medieval Italy is obvious. The early mosaics in the churches of Italy, such as those at Ravenna and Venice, also afford examples of the dominating Byzantine influence. But the early middle ages provide but few landmarks to guide the student; and it is only when he emerges into the 12th century, with its frescoes and miniatures still bearing the impress of the Byzantine tradition, that he can be satisfied that the connexion has always existed during the intervening centuries.

When we turn to the farther-west of Europe, there also we find under the Carolingian monarchs a school of painting obviously derived from classical models, chiefly of the Byzantine type, but whether derived directly from the East, or, what is

more probable, transmitted through Italian channels, must remain doubtful. The interest of that school for our present purpose is that it was the parent of the later miniature-painting in the countries of the West. For in the native schools of those countries decoration only was the leading motive. In the MSS. of the Merovingian period, in the school which connected Frankland and northern Italy, and which is known as Lombardic or Franco-Lombardic, in the MSS. of Spain, in the productions of the Celtic school of our own islands, figure-drawing was scarcely known, and where it was practised it was of a barbarous character, serving rather as a feature of decoration than as a representation of the human form. Hence in those native schools the miniature, in its true sense of a picture, may be regarded as non-existent.

From these native schools we exclude the Anglo-Saxon school, developed especially at Canterbury and Winchester, which probably derived its characteristic free-hand drawing from classical Roman models, scarcely influenced by the Byzantine element. The highest qualities of the miniatures of the 10th and 11th centuries of this school lie in fine outline drawing, which had a lasting influence on the English miniature of the later centuries. But the southern Anglo-Saxon school rather stands apart from the general line of development of the western medieval miniature. How far it was affected by Continental influence will be presently noticed.

Turning to the productions of the Carolingian school, which owed its origin to the encouragement of Charlemagne, it is seen that the miniature appears in two forms. First, there is the truly conventional miniature following the Byzantine model, the subjects being generally the portraits of the Evangelists, or portraits of the emperors themselves: the figures stiff and formal; the pages brilliantly and often coarsely coloured and gilded, generally set in architectural surroundings of a fixed type, and devoid of landscape in the real sense of the word. On the other hand, there is also the miniature in which there is an attempt at illustration, as, for example, the depicting of scenes from Bible history. Here there is more freedom; and we trace the debased classical style which copies Roman, as distinguished from Byzantine, models. The figure-drawing is sufficiently clumsy, but the type is Roman, or debased Roman, and the costumes are clearly derived from the same source. Here, too, there is a better attempt at landscape, which is not of the absolutely conventional deadness of the Carolingian-Byzantine type. But this second style of illustrative miniature appears only occasionally. The other was the characteristic miniature of the Carolingian school, and, accompanied as it was with profuse decoration in border and initial, it set the pattern for the later Continental schools of the West.

The influence which the Carolingian school exercised on the miniatures of the southern Anglo-Saxon artists shows itself in the extended use of body-colour and in the more elaborate employment of gold in the decoration. Such a MS. as the Benedictinal of Aethelwold, bishop of Winchester, 963 to 984, with its series of miniatures drawn in the native style but painted in opaque pigments, exhibits the influence of the foreign art. But the actual drawing remained essentially national, marked by its own treatment of the human figure and by the peculiar disposition of the drapery with fluttering folds. Its fault was over-refinement, tending to an affected exaggeration and disproportion of the limbs. With the Norman Conquest this remarkable native school passed away.

The period immediately succeeding the Carolingian school in western Europe was one of extreme decadence in the miniatures of MSS. In the 10th and 11th centuries they were mere lifeless copies of earlier types. But with the awakening of art in the 12th century the decoration of MSS. received a powerful impulse. Although the artist of the time excels in the border and the initial, still in the miniature also there is vigorous drawing, with bold sweeping lines and careful study of the draperies. The artist now grows more practised in figure-drawing, and while there is still the tendency to repeat the same subjects in the same conventional manner, individual effort

produced in this century many miniatures of a very noble character. The Norman Conquest had brought England directly within the fold of Continental art; and now began that grouping of the French and the English and the Flemish schools, which, fostered by growing intercourse and moved by common impulses, resulted in the magnificent productions of the illuminators of north-western Europe from the latter part of the 12th century onwards. But of natural landscape there is nothing, unless rocks and trees of a stereotyped character can be so regarded. Hence the background of the miniature of the 12th and immediately succeeding centuries became the field for decoration to throw into stronger relief the figures in the scene. And thus arose the practice of filling in the entire space with a sheet of gold, often burnished: a brilliant method of ornament which we have already seen practised in the Byzantine school. We have also to notice the conventional treatment of the sacred figures, which continue henceforward, from a sense of veneration, to be clad in the traditional robes of the early centuries, while the other figures of the scene wear the ordinary dress of the period.

It will be convenient, at this point, to follow the development of the miniature in the northern schools of England and France and the Low Countries, occasionally glancing at Germany, during the next three centuries, and to leave aside for the moment consideration of the Italian school and the schools allied therewith.

Entering the 13th century, we reach the period when the miniature may be said to justify the modern false etymology which has connected the title with minuteness. The broad, bold style of the 12th century gives place to the precise and minute. Books in general exchanged their form from the large folio to the octavo and smaller sizes. There was a greater demand for books; and vellum was limited in quantity and had to go further. The handwriting grew smaller and lost the roundness of the 12th century. Contractions and abbreviations in the texts largely increased in number. Everywhere there is an effort to save space. And so with the miniature. Figures were small, with delicate strokes in the features and with neat slim bodies and limbs. The backgrounds blaze with colour and burnished gold; and delicate diaper patterns of alternate gold and colour abound. Frequently, and especially in English MSS., the drawings are merely tinted or washed with transparent colours. In this century, too, the miniature invades the initial. Whereas in the earlier periods bold flowering scrolls are the fashion, now a little scene is introduced into the blank spaces of the letter. To compare the work of the three schools, the drawing of the English miniature, at its best, is perhaps the most graceful; the French is the neatest and the most accurate; the Flemish, including that of western Germany, is less refined and in harder and stronger lines. As to colours, the English artist affects rather lighter tints than those of the other schools: a partiality is to be observed for light green, for grey-blue, and for lake. The French artist loved deeper shades, especially ultramarine. The Fleming and the German painted, as a rule, in less pure colours and inclined to heaviness. A noticeable feature in French MSS. is the red or copper-hued gold used in their illuminations, in strong contrast to the paler metal of England and the Low Countries.

It is remarkable how the art of the miniature throughout the 13th century maintains its high quality both in drawing and colour without any very striking change. Throughout the century the Bible and the Psalter were in favour, and naturally the same subjects and the same scenes ran through the period and were repeated by artist after artist; and the very character of those sacred books would tend to restrain innovation. But towards the close of the period such secular works as the romances were growing in popularity, and afforded a wider field for the invention of the illustrating artist. Therefore with the opening of the 14th century a palpable change of style supervenes. We pass to more flowing lines; not to the bold sweeping strokes and curves of the 12th century, but to a graceful, delicate, yielding style which produced the beautiful swaying figures

of the period. In fact the miniature now begins to free itself from the rôle of an integral member of the decorative scheme of illumination and to develop into the picture, depending on its own artistic merit for the position it is to hold in the future. This is shown by the more prominent place that the miniature now assumes, and by its growing independence of the decorative border and initial. But, at the same time, while the miniature of the 14th century thus strives to dissociate itself from the rest of the illuminated details of the MS., within itself it flourishes in decoration. Besides the greater elasticity of the figure-drawing, there is a parallel development in the designs of the backgrounds. The diapers become more elaborate and more brilliant; the beauty of the burnished gold is enhanced by the stippled patterns which are frequently worked upon it; the gothic canopies and other architectural features which it became the practice to introduce naturally followed the development of the architecture of the period. In a word, the great expansion of artistic sentiment in decoration of the best type, which is so prominent in the higher work of the 14th century, is equally conspicuous in the illuminated miniature.

In the early part of the century, English drawing is very graceful, the figures bending with a waving movement which, if they were not so simple, would be an affectation. Both in the outline specimens, washed with transparent colour, and in the fully painted examples, the best English work of this time is unsurpassed. French art still maintains its neat precision, the colours more vivid than those of England and the faces delicately indicated without much modelling. The productions of the Low Countries, still keeping to the heavier style of drawing, appear coarse beside the works of the other schools. Nor does German miniature art of this period hold a high position, being generally mechanical and of a rustic character. As time advances the French miniature almost monopolizes the field, excelling in brilliancy of colouring, but losing much of its purity of drawing although the general standard still remains high. The English school gradually retrogrades and, owing no doubt to political causes and to the wars with France, appears to have produced no work of much value. It is only towards the end of the century that there is a revival.

This revival, which is referred to in the article on ILLUMINATED MSS., has been attributed, with some reason, to a connexion with the flourishing school of Prague—a school which in the scheme of colouring suggests a southern influence—following on the marriage of Richard II. with Anne of Bohemia in 1382. The new style of English miniature painting is distinguished by richness of colour, and by the careful modelling of the faces, which compares favourably with the slighter treatment by the contemporary French artists. Similar attention to the features also marks the northern Flemish or Dutch school at this period and in the early 15th century; and it may therefore be regarded as an attribute of Germanic art as distinguished from the French style. The promise of the new development in English miniature painting, however, was not to be fulfilled. In the first quarter of the 15th century, examples of great merit were produced, but at a standstill in drawing and fettered by medieval convention. The native art practically came to a close about the middle of the century, just when the better appreciation of nature was breaking down the old conventional representation of landscape in European art, and was transforming the miniature into the modern picture. Whatever miniature painting was to be produced in England after that time was to be the work of foreign artists or of artists imitating a foreign style. The condition of the country during the Wars of the Roses sufficiently accounts for the abandonment of art. Thus the history of the miniature in the 15th century must be sought in the manuscripts of the Continental schools.

First we have to consider northern France and the Low Countries. As it passes out of the 14th and enters the 15th century, the miniature of both schools begins to exhibit greater freedom in composition; and there is a further tendency to aim rather at general effect by the colouring than neatness in drawing. This was encouraged by the wider field opened to

the miniaturist. Books of all kinds were illustrated, and sacred books, Bibles and Psalters and liturgical books, were no longer the chief, if not the only, MSS. which were illuminated. And yet there was one class of MSS. which came into the greatest prominence and which was at the same time liturgical. This was the *Horae*, or Hours of the Virgin, &c., devotional books for individual use, which were multiplied in vast numbers and contained some of the finest work of the miniaturists. The decoration of these little volumes escaped in great measure from the conventional restraints which their religious character might have imposed. Furthermore, the demand for illuminated MSS. had by this time established a regular trade; and their production was not confined, as formerly, to the cloister with its narrow and limited views.

Early in the century the old conventional treatment of landscape still held its own; nor did the diapered and gilded background pass out of use. Indeed, in some of the finest French specimens of the time the diapered patterns are more brilliant than ever. But natural scenery in the second quarter of the century asserts itself more decidedly, although with faults in perspective. It was not until another generation had arisen that there was a true appreciation of the horizon and of atmospheric effect.

The miniatures of the French and Flemish schools run fairly parallel for a time, but after the middle of the century national characteristics become more marked and divergent. The French miniature began to deteriorate, though some very fine examples were produced by the more gifted artists of the school. The figure-drawing was more careless, and the painting tended to hardness without depth, which the artist endeavoured to relieve by an excess of gilt shading. The close of the century brought with it the end of the French miniature; for the extravagant productions of the 16th century cannot be counted as worthy of consideration.

The French miniature went down before the Flemish school, which in the latter part of the 15th century attained to its highest excellence. The Flemish miniature affected extreme softness and depth of colour; also an ever-increasing carefulness in the treatment of details, of the draperies, of the expression of the features: the Flemish type of the Virgin's face, for example, with its full, high forehead, can never be mistaken. In the best Flemish miniatures of the period the artist succeeds in presenting a wonderful softness and glow of colour; nor did the high standard cease with the 15th century, for many excellent specimens still remain to attest the favour in which it was held for a few decades longer.

In the foregoing remarks what has been said in regard to the careful treatment of details applies still more to the miniatures executed in *grisaille*, in which the absence of colour invited an even stronger accentuation of that treatment. This is perhaps most observable in the *grisaille* miniatures of northern Flanders, which often suggest, particularly in the strong angular lines of the draperies, a connexion with the art of the wood-engraver.

The Flemish miniature did not, however, hold the favour of western Europe without a rival. That rival had arisen in the south, and had come to perfection concurrently with the miniature of the Low Countries in the 15th century. This was the Italian miniature; and the history of its development now claims a brief notice. We return to the 13th century, where we suspended examination of the work of the school of the miniature painters of Italy; but we are not in a position, from lack of material, to follow so closely the development of the Italian miniature. Yet there is enough to show that it passed through the same stages as the miniatures of England and France and the Low Countries. Intercommunication between the countries of Europe was too well established for the case to be otherwise. In Italian MSS. of the normal type the influence of Byzantine art is very manifest during the 13th and 14th centuries. The old system of painting the flesh tints upon olive green or some similar pigment, which is left exposed on the lines of the features, thus obtaining a swarthy complexion,

continued to be practised in a more or less modified form into the 15th century. As a rule, the pigments used are more opaque than those employed in the northern schools; and the artist trusted more to colour alone to obtain the desired effect than to the mixture of colour and gold which gave such brilliant results in the diapered patterns of France. The vivid scarlet of the Italian miniaturists is peculiarly their own. The figure-drawing does not bear comparison with the contemporary art of English and French MSS., the human form being often stunted and thick-set. In general, the Italian miniature, before its great expansion in the 14th century, is far behind the miniatures of the north. But with the 15th century, under the influence of the Renaissance, it advanced into the front rank and rivalled the best work of the Flemish school. The use of thicker pigments enabled the miniaturist to obtain the hard and polished surface so characteristic of his work, and to maintain sharpness of outline, without losing the depth and richness of colour which compare with the same qualities in the Flemish school.

The Italian style was followed in the MSS. of Provence in the 14th and 15th centuries. It had its effect, too, on the school of northern France, by which it was also influenced in turn. In the MSS. of southern Germany it is also in evidence. But the principles which have been reviewed as guiding the development of the miniature in the more important schools apply equally to all. Like the miniature of the Flemish school, the Italian miniature was still worked to some extent with success, under special patronage, even in the 16th century; but with the rapid displacement of the manuscript by the printed book the miniaturist's occupation was brought to a close.

For Authorities see under ILLUMINATED MSS. (E. M. T.)

2. *Miniatures as separate Small Pictures*.—In Europe the later development of the miniature, applied almost exclusively to portraits, is to a large extent English, and the greater number of the chief masters in the art have been Englishmen or have lived in England. Several great portrait painters are said to have worked occasionally in miniature, and there are paintings, small in size attributed with good reason to Holbein, Antonio Moro, John Shute, Clef, Stretes, Teerlinck, Zucchero, John and T. Betts, and with less probability even to Van Dyck. There is a fine signed work by Shute (see *Lomazzo's Trattato dell' arte della pittura*, trans. Heydock, 1598) in the Pierpont Morgan collection; examples by Betts at Montagu House and Madresfield Court, and portraits, by Lavina Teerlinck in the collections of Mr George Salting and Mr J. Pierpont Morgan.

The first portrait miniaturist about whom anything definite is known was Nicholas Hilliard (c. 1547-1610), whose work partakes of the characteristics of illuminated manuscripts. The colours are opaque; gold is used to heighten the effect; while the paintings are on card. They are often signed, and have frequently also a Latin motto upon them. It has recently been proved that Hilliard worked for a while in France, and he is probably identical with the painter alluded to in 1577 as "Nicholas Belliard." Nicholas Hilliard was succeeded by his son Lawrence (d. 1640), some works by whom are in the Pierpont Morgan and Madresfield Court collections. His technique was similar to that of his father, but bolder, and his miniatures richer in colour. Isaac and Peter Oliver succeeded Hilliard. Isaac (c. 1567-1617) is said to have been the pupil of Hilliard and Zucchero. Peter (1594-1647) was the pupil of Isaac. The two men were the earliest to give roundness and form to the faces they painted. They signed their best works in monogram, and painted not only very small miniatures, but larger ones measuring as much as 10 in. by 9 in. They copied for Charles I. on a small scale many of his famous pictures by the old masters. Several of these copies are at Windsor and at Montagu House. At about the same date Gerbier, Poelemberg, Jamesone, Penelope Cleyn and her brothers, were workers in the art. John Hoskins (d. 1664) was the master of Samuel Cooper, the greatest English miniaturist. The work of Cooper can best be studied in the collection at Ham House. He was followed by a son of the same name, who was known to have been living in 1700, since a miniature signed by him and bearing that date is in the Pierpont



Collection of Mr J. Pierpont Morgan

FIG. 1.—MRS PEMBERTON.
By HOLBEIN.



Collection of the Duke of
Portland, K.G.

FIG. 2.—A YOUNG MAN
IN DEEP MOURN-
ING (1616). By
NICOLAS HILLIARD.



Collection of Wingham Digby, Esq.

FIG. 3.—LADY LUCY STANLEY.
By ISAAC OLIVER.



Collection of the Duke of
Buckingham and
Ormonde, K.G.

FIG. 4.—OLIVER CROMWELL
(unfinished). By SAMUEL COOPER.



Collection of H.M. the King.

FIG. 5.—SIR PHILIP SIDNEY. By ISAAC OLIVER.



Collection of the Duke of Portland, K.G.

FIG. 6.—COL. HENRY SIDNEY
(1665). By SAMUEL COOPER.



Collection of the Duke of
Portland, K.G.

FIG. 7.—INIGO JONES. By
DAVID DES GRANGES.



Collection of the Marquis of Exeter.

FIG. 8.—CHARLES II. AS A
BOY. By JOHN HOSKINS.



Collection of the Duke of Portland, K.G.

FIG. 9.—"MR SYMPSON, MASTER
OF MUSICK." By THOMAS
FLATMAN.

MINIATURES



FIG. 1.—BERNARD LENS.
By himself, 1718.

Collection of the Duke of Portland. K.G.



FIG. 2.—SIR CHARLES OAKELEY. By JOHN SMART.



FIG. 3.—UNKNOWN LADY (1781). By JOHN SMART.



FIG. 4.—MRS. PARSONS.
By RICHARD COSWAY, R.A.



FIG. 5.—MISS FREE. By ANDREW PLIMER.



FIG. 6.—MISS MARY BERRY.
By GEORGE ENGLEHEART.



Collection of Mr E. M. Hodgkins
FIG. 7.—KITTY FISHER.
By OZIAS HUMPHRY.



FIG. 8.—A BOY.
By J. H. FEAGONARD.



FIG. 9.—LADY. By HORACE HONE.

Marshall Hall Collection.



Collection of the King of Sweden
FIG. 10.—THE COUNTESS D'EGMONT.
By P. A. HALL.

Morgan collection. It represents the duke of Berwick. Samuel Cooper (1609-1672) was a nephew of Hoskins. He spent much of his time in Paris and Holland, and very little is known of his career. His work has a superb breadth and dignity, and has been well called "life-size work in little." His portraits of the men of the Puritan epoch are remarkable for their truth to life and strength of handling. He painted upon card, chicken skin and vellum, and on two occasions upon thin pieces of mutton bone. The use of ivory was not introduced until long after his time. His work is frequently signed with his initials, generally in gold, and very often with the addition of the date. Flatman (d. 1688); Alexander Cooper (d. 1660), who painted a series of portraits of the children of the king and queen of Bohemia, now belonging to the German emperor, and several of whose best miniatures are in the collections of the queen of Holland and the king of Sweden; David des Granges (1611-1675) whose work can be seen at Ham House and Windsor Castle; R. Gibson (1615-1690); Mrs Rosse, his daughter, who so cleverly imitated the work of Samuel Cooper, and Charles and Mary Beale, deserve notice at this period. They are followed by such artists as Lawrence Crosse (d. 1724), Gervase Spencer (d. 1763), Lens, Nathaniel Hone and Jeremiah Meyer, the latter two notable in connexion with the foundation of the Royal Academy. The workers in black lead (plumbago, as it was called at that time) must not be overlooked, especially David Loggan, Faithorne, White, Forster and Faber. They drew with exquisite detail and great effect on paper or vellum. The 18th century produced a great number of miniature painters, of whom Richard Cosway (1742-1821) is the most famous. His works are of great beauty, and executed with a dash and brilliance which no other artist equalled. His best work was done about 1790. His portraits are generally on ivory, although occasionally he worked on paper or vellum, and he produced a great many full-length pencil drawings on paper, in which he slightly tinted the faces and hands, and these he called "stayed" drawings. Cosway's finest miniatures are signed on the back; there is but one genuine signed on the face; very few bear even his initials on the front. George Engleheart (1750-1829) painted 4900 miniatures, and his work is stronger and more impressive than that of Cosway; it is often signed "E" or "G.E." Andrew Plimer (1763-1837) was a pupil of Cosway, and both he and his brother Nathaniel produced some lovely portraits. The brightness of the eyes, wiriness of the hair, exuberance of colour, combined with forced chiaroscuro and often very inaccurate drawing, are characteristics of Andrew Plimer's work. John Smart (1741-1811) was in some respects the greatest of the 18th-century miniaturists. His work excelled in refinement, power and delicacy; its silky texture and elaborate finish, and the artist's love for a brown background, distinguish it. Other notable painters were Ozias Humphry (1742-1810), Nixon (1741-1812), Shelley (c. 1750-1808), whose best pictures are groups of two or more persons, William Wood, a Suffolk artist (1768-1808), Edridge (1769-1821), Sullivan, Sheriff, Crosse, Bogle, Daye. In the 19th century J. C. D. Engleheart (1784-1862), nephew of George; Andrew Robertson (1777-1845), Beaumont, Behnes, Harlow, Heaphy and Mrs Mee must be mentioned. Sir Thomas Lawrence painted a few miniatures, and Raeburn some in his early days; but the art may be said to have died out with Sir William Ross, the Chalons and Newton, although some works by Landseer in this form are in existence, some small paintings of flowers by George Lannac, and one portrait by Rossetti. Towards the end of the 19th century came a revival of miniature painting, but without producing any masters of the same calibre. Alyn Williams and Lloyd amongst Englishmen, J. W. von Rehling-Quistgaard, the talented Danish miniature painter, and Bess Norris, an Australian artist, deserve mention.

From about 1650 onwards many fine miniatures were executed in enamel. Petitot (1607-1691) was the greatest worker in this material, and painted his finest portraits in Paris for Louis XIV. His son succeeded him in the same profession. Other artists in enamel were Boit (d. 1727), Zincke (d. 1767), Hurter (1734-1790), Thouron (1737-1789), Liot, Prieur, Spicer, Dinglinger,

Vouquer, Bain and Thienpondt. Many of these artists were either Frenchmen or Swiss, but most of them visited England and worked there for a while. The greatest English enamel portrait painter was Henry Bone (1755-1839), the finest of whose productions are now at Kingston Lacy. A great collection of his small enamel reproductions of celebrated paintings is in Buckingham Palace.

The earliest French miniature painters were Jean Clouet (d. c. 1540), his son François, Jean Fouquet, Jean Perreal and others; but of their work in portraiture we have little trace at the present day, although there are many portraits and a vast number of drawings attributed to them with more or less reason. The seven portraits in the manuscript of the *Galleic War* (Bibliothèque Nationale) are assigned to the elder Clouet; and to them may be added a fine work, in the Pierpont Morgan collection, representing the Maréchal de Brissac. Following these men we find the two Strösons, St André, Cotellet and Massé; the fine draughtsmen Picart, Vauthier and Chéron; and then, later on, we know of miniatures by Largillière, Boucher, Nattier, Montpetit, Desfosses, Drouais, Charlier, Thouron, Perrin and Dubourg; but the greatest names are those of Hall the Swede, Dumont the Frenchman, and Füger the Austrian. The tiny pictures painted by the von Blarenbergh family are by many persons grouped as miniatures, and some of the later French artists, as Prud'hon, Constance Meyer and Dubois, executed miniature portraits, while other whose names might be mentioned were Werner (1637-1710), Rosalba (1675-1757), Chatillon, Pasquier, Marsigli, Garriot, Sicardi and Festa. The most popular artists in France, however, were Augustin (d. 1832) and Isabeau (d. 1855). Their portraits of Napoleon and his court are exceedingly fine, and perhaps no other Frenchman painted miniatures so well as did Augustin. The Spanish painter Goya is known to have executed a few miniatures.

Miniatures are painted in oil, water-colour and enamel, but chiefly in water-colour. Many Dutch and German miniatures were painted in oil, and as a rule these are on copper; and there are portraits in the same medium, and often on the same material, attributed to many of the great Italian artists, notably those of the Bologna school. Samuel Cooper is said to have executed a few paintings in oil on copper, but we know little about the artists who prepared the numerous oil portraits in foreign collections.

The work of the 18th century on ivory is, of course, in water-colour. The use of ivory came into general adoption in the early part of the reign of William III., miniatures previous to that time having been painted on vellum, chicken-skin or cardboard, a few on the backs of playing cards, and many more on very thin vellum closely mounted on to playing cards.

The most important collections of miniatures in England in 1907 were those in the possession of the king, the duke of Buccleuch, Mr J. Pierpont Morgan, the duke of Rutland, the earls of Exeter, Ilchester, Dysart, Dartrey (notable for enamel work, some examples of which are of the greatest rarity) and Ancaster (especially notable for works by Cosway), of Earl Beauchamp, the late Baroness Burdet-Courts, Sir Gardner Engleheart (remarkable for containing almost exclusively works by the Engleheart family), Lord Weardale, and Messrs Drake, Digby, Williams, Whitehead, and Usher of Lincoln. There is a remarkable collection, principally of works in enamel, in the University Gallery, Oxford, a few fine miniatures at South Kensington, and in the same museum in the Jones collection some splendid works by Petitot, and there are also some famous foreign portrait and picture miniatures in the Wallace Collection, Hertford House, London. The collection at the Louvre is of importance, especially as regards the works of Petitot; that belonging to the queen of Holland of very high merit, and includes some choice works by Holbein and Alexander Cooper; and there is also a very fine collection at Amsterdam, including some of the largest works by Samuel Cooper and the largest known by Hoskins; and some very fine ones belong to the Crown of Sweden, and there is a superb but very mixed collection in Peter the Great's Gallery in St Petersburg, unfortunately in great confusion and needing re-arrangement. Many fine miniatures, including some very scarce enamel work by Prieur, are at the Rosenberg Palace in Copenhagen; the German emperor and the Crown of Prussia both own some remarkable examples, and there are important collections at Vienna, Florence and Stockholm, and in private hands in Berlin, Moscow and Helsingfors.

For fuller information see also J. L. Propert, *History of Miniature Art* (London, 1887); G. C. Williamson, *History of Portrait Miniatures* (2 vols., folio, 1904); *Portrait Miniatures* (London, 1897); *Richard Cosway* (London, 1897); *George Engleheart* (London, 1902); *Andrew Plimer, &c.* (London, 1902); *How to Identify Miniatures* (London, 1904); *Richard Cosway* (London, 1905), and the privately printed catalogue of the *Pierpont Morgan Collection* (1906, 1907, 1908); *Les Emaux de Fétou du Louvre* (Paris, 1868—1864); catalogues of the *Bucleuch Gallery*, *Wellbeck Gallery*, *Ward Fisher Collection*, *Bemrose Collection*, *Woburn Abbey Collection*, all privately printed, the catalogue of the collection exhibited at South Kensington, and the privately issued catalogue at the Burlington Fine Arts Club, with illustrations. (G. C. W.)

MINIM (adapted from Lat. *minimus*, the smallest; a superlative formed from the Indo-Germanic root *min-*, small), the smallest possible part of a thing, a particle. In music the name "minim" (*nota minima*) was given by medieval musicians to a note whose value was half a semibreve. It was, as its name implies, the note of the shortest duration then in use. In modern music several notes of lesser value, as the "crotchet" and "quaver," have been added, and the minim is now about half-way in the scale of "values." According to Thomas Morley (*A Plaine and Easie Introduction to Practical Music*, 1597), its introduction into manuscript music is ascribed to Phillipus de Vitriaco, a musician of the 14th century.

In medicine a minim is the smallest fluid measure, being equal to one drop. Sixty minims make a fluid drachm.

For the religious Order known as "Minims" see FRANCIS OF PAOLA, ST.

MINING, the general term for the working of deposits of valuable mineral. The term¹ is not limited to underground operations, but includes also surface excavations, as in placer mining and open-air workings of coal and ore deposits by methods similar to quarrying, and boring operations for oil, natural gas or brine. Mining may be subdivided into the operations of prospecting or search for minerals, exploration and development, work preparatory to active operations, and working. The latter includes not only the actual excavation of the mineral, but also haulage and hoisting by which it is brought to the surface, timbering and other means of supporting the excavations, and the drainage and ventilation of mines. Finally, under the heads of administration, mine valuation, mining education, accidents, hygiene and mining law, will be discussed matters having important bearing on mining operations. Special methods of mining are dealt with in the separate articles on COAL, GOLD, and other minerals and metals. QUARRYING and ORE-DRESSING, which may be considered as branches of mining, are also discussed in separate articles.

Prospecting.—In the article on MINERAL DEPOSITS (*q.v.*) the distribution and mode of occurrence of the useful minerals and ores are fully discussed. The work of prospecting is usually left to adventurous men who are willing to undergo privation and hardship in the hope of large reward though the chances of success are small. The prospector is guided in his search by a knowledge of the geological conditions under which useful minerals occur. When the rocks are concealed by detrital material he looks for outcroppings on steep hillsides, on the crests of hills or ridges, in the beds of streams, in landslides, in the roots of overturned trees, and in wells, quarries, road-cuttings and other excavations. When the solid rock is not exposed the soil sometimes furnishes an indication of the character of the underlying rock. Sometimes the vegetation, shrubs, trees, &c., as characteristic of certain soils, may furnish evidence as to rock or minerals below. Search should be made in the beds of streams and on the hillsides for "float mineral" or "shoad stones," fragments of rocks and minerals known to be associated with and characteristic of the deposits. Fragments of coal, or soil stained black with coal, will be found near the outcrop of coal beds. Grains of gold or particles of ore may be detected by washing samples of gravel in a prospector's

¹ Of doubtful origin. "Mine," both verb and substantive, come from the Fr., and is usually connected with Lat. *minare*, to drive or lead; but this would normally result in Fr. *mener*, not *miner*. Skeat, following Thurneysen, accepts a Celtic origin (cf. Irish *mein*, ore), but the *New Eng. Dict.* doubts this.

pan. By tracing such indications up the stream or up the hillside the outcrop may sometimes be found, or at least approximately located. The outcrop of a metalliferous vein frequently manifests itself as a line of rocks stained with oxide of iron, often honeycombed and porous, the "gossan" or "cisen-hut," the iron oxide of which results from the decomposition of the pyrites, usually present as a constituent of such veins. Other metals, such as manganese, copper, nickel, may show their presence by characteristic colours. Finally, the surface topography will often throw much light on the underground structure. The shape of the hills and ridges is necessarily influenced by the inclination of the strata, by the relative hardness of different rock-beds, and by the presence of folds and fissures and other lines of weakness. A quartz vein or bed of hard rock may show itself as a sharp ridge or as a well-defined bench; a stratum of soft rock or the line of a great fissure, or the weakening of the strata by an anticlinal fold, may produce a ravine or a deep valley. The bed of fire-clay under a coal seam, being impervious to water, frequently determines the horizon of numerous springs issuing from the hillsides. As the coal and the associated rocks usually contain pyrites, these springs are often chalybeate. When the location of the deposit has been determined approximately, further search is made by trenches or pits or borings through the surface soil.

Exploratory Work.—Before opening and working a mine it is necessary to have as full and accurate information as possible as to the following:—

1. The probable extent and area of the deposit, its average thickness, and the probable amount and value of the mineral;
2. The distribution of the workable areas of mineral in the deposit;
3. Conditions affecting the cost of opening, developing and working the mine or determining the methods to be adopted.

Work undertaken to secure this information must be distinguished from prospecting, which is the search for mineral deposits and from development, work undertaken to prepare for actual mining operations. Exploratory work is associated intimately both with prospecting and with development, but the purpose is quite distinct from either prospecting, development or working, and it is of importance that this should be clearly recognized. It must be remembered that the line between a workable deposit and one that cannot be profitably worked is often very narrow and that the majority of mineral deposits are not workable. The money that is spent in prospecting and in development is therefore liable to prove a loss. This is a recognized and legitimate business risk, differing only in degree from the risks attending all business operations. The risk of failure in mining enterprises is offset by the chances of more than ordinary profits. If the property proves valuable the returns may be very great. While the risk of loss of capital is not to be avoided, it is of the utmost importance to limit the amount of money expended while the extent and value of the deposit are still uncertain and to do the necessary work by the cheapest methods consistent with thoroughness. As the information as to the character and extent of the deposit becomes more definite, and as the prospects of success become more favourable, money may be spent more freely. The risk will vary with the character of the deposit. In the case of the cheaper and more abundant minerals, such as coal and iron ore, and of large deposits of low-grade ores, the extent and character of the deposit can generally be determined by surface examinations at comparatively small expense. On the other hand, in the case of less regular deposits, including most metalliferous veins, and especially those of the precious metals, the uncertainty is often very great, and it is sometimes necessary to work on a small scale for months before any considerable expenditure of money is justified.

The quickest and cheapest method is by surface explorations. The work of the prospector frequently furnishes much of the information required. By sinking additional pits or by extending the costeaning trenches and uncovering the outcrop of the deposit more fully it is sometimes possible to obtain all the

information required for the most extensive and important mining operations. Even when the outcrop is oxidized, and the mineral character and richness of the deposit is altered thereby, it is possible to determine variations in thickness and the extent and distribution of the rich and barren areas by outcrop measurements. Information of this sort obtained by surface exploration is often as conclusive as similar information obtained from underground workings. If the deposit shows great variations in thickness in its outcrop along the surface it is probable that a drift or a slope would show the same thing in depth. If the workable areas are poor, and appear only at long intervals along the outcrop, the chances of discovering richer areas by a shaft are very small.

In many cases underground exploration is necessary. For example, the deposit does not outcrop as in the case of blind veins and flat deposits below the general level of the country; or the outcrop lies beyond the limits of the property or under water or water-bearing formations, or is covered by quicksand, or is deeply buried. For such buried deposits boring is cheaper than sinking. In the case of coal, salt, iron ore, pyrite and other homogeneous minerals, boring may give all the information required. With a number of holes the average thickness and probable extent of the deposit may be determined, at least approximately. When the deposit is vertical or steeply inclined, horizontal or inclined bore-holes will be necessary. This will increase the cost of boring and will render the holes more likely to swerve from the true direction. In the case of metalliferous deposits of varying thickness or irregular distribution the information from bore-holes is less satisfactory. A large number of holes must be bored to obtain, even approximately, the average thickness and value of the ore and the shape and size of the ore bodies. In extreme cases the results from boring are likely to be untrustworthy and misleading unless the work is done on such a scale that the cost becomes prohibitory.

While the information obtained by surface explorations is always valuable, and sometimes conclusive, as to the value of the deposit, it is usually necessary to supplement **Underground Exploration** and confirm it by underground work. The outcrop of a metalliferous vein is generally more or less altered by oxidation, and often a part of the valuable mineral has been converted into a soluble form and leached out. These conditions sometimes extend to a considerable depth. Below the oxidized outcrop the vein is often increased in value by secondary enrichment, sometimes to a depth of several hundred feet. In the case of such altered deposits surface exploration alone is likely to be misleading, and it is important to push the underground exploration far enough to reach the unaltered part of the deposit, or at least deep enough to make it certain that there is a sufficient quantity of altered or enriched ore to form the basis of profitable mining operations. As the sinking of shafts or the driving of narrow entries or drifts is expensive, and as the mineral extracted rarely pays more than a small fraction of the cost, it is usual to plan this exploratory work so that the openings made shall serve some useful purpose later. The mistake is often made of sinking large and expensive shafts, or driving costly tunnels, before it is fully proved that the deposit can be worked on a scale to warrant such developments, and, indeed, too often before it is known that the deposit can be worked at all; and in too many cases large amounts of money are thus unnecessarily lost by over-sanguine mine managers. It is, however, often advisable that the money spent in surface or underground exploration should at the beginning be spent for information alone. The information so gained not only determines the value of the deposit, but also serves to indicate the best methods of development and of working. The money so spent, if judiciously used, insures the undertaking against loss by diminishing the mining risk, and is thus analogous to premiums paid to insure against fire or other sources of loss.

Development.—As soon as it appears reasonably certain that the property is workable the mine will be opened by one or more shafts, drifts or tunnels, and the underground passages

for active mining operations will be started. A drift or entry is a horizontal passageway starting from the outcrop and following the deposit. The former term is used in metal-mines and the latter in coal-mining. A tunnel differs from a drift in that it is driven across the strata to intersect the deposit. Either may be used for drainage of the mine workings, in which case it becomes an adit. A mine should always be opened by drift or entry if practicable, as thereby the expense of hoisting and pumping is avoided. Drifts, entries and tunnels find their chief application in mining regions cut by deep valleys. When, however, the deposit lies below the surface the mine must be opened by a shaft. If the outcrop of the vein or bed is accessible the shaft may be inclined and sunk to follow the deposit. This is in general a cheaper and quicker method of development for inclined deposits than by a vertical shaft, and it has the added advantage that much information as to the character of the deposit is obtained as the shaft is sunk. When the deposit lying below the surface is horizontal, or nearly so, or when the outcrop of an inclined deposit is not accessible, a vertical shaft will be necessary. Vertical shafts are better adapted to rapid hoisting, and have therefore somewhat greater capacity, than inclined shafts. They are to be preferred also for very deep shafts, or for sinking in difficult ground. Drifts and inclined shafts following the deposit may prove difficult of maintenance when the workings become large and settlement of the overlying strata begins. Large pillars of mineral should be left for the protection of the main openings, whether these be shafts or adits. In the case of very thick beds and mass deposits the main shaft or tunnel will preferably be located in the foot-wall.

Figs. 1 and 2 illustrate the development of a metal-vein by two adits, two inclined shafts in the lode, and by a deep vertical shaft connected with the lode by horizontal cross cuts. The stippled areas represent the ore shoots and the white areas the barren portions of the lode. The levels are supposed to be 10 fathoms (60 ft.) apart. As the mine is opened the deposit is subdivided into blocks of convenient size by parallel passages, which form later the main haulage roads, and by transverse openings for ventilation. In metal-mines the main passages are known as levels, and these are connected at intervals by winzes or small shafts. In coal mines, entries and headings, bords and walls serve similar purposes. The size of the blocks or the distance between the

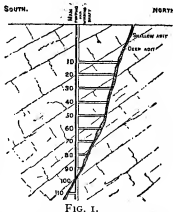

FIG. 1.

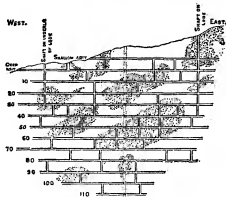

FIG. 2.

main passages is determined mainly by considerations of convenience and economy in excavating and handling the

mineral, and by the possibility of supporting the roof long enough to permit the excavation of the mineral without unnecessary risk or expense. In metal mining, when the workable portions of the deposit are small and separated by unworkable areas, the levels serve also the purpose of exploration, and in such cases must not be so far apart as to risk missing valuable mineral. In coal-mines main entries are often 700 yds. apart, while in metal-mines the distance between levels rarely exceeds 50 yds. and sometimes is but 50 or 60 ft. In irregular and uncertain deposits this work of development should be kept at all times so far in advance of mining operations as to ensure a regular and uniform output. In some cases, where the barren areas are large, it may be necessary to have two or three years' supply of ore thus blocked out in advance. A mine, however, may be over-developed, which results in loss of interest on the capital unnecessarily locked up for years by excessive development, and involves additional cost for the maintenance of such openings until they are needed for active mining operations.

Working.—When the development of a mine has advanced sufficiently the operation of working or extracting the mineral begins. The method to be adopted will vary with the thickness and character of the deposit, with its inclination, and to some extent with the character of the enclosing rocks, the depth below the surface, and other conditions. The safety of the men must be one of the first considerations of the mine operator. In most civilized countries the safety of mine workers is guarded by stringent laws and enforced by the careful supervision of mine inspectors on behalf of the government. The method of mining adopted must secure the extraction of the mineral at a minimum cost. The principal item in mining cost is that of labour, which is expended chiefly in breaking down the mineral, either by the use of hand tools or with the aid of powder. Labour is also expended in handling the mineral in the working-places and in bringing it to the mine-cars in which it is brought to the surface. Narrow and contracted working-places are to be avoided, as in such places the cost of breaking ground is always large. Economy in handling makes it desirable to bring the mine-cars as near as may be to the point where the mineral is broken. This can be done in inclined deposits, it can often be done by the aid of mechanical appliances, though sometimes at an expense not warranted in the saving in the labour of loading. In steeply inclined beds the working-place can be so arranged that the mineral will fall or slide from the place where it is broken down to the main haulage road. The greatest difficulty is found where the inclination of the deposit is too great to permit the mine-cars to be brought into the working-place and yet not great enough to allow the mineral to fall or slide to a point where it can be loaded.

While it is always desirable to provide large working-places, the size of the working-place is limited by the thickness and strength of the overlying beds forming the roof or hanging wall of the mine. With thick and strong rocks the working-places may sometimes exceed 100 or even 200 ft. in width. Indeed in metal-mines 100 ft. is the usual distance from one level to the next. With weak and thin beds forming the roof the working-places are often not wider than 20 or 30 ft. as in most coal-mines. While the width of the working-place is thus limited by the strength of the roof, its length is determined by other considerations—namely, the rapidity with which the mining work can be conducted and the length of time it is practicable to keep the working-place open, and also by the increased difficulty of handling the minerals sometimes experienced when the workings reach undue length. In long-wall and in the work of mining pillars the roof will be supported on one side only, the overhanging beds acting as cantilevers. The working-place in such case is considerably narrower than in rooms or stopes, and there is also greater difficulty in supporting the roof because the projecting beds tend to break close to the point of support where the strain is greatest. This tendency is overcome by the use of timber supports so disposed as to ensure the breaking

of the overhanging roof at a safe distance from the working-face and prevent the interruption of the work that might otherwise result.

While it is always desirable to work the deposit so as to extract the mineral completely, it frequently happens that this can only be done at greatly increased cost. In *Complete Extraction of Mineral*, the case of cheap and abundant minerals and low-grade ore deposits it is sometimes necessary to sacrifice a considerable proportion of the mineral, which is left for the support of the overlying strata. A similar sacrifice in the shape of pillars is often necessary to support the surface, either to avoid injury to valuable structures or to prevent a flooding of the mine. As already noted large pillars must always be left to protect shafts, adits and the more important mine-passages necessary for drainage, ventilation and the haulage of mineral. In the early history of mining there was but little attempt at systematic development and working, and the mines were often irregular and tortuous. Fig. 3 is

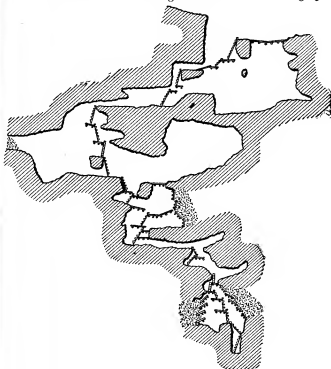

FIG. 3.

an old Mexican silver-mine of this type. In such mines the mineral was carried out on the backs of men, and the water was laboriously raised by a long line of suction-pumps, operated by hand, each lifting the water a few feet only. With but slight modifications permitting the use of pumps and hoisting-machinery equally simple methods of mining may be seen to-day when the deposit is of small extent. Fig. 4 is a portion of a mine which consists of a series of irregular chambers with the roof supported on small pillars left at intervals for the purpose. In the systematic mining of larger deposits, the simplest plan consists in mining large areas by means of numerous working-places under the protection of pillars of mineral left for the purpose, and later mining these pillars systematically, allowing the overlying rock beds to fall and fill the abandoned workings. In shallow mines the pillars are small and the saving of the mineral of minor importance. In deep mines the pillars may furnish the bulk of the product, and the control of the fall of the roof, so as to permit the successful extraction of the mineral, demands a well-schemed plan of operation. In the robbing of pillars, timber is necessary for the support of



FIG. 4.

the roof in the working-places, and later to control the fall of the roof while the pillars are mined. More effective support and control of the roof may be secured by the use of rock-filling alone or with timber. By the use of rock-filling it is even possible to dispense with pillars of mineral; or, if pillars are left, the use of rock-filling greatly facilitates subsequent robbing operations. Rock-filling will be used whenever a large proportion of barren material must be mined with the ore. If rock-filling must be brought from the surface its use will generally be confined to mines in which it is difficult to support the roof in any other way. Rock-filling yields and becomes consolidated under heavy pressure, and therefore does not furnish a rigid support of the overlying strata, but rather a cushion to control and equalize the subsidence.

With soft material, pillars must be large, even at moderate depths below the surface, and it involves less labour to leave **Room- and long rectangular pillars** than to form numerous **Pillar- square ones.** This leads to the adoption of the **room and pillar system** so common in coal-mining. Fig. 5 is a mine in a bed of soft iron ore worked by a series

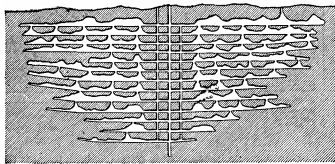

Fig. 5.

of inclined shafts, from which long horizontal rooms branch off right and left.

The usual method of working metal-mines is by overhand and underhand stoping, using rock-filling or pillars of mineral **Stoping.** to support the roof. Fig. 6 represents a portion of one of the Lake Superior copper-mines worked by overhand stoping. A stope is that portion of the working assigned to a party of miners, and the block of ground is usually

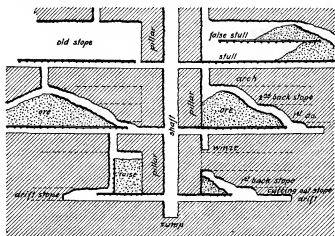

Fig. 6.

divided into three or four stopes at varying heights above the main level, the lowest being known as the cutting-out stope, the others as the first and second back stopes in ascending order. In steep pitching beds sufficient excavated material is allowed to remain in the stope for the support of the machines and men, the excess being drawn out from time to time and loaded into cars. The rest of the mineral is allowed to remain until the stope has so far advanced that its support is no longer needed. This method of mining requires but little timbering,

only a single line of timber and lagging over the level, called the stull. When the roof is weak, or when it is undesirable to leave so much ore in the stopes, false stulls are sometimes erected in the upper part of the stope. The ore below the false stulls can then be drawn out without waiting for the completion of the top stope. When the mineral does not stand well in the pillar it will be necessary to erect a line of timbers with lagging so as to sheathe the under-side of the pillar and prevent

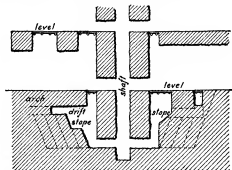

Fig. 7.

its falling. It is not desirable to leave large areas standing upon pillars in the mine, and as soon as the work on any level is completed the pillar below should be mined out as far as is safe, and the abandoned portion of the mine allowed to cave in and lessen the weight on the pillars elsewhere. The block or ground between levels is sometimes mined by underhand stoping (fig. 7). In this case the advanced drift is run underneath the pillar, and the ground below is mined in descending steps. This plan has the advantage of requiring little or no timbering when the mineral is strong enough to stand well in the pillars and when the hanging wall is good. The main haulage tracks are laid at the bottom of the stope, which thus forms the level. In this method of mining the different stopes must be kept close together; otherwise there is much added labour in shovelling the broken ore down to the main level. This method has the advantage of permitting the ore to be sent to the surface as fast as it is mined instead of being left for some months in the stopes for the men to stand upon. It has the disadvantage that the distance from one level to the next cannot usually be more than fifty feet without increasing greatly the chances of injury to the men from falling rock. The method is then practicable and safe only with exceptionally strong mineral and roof. In metal-mines producing abundant rock-filling the overhand method of stoping, illustrated in fig. 8, is used. In this the stoping contracts run vertically,

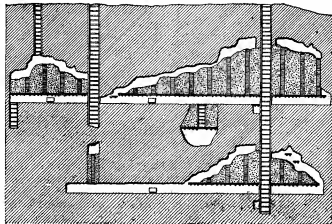

Fig. 8.

and each party of contractors has one or more mills or timbered chutes through which the rich ore is conveyed to the level below and loaded in cars. The ore as mined is hand-picked and the barren material allowed to remain in the stope where it

falls. In this method of mining no pillars need be left under the levels, as the rock-filling gives sufficient support to the roof. This method of mining affords the maximum of safety to the miners.

In the working of thick deposits the block of ground between two levels is divided into horizontal sections or floors which are worked either from above downward or from the bottom upward; in the first case the separate floors are worked by one of the caving systems; in the second, generally with the aid of filling. Fig. 9 illustrates the working of a block of ground by the top-slice caving system. Above, the ground has been completely worked out from the surface, and the space formerly occupied by ore is now filled with the debris of the overlying strata which has caved in above the block of ore now being worked. There is considerable thickness of old timber left from the working of the upper levels. This mat of timber forms a roof under the protection of which the mining of the ore proceeds downward floor by floor. The working-floors are connected by winzes with the main haulage roads below. These winzes serve for ventilation, for the passage of the workmen, and for chutes through which the ore is dumped to the level below. The working out of each floor is conducted much as if it were a bed of corresponding thickness. Haulage roads are driven in the ore so as to divide the floor into areas of convenient size. These separate areas are then mined in small rooms, each room being timbered as in mining under a weak roof rock. The room is driven in this way from one haulage road to another or to the boundary of the ore body. On completion of any room the timbers are withdrawn and the overlying mass of timber and rock is allowed to fall and a new room is started immediately alongside of the one just completed. In this way the whole floor is worked out and the mat of timber and overlying rock is gradually lowered and rests upon the top of the ore forming the floor below. Before abandoning a room it is usual to cover the bottom of the working-place with lagging-poles, which facilitate the mining of the floor below. In this manner one floor after another is worked until the floor containing the main haulage roads of the level below is reached. In the meantime a new level and a system of haulage roads have been driven a hundred feet below, and winzes have been driven upward to connect with the old level which is to be abandoned. The floor containing these old haulage roads now becomes the top slice of the one hundred-foot block of ground below and is mined out as described. Several floors may be mined simultaneously,

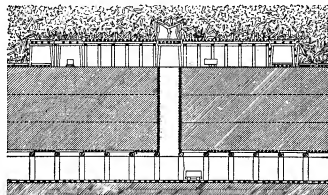

Fig. 9.

the workings in the upper floor being kept in advance of those below, so as to allow the broken mass above to become consolidated before it is again disturbed by the working places of the next floor. This system permits the complete extraction of the ore at moderate cost and without danger to the men.

The subdrift caving system, fig. 10, differs from the top-slice system mainly in the greater thickness given to the working floors, which may be from 12 to 40 ft. in thickness, whereas in the top-slice system the height of the floor is limited by the length of the timbers used in the working-rooms, rarely over 8 or 10 ft. The subdrift system requires a smaller amount

of narrow work in excavating the necessary haulage roads, and is therefore better adapted to hard ores in which such narrow work is expensive. The mining of each floor is carried on in sections with small working-places which are first driven of moderate height to their full length and width, leaving a back of ore above and pillars of ore between to support the upper portion of the upper layer or floor. These pillars and the

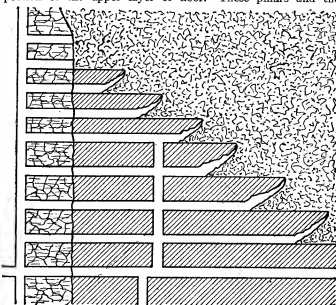

Fig. 10.

back of ore above are then mined in retreating back towards the haulage road. The subdrift system is somewhat cheaper than the top-slice system, the output per man being greater.

The bottom-slice caving system of mining begins at the bottom of a hundred-foot block of ground, a floor being excavated under the whole area, leaving pillars of sufficient size to support the ground above. These pillars are then filled with blast holes which are fired simultaneously, permitting the whole block of ground to the level above to drop. A floor is then reopened in this fallen ore, leaving pillars for temporary support which are blasted out as before. This is the cheapest of the three caving systems, but is applicable only when the deposit lies between walls of very solid rock, as otherwise wall rock is liable to cave with and become mixed with ore, which adds greatly to the expense of handling.

When rock filling is available, as when the ore contains much barren material to be left behind in mining, the ore body is divided into blocks of convenient height as above, and these blocks are divided into floors, the bottom floor of each block however being attacked. Each floor is opened up by subsidiary haulage roads and worked out in small rooms which are timbered and filled with broken rock when completed. An adjoining room is next excavated and filled, and thus the whole floor is worked out and replaced with rock-filling. Work is then started on the floor above, the upper floors being connected with the main haulage roads by winzes which are maintained through the filled ground. Several floors can be mined simultaneously, the work in the lower floors being kept well in advance. Instead of mining in horizontal floors the filling method permits the ore to be mined in vertical chambers or slices which extend from one level to the next above and from one wall of the deposit to the other. When a chamber has been excavated and completely filled the slice adjoining is mined out, or at times a block of ground may be left untouched between two filled chambers and then mined out. In the latter case the top-slice caving method will usually be employed for the working of such intervening pillars. In order to lessen the cost of handling the rock-filling, the excavation sometimes takes the form of inclined working-places, parallel to the slope naturally taken by the rock when dumped from above into the working

place. This method of mining and filling can be used when the work is done in horizontal floors or in transverse chambers. In the United States the Nevada square set system of timbering is used in connexion with rock filling (fig. 11). The use of the heavy timbers and continuous framing which characterize this system facilitates greatly the work of mining and maintaining the haulage roads on the different floors, and gives more rigid support to the unmined portions of the block of ground above. These advantages compensate for the greater first cost. Where each floor is timbered by itself with light timbers, as is the practice on the continent of Europe, the consolidation of the rock-filling under pressure gives rise to considerable subsidence of the unmined ore, which has frequently settled 20 ft. or more before the upper part of the block is reached. This occasions much added expense in the maintenance and retimbering of the haulage roads on the upper floors. The shrinkage of the rock-filling and the settlement of the workings

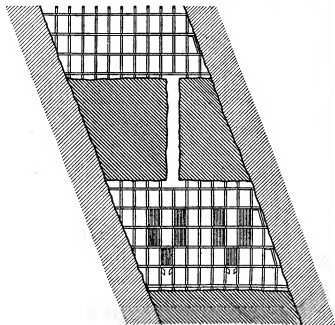

FIG. 11.

can be greatly lessened by the use of hard rock with a minimum of fine stuff; but even so the advantage lies with the American system of timbering.

The cost of filling has been greatly reduced by the system of flushing culm, sand, gravel and similar material, through pipes leading from the surface into mine workings. Material as coarse as 1 in. in diameter may be carried long distances underground with the use of little more than an equal volume of water. This method originated in the Pennsylvania anthracite mines in 1887, but has been employed in recent years on a large scale in Silesia, Westphalia and other European coalfields. In some cases it has been found advantageous to quarry and crush rock for the purpose of using it in this way. Examples of other mining methods will be found under COAL.

Where mineral deposits lie near the surface underground mining may be replaced by open excavations, and the reduced cost of mining makes it possible to remove the overlying soil and rock to considerable depths. The depth to which open working can be pushed depends upon the size and value of the mineral-deposit and upon the expense of removing the over-burden. Open excavations several hundred feet in depth are not uncommon. Where practicable steam shovels are employed, even when it is necessary to break up the material beforehand by blasting. Steam shovels are not well adapted to deep excavation unless provision is made for the rapid handling of the cars when filled. For deep workings the milling method is usually employed, in

which the ore is excavated in funnel-shaped pits, each of which connects with underground haulage roads by a shaft. The ore is mined in the ordinary way, by pick and shovel if soft, or by the aid of powder if necessary, and the funnel-shaped bottom of the pit is maintained at such an angle that little or no shovelling is required to bring the excavated material to the shaft. Before the bottom of these pits reaches the level of the haulage roads below, a new set of roads will have been driven at a lower level and connected with the excavations above by the shafts. The cost of mining by the milling method does not greatly exceed the cost of steam-shovel work. For the special methods by which placer deposits are mined see GOLD.

Underground Haulage.—The excavated material is brought to the hoisting shaft, or sometimes directly to the surface, in small mine cars, moved by men or by animals, or by locomotives or wire-rope haulage. The size, shape and design of the cars depend on the size of the mine passage and of the hoisting compartments of the shafts; on whether the cars are to be trammed by hand or hauled in trains; whether they are loaded by shovel or by gravity from a chute; and whether they are to be hoisted to the surface or used only for underground transport. The cost of underground haulage is lessened by the use of cars of large capacity. In the United States cars in the coal and iron mines hold from 2 to 4 tons. In Europe the capacity ranges from 1000 to 1500 lb, though the tendency is to increase the size of the cars used. In mines of copper, lead and the precious metals, in which the cars are moved by hand, the usual load is from 1200 to 3000 lb. These small cars are constructed so that the load may be dumped by pivoting the car bodies on the trucks. Larger cars are usually dumped by means of rotating or swinging cradles, the car bodies being rigidly attached to the axles or trucks. When loaded by shovel the car is made low to economize labour. Wooden rails, protected by iron straps, are sometimes used on underground roads for temporary traffic; but steel rails, similar to, though lighter than, those employed for railways are the rule. For hand tramping, animal and rope haulage, the rails weigh from 8 to 24 lb per yard, for locomotive haulage 30 to 40 lb. Grades are made, whenever possible, in favour of the load, and of such degree that the power required to haul out the loaded cars shall be approximately equal to that for hauling back the empties, viz. about $\frac{1}{2}$ of 1%. Sharp curves should be avoided, especially for mechanical haulage. Switches for turnouts and branches, &c., are similar to but simpler than those for railways.

In metal mines, where, as a rule, mechanical haulage is inapplicable, the cars are moved by men (trammers). This is expensive, but is made necessary by the small **Man and Animal Haulage.** amount of material to be handled at any given point. The average speed is about 200 ft. per minute, and the distances preferably but a few hundred feet. Animal haulage is employed chiefly in collieries and large metal mines; sometimes for main haulage lines, but oftener for distributing empty cars and making up trains for mechanical haulage. In mines operated through shafts the animals are stabled underground, and when well fed and cared for, thrive notwithstanding their rather abnormal conditions of life. Mine cars are sometimes run long distances, singly or in trains, over roads which are given sufficient grade to impart considerable speed by gravity, say from 1 to 2½%. The grades must not be too great for brake control nor for the hauling back of the empty cars. Cars may thus be run through long adits or through branch gangways to some central point for making up into trains. Near the top and bottom of hoisting shafts the tracks are usually graded to permit the cars to be run to and from the shaft by gravity.

Locomotive haulage is applicable to large mines, where trains of cars are hauled long distances on flat or undulating roads of moderate gradients. Steam locomotives have been largely superseded by compressed air or electric locomotives. Compressed air locomotives are provided with cylindrical

rope decreases. A similar equalizing effect is obtained by the use of flat rope and reel, the rope winding on itself like a ribbon. Tapering ropes, tail-ropes suspended from the cages, and other means of equalization, are also employed. If, for a two-compartment shaft, a pair of drums (or a single wide drum) be keyed to the engine shaft, with the ropes wound in opposite directions, the hoisting is "in balance," that is, the cages and cars counterbalance each other, so that the engine has to raise only the useful load of mineral, plus the rope. This arrangement allows no independence of movement: when the loaded cage is being hoisted the empty must be lowered. Independent drums, on the contrary, are loose upon their shaft, and are thrown on or off by tooth or friction clutches. The maximum load on the engine is thus greater and more power is required than for fixed drums. Steam consumption is economized, whenever possible, by throwing in the clutches of both drums and hoisting in balance. Fixed drums are best for mines in which the hoisting is done chiefly from one level; independent drums when there are a number of different levels. Hoisting engines are provided with powerful brakes and frequently with reversing gear. In deep shafts hoisting speeds of 3000 or 3500 ft. per minute are often attained, occasionally as much as 5000 ft.

Formerly hemp and also fibre ropes were commonly used. Except in a few instances these were long ago superseded by iron-wire ropes, which in turn have been replaced by steel because of

its greater strength. For hoisting in deep shafts, and to reduce the weight of rope, tempered-steel wire of very high tensile strength (up to 250,000 or 275,000 lb ultimate strength per sq. in.) is advantageously employed. A 1-in. ordinary steel rope has a breaking strength of about 32 tons, which, with a factor of safety of six gives a safe working load of $5\frac{1}{3}$ tons. A 1-in. plow-steel rope has breaking and working strengths respectively of at least 48 and 8 tons. Standard round

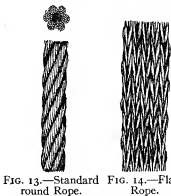
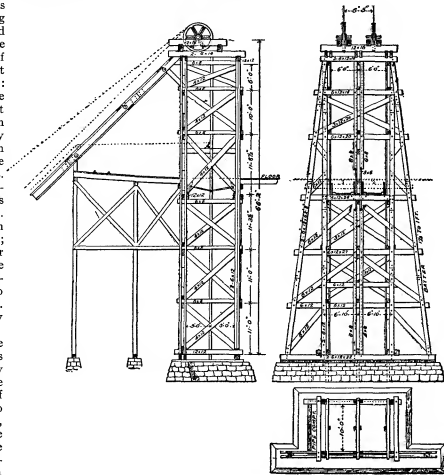

Fig. 13.—Standard round rope. Fig. 14.—Flat rope.

wires and strands of special shapes, have been introduced with the idea of improving the wearing properties. Such, for example, are the Lang-lay, locked-coil and flattened strand rope. Hoisting ropes are weakened by deterioration and breakage of the wires, due to corrosion and repeated bending, and should be kept under careful inspection. To prevent excessive bending stresses the diameter of drum and sheave must bear a proper ratio to that of the rope. A ratio of 48 to 1 is the minimum allowable; better 60 to 75 to 1, and for highly-

tempered steel ropes ratios of 150 to 1 or more are desirable. To prevent corrosion the rope should be treated at intervals with hot lubricant. With proper care a steel rope should last from two to three years.

A frame of wood or steel, erected at the shaft mouth, and



(From *The Colliery Engineer*, May 1897.)

FIG. 15.—Head-gear.

carrying the grooved sheaves over which the hoisting ropes pass, is known as the head-gear (fig. 15). In Great Britain and her colonies it is also called the poppet-head or pit-head frame; in the United States head-frame or gallow-frame. Though it is small and simple in construction for light work, for heavy hoisting at high speeds massively framed towers, often 80 to 100 ft. in height, are built. Steel frames are more durable than those of wood, and have become common in nearly all mining countries, especially where timber is scarce. A German design is shown in fig. 16. The head-gear is often combined with ore-bins and machinery for breaking and sizing the lump ore previous to shipment to the reduction works.

Cages, running in guides in the shaft, are used for raising the cars of mineral to the surface (fig. 17). They may have one, two or more decks, usually carrying one or two cars on each deck. Multiple-deck cages are rarely employed except for deep shafts of small cross-section or when the mine cars (tubs) are small, as in many parts of Europe. In many mines the mineral is raised in skips (fig. 18), filled from cars underground and dumping automatically on reaching the surface. Skips are sometimes of very large capacity, holding 5, 7, and even 10 tons of ore; such are used, for example, in several shafts at Butte, Montana, in the Lake Superior copper district, and in South Africa. Fig. 18 is a small skip; the upper illustration showing position for dumping. The lower cut is of a skip for either ore or water; note valve in bottom. Hoisting buckets or kibles are employed for small

Head-gear.
Cages and Skips.

scale work or temporary service, such as raising the material blasted in sinking shafts. They hold from a few hundred pounds up to 1 ton. In hoisting from great depths the weight of the rope, which may exceed that of the cage and

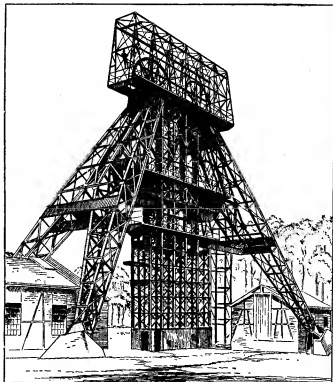

FIG. 16.—Steel head-gear, modern German type, constructed by Aug. Klönne, Dortmund.

contents, produces excessive variations in the load on the engine difficult to deal with. Moreover, the limit of vertical depth at which rope of even the best quality will support its own weight only, with a proper margin of safety, is, say, 10,000 to 12,000 ft.; and with the load the safe working limit of depth would be reached at 7000 to 8000 ft. A number of



FIG. 17.—Light steel safety mining cage and car for gold and silver mines. Wellman-Seaver-Morgan Co., Cleveland, Ohio, makers.

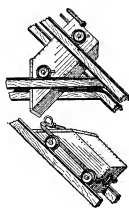

FIG. 18.—Ore and water skips for inclined shaft. Alls-Chalmers Co., Milwaukee, Wisconsin, makers.

shafts in South Africa, the United States and elsewhere, are already approximating depths of 5000 ft., a few being even deeper. Ropes of tapering section may be used for great depths, but are not satisfactory in practice.¹ Stage hoisting is applicable to any depth. Instead of raising the load in one lift from the bottom of the shaft, one or more intermediate

¹ A full discussion of this subject is given in *Trans. Ins. Min. and Met.*, vol. xi.

dumping and loading stations are provided. Each stage has its own engine, rope and cage. The variations in engine load are thus reduced, and incidentally hoisting time is saved.

In shallow mines the men use the ladder-way in going to and from their work. This is sometimes the case also for considerable depths. It is more economical ^{Raising and Lowering} to save the men's strength, however, by raising ^{Men.} and lowering them with the hoisting engines.

At mines with vertical shafts this is a simple operation. Cages of the size generally used in metal mines will hold from ten to fifteen and occasionally twenty men. The time consumed in lowering the men is shortened by the use of cages having two or more decks. These are common in Europe, and are sometimes employed in the United States and elsewhere in mines where the output is large and the shafts deep and of small cross section. While a shift of men is being lowered the miners of the preceding shift are usually raised to the surface in the ascending cages, the entire shift being thus changed in the time required for lowering. Nevertheless, in very deep and large mines the time consumed in handling the men may make serious inroads on the time available for hoisting ore. At a few mines special man-cages are operated in separate compartments by their own engines for handling part of the men, and for tools, supplies, &c. For inclined shafts, where the mineral is hoisted in skips, the operation of raising and lowering men may not be so simple. Even a large skip will hold but a few men, the speed is slower, and more time is required for the men to get into and out of the skip than to step on and off a cage. Moreover, skips are rarely provided with safety attachments, so that the danger is greater. When the shafts are deep and the number of miners large man-cars are sometimes employed. These are long frames on four wheels, with a series of seats like a section of a theatre gallery. Ordinarily 4 or 5 men occupy each seat, the car accommodating from 20 to 36 men. Such cars are in use at a number of deep inclined shafts in the Lake Superior copper district, where the depths range from 3000 to 5000 ft. or more. At a few mines (since safety catches cannot be successfully applied to man-cars) these conveyances are raised and lowered by separate engines and ropes. To replace the ore-skip expeditiously by the man-car when the shifts are to be changed a crane is often erected over the shaft mouth. At the end of a shift the ore-skip is lifted from the shaft track—the hoisting rope being uncoupled—and the man-car put in its place and attached to the rope. This change may be made in a few minutes.

Formerly, at many deep European mines, and at a few in the United States, men were raised by means of "man-engines." A man-engine consists of two heavy wooden rods ^{Man-Engines.} (like the rods of a Cornish pumping plant), placed parallel and close to each other in a special shaft compartment, and suspended at the surface from a pair of massive walking beams (or "bobs"). The rods are caused to oscillate slowly by an engine, one rising while the other is falling. Thus they move simultaneously in opposite directions through a fixed length of stroke, say from 10 to 12 ft. At intervals on the rods are attached small horizontal platforms, only large enough to accommodate two men at a time. As the rods make their measured strokes one of the miners, starting from the surface, steps on the first platform as it rises to the surface landing and is then lowered on the down stroke. At the end of the stroke, when his platform comes opposite to a corresponding platform on the other rod, he steps over on to the latter during the instant of rest prior to the reversal of the stroke, descends with the second rod on this down stroke, steps again at the proper time to a platform of the first rod and so on to the bottom. The men follow each other, one by one, so that in a few minutes all the rod platforms in a deep shaft may be simultaneously occupied by men stepping in unison but in opposite directions from platforms of one rod to the other. Meantime, the men quitting work are ascending in a similar way, as there is room on each platform for two men at a time when passing each other. Man-engines were long used,

but are now practically abandoned in both Great Britain and the United States, and few remain in any of the mining regions of the world. Their first cost is great and they are dangerous for new men, as they require constant alertness, presence of mind, and a certain knack in using them. See *Trans. Inst. Min. and Met.* xi. 334, 345, 380, &c.; also *Eng. and Min. Jour.* (April 4, 1903), pp. 517 and 518.

Surface Handling, Storage and Shipment of Minerals.—To mine ore or coal at minimum cost it is necessary to work the mine plant at nearly or quite its full capacity and to avoid interruption and delays. When the mineral is transported by rail or water to concentration or metallurgical works for treatment, or to near or distant markets for sale, provision must be made for the economical loading of railway wagons or vessels, and for the temporary storage of the mineral product. For short periods the mineral may remain in the mine cars, or may be loaded into railway wagons held at the mine for this purpose. Cars, however, are too valuable to be used in this way for more than a few hours, and it is usual to erect large storage bins at the mine, at concentration works and metallurgical establishments, in which the mineral may be stored, permitting cars, wagons and vessels to be quickly emptied or loaded. In mining regions where water transportation is interrupted during certain months of the year the mineral must be stored underground, or in great stock-piles on the surface. In coal mining the market demand varies in different seasons, and surface storage is sometimes necessary to permit regular work at the mines. For coal, iron ore and other cheap minerals, mechanical handling by many different methods is used in loading and unloading railway wagons and vessels, and in forming the stock-piles and reloading the mineral therefrom. (See CONVEYOR and DOCKS; also G. F. Zimmer, *Mechanical Handling of Materials, and Engineering Magazine*, xiv. 275, xx. 157 and xxi. 657.)

Mine Drainage.—A mine which has been opened by an adit tunnel or drift drains itself, so far as the workings above the adit level are concerned. In many mining regions long tunnels have been driven at great expense to secure natural drainage. Under modern mining conditions drainage tunnels have lost much of their former importance. Taking into account the risk attending all mining operations, which make necessary large interest and amortization charges on the cost of a tunnel, it will in most cases be advisable to raise the water to the surface by mechanical means. Drainage channels are provided, usually along the main haulage roads, by which the water flows to a sump excavated at the pump shaft. In driving mine passages that are to be used for drainage, care is taken to maintain sufficient gradient. Siphons are sometimes used to carry the water over an undulating grade and thereby save the expense of a deep rock cutting. As the larger part of the water in a mine comes from the surface, the cost of drainage may be reduced by intercepting this surface water, and collecting it at convenient points in the pump shaft from which it may be raised at less cost than if permitted to go to the bottom. Water may be raised from mines by buckets, tanks or pumps. Wooden or steel buckets, holding from 35 to 200 gallons, are employed only for temporary or auxiliary service or for small quantities of water in shallow shafts. Tanks operated by the main hoisting engines, and of capacities up to 1500 gallons or more, are applicable under several conditions: (1) When the shaft is deep, the quantity of water insufficient to keep a pump in regular operation, and the hoisting engine not constantly employed in raising mineral, the tank is worked at intervals, being attached temporarily to the hoisting rope in place of the cage. (2) For raising large volumes of water from deep shafts pairs of tanks are operated in balance in special shaft compartments by their own hoisting engine. With an efficient engine the cost per gallon of water is often less than for pumping. (3) For clearing flooded mines. As the water level falls the tanks readily follow it while at work, whereas pumps must be lowered to new positions to keep within suction distance. Self-acting tanks are occasionally built underneath

the platforms of hoisting cages. Mine pumps are of two classes: (1) those in which the driving engine is on the surface and operates the pumps by a long line of rods passing down the shaft, commonly known as the Cornish system; (2) direct-acting pumps, in which the engine and pumping cylinders form a single unit, placed close to the point underground from which the water is to be raised. Cornish pumps are the oldest of the machines for draining mines; in fact, one of the earliest applications of the old Woolf and Newcomen engines in the 18th century was to pumps for deep mines. The engine works a massive counter-balanced walking-beam from which is suspended in the shaft a long wooden (or steel) rod, made in sections and spliced together. Attached to the rod by offsets are one or more plunger or bucket pumps, set at intervals in the shaft. All work simultaneously, each raising the water to a tank or sump above, whence it is taken by the next pump of the system, and finally discharged at the surface. The individual pumps are placed several hundred feet apart, so that a series is required for a deep shaft. The speed is slow—from 4 to 10 strokes per minute—but the larger sizes, up to 24 in. or more in diameter by 10 or 12 ft. stroke, are capable of raising millions of gallons per day. Cornish pumps are economical in running expenses, provided the driving engine is of proper design and the disadvantages incurred in conveying steam underground are avoided. Their first cost, however, is high and the cumbersome parts occupy much space in the shaft. Direct-acting pumps, first introduced (1841) by an American, Henry R. Worthington, are made of many different designs. Typically they are steam pumps, the steam and water cylinders being set tandem on the same bed frame, generally without fly-wheel or other rotary parts; they may be single cylinder or duplex, simple, compound or tripler expansion, and having a higher speed of stroke are smaller in all their parts than Cornish pumps. For high heads the water cylinders, valves and valve chambers are specially constructed to withstand heavy pressures, water being sometimes raised in a single lift to heights of more than 2000 ft. Condensers are always required for underground pumps. Sinking pumps, designed for use in shafts in process of sinking, are suspended by wire ropes so as to be raised before blasting and promptly lowered again to resume pumping. Electrically driven pumps, now widely used, are convenient and economical. Mine pumps of ordinary forms may be operated by compressed air, and air-lift pumps have been successfully employed. Hydraulic pumping engines, while not differing essentially from steam pumps, must have specially designed valves in the power cylinder on account of the incompressibility of water. They can be used only when a supply of water under sufficient pressure is available for power. Centrifugal pumps, constructed with several stages or sets of vanes, and suitable for high lifts, have been introduced for mine service. When mine water is acid the working parts of the pump must be lined with or made of bronze or other non-corrosive material; or the acid may be neutralized by adding lime in the sump.

Ventilation.—The air of a mine is vitiated by the presence of large numbers of men and animals and of numerous lights, each of which may consume as much air as a number of men. In mining operations explosives are used on a large scale and the powder gases contain large quantities of the very poisonous gas, carbon monoxide, a small percentage of which may cause death, and even a minute percentage of which in the air will seriously affect the health. In addition to these sources of contamination the air of the mine is frequently charged with gas issuing from the rocks or from the mineral deposit. For example, carbon dioxide occurs in some mines, and hydrogen sulphide, which is a poisonous gas, in others. In coal-mines we have to deal with "fire-damp" or marsh gas, and with inflammable coal dust, which form explosive mixtures with air and frequently lead to disastrous explosions resulting in great loss of life. The gases produced by such fire-damp or dust explosions contain carbon dioxide and carbon monoxide in large proportion, and the majority of the deaths from such explosions are due to this "after-damp" rather than to the

explosion itself. The terrible effects of fire-damp have led to the adoption of elaborate systems of ventilation, as the most effective safeguard against these explosions is the dilution and removal of the fire-damp as promptly and completely as possible. Very large volumes of air are necessary for this purpose, so that in such mines other sources of vitiation are adequately provided against and need not be considered. In metal mines, however, artificial ventilation is rarely attempted, and natural ventilation often fails to furnish a sufficient quantity of air. The examination of the air of metal mines has shown that in most cases it is much worse than the air of crowded theatres or other badly ventilated buildings. This has a serious effect on the health and efficiency of the workmen employed, and in extreme cases may even result in increased cost of mining operations. The ventilation of a mine must in general be produced artificially. In any case whether natural or artificial means be employed, a mine can only be ventilated properly when it has at least two distinct openings to the surface, one an intake or "downcast," the other a chimney serving as an "upcast." Two compartments of a shaft may be utilized for this purpose, but greater safety is ensured by two separate openings, as required by law in most mining countries.

The air underground remains throughout the year at nearly the same temperature, and is warmer in winter and cooler in summer than the outside air. If the two openings to the mine are at different levels the difference in weight of the inside and outside air due to difference in temperature causes a current, and in the winter months large volumes of air will be circulated through the mine from this cause alone. In summer there will be less movement of air and the current will frequently be reversed. In a mine with shafts opening at the same level, natural ventilation once established will be effective during cold weather, as the downcast will have the temperature of the outside air, while the upcast will be filled with the warm air of the mine. In summer this will occur only on cool days and at night. When the temperature of outside and inside air becomes equal or nearly so natural ventilation ceases or becomes insignificant. In a mine with two shafts a ventilating current may result from other conditions creating a difference in the temperature of the air in either shaft—for example, the cooling effect of dropping water or the heating effect of steam pipes. Natural ventilation is impracticable in flat deposits worked by drifts and without shafts.

Ventilation may be produced by heating the air of the mine, as for example, by constructing a ventilating furnace at the bottom of an air shaft. The efficiency of such ventilating furnaces is low, and they cannot safely be used in mines producing fire-damp. They are sometimes the cause of underground fires, and they are always a source of danger when by any chance the ventilating current becomes reversed, in which case the products of combustion, containing large quantities of carbon dioxide, will be drawn into the mine to the serious danger of the men. On account of their dangerous character furnaces are prohibited by law in many countries.

Positive blowers and exhausting apparatus of a great variety of forms have been used in mines for producing artificial ventilation. About 1850, efficient ventilators of the **Mechanical Ventilators.** centrifugal type were first introduced, and are now almost universally employed where the circulation of large volumes of air is necessary, as in collieries. The typical mine fan consists of a shaft upon which are mounted a number of vanes enclosed in a casing; the air entering a central side inlet is caught up by the revolving vanes and thrown out at the periphery by the centrifugal force thus generated. "Open-running" fans have no peripheral casing, and discharge freely throughout their entire circumference; in "closed" fans the revolving part is completely enveloped by a spiral casing opening at one point into a discharge chimney. Fans either force air into or exhaust it from the mine. The inlet opening of the pressure fan is in free communication with the outside air,

the discharge connecting with the mine air-way; in the more generally used exhaust fan the inlet is connected with the air-way, the fan discharging into the atmosphere. Among the exhaust fans most widely employed is the Guibal. Many others have been introduced, such as the Capell (fig. 19), Rateau,

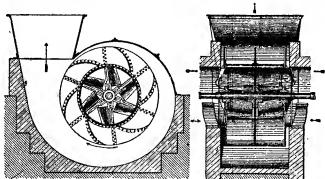

(From *Mines and Minerals*, March, 1905.)

FIG. 19.—Capell Fan.

Schiele, Pelzer, Hanarte, Ser, Winter, Kley, and Sirocco fans. The Waddle may be instanced as an example of the open fans. Slow-speed fans are sometimes of large dimensions, up to 30 and even 45 ft. diameter, discharging hundreds of thousands of cubic feet of air per minute. Occasionally, at very gassy and dangerous collieries, two fans and driving engines are erected at the same air shaft, and in case of accident to the fan in operation the other can be started within a few minutes.

Opposed to the motive force producing the air current is the frictional resistance developed in passing through the mine workings. This resistance is equal to the square of the velocity of the current in feet per minute, multiplied by the total rubbing or friction surface of the air-ways in square feet and by the coefficient of friction. The latter, determined experimentally, varies with different kinds of surfaces of mine workings, whether rough or smooth, timbered or unlined; it ranges from 0.00000001872 to 0.000000217 lb per sq. ft., the latter being the value usually adopted. A certain pressure of air is required to maintain circulation against the resistance, and for a given volume per minute the smaller and more irregular the mine openings the greater must be the pressure. The pressure is measured by a "water-gauge" and the velocity of flow by an "anemometer."

The power required to circulate the air through a mine increases as the cube of the velocity of the air current. To decrease the velocity, when large volumes of air are required, the air passages are made larger, and the mine is divided into sections and the air current subdivided into a corresponding number of independent circuits. This splitting of the air not only lessens the cost of ventilating, but greatly increases its efficiency by permitting the circulation of much larger volumes, and has the added advantage that the effect of an explosion or other accident vitiating the air current is often confined to a single division of the mine, and affects but a small part of the working force. The adjustment of the air currents in the different splits is affected by regulators which are placed in the return air-ways, and act as throttle valves to determine the volume of air in each case. The circulation of air in any given division of the mine is further controlled and its course determined by temporary or permanent partitions ("brattices"), by the erection of stoppings, or by the insertion of doors in the mine passages and by the use of special air-ways (see COAL). In devising a system of ventilation it is customary to subdivide the workings so that the resistance to the ventilating current in each split shall be nearly equal, or so that the desired amount of air shall be circulated in each without undue use of regulating appliances which add to the friction and increase the cost of removing the air. In addition to this it is desirable to take advantage of the natural ventilation, that is, to circulate the air in the direction that it goes naturally, as otherwise the resistance to the movement of the air may be

greatly increased. So far as possible, vitiated air is led directly to the shaft instead of passing through other workings; for example, mine stables when used are placed near the upcast shaft and ventilated by an independent split of the ventilating current.

Deep Mining.—There has been much speculation as to the depth to which it will be practicable to push the work of mining. The special difficulties which attend deep mining, in addition to the problems of hoisting ore and raising water from great depths, are the increase of temperature of the rocks and the pressure of the overlying strata. The deepest mine in the world is No. 3 shaft of the Tamarack mine in Houghton county, Michigan, which has reached a vertical depth of about 5200 ft. Three other shafts of the Tamarack Company, and three of the neighbouring Calumet and Hecla mine, have depths of between 4000 and 5000 ft. vertical. The Quincy mine, also in Houghton county, has reached a vertical depth of nearly 4000 ft. In England are several collieries over 3000 ft., and in Belgium two are nearly 4000 ft. deep. In Austria three shafts in the silver mines at Pribram have reached the depth of over 1000 metres. At Bendigo in Australia are several shafts between 3000 and 4000, and one, the Victoria Quartz mine, 4300 ft. deep. In the Transvaal gold region (South Africa), a number of shafts have been sunk to strike the reef at about 4000 ft. In most cases the deposits worked are known to extend to much greater depths than have been reached. The possibility of hoisting and pumping from great depths has been discussed, and it remains now to consider the other conditions which will tend to limit mining operations in depth—namely, increase of temperature and increase of rock pressure. Observations in different parts of the world have shown that the increase of temperature in depth varies: in most localities the rise being at the rate of one degree for 50 to 100 feet of depth; while in the deep mines of Michigan and the Rand, an increase as low as one degree for each 200 ft. or more has been observed. In the Comstock mines at Virginia City, Nevada, it is possible to continue mining operations at rock temperatures of 130° F. In these mines a constant supply of pure air, about 1000 cub. ft. per minute, was blown into the hot working places through light iron pipes. The air issuing from these pipes was dry and warm, and served to keep the temperature of the air below 120°, at which temperature it was possible for men to work continuously for half an hour at a time, and for four hours in the day. In some places work was conducted with rock temperatures as high as 158° F., with air 135° F. In these very hot drifts the fatality was large. In the Alpine tunnels, where the air was moist and probably not as pure as in the Comstock mines, great difficulty was experienced in prosecuting the work at temperatures of 90° F. and less. The mortality was large, and it was believed by the engineers that temperatures over 104° would have proved fatal to most of the workmen. Deep mines, however, are generally dry, so that in most cases it will be possible to realize the more favourable conditions of the Comstock mines. Assuming an initial mean temperature of 50° F., and increments of one degree for 100 and for 200 ft., a rock temperature of 130° will be reached at 8000 to 10,000 ft. In many deep mines to-day "explosive rock" has been encountered. This condition manifests itself, for example, in mine pillars which are subjected to a weight beyond the limit of elasticity of the mineral of which they are composed. Under such conditions the pillar begins to yield, and fragments of mineral fly off with explosive violence, exactly as a specimen of rock will splinter under pressure in a testing machine. The flying fragments of rock have frequently injured and sometimes killed miners. A similar condition of strain has been observed in deep mines in different parts of the world—perhaps due to geological movements. Assuming a weight of 13 cub. ft. to the ton, then at 6500 ft. the pressure per sq. ft. will be 500 tons, and at 13,000 ft. 1000 tons; and as the mineral is mined the weight on the pillars left will be proportionately greater. At such pressures all but the strongest rocks will be strained beyond their limit of elasticity. At depths of 1000 ft.

and less some of the softer rocks show a tendency to flow, as exhibited by the under-clay in deep coal-mines, which not infrequently swells up and closes the mine passages. In the Mont Cenis tunnel a bed of soft granite was encountered that continued to swell with almost irresistible force for some months. The pressure developed was sufficient to crush an arched lining of two-foot granite blocks. Similar swelling ground is not infrequently met with in metal mines, as, for example, in the Phoenix copper mine in Houghton county, Michigan, where the force developed was sufficient to crush the strongest timber that could be used. In very deep mines this flowing of soft rock will doubtless add greatly to the difficulty of maintaining openings. What may happen in some cases is illustrated by the curious form of accident locally known as a "bump," which occurs in some of the deep coal-mines of England. In one instance (described by F. G. Meacham, *Trans. Fed. Inst. M. E.* v. 381), the force developed by the swelling under-clay broke through and lifted with the force and suddenness of an explosion a lower bench of coal 8 ft. thick in the bottom of a gangway 12 ft. wide for a length of 200 ft., throwing men and mine cars violently against the roof and producing an air-wave which smashed the mine doors in the vicinity. It is apparent that the combined effect of internal heat and rock pressure will greatly increase the cost of mining at depths of 8000 or 10,000 ft., and will probably render mining impracticable in many instances at depths not much greater.

Mine Administration.—In organizing a mining company it must be recognized that mining is of necessity a temporary business. When the deposit is exhausted the company must be wound up or its operations transferred to some other locality. Mining is also subject to the risks of ordinary business enterprises, and to additional risks and uncertainties peculiar to itself. The vast majority of mineral deposits are unworkable, and of those that are developed a large proportion prove unprofitable. In addition mining operations are subject to interruption and added expense from explosions, mine fires, flooding, and the caving-in of the workings. To provide for the repayment from earnings of the capital invested in a mining property and expended in development, and to provide for the depreciation in value of the plant and equipment, an amortization fund must be accumulated during the life of the mine; or, if it be desired to continue the business of mining elsewhere, a similar fund must be created for the purchase, development and equipment of a new property to take the place of the original deposit when that shall be exhausted. If, for example, we assume the life of a given mine at ten years and the rate of interest at 5%, it will be necessary that the property shall earn nearly 13% annually—viz., 5% interest and 8% for the annual payment to the amortization or the reserve fund. To cover the special risks of mining, capital should earn a higher interest than in ordinary business, and if we assume that the sinking-fund be safely invested, we must compute the amortization on a lower basis than 5%. Assuming, for example, the life of the mine at ten years as before, and taking the interest to be earned by the amortization fund at 3%, and that on the investment at 10%, we shall find that the annual income should amount to 18.7% per year. These simple business principles do not seem to be generally recognized by the investing public, and mines, whose earning capacity is accurately known, are frequently quoted on the stock markets at prices which cannot possibly yield enough to the purchaser to repay his investment during the probable life of the mine.

Mine Valuation.—The value of any property is measured by its annual profits. In the case of mining properties these profits are more or less uncertain, and cannot be accurately determined until the deposit has been thoroughly explored and fully developed. In many instances, indeed, profits are more or less uncertain during the whole life of the mine, and it is evident that the value of the mining property must be more or less speculative. In the case of a developed mine its life may be predicted in many cases with absolute certainty—as when the extent of the mineral deposit and the volume of mineral can be measured. In other cases the life of the mine, like the value of the mineral, is more or less uncertain. Further, both time and money are required for the development of the mining property before any profit can be realized. Mathematically we have thus in all cases to compute present value on the basis of a deferred as well as a limited annuity. The valuation of mines then involves the following steps: (1) The sampling of the deposit so far as developed, and assaying of the samples taken; (2) The measurement of the developed ore; (3) estimates of the probable amount of ore in the undeveloped part of the property; (4) estimates of probable profits, life of the mine, and determination of the value of the property. Where the deposit is a regular one and the mineral is of fairly uniform richness, the taking of a few samples from widely separated parts of the mine will often furnish sufficient data to

determine the value of the deposit. On the other hand in the case of uncertain and irregular deposits, the value of which varies between very wide limits, as, for example—in most metal mines and especially mines of gold and silver—a very large number of samples must be taken—sometimes not more than two or three feet apart—in order that the average value of the ore may be known within reasonable limits of error. The sampling of a large mine of this character may cost many hundreds of pounds. This applies with even greater force to estimates of undeveloped portions of the property. If the deposit is regular and uniform, the value of undeveloped areas may sometimes be predicted with confidence. In the majority of instances, however, the estimates of undeveloped ore contain a large element of uncertainty. In order to determine the probable profit and life of the mine a definite scale of operations must be assumed, the money required for development and plant and for working capital must be estimated, the methods of mining and treating the ore determined, and their probable cost estimated. Where the deposit is uncertain and the element of risk is large, we must adopt a high rate of interest on investments of capital in our computations of value—in some cases as high as 10, 15 or even 20%. Where the deposit is regular and the future can be predicted with some degree of certainty, we may be justified in adopting in some cases possibly as low as 5%. The interest on the annual contribution to the sinking-fund or its equivalent should be reckoned at a low rate of interest, for such funds are assumed to be invested in perfectly safe securities. Allowance must be made for the period of development during which there are no contributions to the sinking-fund and within which no interest is earned on invested capital.

Mining Education.—It is necessary to have the work directed by men thoroughly familiar with the characteristics of mineral deposits, and with wide experience in mining. For the purpose of training such men special schools of mining engineering (*écoles des mines, Bergakademie*) have been established in most mining countries. A student of mining must receive thorough instruction in geology; he must study mining as practised in different countries, and the metallurgical and mechanical treatment of minerals; and he should have an engineering education, especially on mechanical and electrical lines. As he is called upon to construct lines of transport, both underground and on the surface, works for water-supply and drainage, and buildings for the handling, storage and treatment of ore, he must be trained to some extent as a civil engineer. As a foundation his education must be thorough in the natural and physical sciences and mathematics. In addition there have been established in many countries schools for the education of workmen, in order to fit them for minor positions and to enable them to work intelligently with the engineers. These miners' schools (*Bergschule, écoles des mineurs*) give elementary instruction in chemistry, physics, mechanics, mineralogy, geology and mathematics and drawing, as well as in such details of the art of mining as will best supplement the practical information already acquired in underground work. The training of a mining engineer merely begins in the schools, and mining graduates should serve an apprenticeship before they accept responsibility for important mining operations. It is especially necessary that they should gain experience in management of men, and in the conduct of the business details, which cannot well be taught in schools.

Accidents.—Mining is an extra-hazardous occupation, and the catastrophes, which from time to time have occurred, have caused

agencies to enforce their authority. While in some cases these laws are unnecessarily stringent and tend to restrict the business of mining yet on the whole they have had the effect of reducing greatly the loss of life and injuries of miners where they have been well enforced. This is evident from fig. 20, which shows the number of men killed in the coal and metal mines of Great Britain for a series of years. As will be seen from this diagram the most serious source of death and injury is not found in mine explosions, but in the fall of rocks and mineral in the working places. This danger can be reached only in small degree by laws and inspection; but the safety of the men must depend upon the skill and care of the miners themselves and the officers in charge of the underground work. Great loss of life and injury occur through the ignorance, carelessness and recklessness of the men themselves, who fail to take the necessary precautions for their own safety, even when warned to do so. Mining laws have proved chiefly serviceable in securing the introduction of efficient ventilation, the use of safety-lamps, and of proper explosives, to lessen the danger from fire-damp and coal-dust in the coal-mines, the inspection of machinery for hoisting and haulage, and prevention of accidents due to imperfection in design or in working the machinery.

Fire-damp and dust explosions are caused by the presence of marsh-gas in sufficient quantity to form an explosive mixture, or by a mixture of small percentages of marsh-gas and coal-dust, and in some cases by the presence of coal-dust alone in the air of the mine. Explosive mixtures of marsh-gas and air may be fired by an unprotected light. But when coal-dust is present, and little or no marsh-gas, an initial explosion such as is produced by a blown-out shot—is required. To guard against explosions from this cause it is necessary to use explosives in moderate quantities and to see that the blast-holes are properly placed, so that the danger of blown-out shots may be lessened. In dry and dusty mines the danger may be greatly lessened by sprinkling the working places and passages, and the removal of the accumulated dust and fine coal. Where large quantities of fire-damp are present, safety-lamps of approved pattern must be used and carefully inspected daily. The use of matches and naked lights of any kind must be prohibited. To lessen the danger from blasting operations the use of special safety explosives is required in Great Britain and some European countries. The use of such explosives decreases to some extent the danger from dust explosions; but experiment shows that no explosive is absolutely safe, if used in excessive quantity, or in an improper manner. Absolute security is impossible, as is proved by the many and serious disasters under the most stringent laws and careful regulations that can be devised.

Mine fires may originate from ordinary causes, but in addition they may result from the explosion of fire-damp or from the accidental lighting of jets of fire-damp issuing from the coal. **Mine Fires.** In some mining districts the coal is liable to spontaneous combustion. A fire underground specially becomes formidable, not only in coal but also in metal mines, on account of the large quantity of timber used to support the excavations. Underground fires may sometimes be extinguished by direct attack with water. The difficulty of extinguishing an underground fire in this way is, however, very great, as on account of the poisonous products of combustion it is impossible to attack it except in the rear, and even there the men are always in great danger from the reversal of the

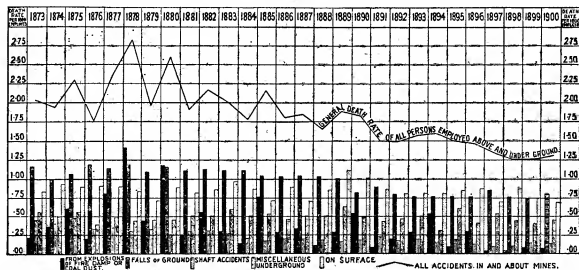

FIG. 20.—Death-rate from various classes of accidents in and about all mines in the United Kingdom from 1873 to 1900.

the enactment of laws to protect the lives of the men engaged in underground work. These laws are enforced by mine inspectors who are empowered to call upon the courts and other government

air current, or back-draught from the fire. Further, the burning of the timber produces falls of ground, making necessary the excavation and removal at times of hundreds of tons of heated rock and

burning coal, in order to reach the fire. When direct attack is no longer practicable, it is possible to extinguish the fire by sealing the mine workings, and exhausting the supply of oxygen. It is necessary, however, to keep the mine sealed until the burning timbers, or coal, and the red-hot rocks have become cool, or the fire will again break out. This sometimes requires two or three months. Where an effective sealing of the mine is impracticable it is sometimes possible to extinguish the fire from the outside of the mine by constructing a large reservoir or tank in the upper part of the mine-shaft and suddenly releasing a large volume of water by opening discharge-doors. The mass of water falling down the shaft is converted into spray, which is carried by the force of the fall long distances into the workings. Where the fire is in or near the shaft this method has proved very effective. Mine fires may sometimes be reached by bore-holes sunk for the purpose from the surface, and the burning workings below filled by flooding with culm and water. As a last resort the mine may be flooded with water. This is an expensive operation as it entails the cost of pumping the water out again and repairing the resulting damage. If the fire is in working places to the rise the water may not reach the burning portions of the mine, but will effectually seal them. But sufficient time must be allowed to elapse before pumping out the water, as otherwise the fire may break out again.

Mines may become flooded by the inrush of surface waters in times of great rainfall or sudden floods, or by the undermining of surface waters. The surface workings may also be flooded or flooded by large bodies of underground water. This is an expensive operation as it entails the cost of pumping the water out again and repairing the resulting damage. If the fire is in working places to the rise the water may not reach the burning portions of the mine, but will effectually seal them. But sufficient time must be allowed to elapse before pumping out the water, as otherwise the fire may break out again.

Flooding of Mines.—Floods must be provided with channels of sufficient size to carry them safely past the mine openings, and intercepting ditches should be excavated for this purpose, and dams and embankments constructed to divert the flood waters. That it is possible to work with safety beneath rivers, lakes and even the ocean has been proved in numerous instances; mines in different parts of the world having been extended long distances under the sea. In such cases preliminary surveys should be made to determine the thickness of rock over the proposed workings. Under favourable conditions mining may be conducted under the protection of a few yards of solid rock only, as in the submarine work for the removal of reefs in the harbours of San Francisco and New York. At Silver Islet, Lake Superior, mining was successfully carried on for years under the protection of a coffer dam and an arch of rich silver ore less than 20 ft. thick. At Wheel Cock near St. Just in Cornwall the protecting roof was so thin that holes bored for blasting more than once penetrated to the bed of the ocean, and wooden plugs were used on hand to drive into such holes, when this occurred. In storms the boulders could be heard striking each other overhead. When large areas are undermined, as in submarine coal mining, it is best to have several hundred feet of protecting rock. In Great Britain the law requires that the workings shall be protected by 120 ft. of solid strata. When the presence of underground bodies of water is known or suspected, advance bore-holes should radiate from the end of the advancing working place so as to give warning of the position of the body of water, these holes being of such length as to ensure a safe thickness of solid rock.

The caving in of mine workings results from the excavation of large areas supported upon pillars of insufficient size. While the mine workings are small the overlying rocks support themselves and the full pressure does not come upon the mine pillars. As the workings increase in size the pillars support an increasing weight until finally they are strained beyond the limit of elasticity. When this occurs, the pillars begin to crack and splinter with a noise like musketry firing, and the roof of the mine shows signs of subsidence. This may continue for weeks or even months. As the pillars are undermined the roof occurs locally, here and there throughout the mine, and these falls may succeed one another until the settlement of portions of the roof has so far relieved the strain that the remaining areas are supported by the stronger pillars, and by the fallen rock masses. While abundant warning of the caving-in of the workings is thus given in advance it may happen that men are unexpectedly imprisoned by the closing of the main passage ways. The caving-in of the mine, however, is rarely so complete that avenues of escape are not open. In many cases, however, it has been found necessary to reopen the mine through the fallen ground, and even to make tall openings through the solid mineral. The history of mining is full of dramatic episodes of this character.

Accidents from Explosives.—Accidents from the misuse and careless handling of explosives are unfortunately too frequent in mines. The conditions under which explosives may be stored, handled and used are carefully formulated in the mining laws of most states, but it is almost impossible to secure obedience to these regulations on the part of the miners, who are, as a rule, both careless and reckless in the use of powder. In some states it has become necessary to provide fines and even imprisonment of men disobeying the regulations regarding explosives.

Mine Hygiene.—While mining is not necessarily an unhealthy occupation, miners are subject to certain diseases resulting from vitiated air, and from unusual or special conditions under which at times they are forced to work. Recent investigations have shown an alarming increase in mortality from miners' phthisis in Cornwall,

South Africa and elsewhere. This seems to be due to the dust abundantly produced in mining operations, and especially by machine drills when boring "dry" (rising) blast holes. Drill runners, who are compelled to breathe this dusty air daily, furnish most of the sufferers from phthisis. The increased mortality seems to be due to the general tendency toward forced speed in development work, which is secured by rapid drilling, and by an increase in the number of machine drills in use. In some cases, when the miners, to save time, often return to their work after blasting before the powder-smoke and dust have been sufficiently removed. It is probable that the carbon monoxide seriously affects the general health and vitality of the men, and renders them more likely to succumb to phthisis. More effective ventilation will materially lessen the death-rate. In the metal mines of Cornwall and Devon special rules are now in force requiring the use of water in drilling, and other precautions, to lessen this danger from dust. In some mines dust seems to have but little effect on the health of the miners; indeed it is even claimed by some that coal dust decreases the mortality from phthisis. On the other hand, as in mining ores containing lead, arsenic and mercury, the dust may be poisonous. The climbing of ladders from deep mines not only lessens the efficiency of the men by reason of fatigue, but often tends to increase the mortality from diseases of the heart. In cold climates men coming from the warm atmosphere of a mine, often in wet clothing, are liable to suffer in health unless proper provision is made for the necessary change of clothing. In such cases the establishment of dressing-rooms, proper ventilation of the mine, and passages by covered passages will be necessary. These "change-rooms" are provided with washing and bathing facilities, and arrangements for drying wet clothing. Ankylostomiasis (*g.v.*) is a disease which finds a congenial habitat in the warm damp atmosphere of mines, and has become a veritable scourge in some mining regions. The disease yields readily to treatment, but is difficult to eradicate from a mine without stringent sanitary regulations to prevent its spread. The care of the health of the working force should be entrusted to competent mine physicians, thoroughly familiar with the conditions under which the miners work, and with the special diseases to which they are subject. The men should be instructed in the laws of sanitation, and in the proper care of injured men.

Mine Law.—Mine law is that branch of the law of real property relating to mineral and mining rights as distinct from rights pertaining to the surface of the ground. Under the common law the owner of the surface possesses all mining rights as well, unless these have been reserved as the property owner of the property. From very ancient times expectations of gold and silver have been met in countries under the protection of the crown. In public government land the minerals as well as surface belong to the state, and are not infrequently these rights have been separated by law and granted or otherwise disposed of to different owners. It is to the public interest that deposits of mineral should not be permitted to remain idle and undeveloped. This has been recognized from the earliest times, and laws have been framed in all countries for the encouragement of mining enterprise. In many cases the state or the ruler has sought to obtain a share in the profits of mining, or even to work himself mine physicians, thoroughly familiar with the conditions under which the miners work, and with the special diseases to which they are subject. The men should be instructed in the laws of sanitation, and in the proper care of injured men.

Mine Law.—Mine law is that branch of the law of real property relating to mineral and mining rights as distinct from rights pertaining to the surface of the ground. Under the common law the owner of the surface possesses all mining rights as well, unless these have been reserved as the property owner of the property. From very ancient times expectations of gold and silver have been met in countries under the protection of the crown. In public government land the minerals as well as surface belong to the state, and are not infrequently these rights have been separated by law and granted or otherwise disposed of to different owners. It is to the public interest that deposits of mineral should not be permitted to remain idle and undeveloped. This has been recognized from the earliest times, and laws have been framed in all countries for the encouragement of mining enterprise. In many cases the state or the ruler has sought to obtain a share in the profits of mining, or even to work himself mine physicians, thoroughly familiar with the conditions under which the miners work, and with the special diseases to which they are subject. The men should be instructed in the laws of sanitation, and in the proper care of injured men.

BIBLIOGRAPHY.—See C. Le Neve Foster's *Ore and Stone Mining* (6th ed., London, 1905), or G. Köhler's *Lehrbuch der Bergbaukunde* (6th ed., Leipzig, 1903). The following works may also be consulted: Books—Bertolito, *Coltivazione delle miniere* (Milan, 1902); Brown, *The Organisation of Gold Mining Business* (Glasgow, 1897); Brough, *Mine Surveying* (12th ed., London, 1906); Bulman and Redmayne, *Colliery Working and Management* (London, 1896); Colomer, *Exploitation des mines* (1897); Demanet, *Traité d'exploitation des mines* (2nd ed., London, 1902); Demanet, *Traité d'exploitation des mines de houille* (2nd ed., Brussels, vols. i and ii, 1898, vol. iii, 1899); Denny, *Deep Level Mines of the Rand* (London, 1902); Galloway, *Lectures on Mining* (Cardiff, 1900); Habets, *Cours d'exploitation des mines* (2nd ed., Liège, vol. i, 1906, vol. ii, 1904); Hatch and Chalmers, *The Gold Mines of the Rand* (London, 1895); Haton de la Goupillière, *Cours d'exploitation des mines* (2nd ed., Paris, vol. i, 1896, vol. ii, 1897); Hoeler, *Taschenbuch für Bergmänner* (Leoben, 1897); Hughes, *Colliery Working* (London, 1900); M. C. Hilsing, *A Practical Mining* (4th ed., New York, 1905); Kirschner, *Grubenbau und Erzaufbereitung* (Leipzig and Vienna, vol. i, 1898, vol. ii, 1899); Lawn, *Mine Accounts and Mining Book-keeping* (London, 1897); Lupton, *Mining* (3rd ed., London, 1899); T. A. Rickard, *The Sampling and Estimation of Ore in a Mine* (New York, 1904); Truscott, *The Witwatersrand Goldfields—Banket and Mining Practice* (London, 1898); G. F. Williams, *The Diamond Mines of South Africa* (New York,

1902); Periodical Publications—*Annales des mines de Belgique* (Brussels, quarterly); *Australian Mining Standard* (Melbourne, Sydney and Brisbane, weekly); *Engineering and Mining Journal* (New York, weekly); *Glückauf* (Essen, weekly); *Mines and Quarries; General Report and Statistics* (London, annually); with details from official reports of colonial and foreign mining departments; *Mines and Minerals* (monthly, Scranton, Pennsylvania); *The Mineral Industry* (New York, annually); *Transactions of the American Institute of Mining Engineers* (New York); *The Mining and Scientific Press* (weekly, San Francisco); *Transactions of the Institute of Mining and Metallurgy* (London); *Transactions of the Institution of Mining Engineers* (Newcastle-on-Tyne). (H. S. M.)

MINION, a favourite, pet or spoiled person. The word is adapted from the Fr. *mignon* (Ital. *mignone*), of which the origin is doubtful. Connexions with the O.H. Ger. *minna*, love, and with a Celtic root *min-*, meaning small, have been suggested. "Minion" is chiefly applied in a derogatory sense to the "creatures" of a royal court, and thus has been used of the favourites of Edward II. and James I. of England, and of Henry III. of France. In the sense pretty, delicate, dainty, the French form *mignon* or *mignonne* is often used in English. During the 17th century "minion" was the name of a type of cannon with a small bore. In typography, it is still used for the type which comes between "nonpareil" and "brevier."

MINISTER (Lat. *minister*, servant), an official title both civil and ecclesiastical. The word *minister* as originally used in the Latin Church was a translation of the Greek *διάκονος*, deacon; thus Lactantius speaks of *presbyteri et ministri*, priests and deacons (*De mort. persecutorum*, No. 15), and in this sense it is still technically used; thus canon vi., Sess. xxiii. of the council of Trent speaks of the hierarchy as consisting "ex episcopis, presbyteris et ministris." But the equivocal character of the word soon led to the blurring of any strictly technical sense it once possessed. Bishops signed themselves *minister* in the spirit of humility, priests were "servants of the altar" (*ministri altaris*), while sometimes the phrase *ministri ecclesiae* was used to denote the clergy in minor orders (see *Lex Bajwar. tit. 8*, quoted in Du Cange). A similar equivocal character attaches to the word *minister* as used in the Anglican formularies: " Oftentimes it is made to express the person officiating in general, whether priest or deacon; at other times it denoteth the priest alone, as contradistinguished from the deacon" (Burn's *Ecc. Law*, ed. Phillimore, iii. 44). Thus the 33rd canon of 1603 orders that "no bishop shall make any person a deacon and minister both together upon one day." Generally, however, it may be said that in the use of the Church of England "minister" means no more than *executor officii*, a sense in which it was used long before the Reformation. As the most colourless of all official ecclesiastical titles, it is easy to see how the word *minister* has come to be applied to the clergy of Protestant denominations. The phrase "minister of religion" is wide enough to embrace any evangelical office, and has about it more of the savour of humility than "pastor."

The civil title of minister originates in the same exact sense of servant, i.e. servants of the royal household (*ministri aulae regis*). This origin is still clearly traceable in the titles of some ministers in Great Britain, e.g. chancellor of the exchequer, first lord of the treasury, and in the official style of "his majesty's servants" applied to all. Practically, however, the word *minister* has in modern states come to be applied to the heads of the great administrative departments who as such are members of the government. On the continent there are, besides, "ministers without portfolio," i.e. ministers who, without being in charge of any special department, are members of the government. In general it is distinctive of constitutional states that any public act of the sovereign must bear the countersignature of the minister responsible for the department concerned. (See the articles **MINISTRY** and **CABINET**. For the history and meanings of the word "minister" in diplomacy, see **DIPLOMACY**.) (W. A. P.)

MINISTRY, the office of a minister (*g.v.*), in all its meanings, political and religious, or the body of persons holding such an office and performing its duties; more particularly the body of

persons who, in theory the servants at the head of the state, act as the responsible executive over the whole sphere of government, as in the United Kingdom. On the continent of Europe, on the other hand, the word "ministry" is most usually applied to the responsible head of a particular department together with his subordinates, including the permanent officials or staff. In England, ever since the introduction of monarchical institutions the sovereign has always been surrounded by a select body of confidential advisers to assist the crown in the government of the country. At no period could a king of England act, according to law, without advice in the public concerns of the kingdom; the institutions of the crown of England and the institution of the privy council are coeval. At the Norman Conquest the king's council, or as it is now called, the privy council, was composed of certain members of the aristocracy and great officers of state, specially summoned by the crown, with whom the sovereign usually advised in matters of state and government. In the earlier stages of English constitutional history the king's councillors, as confidential servants of the monarch, were present at every meeting of parliament in order to advise upon matters judicial in the House of Lords; but in the reign of Richard II. the privy council dissolved its judicial connexion with the peers and assumed an independent jurisdiction of its own. It was in the reign of Henry VI. that the king's council first assumed the name of privy council, and it was also during the minority of this sovereign that a select council gradually emerged from the larger body of the privy council, which ultimately became the modern cabinet. Since the Revolution of 1688, and the development of parliamentary government, the privy council has dwindled into comparative insignificance. The power once swayed by the privy council is now exercised by that unrecognized select committee of the council known as the cabinet (*g.v.*). The practice of consulting a few confidential advisers instead of the whole privy council had been resorted to by English monarchs from a very early period; but the first mention of the term cabinet council in contradistinction to privy council occurs in the reign of Charles I., when the burden of state affairs was entrusted to the committee of state which Clarendon says was enviously called the "cabinet council." At first government by cabinet was as unpopular as it was irregular. Until the formation of the first parliamentary ministry by William III. the ministers of the king occupied no recognized position in the House of Commons; it was indeed a moot point whether they were entitled to sit at all in the lower chamber, and they were seldom of one mind in the administration of matters of importance. Before the Revolution of 1688 there were ministers, but no ministry in the modern sense of the word; colleague schemed against colleague in the council chamber, and it was no uncommon thing to see ministers opposing one another in parliament upon measures that in modern times would be supported by a united cabinet. As the change from government by prerogative to government by parliament, consequent upon the Revolution of 1688, developed, and the House of Commons became more and more the centre and force of the state, the advantage of having ministers in the legislature to explain and defend the measures and policy of the executive government began to be appreciated. The public authority of the crown being only exercised through the medium of ministers, it became absolutely necessary that the advisers of the sovereign, who were responsible for every public act of the Crown as well as for the general policy they had been called upon to administer, should have seats in both Houses of Parliament. Still nearly a century had to elapse before political unanimity in the cabinet was recognized as a political maxim. From the first parliamentary ministry of William III. until the rise of the second Pitt, divisions in the cabinet were constantly occurring, and a prime minister had more to fear from the intrigues of his own colleagues than from the tactics of the opposition. In 1812 an attempt was made to form a ministry consisting of men of opposite political principles, who were invited to accept office, not avowedly as a coalition government, but with an offer to the Whig leaders that their friends should be allowed a majority of one in the cabinet. This offer

was declined on the plea that to construct a cabinet on "a system of counteraction was inconsistent with the prosecution of any uniform and beneficial course of policy." From that date it has been an established principle that all cabinets are to be formed on some basis of political union agreed upon by the members when they accept office together. It is now also distinctly understood that the members of a cabinet are jointly and severally responsible for each other's acts, and that any attempt to distinguish between a particular minister and his colleagues in such matters is unconstitutional.

During the 19th century the power of ministers was greatly extended, and their duties became more distinctly marked out. As now interpreted, the leading principles of the British constitution are the personal irresponsibility of the sovereign, the responsibility of ministers, and the inquisitorial and controlling power of parliament. At the head of affairs is the prime minister (g.s.), whose duties are more general than departmental; and the other members of the administration, whose work is exemplified by the titles of their offices (the more important of which are treated separately), are the lord high chancellor, the lord president of the council, the lord privy seal, the first lord of the treasury, the five secretaries of state (home, foreign affairs, colonies, war, India), the chancellor of the exchequer, the secretary for Scotland, the chief secretary to the lord-lieutenant of Ireland, the postmaster-general, the presidents of the board of trade, the local government board, the board of agriculture and the board of education (all of which were originally committees of the privy council), the chancellor of the duchy of Lancaster and the first lord of the admiralty. These are the more important members of the administration, and they are generally in the cabinet. The subordinate members of the administration, some of whom are occasionally invited to join the cabinet, while others are never in it, are the parliamentary and financial secretary to the admiralty, the parliamentary under-secretaries of the home, foreign, war, colonial and India offices, the board of trade, local government and board of education, the junior lords of the treasury (assistant "whips"), the financial secretary and patronage secretary to the treasury (the senior "whip"), the first commissioner of works, the paymaster-general, and the attorney-general and solicitor-general. There are in addition the lord advocate and the solicitor-general for Scotland, the lord-lieutenant and lord chancellor of Ireland (who are sometimes members of the cabinet), and the attorney-general and solicitor-general for Ireland.

TABLE OF LORD TREASURERS OR FIRST LORDS OF THE TREASURY

[The title was at first lord treasurer, except when the treasury was put in commission. Ultimately special rank was given to one of the commissioners as first lord of the treasury. From the time of the earl of Essex (1679) the name given is that of the first lords, with the exception of the three printed in italics. In modern times the first lord of the treasury has usually, but not invariably, been the head of the government or prime minister. A list of the Prime Ministers is given in the article PRIME MINISTER.]

- 1603. Lord Buckhurst, cr. Earl of Dorset 1604.
- 1608. Earl of Salisbury.
- 1612. Earl of Northampton and others. (Commissioners.)
- 1614. Earl of Suffolk.
- 1618. Archbishop Ambot and others. (Commissioners.)
- 1620. Sir H. Montagu, cr. Viscount Mandeville 1620.
- 1621. Lord Cranfield, cr. Earl of Middlesex 1622.
- 1624. Sir J. Ley, cr. Lord Ley 1625, and Earl of Marlborough 1626.
- 1628. Lord Weston, cr. Earl of Portland 1633.
- 1635. Archbishop Laud and others. (Commissioners.)
- 1636. W. Juxon, Bishop of London.
- 1641. Sir E. Littleton and others. (Commissioners.)
- 1643. Lord Cottington.
- 1649. Interregnum.
- 1660. Sir E. Hyde and others. (Commissioners.)
- 1660. Earl of Southampton.
- 1667. Duke of Albemarle and others. (Commissioners.)
- 1672. Lord Clifford.
- 1673. Viscount Dunblane, cr. Earl of Danby 1674.
- 1679. Earl of Essex.
- 1679. Lord Hyde, cr. Earl of Rochester 1682.
- 1684. Lord Godolphin.
- 1687. Lord Bellasyse.
- 1689. Earl of Monmouth.
- 1690. Viscount Londsale.
- 1690. Lord Godolphin.
- 1697. C. Montagu, cr. Earl of Halifax 1700.
- 1699. Earl of Tankerville.
- 1700. Lord Godolphin.
- 1701. Earl of Carlisle.
- 1702. Lord Godolphin.
- 1710. Earl Poulett.

- 1711. Earl of Oxford.
- 1714. Duke of Shrewsbury.
- 1714. Earl of Halifax.
- 1715. Earl of Carlisle.
- 1715. Sir R. Walpole.
- 1717. Lord Stanhope.
- 1718. Earl of Sunderland.
- 1721. Sir R. Walpole.
- 1742. Earl of Wilmington.
- 1743. H. Pelham.
- 1754. Duke of Newcastle.
- 1756. Duke of Devonshire.
- 1757. Duke of Newcastle.
- 1762. Earl of Bute.
- 1763. G. Grenville.
- 1765. Marquess of Rockingham.
- 1766. Duke of Grafton.
- 1770. Lord North.
- 1782. Marquess of Rockingham.
- 1782. Earl of Shelburne.
- 1783. Duke of Portland.
- 1783. W. Pitt.
- 1801. H. Addington.
- 1804. W. Pitt.
- 1806. Lord Grenville.
- 1807. Duke of Portland.
- 1807. S. Perceval.
- 1812. Earl of Liverpool.
- 1827. G. Canning.
- 1827. Viscount Goderich.
- 1828. Duke of Wellington.
- 1830. Earl Grey.
- 1834. Viscount Melbourne.
- 1834. Sir R. Peel.
- 1835. Viscount Melbourne.
- 1841. Sir R. Peel.
- 1846. Lord J. Russell, cr. Earl Russell 1861.
- 1852. Earl of Derby.
- 1852. Earl of Aberdeen.
- 1855. Viscount Palmerston.
- 1858. Earl of Derby.
- 1859. Viscount Palmerston.
- 1865. Earl Russell.
- 1866. Earl of Derby.
- 1868. B. Disraeli.
- 1868. W. E. Gladstone.
- 1874. B. Disraeli, cr. Earl of Beaconsfield 1876.
- 1880. W. E. Gladstone.
- 1885. Sir Stafford Northcote, cr. Earl of Idesleigh 1885 (prime minister, Marquess of Salisbury).
- 1886. W. E. Gladstone.
- 1886. Marquess of Salisbury.
- 1887. W. H. Smith (prime minister, Lord Salisbury).
- 1891. A. J. Balfour (prime minister, Lord Salisbury).
- 1892. W. E. Gladstone.
- 1894. Earl of Rosebery.
- 1895. A. J. Balfour (prime minister, Lord Salisbury till 1902).
- 1905. Sir H. Campbell-Bannerman.
- 1908. H. H. Asquith.

TABLE OF LORD CHANCELLERS (C.) OR LORD KEEPERS (L.K.)

- 1603. Sir T. Egerton, L.K., cr. Lord Ellesmere 1603, and Viscount Breckley 1616.
- 1617. Sir F. Bacon, L.K., cr. Lord Verulam 1618, and Viscount St Albans 1621.
- 1621. J. Williams, Bishop of Lincoln, L.K.
- 1625. Sir T. Egerton, L.K., cr. Lord Coventry 1628.
- 1640. Sir J. Finch, L.K., cr. Lord Finch 1640.
- 1641. Sir E. Littleton, L.K., cr. Lord Lyttelton 1641.
- 1645. Sir R. Lane, L.K.
- 1649. Interregnum.
- 1660. Sir E. Hyde, C., cr. Lord Hyde 1660, and Earl of Clarendon 1661.
- 1667. Sir O. Bridgeman, L.K.
- 1672. Earl of Shaftesbury, C.
- 1673. Sir H. Finch, L.K., cr. Lord Finch 1674, C. 1675, cr. Earl of Nottingham 1681.
- 1682. Sir F. North, L.K., cr. Lord Guilford 1683.
- 1685. Lord Jeffreys, C.
- 1690. Sir J. Maynard and others. (Commissioners.)
- 1690. Sir J. Trevor and others. (Commissioners.)
- 1693. Sir J. Somers, L.K., C., cr. Lord Somers 1697.
- 1700. Sir N. Wright, L.K.
- 1705. W. Cowper, L.K., cr. Lord Cowper 1706, C. 1707.
- 1710. Sir T. Trevor and others. (Commissioners.)
- 1710. Sir S. Hildcourt, L.K., cr. Lord Harcourt 1711, C. 1713.
- 1714. Lord Cowper, C.
- 1718. Sir R. Tracy and others. (Commissioners.)
- 1718. Lord Parker, C., cr. Earl of Macclesfield 1721.
- 1725. Sir J. Jekyll and others. (Commissioners.)
- 1725. Lord King, C.
- 1733. Lord Talbot of Hensol, C.
- 1737. Lord Hardwicke, C., cr. Earl of Hardwicke 1754.
- 1756. Sir J. Willes and others. (Commissioners.)
- 1757. Sir R. Henley, L.K., cr. Lord Henley and of T. 1760, Earl of Northampton 1764.
- 1766. Lord Camden, C.
- 1770. Charles Yorke, C.
- 1770. Sir S. S. Smyther and others. (Commissioners.)
- 1771. Lord Apsley, C., succeeded as Earl Bathurst 1775.
- 1778. Lord Thurlow, C.
- 1783. Lord Loughborough and others. (Commissioners.)
- 1783. Lord Thurlow, C.
- 1792. Sir J. Eyre and others. (Commissioners.)
- 1793. Lord Loughborough, C., cr. Earl of Rosslyn 1801.
- 1801. Lord Eldon, C.
- 1806. Lord Erskine, C.
- 1807. Lord Eldon, C.
- 1827. Lord Lyndhurst, C.
- 1830. Lord Brougham, C.
- 1834. Lord Lyndhurst, C.
- 1835. Sir C. C. Pepsy and others. (Commissioners.)
- 1836. Lord Cottentham, C.
- 1841. Lord Lyndhurst, C.
- 1846. Lord Cottentham, C.
- 1850. Lord Cairns and others. (Commissioners.)
- 1850. Lord Truro, C.
- 1852. Lord St Leonards, C.
- 1852. Lord Cranworth, C.
- 1858. Lord Chelmsford, C.
- 1859. Lord Campbell, C.
- 1861. Lord Westbury, C.
- 1865. Lord Cranworth, C.
- 1866. Lord Chelmsford, C.
- 1867. Lord Cairns, C.
- 1868. Lord Hatherley, C.
- 1872. Lord Selborne, C.
- 1874. Lord Cairns, C., cr. Earl Cairns 1878.
- 1880. Lord Selborne, C., cr. Earl of Selborne 1882.
- 1885. Lord Halsbury, C.
- 1886. Lord Herschell, C.
- 1886. Lord Halsbury, C.
- 1892. Lord Herschell, C.
- 1895. Lord Halsbury, C., cr. Earl of Halsbury 1898.
- 1905. Lord Loreburn, C.

TABLE OF SECRETARIES OF STATE

[The substitution of two secretaries for one was the consequence of the increase of business. There was no distinction of departments, each secretary taking whatever work the king saw fit to entrust him with. During the reigns of the first two Stuarts, however, there was a tendency to entrust one secretary with the correspondence with Protestant states and their allies, and the other with the correspondence with Catholic states. Probably in the reign of Charles II., and certainly as early as 1691, two departments, the Northern and the Southern, were instituted. In 1782 the departments were changed to Home and Foreign. A third secretary of state was appointed in 1794, and he was called the Secretary for War and the Colonies from 1801 to 1854, when the work was divided, and the War and Colonial Secretaryships were instituted. The Secretary of State for

India was appointed in 1854.]			
1603. Sir R. Cecil, cr. Lord Cecil		1717. Earl of Sunderland.	J. Addison.
1603, Viscount Cranborne		1718. Earl Stanhope.	J. Craggs.
1604, Earl of Salisbury		1721. Viscount Townshend.	Lord Carteret.
1605		1724	Duke of Newcastle.
1612. Vacant.		1730. Lord Harrington.	
1614. Sir R. Winwood.	Sir T. Lake.	1742. Lord Carteret, became	
1615.		Earl Granville 1744.	
1618. Sir R. Naunton.	Sir T. Lake.	1744. Earl of Harrington.	
1619.		1746. Earl Granville.	
1623. Sir E. Conway, cr. Lord	Sir G. Calvert.	1746. Earl of Harrington.	
Conway 1625.		1746. Earl of Chesterfield.	
1625.		1748. Duke of Bedford.	
1625. Viscount Dorchester.	Sir A. Morton.	1751. Earl of Holderness.	
1632. Sir F. Windebank.	Sir J. Coke.	1754.	Sir T. Robinson, cr. Baron
1640.		1755.	Grantham 1761
1641. Sir E. Nicholas.	Sir H. Vane.	1756.	H. Fox.
1642.		1761. Earl of Bute.	W. Pitt.
1643.	Viscount Falkland.	1761.	Earl of Egremont.
1643. Interregnum.	Lord Digby.	1762. G. Grenville.	
1643. Sir E. Nicholas.		1763. Earl of Halifax.	Earl of Sandwich.
1662. Sir H. Bennet, cr. Earl	Sir W. Morrice.	1765. Duke of Grafton.	H. S. Conway.
of Arlington 1665.		1766. Duke of Richmond.	
1668.		1766. Earl of Shelburne.	
1672.	Sir J. Trevor.	1768.	Viscount Weymouth.
1674. Sir J. Williamson.	Henry Coventry	1768. Earl of Hillsborough, <i>Colo-</i>	
1678. Earl of Sunderland.		<i>nies.</i>	
1680.		1768. Earl of Rochford.	
1681. Lord Conway.	Sir L. Jenkins.	1770.	Earl of Sandwich.
1683. Earl of Sunderland.		1771.	Earl of Halifax.
1684.	S. Godolphin.	1771.	Earl of Suffolk.
1684.	Earl of Middleton.	1772. Earl of Dartmouth, <i>Colonies.</i>	
1688.	Viscount Preston.	1775. Viscount Weymouth, cr.	
1689. Earl of Shrewsbury.	Earl of Nottingham.	Marquess of Bath 1789.	
1690. Viscount Sidney.		1776. Lord G. S. Germaine, <i>Colo-</i>	
1692. Sir J. Trenchard.		<i>nies.</i>	Viscount Stormont.
1694.	Earl of Shrewsbury.	1779. Earl of Hillsborough, cr.	
1695. Sir W. Trumbull.		Marquess of Downshire 1789	
1697. J. Vernon.		1782. W. Ellis, cr. Baron Mendip,	
1700. Sir C. Hedges.	Earl of Jersey.	1794. <i>Colonies.</i>	
1701.	Earl of Manchester.		
1702.	Earl of Nottingham.		
1704.	R. Harley, cr. Earl of Oxford 1711		
1706. Earl of Sunderland.			
1708.	H. Boyle, cr. Baron Carleton		
1710. Lord Dartmouth, cr. Earl	1714.		
of Dartmouth 1711.	H. St. John, cr. Viscount Boling-		
1713. W. Bromley.	broke 1712.		
1714. J. Stanhope, cr. Earl Stan-	Viscount Townshend.		
hope 1718			

<i>Home Department.</i>		<i>Foreign Department.</i>		<i>War and Colonial Department.</i>	
1794. Duke of Portland		Lord Grenville		H. Dundas, cr. Visc. Melville 1802.	
1801. Lord Pelham, aft. Earl of Chichester		Lord Hawkesbury		Lord Hobart, aft. Earl of	
1803. C. P. Yorke				Buckinghamshire.	
1804. Lord Hawkesbury		Lord Harrowby		Earl Camden.	
1805.		Lord Mulgrave		Viscount Castlereagh.	
1806. Earl Spencer		C. J. Fox		W. Windham.	
1807. Lord Hawkesbury, aft. Earl of Liverpool		G. Canning		Viscount Castlereagh.	
1809. R. Ryder		Earl Bathurst			
1809.		Marquess Wellesley			
1812. Viscount Sidmouth (H. Addington)		Viscount Castlereagh, aft. Marquess of		Earl Bathurst.	
1822. R. Peel		G. Canning [Londonderry]			
1827. W. S. Bourne		Earl of Dudley		Viscount Goderich.	
1827. Marquess of Lansdowne				W. Huskisson.	
1828. R. Peel		Earl of Aberdeen		Sir G. Murray.	[Ripon.]
1830. Viscount Melbourne		Viscount Palmerston		Viscount Goderich, aft. Earl of	
1833.				W. E. S. Stanley aft. Lord Stanley	
				and Earl of Derby.	
1834. Viscount Duncannon, aft. Earl of Bessborough		Duke of Wellington		T. Spring-Rice, aft. Lord Mont-	
1834. H. Goulburn		Viscount Palmerston		Earl of Aberdeen. [eagle.]	
1835. Lord J. Russell				Lord Glenelg.	
1839.				Marquess of Normanby.	
1839. Marquess of Normanby				Lord J. Russell.	
1841. Sir J. Graham, Bart.		Earl of Aberdeen		Lord Stanley.	
1845.				W. E. Gladstone.	
1846. Sir G. Grey		Viscount Palmerston		Earl Grey.	[Hampton.]
1852. Spencer H. Walpole		Earl of Malmesbury		Sir J. S. Pakington, aft. Lord	
1852. Viscount Palmerston		Lord J. Russell		Duke of Newcastle.	

	Home Department.	Foreign Department.	Colonial Department.	War Department.
1855.	Sir G. Grey	Earl of Clarendon	Sidney Herbert	Lord Panmure.
1855.			Lord J. Russell. [Taunton	
1855.			H. Labouchere, aft. Lord	
1858.	S. H. Walpole	Earl of Malmesbury	Lord Stanley	Jonathan Peel.
1858.	Home Department. S. H. Walpole	Foreign Department. Earl of Malmesbury	Colonial Department. Sir E. G. E. L. Bulwer Lytton, cr. Baron Lytton 1866	War Department. Jonathan Peel
1859.	T. H. S. Sotherton- Estcourt			
1859.	Sir G. Cornewall Lewis	Lord J. Russell, cr. Earl Russell 1861	Duke of Newcastle	S. Herbert, cr. Lord Herbert of Lea 1861
1861.	Sir G. Grey			Sir G. C. Lewis.
1863.				Earl de Grey and Ripon, aft. Marquess of Ripon
1864.			E. Cardwell	
1865.		Earl of Clarendon.		
1866.	S. H. Walpole	Lord Stanley, aft. Earl of Derby	Earl of Carnarvon	Jonathan Peel
1867.			Duke of Buckingham	Sir J. S. Pakington, aft. Baron Hampton
1868.	H. A. Bruce, cr. Baron Aberdare 1873	Earl of Clarendon	Earl Granville	E. Cardwell, cr. Vis- count Cardwell 1874
1870.				
1874.	Sir R. A. Cross	Earl Granville	Earl of Kimberley.	G. Hardy
1878.		Earl of Derby	Earl of Carnarvon	F. A. Stanley
		Marquess of Salisbury	Sir M. Hicks Beach, cr. Viscount St Aldwyn 1906	
1880.	Sir W. Vernon Har- court	Earl Granville	Earl of Kimberley	H. C. E. Childers
1882.			Earl of Derby	Marquess of Hartington, aft. D. of Devonshire
1885.	Sir R. A. Cross, cr. Viscount Cross 1886	Marquess of Salisbury.	Sir F. A. Stanley, cr. Baron Stanley of Preston 1886, aft. Earl of Derby	W. H. Smith
1886.				Viscount Cranbrook.
1886.	H. C. E. Childers	Earl of Rosebery.	Earl Granville	H. Campbell-Bannerman
1886.	H. Matthews, cr. Viscount Llandaff 1895	Earl of Iddesleigh	E. Stanhope	W. H. Smith.
1887.		Marquess of Salisbury.	Sir H. T. Holland, cr. Vis- count Knutsford 1895.	E. Stanhope.
1892.	H. H. Asquith	Earl of Rosebery.	Marquess of Ripon	H. Campbell-Bannerman
1894.		Earl of Kimberley		
1895.	Sir M. White Ridley, cr. Viscount Rid- ley 1900	Marquess of Salisbury.	J. Chamberlain	Marquess of Lansdowne
1900.	C. T. Ritchie, cr. Baron Ritchie of Dundee 1905	Marquess of Lansdowne		Hon. W. St J. Brodrick, aft. Viscount Midleton
1902.	A. Akers-Douglas.			
1903.				
1905.	H. J. Gladstone, cr. Viscount Glad- stone 1910	Sir E. Grey	Hon. A. Lyttelton Earl of Elgin	H. O. Arnold-Forster . R. B. Haldane
1908.			Earl of Crewe.	Hon. W. St J. Brodrick. J. Morley, aft. Viscount Morley of Blackburn.
1910.	Winston S. Churchill.			

MINK, a name for certain large species of the zoological genus *Putorius* (Polecat), distinguished by slight structural modifications and semi-aquatic habits. The two best-known species, so much alike in size, form, colour and habits that, although they are widely separated geographically, some zoologists question their specific distinction, are *P. lutreola*, the *Nôrz* or *Sumpftotter* (marsh-otter) of eastern Europe, and *P. vison*, the mink of North America. The former inhabits Finland, Poland and the greater part of Russia, though not found east of the Ural Mountains. Formerly it extended westward into central Germany, but it is now very rare, if not extinct, in that country. The latter is found in places which suit its habits throughout the whole of North America. Another form, *P. sibiricus*, from eastern Asia, of which much less is known, appears to connect the true minks with the polecats.

The name may have originated in the Swedish *maenk* applied to the European animal. Captain John Smith, in his *History of Virginia* (1626), at p. 27 speaks of "Martins, Powlcats, Weesels and Minkes," showing that the animal must at that time have been distinguished by a vernacular appellation from its

congeners. By later authors, as Lawson (1700) and Pennant (1784), it is often written "Minx." For the following description, chiefly taken from the American form (though almost equally applicable to that of Europe) we are mainly indebted to Dr Elliott Coues's *Fur-bearing Animals of North America*, 1877.

In size it much resembles the English polecat—the length of the head and body being usually from 15 to 18 in., that of the tail to the end of the hair about 9 in. The female is considerably smaller than the male. The tail is bushy, but tapering at the end. The ears are small, low, rounded, and scarcely project beyond the adjacent fur. The pelage consists of a dense, soft, matted under fur, mixed with long, stiff, lustrous hairs on all parts of the body and tail. The gloss is greatest on the upper parts; on the tail the bristly hairs predominate. Northern specimens have the finest and most glistening pelage; in those from southern regions there is less difference between the under and over fur, and the whole pelage is coarser and harsher. In colour different specimens present a considerable range of variation, but the animal is ordinarily of a rich dark brown, scarcely or not paler below than on the general upper parts; but the back

is usually the darkest, and the tail is nearly black. The under jaw, from the chin about as far back as the angle of the mouth, is generally white. In the European mink the upper lip is also white, but, as this occasionally occurs in American specimens, it falls as an absolutely distinguishing character. Besides the white on the chin, there are often other irregular white patches on the under parts of the body. In very rare instances the tail is tipped with white. The fur is important in commerce.

The principal characteristic of the mink in comparison with its congeners is its amphibious mode of life. It is to the water that the other weasels are to the land, or martens to the trees, being as essentially aquatic in its habits as the otter, beaver, or muskrat, and spending perhaps more of its time in the water than it does on land. It swims with most of the body submerged, and dives with perfect ease, remaining long without coming to the surface to breathe. It makes its nest in burrows in the banks of streams, breeding once a year about the month of April, and producing five or six young at a birth. Its food consists of frogs, fish, fresh-water molluscs and crustaceans, as well as mice, rats, muskrats, rabbits and small birds. In common with the other animals of the genus, it has a very peculiar and disagreeable effluvium, which, according to Dr Coues, is more powerful, penetrating and lasting than that of any animal of the country except the skunk. (W. H. F.)

MINNEAPOLIS, the largest city of Minnesota, U.S.A., and the county-seat of Hennepin county, situated on both banks of the Mississippi river at the Falls of St Anthony and immediately above St Paul. Pop. (1870), 13,066; (1880), 46,887; (1890), 104,738; (1900), 202,718; (1910 census) 301,408. Of the total population in 1900, those of foreign parentage (both parents foreign-born) numbered 118,946, and there were 61,021 of foreign birth, including 20,035 Swedes, 11,532 Norwegians, 7335 Germans, 5637 English-Canadians, 3213 Irish, 2280 English, 1020 Russians, 1706 French-Canadians and 1133 Austrians. Minneapolis is served by the Chicago, Burlington & Quincy, the Chicago, Great Western, the Chicago, Milwaukee & St Paul, the Chicago & Northwestern, the Chicago, Rock Island & Pacific, the Great Northern, the Minneapolis & St Louis, the Minneapolis, St Paul & Sault Sainte Marie, and the Northern Pacific railways. It has also three terminal switching lines and the belt line of the Minnesota Transfer Company, serving both Minneapolis and St Paul. With St Paul, which is served by the same system of railways, Minneapolis is the chief railway centre of the Northwest and one of the greatest in the United States, being the principal gateway to the commerce of the Canadian and Pacific northwest. There are a Union passenger station, and separate stations for the Chicago, Milwaukee & St Paul, the Chicago, Great Western and the Minneapolis & St Louis railways.

The city is situated on a high plateau (800-850 ft. above sea-level) above the river, and covers an area of about 53 sq. m. It has an extensive system of boulevards, parkways and parks (aggregating 2465 acres in 1908). Among the parks are Loring, near the centre of the city, in which is a statue of Ole Bull; Lyndale, in the south-west part of the city; Interlachen, just north-west of Lyndale; Glenwood, in the west of the city; Van Cleve, Logan, Windom and Columbia in the part of the city east of the Mississippi river; Riverside, on the south-west bank of the Mississippi; and Minnehaha Park, in which are the Minnehaha Falls, a beautiful cascade of the Minnehaha Creek (the outlet of Lake Minnetonka), near the Mississippi, with a fall of 50 ft., well known from Longfellow's poem "Hiawatha." The numerous small lakes in the city (there are about 200 lakes in Hennepin county) have been incorporated in the park system; among them are Lake Harriet (353 acres; in Lake Harriet Park), Lake Calhoun (on which are extensive public baths), Lake Amelia (295 acres), Lake of the Isles (100 acres), Cedar Lake, Powder Horn Lake (in the park of that name) and Sandy Lake (in Columbia Park). Adjoining Minnehaha Park are the grounds (51 acres, given to the state by the city) and buildings of the Minnesota state soldiers' home (1887); and 2 m. beyond the Falls, at the junction of the Minnesota and Mississippi rivers, is

the Fort Snelling Military Reservation (1819). Seven miles south-west of the limits of the city is Lake Minnetonka, one of the most famous summer resorts in the Northwest, a beautiful body of water 15 m. long, with a shore line of 150 m. encircled by undulating wooded hills. Among the most fashionable streets are Mount Curve, Clifton and Park avenues, all in the "West Division" or south-western quarter of the city. The streets in all parts of the city are of exceptional width and heavily shaded in the residential districts. There are handsome residential suburbs. The court-house and city-hall, constructed of red Minnesota granite and completed in 1902 at a cost of about \$3,500,000, is one of the finest municipal buildings in America. Other prominent buildings are the Masonic Temple, the Chamber of Commerce, the Lumber Exchange, the Bank of Commerce, the Auditorium; the buildings of the Metropolitan Life (formerly the Guaranty), the Security Bank, the Northwestern National Bank, the First National Bank, the Andrus, the New York Life, and the Young Men's Christian Association; Hotel Radisson and West Hotel. Minneapolis is the see of a Protestant Episcopal bishopric. On the east side of the river are the buildings of the university of Minnesota (*q.v.*). In Minneapolis are the Minneapolis College of Physicians and Surgeons (1883), the medical school of Hamline University; Augsburg Seminary (Norwegian Lutheran, 1869), the United Church Seminary (1890), the Minnesota College (Swedish, 1905), the Minneapolis Normal School for Kindergartners, the Froebelian Kindergarten Normal School, Graham Hall and Stanley Hall, the Minneapolis School of Music, Oratory and Dramatic Art, and the Northwestern Conservatory of Music. Between Minneapolis and St Paul are the main buildings of Hamline University (Methodist Episcopal, co-educational, 1854). The public library (more than 180,000 volumes in 1908) grew out of a private library, the Athenaeum (1860), was reorganized by Herbert Putnam (librarian from 1887 to 1911), and has several branches, the most notable of which is the Pillsbury Library (1904) on the east side; in its main building (Hennepin Avenue and 10th Street) are the offices of the Minnesota Academy of Natural Sciences (1873), which, with the Society of Fine Arts, assisted in erecting the building in 1884. Among the hospitals and charitable institutions are the Minneapolis city hospital, the state hospital for crippled and deformed children, and Asbury Methodist, the Northwestern, the Deaconess', the Swedish, the St Mary's, the Maternity and the St Barnabas hospitals, Bethany Home, the Catholic orphan asylum, the Washburn orphans' home, the Pillsbury House (1906) where settlement work is carried on by the Plymouth Congregational Church, and several free dispensaries. The first newspaper in the city was the *St Anthony Express*, which began publication in 1851; it is no longer in existence. In 1906 the city had, in addition to numerous weekly and monthly periodicals (English, Norwegian-Danish, Swedish, German, French), four dailies, the *Tribune* (1867), the *Journal* (1878), and the *News* (1903), all in English, and the *Tidende* (Norwegian-Danish), established as a weekly in 1851.

The Mississippi river, which here has an average width of about 1200 ft., is crossed by 17 bridges (9 highway and 8 railway bridges). The Federal government undertook to deepen the channel by dredging and by making two dams and two locks between the Chicago, St Paul, Minneapolis & Omaha railway bridge in St Paul and the Washington Avenue bridge in Minneapolis—a distance of 11.4 m.—from 2 or 3 ft. to 6 ft., and to make the river regularly navigable as far as the Washington Avenue bridge, Minneapolis; the project, first adopted in 1894 and modified in 1907, was 70% completed in July 1908, and up to that time \$1,061,397 had been spent on the work. The enormous water-power of the Falls of St Anthony, yielding about 40,000 h.p., has been the principal factor in making Minneapolis a great manufacturing centre. The rapid erosion of the soft limestone bed at one time threatened the destruction of the power, but this has been prevented by an enormous apron and an artificial concrete floor (completed in 1879). Additional water-power (25,000 h.p.) is derived from Taylor's Falls on the St Croix

river. The proximity of the rich wheatfields of the north-west, and the extensive timber forests, have made Minneapolis the greatest lumber and flour centre in the world. The importance of the flour manufacturing industry was originally due to the excellent water-power available, and dates from the introduction of improved roller-mill methods in the early 'seventies, although there were successful mills in operation twenty years earlier. The enormous flour-mills of Minneapolis (22 in 1907) are perhaps the most interesting sights of the city. Their aggregate daily capacity is over 80,000 barrels, the largest of them having a capacity of 15,000 to 16,500 daily. In 1905 the value of the city's flour and grist mill products was \$62,754,446, 51.6 % of the total value of the city's factory product, and 8.8 % of the value of the flour and grist mill products of the entire United States. Food preparations were valued in 1905 at \$1,361,492. Minneapolis is also the greatest primary wheat market in the world, its 40 or more elevators (of which those of the Washburn-Crosby Company, erected in 1907, are the largest) having a net capacity of about 35,000,000 bushels, and handling more than 90,000,000 bushels in 1908. Its commerce in other grains is also extensive; in the amount of barley received and shipped Minneapolis surpasses any other city in the United States, and in receipts and shipments of rye is second only to Chicago. The Mississippi river above Minneapolis is made to serve, by means of a series of extensive log-booms, as the principal source of supply to the great saw-mills, of which there are here some of the largest in the world, with a combined capacity of 3,500,000 ft. a day, and with an average annual cut of 575,000,000 ft. The total value of the lumber products in 1905 was \$9,960,842 (lumber and timber, \$5,816,726; planing-mill products, including sash, doors and blinds, \$4,144,116). Other important manufactures with the product-value of each in 1905 were malt liquors (\$1,185,525), foundry and machine shop products (\$2,820,697), structural iron-work (\$1,991,771), steam railway car construction and repairing (\$2,027,248), patent medicines (\$1,715,889), furniture (\$1,238,324), cooperage (\$1,415,360), and hosiery and knit goods (\$957,455). The total value of the factory product was \$94,407,774 in 1900, and \$121,593,120 in 1905, an increase of 28.8 %; in 1905 the value of the factory product was 39.5 % of that of the entire state.

Minneapolis is governed under a charter adopted in 1872 (when St Anthony and Minneapolis were consolidated) and frequently amended. It provides for the election of a mayor, treasurer and comptroller for two-years terms; for elected boards of control for library, parks and education, and for a unicameral city council, half of which is chosen every two years for a term of four years. The mayor, whose veto may be nullified by an adverse vote of two-thirds of the council, has very limited appointing powers, the head of the police department being the most important of his appointees. The city council elects the city clerk, city attorney, city engineer, chief of the fire department and most of the minor officers. Under a provision of the charter adopted in 1887 saloons are not permitted outside the "patrol limits of the business district"; so that there are no saloons in the residential districts of the city. The municipality owns the waterworks system, the water supply being obtained from the Mississippi river.

History.—The first recorded visit of a European to the site of Minneapolis was that of Father Louis Hennepin, the French Jesuit missionary, who discovered and named the Falls of St Anthony in 1680; but it is almost certain that he was preceded by some of the adventurous *coureurs des bois*, few of whom left records of their extensive wanderings, and Radisson and Grosseilliers seem to have visited this region two decades before Hennepin. The land on which the city lies, being divided by the Mississippi river, was for many years under different sovereignties, the east side becoming United States territory at the close of the War of Independence, while the west side, after being under Spanish and French rule, did not become a part of the United States until the purchase of Louisiana in 1803. In 1766 the site was visited by the American traveller, Jonathan Carver, 1

and in 1805 by Lieut. Zebulon M. Pike; the military reserve which Pike bought from the Indians included a greater portion of the west side of the present city. After the erection of Fort St Anthony (1819; later called Fort Snelling), a water-power saw-mill was erected (1822) to saw lumber for the fort on the east bank of the river at the Falls of St Anthony. Later flour was also ground in this mill, which thus became the forerunner of the greatest of the city's industries. Gradually as the Indian land titles became extinguished the east bank was settled. The first settlement on the west bank was made by Colonel John H. Stevens in 1850, but the land was not opened to settlers until 1855. The village of St Anthony, on the east side of the river, was incorporated in 1855; Minneapolis, on the west bank, was incorporated in 1856. St Anthony became a city in 1860, and Minneapolis, which then had only 2564 inhabitants, soon outstripped its neighbour after the Civil War, and received a city charter in 1867. In 1870 Minneapolis alone had 13,066 inhabitants (18,079 with St Anthony), and in 1872 the two cities were united under the name of Minneapolis. The Republican National Convention met in Minneapolis in 1892 and renominated President Benjamin Harrison.

AUTHORITIES.—Isaac Atwater, *History of the City of Minneapolis* (2 vols., New York, 1893); G. E. Warner and C. M. Foote, *History of Hennepin County and the City of Minneapolis* (Minneapolis, 1881); Hudson's *Dictionary of Minneapolis and Vicinity* (Minneapolis, annually); A. Morrison, *The Industries of Minneapolis* (Minneapolis, 1885); S. P. Snyder and H. K. Macfarlane, *Historical Sketch of St Anthony and Minneapolis* (Philadelphia, 1856); and C. B. Elliott's "Minneapolis-St Paul" in L. P. Powell's *Historic Towns of the Western States* (New York, 1901).

MINNESINGERS (Ger. *Minnesänger* from *Minne*, love), the name given to the German lyric poets of the 12th and 13th centuries. The term *Minnesang*, strictly applicable to the poems expressing the homage (*Minnedienst*) rendered by the knight to his mistress, is applied to the whole body of lyric poetry of the period, whether dealing with love, religion or politics. The idea of *amour courtois*, with its excessive worship of woman, its minute etiquette and its artificial sentiment, was introduced into German poetry from Provençal literature; but the German *Minnesang* was no slavish imitation of the poetry of the troubadours. Its tone was, on the whole, far healthier and more sincere, reflecting the difference between the simple conditions of German life and the older and corrupt civilization of Provence. The minnesinger usually belonged to the lower ranks of the nobility, and his verses were addressed to a married woman, often above him in rank; consequently the commonest lyric themes are the lover's hopeless devotion and complaints of the lady's cruelty, expressed with a somewhat wearisome iteration. That real passion was sometimes present may be safely assumed, but it was not within the rules of the game, which corresponded fairly closely to the later sonnetting conventions. The poet was not permitted to give the lady's name, or to betray her identity; and a direct expression of passion would also have contravened the rules. The poems were from the first sung in open court to a melody (*Weise*) of the poet's own composing, with the accompaniment of a fiddle or small harp. That the minnesinger was no improvisatore is evident from the complicated forms of his verse, which were partly borrowed from the Provençal, but possibly owed something to the Latin rhymed verse¹ of the wandering scholars. The older songs consisted of a single strophe cast in three divisions, two (known as *Stollen* or *doorposts*) identical in form, stating and developing the argument, the third (*Abgesang*) of different form, giving the conclusion. Later on, two or more strophes were used in a single poem, but the principle of their structure was retained. In this form were cast the *Taseltied*, a dialogue describing the parting of lovers at dawn; and the crusading song. Side by side with these existed the *Spruch*, written in a single undivided stanza, destined for recitation and often cast in the form of a fable. The lay (*Leich*) was written in unequal strophes, each formed of two equal divisions. It was applied in the first instance to sacred lyrics,

¹ See the *Carmina Burana*, ed. J. A. Schmeller, 4th ed., Breslau, 1904.

and was first used in love poems by the Alsatian minnesinger Ulrich von Gutenberg.

The origin of the native lyric, which flourished especially in Austria and Bavaria, is perhaps to be sought in the songs which accompanied dancing. These were not necessarily love songs, but celebrated the coming of spring, the gloom of winter &c., the commonplaces of *Minnesang* throughout the two centuries of its existence. The older lyrics, which date from the middle of the 12th century, are simple in form and written in the ordinary epic metres. The earliest minnesinger whose name has come down to us is Der von Kurenberg (*f. c.* 1160), a scion of an Austrian knightly family whose castle lay on the Danube, west of Linz. These songs, however, contradict the root idea of *Minnedienst*, since the lady is the wooer, and the poet, at the most, an acquiescent lover. They take the form of laments for an absent lover, complaints of his faithlessness and the like. Among the other Austrian and south German lyrists who show small trace of foreign influence was Dietmar von Aist (*d. c.* 1171), though some of the songs attributed to him seem to be of later date. While the love-song remained in the hands of noble singers, the *Spruch* was cultivated by humbler poets. The elder of the two or three poets concealed under the name of Spervogel was a wandering singer who found patronage at the court of the burgraves of Regensburg, one of whom himself figures among the earlier minnesingers.

The characteristic period of German *Minnesang* begins at the close of the 12th century with the establishment of the Provençal tradition in western Germany through the poems of Heinrich von Veldeke and Friedrich von Hausen. National elements abound in Veldeke's songs, although the *amour courtois* dominates the whole; Friedrich von Hausen (*d.* 1190) followed Provençal models closely. The long crusading song *Sie darf mich des Zihen niet*, is a good example of his powers. A close disciple of the troubadours Peire Vidal and Folquet de Marseille was the Swiss *Chunt* Rudolf von Fenis.¹ The greatest name among the earlier minnesingers is that of Heinrich von Morungen, a Thuringian poet who lived on in popular story in the ballad of "The Noble Moring." He brought great imaginative power to bear on the common subjects of *Minnesang*, and his poetry has a very modern note. The formal art and science of *Minnesang* reached full development in the subtle love-songs of Reinmar, the Alsatian "nightingale of Hagenuau." Uhlend aptly called him the "scholastic philosopher of unhappy love." As a metrist he developed a greater correctness of rhyme, and a better handling of German metres. He became a member of the court of Duke Leopold V. (*d.* 1194) of Austria, and there Walther von der Vogelweide (*q. v.*) was first his disciple, and then perhaps his rival. Walther, the greatest of medieval German lyric poets, had Reinmar's technical art, but in feeling was more nearly allied to Morungen. He raised the *Spruch* to the dignity of a serious political poem, which proved a potent weapon against the policy of Innocent III. In 1202 at the court of Hermann, landgrave of Thuringia, he met Wolfram von Eschenbach, who is said to have taken part in the tourney of poets known as the *Wariburgskrieg*, made world-famous through Wagner's *Tannhäuser*. The *Tagelieder* of Wolfram give him a high place in *Minnesang*, although his fame, like that of Heinrich von Veldeke and Hartmann von Aue, chiefly rests on his epics. A new style—called by Lachmann *höfische Dorfpoesie*—was marked out by Neidhart von Reuenthal (*d. c.* 1240), who belonged to the lesser Bavarian nobility. He wrote songs to accompany the dances of the village beauties, and comic and realistic descriptions of village life to please the court. He was acknowledged by the Meistersinger as one of the twelve masters of song. Nevertheless, with him the decadence may be said to have begun.

The Styrian poet Ulrich von Lichtenstein (*d. c.* 1275) unconsciously caricatured chivalry itself by his *Frauedienst*, in which he relates the absurd feats which he had undertaken at his lady's command, while Steinmar (*f.* 1276) deliberately parodied

¹ Rudolf II., count of Neuenburg (*d.* 1196), or, according to some, a nephew of his who died in 1257.

court poetry in his praises of rustic beauty and good living. In the lays, songs and proverbs of Tannhäuser something of both elements, of the court and the village, is to be found. He seems to have lived as a wandering singer until 1268, and there very soon grew up round his name the Tannhäuser myth which has so little foundation in his life or poetry. The Austrian poet Reinmar von Zweter (*d. c.* 1260) left some hundreds of *Sprüche* political or social in their import. Among the princes who practised *Minnesang* were the emperor Henry VI., though the two songs preserved under his name are of doubtful authenticity, Duke Henry IV. of Breslau (*f.* 1270-1290), King Wenceslaus II. of Bohemia, the margrave Otto IV. of Brandenburg, Wizlaw IV., prince of Rügen and the unhappy Conrad, the last of the house of Hohenstaufen, beheaded by the order of Charles of Anjou before he reached his seventeenth year.

The didactic motive came more and more to the front in the 13th century. The wandering Swabian poet Marner (*d. c.* 1270) cultivated especially the *Spruch*, laughed at the Provençal and courtly tradition, and there is no very great step from his learning and his feuds to the conditions of *Meistersang*. Heinrich von Meissen (1250-1310), known as "Frauenlob" ("ladies'praise"), was one of the last minnesingers, and his pedantry and virtuosity entitle him to be called the first meistersinger.

BIBLIOGRAPHY.—The chief MSS. containing the work of the 300 or more minnesingers whose work has been partially preserved, are the old Heidelberg MS. (13th century), the Weingarten—Stuttgart MS. (14th century) and the Great Heidelberg MS. (14th century), formerly known as the Manasse MS. This last is the most comprehensive of all. The collection on which it is based was made by Rüdiger Manasse (*d.* 1304) and his son Johannes at Zürich. It is quaintly illustrated with imaginary portraits of the poets (that of Hartmann von Aue in full armour with closed visor) and pictures of their coats of arms. It was printed by F. Pfaff (Heidelberg, 1809). The complete collection of the minnesingers' verses is F. H. von der Hagen, *Deutsche Liederdichter des zwölften, dreizehnten und vierzehnten Jahrhunderts* (4 vols., Leipzig, 1838), vol. iv. of which contains biographical matter and a discussion of the music; K. Lachmann and M. Haupt, *Des Minnesangs Frühling* (3rd ed., edited F. Vogt, Leipzig, 1882) is a collection of the minnesingers earlier than Walther von der Vogelweide; there is a comprehensive selection of 97 minnesingers by Karl Bartsch, *Deutsche Liederdichter des zwölften bis vierzehnten Jahrhunderts* (ed. W. Golther, Berlin, 1901) with bio-bibliographical account of individual minnesingers; see also F. Pfaff, *Der Minnesang der 12 bis 14 Jahrhunderte*, pt. i. (Stuttgart, 1892). English translations of early German lyrics are F. C. Nicholson, *Old German Love Songs*, translated from the minnesingers of the 12th to 14th centuries (London, 1907). See also WALTHER V. D. VOGELWEIDE.

Of historical and critical work on the minnesingers, see K. Goedeke, *Geschichte der deutschen Dichtung*, vol. i. (Dresden, 1881); H. Paul, *Grundriss der germanischen Philologie*, vol. ii. (Strasbourg, 2nd ed., 1901), where further references will be found; also A. E. Schönbach, *Die Anfänge der deutschen Minnesänger* (Graz, 1898); F. Grimme, *Geschichte der Minnesänger*, vol. i. (Paderborn, 1892); K. Burdach, *Reinmar der Alte und Walther von der Vogelweide* (Leipzig, 1880); A. Schultz, *Das höfische Leben zur Zeit der Minnesänger* (2nd ed., Leipzig, 1889); J. Falke, *Die ritterliche Gesellschaft im Zeitalter des Frauencultus* (Berlin, no date).

MINNESOTA, a North Central State of the United States of America. It is bounded on the S. by Iowa, on the W. by South and North Dakota—the Red River (commonly called the Red River of the North) separating it from the latter state—on the N. by the Canadian provinces of Manitoba and Ontario, being separated from the latter by the Lake of the Woods, Rainy River and Rainy Lake, and certain of their tributaries and outlets, and on the E. by Lake Superior and by Wisconsin, from which it is separated for the greater part of the distance by the Mississippi and St Croix rivers. It is the tenth state in size in the Union, with a total area of 84,682 sq. m., of which 3824 sq. m. are water surface.² From north to south it is about 400 m. in length, extending from 43° 30' to 49° 25' 55" N. lat., and from east to west its width is about 354 m., lying between long. 80° 29' and 97° 15' W.

The north-east part of the state is included in the Great Lakes Province, and the southern and western parts are in the Prairie Plains Province. The whole area of the state was formerly a complexly folded mountainous region of strong relief, which was

² In addition the state contains approximately 2514 sq. m. of Lake Superior.

afterwards worn down to a more nearly level surface, except in the extreme north-east corner, where ridges of harder rock resisted erosion. Marine deposits were laid down over the south of the state after a submergence of the region; an uplift afterwards made of these deposits a coastal plain. The rather level surface of the "worn down mountains" of the north of the state and the coastal plain beds of the southern and western parts are now dissected by rivers, which make most of the state a rolling or hilly country, without strong relief. The average elevation is about 1275 ft. above sea-level or 600 ft. above the surface of Lake Superior. An extensive water-parting in the north central part of the state, an elevation whose inclination is almost imperceptible, determines the course of three great continental river systems. From this central elevation the land slopes off in all directions, rising again in the extreme north-east corner, where the rugged granite uplift in Cook county, known as the Misquah Hills, reaches an altitude of 2230 ft., the highest point in the state; and in the south-west corner, where an altitude of 1800 ft. is reached in the Coteau des Prairies. Only in the valleys of the Red, Minnesota and Mississippi rivers does the elevation fall below 800 ft. In the southern and central portions of the state open rolling prairies interspersed with groves and belts of oak and other deciduous hard-wood timber predominate. A little north of the centre the state is traversed from north-west to south-east by the extensive forest known as the "Big Woods," in which also oak occurs most frequently. In the northern part of the state the great pine belt stretches from the head of Lake Superior westward to the confines of the Red River Valley, while along the north border and in the north-east the forest growth is almost exclusively tamarack and dwarf pine. More than three-fourths of the area of the state is arable, the small percentage of non-arable land lying principally in the north-eastern regions, which afford compensation in the form of rich mineral deposits. Of the three great continental river systems above mentioned, the Red River and its tributaries drain the western and west central slope northward through Lake Winnipeg into Hudson Bay; the other two being the St. Lawrence system, to which the St. Louis River and its branches and several smaller streams flowing into Lake Superior contribute their waters by way of the Great Lakes and the Mississippi, which with its tributaries drains about two-thirds of the state into the Gulf of Mexico. A few rivers in the south drain into the Mississippi through Iowa, while a smaller area in the extreme north is drained through the Lake of the Woods and Rainy Lake into Hudson Bay. These river systems serve the threefold purpose of drainage, providing water communications (there being about 3000 m. of navigable waters in the state), and, by falls and rapids caused by glacial displacement of rivers, furnishing a magnificent volume of water-power. The Mississippi river, which flows for about 800 m. within or along the borders of the state, has its principal sources in and near Lake Itasca. It affords facilities for the transport of logs by means of booms above Minneapolis, and is navigable below St. Paul; being half a mile broad where it reaches the border of the state at Hastings. At the Falls of St. Anthony, St. Cloud, Little Falls and other places, it provides ample water-power for manufacturing purposes. Its two principal tributaries are the St. Croix and the Minnesota. The first, after having for about 135 m. (about 50 being navigable) formed the boundary between Wisconsin and Minnesota, enters the Mississippi at Hastings; the second, rising in Big Stone Lake on the western border, but 1 m. from Lake Traverse, the source of the Red River, enters the Mississippi from the south-west between St. Paul and Minneapolis after a course of about 450 m., about 240 of which are navigable at high water. Both furnish valuable water-power, which is true also of the Cannon and Zumbro rivers flowing into the Mississippi below Hastings. The Red River, which forms the western boundary of the state for more than half its distance, has its source in Lake Traverse. Its most important branch is the Red Lake River, and both are navigable for vessels of light draught at high water. In the south the western fork of the Des Moines River, flowing for 125 m. through the state,

is navigable for 20 m. Glacial action determined the direction and character of the rivers, made numerous swamps, and, by scouring out rock basins, damming rivers and leaving morainal hollows, determined the character and formation of the lakes, of which Minnesota has upwards of 10,000, a number probably exceeding that of any other state in the Union. The general characteristics of the lakes in the north differ from those of the south, the former being generally deep, with ragged rocky shores formed by glacial scouring which caused rock basins, the latter being mostly shallow. The most interesting feature of the glacial epoch is the extinct Lake Agassiz, which the receding ice of the later glacial period left in the Red River Valley of Minnesota, North Dakota and Manitoba. This lake drained southward into the Gulf of Mexico via the Minnesota and Mississippi rivers, until the ice sheet which had prevented its natural drainage to the north had melted sufficiently to allow it to be drained off into Hudson Bay by way of the Nelson River. The remarkably level character of the Red River district is due to horizontal deposits in the bottom of this lake, which have been little dissected by river erosion. The largest of the present lakes, Red Lake, in Beltrami county, has an area of 342 sq. m. Other large lakes are Mille Lacs (198 sq. m.) in Mille Lacs and Aitkin counties; Leech Lake (184 sq. m.) in Cass county; Lake Winnibigishish (82 sq. m.) in Itasca county; and Vermilion Lake (66 sq. m.) in St. Louis county. On the northern boundary are the Lake of the Woods (612 sq. m.) and Rainy Lake (148 sq. m.), draining northwards into Hudson Bay. The beautiful "Park Region," centring in Ottertail county, contains several thousand lakes. Several large lakes such as Pepin, Traverse and Big Stone are river expansions. The state supports three parks—Itasca state park (22,000 acres, established in 1891), about the sources of the Mississippi, in Clearwater, Becker and Hubbard counties; the St. Croix (established in 1895), in Chicago county, across the St. Croix from the Wisconsin state park of the same name, and including the beautiful Dalles of the St. Croix; and the Minneopa state park (established in 1905), containing Minneopa Falls, near Mankato.

Flora and Fauna.—The flora and fauna are similar to those of the other states of the same latitude. The rapid settling of the state drove its native fauna, which comprised buffalo, deer, moose, bear, lynx and wolves, in great numbers into the northern sections, westward into Dakota, or across the Canadian border. Deer and moose are still found in the state. The preservation of game is now enforced by stringent game laws, administered by an efficient state Game and Fish Commission. The fisheries, which are of great value, are carefully supervised and systematically replenished from the State Fish Hatchery at St. Paul, and the Federal Fish Hatchery maintained at Duluth, in which particular attention is devoted to the fish of Lake Superior. Minnesota ranked third among the states of the Union in 1900 in the production of lumber, but in 1905 was fifth, the supply having diminished and the industry having been developed in the states of Washington and Louisiana. The danger of loss from forest fires, such as that of 1894, emphasized the necessity of forest preservation, and resulted (1895) in the creation of a special state department with a forest commissioner and five wardens with power to enforce upon corporations and individuals a strict observance of the forestry laws, the good effects of the law being evidenced by the fact that the fire losses in forest lands for the first twelve years of its operation averaged only \$31,000 a year. Furthermore, in order to encourage the growth and preservation of the forests, and to create systematically forest reserves, the legislature established in 1899 a State Forestry Board. There are two national forest reserves, with an aggregate area of 1882 sq. m.

Climate.—Minnesota has the characteristic climate of the North Central group of states, with a low mean annual temperature, a notably rarefied atmosphere that results in an almost complete absence of damp foggy weather, and an unusual dryness which during the rather long winters considerably neutralizes the excessive cold. The cold increases not only from south to north, but to some extent from east to west. The mean annual temperature, according to the reports of the U.S. Weather Bureau, varies from 45° F. at St. Paul and points in the south of the state to 37° F., at points in the north-east and as far south-west as Moorhead, Clay county. In the south the season is usually without killing frost from early in May to late in September, but in the north it is not uncommon late in May or early in September. The amount of rain decreases from east to west, the mean annual rainfall being 32.7 in. at Grand Meadow in the south-east and 33.3 in. at Mount Iron in the north-east, but less than 25 in. at several points of observation in the western half of the state. In all sections about as

much, or even more, rain falls in summer as in both autumn and winter, and the summer rains, together with the long summer days, are very favourable to a rapid growth and early maturity of crops. Nearly the whole state is usually covered with snow during the greater part of winter, and the mean annual fall of snow varies from about 52 in. at points in the north-east to less than 25 in. in the south-west. In most localities the prevailing winds are north-westerly in winter and southerly in summer, but at Duluth, on the shore of Lake Superior, they are south-westerly during November, December and January and north-east during all other months.

Soil and Minerals.—The surface drifts of the greater part of the state, which are almost wholly of glacial origin, have provided Minnesota with a remarkably fertile soil. It consists largely of a dark brown or black sandy loam, finely comminuted, the richness of which in organic matter and mineral salts induces rapidity of growth, and the strength and durability of which render it capable of a long succession of crops. This soil prevails throughout the southern counties and the Minnesota and Red River valleys, in which sections cereal crops predominate. Toward the central part of the state there is a somewhat less fertile sandy soil, which is devoted more largely to potatoes and similar crops. The non-arable north-east portion of the state is covered with a coarse granite drift. Underneath the surface are beds of sand, gravel and clays, the last affording material for the manufacture of brick, tiles and pottery. The rock formations of the state furnish building stones of great value.

Minnesota ranked first among the states in 1902 in the production of iron ore. Although the iron ranges in the north-east had been explored about 1860, it was not known to contain a great wealth of iron, it was not until 1884 that mining was actually begun on the Vermilion Range. Since that date the development of iron mining in Minnesota has been remarkable, and the increase both in volume and value of the output has been practically uninterrupted. Eight years later (1892) the much richer Mesabi Range, the most productive iron range in the world, was opened up; it soon surpassed the Vermilion in its output, and by 1902 the product was nearly ten times greater. The ore, which in many places is found in an almost pure state, is at or near the surface and the process of mining is one of great simplicity and ease. The quality of ore in the two ranges differs somewhat, that mined on the Vermilion Range being a hard specular or red haematite, while that taken from the Mesabi Range, largely red haematite, is much softer and in many localities quite finely comminuted.

Agriculture.—The principal industry of Minnesota is agriculture. Large areas of swamp lands in the central and north central parts of the state once counted non-arable have been drained and reclaimed. There were in 1900 154,659 farms aggregating 26,248,498 acres, of which 70.3% was improved land; in the value of farm property was \$788,684,642, an increase in value of \$373,983,016, or 47.5% since 1900, and the value of the value of the manufactured animals of farms and ranges was \$86,620,643. The total value of farm products for the year 1899 (consensus of 1900) was \$161,217,304. Geographically the wheat-raising area extends across the entire south of the state—the Minnesota Valley and the Red River Valley—the rich glacial loam of which renders it one of the most productive wheat regions in the world. Other important crops in the order of their value are oats, hay and forage, Indian corn, barley, flax-seed, potatoes, rye, grass seeds, wild grass, clover, beans, peas, and miscellaneous vegetables and orchard products. Both fruit-raising and dairying interests are centred principally in the southern half of the state.

Manufactures and Commerce.—The extraordinary numbers of utilizable water-powers, the unusual transport facilities affording ample means of reaching the great markets, and finally the proximity to the raw materials of manufacture, have made Minnesota of great importance as a manufacturing state. The federal census showed for the decades 1880–1890 and 1890–1900 an increase in the number of manufacturing establishments from 3493 in 1880 to 7505 in 1890, and 11,114 in 1900. During the same period the capital invested increased from \$7,604,811 in 1880 to \$127,686,618 in 1890 and \$165,832,246 in 1900, and the value of the manufactured products increased from \$76,065,198 in 1880 to \$192,033,478 in 1890 and \$262,655,881 in 1900. The wonderful development of Minnesota as a flour-producing state began with the introduction of improved roller processes after 1870. Minneapolis is the chief flour-making centre of the world, and the cities at the "Head of the Lakes" (Duluth, Minnesota, and Superior, Wisconsin, considered industrially as one place) constitute the second largest centre. The towns of the Red River Valley, which are nearer to the great wheat belt, give promise of developing into great flouring cities. Next to flour, grain and animal products rank in importance. Other manufactures of importance are butter, cheese and condensed milk, packed meats and other slaughter-house products, steam railway cars, foundry and machine-shop products, linseed oil, malt liquors, planing-mill products, sash, doors and blinds, boots and shoes, and agricultural implements. As compared with other states of the Union Minnesota ranked third in 1900 and fifth in 1905 in lumber; sixth in 1900 and fifth in 1905 in cheese, butter and condensed milk; eighth in 1900 and in 1905 in agricultural implements; and fourth in 1900 and eighth in 1905 in planing-mill products.

For an inland state Minnesota is exceptionally well situated to play a chief part in the commercial life of the country, and various causes combine to make it important in respect to its interstate and foreign trade. It is the natural terminal of three great northern transcontinental railway lines—the Northern Pacific, the Great Northern, and the Chicago, Milwaukee & Puget Sound (the extension of the Chicago, Milwaukee & St Paul system); and the Chicago, Burlington & Quincy and the connecting lines of the Canadian Pacific form lines of communication with the middle Northwest and the Pacific provinces of Canada. Seven navigable rivers within or on the borders of the state—the Red River of the north, the Red Lake River, Rainy River, the Minnesota, the Mississippi, the St Croix and the St Louis—give facilities for transport by water that exert an important competing influence on freight charges; and at the "Head of the Lakes" (Duluth-Superior) many lines of steamships on the Great Lakes, providing direct or indirect connexion with the Eastern and Southern states, make that port in respect to tonnage the first in the United States. This combination of natural and artificial highways of commerce derives an additional importance from the character of the regions thus provided with transport facilities, which renders its cities the principal distributing centres both for the entire Northwest for coal shipped via the Great Lakes, and also for the eastern and middle Western states for the great staples, wheat and lumber, derived either from Minnesota itself or by means of its great transcontinental railways from the neighbouring Northwestern states and Canadian provinces. Iron shipments from the Mesabi and Vermilion ranges, cereals from the Northwest, fruits and vegetables from the Pacific coast, and Oriental products obtained via the great northern railways, are also elements of great importance in the state's commerce. There were on the 31st of December 1908 8438.73 m. of railway within the state. St Paul and Duluth are ports of entry.

Population.—The population of Minnesota at the first Federal census (1860) after its admission into the Union was 172,023, and by the succeeding Federal enumerations it was: (1870), 439,700; (1880), 780,773; (1890), 1,301,826, excluding Indians (10,096); (1900), 1,757,394; (1910) 2,075,708.² Of the total population in 1900, 932,490, or 53.2%, were males, and 818,904, or 46.8%, females; 1,246,076 were native-born; 505,318, or 28.9%, were foreign-born, and 1,312,019 were of foreign parentage (i.e. having either one or both parents foreign-born). Of the 14,358 coloured inhabitants, 4959 were negroes and 9182 Indians, 8457 of whom lived on reservations. The urban population (i.e. inhabitants of cities of 8000 or over) was 26.8% of the total population, as compared with 28.2% in 1890. By the state census of 1905 the population of the principal cities was as follows: Minneapolis, 261,954; St Paul, 197,023; Duluth, 64,942; Winona, 20,334; Stillwater, 12,435; and Mankato, 10,996; by the same census four other cities, all in the mining region in the north-east, had passed the 5000 limit, viz. Hibbing, 6566; Cloquet, 6117; Virginia, 5056; and Eveleth, 5332. The density of population increased from 16.5 per sq. m. in 1890 to 22.1 in 1900. The largest religious denomination in the state in 1906 was the Roman Catholic, with 378,288 communicants out of a total of 834,442 members of all religious denominations; there were 267,322 Lutherans, 47,637 Methodists, 27,569 Presbyterians, 24,309 Baptists, 22,264 Congregationalists, and 18,703 Protestant Episcopalians.

Government.—The state is governed under the constitution adopted on the 13th of October 1857 and frequently amended. By an amendment of 1898 an amendment may be suggested by a majority of both houses of the legislature and comes into effect if approved by a majority of all electors voting at the general election at which the amendment is voted upon; if two or more amendments are submitted at the same election voters shall vote for or against each amendment separately. For the revision of the constitution it is necessary that two-thirds of the members elected to each house of the legislature vote for the call of a constitutional convention, that a majority of all electors voting at the next general election approve the call for the convention, and that the convention consist of as many members as the house of representatives, who shall be chosen in the same manner, and shall meet within three months after the general

¹ At International Falls on Rainy River and at Duluth on the St Louis immense water-power is utilized for manufacturing.

² By the state census of 1905 the total population was 1,979,912 (1,066,412 males and 909,275 females—excluding Indians from the sex classification), of whom 537,041 were foreign-born, 10,929 were Indians, 5113 were negroes, 171 were Chinese, and 50 were Japanese.



MINNESOTA

Scale, 1:1,830,000
English Miles

Railways
County Seats
County Boundaries
Indian Reservations

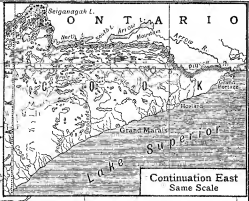

Environments of ST. PAUL and MINNEAPOLIS

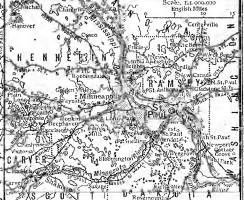

Longitude West of Greenwich

election at which it is voted. The executive department consists of a governor, lieutenant-governor, secretary of state, treasurer and attorney-general, elected biennially in November of the even-numbered years, and an auditor elected at the same time every four years. The veto power of the governor (since 1876) extends to separate sections of appropriation bills. The judicial department comprises a supreme court consisting of a chief justice and (since 1881) four associate justices elected for terms of six years, and lower courts consisting of district courts with original jurisdiction in civil cases in law and equity, and in criminal cases upon indictments by grand juries; justices' courts, in which the amount in litigation cannot exceed \$100, or the punishment cannot exceed three months' imprisonment or a fine of \$100; and of municipal and probate courts with the usual jurisdictions. The legislative department consists of a senate of sixty-three members elected for four years, and a house of representatives of one hundred and nineteen members, elected for two years, the remuneration being mileage and \$500 a year. The reapportionment of congressional, senatorial and representative districts is made in the first legislative session after the state census, which has been taken in every tenth year since 1865. The legislature meets biennially in odd-numbered years, the session being limited to ninety days by a constitutional amendment of 1888. A majority of all the members elected to each house is required for the passage of a bill, and a two-thirds majority is necessary to pass a bill over the governor's veto. All bills for raising revenue must originate in the House of Representatives, but the senate may propose and concur with amendments as on other bills. Expenditures from the fund known as "The Internal Improvement Land Fund," derived from the sale of state lands, can be made only after the enactment for that purpose has been approved by the voters of the state; in 1881 the legislature, and in 1884 the popular vote, pledged the proceeds of this fund to the payment of Minnesota state railway adjustment bonds. Taxation must be uniform only within classes of property prescribed by the legislature. An Australian ballot law was enacted in 1891; the qualifications for electors (adopted in 1896) require that the voter be at least twenty-one years old, that he shall have been a full citizen of the United States for three months prior to the election, and shall have lived in the state six months and in the election district thirty days. Women (since 1898) may vote for school officers and members of library boards, and are eligible for election to any office pertaining to the management of schools or libraries. A constitutional amendment in regard to local government adopted in 1898 provides that any city or village, by a four-sevenths vote of its electors, may adopt a charter drawn by a commission (appointed by the local district judges) and proposed by such commission within six months of its appointment.

An amendment to the constitution adopted in November 1888 declares that any combination or pool to affect the markets for food products is a "criminal conspiracy, and shall be punished in such manner as the legislature may provide."

A homestead which is owned and occupied by a debtor as his dwelling place is exempt from seizure or sale for debts other than taxes, those secured by a mortgage on it, or those incurred for its improvement or repair, or for services performed by labourers or servants. But a homestead so exempted may not be larger than one-fourth of an acre if it is in an incorporated place having a population of 5000 or more, than half an acre if it is in an incorporated place having a population of less than 5000, or than eighty acres if it is outside an incorporated place. In case the owner is married the homestead cannot be sold or mortgaged, except for an unpaid portion of the purchase money, without the joinder of husband and wife, and if the owner dies leaving a spouse or minor children, the homestead with its exemptions descends to the surviving member or members of the family. If the owner is a husband and he deserts his family, the wife and minor children may retain the homestead. Under the laws of the state the legal existence and legal personality of a woman are not affected by marriage, and the property rights of a husband and wife are nearly equal. A husband may, however, convey his real estate, other than a homestead, by his separate deed, whereas a wife's deed for her real estate is void without the joinder of her husband. If either husband or wife dies intestate and there are no descendants the whole of the estate passes to the survivor; if there are descendants the surviving spouse has the use

of the homestead for the remainder of his or her life, an absolute title to one-third of the other real estate of the deceased, and to personal property limited to \$1000 besides wearing apparel. The grounds for an absolute divorce in Minnesota are adultery, impotence, cruel and inhuman treatment, sentence to state prison or state reformatory subsequent to the marriage, desertion or habitual drunkenness for one year next preceding the application for a divorce. Before applying for an absolute divorce the plaintiff must have resided in the state for the year next preceding, unless the cause of action is adultery committed while the plaintiff was a resident of the state. A wife may at any time sue for a limited divorce from her husband on the ground of cruel and inhuman treatment, or of such conduct as to render life with him unsafe and improper, or of abandonment and refusal or neglect to provide for her, if both parties are inhabitants of the state or their marriage took place in the state. A law of 1909 provides for a women's and children's department in the state bureau of labour.

The sale of intoxicating liquors is for the most part regulated by licenses, but the granting of licenses may be prohibited within any town or incorporated village by its legal voters, and the question must be submitted to popular vote upon the request of ten legal voters.

Pauper and Charitable Institutions.—The charitable and correctional institutions of Minnesota have been since 1901 under the supervision of a State Board of Control consisting of three paid members appointed by the governor and serving for terms of six years; this board supplanted an unpaid Board of Corrections and Charities established in 1883, and the boards of managers of separate institutions (except the schools for the deaf and the blind at Faribault, and the state public school at Owatonna) and of groups of institutions were abolished. The state institutions consist of state hospitals for the insane at St Peter (1866), at Rochester (1877), established originally as a state inebriate asylum under a law taxing liquor dealers for that purpose, which was subsequently held to be unconstitutional, atergus Falls (1887), at Anoka (1900) and at Hastings (1900); the state institute for defectives at Faribault, consisting of the schools for the deaf (1863), blind (1874) and feeble-minded (1879); the state public school for dependent and neglected children at Owatonna (1886); a sanatorium for consumptives at Walker; a hospital for indigent, crippled or deformed children (1907) at St Paul; the state training school for boys near Red Wing; a similar industrial school for girls (established separately in 1907) at Sauk Center; the state reformatory at St Cloud (1887), intermediate between the training school and the state prison, for first offenders between the ages of sixteen and thirty years, in which indeterminate sentences and a parole system are in operation; the state prison at Stillwater (1851), in which there is a parole system and a good school, consisting of the governor, state superintendent, and in which, up to 1895, prisoners were leased under contract (especially to the Minnesota Thresher Company), and since 1895 have been employed in the manufacture of shoes and of binding twine, and in providing for the needs of the prison population; and the state soldiers' home occupying fifty-one acres adjoining Minnehaha Park in Minneapolis. By an act of 1907 the Board of Control was empowered to establish a hospital for inebriates.

Education.—The state supports a highly efficient public school system, organized through all the grades from the primary district and rural schools to the state university. At the head of the system stands the state superintendent of public instruction, appointed by the governor; there are also county superintendents; and at the high school board, consisting of the governor, state superintendent and the president of the state university, has general supervision of the schools and apportions the state aid. The schools are supported by a state tax, and by the proceeds of a permanent school fund amounting (in 1908) to \$19,709,383; in the same year the total value of all public school property was \$28,297,420, with an aggregate debt of \$6,329,794, and \$13,463,211 was spent for public educational purposes. There are state normal schools at Winona (1860), Mankato (1868), St Cloud (1869), Moorhead (1888) and Duluth (1902). The university of Minnesota at Minneapolis was projected by the Territorial Legislature of 1851. Some ground was purchased for its campus in 1854, but it was actually founded by an act of 1864, amended in 1866, 1868 and 1872. It is governed by a board of twelve regents, of whom the president of the university, the governor of the state and the state superintendent of public instruction are members *ex officio*, and the other nine, holding office for six years, are appointed by the governor with the advice and consent of the senate. The university is supported by a state tax of 0-23 mills per dollar on the taxed property of the state, by special appropriations from the state (for "deficiency," for School of Mines, and for salaries of teachers in the department of mines and engineering), by the interest on state bonds and land contracts purchased with the proceeds of Federal land grants under the Morrill Act of 1862, by Federal appropriations under the Morrill Act of 1890 and the Hatch Act, and by students' fees, &c.; the total of this income was estimated in 1906-1907 at \$628,500. The act of 1872 provided for a board of trustees or departments of the university, of science, literature and the arts, which offers (for the degree of Bachelor of Arts) a four-years course, is entirely elective (except that a certain number of "long courses" must be selected) after the first year, and in which the

only restriction is upon the range of subjects from which the student's choice may be made; a college of agriculture (including military tactics), which is now a "department," including a college and a school of agriculture, a short course for farmers, a dairy school, the Crookston school of agriculture, a main experiment station at St Anthony Park, between Minneapolis and St Paul, and sub-stations 1 m. north of Crookston and 2 m. east of Grand Rapids; a college of mechanic arts, now called the college of engineering and the mechanic arts, which offers four-year courses in civil, mechanical, electrical and municipal engineering, a four-year course in science and technology, leading to the degree of Bachelor of Science, and graduate work leading to the degree of Master of Science; the college of law, a three-year course, with evening classes and graduate courses; a college of medicine, which is now the college of medicine and surgery (1888), and the college of homoeopathic medicine and surgery (1889), each with four-year courses, and each (since 1903) with a course of six years partly in the college of science, literature and the arts, and partly in the medical college and leading to the degrees of Bachelor of Science and Doctor of Medicine. In addition to these departments provided for in the organic act, the university included in 1909 colleges of dentistry (three-year course), pharmacy (two-year and three-year courses), a school of mines (1891; four-year course, leading to the degree of Engineer of Mines or Metallurgical Engineer), a school of analytical and applied chemistry (four-year courses, leading to the degree of Bachelor of Science), the library of Minneapolis and St. Paul, in 1908-1909 the faculty numbered about 325 and the total enrollment of students was 4421. Other higher educational institutions in Minnesota are Hamline University (Methodist Episcopal), with a college of liberal arts at St Paul, and a college of medicine at Minneapolis; Macalester College (Presbyterian) at St Paul; Augsburg Seminary (Lutheran) at Minneapolis; Carleton College (non-sectarian, founded in 1866) and St Olaf College (Lutheran, founded in 1874) at Northfield; Gustavus Adolphus College (Lutheran) at St Peter; Parker College (Free Baptist, 1888) at Winnebago City; St John's University (Roman Catholic) at Collegeville, Stearns county; and Albert Lea College for women (Presbyterian, founded 1884) at Albert Lea.

History.—The first European visitors to the territory now embraced in the state of Minnesota found it divided between two powerful Indian tribes, the Ojibways or Chippewas, who occupied the heavily wooded northern portion and the region along the Mississippi river, and the Sioux or Dakotas, who made their homes on the more open rolling country in the south and west and in the valley of the Minnesota. The first known white explorers were Radisson and Groselliers, who spent the winter of 1658-1659 among the Sioux in the Mille Lacs region. At Sault Sainte Marie in 1671, before representatives of fourteen Indian nations, the Sieur de St Lussou read a proclamation asserting the French claim to all the territory in the region of the Great Lakes. Two years afterwards the upper course of the Mississippi was explored by Joliet and Marquette. In 1679 Daniel Greysolon, Sieur du Lhut (Duluth), as agent for a company of Canadian merchants which sought to establish trading posts on the Lakes, explored the country from the head of Lake Superior to Mille Lacs and planted the arms of Louis XIV. in a large Sioux village. In the following year the Franciscan friar Father Louis Hennepin, acting as an agent of the Sieur de la Salle, discovered and named the Falls of St Anthony; and in 1686 Nicholas Perrot, the commandant of the west, built Fort St Antoine on the east bank of Lake Pepin, in what is now Pepin county, Wisconsin, and in 1688 formally took possession of the region in the name of the French king. A few years later (1694) Le Sueur, who had as early as 1684 engaged in trade along the upper Mississippi, established a trading post on Isle Pelée (Prairie Island) in the Mississippi between Hastings and Red Wing, and in 1700 he built Fort L'Huillier at the confluence of the Blue Earth and the Le Sueur rivers. In 1762 the Sieur de la Perrière, acting as an agent of the French government, established on the west bank of Lake Pepin a fortified post (Fort

Beauharnois), which was to be a headquarters for missionaries, a trading post and a starting-point for expeditions in search of the "western sea." But none of the French posts was permanent, and in 1763 French rule came to an end, the Treaty of November (1762) and the Treaty of Versailles (1763) transferring respectively the western portion of the state to Spain and that part east of the Mississippi river to Great Britain. In 1766 the region was visited by the Connecticut traveller Jonathan Carver (1732-1780). Great Britain surrendered its title to the eastern portion by the Treaty of Paris (1763), and after the surrender of Virginia's colourable title had been accepted by Congress in 1784, this eastern part was made a part of the Northwest Territory by the ordinance of 1787, although the British held possession and did some trading there until 1796. The western part remained under Spanish control until 1803, when it, too, after being retransferred to France, became a part of the United States with the rest of the Louisiana Purchase. In 1805-1806, at the instance of President Thomas Jefferson, Lieut. Zebulon M. Pike led an exploring expedition as far north as Leech Lake and took formal possession of the Minnesota region for the United States. He obtained from the Sioux for military reservations one tract 9 m. square at the mouth of the St Croix River and another containing about 100,000 acres at the confluence of the Minnesota and Mississippi rivers. On the latter tract a military post was established by Lieut.-Colonel Henry Leavenworth (1783-1834) in 1810, and in the following year the construction was begun of a fort at first named Fort St Anthony but renamed Fort Snelling in 1824 (two years after its completion) in honour of its builder and commander Colonel Josiah Snelling (1782-1829). In 1819 Michigan Territory was extended westward to the Mississippi river, and in 1820 General Lewis Cass, its governor, conducted an exploring expedition in search of the source of the Mississippi, which he was satisfied was in the body of water named Lake Cass in his honour. Further search for the true source of the Mississippi was made in 1823 by Giacomo Constantio Beltrami (1779-1855), an Italian traveller and political refugee, and in 1832 by Henry Rowe Schoolcraft, who had accompanied Cass's expedition and traced the Mississippi from Lake Cass to Lake Itasca. In 1823 extensive explorations of the Minnesota and Red River valleys were conducted by Major Stephen Harriman Long (1784-1864), and subsequently (1834-1836) knowledge of the region was extended by the investigations of the artist George Catlin (1796-1872), the topographer George William Featherstonhaugh (1780-1866), and the geologist Jean Nicholas Nicollet (1786-1843). Meanwhile, the country was slowly being settled. In 1823 the first river steamboat reached St Paul; the Mississippi was soon afterwards opened to continuous if irregular navigation; and in 1826 a party of refugees from Lord Selkirk's colony on the Red River settled near Fort Snelling. On the erection of Wisconsin Territory in 1836 the whole of Minnesota, which then extended westward to the Missouri river, was incorporated with it, but on the erection of Iowa Territory in 1838 Minnesota was divided and the part west of the Mississippi became a part of Iowa Territory. In 1837, by two important treaties, the one (July 29) between the Chippewas and Governor Henry Dodge of Wisconsin at St Peters, and the other (Sept. 29) between some Sioux chiefs and Joel R. Poinsett at Washington, the Indian titles to all lands east of the Mississippi were practically extinguished. The first county, St Croix, was established in 1839, and in the succeeding years thriving settlements were established at St Paul and Stillwater. The admission of Wisconsin as a state in 1848 left that part of the former territory west of the St Croix and north of the Mississippi rivers, which was not included in the new state, practically without a government. On the 26th of August a convention met at Stillwater, where measures were taken for the formation of a separate territorial government, and Henry Hastings Sibley (1811-1891) was sent to Congress as a delegate of "Wisconsin Territory." Upon his admission to a seat the curious situation was presented of representatives of the state and of the territory of Wisconsin sitting in the same body. This situation did not last long, however, for on the 3rd of March 1849 the bill organizing the territory of Minnesota was passed,

and on the 19th President Zachary Taylor appointed Alexander Ramsey of Pennsylvania the first territorial governor. The territorial boundaries extended to the Missouri river, including a greater part of the present North and South Dakota. The first territorial legislature met at St Paul on the 3rd of September following. By the Federal census of 1850 the territory had a population of 6077, most of whom lived east of the Mississippi, or along the Red river in the extreme north-west. Two treaties negotiated with the Sioux by Luke Lea, commissioner, and Governor Alexander Ramsey in 1851 opened to settlement the greater part of the land within the territory west of the Mississippi, and such an unparalleled rush to the new lands took place that a census taken in 1857 showed a population of 150,037. In July 1857 a convention chosen to form a state constitution was found on assembling to be so evenly divided between the Republican and Democratic parties that organization was impossible, and the members proceeded to their work in two separate bodies. By means of conference committees, however, identical constitutions were formed, which in the following October were adopted by an almost unanimous popular vote. The state was admitted to the Union with its present boundaries on the 12th of May 1858, and the federal census of 1860 showed that the population had increased to 172,023, despite the fact that the financial panic of 1857 had severely checked the state's growth. Minnesota furnished more than 25,000 troops for the Federal armies during the Civil War. But even more pressing than the call of the nation was the need of defending her own homes against the uprisings of the Indians within her borders. The settlements bordering on the Indian reservations had experienced more or less trouble with the Sioux for several years, the most serious outbreak having occurred in March 1857, when Ink-pa-tu-la led his band to massacre the settlers at Spirit Lake. The absence of a large proportion of the able-bodied young settlers in the northern armies was taken advantage of by the Indians, and in the summer of 1862 there was delay in paying them their yearly allowance. Suddenly towards the end of August, as if by previous understanding (although nothing of the sort was ever proved), small bands of Sioux scattered along the frontier for 200 m. and began a systematic massacre of the white settlers. Beginning with the first outbreak at Acton, Meeker county (Aug. 17), the attacks continued with increasing fury (nearly 1000 whites losing their lives) until the 23rd of September, when hastily-raised volunteer forces under Colonel H. H. Sibley decisively defeated Little Crow, the principal leader of the Kaposia band, at Wood Lake. Three days later more than 2000 of the Indians were surrounded and captured, Little Crow with a few of his companions alone escaping beyond the Missouri. A military commission tried 425 of the captives for murder and rape, of whom 321 were found guilty and 303 were condemned to death. Of these 38 were hanged at Mankato on the 26th of December 1862. Little Crow and his followers kept up desultory raids from the Dakota country, during one of which in July 1863 he lost his life. Expeditions of Sibley in 1863, and General Alfred Sully (1821-1879) in 1864, eventually drove the hostile Indians beyond the Missouri and terminated the war, which in two years had cost upwards of a thousand lives of settlers and volunteers. The opening of the Chippewa lands in the north-west and the coming of peace marked the beginning of a new period of rapid growth, the Federal census of 1870 showing a population of 439,706, or a gain of 75.8 % in five years. During the same half-decade railway construction, which had begun with the opening of the railway between St Paul and Minneapolis in 1862, reached a total of more than 1000 m. For a period of five years after the financial panic of 1873 the growth was comparatively slow, but in the succeeding two years the recuperation was rapid. During the decade, 1880-1890, more than 2300 m. of railway were completed and put in operation. In September 1894 disastrous forest fires, starting in the neighbourhood of Hinckley in Pine county, destroyed that village and several neighbouring towns, causing the death of 418 people, rendering 2200 others homeless, and devastating about 350 sq. m. of forest land, entailing a loss of more than \$1,000,000. The

state furnished four regiments (a total of 5313 officers and men) to the volunteer army during the Spanish-American War (1898), the service of the 13th Regiment for more than a year in the Philippines being particularly notable. In October 1898 there was an uprising of the Pillager band of Chippewa Indians at Leech Lake, which was quelled by the prompt action of Federal troops. Since the first state election, which was carried by the Democratic party, the state has been generally strongly Republican in politics; but the Republican candidate for governor was defeated in 1898 by a "fusion" of Democrats and Populists, and in 1904, 1906 and 1908 a Democratic governor, John Albert Johnson, was elected, very largely because of his personal popularity.

GOVERNORS OF MINNESOTA.

Territorial.		Whig	1849-1853
Alexander Ramsey		Democrat	1853-1857
Willis Arnold Gorman		"	1857-1858
Samuel Medary		"	
State.			
Henry Hastings Sibley	Democrat		1858-1860
Alexander Ramsey	Republican		1860-1863
Henry A. Swift	"		1863-1864
Stephen Miller	"		1864-1866
William Rogerson Marshall	"		1866-1870
Horace Austin	"		1870-1874
Cushman Kellogg Davis	"		1874-1876
John Sargent Pillsbury	"		1876-1882
Lucius Fairchild Hubbard	"		1882-1887
Andrew Ryan McGill	"		1887-1889
William Rush Merriam	"		1889-1893
Knute Nelson	"		1893-1895
David Marston Clough	"		1895-1899
John Lind	Democrat-Populist		1899-1901
Samuel R. Van Sant	Republican		1901-1905
John Albert Johnson	Democrat (died in office)		1905-1909
Adolph Olson Eberhart	Republican		1909-

BIBLIOGRAPHY.—There is a well-arranged *Bibliography of Minnesota* by John Fletcher Williams in the *Collections of the Minnesota Historical Society*, vol. iii. (St Paul, 1880). Consult also *Materials for the Future History of Minnesota*, published by the State Historical Society (St Paul, 1865), and Leo S. Bradley's bibliography of Northwestern institutional history in the *Proceedings of the Wisconsin State Historical Society* (Madison, Wis., 1896). Of the many interesting and valuable narratives and descriptions of Minnesota in the early days, those especially worthy of mention are Beltrami's *La Découverte des sources des Mississipi et de la Rivière Sanglante* (New Orleans, 1824) and the same author's *A Pilgrimage in Europe and America, leading to the Discovery of the Sources of the Mississipi and Bloody Rivers* (2 vols., London, 1828); William H. Keating, *Narrative of an Expedition to the Sources of the St Peter (Minnesota) River, Lake Winnepeg, Lake of the Woods, &c.* . . . in 1823 (2 vols., London, 1825), an account of the explorations of Major Long; Henry R. Schoolcraft, *Narrative of an Expedition through the Upper Mississippi to Itasca* (New York, 1834); G. W. Featherstonhaugh, *A Canoe Voyage up the Minnaw Sator* (2 vols., London, 1847); Laurence Oliphant, *Minnesota and the Far West* (Edinburgh, 1855); and Frederika Bremer, *The Homes of the New World: Impressions of America* (2 vols., New York, 1864). For the territorial period consult also E. S. Seymour, *Sketches of Minnesota, the New England of the West* (New York, 1850); J. Wesley Bond, *Minnesota and its Resources* (New York, 1853); C. A. Andrews, *Minnesota and Dacotah* (Washington, 1857); and C. E. Flandreau, *The History of Minnesota and Tales of the Frontier* (St Paul, 1901). The *Collections of the Minnesota State Historical Society* contain much valuable material on the history of the state, notably E. D. Neill's "French Voyagers to Minnesota during the Seventeenth Century" (1872); E. D. Neill's "Early French Ports" (1880); T. F. Moran's "How Minnesota became a State" (1898); H. C. Moss's "Last Days of Wisconsin Territory and Early Days of Minnesota Territory" (1898); C. E. Flandreau's "Reminiscences of Minnesota during the Territorial Period" (1901); C. D. Gillilan's "Early Political History of Minnesota" (1901); and James H. Baker's *Lives of the Governors of Minnesota* (1908). For the Sioux uprising consult Isaac V. D. Heard, *History of the Sioux War and the Massacres of 1862 and 1863* (New York, 1864); Charles S. Bryant and Abel B. Murch, *A History of the Great Massacre by the Sioux Indians in Minnesota* (Cincinnati, 1864); and S. R. Foot, "The Sioux Indian War," in *Iowa Historical Record*, vols. x. and xi. (1894-1895). Consult also *Minnesota in the Civil and Indian Wars, 1861-1865* (2 vols., St Paul, 1890-1893). The best general account of the state's history is W. W. Folswell's *Minnesota, the North Star State* (Boston, 1908), in the "American Commonwealth series"; E. D. Kirk's *Concise History of Minnesota* (Minneapolis, 1887); and T. H. Nell's *Illustrated History of Minnesota* (St Paul, 1887) may also be consulted. For an account of the administration consult Frank L. McVey, *The Government of Minnesota*

(New York, 1901); Sanford Niles, *History and Civil Government of Minnesota* (Chicago, 1897); and the *Legislative Manual*, published biennially by the state at St Paul.

MINNOW (*Leuciscus phoxinus*), the smallest British fish of the Cyprinoid family, readily distinguished by its very minute scales. The ordinary name is derived from the common Indo-European word for "little" (cf. Lat., *minor*), and "minnow" is popularly identified with any tiny fish; in America it is given to small forms of the *Gambusia* and *Notropis* genera, &c. The British minnow abounds in lakes, rivers and brooks, swimming in schools, and shifting its ground in search of food, in the shape of every kind of animal and vegetable substance. It ranges from Scandinavia to south Europe, and from Ireland to north-east Asia, attaining an elevation of nearly 8000 ft. in the Alps. Its size varies from between 2 and 3 in. to as much as 4 or 5 in. The minnow is commonly used by anglers for bait, and is useful in ponds as food for trout, perch or pike.

MINO DI GIOVANNI (1431-1484), called **DA FIESOLE**, Italian sculptor, was born at Poppi in the Casentino. He had property at Fiesole. Vasari's account of him is very inaccurate. Mino was a friend and fellow-worker with Desiderio da Settignano and Matteo Civitate, all three being about the same age. Mino's sculpture is remarkable for its finish and delicacy of details, as well as for its spirituality and strong devotional feeling. Of Mino's earlier works, the finest are in the duomo of Fiesole, the altarpiece and tomb of Bishop Salutati, executed before 1466. In the Badia of Florence are an altarpiece and the tombs of Bernardo Giugni (1466) and the Margrave Hugo (1481), all sculptured in white marble, with life-sized recumbent effigies and attendant angels. The pulpit in Prato Cathedral, in which he collaborated with Antonio Rossellino, finished in 1473, is very delicately sculptured with bas-reliefs of great minuteness, but somewhat weakly designed. Soon after the completion of this work Mino went to Rome, where he executed the tomb of Pope Paul II. (now in the crypt of St Peter's), the tomb of Francesco Tornabuoni in S. Maria sopra Minerva, and a beautiful little marble tabernacle for the holy oils in S. Maria in Trastevere. There can be little doubt that he was also the sculptor of several monuments in S. Maria del Popolo, especially those of Bishop Gomiel and Archbishop Rocca (1482), and the marble reredos given by Pope Alexander VI. Some of Mino's portrait busts and profile bas-reliefs are preserved in the Bargello at Florence; they are full of life and expression, though without the extreme realism of Verrocchio and other sculptors of his time.

See Vasari, Milanesi's ed. (1878-1882); Perkins's *Italian Sculptors*, Winkelmann and D'Agincourt, *Storia della scultura* (1813); Hans Semper, *Architekten der Renaissance* (Dresden, 1880); Wilhelm Bode, *Die italienische Plastik* (Berlin, 1893).

MINOR, ROBERT CRANNE (1830-1904), American artist, was born in New York city on the 30th of April 1839, and received his art training in Paris under Diaz, and in Antwerp under Joseph Van Luppen. His paintings are characteristic of the Barbizon school, and he was particularly happy in his sunset and twilight effects; but it was only within a few years of his death that he began to have a vogue among collectors. In 1897 he was elected a member of the National Academy of Design, New York. After 1900 he lived at Waterford, Connecticut, where he died on the 4th of August 1904.

MINOR (Lat. for smaller, lesser), a word used both as an adjective and as a substantive for that which is less than or inferior to another, and often correlatively opposed to that to which "major" is applied in the same connotation. Among the numerous special uses of the word the following may be mentioned: "Minor Friars," sometimes known as "Minorites," i.e. the name (*fratres minores*, lesser brothers) given by St Francis to the order he founded (see **FRANCISCANS**); "minor canons" are clergymen attached to a cathedral or collegiate church who read and sing the daily service. In some cathedrals they are known as "vicars choral"; they are not members of the chapter. (For the distinction between holy and minor orders in Christian hierarchy see **ORDERS**.) The name "Minor Prophets" is used collectively of the twelve

prophetic books of the Old Testament from Hosea to Malachi inclusive. (For the distinction in music between major and minor intervals, and for other applications of the correlative term, see **MUSIC** and **HARMONY**.) In the categorical syllogism (*q.v.*) in logic, the minor term is that term which forms the subject of the conclusion, the minor premiss is that which contains the minor term. In law, a "minor" is a person under legal age (see **INFANT**).

In mathematics, the "minor of a determinant" is the determinant formed by erasing an equal number of the rows and columns of the original determinant. If one column and row be erased there is formed the first minor; if two rows and columns the second minor, and so on. The minor axis of a central conic section is the shorter of the two principal axes; it may also be regarded as the line joining the two imaginary foci. In astronomy, the term minor planets is given to the members of the solar system which have their orbits between those of Mars and Jupiter (see **PLANETS**, **MINOR**).

MINORCA (Menorca), the second in size of the group of Spanish islands in the Mediterranean Sea, known as the Balearic Islands (*q.v.*), 27 m. E.N.E. of Majorca. Pop. (1900), 371,512; area, 260 sq. m. The coast is deeply indented, especially on the north, with numerous creeks and bays—that of Port Mahon (17,144) being one of the finest in the Mediterranean, if not the best of them all, according to the popular rhyme—

"Junio, Julio, Agosto y puerto Mahon
Los mejores puertos del Mediterraneo son"—

"June, July, August and Port Mahon are the best harbours of the Mediterranean" (see **PORT MAHON**). The ports Abdaya, Fornelle, Ciudadela and Nitja may also be mentioned. The surface of the island is uneven, flat in the south and rising irregularly towards the centre, where the mountain El Toro—probably so called from the Arabic *tor*, a height, though the natives have a legend of a *toro* or bull—has an altitude of 1207 ft. The climate is not so equable as that of Majorca, and the island is exposed in autumn and winter to the violence of the north winds. Its soil is of very unequal quality; that of the higher districts being light, fine, and fertile, and producing regular harvests without much labour, while that of the plains is chalky, scanty, and unfit for pasture or the plough. Some of the valleys have a good alluvial soil; and where the hills have been terraced they are cultivated to the summit. The wheat and barley raised in the island are sometimes sufficient for home consumption; there is rarely a surplus. The *Hedysarum coronarium*, or *zulla*, as it is called by the Spaniards, is largely cultivated for fodder. Wine, oil, potatoes, hemp and flax are produced in moderate quantities; fruit of all kinds, including melons, pomegranates, figs and almonds, is abundant. The caper plant is common throughout the island, growing on ruined walls. Horned cattle, sheep and goats are reared, and small game abound. Stone of various kinds is plentiful. In the district of Mercadal and in Mount Santa Agueda are found fine marbles and porphyries; lime and slate are also abundant. Lead, copper and iron might be worked were it not for the scarcity of fuel. There are manufactures of the wool, hemp and flax of the island; and formerly there was a good deal of boat-building; but agriculture is the chief industry. An excellent road, constructed in 1713-1715 by Brigadier-General Richard Kane, to whose memory a monument was erected at the first milestone, runs through the island from south-east to north-west, and connects Port Mahon with Ciudadela. Ciudadela (8611), which was the capital of the island till Port Mahon was raised to that position by the English, still possesses considerable remains of its former importance.

MINOS, a semi-legendary king of Crete, son of Zeus and Europa. By his wife, Pasiphaë, he was the father of Ariadne, Deucalion, Phædra and others. He reigned over Crete and the islands of the Aegean three generations before the Trojan War. He lived at Cnossus for periods of nine years, at the end of which he retired into a sacred cave, where he received instruction from Zeus in the legislation which he gave to the island. He was the author of the Cretan constitution and the founder of its naval

supremacy (Herodotus iii. 122; Thucydides i. 4). In Attic tradition and on the Athenian stage Minos is a cruel tyrant, the heartless exactor of the tribute of Athenian youths to feed the Minotaur (*q.v.*). It seems possible that tribute children were actually exacted to take part in the gruesome shows of the Minoan bull-rings, of which we now have more than one illustration (see CRETE: *Archaeology*). To reconcile the contradictory aspects of his character, two kings of the name of Minos were assumed by later poets and mythologists. Since Phoenician intercourse was in later times supposed to have played an important part in the development of Crete, Minos is sometimes called a Phoenician. There is no doubt that there is a considerable historical element in the legend; recent discoveries in Crete (*q.v.*) prove the existence of a civilization such as the legends imply, and render it probable that not only Athens, but Mycenae itself, was once subject to the kings of Cnossus, of whom Minos was greatest. In view of the splendour and wide influence of Minoan Crete, the age generally known as "Mycenaean" has been given the name of "Minoan" by Dr Arthur Evans as more properly descriptive (see CRETE). Minos himself is said to have died at Camicus in Sicily, whither he had gone in pursuit of Daedalus, who had given Ariadne the clue by which she guided Theseus through the labyrinth. He was killed by the daughter of Cocalus, king of Agrigento, who poured boiling water over him in the bath (Diod. Sic. iv. 79). Subsequently his remains were sent back to the Cretans, who placed them in a sarcophagus, on which was inscribed: "The tomb of Minos, the son of Zeus." The earlier legend knows Minos as a beneficent ruler, legislator, and suppressor of piracy (Thucydides i. 4). His constitution was said to have formed the basis of that of Lycurgus (Pausanias iii. 2, 4). In accordance with this, after his death he became judge of the shades in the under-world (*Odyssey*, ix. 568); later he was associated with Aeacus and Rhadamanthus.

The solar explanation of Minos as the sun-god has been thrown into the background by the recent discoveries. In any case a divine origin would naturally be claimed for him as a priest-king, and a divine atmosphere hangs about him. The name of his wife, Pasiphaë ("the all-shining"), is an epithet of the moon-goddess. The name Minos seems to be philologically the equivalent of Minyas, the royal ancestor of the Minyans of Orchomenus, and his daughter Ariadne ("the ex-ceding holy") is a double of the native nature-goddess. (See CRETE: *Archaeology*.)

On Cretan coins Minos is represented as bearded, wearing a diadem, curly-haired, haughty and dignified, like the traditional portraits of his reputed father, Zeus. On painted vases and sarcophagi his relief is frequently occurs with Aeacus and Rhadamanthus as judges of the under-world and in connexion with the Minotaur and Theseus.

MINOT, LAURENCE (fl. 1333-1352), English poet, the author of eleven battle-songs, first published by Joseph Ritson in 1795 as *Poems on Interesting Events in the reign of King Edward III*. They had been discovered by Thomas Tyrwhitt in a MS. (Cotton Galba, E. IX., British Museum) which bore on the fly-leaf the misleading inscription: "Chaucer, Exemplar emendate scriptum." It dates from the beginning of the 15th century. The authorship of Laurence Minot's eleven songs is fixed by the opening of the fifth: "Minot with moeth had begin to make," and in VII. 20, "Now Laurence Minot will mend." The poems were evidently written contemporaneously with the events they describe. The first celebrates the English triumph at Halidon Hill (1333), and the last the capture of Guines (1352). The writer is animated by an ardent personal admiration for Edward III. and a savage joy in the triumphs of the English over their enemies. The technical difficulty of his metres and the comparatively even quality of the work led to the inference that Minot had written other songs, but none have come to light. Nothing whatever is known of his life, but the minuteness of his information suggests that he accompanied Edward on some of his campaigns. Though his name proves him to have been of Norman birth, he writes vigorous and idiomatic English of the northern dialect with some admixture of midland forms. His poems are

instinct with a fierce national feeling, which has been accepted as an index of the union of interests between the Norman and English elements arising out of common dangers and common successes.

There are excellent editions of Minot's poems by Wilhelm Scholle (*Quellen und Forschungen*, vol. liii., Strassburg, 1884), with notes on etymology and metre, and by Mr J. Hall (Clarendon Press, 2d ed., 1897). Mr Hall is inclined to include as his work the "Hymn to Jesus Christ and the Virgin" (*Religious Pieces*, Early English Text Society, No. 26, p. 76), on the grounds of similarity of style and language. See also T. Wright, *Political Poems and Songs* (Rolls series, 1859).

MINOTAUR (Gr. *Μινώταυρος*, from *Μίνως*, and *ταύρος*, bull), in Greek mythology, a fabulous Cretan monster with the body of a man and the head of a bull. It was supposed to be the offspring of Pasiphaë, the wife of Minos, and a snow-white bull, sent to Minos by Poseidon for sacrifice. Minos, instead of sacrificing it, spared its life, and Poseidon, as a punishment, inspired Pasiphaë with an unnatural passion for it. The monster which was born was shut up in the Labyrinth (*q.v.*). Now it happened that Androgeus, son of Minos, had been killed by the Athenians, who were jealous of the victories he had won at the Panathenian festival. To avenge the death of his son, Minos demanded that seven Athenian youths and seven maidens should be sent every ninth year to be devoured by the Minotaur. When the third sacrifice came round Theseus volunteered to go, and with the help of Ariadne (*q.v.*) slew the Minotaur (Plutarch, *Theseus*, 15-19; Diod. Sic. i. 16, iv. 61; Apollodorus iii. 1, 15). Some modern mythologists regard the Minotaur as a solar personification and a Greek adaptation of the Baal-Moloch of the Phoenicians. The slaying of the Minotaur by Theseus in that case indicates the abolition of such sacrifice by the advance of Greek civilization.

According to A. B. Cook, Minos and Minotaur are only different forms of the same personage, representing the sun-god Zeus of the Cretans, who represented the sun as a bull. He and J. G. Frazer both explain Pasiphaë's monstrous union as a sacred ceremony (*ἱερὸν γάμου*), at which the queen of Cnossus was wedded to a bull-formed god, just as the wife of the *ἄρχων βασιλεύς* in Athens was wedded to Dionysus. E. Pottier, who does not dispute the historical personality of Minos, in view of the story of Phalaris (*q.v.*) considers it probable that in Crete (where a bull-cult may have existed by the side of that of the double axe) victims were tortured by being shut up in the belly of a red-hot brazen bull. The story of Talos, the Cretan man of brass, who heated himself red-hot and clasped strangers in his embrace as soon as they landed on the island, is probably of similar origin. The contest between Theseus and the Minotaur was frequently represented in Greek art. A Cnossian didrachm exhibits on one side the labyrinth, on the other the Minotaur surrounded by a semicircle of small balls, probably intended for stars; it is to be noted that one of the monster's names was Asterius.

See A. Conze, *Theseus und Minotaurus* (1878); L. Stephani, *De Kampf zwischen Theseus und Minotaurus* (1842), with plates and history of the legend; L. Preller, *Griechische Mythologie*; Helbig in Roscher's *Lexicon der Mythologie*; F. Durrbach in Daremberg and Saglio's *Dictionnaire des antiquités*; A. B. Cook in *Classical Review*, xvii. 410; J. G. Frazer, *Early History of the Kingship* (1905); E. Pottier in *La Revue de Paris* (Feb. 1902); the story is told in Kingsley's *Heracles*.

MINSK, a government of western Russia, bounded by the governments of Vilna, Vitebsk, Mogilev and Chernigov on the N. and E. and by Kiev, Volhynia and Grodno on the S. and W. It has an area of 35,283 sq. m. The surface is undulating and hilly in the north-west, where a narrow plateau and a range of hills (800-1000 ft.) of tertiary formation separate the basin of the Niemen, which flows into the Baltic, from that of the Dnieper, which sends its waters into the Black Sea. The remainder of the government is flat, 450 to 650 ft. above sea-level, and covered with sands and clays of the glacial and post-glacial periods. Two broad shallow depressions, drained by the Berzina and the Pripet, cross the government from north to south and from west to east; and these, as well as the triangular space between them, are occupied by immense marshes (often as much as 200 to 600 sq. m. each), ponds and small lakes, peat-bogs and moving sands, intermingled with dense forests. This country, and especially its south-western part, is usually known under the name of Polyésie ("The Woods"). Altogether, marshes and moors

take up 22% and marshy forests no less than 40% of the entire area of the province. It is only in the north-west that the forests consist of full-grown trees; those which grow on the marshy ground are small, stunted pine, birch and aspen. The climate of the Polyesie is extremely unhealthy; malarial and an endemic disease of the hair (*plica Polonica*) are the plagues of these tracts. Communication is very difficult. The railway from Poland to Moscow has taken advantage of the plateau above mentioned; but still it has to cross the broad marshy depression of the Berezina. A successful attempt was made to drain the marshes of the Polyesie by a system of canals, and more than 4,500,000 acres have thus been rendered suitable for pasture and agriculture. Two tributaries of the Dnieper—the Berezina and the Pripet—both navigable, with numberless subtributaries, many also navigable, are the natural outlets for the marshes. The Dnieper flows along its south-eastern border for 160 m. and the Niemen on the north-west for 130 m. The affluents of the Baltic, the Dvina and the Vistula, are connected by canals with tributaries of the Dnieper. The estimated population in 1906 was 2,581,400. The peasants constitute 65% of the population, who are mostly White Russians (71%); there are also Poles (12%), Jews (16%), Little Russians and Great Russians. About 70,000 are considered to be Lithuanians; there are also 4500 Tatars and 2000 Germans.

The principal occupation of the inhabitants is agriculture, which is very unproductive in the lowlands; in the Polyesie the peasants rarely have pure bread to eat. Only 23.5% of the area is under crops. Cattle-breeding is very imperfectly developed. Hunting and bee-keeping are sources of income in the Polyesie, and fishing gives occupation to about 20,000 persons. Gardening is carried on in some parts. The chief source of income for the inhabitants of the lowlands is the timber trade. Timber is floated down the rivers, and tar, pitch, various products of bark, potash, charcoal and amber-ware (wooden dishes, &c.) are manufactured in the villages to a great extent; and ship-building is carried on along the Dnieper, Pripet and Niemen. Shipping is also an important source of income. The industrial arts are almost entirely undeveloped, but there are several distilleries, flour-mills, saw-mills and tanneries, and woollen-stuffs, candles, tobacco, matches and sugar are manufactured. The great highway from Warsaw to Moscow crosses the government in the south, and its passage through the Berezina is protected by the first-class fortress of Bobruisk. The government is divided into nine districts, of which the chief towns and populations in 1897 are: Minsk, capital of the government (q.v.), Bobruisk (35,177), Igumei (4579), Mozyr (10,762), Novogrudok (7700), Pinsk (27,938), Ryeckitsa (10,681) and Slutsk (14,180).

This region was originally inhabited by Slavs. That portion of it which was occupied by the Krivichi became part of the Polotsk principality, and so of White Russia; the other portion, occupied by the Dregovichi and Drevlyans, became part of Black Russia; whilst the south-western portion was occupied by Yatvyags or Lithuanians. During the 12th, 13th and 14th centuries it was divided among several principalities, which were successively incorporated with Lithuania, and later annexed to Poland. Russia took possession of this country in 1793. In 1812 it was invaded by the army of Napoleon I. Archaeological finds of great value, dating from the Neolithic and subsequent ages, have lately been made. (P. A. K.; J. T. BE.)

MINSK, a town of Russia, capital of the government of the same name, on the Svisloch, a tributary of the Berezina, at the intersection of the Moscow-Warsaw and Libau-Kharkov railways, 430 m. by rail W. from Moscow. It had, in 1897, 91,494 inhabitants, of whom one-third were Jews of the poorest class; the others were White Russians, Poles and Tatars. Amongst its public buildings is a cathedral, built in 1611. Minsk is the headquarters of the IVth Army Corps and the see of a bishop of the Orthodox Greek Church, and from 1798 to 1853 it was a see of the Roman Catholic Church. The manufactures are few and insignificant. Since the introduction of railways the commercial importance of the place, which formerly was slight, has begun to increase.

Minsk is mentioned in Russian annals in the 11th century under the name of Myen'sk, or Menesk. In 1066 and 1066 it was devastated, first by Izyaslav and afterwards by Vladimir, prince of Kiev. It changed rulers many times until the 13th century, when it became a Lithuanian fief. In the 15th century it was

part of Poland, but as late as 1505 it was ravaged by Tatars, and in 1508 by Russians. In the 18th century it was taken several times by Swedes and Russians. Russia annexed it in 1793. Napoleon I. took it in 1812.

MINSTER, two towns of Kent, England.

1. **MINSTER-IN-THANER**, in the Isle of Thanet parliamentary division, lies on the southern slope of the isle, above the Minster marshes, in the low, flat valley of the river Stour, 4 m. west of Ramsgate, on the South-Eastern & Chatham railway. Pop. (1901), 2338. Its church, dedicated to St Mary, is cruciform, with a western tower, the nave a fine example of Norman work, the transepts and choir a beautiful Early English addition. The carved choir-stalls are a notable feature. The church belonged to a nunnery, founded at the close of the 7th century. The abbey, a residence close to the church, incorporates portions of the ancient buildings. Fruit-growing is largely carried on in the neighbourhood.

2. **MINSTER-IN-SHEPPEY**, in the north-eastern parliamentary division, lies in the Isle of Sheppey, near the north coast. Pop. (1901), 1306. It is served by the Sheppey light railway from Sheerness, 2 m. west. The village has in modern times become a seaside resort. It has a fine church, dedicated to St Mary and St Sexburga, originally attached to a convent of the 7th century, founded by Sexburga, widow of Erconberht, king of Kent. The building as it stands is only a portion of the conventual church founded in the early part of the 12th century by William de Corbeul, archbishop of Canterbury; it retains also traces of pre-Norman work. It contains some interesting early monuments. The abbey gatehouse remains, and other fragments may be traced. There are oyster beds in the neighbouring shallow sea.

MINSTER (from Lat. *monasterium*; cf. German *Münster*), the church of a monastery, or one to which a monastery has been attached. In the 10th century the name was applied to the churches of outlying parishes, and is now given to some of the English cathedrals, such as York, Lincoln, Ripon and Southwell, and to large churches or abbeys, like those of Sherborne, Wimborne or Westminster.

MINSTREL. The word "minstrel," which is a derivative from the Latin *minister*, a servant, through the diminutives *ministellus*, *ministrallus* (Fr. *menestral*), only acquired its special sense of household entertainer late in the 13th century. It was the equivalent of the Low Latin *joculator*¹ (Prov. *joglar*, Fr. *jougleur*, Mid. Eng. *jogelour*), and had an equally wide significance.

The minstrel of medieval England had his forerunners in the Teutonic *scōp* (O.H.G. *scōpf* or *scōf*, a shaper or maker), and to a limited extent in the *mimus* of the later Roman empire. The earliest record of the Teutonic *scōp* is found in the Anglo-Saxon poem of *Widsith*, which in an earlier form probably dates back before the English conquest. *Widsith*, the far-traveller, belonged to a tribe which was neighbour to the Angles, and was sent on a mission to the Ostrogoth Ermanric (Hermanric or Ermanaric, d. 375), from whom he received a collar of beaten gold. He wandered from place to place singing or telling stories in the mead-hall, and saw many nations, from the Picts and Scots in the west to the Medes and Persians in the east. Finally he received a gift of land in his native country. *The Complaint of Deor* and *Beowulf* give further proof that the Teutonic *scōp* held an honourable position, which was shaken by the advent of Christianity. The *scōp* and the gleeman (the terms appear to have been practically synonymous) shared in the general condemnation passed by the Church on the dancers, jugglers, bear-leaders and tumblers. Saxo Grammaticus (*Historia danica*, bk. v.) condemns the Irish king Huelgic because he spent all his bounty on mimes and jugglers. That the loftier tradition of the *scōpas* was preserved in spite of these influences is shown by the tales of Alfred and Anlaf disguised as minstrels. With the Normans came the *joculator* or *jogleur*, who wore gaudy-coloured coats and the flat

¹ Used by John of Salisbury (*Polycraticus*, i. 8) as a generic term to cover *mimi*, *salti* or *salices*, *balatrones*, *aemulani*, *gladiatores*, *palaestriac*, *gignadii*, *praestigatores*.

shoes of the Latin mimes, and had a shaven face and close-cut hair. Jogleurs were admitted everywhere, and enjoyed the freedom of speech accorded to the professional jester. Their impunity, however, was not always maintained, for Henry I. is said to have put out the eyes of Luc de la Barre for lampooning him. A fairly defined class distinction soon arose. Those minstrels who were attached to royal or noble households had a status very different from that of the motley entertainers, who soon came under the restrictions imposed on vagabonds generally. A *joculator regis*, Berdic by name, is mentioned in Domesday Book. The king's minstrels formed part of the royal household, and were placed under a *rex*, a fairly common term of honour in the craft (cf. Adenès li rois). Edward III. had nineteen minstrels in his pay, including three who bore the title of waits. The large towns had in their pay bodies of waits, generally designated in the civic accounts as *histriones*. A wait under Edward III. had to "pipe the watch" four times nightly between Michaelmas and Shere Tuesday, and three times nightly during the remainder of the year. In spite of the repeated prohibitions of the Church, the matter was compromised in practice. Even religious houses had their minstrels, and so pious a prelate as Robert Grosseteste had his private harper, whose chamber adjoined the bishop's. St Thomas Aquinas (*Summa theologia*) said that there was no sin in the minstrel's art if it were kept within the bounds of decency. Thomas de Cabham, bishop of Salisbury (d. 1313), in a *Penitential* distinguished three kinds of minstrels (*histriones*)—buffoons or tumblers; the wandering *scourae*, by whom he probably meant the goliards (see GOLLARD); and the singers and players of instruments. In the third class he discriminated between the singers of lewd songs and those *joculatores* who took their songs from the deeds of princes and the lives of saints. The performances of these *joculatores* were permissible, and they themselves were not to be excluded from the consolations of the Church. The Parisian minstrels were formed into a guild in 1321, and in England a charter of Edward IV. (1469) formed the royal minstrels into a guild, which minstrels throughout the country were compelled to join if they wished to exercise their trade. A new charter was conferred in 1604, when its jurisdiction was limited to the city of London and 3 m. round it. This corporation still exists, under the style of the Corporation of the Master, Wardens and Commonalty of the Art or Science of the Musicians of London.

During the best time of minstrelsy—the 10th, 11th and 12th centuries—the minstrel, especially when he composed his own songs, was held in high honour. He was probably of noble or good bourgeois birth, and was treated by his hosts more or less as an equal. The distinction between the troubadour and the jogleur which was established in Provence probably soon spread to France and England. In any case it is probable that the poverty which forms the staple topic of the poems of Rutebef (*q.v.*) was the commonest lot of the minstrel.

Entries of payments to minstrels occur in the accounts of corporations and religious houses throughout the 16th century; but the art of minstrelsy, already in its decline, was destroyed in England by the introduction of printing, and the minstrel of the entertainments given to Elizabeth at Kenilworth was little more than a survival.

The best account of the subject is to be found in E. K. Chambers's *Medieval Stage* (1903), i. 23-86 and ii. 230-266. See also L. Gautier in *Épopées françaises* (vol. ii., 2nd ed., 1892); A. Schultz, *Das höfische Leben zur Zeit der Minnesinger* (2nd ed., 1889); T. Percy, *Reliques of English Poetry* (ed. H. B. Wheatley, 1876); J. Ritson, *Ancient English Metrical Romances* (1802); J. J. Jusserand, *English Wayfaring Life in the Middle Ages* (4th ed., 1892).

MINT, botanically *Mentha*, a genus of labiate plants, comprising about twenty species of perennial herbs, widely distributed throughout the temperate and sub-tropical portions of the globe, but chiefly in the temperate regions of the Old World. The species have square stems, opposite, aromatic leaves, and a stoloniferous creeping rootstock. The flowers are arranged in axillary clusters (cymes), which either form separate whorls or are crowded together into a terminal spike. The corolla is usually small and of a pale purple or pinkish colour; it has four

nearly equal lobes, and encloses two long and two short stamens. Nearly three hundred intermediate forms have been named and described. Many of these varieties are permanent, in consequence of being propagated by stolons.

In Britain ten species are indigenous or naturalized. *Mentha viridis*, or spearmint, grows in marshy meadows, and is the species commonly used for culinary purposes; it is distinguished by its smooth, sessile leaves and lax tapering flower-spikes. It is probably a cultivated race of the next species, *Mentha sylvestris*, or horsemint, which chiefly differs from the above in its coarser habit and hairy leaves, which are silky beneath, and in its denser flower-spikes. This plant is supposed to be the mint of Scripture, as it is extensively cultivated in the East; it was one of the bitter herbs with which the paschal lamb was eaten. *M. rotundifolia* resembles the last in size and habit, but is distinguished by its rounded wrinkled leaves, which are shaggy beneath, and by its lanceolate bracts. The last two species usually grow on damp waste ground. *M. aquatica* grows in ditches, and is easily recognized by its rounded flower-spikes and stalked hairy leaves. *M. piperita*, or peppermint (*q.v.*), has stalked smooth leaves and an oblong obtuse terminal spike of flowers; it is cultivated for its volatile oil. *M. pratensis* belongs to a group which have the flowers arranged in axillary whorls and never in terminal spikes; it otherwise bears some resemblance to *M. viridis*. *M. sativa* grows by damp roadsides, and *M. arvensis* in cornfields; they are distinguished from *M. pratensis* by their hairy stalked leaves, which in *M. arvensis* are all equally large, but in *M. sativa* are much smaller towards the apex of the stem. *M. Palegium*, commonly known as pennyroyal, more rarely as fleamint, has small oval obtuse leaves and flowers in axillary whorls, and is remarkable for its creeping habit and peculiar odour. It differs from all the mints above described in the throat of the calyx being closed with hairs. It is met with in damp places on grassy commons, and was formerly popular for medicinal purposes.

All the genus *Mentha* abound in a volatile oil, contained in resinous dots in the leaves and stems. The odour of the oil is similar in several species, but is not distinctive, the same odour occurring in varieties of distinct species. Thus the peppermint flavour is found in *M. piperita*, in *M. incana*, and in Chinese and Japanese varieties of *M. arvensis*. Other forms of the last-named species growing in Ceylon and Java have the flavour of the common garden mint. *M. viridis*, and the odour is found in *M. sylvestris*, *M. rotundifolia* and *M. canadensis*. A bergamot scent is met with in a variety of *M. aquatica* and in forms of other species. Most mints blossom in August.

The name mint is also applied to plants of other genera, *Monarda punctata* being called horsemint, *Pycnanthemum linifolium* mountain mint, and *Nepeta cataria* catmint.

MINT (Lat. *moneta*; Mid. Eng. *mynt*), a place where coins are manufactured with the authority of the state. Coins are pieces of metal, of weight and composition fixed by law, with a design upon them, also fixed by law, by which they are identified, their value made known and their genuineness certified. The origin of the word "mint" is ascribed to the manufacture of silver coin at Rome in 269 B.C. at the temple of Juno Moneta.¹ This goddess became the personification of money, and her name was applied both to money and to its place of manufacture. Metals were used for money at an early stage of civilization, and are well suited to the purpose, owing to their great intrinsic value and their durability, indestructibility, divisibility and rarity. The best metals for coinage are gold, silver, platinum, copper, tin, nickel, aluminium, zinc, iron, and their alloys; certain alloys of gold, silver, copper and nickel have the best combination of the required qualities.

History of Minting.—The earliest metallic money did not consist of coins, but of unminted metal in the form of rings and other ornaments or of weapons, which were used for thousands of years by the Egyptian, Chaldean and Assyrian Empires (see NUMISMATICS). According to Herodotus, the first mint was probably that established by Gyges in Lydia towards the end of the 8th century B.C. for the coining of gold, silver and electrum, an

¹ Lenormant, *La Monnaie dans l'antiquité*, i. 82.

alloy of gold and silver found in a natural state.¹ Silver was coined in the island of Aegina soon afterwards. The art of coining was introduced by the Greeks into Italy and other countries bordering on the Mediterranean and into Persia and India. Subsequently the Romans laid the foundations of modern minting. Coining originated independently in China at a later date than in the western world, and spread from China to Japan and Korea. Coins may be made by casting in moulds or by striking between engraved dies. The Romans cast their larger copper coins, in clay moulds carrying distinctive markings, not because they knew nothing of striking, but because it was not suitable for such large masses of metal. Casting is now used only by counterfeiters. The most ancient coins were cast in bullet-shaped or conical moulds and marked on one side by means of a die which was struck with a hammer. The "blank" or unmarked piece of metal was placed on a small anvil (*ambos*), and the die was held in position with tongs. The reverse or lower side of the coin received a rectangular mark made by the sharp edges of the little anvil. Subsequently the anvil was marked in various ways, and decorated with letters and figures of beasts, and later still the *ambos* was replaced by a reverse die. The spherical blanks soon gave place to lenticular-shaped ones. The blank was made red-hot and struck between cold dies. One blow was usually insufficient, and the method was similar to that still used in striking medals in high relief, except that the blank is now allowed to cool before being struck. With the substitution of iron for bronze as the material for dies, about A.D. 300, the practice of striking the blanks while they were hot was gradually discarded.² In the middle ages bars of metal were cast and hammered out on an anvil. Portions of the flattened sheets were then cut out with shears, struck between dies and again trimmed with shears. A similar method had been used in Egypt under the Ptolemies (c. 300 B.C.) but had been forgotten. Square pieces of metal were also cut from cast bars, converted into round disks by hammering and then struck between dies. In striking, the lower die was fixed into a block of wood, and the blank piece of metal laid upon it by hand. The upper die was then placed on the blank, and kept in position by means of a holder round which was placed a roll of lead to protect the hand of the operator while heavy blows were struck with a hammer. An early improvement was the introduction of a tool resembling a pair of tongs, the two dies being placed one at the extremity of each leg. This avoided the necessity of readjusting the dies between blows, and ensured greater accuracy in the impression. Minting by means of a falling weight (*monkey press*) intervened between the hand hammers and the screw press in many places. In Birmingham in particular this system became highly developed and was long in use. A. Olivier introduced screw presses for striking coins, together with rolls for reducing the cast bars and machines for punching-out round disks from flattened sheets of metal, in Paris in 1553. After being discarded in 1585, except for making medals, they were reintroduced by J. Varin in 1640 and the practice of hammering was forbidden in 1645.³ In England the new machinery was tried in London in 1561, but abandoned soon afterwards; it was finally adopted in 1662, although the old pieces continued in circulation until 1696. At first the rolls were driven by workmen by means of cranks, but later they were worked by horses, mules or water-power. Steam-power was applied to them by Matthew Boulton and Watt in Birmingham in 1788, and was adopted by the Royal Mint, London, in 1810. Recently the practice of driving rolls by electricity has been growing, the advantage being that each pair of rolls can be driven independently without the intervention of cumbersome shafting. Boulton and Watt's screw press, invented in 1788 and used at the Royal Mint until 1881, was worked by atmospheric pressure applied to a piston. The piston was in communication with a vacuum vessel from which the air had been pumped by steam power.

History of British Mints.—In Britain there are evidences of

¹ *Op. cit.* i. 136. Herodotus i. 94.

² E. Dumas, *L'Émission des monnaies décimales de bronze*, p. 14.

³ *Ibid.* p. 19.

the existence of mints before the arrival of the Romans. The Romans at first imported their coins, and no Roman mints were established until about the end of the 3rd century, when coins were being struck at London and Colchester.⁴ In Anglo-Saxon times Athelstan appears to have been the first monarch who enacted regulations for the mints.⁵ He promulgated laws about the year 928, appointing a large number of "moneys" or "mynteres," London being assigned eight, Canterbury seven, other important towns various numbers and all smaller boroughs one moneyer each. The necessity for so many mints lay in the imperfect means of communication. At an early period, probably about A.D. 1000, the dies were made in London and issued to the other mints. The moneyers, who were elected by the burgesses, were responsible for the manufacture of the coin, and according to Madox were liable at the time of Henry II. to be summoned to Westminster to take part in the trials of the *pyx*.⁶ If there was any deficiency in the weight or the fineness of the coin the moneyers were punished as traitors. These moneyers appear to have been abolished about 1180,⁷ when officers were appointed to supervise the coinage on behalf of the king, and the name "moneyer" was applied to contractors who manufactured the coin under superintendence and were not responsible to the king for its weight and fineness. The moneyers continued to manufacture the coin of the realm until the year 1850, when the work was entrusted to civil servants. In the reign of Henry III. the principal officers of the Mint were the master, who manufactured the coin under a contract, the warden or paymaster who acted on behalf of the Crown, the assay master (also a king's officer) who was responsible for the fineness of the coin, the cuneator or superintendent of the engravers of the dies, and the moneyer. One of the most important duties of the warden was the collection from the contractor of the seigniorage which was claimed by the sovereign by virtue of his prerogative as a source of revenue to the Crown. In 1718 Sir Isaac Newton was made master of the Mint, and in that capacity as contractor for the coinage he amassed a considerable fortune.⁸ As the work of the Mint became more extensive and more complicated other officers were added and their duties were varied from time to time. The present administration of the English Mint is based on arrangements made in 1870, when the establishment was reorganized. The office of master of the Mint is held by the chancellor of the exchequer for the time being, without salary, but the actual administrative work of the department is entrusted to the deputy master and comptroller. The receipt of bullion and the delivery of coin from the Mint is under the charge of the chief clerk, the manufacture of coin is in the hands of the superintendent of the operative department, and the valuation of the bullion by assay, and matters relating to the fineness of the coin are entrusted to the chemist and assayer. The date of the establishment of the Mint in the Tower of London is unknown. There is a reference to it dated 1229 and a clear reference dated 1329.⁹ According to Ruding, there were over fifty mints in the reign of Edward the Confessor. After the Norman Conquest the mints increased to about seventy, a greater number than now exists in the world, but they were gradually reduced and in the reign of Edward I. there were only twelve. Ruding enumerates 128 mints operated at various times in the United Kingdom, including some established by usurpation, as in the reign of Stephen by certain barons, and also mints established by grants to ecclesiastics to be worked for their own profit. The provincial mints were all closed just before the reign of Mary, who coined in London only. Charles I. set up small mints in various towns, and for the great re-coinage in the reign of William III. mints were established at York, Chester, Exeter, Bristol and Norwich, but were soon abandoned. Wood's copper money for Ireland and America was coined at Wolverhampton (1700-1722), and the tradesmen's tokens were struck at various towns. Copper coins were struck by Boulton at Soho, Birmingham,

⁴ H. A. Grueber, *Coins of Great Britain and Ireland*, p. vii.

⁵ Rogers Ruding, *Annals of the Coinage*, 3rd ed. ii. 135.

⁶ Grueber, *op. cit.* p. xxv. ⁷ Ruding, *op. cit.* i. 35.

⁸ *Ibid.* p. xxvi. ⁹ *Ibid.* ii. 192, 194.

in 1788, and a colonial bronze coinage was executed at this establishment as recently as the year 1875. There is another mint in Birmingham worked by a private company ("The Mint, Birmingham, Limited"), where coinages for foreign governments are executed and in addition silver and bronze colonial coins are occasionally manufactured under the supervision of the London Mint. The existing London Mint was erected on Tower Hill in 1810. Minting in Scotland began in the reign of David I. (1124-1153) and ceased in 1709, two years after the Act of Union, in which it had been expressly stipulated that a mint should be continued in Scotland.¹ Coinage in Dublin began in Anglo-Saxon times and came to an end in the reign of William III.² The other Irish mints were of little importance.

British Dominions.—Turning to mints in British Dominions beyond the Seas, Ruding enumerates twenty-six mints in France and Flanders used by British monarchs between 1186 and 1513, and Anglo-Hanoverian coins were struck at Clauthal, Zellerfeld and Hanover in the period 1714-1837. In India³ the earliest English mint was that at Madras which was bought by the East India Company in 1620, reorganized more than once and finally closed in 1869. The Calcutta mint was established by the East India Company in 1757, but other mints in Bengal continued to be used till about 1835, when the Calcutta mint was rebuilt. The Bombay mint was set up about the year 1671, but the coins were made by hammer and anvil until 1800. The Calcutta and Bombay mints are still in operation. A mint was opened in Hong-Kong in 1866 but was closed in 1868 and the machinery sold to Japan. In Australia there are three mints, Sydney, opened in 1855, Melbourne, opened in 1872, and Perth, opened in 1899. Up to 1909 only sovereigns and half-sovereigns were struck at these establishments, but in 1910 arrangements were made for a Commonwealth silver coinage. A mint at Ottawa was opened in 1908 for the manufacture of all Canadian coins as well as English sovereigns.

Other Countries.—In the United States the Philadelphia mint was opened in 1792, but only manual or horse power was used until 1836, when steam was introduced. Other mints are now in operation at New Orleans, San Francisco and Denver. In most European countries a single mint situated at the capital is found to be sufficient, but there are six mints in the German Empire and two in Austria-Hungary. In China 26 mints were at work in 1906. There are also mints at Osaka, Bangkok and Teheran, and the Seoul mint was at work in 1904. In Mexico 11 mints formerly existed, but only one, in the city of Mexico, remained open in 1907. In South America there are mints at Lima, Santiago, Buenos Ayres and Tegucigalpa. No mints are in operation in Africa. In all there are nearly 70 mints in the world.

The Supply of Bullion to Mints.—In England, in the middle ages, the king was accustomed to send in to the mint the produce of his own silver mines, and claimed the exclusive privilege of purchasing the precious metals. The right of levying seigniorage, however, was sometimes waived by the king to encourage his subjects to bring gold and silver to the mint, and several instances are recorded in which the aid of alchemists was called in to effect the transmutation of baser metals into gold. Seigniorage was abolished for both gold and silver in 1666, when it was provided that no charge should be made at the Mint for coining and assaying. Finally in 1816 the free coinage of silver was brought to an end. At present all gold bullion brought to the Mint is weighed and portions are cut off for assay. The amount of gold in standard ounces (916.6 fine) corresponding to the "imported" bullion is thus ascertained, and on the application of the importer the gold is coined and delivered to him in the form of sovereigns and half-sovereigns at the rate of £3, 17s. 10½d. per standard ounce troy, no deduction being made for wastage, seigniorage, the purchase of alloy metal, or the expense of manufacture. As a considerable time elapses between the receipt of bullion by the Mint and the delivery of the coin, it is generally

more profitable for the holder of gold bullion to sell it to the Bank of England or dispose of it in some other way. The result is that the gold presented for coinage is almost always sent from the Bank of England, which suffers no loss of interest during the coinage of the bullion, because bank-notes have already been issued against it. Silver bullion, and the copper, tin and zinc required to make up bronze, are bought by the Mint and manufactured into coin, which is kept in stock and issued as it may be required. One ounce of standard silver, which contains 925 parts of silver and 75 of copper per 1000, is converted into 5s. 6d. in silver coin, whatever may be the market price of silver bullion. This seldom exceeded 30d. per ounce in the years 1893-1907. Coinage bronze consists of copper 95 parts, tin 4 parts and zinc 1 part, and a ton yields £448 in pence or £373, 6s. 8d. in halfpence or farthings. The difference between the nominal value of silver and bronze coin and its intrinsic value is retained by the state to cover the expenses of manufacture and as a source of profit. It corresponds to the seigniorage levied by the king on all coinages down to the reign of Charles II. In return, the Mint receives at its nominal value for recoinage the worn gold and silver coin which is withdrawn from circulation by the Bank of England and some other banks. In spite of the cost of this recoinage, however, the profit on the issue of new silver and bronze usually exceeds in each year the total expenditure of the Mint. Gold and silver are delivered in a refined state suitable for immediate conversion into coin. In general, only old coin, ingots resulting from the melting of coin, and "fine" ingots are received. Fine gold ingots (the "bar gold" of commerce) are usually about 400 oz. troy in weight, and contain from 990 to 999.5 parts of gold per 1000, the remainder being chiefly silver. Fine silver ingots usually weigh from 1000 to 1200 oz. troy and contain from 995 to 999 parts of silver per 1000. The ingots are valued by weighing and assaying, and a calculation is made as to the amount of copper required for melting with them to produce the standard alloy. The two standard alloys consist respectively of gold 916.6, copper 83.3 and of silver 925, copper 75. All gold coins received at the Bank are weighed on automatic balances (see below) and those below the lowest legal current weight are separated. The lowest current weight is 122.5 grains for sovereigns and 61.125 grains for half-sovereigns corresponding to losses by wear of about 0.6% and 0.8% respectively. The average age on withdrawal is about 24 years for sovereigns and 15 years for half-sovereigns. Silver coins are not weighed but are selected for withdrawal when they present a worn appearance. The average deficiency in weight of worn silver coin received at the Mint is from 8 to 10%, and the mean age somewhat less than 50 years. In European mints generally little difficulty is experienced in procuring refined gold and silver for coinage. In Australia, the United States, Japan and some other countries, the Mints receive unrefined gold from the mines and refine it before it is coined. A charge for refining is made in all cases. A refinery was attached to the London Mint from 1816 to 1851, but was then let on lease and left to private enterprise. The operations employed in the manufacture of gold and silver coin are as follow:—

- (1) Melting the metal and casting it into bars. (2) Rolling the bars into strips or "fillets." (3) Cutting out disks or blanks from the fillets. (4) Adjusting the weight of the blanks (this is omitted in some mints). (5) "Marking" or edge-rolling the blanks to produce a raised rim or to impress a design on the edge. (6) Annealing the blanks and (in some mints) cleaning them in acid. (7) Striking the blanks between dies surrounded by a collar. (8) Weighing each coin. Among the incidental operations are (a) the valuation of the bullion by weighing and assaying it; (b) "rating" the bullion, or calculating the amount of copper to be added to make up the standard alloy; (c) recovering the values from ground-up crucibles, ashes and floor sweepings (the Mint "sweep"); (d) assaying the melted bars; (e) "pyxing" the finished coin or selecting specimens to be weighed and assayed; (f) "telling" or counting the coin.

Melting.—Formerly bullion was melted in crucibles made of refractory clay, but they are liable to crack and require careful handling

¹ Grueber, *op. cit.* p. 11v.

² Ruding, *op. cit.* i. 245.

³ W. J. Hocking, *Catalogue of Coins in the Royal Mint*, i. 272, 275 and 279.

These were succeeded by iron crucibles, especially for melting silver, and these have now been generally replaced by graphite (plumbago) crucibles made of a mixture of clay and graphite. Good graphite crucibles can be used many times in succession if they are heated gradually each time, but they are usually discarded after about fifteen or twenty meltings. At the Royal Mint gold is melted in crucibles about 10 in. in height and 8½ in. in diameter at the widest part. The charge is from 1200 to 1300 oz. (37·3 to 40·5 kilograms) of metal. The furnace is 12 in. square and 2 ft. deep from the fire-bars to the cover. An old crucible is cut off about 2 in. from the bottom and the bottom piece is inverted and placed on the fire-bars as a support for the crucible. The "muffle," a graphite cylinder 6 in. in height, is placed on the crucible to allow room for long bars to be melted in the crucible and to prevent the surrounding

and C is the flue, common to two furnaces and leading to the stack. The handle D, acting through the gear wheels E, F, G and H, turns the cogwheel K, which moves the curved rack of the cradle and tips the crucible M. The molten metal is poured into the moulds N, which are carried on wheels running on rails Q. The parts of the range of moulds are brought tightly together and held in position by the bars O and the screw P, and when one mould is filled the carrier is moved forward on its rails by wheels worked by a handle also shown in the figure. In some other mints still larger crucibles are used, containing various amounts up to about 1000 kilograms or over 30,000 oz. In foreign mints the molten metal is generally transferred from the crucible to the moulds by dipping crucibles or iron ladles covered with clay. Gas is used as fuel for the melting furnaces at Philadelphia. It is cleaner than coke and is said to

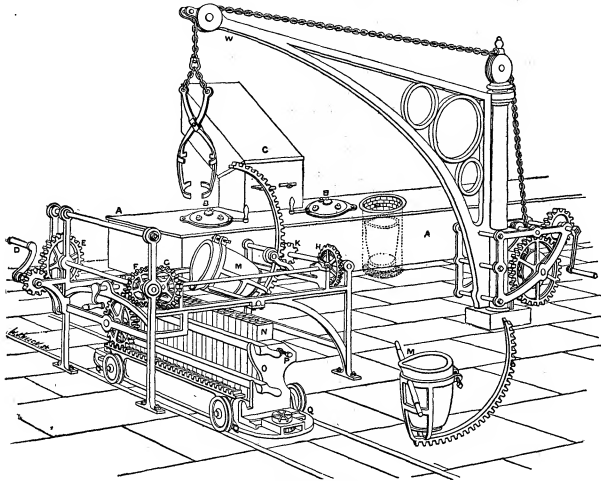

FIG. 1.—Furnace Apparatus.

coke from falling into it. The flue, of about 5 in. square, communicates with a stack 60 ft. high. In many mints the fumes pass into condensing chambers where volatilized gold and silver are recovered. The crucible is at a red heat when the gold is charged in, the copper being added last, and a graphite lid put on the crucible to check loss by volatilization. The charge is completely melted in about half an hour, and it is then thoroughly mixed by stirring with a graphite rod. The crucible is then lifted out by circular tongs suspended in such a way that two men can take part in the operation. The contents are poured by hand into moulds which are contained side by side in an iron carriage running on wheels, fig. 1, OP. The molten gold, which is of a pale green colour, solidifies at once in the iron moulds, and the bars can be taken out immediately. Bars from which sovereigns are to be coined are 22 in. long, 1½ in. wide and ¼ in. thick, and about seven such bars are cast from one pot. The rough edges of the bars are removed by a circular revolving file, and the hollow ends are cut off. Pieces are cut out for assay, and the bars are then ready for rolling. The amount of gold melted in an ordinary day's work is two tons to two and a half tons, of the value of £250,000 to £300,000. For silver larger crucibles are used, containing about 5000 oz. troy (155 kilograms). They are heated in circular furnaces 21 in. in diameter and lifted out with circular tongs suspended from a travelling crane which is worked by electricity. The crucible is placed in the pouring cradle, which has been in use since 1816, and is shown in fig. 1. Here A is the iron cover surrounding the furnaces, B is the revolving lid of a furnace,

save time and to reduce the loss of the precious metals. At Denver and Ottawa the fuel used is "first distillate" oil, which is found to be cheaper than either naphtha or gas. The oil is pumped from buried tanks and warmed to about 90° F. before it reaches the burners at the furnaces. At the Denver mint the crucibles are used for from twelve to fifteen meltings with oil fuel, whereas they were soon destroyed when gas was employed. A charge of 6000 oz. of gold is melted in about an hour. The melting losses amount to about 0·2 per 1000 of gold and 0·6 per 1000 of silver in the Royal Mint. The losses are caused by volatilization, by the absorption of metal by the crucible, stirring rod, &c., and by occasional projection of particles from the pot into the furnace. The ash-pit is lined with iron plates to facilitate the recovery of metal accidentally spilt. All crucibles and other materials which might contain precious metal are ground up and washed in a pan, and the panings together with a selection from the floor sweepings are remelted. The residues (the Mint "sweep") are sold to refiners or ore-smelters.

Rolling.—The cast bars are reduced to the thickness of the coin by repeated passages between rolls. These are cylinders of cast iron or steel from 6 in. to 15 in. in diameter set parallel to one another with a small interval between, and revolved by electric or steam power. They are divided into breaking-down and finishing rolls, the latter being of smaller diameter than the former. The power is usually transmitted through toothed wheels, each roll being driven independently in some cases, while sometimes power is applied to the lower roll only, the upper roll being coupled to it. The

power required for breaking down mint bars amounts to from 25 to 35 h.p. The bars are fed to the rolls by hand. Heavy pinches are applied at first, the space between the rolls being diminished by a hand-screw after each passage of the bars through them. When the bars are nearly to gauge, light pinches are given, the power required by finishing rolls being about 5 h.p. only. The reduction in thickness of the bars is accompanied by a slight increase in their width and a very great increase in their length, so that it is generally necessary to cut partly rolled bars into two parts to keep them of convenient dimensions. By repeated passages through the rolls the bars are hardened, and to facilitate further reduction they are usually softened by annealing before being passed to the finishing rolls. In some mints the fillets are annealed frequently, the fillets for one-mark pieces at the Berlin mint, for example, being annealed four times in the course of rolling. In this case the bars are reduced from 5½ mm. in thickness to 1½ mm. by being passed thirteen times through the rolls. At the Vienna mint the practice has been to anneal silver bars after each passage through the rolls. On the other hand, in the United States mints, the use of very carefully refined metal has made it possible to discontinue the annealing of partly rolled bars. In the Royal Mint silver bars are annealed once during rolling by passing through a Bates & Peard gas furnace. The fillets are placed on an endless chain which moves slowly through the furnace, returning underneath. At each end of the furnace is a trough of water which covers the furnace mouth, so that air is prevented from entering the furnace. The chain dips below the water, then rises into the furnace and passes down into the other trough on its way out. The result is that so long as the fillets are hot they are kept from contact with the air and blackening of the metal is prevented. In some mints the drag-bench or draw-bench is used after the rolls to equalize the thickness of the fillets. The fillet is drawn between two little steel cylinders which do not revolve and are held rigidly in position. The principle resembles that used in wire drawing. It was introduced by Sir John Barton at the Royal Mint in 1816 and was abandoned there in 1905. The thickness of the



FIG. 2.—Gauge Plate.

fillets is measured by the gauge-plate shown in fig. 2. When they have been reduced to the correct thickness they are examined by the "tryer," who cuts out one or two blanks from each fillet with a hand machine and weighs them on a delicate balance. If the weight of the blank is slightly below the standard weight, a somewhat larger cutter is used, so that the blanks may be of correct weight. If the blank is too heavy the fillet may of course be passed through the rolls again.

Remedy.—The degree of accuracy required is indicated by the "remedy" allowance for weight, which is different for each coin, and is the maximum difference from the standard weight which is allowed by law. In the sovereign it is 0.2 grain or about 1.62 per 1000. As the mean thickness of a sovereign is 0.0466 in., the remedy for weight corresponds to a difference of less than 1185 in. in the thickness of the fillet. The remedy for English silver coins varies from 2 grains or 4.58 per 1000 in the case of the crown, to 0.087 grain or 11.97 per 1000 in the case of the silver penny. The remedies for weight on foreign coins are in general greater than those allowed in the British Empire, averaging 2 per 1000 for gold coins. Reference may here be made to the similar working margin allowed in respect of the fineness of gold and silver. In England the remedy for fineness is 2 per 1000 on gold coins and 4 per 1000 on silver coins above and below the legal standard. This gold coin would be within the limits if they contained between 914.6 and 918.6 parts of gold per 1000. Remedies are intended to cover accidental variations from the exact standard and are now generally used only in this way. In former times, however, advantage was sometimes taken of the remedy as a means of profit. In the reign of Queen Elizabeth, the master of the Mint, finding the allowance under his contract to be insufficient, availed himself of the remedy on the silver coinage, which was amounting to 64½d. on the pound troy, or about 8.7 per 1000.

Cutting Blanks.—The cutting machine used in the Mint is shown in fig. 3. The revolution of an eccentric A causes two short steel cylinders or cutters mounted on a block of iron B, suitably guided, to enter two holes in a plate fixed to the bed of the machine. When the fillet FF is brought above the holes, the cutters descend and force disks of metal through the holes. After each descent of the cutters, the fillet is advanced by small gripping rolls C C' worked by a ratchet wheel E driven from the shaft which bears the eccentric A. The disks fall down the tube G to a receptacle on the floor. The cutters are so placed as to remove blanks in the manner shown in fig. 4, this arrangement leaving less "scissel" or residual metal than any other. In the case of very large silver coins only one blank is cut in the width of the fillet, but bronze fillets are made wider so that three penny blanks are

cut out at each stroke of the machine. The cutting machines at the Mint work at 160 revolutions per minute, so that each of the eleven machines would be capable of cutting 19,200 blanks in an hour if it could be fed continuously. The scissel, which amounts to about 30% of the metal operated on, is returned in bundles to the melting house.

Marking.—The blanks are then passed to an edge rolling machine, by which they are thickened at the edge so as to form a rim to protect the finished coin from wear. This operation is called marking, because originally the edges

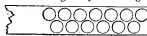

FIG. 4.

were not only thickened but were also marked with an inscription. This is still done, in the case of many foreign coins. The letters are sometimes sunk and sometimes raised. Like the graining or "milling" on the edge of many coins, the inscriptions were intended to put a stop to the practice of clipping and filing coins, which was prevalent in the 16th and 17th centuries. They also render the manufacture of counterfeit coin more difficult. At the Royal Mint the blanks are passed between the parallel faces of a revolving steel plate and fixed block. The plate has a circular groove in its face and the block has a corresponding curved groove.

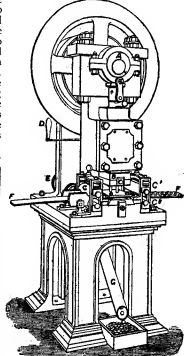

FIG. 3.—Cutting Machine.

The blank passes between the two faces.

The distance between the block and the plate is adjusted so as to be slightly less than the diameter of the blank, and the result is that the edge of the blank is thickened and its diameter reduced before it escapes from the machine. About 720 blanks are passed through this machine per minute.

In marking machines in some foreign mints the groove is in the periphery of the revolving wheel, and the grooved block is curved (fig. 5). The distance between the block and the plate is adjusted so as to be slightly less than the diameter of the blank, and the result is that the edge of the blank is thickened and its diameter reduced before it escapes from the machine. About 720 blanks are passed through this machine per minute.

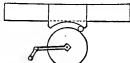

FIG. 5.

Annealing and Blanching the Blanks.—The blanks are next softened by annealing, and are then thoroughly cleaned before being passed to the coining presses. In England gold and copper blanks are protected from oxidation, and after their passage through the furnace are merely washed in colanders with water and dried with sawdust in a rotating drum. Silver blanks, however, are passed through rotary gas furnaces in which no attempt is made to exclude the air. The blanks are charged into a hopper at one end of the furnace and conveyed towards the other end by a revolving Archimedean screw. The blanks fall through an aperture after having been heated for a few minutes. They are at a dull red heat and are allowed to cool gradually in the air and become blackened by the formation on the surface of a film of oxide of copper. This is removed by solution in hot dilute sulphuric acid and a layer of pure frosted silver is left on the surface, which appears dead white in colour, and has lost its metallic lustre. The operation is called "blanching." A similar method was formerly used for gold coins in England and is still employed in some mints. The removal of part of the copper from the blank raises the percentage of silver contained in them and this is allowed for by adding an equivalent amount of copper to the metal when it is melted. The amount of copper removed from silver blanks containing 900 to 925 parts of silver per 1000 is from 0.6 to 1.0 per 1000. The process will probably be abandoned as soon as the tarnishing of the metal during rolling and annealing can be avoided.

Coining Press.—The blanks are converted into coin by receiving an impression from an engraved die. Each blank is placed on the lower die and the upper die is brought down forcibly upon it. The pressure causes the soft metal to flow like a viscous solid, but its lateral escape is prevented by a collar which surrounds the blank while it is being struck. The collar may be plain, or crenated ("milled"), or engraved with some device. In the last case the collar must be made in two or more pieces, as otherwise the coin could not be removed without injury. The collar for striking English crown pieces is made in three sections now that raised lettering is put on the edge of the coin. Sunk letters, such as occur on the edges

of many foreign coins, are put on by the marking machine, and a plain collar is used in striking.

The coining presses now used are all modifications of the lever press invented by Uhlhorn of Grevenbroich near Cologne in 1839. The

at the Mint strike from 90 to 125 coins per minute, most of them working at the rate of 110 coins per minute. There are 19 presses and it is possible with these to strike between 700,000 and 800,000 pieces in an ordinary working day.

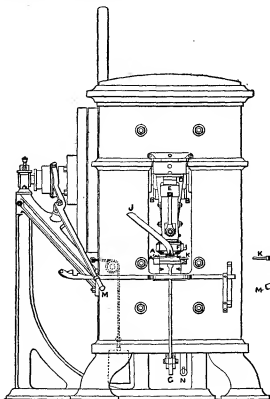

FIG. 6.

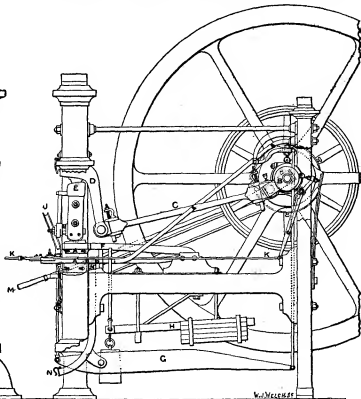

FIG. 7.

press in use at the Royal Mint since 1882 is shown in figs. 6 and 7. The lever M worked from the front of the machine causes the fly-wheel to be connected with the driving-wheel and the machine starts. The blanks are placed in the slide J and the lowest one is carried forward to the die in two successive movements of the "layer-on" K, a rod working backwards and forwards on a horizontal plate and actuating the finger L, fig. 8. The lower die is firmly fixed

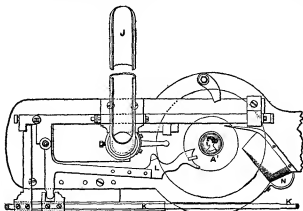

FIG. 8.

to the bed of the machine, and the blank is placed exactly upon it. The collar A' is then raised by the lever G so as to encircle the blank, and the upper die which is held at A is brought down. This is done by the little crank B on the axle of the fly-wheel, acting through the rod C, and the bent lever D, which forms a toggle-joint at E with the vertical piece of metal below it. The straightening of the toggle-joint when C is pushed forward forces A down to strike the coin. The reverse movement of D lifts up the upper die and the collar drops simultaneously so that its upper surface is level with the face of the lower die on which the finished coin lies. Another blank moved on by the finger L pushes off the finished coin which falls down the tube N. The diagram, fig. 9, shows the relative position of the dies and levers more clearly. The dies and collar are shaded. The presses

weighing the coins.—Gold and silver coins are examined and tested by ringing, and each coin is then weighed separately by being passed over delicate automatic balances.

The first automatic balance for weighing single coins was introduced at the Bank of England in 1843, and was designed by William Cotton, the deputy governor of the Bank. In 1851 these balances, improved by Richard Pilcher, were introduced at the Royal Mint, and modifications of them are now used at most foreign mints. For mint use it is necessary that they shall distinguish between "light," "heavy" and "good" coins which do not differ from standard by more than the small weight known as the "remedy" (see above). The balances used in the Royal Mint were further improved by J. T. Butler in the year 1889. The balance consists essentially of a beam with two scale pans, one for the coin and the other for the counterpoise. The beam is released and in the course of a second or so takes up a certain position dependent on the relative weights of the coin and counterpoise. Its position is then fixed by an automatic grip, and the coin falling down a shoot enters one of three compartments of a box, according to the position of the beam when it is arrested. The chief working parts are shown in fig. 10. The beam A is of steel made in one piece,

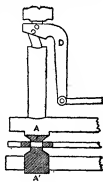

FIG. 9.



FIG. 10.

about 11 in. long. Its centre and end knife edges are shown in fig. 11. The scale pan for the coin is shown in fig. 12. B is the pan on which the coin rests, at a point above the beam. The coins are placed in a rouleau in the hopper C and the lowest one is pushed on to the pan B by a slide not shown in the figure. While the coin is being moved the hanger D is held firmly by the forceps E to prevent the pan from being pushed sideways. The forceps are then opened and the beam released, but at this moment the levelling bar F is allowed to drop momentarily by a bent lever G acting on the pin G', until the ends of F press down on a stirrup in each hanger at H, H. This brings the beam to a horizontal position. The lever G at once

lifts the bar F again by acting on the pin G' so that the bar F does not touch the stirrups at H and the beam and hangers are free to move. The coin is balanced by the brass counterpoise J on the left-hand hanger and by little weights made of wire attached to the right-hand hanger at K. If the coin is heavier than the lowest legal weight (that is, the standard weight less the remedy) the right-hand side of the beam begins to fall and the left-hand one is raised. This movement proceeds until the stirrup L below the left-hand hanger is raised far enough to touch the rod M, which is equal in weight to twice the remedy. The movement is then stopped provided that the weight of the coin is not greater than the standard weight plus the remedy. If it is heavier than this, it raises the

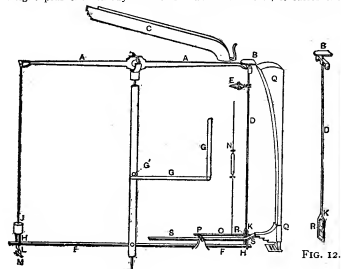

FIG. 11.

FIG. 12.

weight M, and the movement of the beam and its hangers proceeds farther in the same direction. After about a second from the time of the final release of the beam, the forceps E again close and the hanger D is held firmly in its new position. The rod N is then lowered and allows the indicating finger Q, which is pivoted at P, to fall until it rests on the stirrup R, which is part of the hanger D. The extension of O holds down the right-hand end of the rod S which is also pivoted at P, and enables its end to fit into one of the three inverted steps on the bottom of the shoot Q. The position of the shoot is thus determined. It stops over one of three orifices in the bottom plate of the balance. If the coin is light the rod S fits into the uppermost step and the shoot stops over the right-hand slot. If the coin is heavy, S fits into the lowest step and the shoot stops over the left-hand slot. The middle step and slot are for coins within the remedy. The movement of the slide now pushes another coin forward, and the weighed coin is displaced by it and falls down the shoot, through one of the slots. Each slot leads into a separate compartment and the coins are consequently sorted into three classes, light, correct weight and heavy. The balance turns to 0.01 grain. The driving power is applied by shafting through a number of cams. In the Royal Mint both light and heavy coins are returned to the melting pot. The proportion of rejected gold coin varies with the quality of the bullion, and frequently exceeds 10%. The percentage of rejected silver is often no more than 1%. In most foreign mints the blanks are weighed by the automatic balances before being struck, and those which are too heavy are reduced by filing or planing. A workman sitting at a balance files the edges of the piece and weighs it until it is within the remedy. The blank is then again passed through the automatic balance and is sent forward to the coining press if the correctness of the weight is confirmed. Since 1870 no adjusting of the weight of coins has been attempted at the Royal Mint. Heavy blanks have also been reduced chemically by making them part of the anode in a cyanide bath through which a current of electricity is passed. Some metal from the surface of each blank then passes into solution, and the blanks are reduced in weight with remarkable uniformity. This system was introduced into the Indian mints in 1873.

Telling.—The coin is counted and packed into bags for despatch from the Mint. The counting or telling is now carried out in the case of bronze and silver coins by ingenious machines introduced in 1891. The coins are spread on an inclined table by hand. They slide down the table and enter a narrow passage where only one can pass at a time, jamming being prevented by the joggling action of an eccentric rotating disk at the entrance to the passage. The coins are then gripped by a pair of india-rubber driving wheels, which force them past the rim of a thin disk with notches in its edge to fit the coins. As the disk is thus made to revolve, the coins are pushed forward, and falling down a shoot are received in a bag. The machine can be set to deliver a certain number of coins, after which the counting wheel stops automatically.

Trial of the Pyx.—Periodical examinations of the coins issued by the Mint have been made from very early times in England by persons appointed by the Crown. Specimens are selected from the finished coin and are put into a box or "pyx." At intervals these coins are weighed and assayed by a jury of skilled persons and the results reported to the Crown. A trial of the pyx is mentioned in the Lansdowne MSS. as having taken place in the reign of Henry II., but the practice had probably originated much earlier. The trial is now held annually by a jury consisting of freemen of the Company of Goldsmiths. Coins from the London and Australian mints are examined. The Company has been entrusted with the duty since the time of James I. Coins of foreign mints are generally submitted to examination by a committee of eminent chemists and metallurgists whose report is published in the official journals.

A full account of the work of the Mint, with valuable tables giving the amount of the coinage of gold and silver and bronze in the United Kingdom and the colonies in detail, and a *résumé* of the coinages of foreign countries, will be found in the *Annual Reports of the Deputy Master and Comptroller of the Mint*, which have been published since 1870. (T. K. R.)

MINTO, EARLS OF. The Scottish border family of Elliot which has held the earldom of Minto since 1813 has had many distinguished members. Sir Gilbert Elliot, bart. (1651-1718), and his son and successor, another Sir Gilbert Elliot (1693-1766), were both celebrated Scottish judges and both took the official title of Lord Minto. The elder Sir Gilbert was sentenced to death for his share in the rising of the earl of Argyll in 1685, but was afterwards pardoned; the younger Sir Gilbert was a scholar and an agriculturist. Among the children of the latter were John Elliot (d. 1808), a naval officer, who served as governor of Newfoundland and was made an admiral; Andrew Elliot, the last English governor of New York; and the poetess Jean, or Jane, Elliot (c. 1727-1805), who wrote the popular ballad "Flowers of the Forest." The eldest son, Sir Gilbert Elliot (1722-1777), who became the third baronet in April 1766, was a member of parliament from 1753 to 1777, and a friend and follower of the earl of Bute. He filled several public offices, and Horace Walpole said he was "one of the ablest members of the House of Commons." His second son was the diplomatist, Hugh Elliot (1752-1830), who represented his country at Munich, at Berlin, at Copenhagen and at Naples. He was governor of Madras from 1814 to 1820, and he died on the 10th of December 1830.

See the *Memoirs of the Right Hon. Hugh Elliot*, by the countess of Minto (Edinburgh, 1868).

The third baronet's eldest son was GILBERT ELLIOT, 1st earl of Minto (1751-1814). About 1765 Gilbert and his brother Hugh were sent to Paris, where their studies were supervised by David Hume and where they became intimate with Mirabeau. Having passed the winters of 1766 and 1767 at Edinburgh University, Gilbert entered Christ Church, Oxford, and on quitting the university he was called to the bar. In 1776 he entered parliament as an independent Whig. He became very friendly with Burke, whom he helped in the attack on Warren Hastings and Sir Elijah Impey, and on two occasions was an unsuccessful candidate for the office of speaker. In 1794 Elliot was appointed to govern Corsica, and in 1797 he assumed the additional names of Murray-Kynynmond and was created Baron Minto. From 1799 to 1801 he was envoy-extraordinary to Vienna, and having been for a few months president of the board of control he was appointed governor-general of India at the end of 1806. He governed with great success until 1813. He was then created Viscount Melgund and earl of Minto. He died at Stevenage on the 21st of June 1814 and was buried in Westminster Abbey.

The earl's second son was Admiral Sir George Elliot (1784-1863), who as a youth was present at the battles of Cape St Vincent and the Nile, and who was secretary to the admiralty from 1830 to 1834. A nephew of the earl was Sir Charles Elliot (1801-1875) also an admiral, who took a prominent part in the war with China in 1842. Afterwards he was governor of Bermuda, of Trinidad and of St Helena.

GILBERT ELLIOT-MURRAY-KYNNYMOND, 2nd earl of Minto (1782-1859), eldest son of the 1st earl, was ambassador to Berlin from 1832 to 1834, first lord of the admiralty from 1835 to 1841 and lord privy seal from 1846 to 1852. His influence in the Whig party was partly due to the fact that his daughter, Frances, was the wife of Lord John Russell.

His son William Hugh, the 3rd earl (1814-1891), was the father of the 4th earl, GILBERT JOHN ELLIOT-MURRAY-KYNYMUND (1845-), who joined the Scots Guards in 1867. In 1874, in the capacity of a newspaper correspondent, he witnessed the operations of the Carlists in Spain; he took service with the Turkish army in the war with Russia in 1877 and served under Lord Roberts in the second Afghan War (1878-79), having narrowly escaped accompanying Sir Louis Cavagnari Kabul. He acted as private secretary to Lord Roberts during his mission to the Cape in 1881; as military secretary to Lord Lansdowne during his governor-generalship of Canada from 1883 to 1885; and as chief of the staff to General Middleton in the Riel Rebellion in Canada (1885). Having succeeded to the earldom in 1891 he was appointed governor-general of Canada in 1898. His term of office (1898-1904) was distinguished by a visit of the prince and princess of Wales to the colonies. In 1905, on the resignation of Lord Curzon, Lord Minto was appointed viceroy and governor-general of India, retiring in 1910.

His 4th earl's brother, the Hon. Arthur Ralph Douglas Elliot (b. 1846), editor of the *Edinburgh Review*, was a member of parliament from 1880 to 1892 and again from 1898 to 1906, and from 1903 to 1906 he was financial secretary to the treasury. Sir Francis Edmund Hugh Elliot (b. 1851), a grandson of the 2nd earl, became British minister at Athens in 1903.

See Hon. G. F. S. Elliot, *The Borden Elliots and the Family of Minto* (Edinburgh, 1897); the article INDIA; *History*; also the *Life and Letters of the first Earl of Minto, 1751-1806* (1874) and *Lord Minto in India, 1807-1814* (1880), both edited by the countess of Minto; and Sir J. F. Stephen, *The Story of Nuncomar and the Impachment of Sir E. Impey* (1885).

MINTO, WILLIAM (1845-1893), Scottish man of letters, was born at Auchintoul, Aberdeenshire, on the 10th of October 1845. He was educated at Aberdeen University, and spent a year at Merton College, Oxford. He was assistant professor under Alexander Bain at Aberdeen for some years; from 1874 to 1878 he edited the *Examiner*, and in 1880 he was made full professor of logic and English at Aberdeen. In 1872 he published a *Manual of English Prose Literature*, which was distinguished by sound judgment and sympathetic appreciation; and his *Characteristics of English Poets from Chaucer to Shirley* (1874) showed the same high qualities. His other works include: *The Literature of the Georgian Era* (1894) edited with a biographical introduction by W. Knight; a monograph on Defoe in the *English Men of Letters series* (1879); three novels of small importance, and numerous articles on literary subjects in the 9th edition of the *Encyclopaedia Britannica*. He died on the 1st of March 1893.

MINTURNAE, an ancient city of the Aurunci, in Italy, situated on the N.W. bank of the Liris with a suburb on the opposite bank $1\frac{1}{2}$ m. from its mouth, at the point where the Via Appia crossed it by the Pons Tivertius. It was one of the three towns of the Aurunci which made war against Rome in 314 B.C., the other two being Ausona (see *SESSA AURUNCA*) and Vescia; and the Via Appia was made two years later. It became a colony in 295 B.C. In 88 B.C. Marius in his flight from Sulla hid himself in the marshes of Minturnae. The ruins consist of an amphitheatre (now almost entirely demolished, but better preserved in the 18th century), a theatre, and a very fine aqueduct in *opus reticulatum*, the quoins of which are of various colours arranged in patterns to produce a decorative effect. Close to the mouth of the river was the sacred grove of the Italic goddess Marica. It is still mentioned in the 6th century, but was probably destroyed by the Saracens, and its low site, which had become unhealthy, was abandoned in favour of that of the modern town of Minturno (known as Traetto until the 19th century), 459 ft. above sea-level. A tower at the mouth of the river, erected between 961 and 981, commemorates a victory gained by Pope John X. and his allies over the Saracens in 915. It is built of Roman materials from Minturnae, including several inscriptions and sculptures.

R. Laurent-Vibert and A. Piganol, *ibid.* (1907), p. 495; G. Q. Giglioli, *Notizie degli Scavi* (1908) p. 396. (T. As.)

MINUCIUS, FELIX MARCUS, one of the earliest if not the earliest, of the Latin apologists for Christianity. Of his personal history nothing is known, and even the date at which he wrote can be only approximately ascertained. Jerome (*De vir. ill.* 58) speaks of him as "Romae insignis caudicus," but in this he is probably only improving on the expression of Lactantius (*Inst. div. v. 1*) who speaks of him as "non ignobilis inter caudicos loci." He is now exclusively known by his *Octavius*, a dialogue on Christianity between the pagan Caecilius Natalis and the Christian Octavius Januarius, a provincial lawyer, the friend and fellow-student of the author. The scene is pleasantly and graphically laid on the beach at Ostia on a holiday afternoon, and the discussion is represented as arising out of the homage paid by Caecilius, in passing, to the image of Serapis. His arguments for paganism (possibly modelled on those of Celsus) are taken up seriatim by Octavius, with the result that the assailant is convinced. Minucius himself plays the part of umpire. The form of the dialogue is modelled on the *De natura deorum* and *De divinatione* of Cicero and its style is both vigorous and elegant if at times not exempt from something of the affectation of the age. Its latinity is not of the specifically Christian type. If the doctrines of the Divine unity, the resurrection, and future rewards and punishments be left out of account, the work has less the character of an exposition of Christianity than of a philosophical and ethical polemic against the absurdities of polytheism. While it thus has much in common with the Greek Apologies it is full of the strong common sense that marks the Latin mind. Its ultimate appeal is to the fruits of faith.

The *Octavius* is admittedly earlier than Cyprian's *Quod idola dei non sint*, which borrows from it; how much earlier can be determined only by settling the relation in which it stands to Tertullian's *Apologestum*. Since A. Ebert's exhaustive argument in 1868, repeated in 1890, the priority of Minucius has been generally admitted; the objections are stated in the *Dict. Chr. Biog.* article by G. Salmon. Editions: F. Sabaeus-Brixianus, as Bk. viii. of Arnobius (Rome, 1543); F. Balduinus, first separate edition (Heidelberg, 1560); Migne, *Patrol. Lat.* iii. 239; Halm in *Corp. Scr. Eccl. Lat.* (Vienna, 1867); H. A. Holden. Translations: R. E. Wallis, in *Ante-Nic. Fathers*, vol. iv.; A. A. Brodribb's *Pagan and Puritan Literature*. In addition to that already cited see H. Boenig's art. in Hauck-Herzog's *Realencyk.* vol. 13, and the various histories of early Christian literature by A. Harnack, G. Krüger, A. Ehrhard and O. Bardenhever.

MINUETO (adapted, under the influence of the Italian *minuetto*, from *Fr. menuet*, small, pretty, delicate, a diminutive of *menu*, from *Lat. minutus*; the word refers probably to the short steps, *pas menus*, taken in the dance), a dance for two persons, in $\frac{3}{4}$ time. At the period when it was most fashionable it was slow, ceremonious, and graceful (see DANCE). The name is also given to a musical composition written in the same time and rhythm, but when not accompanying an actual dance the pace was quicker. An example of the true form of the minuet is to be found in Don Giovanni. The minuet is frequently found as one of the movements in the Suites of Handel and Bach. Haydn introduced it into the symphony, with little trace of the slow grace and ceremony of the dance. In the hands of Beethoven it becomes the scherzo.

MINUSINSK, a town of Russia, in East Siberia, and the government of Yeniseisk, 180 m. S.S.W. of Krasnoyarsk railway station, and 5 m. from the right bank of the Yenisei, in a fertile prairie region. Pop. (1897), 10,255. It is a centre for trade with the native populations of the Sayan Mountains and north-western Mongolia. It has an excellent natural history, ethnographical and archaeological museum (1877), with a library and a meteorological station. Coal and iron abound in the vicinity.

¹ This name occurs in six inscriptions of the years 211-217 found at Constantine (Cirta), North Africa (*C.I.L.*, vol. viii.). Like the other North African fathers Tertullian, Cyprian, Arnobius and Lactantius, he was a lawyer. Some use may have been made of rhetorical expressions of M. Cornelius Fronto of Cirta (d. c. A.D. 170).

MINUTE (Lat. *minutus*, small; *minuere*, to make less), an adjective meaning of very small size, petty or trifling; also extremely precise. In this sense the word is pronounced *mi-ni-ite*. As a substantive and pronounced *minnit* the word (usually in the plural) is applied to a written summary of the transactions of a meeting of a public or other body, or to a memorandum of instructions, &c. A Treasury minute in the United Kingdom is an official memorandum authorizing certain procedure. "To minute" is to draw up such a summary or memorandum. More particularly, "minute" is used of the sixtieth part of any unit; in time, of an hour; and in astronomy, geometry, geography, &c., of a degree in the measurement of a circle. The sexagesimal system of division was originally used by the ancient Babylonian astronomers, was adopted by Ptolemy; and the sixtieth part of a degree, and its further subdivision into sixty parts, was called in Latin *pars minutae primae*, and *pars minutae secundae* respectively, hence the English "minute" and "second."

MINUTE MEN: in the American War of Independence, militia-men who had undertaken to turn out for service at a minute's notice. In Massachusetts the minute men were enrolled by an act of the provincial congress of the 23rd of November 1774, and in Boston alone they numbered 16,000 prior to the outbreak of the war. The Americans who fought in the opening action of Lexington were "minute men."

MIOCENE, in geology, the system of strata which occurs between the Oligocene and the Pliocene. The term, derived from the Greek *μῖον*, less, and *καινός*, recent, was introduced by Sir Charles Lyell, as indicating palaeontologically a less percentage of recent species than is found in the Pliocene. Variable lacustrine, estuarine and marine deposits, especially characterized by soft calcareous sandstones and conglomerates ("molasse" and sandy shell-beds ("faluns")), make up the Miocene system of the Neogene or newer Tertiary in Europe and western Asia, where it attains its fullest development.

A. de Lapparent's classification is here adopted:—
V. *Pontian* or *Pannonian*.—Brackish- and fresh-water marls, limestones and sandstones occurring at Vienna, in the Caspian and Mediterranean basins, and in southern France; mammalian deposits of Pikerri and the Siwalik Hills, with *Hipparion gracile*, *Mastodon longirostris*, *Rhinoceros scleromachus*, numerous ruminants, *Congeria subglobosa*. Marine beds of Belgium (Black Crag) and north Germany.

IV. *Sarmatian*.—More or less salt-water sands and marls of the same basins with *Mastodon angustidens*, *Anchitherium auriense*, *Cerithium pictum*, *C. rubiginosum*, *Ostrea ginsgensis*, *Mastra podolica*, *Tapes pregaris*. Stages IV. and V. represented in north-western France by marine sands (*Cardium stratiotissima*), and in Algeria and Morocco by marl marls and limestones.

III. *Vindobonian*.—Sub-stages:—
II. *Tortonian*: Marine marls with *Ancillaria glaudiviformis*, *Conus antiquus*, *Ranella marginata*, *Trochus patulus*, *Voluta varispina*. Laminated fresh-water limestones of Oeningen with fish, countless insects, and plants showing seasonal changes of the year in their successive layers (*Acer trilobatum*, *Populus mutabilis*, *Juglans acuminata*, *Camphora*, *Podogonium*), and the lacustrine deposits of central Spain.

(a) *Helvetian*: Marine shelly sandstones and conglomerates ("molasse" of Switzerland) with *Ostrea giganteis*, *Cardium jonanneti*, *Panopaea menardi*, *Conus ventricosus*; the "faluns" of Touraine and Aquitaine; and the marine beds of Black Sea basin. At the base of the marine Helvetian in the Vienna basin clays ("Schlier" with rock-salt and gypsum, and the lacustrine beds of Gascony (*Calcaire de Sigorre* with *Mastodon tapiroides*, *M. simorrensis*, *Dinotherium giganteum*) occur.

II. *Burdigalian* or *Langhian*.—Marine "faluns" of Bordeaux (*Olivia basteroti*, *Turritella teberulalis*); marls of Langhe in Liguria (*Pecten burdigalensis*); marine deposits of Vienna basin, Caspian region, Tunis and Algeria; fresh-water sands and marls of Orleans with *Mastodon angustidens*, *M. tapiroides*, *Dinotherium cuvieri*, *Anthracotheium noideum*; *Littorinella clays* of Mainz basin with *Aceratherium incisivum* *Littorinella acuta*, *Dreysenia bardi*; fresh-water grey "molasse" of Switzerland, with acacias, laurals, palms and sequoias.

I. *Aquitanian*.—Limestones, sands and marls of lakes and lagoons, with *Anthracotheium*, *Anchitherium*, *Acerotherium incisivum*, *Palaeocoelus typus*, *Helix ramondi*, *Limnaea pachyaster*, *Planorbis cornu*, *Polatimides lamarchi*; *Quercus*, *Acacia*, *Ficus*, *Camphora*, *Cinnamomum*, *Taxodium*, *Glyptostrobus*, *Sequoia*, *Sabal*, *Phoenix*; occur in central France (*Calcaire de la Beauce*); the plant-beds of Manosque; Mainz basin; lower "molasse" of Switzerland with

lignite, gypsum, red marls and conglomerates; "brown-coal series" of north Germany with lignite. Intercalated marine sandstones occur in Aquitaine and near Marseilles; other marine deposits occur in the "faluns" of Gascony (*Lepidocyclus mantelli*, *Miogyalina burdigalensis*), the upper Aquitanian of Bavaria and Austria-Hungary (*Ostrea crassissima*, *Pectunculus pilosus*), and in southern Spain, Italy and Malta (*Lepidocyclus* and *Lithothamnium*). Basic tufts and lavas occur in Auvergne.

Some authors assign Stage II. to the Oligocene, Stage V. to the Pliocene; Stages I. and II. correspond to the first, and III. to the second Mediterranean Stage of E. Suess.

In Europe a general emergence of land in late Oligocene time resulted at the beginning of the Miocene (Aquitanian) in widespread lacustrine conditions throughout the western part of that continent, upon which the sea encroached at few points, though it had gained access to the Vienna basin and extended westward into Bavaria. Otherwise, marine Aquitanian deposits are confined to the Mediterranean basin and the south-west corner of France. Most of northern Europe, including the British Isles, remained dry land throughout Miocene time. During the Burdigalian period, with increasing elevation of the mountain regions and depression of the Mediterranean and Caspian basins, a marine invasion began, which passed its maximum in the Vindobonian. The Mediterranean reached eastward to Persia, and, still open to the Atlantic, submerged north Africa, most of Italy and the neighbouring islands. It ascended the Rhone valley, penetrated to the Mainz basin, and skirting the north flank of the Alpine region passed into the Vienna basin and thence around the Carpathian tract into the Pontic and Caspian depression. The waters of the Atlantic further invaded the regions of the Garonne and the Loire, isolated Britain, and encroached upon north Europe between Belgium and Denmark.

The elevation of the Alps, and probably of the whole Alpine system of mountain folds from Morocco to Indo-China, though initiated by earlier Miocene and late Oligocene movements, took place mainly during the latter part of the Vindobonian period, and was completed in the Sarmatian. The waters of the ocean were then excluded from the Caspian and eastern Mediterranean basins, and replaced by vast fresh-water lakes; while brackish-water lagoons occupied much of the western Mediterranean. This general retreat of the sea, terminated in the Pontian stage, and the land-connexion was established between North and South America. Outside the Eurasian region, Aquitanian deposits occur in Formosa, Java, Borneo and Madagascar; while Burdigalian deposits are found in Mongolia. The Vindobonian ranges from Greenland, Iceland and Spitzbergen, where it contains lignite and plants denoting a temperate climate, by Japan, Java and India, to Victoria. It recurs in the Azores and the Antilles, and at intervals along the American continent from Patagonia to Alaska, where all three lower stages are represented, as also in the West Indies. Along the Atlantic slope of the United States and around the Gulf of Mexico the complete Miocene series is present, the Sarmatian and Pontian also occur in California.

The Miocene was a period of change, of mountain-building, climatic differentiation hitherto unprecedented, and of moderation in organic life, especially on land. The rich European flora indicates an equable and moist sub-tropical climate, slowly cooling, as witnessed by the gradual increase of trees with deciduous foliage among those characteristic of more tropical conditions. Oaks, maples, poplars, planes, willows, *Cinnamomum*, *Camphora*, *Myrica*, *Sequoia*, *Taxodium*, *Glyptostrobus* and palms, flourished together. The marine calcareous alga *Lithothamnium* became an important reef-building organism. New groups gave place to and replaced lamellibranchs and particularly gastropods abounded in the shallow seas, of which the shark *Carcharodon* and the marine mammals *Squalodon* and *Haltitherium* were among the largest denizens. The mammalian land-fauna of Europe made striking advances, and assumed a decidedly African aspect. Marsupials had disappeared from it before the Burdigalian period, during which primitive genera like *Palaeocoelus*, *Hypotamias*, and the hornless ruminants *Anthracotheium* and *Brachypodus*, became extinct, while prosociidians (*Mastodon*, *Dinotherium*), antelopes and apes (*Oreopithecus*, *Pithecius*) came in, followed by rhinoceroses, and probably *Machaerodus* in the Vindobonian. The spread of turf-forming grasses was succeeded in the Pontian by an enormous increase of herbivorous mammals, including *Hipparion* and horned ruminants (*Helladotherium*, *Antelope*, *Cervus*, *Camelopardalis*, *Palaeotragus*), whose migrations were facilitated by the desiccation of the Mediterranean basin. (C. B. W.)

MIOT DE MËLITO, ANDRÉ FRANÇOIS, COMTE (1762–1841), French statesman and scholar, was born at Versailles (Seine-et-Oise) on the 9th of February 1762. He was a high official in the war office before the Revolution, and under the Republic he eventually became secretary-general for foreign affairs. That he was not denounced under the Terror was due to the fact that he was indispensable in his department. In 1795 he was sent as French envoy to Florence; then to Rome, and on

his return to Florence received orders to proceed to Corsica, which, after its evacuation by the British, was in a state of anarchy. In Corsica he allied himself with Joseph Bonaparte, and after pacifying the island returned to Italy. Recalled by their Dictator in 1798 because of his refusal to foment insurrection in Italy, he spent some time in retirement, but he was in the diplomatic service in Holland at the revolution of 18. Brumaire (Nov. 9, 1799). Under the consulate he was secretary-general at the ministry of war, and a member of the council of state, and was sent on a second mission (1801-1802) for the pacification of Corsica. In 1806 he joined Joseph Bonaparte in Naples as minister of the interior, afterwards following him to Spain as comptroller of the household, but he returned to France in the retreat of 1813. Next year he was created comte de Mérito, and during the Hundred Days he served as commissary extraordinary with the XII. Army division. He took no part in politics after Waterloo, where his son-in-law, General J. B. Jamin, was killed, and his own son mortally wounded. He visited Joseph Bonaparte in America in 1825, and then spent some years in Germany with his daughter, whose second husband, General von Fleischmann, represented the king of Württemberg in Paris in 1831. He was admitted in 1835 to the French Academy on the merits of his translations of Herodotus (Paris, 1822) and Diodorus (Paris, 1835-1838). He died in Paris on the 5th of January 1841.

Miot de Mérito had kept a diary which, arranged for publication by his son-in-law, General von Fleischmann, covers the years from 1788 to 1815, and is of interest for the history of the Bonaparte family and of Joseph's dominion in Spain. Published in France in 1858, it was translated into English by Mrs C. Hoey and J. Lillie (2 vols., 1881); and also into German (Stuttgart, 1866-1867). See Albert Gaudin, *Les Arrêtés Miot* (Ajaccio, 1896).

MIQUEL, JOHANN VON (1829-1901), German statesman, was born at Neuenhaus, Hanover, on the 10th of February 1829, being descended from a French family which had emigrated during the Revolution. He learnt law at the universities of Heidelberg and Göttingen. Studying the writings of Karl Marx he became a convert to an extreme revolutionary, socialistic and atheistic creed; but though he entered into correspondence with Marx, with the object of starting a revolutionary movement, he does not appear to have taken any overt part in the events of 1848-1849. Further study of political economy soon enabled him to pass out of this phase, and in 1850 he settled down to practise as an advocate at Göttingen. He acquired repute as an able lawyer and a rising politician, and especially for his knowledge of financial questions. He was one of the founders of the German *Nationalverein*, and in 1864 he was elected a member of the Hanoverian parliament as a Liberal and an opponent of the government. He accepted the annexation of Hanover by Prussia without regret, and was one of the Hanoverians whose parliamentary abilities at once won a commanding position in the Prussian parliament, which he entered in 1867. For some reason—perhaps because Bismarck did not entirely trust him—he did not at this time attain quite so influential a position as might have been anticipated; nevertheless he was chairman of the parliamentary committee which in 1876 drafted the new rules of legal procedure, and he found scope for his great administrative abilities in the post of burgomaster of Osnabrück. He held this position from 1865 to 1870, and again from 1876 to 1879, being in the meantime (1870-1873) a director of the *Disconto-Gesellschaft*. In 1879 he was elected burgomaster of Frankfort-on-Main, where he gained a great reputation for the energy with which he dealt with social questions, especially that of the housing of the poor. Probably owing to his early study of socialism, he was very ready to support the new state socialism of Bismarck. He was the chief agent in the reorganization of the National Liberal party in 1887, in which year he entered the imperial Reichstag. After Bismarck's fall in 1890 he was chosen Prussian minister of finance, and held this post for ten years. He distinguished himself by his reform of the Prussian system of taxation, the one really successful measure of the new reign in internal affairs. An attempt, however, to reform the system of imperial finance in 1893-1894 failed, and much injured

his reputation. Miquel had entirely given up his Liberalism, and aimed at practical measures for improving the condition of the people irrespective of the party programmes; yet some of his measures—such as that for taxing "Waarenhäuser" (stores)—were of a very injudicious nature. He pressed to aim at a union of parties on the basis of the satisfaction of material interests, a policy to which the name of *Sammlung* was given; but his enemies accused him of constantly intriguing against the three chancellors under whom he served, and of himself attempting to secure the first place in the state. The sympathy which he expressed for the Agrarians increased his unpopularity among Liberals and industrialists; but he pointed out that the state, which for half a century had done everything to help manufacturers, might now attempt to support the failing industry of agriculture. In June 1901 the rejection of the canal bill led to a crisis, and he was obliged to send in his resignation. His health was already failing, and he died on the 8th of September of the same year at his house in Frankfurt.

MIQUELETS (MIQUELETES or MIGUELETES) were irregular local troops in Catalonia who derived their name, it is said, from Miguel or Miquelot de Prats, a Catalan mercenary captain in the service of Cesare Borgia. They enjoyed a certain prominence in the minor wars of Spain during the 17th and 18th centuries, and in peace seem to have plundered travellers. In the War of the Spanish Succession (*g.u.*) the Miquelets continued the struggle against the French claimant until long after the peace. During the Peninsular War they were exceedingly successful in harassing the French invaders in the mountains of Catalonia. Sometimes they even attempted operations in large bodies, as in the operations round Gerona in 1808 and 1809. They were maintained by the several parishes, not by the central or the provincial governments, and as they had to turn out for duty on sound of the village alarm-bell (*somalen*) they are frequently called *somatenes*.

MIRABEAU, ANDRÉ BONIFACE LOUIS RIQUETI, VICOMTE DE (1754-1792), brother of the orator Mirabeau, was one of the reactionary leaders at the opening of the French Revolution. Sent to the army in Malta in 1776 he spent part of his two years there in prison for insulting a religious procession. During the War of American Independence he was in several sea-fights with the English, and was at the taking of Yorktown in 1781. In the following year he had two narrow escapes from drowning. In 1789, with his debts paid up by his father, he was elected by the noblesse of Limoges a deputy to the States General. He was a violent Conservative and opposed everything that threatened the old régime. His drunkenness produced a complicity which brought him the nickname Mirabeau Tonneau ("Barrel Mirabeau"); but he was not lacking in some of that insight which marked his brother. He shared fully in the eccentric family pride; and boasted of his brother's genius even when bitterly opposing him. He emigrated about 1790, and raised a legion which was to bear his name; but his insolence alienated the German princes, and his command was taken from him. He died in August 1792—of apoplexy or from a duel—in Freiburg im Breisgau. He wrote some works as well as various pamphlets.

See Joseph Sarrazin, *Mirabeau Tonneau, ein Condottiere aus der Revolutionszeit* (Leipzig, 1893); and *La Révolution française, vols. xxi. and xxiv.*; Eugène Berger, *Le Vicomte de Mirabeau (Mirabeau Tonneau), 1754-1792* (1904); and for a list of contemporary pamphlets, &c., M. Tournoux, *Bibliographie de la ville de Paris* . . . , vol. iv. (1906).

MIRABEAU, HONORÉ GABRIEL RIQUETI, COMTE DE (1749-1791), French statesman, was born at Bignon, near Nemours, on the 9th of March 1749. The family of Riquet, or Riquetti, originally of the little town of Digne, won wealth as merchants at Marseilles, and in 1570 Jean Riquetti bought the château and seigniorship of Mirabeau, which had belonged to the great Provençal family of Barras. In 1685 Honoré Riquetti obtained the title of marquis de Mirabeau. His son Jean Antoine served with distinction through all the later campaigns of the reign of Louis XIV., and especially distinguished himself in 1705 at the battle of Cassano, where he was so severely wounded in

the neck that he had ever after to wear a silver stock; yet he never rose above the rank of colonel, owing to an eccentric habit of speaking unpleasant truths to his superiors. On retiring from the service he married Françoise de Castellane, and left at his death, in 1737, three sons—Victor marquis de Mirabeau, Jean Antoine, bailli de Mirabeau, and Comte Louis Alexandre de Mirabeau. The great Mirabeau was the eldest surviving son of the marquess. When but three years old he had a virulent attack of small-pox which left his face disfigured, and contributed to his father's dislike of him. Being destined for the army, he was entered at a pension militaire at Paris. Of this school, which had Lagrange for its professor of mathematics, we have an amusing account in the life of Gilbert Elliot, 1st earl of Minto, who with his brother Hugh, afterwards British minister at Berlin, there made the acquaintance of Mirabeau. On leaving this school in 1767 he received a commission in a cavalry regiment which his grandfather had commanded years before. He at once began love-making, and in spite of his ugliness succeeded in winning the heart of the lady to whom his colonel was attached; this led to such scandal that his father obtained a *lettre de cachet*, and the young scapegrace was imprisoned in the isle of Ré. The love affairs of Mirabeau form a well-known history, owing to the celebrity of the letters to Sophie. Yet it may be asserted that until the more durable and more reputable connexion with Mme de Nehra these love episodes were the most disgraceful blemishes in a life otherwise of a far higher moral character than has been commonly supposed. As to the marquess, his use of *lettres de cachet* is perfectly defensible on the theory of *lettres de cachet*, and Mirabeau, if any son, surely deserved such correction. Further, they had the effect of sobering the culprit, and the more creditable part of his life did not begin till he left Vincennes. Mirabeau did not develop his great qualities of mind and character until his youthful excesses were over, and it was not till 1781 that these began to appear. On being released, the young count obtained leave to accompany as a volunteer the French expedition to Corsica. After his return, he tried to keep on good terms with his father, and in 1772 he married a rich heiress, Marie Emilie, daughter of the marquess de Marignane, an alliance procured for him by his father. His wild extravagance, however, forced his father to forestall his creditors by securing his detention in semi-exile in the country, where he wrote his earliest extant work, the *Essai sur le despotisme*. His violent disposition now led him to quarrel with a country gentleman who had insulted his sister, and his semi-exile was changed by *lettre de cachet* into imprisonment in the Château d'If. In 1775 he was removed to the castle of Joux, to which, however, he was not very closely confined, having full leave to visit in the town of Pontarlier. Here he met Marie Thérèse de Monnier, his Sophie as he called her. Of his behaviour nothing too strong can be said: he was introduced into the house as a friend, and betrayed his trust by inducing Mme de Monnier to fall in love with him. The affair ended by his escaping to Switzerland, where Sophie joined him; they then went to Holland, where he lived by hack-work for the booksellers; meanwhile Mirabeau had been condemned to death at Pontarlier for *rapt et vol*, and in May 1777 he was seized by the French police, and imprisoned by a *lettre de cachet* in the castle of Vincennes.

During his imprisonment he seems to have learnt to control his passions from their very exhaustion, for the early part of his confinement is marked by the indecent letters to Sophie (first published in 1793), and the obscene *Erotica biblion* and *Ma conversion*, while to the later months belongs his political work of any value, the *Lettres de cachet*, published after his liberation (1782). It exhibits an accurate knowledge of French constitutional history skillfully applied in an attempt to show that an existing actual grievance was not only philosophically unjust but constitutionally illegal. It shows, though in rather a diffuse and declamatory form, that application of wide historical knowledge, keen philosophical perception, and genuine eloquence to a practical purpose which was the great characteristic of Mirabeau, both as a political thinker and as a statesman.

With his release from Vincennes (August 1782) begins the

second period of Mirabeau's life. He found that his Sophie was an idealized version of a rather common and ill-educated woman, and she consoled herself with the affection of a young officer, after whose death she committed suicide. Mirabeau first set to work to get the sentence of death still hanging over him reversed, and by his eloquence not only succeeded in this but got M. de Monnier condemned in the costs of the whole law proceedings. From Pontarlier he went to Aix, where he claimed the court's order that his wife should return to him. She naturally objected, but his eloquence would have won his case, even against Jean Etienne Marie Portalis, the leader of the Aix Bar, had he not in his excitement accused his wife of infidelity, on which the court pronounced a decree of separation. He then intervened in the suit pending between his father and mother before the parlement of Paris, and attacked the ruling powers so violently that he had to leave France and again go to Holland, and try to live by literary work. About this time began his connexion with Mme de Nehra, the daughter of Zwier van Haren, a Dutch statesman and political writer, and a woman of a far higher type than Sophie, more educated, more refined, and more capable of appreciating Mirabeau's good points. His life was strengthened by the love of his *petite horde*, Mme de Nehra, his adopted son, Lucas de Montigny, and his little dog Chico. After a period of work in Holland he betook himself to England, where his treatise on *lettres de cachet* had been much admired, being translated into English in 1787, and where he was soon admitted into the best Whig literary and political society of London, through his old schoolfellow Gilbert Elliot, who had now inherited his father's baronetcy and estates, and became a leading Whig member of parliament. Of all his English friends none seem to have been so intimate with him as the 1st marquess of Lansdowne, better known as Lord Shelburne, and Mr. afterwards Sir Samuel, Romilly. The latter became particularly attached to him, and really understood his character; and it is strange that his remarks upon Mirabeau in the fragment of autobiography which he left, and Mirabeau's letters to him, should have been neglected by French writers. Romilly was introduced to Mirabeau by Sir Francis D'Ivernois (1757-1842), and readily undertook to translate into English the *Considerations sur l'ordre de Cincinnati*, which Mirabeau had written in 1785. Romilly writes thus of him in his autobiography:—

"The count was difficult enough to please; he was sufficiently impressed with the beauties of the original. He went over every part of the translation with me, observed on every passage in which justice was not done to the thought or the force of the expression lost, and made many useful criticisms. During this occupation we had occasion to see one another often, and became very intimate; and, as he had read much, had seen a great deal of the world, was acquainted with all the most distinguished persons who at that time adorned either the royal court or the republic of letters in France; had a great knowledge of French and Italian literature, and possessed very good taste, his conversation was extremely interesting and not a little instructive. I had such frequent opportunities of seeing him at this time, and afterwards at a much more important period of his life, that I think his character was well known to me. I doubt whether it has been so well known to the world, and I am convinced that great injustice has been done him. This, indeed, is not surprising, when one considers that, from the first moment of his entering upon the career of an author, he had been altogether indifferent how numerous or how powerful might be the enemies he should provoke. His vanity was certainly excessive; but I have no doubt that, in his public conduct as well as in his writings, he was desirous of doing good, that his ambition was of the noblest kind, and that he proposed to himself the noblest ends. He was, however, like many of his countrymen, who were active in the calamitous Revolution which afterwards took place, not sufficiently scrupulous about the means by which those ends were to be accomplished. He indeed to some degree professed this; and more than once I have heard him say that there were occasions upon which 'la petite morale était ennemie de la grande.' It is not surprising that with such maxims as these in his mouth, unguarded in his expressions and careless of his reputation, he should have afforded room for the circulation of many stories to his disadvantage."

This luminous judgment, it must be noted, was written by a man of acknowledged purity of life, who admired Mirabeau in early life not when he was a statesman, but when he was only a struggling literary man. The *Considerations sur l'ordre*

de *Cincinnatus* which Romilly translated was the only important work Mirabeau wrote in the year 1785, and it is a good specimen of his method. He had read a pamphlet published in America attacking the proposed order, which was to form a bond of association between the officers who had fought in the American War of Independence against England; the arguments struck him as true and valuable, so he re-arranged them in his own fashion, and rewrote them in his own oratorical style. He soon found such work not sufficiently remunerative to keep his *petite horde* in comfort, and then turned his thoughts to employment from the French foreign office, either in writing or in diplomacy. He first sent Mme de Nehra to Paris to make peace with the authorities, and then returned himself, hoping to get employment through an old literary *collaborateur* of his, Durival, who was at this time director of the finances of the department of foreign affairs. One of the functions of this official was to subsidize political pamphleteers, and Mirabeau had hoped to be so employed, but he ruined his chances by a series of writings on financial questions. On his return to Paris he had become acquainted with Étienne Clavière, the Genevese exile, and a banker named Panchaud. From them he heard plenty of abuse of stock-jobbing, and seizing their ideas he began to regard stock-jobbing, or agiotage, as the source of all evil, and to attack in his usual vehement style the Banque de St Charles and the Compagnie des Eaux. This last pamphlet brought him into a controversy with Caron de Beaumarchais, who certainly did not get the best of it, but it lost him any chance of literary employment from the government. However, his ability was too great to be neglected by a great minister such as Charles Gravier, Comte de Vergennes undoubtedly was, and after a preliminary tour to Berlin at the beginning of 1786 he was despatched in July 1786 on a secret mission to the court of Prussia, from which he returned in January 1787, and of which he gave a full account in his *Histoire secrète de la cour de Berlin* (1789). The months he spent at Berlin were important in the history of Prussia, for while he was there Frederick the Great died. The letters just mentioned show clearly what Mirabeau did and what he saw, and equally clearly how unfit he was to be a diplomatist. He certainly failed to conciliate the new king Frederick William; and thus ended Mirabeau's one attempt at diplomacy. During his journey he had made the acquaintance of Jakob Mauvillon (1743-1794), whom he found possessed of a great number of facts and statistics with regard to Prussia; these he made use of in a great work on Prussia published in 1788. But, though his *De la monarchie prussienne sous Frédéric le Grand* (London, 1788) gave him a general reputation for historical learning, he had in the same year lost a chance of political employment. He had offered himself as a candidate for the office of secretary to the Assembly of Notables which the king had just convened, and to bring his name before the public published another financial work, the *Démonstration de l'agiotage*, which abounded in such violent diatribes that he not only lost his election, but was obliged to retire to Tongres; and he further injured his prospects by publishing the reports he had sent in during his secret mission at Berlin. But 1789 was at hand; the states-general was summoned; Mirabeau's period of probation was over.

On hearing of the king's determination to summon the states-general, Mirabeau started for Provence, and offered to assist at the preliminary conference of the noblesse of his district. They rejected him; he appealed to the *tiers état*, and was returned both for Aix and for Marseilles. He elected to sit for the former city, and was present at the opening of the states-general on the 4th of May 1789. From this time the record of Mirabeau's life forms the best history of the first two years of the Constituent Assembly, for at every important crisis his voice is to be heard, though his advice was not always followed. He possessed at the same time great logical acuteness and the most passionate enthusiasm. From the beginning he recognized that government exists in order that the bulk of the population may pursue their daily work in peace and quiet, and that for a government to be successful it must be strong. At the same time he thoroughly

comprehended that for a government to be strong it must be in harmony with the wishes of the majority of the people. He had carefully studied the English constitution in England, and he hoped to establish in France a system similar in principle but without any slavish imitation of the details of the English constitution. In the first stage of the history of the states-general Mirabeau's part was very great. He was soon recognized as a leader, to the chagrin of Jean Joseph Mounier, because he always knew his own mind, and was prompt in emergencies. To him is to be attributed the successful consolidation of the National Assembly. When the taking of the Bastille had assured the success of the Revolution, he warned the Assembly of the futility of passing fine-sounding decrees and urged the necessity for acting. He declared that the famous night of the 4th of August was but an orgy, giving the people an immense theoretical liberty while not assisting them to practical freedom, and overthrowing the old régime before a new one could be constituted. His failure to control the theorists showed Mirabeau, after the removal of the king and the Assembly to Paris, that his eloquence would not enable him to guide the Assembly by himself, and that he must therefore try to get some support. He wished to establish a strong ministry, which should be responsible like an English ministry, but to an assembly chosen to represent the people of France better than the English House of Commons at that time represented England. He first thought of becoming a minister at a very early date, if we may believe a story contained in the *Mémoires* of the duchesse d'Abrantes, to the effect that in May 1789 the queen tried to bribe him, but that he refused this and expressed his wish to be a minister. The indignation with which the queen repelled the idea may have made him think of the duke of Orleans as a possible constitutional king, because his title would of necessity be parliamentary. But the weakness of Orleans was too palpable, and in a famous remark Mirabeau expressed his utter contempt for him. He also attempted to form an alliance with Lafayette, but the general was as vain and as obstinate as Mirabeau himself, and had his own theories about a new French constitution. Mirabeau tried for a time, too, to act with Necker, and obtained the sanction of the Assembly to Necker's financial scheme, not because it was good, but because, as he said, "no other plan was before them, and something must be done."

Hitherto weight has been laid on the practical side of Mirabeau's political genius; his ideas with regard to the Revolution after the 5th and 6th of October must now be examined, and this can be done at length, thanks to the publication of Mirabeau's correspondence with the Comte de La Marck, a study of which is indispensable for any correct knowledge of the history of the Revolution between 1789 and 1791. Auguste Marie Raymond, prince d'Arenberg, known as the Comte de la Marck, was a Flemish nobleman who had been proprietary colonel of a German regiment in the service of France; he was a close friend of the queen, and had been elected a member of the states-general. His acquaintance with Mirabeau, begun in 1788, ripened during the following year into a friendship, which La Marck hoped to turn to the advantage of the court. After the events of the 5th and 6th of October he consulted Mirabeau as to what measures the king ought to take, and Mirabeau, delighted at the opportunity, drew up an admirable state paper, which was presented to the king by Monsieur, afterwards Louis XVIII. The whole of this *Mémoire* should be read to get an adequate idea of Mirabeau's genius for politics; here it must be summarized.

The main position is that the king is not free in Paris; he must therefore leave Paris and appeal to France. "Paris n'en veut que l'argent; les provinces demandent des lois." But where must the king go? "Se retirer à Metz ou sur toute autre frontière: serait déclarer la guerre à la nation et abdiquer le trône. Un roi qui est la seule sauvegarde de son peuple ne fuit point devant son peuple; il le prend pour juge de sa conduite et de ses principes." He must then go towards the interior of France to a provincial capital, best of all to Rouen, and there he must appeal to the people and summon a great convention. It would be ruin to appeal to the noblesse, as the queen advised: "un corps de noblesse n'est point une armée, qui puisse combattre." When this great convention met the

king must show himself ready to recognize that great changes have taken place, that feudalism and absolutism have for ever disappeared, and that a new relation between king and people has arisen, which must be loyally observed on both sides for the future. "Il est certain, d'ailleurs, qu'il faut une grande révolution pour sauver le royaume, que la nation a des droits, qu'elle est en chemin de les recouvrer tous, et qu'il faut non seulement les rétablir, mais les consolider." To establish this new constitutional position between king and people would not be difficult, because "l'indivisibilité du monarque et du peuple est dans le cœur de tous les Français; il faut qu'elle existe dans l'action et le pouvoir."

Such was Mirabeau's programme, from which he never diverged, but which was far too statesmanlike to be understood by the poor king, and far too positive regarding the altered condition of the monarchy to be palatable to the queen. Mirabeau followed up his *Mémoire* by a scheme of a great ministry to contain all men of mark—Necker as prime minister, "to render him as powerless as he is incapable, and yet preserve his popularity for the king," the duc de Liancourt, the duc de la Rochefoucauld, La Marck, Talleyrand, bishop of Autun, at the finances, Mirabeau without portfolio, G. J. B. Target, mayor of Paris, Lafayette generalissimo to reform the army, Louis Philippe, comte de Ségur (foreign affairs), Mounier and I. R. G. le Chapelier. This scheme got noised abroad, and was ruined by a decree of the Assembly of the 7th of November 1790, that no member of the Assembly could become a minister; this decree destroyed any chance of that necessary harmony between the ministry and the majority of the representatives of the nation which existed in England, and so at once overthrew Mirabeau's hopes. The queen utterly refused to take Mirabeau's counsel, and La Marck left Paris. However, in April 1790 he was suddenly recalled by the comte de Mercy-Argenteau, the Austrian ambassador at Paris, and the queen's most trusted political adviser, and from this time to Mirabeau's death he became the medium of almost daily communications between the latter and the queen. Mirabeau at first attempted again to make an alliance with Lafayette, but it was useless, for Lafayette was not a strong man himself and did not appreciate "la force" in others. From the month of May 1790 to his death in April 1791 Mirabeau remained in close and suspected, but not actually proved, connexion with the court, and drew up many admirable state papers for it. In return the court paid his debts; but it ought never to be said that he was bribed, for the gold of the court never made him swerve from his political principles—never, for instance, made him a royalist. He regarded himself as a minister, though an unavowed one, and believed himself worthy of his hire.

Before Mirabeau's influence on foreign policy is discussed, his behaviour on several important points must be noticed. On the great question of the veto he took a practical view, and seeing that the royal power was already sufficiently weakened, declared for the king's absolute veto and against the compromise of the suspensive veto. He knew from his English experiences that such a veto would be hardly ever used unless the king felt the people were on his side, and that if it were used unjustifiably the power of the purse possessed by the representatives of the people would, as in England in 1688, bring about a bloodless revolution. He saw also that much of the inefficiency of the Assembly arose from the inexperience of the members and their incurable verbosity; so, to establish some system of rules, he got his friend Romilly to draw up a detailed account of the rules and customs of the English House of Commons, which he translated into French, but which the Assembly, puffed up by a belief in its own merits, refused to use. On the great subject of peace and war he supported the king's authority, and with some success. Again Mirabeau almost alone of the Assembly held that the soldier ceased to be a citizen when he became a soldier; he must submit to be deprived of his liberty to think and act, and must recognize that a soldier's first duty is obedience. With such sentiments, it is no wonder that he approved of the vigorous conduct of François Claude Amour, marquis de Bouillé, at Nancy, which was the more to his credit as Bouillé was the one hope of the court influences opposed to him. Lastly,

in matters of finance he showed his wisdom: he attacked Necker's "caisse d'escompte," which was to have the whole control of the taxes, as absorbing the Assembly's power of the purse; and he heartily approved of the system of assignats, but with the reservation that they should not be issued to the extent of more than one-half the value of the lands to be sold.

Of Mirabeau's attitude with regard to foreign affairs it is necessary to speak in more detail. He held it to be just that the French people should conduct their Revolution as they would, and that no foreign nation had any right to interfere with them while they kept themselves strictly to their own affairs. But he knew also that neighbouring nations looked with unquiet eyes on the progress of affairs in France, that they feared the influence of the Revolution on their own peoples, and that foreign monarchs were being prayed by the French émigrés to interfere on behalf of the French monarchy. To prevent this interference, or rather to give no pretext for it, was his guiding thought as to foreign policy. He had been elected a member of the *comité diplomatique* of the Assembly in July 1790, and became its reporter at once, and in this capacity he was able to prevent the Assembly from doing much harm in regard to foreign affairs. He had long known Armand Marc, comte de Montmorin, the foreign secretary, and, as matters became more strained from the complications with the princes and counts of the empire, he entered into daily communication with the minister, advised him on every point, and, while dictating his policy, defended it in the Assembly. Mirabeau's exertions in this respect are not his smallest title to the name of statesman; and how great a work he did is best proved by the confusion which ensued in this department after his death. For indeed in the beginning of 1791 his death was very near; and he knew it to be so. The wild excesses of his youth and their terrible punishment had weakened his strong constitution, and his parliamentary labours completed the work. So surely did he feel its approach that some time before the end he sent all his papers over to Sir Gilbert Elliot, who kept them under seal until claimed by Mirabeau's executors. In March his illness was evidently gaining on him, to his great grief, because he knew that he alone could yet save France from the distrust of her monarch and the present reforms, and from the foreign interference, which would assuredly bring about catastrophes unparalleled in the history of the world. Every care that science could afford was given by his friend and physician, Cabanis, to whose brochure on his last illness and death the reader may refer. The people kept the street in which he lay quiet; but medical care, the loving solicitude of friends, and the respect of all the people could not save his life. When he could speak no more he wrote with a feeble hand the one word "dormir," and on the 2nd of April 1791 he died.

No man ever so thoroughly used other men's work, and yet made it all seem his own. "Je prends mon bien où je le trouve" is as true of him as of Molière. His first literary work, except the bombastic but eloquent *Essai sur le despotisme* (Neuchâtel, 1775), was a translation of Robert Watson's *Philip II.*, done in Holland with the help of Durival; his *Considérations sur l'ordre de Cincinnati* (London, 1788) was based on a pamphlet by Aedanus Burke (1743-1802), of South Carolina, who opposed the aristocratic tendencies of the Society of the Cincinnati, and the notes to it were by Target; his financial writings were suggested by the Genevese exile Clavière. During the Revolution he received yet more help; men were proud to labour for him, and did not murmur because he absorbed all the credit and fame. Etienne Dumont, Clavière, Antoine Adrien Lamourette and Etienne Salomon Reybaz were but a few of the most distinguished of his collaborators. Dumont was a Genevese exile, and an old friend of Romilly's, who willingly prepared for him those famous addresses which Mirabeau used to make the Assembly pass by sudden bursts of eloquent declamation; Clavière helped him in finance, and not only worked out his figures, but even wrote his financial discourses; Lamourette wrote the speeches on the civil constitution of the clergy; Reybaz not only wrote for him his famous speeches on the assignats, the organization of the national guard, and others, which Mirabeau read word for word at the tribune, but even the posthumous speech on succession to the estates of intestates, which Talleyrand read in the Assembly as the last work of his dead friend. Yet neither the gold of the court nor another man's conviction would make Mirabeau say what he did not himself believe, or do what he did not himself think right. He took

other men's labour as his due, and impressed their words, of which he had suggested the underlying ideas, with the stamp of his own individuality; his collaborators themselves did not complain—they were but too glad to be of help in the great work of controlling and forwarding the French Revolution through its greatest thinker and orator. As an orator his eloquence has been likened to that of both Bossuet and Vergniaud, but it had neither the polish of the old 17th century bishop nor the flashes of genius of the young Girardin. It was rather parliamentary oratory in which he excelled, and his true compeer was only Burke and Fox than any French speaker. Personally he had that which is the truest mark of nobility of mind, a power of attracting love and winning faithful friends. (H. M. S.)

AUTHORITIES.—The best edition of Mirabeau's works that is published by Blanchard in 1819-1822, in ten volumes, of which the first two contain his *Œuvres oratoires*; from this collection, however, many of his less important works and the *De la monarchie prussienne* are omitted. For details of his life consult Peuchet, *Mirabeau: Mémoires sur sa vie littéraire et privée* (1824); and the *Mémoires biographiques, littéraires et politiques de Mirabeau, écrits par lui-même, par son père, son oncle et son fils adoptif*, which was issued by his adopted son, Lucas de Montigny (8 vols., Paris, 1834-1835). See also Etienne Dumont, *Souvenirs sur Mirabeau* (1832), a work which has been translated into English by Lady E. R. Seymour as *The Great Frenchman and the Little Genevese* (1904); Louise Colet, *La Jeunesse de Mirabeau* (1841); and Alfred Bégis, *Mirabeau, son interdiction judiciaire* (1895). The publication of the *Correspondance entre Mirabeau et le comte de la Marck*, by A. de Bacourt (2 vols., 1851) marks an epoch in our exact knowledge of Mirabeau and his career; some additional letters appeared in the *Germania* (1853) and in *Le Correspondant* (1852). Other published correspondence is *Lettres de Mirabeau à Chamfort* (1796); *Lettres du comte de Mirabeau à Jacques Mawillon* (Brunswick, 1792); *Lettres originales de Mirabeau, écrites du donjon de Vincennes, 1777-1780*, published by L. P. Manuel (4 vols., 1792); and, on the same subject, Paul Cottin, *Sophie de Monnier et Mirabeau d'après leur correspondance inédite* (1903); *Lettres à Julie*, edited by D. Meunier and G. Selois (Paris, 1903); *Lettres inédites* (1806), edited by J. F. Vitry. *The Histoire secrète* forms the basis of H. Welschinger's *La Mission secrète de Mirabeau à Berlin* (Paris, 1900). The most useful modern books are Louis and Charles de Lamoignon, *Les Mirabeaux* (2 vols., 1878 and 1889); Alfred Stern, *Das Leben des Mirabeau* (1889). See also E. Roux, *Mirabeau* (1891) in the *Grands Ecrivains Français* series; P. Plan, *Un Collaborateur de Mirabeau* (Paris, 1874), treating of Reybaz and throwing infinite light on Mirabeau's mode of work; and H. Reynald, *Mirabeau et la constituante* (1873). On his eloquence and the share his collaborators had in his speeches see F. A. Aulard, *Orateurs de l'assemblée constituante* (1882). For his death see the curious brochure of his physician, Cabanis, *Journal de la maladie et de la mort de Mirabeau* (Paris, 1791, ed. H. Duchene, Paris, 1890). There is a good sketch summarizing modern opinion by E. Charavay in *La Grande Encyclopédie*. English works include P. F. Willert, *Mirabeau* (1898) in the "Foreign Statesman" series; C. F. Warwick, *Mirabeau and the French Revolution* (1905); W. R. H. Trowbridge, *Mirabeau, the demi-god* (1907); H. E. von Holst, *The French Revolution Tested by Mirabeau's Career* (Chicago, 1894); and F. Fling, *Mirabeau and the French Revolution* (London and New York, 1908). Other works are Victor Hugo, *Étude sur Mirabeau* (1834); Jules Barni, *Mirabeau* (1882); Albert Sorel, "Mirabeau" in *Essais d'histoire et de critique* (1883); G. Loloit, *Mirabeau à Pontarlier* (1886); Ferdinand Schwartz, *Mirabeau und Marie Antoinette* (Basel, 1891); and Alfred Mézières, *Vie de Mirabeau* (1892).

MIRABEAU, VICTOR RIQUETTI, MARQUIS DE (1715-1789), French author and political economist, father of the great Mirabeau, was born at Pertuis, near the old château de Mirabeau, on the 4th of October 1715. He was brought up very sternly by his father, and in 1728 joined the army. He took keenly to campaigning, but never rose above the rank of captain, owing to his being unable to get leave at court to buy a regiment. In 1737 he came into the family property on his father's death, and spent some pleasant years till 1743 in literary companionship with duc Clapiers, marquis de Vauvenargues and the poet Lefranc de Pompignan, which might have continued had he not determined to marry—not for money, but for landed estates. The lady whose property he fancied was Marie Gencviève, daughter of a M. de Vassan, a brigadier in the army, and widow of the marquis de Saulveboef, whom he married without previously seeing her on the 21st of April 1743. While in garrison at Bordeaux Mirabeau had made the acquaintance of Montesquieu, and after retiring from the army he wrote his first work, his *Testament Politique* (1747), which demanded for the prosperity of France a return of the French noblesse to their old position in the middle ages. This work was followed in 1750 by a book on the *Utilité*

des états provinciaux, which was attributed to Montesquieu himself. In 1756 Mirabeau made his first appearance as a political economist by the publication of his *Ami des hommes ou traité de la population*. This work has been often attributed to the influence, and in part even to the pen, of Quesnay, the founder of the economical school of the physiocrats, but was really written before the marquis had made the acquaintance of the physician of Madame de Pompadour. In 1760 he published his *Théorie de l'impôt*, in which he attacked with all the vehemence of his son the farmers-general of the taxes, who got him imprisoned for eight days at Vincennes, and then exiled to his country estate at Bignon. At Bignon the school of the physiocrats was really established, and the marquis in 1765 bought the *Journal de l'agriculture, du commerce, et des finances*, which became the organ of the school. He was recognized as a leader of political thinkers by Prince Leopold of Tuscany, afterwards emperor, and by Gustavus III. of Sweden, who in 1772 sent him the grand cross of the order of Vasa. But his marriage had not been happy; he had separated from his wife in 1762, and had, he believed, secured her safely in the provinces by a letter de cachet, when in 1772 she suddenly appeared in Paris, and commenced proceedings for a separation. One of his own daughters had encouraged his wife to take this step. He was determined to keep the case quiet, if possible, for the sake of Mme de Pailly, a Swiss lady whom he had loved since 1756. But his wife would not let him rest; her plea was rejected in 1777, but she renewed her suit, and, though the great Mirabeau had pleaded his father's case, was successful in 1781. This trial quite broke the health of the marquis, as well as his fortune; he sold his estate at Bignon, and hired a house at Argenteuil, where he lived quietly till his death on the 11th of July 1789.

The marquis's younger brother, JEAN ANTOINE RIQUETTI, "the bailli" (d. 1794), served with distinction in the navy, but his brusque manners made success at court impossible. In 1763 he became general of the galleys of Malta. In 1767 he returned to France and took charge of the château de Mirabeau, helping the marquis in his disastrous lawsuits.

See Louis de Loménie's *Les Mirabeau* (2 vols., 1879). Also Henri Ripert, *Le Marquis de Mirabeau, ses théories politiques et économiques, thèse pour le doctorat* (Paris, 1901); Oncken, *Der ältere Mirabeau und die ökonomische Gesellschaft in Bern* (Berne, 1886); De Lavergne, *Les Economistes français du 18^{me} siècle*.

MIRACLE (Lat. *miraculum*, from *mirari*, to wonder), anything wonderful, beyond human power, and deviating from the common action of the laws of nature, a supernatural event. The term is particularly associated with the supernatural factors in Christianity. To the Lat. *miraculum* correspond Gr. *répas* in the New Testament, and Heb. *מוֹפֵת* (Exod. xv. 11; Dan. xii. 6) in the Old Testament. Other terms used in the New Testament are *δύναμις* "with reference to the power residing in the miracle worker" (cf. *נְסִיחַ* Deut. iii. 24 and *מוֹפֵת* Num. xvi. 30), and *σημεῖον* "with reference to the character or claims of which it was the witness and guarantee" (cf. *מֹעַד* Exod. iv. 8); that the power is assumed to be from God is shown by the phrases *πνεῦμα θεοῦ* (Matt. xii. 28; cf. Luke iv. 18) and *δακτύλου θεοῦ* (Luke xi. 20).

While Augustine describes miracles as "contra naturam quæ nobis est nota," Aquinas without qualification defines them as "praeter naturam," supra et contra naturam." Löschner affirms in regard to miracles that "solut Deus potest tum supra naturæ vires tum contra naturæ leges agere;" and Buddaeus argues that in them a "suspensio legum naturæ" is followed by a *restitutio*. Against the common view that miracles can attest the truth of a divine revelation Gerhard maintained that "per miracula non possunt probari oracula;" and Höpflner returns to the qualified position of Augustine when he describes them as "praeter et supra naturæ ordinem." The two conceptions, once common in the Christian church, that on the one hand miracles involved an interference with the forces and a suspension of the laws of nature, and that, on the other hand, as this could be effected only by divine power, they served as credentials of a divine revelation, are now generally abandoned. As regards the first point, it is now generally held that miracles are exceptions to the order of nature as known to our common experience; and as regards the second, that miracles are constituent elements in the divine revelation, deeds which display

the divine character and purpose; but they are signs and not merely seals of truth. Some of the theories regarding miracles which have been formulated may be mentioned. Bonnet, Euler, Haller, Schmid and others "suppose miracles to be already implanted in nature. The miraculous germs always exist alongside other germs in a sort of sheath, like hidden springs in a machine, and emerge into the light when their time comes. Similar is the view of Paracelsus and of Pierre Cardan who "suppose a twofold world, existing one in the ether, beside or behind the visible, is an inner, ideal world, which breaks through in particular spots" (Dorner's *System of Christian Doctrine*, ii. 155, 156). The 8th duke of Argyll (*Reign of Law*) maintains that "miracles may be wrought by the selection and use of laws of which man knows and can know nothing, and which, if he did know, he could not employ." These theories endeavour to discover the means by which the exceptional occurrence is brought about; but the explanation is merely hypothetical, and we are not helped in conceiving the mode of the divine activity in the working of miracles. The important consideration from the religious standpoint is that God's activity should be fully recognized.

An attempt has been made to discover a natural law which will explain some at least of the miracles of Jesus. "In one respect alone," says Matthew Arnold, "have the miracles recorded by the evangelists a more real ground than the mass of miracles of which we have the relation. Medical science has never gauged, perhaps never even set itself to gauge the intimate connexion between moral fault and disease. To what extent or in how many cases what is called illness is due to moral springs having been used amiss, whether by being over-used, or by not being used sufficiently, we do not at all know; but the other, certainly it is due to this very much more than we commonly think, and the more it is due to this the more do moral therapeutics rise in possibility and importance" (*Literature and Dogma*, pp. 143-144). The moral therapeutics consists in the influence of a powerful will over others. Harnack accepts this view. "We see that a firm will and a convinced faith act even on the bodily life and cause appearances which appear to us as miracles. Who has hitherto here with certainty measured the realm of the possible and the real? Nobody. Who can say how far the influences of one soul on another soul and of the soul on the body reach? Nobody. Who can still say that in this realm appears as striking rests only on deception and error? Certainly no miracles occur, but there is enough of the wonderful and the inexplicable" (*Das Wesen des Christentums*, p. 18). As regards the theory, it may be pointed out: (1) that the nature or cosmical miracles—feeding of the five thousand, stilling of the storm, withering of the fig-tree—are as well-attested as the miracles of healing; (2) that many of the diseases, the cure of which is reported, are of a kind with which moral therapeutics could not effect anything; (3) that Christ's own insight regarding the power by which He wrought His works is directly challenged by this explanation, for He never failed to ascribe His power to the Father dwelling in Him.

The divine agency is recognized as combining and controlling, but not as producing, in the teleological notion of miracles. "In miracle no new powers, instituted or stimulated by God's creative action, are at work, but merely the general order of nature"; but "the manifold physical and spiritual powers in actual existence so blend together as to produce a startling result" (Dorner's *System of Christian Doctrine*, ii. 157). While we cannot deny, we have no ground for affirming the truth of this theory. Whether God's action is creative, or only selective and directive in miracles, is beyond our knowledge; we at least do not know the powers engaged, whether new or old.

An attempt is made to get rid of the distinctive nature of miracle when the exceptionalness of the events so regarded is reduced to a new subjective mode of regarding natural phenomena. H. E. G. Paulus dismisses the miracles as "exaggerations or misapprehensions of quite ordinary events." A. Ritschl has been unjustly charged with this treatment of miracles. But what he emphasizes is on the one hand the close connexion between the conception of miracles and the belief in divine providence, and on the other the compatibility between miracle and the order of nature. He declines to regard miracles as divine action contrary to the laws of nature. So for Schleiermacher "miracle is neither explicable from nature alone, nor entirely alien to it." What both Ritschl and Schleiermacher insist on is that the belief in miracles is inseparable from the belief in God, and in God as immanent in nature, not only directing and controlling its existent forces, but also as initiating new stages consistent with the old in its progressive development.

"We may accept Dorner's definition as adequate and satisfactory. "Miracles are sensuously cognizable events, not comprehensible on the ground of the causality of nature as such, but essentially on the ground of God's free action alone. Such facts find their possibility in the constitution of nature and God's living relation to it, their necessity in the aim of revelation, which they subserve" (p. 161). By the first clause, inward moral and religious changes due to the operation of the Spirit of God in man are excluded, and

rightly so (see INSPIRATION). The negative aspect is presented in the second clause. This is prominent in J. S. Mill's definition of miracles: "to constitute a miracle, a phenomenon must take place without having been preceded by any antecedent phenomenal conditions sufficient again to reproduce it. . . . The test of a miracle is, were there present in the case such external conditions, such second causes we may call them, that wherever these conditions or causes reappear the event will be reproduced. If there were, it is not a miracle; if there were not, it is" (*Essays*, p. 224). The positive aspect is presented in the third clause. When the existence of God is denied (atheism), or His nature is declared unknowable (agnosticism), or He is identified with nature itself (pantheism), or He is so distinguished from the world that His free action is excluded from the course of nature (deism), miracle is necessarily denied. Thus Spinoza, identifying God and nature, declares "nothing happens in nature which is in contradiction with its universal laws." The deists, compelled by their view of the relation of God to nature to regard miracles as interventions, disposed of the miracles of the Bible either as "mistaken allegory" or even as conscious fraud on the part of the narrators. It is only the theistic view of God as personal power—that is as free-will ever present and ever active in the world, which leaves room for miracles.

The possibility of miracles is often confidently denied. "We are of the unalterable conviction," says Harnack, "that what happens in time and space is subject to the universal laws of movement; that accordingly there cannot be any miracles in this sense, i.e. as interruptions of the continuity of nature" (*Das Wesen des Christentums*, p. 17). Huxley expresses himself much more cautiously, as he recognizes that we do not know the continuity of nature so thoroughly as to be able to declare that this or that event is necessarily an interruption of it. "If a dead man did come to life the fact would be evidence, not that any law of nature had been violated, but that these laws, even when they express the results of a very long and uniform experience, are necessarily based on incomplete knowledge, and are to be held only on grounds of more or less justifiable expectation" (*Hume*, p. 135).

Lotze has shown how the possibility of miracle can be conceived. "The whole course of nature becomes intelligible only by supposing the co-working of God, who alone carries forward the reciprocal action of the different parts of the world. But that view which admits a life of God that is not benumbed in an unchangeable sameness will be able to understand his eternal co-working as a variable quantity, the transforming influence of which is felt at particular moments and attests that the course of nature is not shut out from its own life. And thus, when the conditions completely conditioning causes of the miracle will be found in God and nature together, and in that eternal action and reaction between them which perhaps, although not ordered simply according to general laws, is not void of regulative principles. This vital, as opposed to a mechanical, constitution of nature, together with the conceptions of nature as not complete in itself—as if it were severed from the divine energy—shows how a miracle may take place without any disturbance elsewhere of the constancy of nature, all whose forces are affected sympathetically, with the consequence that its orderly movement goes on unhindered" (*Mikrokosmos*, iii. 364).

The mode of the divine working in nature is in another passage more clearly defined.

"The closed and hard circle of mechanical necessity is not immediately accessible to the miracle-working fiat, nor does it need to be; but the inner nature of that which obeys its laws is not determined by it but by the meaning of the world. This is the open place on which a power that commands in the name of this meaning can exert its influence; and if under this command the inner condition of the elements, the magnitudes of their relation and their opposition to each other, become altered, and the necessity of the mechanical cause of the world may unfold this new state into a miraculous appearance, not through suspension but through strict maintenance of its general laws" (*op. cit.* ii. 54).

If we conceive God as personal, and His will as related to the course of nature analogously to the relation of the human will to the human body, then the laws of nature may be regarded as habits of the divine activity, and miracles as unusual acts which, while consistent with the divine character, mark a new stage in the fulfilment of the purpose of God.

The doctrine of Evolution, instead of increasing the difficulty of conceiving the possibility of miracle, decreases it; for it presents to us the universe as an uncompleted process, and one in which there is no absolute continuity on the phenomenal side; for as well as the modifications by their physical accidents, and as there is not only room for, but need of, the divine initiative, a creative as well as conservative co-operation of God with nature. Such an absolute continuity is sometimes assumed without warrant; but Descartes already recognized that the world was no continuous process, "Tria mirabilia fecit Dominus; res ex nihilo, liberum arbitrium et hominem Deum." That life cannot be explained by force is recognized by Sir Oliver Lodge. "Life may be something not only ultra-terrestrial, but even immaterial, something outside our present categories of matter and energy; as real as they are, but

¹ See also R. J. Myle, "The Neurotic Theory of the Miracles of Healing," *Hibbert Journal*, v. 586.

different, and utilizing them for its own purpose" (*Life and Matter*, p. 108). The theory of *psychophysical parallelism* recognizes that while there is a correspondence between mental and material phenomena, changes in the mind and changes in the brain, the former cannot be explained by the latter, as the transition from the one to the other is unthinkable. William James distinguishes the *transmissive* function of the brain from the *productive* in relation to thought, and admits only the former, and not the latter (*Human Immortality*, p. 32). Thus as life is transcendent and yet immanent in body, and mind in brain, and both utilize their organs, so God, transcendent and immanent, uses the course of nature for His own ends, and the emergence both of life and mind in that course of nature evidences such a divine initiative as is assumed in the recognition of the possibility of miracles. For such an initiative there must be adequate reason; it must be prepared for in the previous process, and it must be necessary to further progress.

The proof of the possibility of miracle leads us inevitably to the inquiry regarding the *necessity* of miracle. The necessity of miracles is displayed in their connexion with the divine revelation; but this connexion may be conceived in two ways. The miracles may be regarded as the *credentials* of the agents of divine revelation. It is an acknowledged historical fact, says Butler, that Christianity offered itself to the world, and was demanded to be received, upon the allegation—i. e. as unbelievers would speak—upon the pretence of miracles, publicly wrought to attest the truth of it, in such an age; and that it was actually received by great numbers in that very age, and upon the professed belief of the reality of miracles" (*Analogy*, part ii. ch. vii.). This view is now generally abandoned, for it is recognized that acts of superhuman power, even if established by adequate historical evidence, do not necessarily certify their divine origin. Their moral quality must correspond with the character of God; and they must be connected with teaching which to reason and conscience approves itself divine. "Miracula sine doctrina nihil valent" is the principle now generally recognized. The miracle and the doctrine mutually illuminate one another. "Les miracles discernent la doctrine, et la doctrine discernent les miracles" (*Pascal's Pensées des miracles*). Accordingly, the *credentials* must also be *constituents* of the revelation. Of the miracles of Jesus, Bushnell says, "The character of Jesus is ever shining with and through them, in clear self-evidence leaving them never to stand as raw wonders only of might, but covering them with glory as tokens of a heavenly love, and acts that only suit the proportions of His personal greatness and majesty" (*Nature and the Supernatural*, p. 364). If it be asked why the character may not be displayed in ordinary instances, the answer may be given, "Miracles are the certificate of identity between the Lord of Nature and the Lord of Conscience—the proof that He is really a moral being who subordinates physical to moral interests" (Lidden's *Elements of Religion*, p. 73). As God is the Saviour, and the chief end of the revelation is redemption, it is fitting that the miracles should be acts of divine deliverance from physical evil. This congruity of the miracle with divine truth and grace is the answer to Matthew Arnold's taunt about turning a pen into a pen-wiper or Huxley's about a centaur trotting down Regent Street. The miracles of Jesus—the relief of need, the removal of suffering, the recovery of health and strength—reveal in outward events the essential features of His divine mission. The divine wisdom and goodness are revealed in the course of nature, but also obscured by it. The existence of physical evil, and still more of moral evil, forbids the assumption without qualification that the real is the rational. God in nature as well as history is fulfilling a redemptive as well as perfective purpose, of which these miracles are appropriate signs. It is an unwarranted idealism and optimism which finds the course of nature so wise and so good that any change in it must be regarded as incredible. On the problem of evil and sin it is impossible here to enter; but this must be insisted on, that the miracles of Jesus at least express divine benevolence just under those conditions in which the course of nature obscures and forbids therefore proper elements in a revelation of grace, of which nature cannot give any evidence.

Having discussed the possibility and necessity of miracles for the divine revelation, we must now consider whether there is sufficient historical evidence for their occurrence. Hume maintains that no evidence, such as is available, can make a miracle credible. Mill states the position with due care. "The question can be stated fairly as depending on a balance of evidence, a certain amount of positive evidence in favour of miracles, and a negative presumption from the general course of human experience against them" (*Essays on Religion*, p. 221). The existence of "a certain amount of positive evidence in favour of miracles" forbids the strongest statement that miracles are "contrary to experience." The phrase itself is, as Paley has pointed out, ambiguous. "If it means all experience it assumes the point to be proved; if it means only common experience then it simply asserts that the miracle is unusual—a truism. The probability of miracles depends on the conception we have of the free relation of God to nature, and of nature as the adequate organ for the fulfilment of God's purposes. If we believe in a divine revelation and redemption, transcending the course of nature, the miracles as signs of that divine purpose will not seem improbable.

For the Christian Church the miracles of Jesus are of primary importance; and the evidence—external and internal—in their favour may be said to be sufficient to justify belief. The Gospels assumed their present form between A.D. 60 and 90. Their representation of the moral character, the religious consciousness, the teaching of Jesus, inspires confidence. The narratives of miracles are woven into the very texture of this representation. In these acts Jesus reveals Himself as Saviour. "The Jesus Christ presented to us in the New Testament would become a very different person if the miracles were removed" (*Temple's Relations between Religion and Science*). In His sinless perfection and filial relation to God He is unique, and His works are congruous with His Person. Of the supreme miracle of His resurrection there is earlier evidence than of any of the others (1 Cor. xv. 3-7, before A.D. 58). His conquest of death is most frequently appealed to in the apostolic teaching. The Christian Church would never have come into existence without faith in the Risen Lord. The proof of the supernaturalness of His Person sets the seal to the credibility of His supernatural works. In Christ, however, was the fulfilment of law and prophecy. This close connexion invests the antecedent revelation in some degree with the supernaturalness of His Person; at least, we are prepared to entertain without prejudice any evidence that may be presented in the Old Testament. That this evidence is not as good as that for the miracles of Jesus must be conceded, as much of it is of much later date than the events recorded. The miracles connected with the beginnings of the national history—the period of the Exodus—appear on closer inspection to have been ordinarily natural phenomena, to which a supernatural character was given by their connexion with the prophetic word of Moses. The miracles recorded of Elijah and Elisha lie somewhat apart from the main currents of the history, the narratives themselves are distinct from the historical works in which they have been incorporated, and the character of some of the actions raises serious doubts and difficulties. In some cases suspense of judgment seems necessary even from the standpoint of Christian faith. The supernatural element that is prominent in the Old Testament is God's providential guidance and guardianship of His people, and His teaching and training of them by His prophets. The Apostolic miracles, to which the New Testament bears evidence, were wrought in the power of Christ, and were evidences to His church and to the world of His continued presence. When the Church had established itself in the world, and possessed in its moral and religious fruits evidence of its claims, these outward signs appear gradually to have ceased, although attempts were made to perpetuate them. It is true that in Roman Catholicism, in medieval as in modern times, the miracle has been a staple of its teaching; but the character of most of these miracles is such as to lack the *a priori probability* which has been claimed for the Scripture miracles on account of their connexion and congruity with the divine revelation. The *a posteriori evidence* as regards both its moral and religious quality and its date is altogether inferior to the evidence of the Gospels. Further, these records are imitative. As Christ and the apostles wrought miracles, it is assumed that those who in the Church were distinguished for their sanctity would also work miracles; and there can be little doubt that the wish was often father to the thought. There may be cases which cannot be explained in this way; but whatever may be thought about them, it is plain that even if these and their like are really to be traced to the intervention of the divine mercy which loves to reward a simple faith (and it does not seem to us that the evidence is sufficient to establish such a conclusion), yet they do not serve as vehicles of revelation as the miracles of the Gospel did" (H. J. Bernard in *Hastings's Bible Dictionary*, iii. 395). (A. E. G. *)

MIRA DE AMESCUA, ANTONIO (1578?–1636 ?), Spanish dramatist, was born at Guadix (Granada) about 1578. He is said, but doubtfully, to have been the illegitimate son of one Juana Perez; he took orders, obtained a canonry at Guadix, and settled at Madrid early in the 17th century. He is mentioned as a prominent dramatist in Rojas Villandrando's *Loa* (1603), which was written several years before it was published. In 1610, being then arch-dean of Guadix, he accompanied the count de Lemos to Naples, and on his return to Spain was appointed (1619) chaplain to the cardinal Infante Ferdinand of Austria; he is referred to as still alive in Montalbán's *Para todos* (1632), and he collaborated with Montalbán and Calderón in *Poliéfemo y Circe*, printed in 1634. The date of his death is not known. Mira de Amescua's plays are dispersed in various printed collections, and the absence of a satisfactory edition has prevented his due recognition. He has an evenness of execution which indicates an artistic conscience uncommon in Spanish playwrights; he resisted the temptation to write too much, and he unites a virile quality of expression to impressive conception of character.

Two of his plays—*La Adversa fortuna de Don Bernado de Cabrera*

and *El ejemplo mayor de la desdicha*—are respectively the sources of Rotrou's *Don Bernardo de la Cabriere* and *Beisaisire*; Moreto's *Cae para levantar* is simply a recast of Mira's *El Esclavo del demonio*, a celebrated drama which clearly influenced Calderón when composing *La Devoción de la cruz*; and there is manifestly a close relation between Mira's *La Rueda de la fortuna* on the one hand and Corneille's *Héraclius* and Calderón's *En esta vida todo es verdad y todo es mentira*. A few of Mira de Amescua's plays are reprinted in the *Biblioteca de autores españoles*, vol. xlv.

MIRAGE (a French word, from *miser*, to look at, *se mirer*, to be reflected), an optical illusion due to variations in the refractive index of the atmosphere. It embraces the phenomena of the visionary appearance of lakes in arid deserts, the images of ships and icebergs, frequently seen as if inverted and suspended in the atmosphere in the Polar Regions, the *Fata Morgana*, and "looming" as witnessed in mists or fogs.

In the article **REFRACTION** it is shown that a ray of light traversing a homogeneous medium is deviated from its rectilinear path when it enters a medium of different refractive index; it is therefore readily seen that the path of a ray through continuously varying media is necessarily curvilinear, being compounded of an infinite number of infinitesimally small rectilinear deviations. Our atmosphere is a medium of continuously varying refractive index. Meteorological optical phenomena, due to variations in the refractive index of the atmosphere, may be divided into groups: (1) those due to the permanent or normal variation experienced as one ascends in the atmosphere, and (2) those due to sporadic variations occasioned by irregular heating. The first variation must be taken into account in correcting geodetic observations of heights and astronomical observations of the heavenly bodies; it also has a considerable bearing on the phenomena of the twilight and the afterglow (see **REFRACTION**: § *Astronomical*; and **TWILIGHT**). The second (or temperature) variation gives rise to phenomena which we proceed to discuss.

A common type of mirage is the appearance of an isolated lake frequently seen in hot sandy deserts, as in the Sahara, Turkestan, &c. The explanation is as follows: The sand, being abnormally heated by the solar rays, causes the neighbouring air to expand, consequently its density, and therefore its refractive index, is diminished, and attains a minimum value in the lowest layers. It increases as we ascend and reaches a maximum at a certain height, and then decreases according to the normal variation. Any object viewed across such an area is seen by two sets of rays: one set passing near the earth and assuming a curved path convex to the horizon, the second set more remote from the earth and concave to the horizon. The object thus appears double, an image being seen mirrored in the sand. The sky appears as a shining lake; mountains or palms may be similarly reflected, but it is to be noted that the images are inverted (see fig.).

Similar atmospheric conditions sometimes prevail in the air over large bodies of water on cold autumn mornings. The phenomena have been experimentally realized by R. W. Wood (*Phil. Mag.*, 1899, vol. xlvii.), who viewed objects over a series of heated slate slabs.

Another type of mirage, frequently observed at sea in the northern latitudes, is presented in the appearance of ships and icebergs as if inverted and suspended in the clouds. This is due to a stratum of hot air at some distance above the sea level, the rays of light near the horizon being practically horizontal, while those at greater elevations are fairly concave. It may happen that the change in density is so great that only the upper rays reach the eye; we are then met with the curious illusion of seeing inverted ships in the clouds, although nothing is visible on the ocean.

The *Fata Morgana*, frequently seen in the Straits of Messina, consists of an apparent vertical elongation of an object situated on the opposite shore. The distribution of density is similar to that attending a desert mirage, but the transition is not so abrupt. The object is really viewed through a horizontally

stratified medium consisting of a central sheet of maximum refractive index, over- and under-laid by sheets of decreasing refractive power. The system consequently acts as a continuous lens, magnifying the object in a vertical direction.

If, in addition to this horizontal stratification, the atmosphere varies similarly in vertical planes, then the object would be magnified both horizontally and vertically. These conditions sometimes prevail in misty or foggy weather, more particularly at sea, and thus give rise to the phenomena known as "looming." A famous example is the *Broekengespenst* or "spectre of the Brocken." The chromatic halos which frequently encircle these images are due to diffraction. (See **CORONA**.)

It is interesting to note that lenses formed on non-homogeneous material, having the maximum refractive index along the central axis, have been prepared, and reproduce the effects caused by abnormal distribution of the density of the atmosphere.

The mathematical investigation of this subject was worked out by Gaspard Monge. For this aspect and further details, both descriptive and experimental, see J. Perner, *Meteorologische Optik* (1906); E. Mascart, *Traité d'optique* (1899-1903); R. W. Wood, *Physical Optics* (1905); R. S. Heath, *Geometrical Optics*.

MIRAJ, a native state of India, in the Deccan division of Bombay, forming part of the southern Mahratta Jagirs. Since 1820 it has been subdivided between a senior and a junior branch. The territory of both is widely scattered among other native states and British districts. Area of the senior branch, 339 sq. m.; pop. (1901), 81,467; revenue £23,900; tribute £800. Area of the junior branch, 211 sq. m.; pop. (1901), 35,806; revenue £27,000, tribute £400. The chiefs are Brahmans of the Patwardhan family. The town of MIRAJ, at which the chief of the senior branch resides, is situated near the river Kistna; it is a junction of the Southern Mahratta railway for the branch to Kolhapur. Pop. (1901), 18,425. The chief of the junior branch has his residence at Bhudgaon (pop. 3591).

MIRAMON, MIGUEL (1832-1867), Mexican soldier of French extraction, was born in the city of Mexico, on the 29th of September 1832, and shot with the Emperor Maximilian at Queretaro on the 19th of June 1867. While still a student he helped to defend the military academy at Chapultepec against the forces of the United States; and, entering the army in 1852, he rapidly came to the front during the civil wars. It was largely due to Miramon's support of the ecclesiastical party against Alvarez and Comonfort that Zuloaga was raised to the presidency; and in 1859 he was called to succeed him in that office. Decisively beaten by the Liberals in 1860, he spent some time in Europe advocating foreign intervention in Mexican affairs; and returned as a partisan of Maximilian. His ability as a soldier was shown by his double defence of Puebla in 1856.

MIRANDA, FRANCESCO (c. 1754-1816), Spanish-American soldier and adventurer, was born at Caracas, Venezuela, about 1754. He entered the army, and served with the French in the American War of Independence. The success of that war inspired him with a belief that the independence of Spanish America would increase its prosperity. He began to scheme a revolution, but was discovered and had only just time to escape to the United States. Thence he went to England, where he was introduced to Pitt, but chiefly lived with the leading members of the opposition—Fox, Sheridan and Romilly. Finding no help, he travelled through Austria and Turkey to Russia, where he was warmly received, but was dismissed with rich presents, at the demand of the Spanish ambassador, backed up by France. The news of the dispute between England and Spain about Nootka Sound in 1790 recalled him to England, where he saw a good deal of Pitt, but the peaceful arrangement of the dispute again destroyed his hopes. In April 1792 he went to Paris, with introductions to Pétion and the leading Girondists, hoping for aid in South America. France had too much to do to help others; but Miranda's friends sent him to the front as general of brigade. He distinguished himself under Dumouriez, was entrusted in February 1793 with the siege of Maestricht, and commanded the left wing of the French army at the disastrous



battle of Neerwinden. Although he had given notice of Dumouriez's treachery, he was put on his trial on the 12th of May, unanimously acquitted, but again imprisoned, and not released till after the 6th Thermidor. He was sentenced to be deported after the struggle of Vendémiaire, yet he continued in Paris till the *coup d'état* of Fructidor caused him to take refuge in England. He now found Pitt and Dundas ready to listen, but, as neither of them would or could give him substantial help, he went to the United States, where President Adams only gave him fair words. Addington might have done something for him but for the peace of Amiens in 1802. Though in no way amnestied, he returned to Paris, but was expelled by the First Consul, who was eager to be on good terms with Spain. Disappointed in England and the United States, he decided to make an attempt at his own expense. Aided by two American citizens, Colonel W. S. Smith and Mr S. G. Ogden, he equipped the "Leander," in 1806, and with the help of the English admiral Sir A. Cochrane made a landing near Carácas, and proclaimed the Colombian republic. He had some success, but a false report of peace between France and England caused the English admiral to withdraw his support. At last, in 1810, the events in Spain which brought about the Peninsular War had divided the authorities in Spanish America, some of whom declared for Joseph Bonaparte, others for Ferdinand VII., others for Charles IV., and Miranda again landed, and got a large party together who declared a republic both in Venezuela and New Granada or Colombia. But Miranda's desire—that all the South American colonies should form a federal republic—awoke the selfishness of provincial administrations, and the cause was believed to be hateful to heaven owing to a great earthquake on the 26th of March 1812. The count of Monte Verde, the Bourbon governor, had little difficulty in defeating Miranda, and on the 26th of July the general capitulated on condition that he should be deported to the United States. The condition was not observed; Miranda was moved from dungeon to dungeon, and died on the 14th of July 1816 at Cadiz.

There are allusions to Miranda's early life in nearly all memoirs of the time, but they are not generally very accurate. For his trial see Buchez et Roux, *Histoire parlementaire*, xvii, 26-70. For his later life see J. Biggs, *History of Miranda's Attempt in South America* (London, 1809); and Veggsa, *Revolucion de la Colombia*. Prof. William S. Robertson has recently devoted considerable research in the Spanish archives and elsewhere to Miranda, his monograph on *F. de M. and the revolutionizing of Spanish America* being awarded a prize of the American Historical Association in 1908. See also Marqués de Rojas, *El General Miranda* (Paris, 1884), and his *Miranda dans la révolution française* (Carácas, 1889); and R. Becerra, *Ensayo historico documentado de la vida de Don F. de M.* (Carácas, 1896).

MIRANDE, a town of south-western France, capital of an *arrondissement* in the department of Gers, on the left bank of the Grande Baise, 17 m. S.S.W. of Auch by the Southern railway. Pop. (1906), 2368. Miranda is laid out on the uniform plan typical of the *bastide*. Its church, built at the beginning of the 15th century, is chiefly remarkable for its porch which bestrides the Rue de l'Évêché and is surmounted by two flying buttresses supporting a belfry of Flemish appearance. The remains of ramparts are still to be seen and the principal street is bordered by ancient arcades. The town has a sub-prefecture and a tribunal of first instance. The trade is in live-stock and agricultural products. Tanning and wood-turning are carried on.

Miranda was founded in 1286 by the monks of Berdones and the seneschal of Toulouse acting on behalf of Philip IV. During the 14th century it was the capital of the counts of Astarac.

MIRANDOLA, a town of Emilia, Italy, in the province of Modena, 10½ m. N. by E. of it by rail, 59 ft. above sea-level. Pop. (1901), 15,162. The Palazzo del Comune is a 15th-century edifice of Gothic style. The castle of the Pico family, who held the town from the 14th century to 1710, when the last member was deprived of his dominions by Joseph I. of Austria, is almost entirely destroyed. The height of the fortunes of this family was from about 1450 to 1550, Giovanni (b. 1463, d. 1494) being its ablest and most learned member (see Pico). The cathedral, dating from the end of the 16th century, has been restored. S. Francesco is a fine Gothic church.

MIRANZAI VALLEY, or HANGU, a mountain valley on the Kohat border of the North-West Frontier Province of India. Miranzai comprises two valleys draining S.W. into the Kunam and N.E. into the Kohat Toi. It is thus divided into upper and lower Miranzai, and extends from Thal to Raisan, and from the Zaimukht and Orakzai hills to those of the Khattaks. Its length is about 40 m., and its breadth varies from 3 to 7 m. Area, 546 sq. m.; pop. (1901), 43,901. The portion of Miranzai east of Hangu village consists of numerous small and well-cultivated valleys, in which orchard trees flourish abundantly. To the west of Hangu, including the whole of Upper Miranzai, the country is a broad, open, breezy valley. The plain is bare of trees, but the hills are generally covered with scrub. The country is full of ravines towards Thal. The wealth of the inhabitants consists principally in cattle, goats and sheep; of these the cows are of a lean and dwarf breed, and give but little milk. Miranzai forms the meeting place of many different tribes; but its chief inhabitants are the Bangash and Orakzais. Disturbances have necessitated British expeditions in 1851, 1855, and twice in 1891.

MIRBEAU, OCTAVE HENRI MARIE (1850—), French dramatist and journalist, was born at Trévières (Calvados) on the 16th of February 1850. He was educated in a Jesuit school at Vannes, and studied law in Paris. He began his journalistic career as dramatic critic of the *Bonapartist paper, L'Ordre*. For a short time before 1877 he was *sous-préfet* and then *préfet* of Saint-Girons, but from that time he devoted himself to literature. He was one of the earliest defenders of the Impressionist painters. His witty articles in the anti-republican papers, and his attacks on established reputations, involved him in more than one duel. He gradually developed extreme individualist views. In 1890 he began to write for the *Révolte*, but his anarchist sympathies were definitely checked by the murder of President Carnot in 1894. He was one of the early and consistent defenders of Captain Alfred Dreyfus. He married in 1887 the actress Alice Regnaud. His first novel, *Jean Marcellin* (1885), attracted little attention, but he made his mark as a *conteur* with a series of tales of the Norman peasantry, *Lettres de ma chaumière* (1886). *Le Calvaire* (1887), a chapter of which on the defeat of 1870 aroused much discussion, was followed by *L'Abbé Jules* (1888), the story of a mad priest; by *Sebastien Roch* (1890), a bitter picture of the Jesuit school in which his own early years were spent; *Le Jardin des supplices* (1899), a Chinese story; *Les Mémoires d'une femme de chambre* (1901); and *Les Vingt-et-un jours d'un neurasthénique* (1902). In 1897 his five-act piece, *Les Mauvais Bergers*, was played at the Renaissance by Sarah Bernhardt, and he followed this up with *Les Affaires sont les affaires* (Théâtre Français, 1903), which was adapted by Sydney Grundy for Sir H. Beerbohm Tree in 1905. Some of his short pieces are collected as *Farces et moralités* (1904).

MIRFIELD, an urban district in the Morley parliamentary division of the West Riding of Yorkshire, England, 3 m. S.W. of Dewsbury, on the Lancashire & Yorkshire and London & North-Western railways. Pop. (1901), 11,341. The church of St Mary was completed in 1874, from designs of Sir Gilbert Scott. The tower of the ancient church remains. The large industrial population is employed in woollen, cotton, carpet and blanket manufactures, and in the numerous collieries in the vicinity.

MIRKHOND (1433-1498). Mohammed bin Khāwandshāh bin Mahmūd, commonly called Mirkhāwand or Mirkhāwand, more familiar to Europeans under the name of Mirkhond, was born in 1433, the son of a very pious and learned man who, although belonging to an old Bokhara family of Sayyids, or direct descendants of the Prophet, lived and died in Balkh. From his early youth he applied himself to historical studies and literature in general. In Herāt, where he spent the greater part of his life, he gained the favour of that famous patron of letters, Mir 'Alishir (1440-1501), who served his old schoolfellow, the reigning sultan Husain (who as the last of the Timurids in Persia ascended the throne of Herāt in 1468), first as keeper of the seal, afterwards as governor of Jurjān. At the request of

Mir 'Alishir, himself a distinguished statesman and writer, Mirkhond began about 1474, in the quiet convent of Khlāstiyah, which his patron had founded in Herāt as a house of retreat for literary men of merit, his great work on universal history, *Rauzat-ussajfā fī sirāt-ulunbiā walmulūk walukhulafā' or Garden of Purity on the Biography of Prophets, Kings and Caliphs*. He made no attempt at a critical examination of historical traditions, and wrote in a flowery and often bombastic style, but in spite of this drawback, Mirkhond's *Rauzat* remains one of the most marvellous achievements in literature. It comprises seven large volumes and a geographical appendix; but the seventh volume, the history of the sultan Husain (1438-1505), together with a short account of some later events down to 1523, cannot have been written by Mirkhond himself, who died in 1498. He may have compiled the preface, but the main portion of this volume is probably the work of his grandson, the historian Khwandāmir (1475-1534), to whom also a part of the appendix must be ascribed.

For accounts of Mirkhond's life see De Sacy's "Notice sur Mirkhond" in his *Mémoires sur diverses antiquités de la Perse* (Paris, 1793); Jourdan's "Notice de l'histoire universelle de Mirkhond" in the *Notices et extraits*, vol. ix (Paris, 1812); Elliot, *History of India*, iv, 127 seq.; Morley, *Descriptive Catalogue* (London, 1884), p. 30 seq.; Rieu, *Cat. of Persian MSS. of the Brit. Mus.* (vol. i, London, 1879), p. 87 seq. Besides the lithographed editions of the whole work in folio (Bombay, 1853, and Teheran, 1852-1856) and a Turkish version (Constantinople, 1842), the following portions of Mirkhond's history have been published by European Orientalists: *Early Kings of Persia*, by D. Shea (London, 1832) (Oriental Translation Fund); *L'Histoire de la dynastie des Sassanides*, by S. de Sacy (in the above-mentioned *Mémoires*); *Histoire des Sassanides (texte Persan)*, by Jaubert (Paris, 1843); *Historia priorum regum Persarum*, Persian and Latin, by Jewish (Vienna, 1782); *Mirkhond's historia Takeridarum*, Persian and Latin, by Mitscherlik (Göttingen, 1814, 2nd ed., Berlin, 1819); *Historia Samanidarum*, Persian and Latin, by Wilken (Göttingen, 1808); *Histoire des Samanides*, translated by Defrémery (Paris, 1845); *Historia Ghanavidarum*, Persian and Latin, by Wilken (Berlin, 1832); *Geschichte der Sultane aus dem Geschlechte Bujeh*, Persian and German, by Wilken (Berlin, 1835); followed by Erdmann's *Erläuterung und Ergänzung* (Kazan, 1836); *Historia Seldschucidarum*, ed. Vullers (Gießen, 1837); and a German trans. by the same; *Histoire des Sultans du Kharezm*, in Persian, by Defrémery (Paris, 1842); *History of the Atebeks of Syria and Persia*, in Persian, by W. Morley (London, 1848); *Historia Ghuridarum*, Persian and Latin, by Mitscherlik (Frankfort, 1818); *Histoire des Sultans Ghurides*, trans. into French by Defrémery (Paris, 1844); *Vie de Djenghis-Khan*, in Persian, by Jaubert (Paris, 1841) (see also extracts from the same 5th vol. in French trans. by Langlès in vol. vi of *Notices et extraits*, Paris, 1799, p. 192 seq.), and by Hammer in *Sur les origines russes*, St Petersburg, 1825, p. 52 seq.); "Timur's Expedition against Tukhamaish Khān," Persian and French, by Char moy, in *Mémoires de l'Acad. impér. de St Pétersbourg* (1836), pp. 270-321 and 441-471. (H. E.)

MIRROR (through O. Fr. *mirour*, mod. *miroir*, from a supposed Late Lat. *miratorium*, from *mirari*, to admire), an optical instrument which produces images of objects by reflection. In its usual forms it is simply a highly polished sheet of metal or of glass (which may or may not be covered, either behind or before, with a metallic film); a metallic mirror is usually termed a speculum. The laws relating to the optical properties of mirrors are treated in the article REFLECTION OF LIGHT.

Ancient Mirrors.—The mirror (*κάτοπτρον*, *ἑσπράνιον*, *ἑσπράνιον*, *speculum*) of the Etruscans, Greeks and Romans consisted of a thin disk of metal (usually bronze) slightly convex and polished on one side, the other being left plain or having a design incised upon it. A manufactory of mirrors of glass at Sidon is mentioned by Pliny (*Nat. Hist.* xxxvi. 66, 193), but they appear to have been little used (one has been found at San Remo). Glass mirrors were coated, but with tin; some silver mirrors have also been found. They are said to have been in use as early as the time of Pompey, and were common under the empire. Homer knows nothing of mirrors, but they are frequently mentioned in the tragedies and onwards. The usual size was that of an ordinary hand-mirror, but in imperial times some appear to have been large enough to take in the whole figure (Seneca, *Nat. quaest.* i. 17, 8), being either fixed to the wall or working up and down like a window sash. The first specimen of a Greek mirror was not discovered till 1867, at Corinth, and the number

extant is comparatively small. They are usually provided with a handle, which sometimes took the form of a statuette (especially of Aphrodite) supported on a pedestal, or consist of two metallic circular disks (the "box" mirrors) fitting in to each other, and sometimes fastened together by a hinge. The upper disk or cover was ornamented on the outside with a design in low relief; inside it was polished to reflect the face. The lower disk was decorated inside with engraved figures. The best specimens of both kinds of mirrors date from a little before 400 B.C. and last for some time after that. Of the reliefs, one of the best examples is "Ganymede carried away by the eagle"; amongst the incised mirrors may be mentioned one representing Leucas and Corinthus, inscribed with their names (both the above in Collignon, *L'Archéologie grecque*, 1907, figs. 212, 213); the Genius of the Cock-fights (*Revue archéologique*, new ser. xvii. 1868, Pl. 13). A bronze mirror-case, found at Corinth, has attached on the outside a relief representing an Eros with two girls; on the inside is incised a design of a nymph seated on a bench and playing with Pan at a game resembling the Italian *mora* (*Classical Review*, Feb. 1889, p. 86). On the back of another mirror in the British Museum (*Gazette archéologique*, ii. Pl. 27) is a figure of Eros which has been silvered over. With this was found the bronze case used to contain it, on the back of which is a group of Aphrodite and Eros in *repassé*. It was found in Crete; but most of the Greek mirrors and mirror-cases having designs are from Corinth.

The principal feature of the Etruscan mirrors, the extant examples of which far outnumber the Greek, is the design incised on the back. Belonging chiefly to the 4th and 3rd centuries, they most resemble the Greek disk-mirrors in form, box-mirrors being rare. As a rule the subjects incised are taken from Greek mythology and legend (Trojan War, birth of Athena, Aphrodite and Adonis), the names of the persons represented being frequently added in Etruscan letters and orthography (Apu= Apollo, Achle= Achilles, Achmemrum= Agamemnon). Scenes from daily life, the toilet, the bath, the palestra, also occur. In most cases the style of drawing, the types of the figures, and the manner of composing the groups are true to the characteristics of Greek art. Some may have been imported from Greece, but the greater number appears to have been more or less faithfully imitated from such designs as occurred on the Greek vases which the Etruscans obtained from Greece. Even where distinctly Etruscan figures are introduced, such as the heroes Aelius and Caelius Vibenna on a mirror in the British Museum, Greek models are followed. Although the work is frequently rough and careless, certain very fine and beautiful specimens have been found: the famous Semele-mirror, and the healing of Telemachus, in which Achilles is shown scraping the healing rust from the lance with a crescent-shaped knife (Baumeister, *Denkmäler*, figs. 557, 1774). Roman mirrors are usually disk-mirrors, the back of the disk, if engraved, being generally ornamented with decorative patterns, not with any subject design.

Plain mirrors are found wherever Greek and Roman civilization spread, and a specimen found in Cornwall (now in the British Museum) shows that the Celtic population of England had adopted the form and substance of the mirror from their conquerors. This specimen is enriched with a Celtic pattern incised. The shape of the handle exhibits native originality. Mirrors were sometimes used in Greece for purposes of divination (Pausanias vii. 21, 5). The mirror was let down into a well by means of a string until it grazed the surface of the water with the rim; after a little while it was pulled up, and when looked into showed the face of the sick person, alive or dead, on whose behalf the ceremony had been performed. This took place at Patrae.

See J. J. de Witte, "Les miroirs chez les anciens," in *Extrait des annales de l'Académie*, xviii. (Antwerp, 1872); Mylonas, "Ἐπιπέδα κάτοπτρα" (Athens, 1876); M. Collignon, *L'Archéologie grecque* (new ed., 1907; Eng. tr. by J. H. Wright, 1886); E. Gerhard, *Etruskische Spiegel* (1840-1867), continued by K. Klugmann and G. Körte (1884-1897); article in Smith's *Dictionary of Greek and Roman Antiquities* (3rd ed., 1891). (J. H. F.)

Medieval and Modern Mirrors.—Small metallic mirrors with a highly polished surface were largely used during the middle ages; pocket mirrors or small hand mirrors carried at the girdle being indispensable adjuncts to ladies' toilets. The pocket mirrors consisted of small circular plaques of polished metal, usually steel or silver, fixed in a shallow circular box covered with a lid. Mirror-cases were chiefly made of ivory, carved with relief representations of love or domestic scenes, hunting and games, and sometimes illustrations of popular poetry or romance. Gold and silver, enamels, ebony and other costly materials were likewise used for mirror cases, on which were lavished the highest decorative efforts of art workmanship and costly jewellery. The mirrors worn at the girdle had no cover, but were furnished with a short handle. In 625 Pope Boniface IV. sent Queen Ethelberga of Northumbria a present of a silver mirror; and in early Anglo-Saxon times mirrors were well known in England. It is a remarkable fact that on many of the sculptured stones of Scotland, belonging probably to the 7th, 8th or 9th century, representations of mirrors, mirror-cases and combs occur.

The method of backing glass with thin sheets of metal for mirrors was well known in the middle ages, at a time when steel and silver mirrors were almost exclusively employed. Vincent of Beauvais, writing about 1250, says that the mirror of glass and lead is the best of all, "quia vitrum propter transparentiam melius recipit radios"; and a *verre à mirer* is mentioned in the inventories of the dukes of Burgundy, dating from the 15th century. A guild of glass-mirror makers existed at Nuremberg in 1373, and small convex mirrors were commonly made in southern Germany before the beginning of the 16th century; and these continued to be in demand, under the name of bull's-eyes (*Ochsen-Augen*), till comparatively modern times. They were made by blowing small globes of glass into which while still hot was passed through the pipe a mixture of tin, antimony and resin or tar. When the globe was entirely coated with the metallic compound and cooled it was cut into convex lenses, which formed small but well-defined images. As early as 1317 a "Magister de Alemania," who knew how to work glass for mirrors, broke an agreement he had made to instruct three Venetians, leaving in their hands a large quantity of mixed alum and soot for which they could find no use. It was, however, in Venice that the making of glass mirrors on a commercial scale was first developed; and the republic enjoyed a monopolized monopoly of the manufacture for about a century and a half. In 1507 two inhabitants of Murano, representing that they possessed the secret of making perfect mirrors of glass, a knowledge hitherto confined to one German glass-house, obtained an exclusive privilege of manufacturing mirrors for a period of twenty years. In 1564 the mirror-makers of Venice, who enjoyed peculiar privileges, formed themselves into a corporation. The products of the Murano glass-houses quickly supplanted the mirrors of polished metal, and a large and lucrative trade in Venetian glass mirrors sprang up. They were made from blown cylinders of glass, which were slit, flattened on a stone, carefully polished, the edges frequently bevelled, and the backs "silvered" by an amalgam. The glass was remarkably pure and uniform, the "silvering" bright, and the sheets sometimes of considerable dimensions. In the inventory of his effects, made on the death of the French minister Colbert, a Venetian mirror, 46 by 26 in., in a silver frame, is valued at 8016 livres, while a picture by Raphael is put down at 3000 livres.

The manufacture of glass mirrors, with the aid of Italian workmen, was practised in England by Sir Robert Mansel early in the 17th century, and about 1670 the duke of Buckingham was concerned in glass-works at Lambeth where flint glass was made for looking-glasses. These old English mirrors, with bevelled edges in the Venetian fashion, are still well known. The Venetians guarded with the utmost jealousy the secrets of their manufactures, and gave exceptional privileges to those engaged in such industries. By their statutes any glass-maker carrying his art into a foreign state was ordered to return on the pain of imprisonment of his nearest relatives, and should he disobey

the command emissaries were delegated to slay him. In face of such a statute Colbert attempted in 1664 to get Venetian artists transported to France to develop the two great industries of mirror-making and point-lace working. The ambassador, the bishop of Béziers, pointed out that this was to court the risk of being thrown into the Adriatic, and, further, that Venice was selling to France mirrors to the value of 100,000 crowns and lace to three or four times that value. Nevertheless, twenty Venetian glass-mirror makers were sent to France in 1665, and the manufacture was begun in the Faubourg St Antoine, Paris. But previous to this the art of blowing glass for mirrors had been practised at Tour-la-Ville, near Cherbourg, by Richard Lucas, Sieur de Nehou, in 1653; and by the subsequent combination of skill of both establishments French mirrors soon excelled in quality those of Venice. The art received a new impulse in France on the introduction of the making of plate glass in 1691. The St Gobain Glass Company attribute the discovery to Louis Lucas of Nehou, and over the door of the chapel of St Gobain they have placed an inscription in memory of "Louis Lucas qui inventa en 1691 le méthode de couler les glaces et installa la manufacture en 1695 dans le château de Saint Gobain."

Manufacture.—The term "silvering," as applied to the formation of a metallic coating on glass for giving it the properties of a mirror, was till quite recently a misnomer, seeing that till about 1840 no silver, but a tin amalgam, was used in the process. Now, however, a large proportion of mirrors are made by depositing on the glass a coating of pure silver, and the old amalgamation process is comparatively little used. The process of amalgamation consists in applying a thin amalgam of tin and mercury to the surface of glass. A sheet of thin tin-foil, somewhat larger than the glass to be operated on, is spread out on a flat table, and after all folds and creases have been completely removed a small quantity of mercury is rubbed lightly and quickly over the whole surface, and the scum of dust, impurities and mercury is taken off. Mercury is then poured upon the "quicken" foil until there is a body of it sufficient to float the glass to be silvered (about $\frac{1}{2}$ in. deep), and the glass (scrupulously cleaned simultaneously with the above operations) is slid over the surface of the mercury. Weights are placed over the surface until the greater part of the amalgamated mercury is pressed out, and the table is then tilted so that all superfluous mercury finds its way to the gutter. The glass is left twenty-four hours under weights; it is then turned over, and the table is raised up and removed to a drier, where it dries and hardens. This process, when elaborated on a large scale, is called "silvering," producing a brilliant silver-white metallic lustre, which is only subject to alteration by exposure to high temperatures or by contact with damp surfaces; but the mercurial vapours to which the workmen are exposed give rise to the most distressing and fatal affections.

The "silver on glass" mirror may be regarded as a discovery of J. von Liebig, who in 1835 observed that by heating aldehyde with an ammoniacal solution of silver nitrate in a glass vessel a brilliant deposit of metallic silver was formed on the surface of the glass. In practice the process was introduced about 1840; and it is now carried on with several modifications. In two distinct ways, called the hot and the cold process respectively. In the former, mercury is employed a horizontal double-bottomed metallic table, which is heated with steam to from 35° to 40° C., and the reduction of the ammoniacal silver solution is effected with tartaric acid.

In silvering by the cold process advantage is taken of the power of sugar to reduce the silver nitrate. This method has been generally adopted for the silvering of mirrors for astronomical telescopes. G. W. Ritchey ("The Modern Reflecting Telescope," *Smithsonian Contributions to Knowledge*, xxiv. 40) used the process devised by Brashear in 1884. The glass disk is mounted on a rocking-table, and most carefully cleaned with nitric acid, potash, and finally with distilled water. The reducing solution (which improves on keeping) is made up from 200 parts of water, 20 of loaf sugar, 20 of alcohol and 1 of nitric acid (commercial pure). The silver solution is prepared as follows: 2 parts of silver nitrate are dissolved in 20 parts of water, and strong ammonia added until the brown solution becomes clear. A solution of $\frac{1}{2}$ parts of potash (pure by alcohol) in 20 of water is now added, and then ammonia until the solution is again clear. A solution of $\frac{1}{4}$ part of silver nitrate in 16 of water is added until the liquid is straw-coloured; it is then filtered. Quantities of the solutions used about 1 mg. equals one half the nitrate, are taken, then diluted, mixed, and poured on to the plate, which is gently rocked. The liquid goes muddy-brown, and in 3 to 4 minutes it begins to clear, a thick deposit being formed in about 5 minutes. The solution is poured off, and water run on, the streaks of precipitate being removed by lightly held cotton wool. The washing is repeated, and then water is allowed to remain on the film for one hour. The water is then run off, and the plate is washed several times with alcohol, and then dried by an air fan. The film is now burnished with a chamois leather pad, and finally with the finest jewellers' rouge, the silver surface being the reflecting surface of the mirror.

The deposit of silver on glass is not so adherent and unalterable under the influence of sunlight and sulphurous fumes as the tin-mercury amalgam, and, moreover, real silvered glass has in many cases a slightly yellowish tinge. These defects have been overcome by a process introduced by Lenoir, which consists of brushing over the silvered surface with a dilute solution of cyanide of mercury, which, instantaneously forming a kind of amalgam, renders the deposit at once much whiter and more firmly adherent than before. To protect the thin metallic film from mechanical injury and the chemical action of gases and vapours it is coated with shellac or copal varnish, over which, when dry, are applied two coatings of red-lead paint or an electrolytically-deposited film of copper. This precaution only applies when the silver forms the back of the mirror.

Platinum Mirrors.—A cheap process of preparing mirror glass was to some extent prosecuted in France, whereby a thin but very adherent deposit of platinum is formed on the glass. A solution of chloride of platinum with a proportion of ligase and borate of lead dissolved in essential oil of spike is applied with a brush to well-cleaned glass, which is then placed on edge in a muffle furnace, and the platinum is thus burned in, forming an exceedingly thin but brilliant metallic backing having a somewhat grey lustre. It was used only for the lids of cheap boxes, toys, ornamental letters, &c.

Magic Mirrors.—Hand mirrors of metal are still in common use in Oriental countries, and in Japan bronze mirrors possess a religious significance. They have been known and used from the most remote period, mention of them being found in Chinese literature of the 9th century. The (reported) first made Japanese mirror, preserved at Isé, is an object of the highest veneration in Japan, and an ancient mirror, connected with which is a tradition to the effect that it was given by the sun-goddess at the foundation of the empire, is a principal article of the Japanese regalia. The mirrors of Japan in general consist of thin disks, from 3 to 12 in. in diameter, of speculum metal with handles, cast in one piece. The polished face of the mirror is slightly convex in form, so that a reflected image is seen proportionately reduced in size; the back of the disk is occupied with ornamentation and inscriptions in bold relief, and its rim is also raised to the back. Much attention has been attracted to these mirrors by a singular physical peculiarity which in a few cases they are found to possess. These are known as magic mirrors from the fact that when a strong beam of light is reflected from their smooth and polished surface, and thrown on a white screen, an image of the raised ornaments and characters on the back of the mirror is formed with more or less distinctness in the disk of light on the screen. This peculiarity has at no time been specially observed by the Japanese, but in China it attracted attention as early as the 11th century, and mirrors possessed of this property were sought for by artists at ten or even twenty times the price sought for the ordinary non-sensitive examples. The true explanation of the magic mirror was first suggested by the French physicist Charles Cléophas Person in 1847, who observed that the reflecting surface of the mirrors was not uniformly convex, the portions opposite relief surfaces being plane. Therefore, as he says, "the rays reflected from the convex portion diverge and give but a feebly illuminated image, while, on the contrary, the rays reflected from the plane portions of the mirror preserve their parallelism, and appear on the screen as an image by reason of their contrast with the feebler illumination of the rest of the disk." Such differences of plane in the mirror surface are accidental, being due to the manner in which it is prepared, a process explained by W. E. Ayton and J. Perry (*Proc. Roy. Soc.*, 1878, vol. xviii.), by whom ample details of the history, process of manufacture and composition of Oriental mirrors have been published. A preliminary operation in polishing the surface consists of scoring the cast disk in every direction with a sharp tool. The thicker portions with relief ornament offer more resistance to the pressure of the tool than the thin flat portions, which tend to yield and form at first a concave surface, but this is by a reaction of its elasticity first afterwards and forms a slightly convex surface, while the more rigid thick portions are comparatively little affected. This irregularity of surface is inconspicuous in ordinary light, and does not visibly distort images; but when the mirror reflects a bright light on a screen the unequal radiation renders the minute differences of surface obvious.

MIRZAPUR, a city and district of British India, in the Benares division of the United Provinces. The city is on the right bank of the Ganges; a station on the East Indian railway, about halfway between Allahabad and Benares, 509 m. N.W. from Calcutta. Pop. (1901), 79,862. The river front, lined with stone ghats or flights of stairs, mosques, Hindu temples and dwelling-houses of the wealthier merchants, is handsome; but the interior of the town is mainly composed of mud huts. Formerly it was the emporium of trade between central India and Bengal, which has now been diverted to the railways. It has European and native lace factories, and manufactures brass vessels and woollen carpets. The London Mission manages a high school and an orphanage. The municipal limits include the town of Bind-

hachal, an important centre of pilgrimage, with the shrine of Vindhyswari.

The DISTRICT OF MIRZAPUR extends into the Sone valley. Area, 5238 sq. m. It is crossed from east to west by the Vindhya and Kaimur ranges. A central jungly plateau connects these and separates the valley of the Ganges from that of the Sone. The part north of the Vindhya is highly cultivated and thickly peopled, but the rest of the district consists largely of ravines and forests with a sparse population. The population in 1901 was 1,082,430, showing a decrease of 6-8% in the decade. The district comprises a large part of the hereditary domains of the raja of Benares, which are revenue-free. It is traversed, near the Ganges, by the main line of the East Indian railway. The Great Southern road used to start from the city.

MISARRIAGE, in its widest sense a going astray, a failure. In law, the word is used in several phrases; thus, a miscarriage of justice is a failure of the law to attain its ends. In the Statute of Frauds (29 Car. II., c. 3) in the expression "debt, default or miscarriage of another," the word has sometimes been interpreted as equivalent in meaning to default, but it is more usually considered to mean a species of wrongful act for the consequence of which the law makes a party civilly responsible. The term is also used (see ABORTION) for the premature expulsion of the contents of the womb before the period of gestation is complete.

MISCEGENATION (from Lat. *miscere*, to mix, and *genus*, race), a mixture or blending of two races, particularly of a white with a black or negro race.

MISCELLANY, a term applied to a single book containing articles, treatises or other writings dealing with a variety of different subjects. It is a common title in the literature of the 17th and 18th centuries. The word is an adaptation of Lat. *miscellanea* (from *miscellaneus*, mixed, *miscere*, to mix), used in this sense by Tertullian, *Miscellanea Ptolemæi* (Tert. adv. Val. 12); the ordinary use of the word in Latin was for a dish of broken meats, applied by Juvenal (xi. 20) to the coarse food of gladiators.

The Lat. *miscellaneus* has affected the form of a word which is now usually spelled "maslin," applied to a mixture of various kinds of grain, especially rye and wheat. This, however, is really from the O. Fr. *mestillon*; Late Lat. *mistillo*, formed from *mistus*, past participle of *miscere*, to mix, mingle.

MISCHIEF, a term meaning originally calamity, trouble; now used particularly of annoying injuries or damage done in play or through petty spite. The word is derived through O. Fr. *meschef*, mod. *mêchef*, from *meschever*, to do wrong, *mes-*, amiss, and *chever*, bring to a head (*chef*, Lat. *caput*).

MISDEMEANOUR (from O. Fr. *mes-* and *demener*, to conduct oneself ill), the generic term used in English law to include all those offences against the criminal law which are not by common law or statute made treason or felony. In *Russell on Crimes* it is defined as a crime for which the law has not provided a particular name (6th ed., i. 193). The term misprision, at one time applied to the more heinous offences of this class, is now almost obsolete. The term misdemeanour includes not only all indictable offences below the degree of felony, some of them grave crimes, such as sedition, riot and perjury, but also the petty misdemeanours, which may be dealt with summarily by justices of the peace, and the most trifling breaches of local by-laws.

As a matter of legal history, many misdemeanours now represent what were originally described as trespasses against the peace, a phrase which is equivalent to a "tort" or delict, accompanied by circumstances calling for prosecution in the interest of the Crown and the public as well as for civil proceedings by the injured parties. Such acts as riot, public nuisance, sedition and the different forms of libel naturally came to be regarded as wrongs against the king's peace. Many of the early statutes anent justices are particularly concerned with the punishment of rioters; and some offences now treated as misdemeanours belonged to the spiritual and not to the temporal courts, e.g. perjury.

While it is true that almost all crimes which in the middle ages were considered heinous fall into the categories of treason or felony, many statutory misdemeanours differ so little, if at all,

from felony in character or in the mode of punishment that, in the absence of a code, no logical line of division can now be drawn, inasmuch as few felonies are now capital and none involve the forfeitures of land or goods, which at one time afforded an appreciable distinction between the two categories of crime. The result is that it is impossible to distinguish without enumerating the specific crimes falling under each head.

Among the chief *misdemeanours* are: (1) Assault on the sovereign; (2) unlawful assembly; (3) riot and sedition; (4) forcible entries; (5) perjury, which until 1563 was mainly, if not solely, cognizable by the spiritual courts; (6) blasphemy; (7) extortion; (8) bribery; (9) obtaining property by false pretences (which is nearly cognate to the felony of larceny); (10) assault; (11) public nuisance; (12) libel; (13) conspiracy to defraud, &c.; (14) attempts to commit other crimes.

Numerous acts or omissions are punishable as "misdemeanours by interpretation." In other words, disobedience to the command or prohibition of a statute as to a matter of public concern is indictable as a misdemeanor, even if the statute does not so describe it, unless the terms of the statute indicate that some other remedy alone is to be pursued. For some misdemeanours penal servitude may be imposed by statute. But as a rule the appropriate punishment is by fine or imprisonment without hard labour or both, at the discretion of the court unless limited by a particular statute. The offender may also be put under recognizance to keep the peace and be of good behaviour. Theoretically, whipping may be imposed; but this is not now done except under specific statutory authority; and the like authority is necessary to authorize the addition of hard labour to a sentence of imprisonment.

At the present time the practical difference in English law between misdemeanor and felony lies in matters of procedure, in which a trial for misdemeanor closely resembles an ordinary civil trial.

1. An arrest for misdemeanor may not be made without judicial authority except under specific statutory authority.

2. A person charged with misdemeanor is entitled to bail (see *ARREST*). He is released on the obtaining of sureties, or even on his own recognizance without sureties to appear and take his trial. Bail is obligatory in all misdemeanours, with the exception of misdemeanours where the costs of the prosecution are payable out of the court or borough rate or fund.

3. A misdemeanor may be tried on an information filed by the attorney-general or by leave of the high court without the indictment essential in cases of treason and felony.

4. The same indictment or information may include a number of charges of misdemeanor committed at different times and even against different persons. See *INDICTMENT*.

5. A trial for misdemeanor may proceed in the absence of the defendant, who is not "given in charge" to the jury, as in the case of felony.

6. On a charge of misdemeanor a trial by special jury may be ordered.

7. There is no right to challenge peremptorily any of the jurors summoned to try the case; any challenge made must be for cause. The jury is sworn collectively (four men to a book), and not poll by poll as in felony, and their oath is to try the issues joined between the king and the defendant. They may separate during adjournments of the trial, like a jury in a civil case.

8. The costs of prosecuting certain misdemeanours are recoverable out of public funds under specific statutory provisions; but in very few cases can the court make the misdemeanant himself pay them.

9. There are no accessories after the fact to misdemeanor. (See *ACCESSORY*.)

Under French law and systems based thereon or having a common origin a distinction is drawn between *crime* (*verbreken*), *délit* (*vergehen*) and *contravention*. The English term misdemeanor roughly corresponds to the two classes of *délit* and *contravention* but includes some offences which would be qualified as "crime." In the criminal code of Queensland the term "misdemeanour" is retained, while that of "felony" is abolished; and offences are classified as crimes, misdemeanours and simple offences, the two former punishable on indictment, the latter on summary conviction only; the more serious offences described in English law as misdemeanours are in that code described as crimes (*e.g.* perjury). In the United States the English common law as to misdemeanor is generally followed,

but in New York and other states a statutory distinction has been made between misdemeanor and felony by defining the latter as a crime punishable by death or by imprisonment in a state prison. (W. F. C.)

MISE, an Anglo-French term (from Fr. *mettre*, to place) signifying a settlement of accounts, disputes, &c., by agreement or arbitration. As an English legal term it was applied to the issue in a writ of right; and in history to the payment, in return for certain privileges, made by the county palatine of Chester to each new earl, and by the Welsh to each new lord of the Marches, or to a prince or king on his entry into the country. In its more general sense of agreement the term is familiar in English history in the "Mise of Amiens," in January, and that of Lewes, in May of 1264, made between Henry III. and the barons.

MISENUM, an ancient harbour town of Campania, Italy, about 3 m. S. of Baiæ (*g.v.*) at the western extremity of the Gulf of Puteoli (Pozzuoli). Until the end of the Republic it was dependent on Cumæ, and was a favourite villa resort. Agrippa made the fine natural harbour into the main naval station of the Mediterranean fleet, and founded a colony there probably in 31 B.C. The emperor Tiberius died in his villa here. Its importance lasted until the decline of the fleet in the 4th century A.D. It was at first an independent episcopal see: Gregory the Great united it with that of Cumæ. In 890 it was destroyed by the Saracens. The name was derived from one of the companions of Ulysses, or from Aeneas's trumpeter, an account of whose burial is given in Virgil, *Aeneid*, vi. 232.

The harbour consisted of the outer basin, or Porto di Miseno, protected by moles, of which remains still exist, and the present Mare Morto, separated from it by a comparatively modern embankment. The town lay on the south side of the outer harbour, near the village of Miseno, where remains of a theatre and baths and the inscriptions relating to the town have been found. Remains of villas can also be traced, and to the largest of these, which occupied the summit of the promontory, and belonged first to Marius, then to Lucullus, and then to the imperial house, probably belongs the subterranean Grotta Dragonara. Roads ran north to Baiæ and north-west past the modern Torre Gavieta to Cumæ: along the line of both are numerous columbaria.

See J. Beloch, *Campanien*, ed. ii. (Breslau, 1890), 190 sqq. (T. As.)

MISER, a term originally meaning (as in Latin) miserable or wretched, but now used for an avaricious person who hoards up money and who spends the smallest possible sum on necessities.

MISERERE (the imperative of Lat. *misereri*, to have mercy or pity), the name of one of the penitential psalms (*li.*), from its opening words, *Miserere mei, Deus*. The word is frequently used in English as equivalent to "Miserico" (Lat. *miserico*, pity, compassion) for various forms in which the rules of a monastic order or general discipline of the clergy might be relaxed; thus it is applied to a special chamber in a monastery for those members who were allowed special food, drink, &c., and to a small bracket on the under side of the seat in a stall of a church made to turn up and afford support to a person in a position between sitting and standing. "Miserico" and "miserere" are also used of a small dagger, the "dagger of mercy," capable of passing between the joints of armour, with which the *coup de grâce* might be given to a wounded man.

MISHAWAKA, a city of St Joseph county, Indiana, U.S.A., on the St Joseph river of Michigan, about 80 m. E. by S. of Chicago. Pop. (1900), 5560 (821 foreign-born); (1910) 11,886. It is served by the Grand Trunk and the Lake Shore & Michigan Southern railways, and by inter-urban electric lines. It has an extensive trade in grain and other agricultural products. Two miles up the river is the Hen Island dam, which, with the Mishawaka hydraulic dam nearer the city, is the source of much of the power used by the city's manufactures. St Joseph Iron Works was laid out on the south side of the river, in 1833, and in 1835 was organized as a village and two additions were platted. In 1836 Indiana City was laid out on the north side of the river;

and in 1830 St Joseph Iron Works, with its two additions, and Indiana City were incorporated as one town named Mishawaka—the name of an Indian village formerly occupying a part of the present site. Mishawaka was chartered as a city in 1899.

MISHMI, a hill-tribe on the frontier of Eastern Bengal and Assam. The Mishmis occupy the hills from the Dihong to the Brahmapund, in the north-eastern corner of the Brahmaputra valley. In 1854 M. Krick and M. Bourry, two French missionaries, were murdered in the Mishmi country, but their death was avenged by a small expedition which took the murderer prisoner. In 1899 another British expedition was sent against the Mishmis, owing to the murder of some British subjects.

MISIONES, a territory of northern Argentina, bounded N. by Paraguay and Brazil, E. and S. by Brazil and W. by Paraguay and the Argentine province of Corrientes. Its boundary lines are formed by the upper Paraná and Iguassú rivers on the N., the San Antonio and Pequiry-guassu streams on the E. and the Uruguay River on the S. Area, 11,282 sq. m.; pop. (1904, estimate), 38,755, chiefly Indians and mestizos. The territory is a region of roughly-broken surfaces, divided longitudinally by low mountains, called the Sierra Iman and Sierra Grande de Misiones, which form the water-parting for many small streams flowing northward to the Paraná and southward to the Uruguay. The greater part of the country is covered with forest and tropical jungle. The climate is sub-tropical, the temperature ranging from 40° to 95° F. The soil is described as highly fertile, but its products are chiefly confined to *yerba mate* or Paraguay tea (*Ilex paraguayensis*), tobacco and oranges and other fruits. Communication with the capital is maintained by two lines of steamboats running to Corrientes and Buenos Aires, but a railway across Paraguay from Asunción is planned to Encarnación, opposite Posadas. Some of the Jesuit missions of the 17th and 18th centuries were established in this territory, and are to-day represented by the lifeless villages of Candelaria, Santa Ana, San Ignacio and Corpus along the Paraná River, and Apóstoles, Concepción, and San Javier along the Uruguay. Posadas (estimated pop. in 1905, 8000), the capital, on the Paraná, officially dates from 1865. It was also a Jesuit settlement called Itapúa, though the large mission of that name was on the Paraguayan side of the river. It is at the extreme west of the territory, and is the terminal port for the steamers from Corrientes.

MISKOLCZ, capital of the county of Borsod, Hungary, 113 m. N.E. of Budapest by rail. Pop. (1900), 40,833. It is situated in a valley watered by the Szinva in the east of the Bükk mountains, and opens towards the south to the plain of the Sajó, an affluent of the Hernád. Miskolcz is a thriving town, and among its buildings are a Roman Catholic church of the 13th century in Late Gothic style, a Minorite convent, and Greek Catholic, Lutheran and Calvinist churches. It manufactures snuff, porcelain, boots and shoes, and prepared leather, and has both steam and water mills. It trades in grain, flour, wine, fruit, cattle, hides, honey, wax and agricultural products, while four well-attended fairs are held annually. About 5 m. west of the town in the Szinva valley is Diósgyőr (pop. 11,520), which possesses important iron-works, and the ruined castle of Diósgyőr, formerly a shooting-residence of the kings of Hungary. About 4 m. to the south-west of Miskolcz are the baths of Tapolca, containing warm springs. To the south-west of the town lies Onod (pop. 2087), to the south of which, on the banks of the Sajó, is the heath of Mohi or Muhi, famous as the scene of the great defeat of the Hungarians by the Mongols in 1241. About 85,000 Hungarians fell, and the whole country was devastated for the next two years by the Mongolian hordes. During the 16th and 17th centuries Miskolcz suffered much from the Ottomans, and from the troops of George Rákóczy and Emeric Thököly. In 1781, 1843 and 1847 it was devastated by fire, and on the 30th of August 1878 a great portion of the town was ruined by a terrific storm.

MISPICKEL, a mineral consisting of iron sulpharsenide, FeAsS; it contains 46% of arsenic, and is of importance as an

ore of this element. It is known also as arsenopyrite or arsenical pyrites (Ger. *Arsenikkies*): mispickel is an old name of German origin, and in the form *Mispickel* was used by G. Agricola in 1546. The crystals are orthorhombic, with angles similar to those of marcasite; they are often prismatic in habit, and the prism *M* is usually terminated by the deeply striated faces of an obtuse dome *r*. Twinning is not uncommon, the twin-planes *M* (110) and *g* (101) being the same as in marcasite. The colour of the mineral is silver-white or steel-grey, with a metallic lustre, but it is often tarnished yellow; the streak is greyish-black. The hardness is 5½–6, and the specific gravity 5.9–6.2.

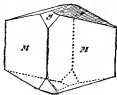

Mispickel occurs in metalliferous veins with ores of tin, copper, silver, &c. It is occasionally found as embedded crystals, for example, in serpentine at Reichenstein, Silesia. In Cornwall and Devon it is associated with cassiterite in the tin-lodes, but is also found in the copper-lodes: well crystallized specimens have been obtained from the neighbourhood of Tavistock, Redruth and St Agnes. Mispickel is the principal source of arsenious oxide or the "white arsenic" of commerce (see ARSENIC). The chief supplies are from Cornwall and Devon, and Freiberg in Saxony, and from Canada and the United States.

Danaite is a cobaltiferous variety of mispickel, containing up to 9% of cobalt replacing iron; it was first noticed by J. F. Dana in 1824 at Franconia in New Hampshire. This variety forms a passage to the species glaucodote, (Co,Fe)AsS, which is found as well-developed orthorhombic crystals in copper ore at Häkånshöda in Ramberg parish, Vestmanland, Sweden. Other species belonging to this isomorphous group of orthorhombic minerals are marcasite (FeS₂), löllingite (FeAs₂), safflorite (CoAs₂) and rammelsbergite (NiAs₂). (L. J. S.)

MISPRISION (from O. Fr. *mesprendre*, mod. *méprendre*, to misunderstand), a term in English law, almost obsolete, used to describe certain kinds of offence. Writers on criminal law usually divide misprision into two kinds (a) negative, (b) positive.

(a) Negative misprision is the concealment of treason or felony. By the common law of England it was the duty of every liege subject to inform the king's justices and other officers of the law of all treasons and felonies of which the informant had knowledge, and to bring the offender to justice by arrest (see Sheriffs Act 1837, s. 8). The duty fell and still falls primarily on the grand jurors of each county borough or franchise, and is performed by indictment or presentment, but it also falls in theory on all other inhabitants (see Pollock and Maitland, *Hist. Eng. Law*, ii. 505). Failure by the latter to discharge this public duty constitutes what is known as misprision of treason or felony (see 3 Co. Inst., 139).

Misprision of Treason, in the words of Blackstone, "consists in the bare knowledge and concealment of treason, without any degree of assent thereto, for any assent makes the party a principal traitor." According to Bracton, de Coronis, seq. 118, failure to reveal the treason of another was in itself high treason, but statutes of 1551–1552 and 1554–1555 made concealment of treason misprision only. Most of the statutes regulating procedure on trials for treason also apply to misprision of treason. The punishment is loss of the profit of the lands of the offender during life, forfeiture of all his goods and imprisonment for life. These punishments are not affected by the Forfeiture Act 1870.

Misprision of Felony is the concealment of a felony committed by another person, but without such previous concert with, or subsequent assistance of the offender, as would make the concealer an accessory before or after the fact. The offence is a misdemeanour punishable on indictment by fine and imprisonment.

(b) Positive misprision is the doing of something which ought not to be done; or the commission of a serious offence falling short of treason or felony, in other words of a misdemeanour of a public character (e.g. maladministration of high officials, contempt of the sovereign or magistrates, &c.). To endeavour to dissuade a witness from giving evidence, to disclose an examination before the privy council, or to advise a prisoner to stand mute, used to be described as misprisings (Hawk. P. C. bk. I. c. 20).

The old writers say that a misprision is contained in every felony and that the Crown may elect to prosecute for the misprision instead of the felony. This proposition merely affirms the right of the Crown to choose a more merciful remedy in certain cases, and has no present value in the law. Positive misprisions are now only of antiquarian interest, being treated as misdemeanours.

In the United States, misprision of treason is defined to be the crime committed by a person owing allegiance to the United States, and having knowledge of the commission of any crime against them, who conceals and does not, as soon as may be, disclose and make known the same to the president or to some judge of the United States, or to the governor, or to some judge or justice of a particular state. The punishment is imprisonment for not more than seven years and a fine of not more than one thousand dollars.

MISRULE, LORD OF, in medieval times the master of the Christmas revels. Probably J. G. Frazer (*Golden Bough* III.) is right in suggesting that the lord or abbot of misrule is the successor of the king of the ancient Roman Saturnalia, who personated Saturn and suffered martyrdom at the end of the revels. Compare, too, the burlesque figure at the carnival, which is finally destroyed. Stow (*Survey*) writes: "In the feast of Christmas there was in the King's House, wheresoever he lodged, a Lord of Misrule or Master of merry sports, and the like had ye in the house of every nobleman of honour or good worship, were he spiritual or temporal." The mayor and sheriffs of London also had Lords of Misrule. These mock-monarchs began their reign on Allhallows Eve, and misruled till Candlemas. In Scotland they were known as "Abbots of Unreason," and in 1555 a special act suppressing them was passed. In Tudor times their reign was marked by much display and expense. In Henry VIII.'s reign an order for a fool's coat is signed by six of the Privy Council. By an Act of Common Council (1555) the city expenses of the Lords of Misrule were severely curtailed. Machyn speaks of a Lord of Misrule who in 1561 rode through London followed by a hundred gentlemen on horseback hung with gold chains (see also REVELS, MASTER OF).

MISSAL, the book containing the liturgy, or office of the mass (*missa*), of the Roman Catholic Church. This name (e.g. *Missale gothicum*, *francorum*, *gallicanum vetus*) began to supersede the older word *Sacramentary* (*sacramentarium*, *liber sacramentorum*) from about the middle of the 8th century.¹ At that period the book so designated contained merely the fixed canon of the mass or consecration prayer (*actionem*, *preceam*, *canonicam*, *canonem actionis*), and the variable collects, *secretæ* or orations *super oblata*, prefaces, and post-communions for each fast, vigil, festival or feria of the ecclesiastical year; for a due celebration of the Eucharist they required accordingly to be supplemented by other books, such as the *Antiphonary*, afterwards called the *Graduale*, containing the proper antiphons (*introits*), *responsories* (*graduals*), *tracts*, *sequences*, *offertories*, *communions* and other portions of the communion service designed to be sung by the schola or choir, and the *Lectiary* (or *epistolary* and *evangelistary*) with the proper lessons.²

¹ It first occurs in Egbert of York's *De remediis peccatorum*, where it refers to the sacramentary of Gregory the Great.

² One of the most celebrated of the early missals is the Stowe missal of the 6th century in the British Museum. It contains the litany of the saints, the *gloria* with the collects, the part of the Epistle to the Corinthians relating to the Eucharist, the *credo* and the *consecratio* and *memento* corresponding exactly to the Roman canon. After the daily mass follow the *missa apostolorum*, *missa sanctorum*, *missa pro poenitentibus vivis* and the *missa pro mortuis*. To the 7th century belong the *Missale francorum* and the *Missale gothicum*, originally in the abbey of Fleury. In the 8th century we find in Egbert of York's *De remediis peccatorum*, i., that those who devote their lives to sacred orders are supposed to furnish themselves with a psalter, lectiary, antiphonary, missal, baptismal office and martyrology. The adoption of the Roman liturgy by Charlemagne explains the great quantity of missals within this period; e.g. the missal of Worms in the library of the Arsenal at Paris. From the 10th century we have the missal of St Vougray, although badly mutilated, and several others. From the 12th century missals became common, and more so with the invention of printing.

Afterwards missals contained more or less fully the antiphons and lessons as well as the prayers proper to the various days, and these were called *missalia plenaria*. All modern missals are of this last description. The *Missale romanum ex decreto ss. concilii tridentini restitutum*, now in almost exclusive use throughout the Latin obedience, owes its present form to the council of Trent, which undertook the preparation of a correct and uniform liturgy, and entrusted the work to a committee of its members. This committee had not completed its labours when the council rose, but the pope was instructed to receive its report when ready and to act upon it. The "reformed missal" was promulgated by Pius V. on the 14th of July 1570, and its universal use enjoined, the only exceptions being churches having local liturgies which had been in unbroken use for at least two centuries.³ It has subsequently undergone slight revisions under Clement VIII. (1604), Urban VIII. (1634) and Leo XIII. (1884), and various new masses, both obligatory and permissive, universal and local, have been added. Although the Roman is very much larger than any other liturgy, the communion office is not in itself inordinately long. The greater part of it is contained in the "ordinary" and "canon" of the mass, usually placed about the middle of the missal, and occupies, though in large type, only a few pages. The work owes its bulk and complexity to two circumstances. On the one hand, in the celebration of the sacrifice of the mass practically nothing is left to the discretion of the officiating priest; everything—what he is to say, the tone and gestures with which he is to say it, the cut and colour of the robe he is to wear—is carefully prescribed in the rubrics.⁴ On the other hand, the Roman, like all the Western liturgies, is distinguished from those of the Eastern Church by its flexibility. A distinctive character has been given to the office for each ecclesiastical season, for each fast or festival of the year, almost for each day of the week; and provision has also been made of a suitable communion service for many of the special occasions both of public and of private life.

The different parts of the Roman communion office are not all of the same antiquity. Its essential features are most easily caught, and best understood, by reference to the earliest *Sacramentaries* (particularly the Gregorian, which was avowedly the basis of the labours of the Tridentine committee), to the Gregorian *Antiphonary*, and to the oldest redaction of the *Ordo romanus*.⁵ The account of the mass (*qualiter Missa Romana celebratur*) as given by the *sacramentarium gregorianum* is to the effect that there is in the first place "the *Introit* according to the time, whether for a festival or for a common day; thereafter *Kyrie eleison*. [In addition to this *Gloria in excelsis Deo* is said if a bishop be (the celebrant), though only on Sundays and festivals; but a priest is by no means to say it, except only at Eastertide. When there is a litany (*quando letania agitur*) neither *Gloria in excelsis* nor *Aleluia* is sung.] Afterwards the *Oratio* is said, whereupon follows the *Apostolos*, also the *Gradual* and *Aleluia*. Afterwards the *Gospel* is read. Then comes the *Offertory*,⁶ and the *Oratio super oblata* is said." Then follow the *Sursum corda*, the *Preface*, *Canon*, *Lord's Prayer* and "embolism" (*ἐμβόλισμα* or insertion, *Libera nos, Domine*), given at full length precisely as they still occur in the Roman missal.

³ The English missal consequently continued to be used by English Roman Catholics until towards the end of the 17th century, when it was superseded by the Roman through Jesuit influence. The Gallican liturgy held its ground until much more recently, but has succumbed under the Ultramontanism of the bishops.

⁴ In all the older liturgies the comparative absence of rubrics is conspicuous and sometimes perplexing. It is very noticeable in the Roman *Sacramentaries*, but the want is to some extent supplied by the very detailed directions for a high pontifical mass in the various texts of the *Ordo Romanus* mentioned below. That there was no absolutely fixed set of rubrics in use in France during the 8th century is shown by the fact that each priest was required to write out an account of his own practice ("libellum ordinis") and present it for approbation to the bishop in Lent (see Baluze, *Cap. Reg. Franc. i.* 824, quoted in Smith's *Dic. of Chr. Antiq.* ii. 1521).

⁵ For the genealogical relationships of the Roman with other liturgies, see LITURGY. For the doctrines involved in the "sacrifice of the mass," see EUCHARIST.

⁶ Some editions do not mention the Offertory here.

In every liturgy of all the five groups a passage similar to this occurs, beginning with *Sursum corda*, followed by a *Preface* and the recitation of the *Sanctus* or Angelic Hymn. The "canon" or consecration prayer, which in all of them comes immediately after, invariably contains our Lord's words of institution, and (except in the Nestorian liturgy) concludes with the Lord's Prayer and "embolism." But there are certain differences of arrangement, by which the groups of liturgies can be classified. Thus it is distinctive of the liturgy of Jerusalem that the "great intercession" for the quick and the dead follows the words of institution and an Epiklesis (*ἐπίκλησις τοῦ πνεύματος ἁγίου*) or petition for the descent of the Holy Spirit upon the gifts; in the Alexandrian the "great intercession" has its place in the *Preface*; in the East Syrian it comes between the words of restitution and the Epiklesis; in the Ephesine it comes before the *Preface*; while in the Roman it is divided into two, the commemoration of the living being before, and that of the dead after, the words of institution. Other distinctive features of the Roman liturgy are (1) the position of the "Pax" after the consecration, and not as in all the other liturgies at a very early stage of the service, before the *Preface* even; and (2) the absence of the Epiklesis common to all the others.¹ The words of its "canonical prayer" are of unknown antiquity; they are found in the extant manuscripts of the *Sacramentarium gelasianum*, and were already old and of forgotten authorship in the time of Gregory the Great, who, in a letter to John, bishop of Syracuse (*Registr. Epist. vii. 64*), speaks of it as "the prayer composed by a 'scholastic'" (*precem quam scholasticus composuerat*). The same letter is interesting as containing Gregory's defence, on the ground of ancient use, of certain parts of the Roman ritual to which the bishop of Syracuse had taken exception as merely borrowed from Constantinople. Thus we learn that, while at Constantinople the *Kyrie eleison* was said by all simultaneously, it was the Roman custom for the clergy to repeat the words first and for the people to respond, *Christe eleison* being also repeated an equal number of times. Again, the Lord's Prayer was said immediately after the consecration aloud by all the people among the Greeks, but at Rome by the priest alone.

The meagre liturgical details furnished by the *Sacramentarium gregorianum* are supplemented by the texts of the *Ordo romanus*, the first of which dates from about the year 730. The ritual they enjoin is that for a pontifical high mass in Rome itself; but the differences to be observed by a priest "quando in statione facta missas" are comparatively slight. Subjoined is a précis of *Ordo Romanus I.*

It is first of all explained that Rome has seven ecclesiastical regions, each with its proper deacons, subdeacons and acolytes. Each region has its own day of the week for high ecclesiastical functions, which are celebrated by each in rotation. [This accounts for the Statio ad S. Mariam Majorum, ad S. Crucem in Jerusalem, ad S. Petrum, &c., prefixed to most of the masses in the *Gregorian Sacramentary*, and still retained in the "Proprium de Tempore" of the Roman missal.] The regulations for the assembling and marshalling of the procession by which the pontiff is met and then escorted to the appointed station are minutely given, as well as for the adjustment of his vestments "at bene sedent" when the sacristy has been reached. He does not leave the sacristy until the *Introit* has begun by the choir in the church. Before the *Gloria* he takes his stand at the altar, and after the *Kyrie Eleison* has been sung (the number of times is left to his discretion) he begins the *Gloria in excelsis*, which is taken up by the choir. During the singing he faces eastward; at its close he turns round for a moment to say "Pax vobis," and forthwith proceeds to the *Oratio*.² This finished, all seat themselves in order while the subdeacon ascends the ambo and reads [the *epistle*]. After he has done, the sacristy with his book (cantatorio) ascends and gives out the response (*Responsum*) with the *Alleluia* and *Tractus* in addition if the season calls for either. The deacon then silently kisses the feet of the pontiff and receives his blessing in the words "Dominus sit in corde tuo et in labiis tuis." Preceded by acolytes with lighted candles and subdeacons burning incense, he ascends the ambo, where he reads the *Gospel*. At the close, with the words "Pax tibi" and

"Dominus vobiscum," the pontiff, after another *Oratio*, descends to the "senatorium" accompanied by certain of the inferior clergy, and receives in order the oblations of the rulers (oblationes principum), the archdeacon who follows taking their "amulus" of wine and pouring them into a larger vessel; similar offerings are received from the other ranks and classes present, including the women. This concluded, the pontiff and archdeacon wash their hands, the offerings being meanwhile arranged by the subdeacons on the altar, and water, supplied by the leader of the choir (archiparaphonista), being mingled with the wine. During this ceremony the schola have been engaged in singing the *Offertorium*; when all is ready the pontiff signs to them to stop, and enters upon the *Preface*, the subdeacons giving the responses. At the Angelic Hymn (*Sanctus*) all kneel and continue kneeling, except the pontiff, who rises alone and begins the *Canon*. At the words "per quem haec omnia" the archdeacon lifts the cup with the oblates, and at "Pax Domini sit semper vobiscum" he gives the peace to the clergy in their order, and to the laity. The pontiff then breaks off a particle from the consecrated bread and lays it upon the altar; the rest he places on the paten held by the deacon. It is then distributed while *Agnus Dei* is sung. The pontiff in communicating puts the particle into the cup, saying, "Fiat commixtio et consecratio corporis et sanguinis Domini nostri Jesu Christi accipientibus nobis in vitam aeternam." Those present communicate in their order under this species also. As the pontiff descends into the senatorium to give the communion, the schola begins the communion *Antiphon*, and continues singing the *Psalm* until, all the people having communicated, they receive the sign to begin the *Gloria*, after which, the verse having been again repeated, they stop. The celebrant, then, facing eastward, offers the *Oratio ad commendum*, which being finished the archdeacon says to the people, "Ite, missa est," they responding with "Deo gratias."

To complete our idea of the Roman communion office as it was prior to the end of the 8th century we must now turn to the Gregorian *Antiphonarius sive gradualis liber ordinatus per circulum anni*, which as its name implies contains those variable portions of the mass which were intended to be sung by the schola or choir. It gives for each day for which a proper mass is provided: (1) the *Antiphona* (Antiphona ad Introitum) and *Psalmus*; (2) the *Responsorium* and *Versus*, with its *Alleluia* and *Versus*; (3) the *Offertorium* and *Versus*; (4) the *Communio* and *Psalmus*. Some explanation of each of these terms is necessary. (1) The word *Antiphon* (ἀντίφωνον, O. Eng. *Antefn*, Eng. *Anthem*) in its ecclesiastical use has reference to the very ancient practice of relieving the voices of the singers by dividing the work between alternate choirs. In one of its most usual meanings it has the special signification of a sentence (usually scriptural) constantly sung by one choir between the verses of a psalm or hymn sung by another. According to the Roman liturgiologists it was Pope Celestine who enjoined that the Psalms of David should be sung (in rotation, one presumes) antiphonally before mass; in process of time the antiphon came to be sung at the beginning and end only, and the psalm itself was reduced to a single verse. In the days of Gregory the Great the introit appears to have been sung precisely as at present—that is to say, after the antiphon proper, the *Psalmus* with its *Gloria*, then the antiphon again. (2) The *Responsorium*, introduced between the epistle and gospel, was probably at first an entire psalm or canticle, originally given out by the cantor from the steps from which the epistle had been read (hence the later name *Graduale*), the response being taken up by the whole choir. (3) The *Offertorium* and *Communio* correspond to the "hymn from the book of Psalms" mentioned by early authorities (see, for example, Augustine, *Retr. ii. 11; Ap. Const. viii. 13*) as sung before the oblation and also while that which had been offered was being distributed to the people. A very intimate connexion between these four parts of the choral service can generally be observed; thus, taking the first Sunday in the ecclesiastical year, we find both in the *Antiphonary* and in the modern *Missal* that the antiphon is Ps. xxv. 1-3, the psalmus Ps. xxv. 4, the responsorium (graduale) and versus Ps. xxv. 3 and xxv. 4, the offertorium and versus Ps. xxv. 1-3 and xxv. 5. The communion is Ps. lxxxv. 12, one of the verses of the responsorium being Ps. lxxxv. 7. In the selection of the introits there are also traces of a certain rotation of the psalms in the *Psalter* having been observed.

The first pages of the modern Roman missal are occupied with the *Calendar* and a variety of explanations relating to the

¹ This was one of the points discussed at the council of Florence, and Cardinal Bessarion for a time succeeded in persuading the Greeks to give up the Epiklesis.

² *Quam collectam dicunt, Ord. Rom. II.*

³ After singing "Credo in unum Deum," *Ord. Rom. II.*

year and its parts, and the manner of determining the movable feasts. The general rubrics (*Rubricae generales missalis*) follow, explaining what are the various kinds of mass which may be celebrated, prescribing the hours of celebration, the kind and colour of vestments to be used, and the ritual to be followed (*ritus celebrandi missam*), and giving directions as to what is to be done in case of various defects or imperfections which may arise. The *Præparatio ad missam*, which comes next, is a short manual of devotion containing psalms, hymns and prayers to be used as opportunity may occur before and after celebration. Next comes the proper of the season (*Proprium missarum de tempore*), occupying more than half of the entire volume. It contains the proper introit, collect (one or more), epistle, gradual (tract or sequence), gospel, offertory, secreta (one or more), communion and post-communion for every Sunday of the year, and also for the festivals and ferias connected with the ecclesiastical seasons, as well as the offices peculiar to the ember days, Holy Week, Easter and Whitsuntide. Between the office for Holy Saturday and that for Easter Sunday the ordinary of the mass (*Ordo missae*), with the solemn and proper prefaces for the year, and the canon of the mass are inserted. The proper of the season is followed by the proper of the saints (*Proprium sanctorum*), containing what is special to each saint's day in the order of the calendar, and by the *Commune sanctorum*, containing such offices as the common of one martyr and bishop, the common of one martyr not a bishop, the common of many martyrs in paschal time, the common of many martyrs out of paschal time, and the like. A variety of masses to be used at the feast of the dedication of a church, of masses for the dead, and of votive masses (as for the sick, for persons journeying, for bridegroom and bride) follow, and also certain benedictions. Most missals have an appendix also containing certain local masses of saints to be celebrated "ex indulto apostolico."

Masses fall into two great subdivisions: (1) ordinary or regular (*secundum ordinem officii*), celebrated according to the regular rotation of fast and feast, vigil and feria, in the calendar; (2) extraordinary or occasional (*extra ordinem officii*), being either "votive" or "for the dead," and from the nature of the case having no definite time prescribed for them. Festival masses are either double, half-double or simple, an ordinary Sunday mass being a half-double. The difference depends on the number of collects and secretae; on a double only one of each is offered, on a half-double there are two or three, and on a simple there may be as many as five, or even seven, of each. Any mass may be either high (*missa solennis*) or low (*missa privata*). The distinction depends upon the number of officiating clergy, certain differences of practice as to what is pronounced aloud and what inaudibly, the use or absence of incense, certain gestures and the like. Solitary masses are forbidden; there must be at least an acolyte to give the responses. The vestments prescribed for the priest are the amice, alb, cingulum or girdle, maniple, stole and chasuble (*planetia*). There are certain distinctions of course for a bishop or abbot. The colour of the vestments and of the drapery of the altar varies according to the day, being either white, red, green, violet or black. This last custom does not go much further back than Innocent III., who explains the symbolism intended (see VESTMENTS).

Subjoined is an account of the manner of celebrating high mass according to the rite at present in force.

1. The priest who is to celebrate, having previously confessed (if necessary) and having finished matins and lauds, is to seek leisure for private prayer (fasting) and to use as he has opportunity the "prayers before mass" already referred to. How the robing in the sacristy is next to be gone about is minutely prescribed, and prayers are given to be used as each article is put on. The sacramental elements having previously been placed on the altar or on a credence table, the celebrant enters the church and takes his stand before the lowest step of the altar, having the deacon on his right and the subdeacon on his left. After invoking the Trinity (In nomine Patris, &c.) he repeats alternately with those who are with him the psalm "Judica me, Deus," which is preceded in the usual way by an antiphon (Introibo ad altare Dei), and followed also by the Gloria and Antiphon. The versicle "Adjutorium nostrum," with its

response "Qui fecit," is followed by the "Confiteor,"² said alternately by the priest and by the attendants, who in turn respond with the prayer for divine forgiveness, "Misereatur." The priest then gives the absolution ("Indulgentiam"), and after the versicles and responses beginning "Deus, tu conversus" he audibly says, "Oremus," and ascending to the altar silently offers two short prayers, one asking for forgiveness and liberty of access through Christ, and another indulgence for himself, through the merits of the saints, whose relics are here. Receiving the Thurible from the deacon he censes the altar, and is thereafter himself censed by the deacon. He then reads the Introit, which is also sung by the choir; the *Kyrie eleison* is then said, after which the words *Gloria in excelsis*³ are sung by the celebrant and the rest of the hymn completed by the choir.

2. Kissing the altar, and turning to the people with the formula "Dominus vobiscum," the celebrant proceeds with the collect or collects proper to the season or day, which are read secretly. The epistle for the day is then read by the subdeacon, and is followed by the gradual, tract, alleluia or sequence, according to the time.⁴ This finished, the deacon places the book of the gospels on the altar, and the celebrant blesses the incense. The deacon kneels before the altar and offers the prayer "Munda cor meum," afterwards takes the book from the altar, and kneeling before the celebrant asks his blessing, which he receives with the words "Dominus sit in corde tuo." Having kissed the hand of the priest, he goes accompanied by acolytes with incense and lighted candles to the pulpit, and with "Dominus vobiscum" and minutely prescribed crossings and censings goes out and reads the gospel for the day, at the close of which "Laus tibi, Christe" is said, and the book is brought to the celebrant and kissed with the words "Per evangelica dicta delectantur nostra delicta." The celebrant then standing at the middle of the altar sings the words "Credo in unum Deum," and the rest of the Nicene creed is sung by the choir.⁵

3. With "Dominus vobiscum" and "Oremus" the celebrant proceeds to read the offertory, which is also sung by the choir. This finished he receives the paten with the host from the deacon, and after offering the host with the prayer beginning "Suscipe, Sancte Pater" places it upon the corporal. The deacon then ministers wine and the subdeacon water, and before the celebrant mixes the water with the wine he blesses it in the prayer "Deus qui humanæ." He then takes the chalice, and having offered it ("Offerimus tibi, Domine") places it upon the corporal and covers it with the pall. Slightly bowing over the altar, he then offers the prayer "In spiritu humilitatis," and, lifting up his eyes and stretching out his hands, proceeds with "Veni sanctificator." After blessing the people "Per intercessionem beati Michaelis archangelus" he takes the thurible from the deacon and censes the bread and wine and altar, and is afterwards himself censed as well as the others in their order. Next going to the epistle side of the altar he washes his fingers as he recites the verses of the 26th Psalm beginning "Lavabo." Returning and bowing before the middle of the altar, with joined hands he says, "Suscipe, sancta Trinitas," then turning himself towards the people he raises his voice a little and says, "Orate, fratres" ("that my sacrifice and yours may be acceptable to God the Father Almighty"), the response to which is "Suscipiat Dominus sacrificium de manibus tuis," &c. He then recites the secret prayer or prayers, and at the end says, with an audible voice, "Per omnia saecula saeculorum" (R. "Amen").

4. Again saluting with a "Dominus vobiscum" he lifts up his hands and goes on to the *Sursum corda* and the rest of the *Preface*. A different intonation is given for each of the prefaces.⁶ At the *Sanctus* the handbell is rung. If there is a choir the *Sanctus* is sung while the celebrant goes on with the canon.⁷ After the words of consecration of the wafer, which are said "secretly, distinctly and attentively," the celebrant kneels and adores the host, rising elevates it, and replacing it on the corporal again adores

Introitum further on. This use of the 43rd Psalm goes as far back at least as the end of the 11th century, being mentioned by Micrologus (1080). It is omitted in masses for the dead and during Holy Week.

² A form very similar to the present is given by Micrologus, and it is foretold even in liturgical literature of the 8th century.

³ During Lent and Advent, and in masses for the dead, this is omitted. In low masses it is of course said, not sung (if it is to be said). It may be added that this early position of the *Gloria in excelsis* is one of the features distinguishing Roman from Ephesine use.

⁴ The tract is peculiar to certain occasions, especially of a mournful nature, and is sung by a single voice. By a sequence is understood a more or less metrical composition, not in the words of Scripture, having a special bearing on the festival of the day. See, for example, the sequence "Lauda Sion Salvatorem" on Corpus Christi day.

⁵ On certain days the *Credo* is omitted.

⁶ Now eleven; they were at one time much more numerous.

⁷ The approved usage appears to be in that case that it is sung as far as "Hosanna in excelsis" before the elevation, and "Benedictus qui venit" is reserved till afterwards. In France it was a very common custom, made general for a time at the request of Louis XII., to sing "O salutaris hostia" at the elevation.

¹ This antiphon is not to be confounded with the Antiphona ad

it (the bell meanwhile being rung).¹ The same rite is observed when the chalice is consecrated. Immediately before the Lord's Prayer, at the words "per ipsum et cum ipso et in ipso," the sign of the cross is made three times over the chalice with the host, and towards the close of the "embolism" the fraction of the host takes place. After the words "Pax Domini sit semper vobiscum" the emission of the particle into the cup takes place with the words "Haec commixtio et consecratio," &c. The celebrant then says the *Agnus Dei* three times.

5. While the choir sings the *Agnus Dei* and the Communion, the celebrant proceeds, still "secrete," with the remainder of the office, which though printed as part of the canon is more conveniently called the communion and post-communion. After the prayer for the peace and unity of the Church ("Domine Jesu Christe, qui dixisti") he salutes the deacon with the kiss of peace, saying, "Pax tecum"; the subdeacon is saluted in like manner, and then conveys the "pax" to the rest of the clergy who may be assisting. The celebrant then communicates under both species with suitable prayers and actions, and afterwards administers the sacrament to the other communicants if there be any. Then while the wine is poured into the cup for the first abtution he says, "Quod ideo sumpsimus"; having taken it he says, "Corpus tuum, Domine." After the second abtution he goes to the book and reads the Communion. Then turning to the people with "Dominus vobiscum" he reads the post-communion (one or more); turning once more to the congregation he uses the old dismissal formula "Dominus vobiscum" (R. "Et cum spiritu tuo"), and "Ite, missa est" or "Benedicamus Domino," in those masses from which *Gloria in excelsis* has been omitted (R. "Deo Gratias"). Bowing down before the altar he offers the prayer "Placatum tibi sancta Trinitas," turning round he makes the sign of the cross over the congregation with the words of the benediction ("Benedic").² He then reads the passage from the gospel of John beginning with "In principio erat Verbum," or else the proper gospel of the day.³

MISSI DOMINICI, the name given to the officials commissioned by the Frankish kings and emperors to supervise the administration of their dominions. Their institution dates from Charles Martel and Pippin the Short, who sent out officials to see their orders executed. When Pippin became king in 754 he sent out *missi* in a desultory fashion; but Charlemagne made them a regular part of his administration, and a *capitulary* issued about 802 gives a detailed account of their duties. They were to execute justice, to enforce respect for the royal rights, to control the administration of the counts, to receive the oath of allegiance, and to supervise the conduct and work of the clergy. They were to call together the officials of the district and explain to them their duties, and to remind the people of their civil and religious obligations. In short they were the direct representatives of the king or emperor. The inhabitants of the district they administered had to provide for their subsistence, and at times they led the host to battle. In addition special instructions were given to various *missi*, and many of these have been preserved. The districts placed under the *missi*, which was their duty to visit four times a year, were called *missatici* or *legationes*. They were not permanent officials, but were generally selected from among persons at the court, and during the reign of Charlemagne personages of high standing undertook this work. They were sent out in twos, an ecclesiastic and a layman, and were generally complete strangers to the district which they administered. In addition there were extraordinary *missi* who represented the emperor on special occasions, and at times beyond the limits of his dominions. Even under the strong rule of Charlemagne it was difficult to find men to discharge these duties impartially, and after his death in 814 it became almost impossible. Under the emperor Louis I. the nobles interfered in the appointment of the *missi*, who, selected from the district in which their duties lay, were soon found watching their own interests rather than those of the central power. Their duties became merged in the ordinary work of the bishops and counts, and under the emperor Charles the Bald they took control of associations

¹ The history of the practice of elevating the host seems to have arisen out of the custom of holding up the oblations, as mentioned in the *Ordo Romanus* (see above). The elevation of the host, as at present practised, was first enjoined by Pope Honorius III. The use of the host as the elevation is still later, and was first made general by Gregory XI.

² The benediction is omitted in masses for the dead.

³ The reading of the passage from John on days which had not a proper gospel was first enjoined by Pius V.

for the preservation of the peace. About the end of the 9th century they disappeared from France and Germany, and during the 10th century from Italy. It is possible that the itinerant justices of the English kings Henry I. and Henry II., the itinerant *baillis* of Philip Augustus king of France, or the royal *enquêteurs* of St Louis originated from this source.

See G. Waitz, *Deutsche Verfassungsgeschichte* (Kiel, 1844); E. Bourgeois, *Le Capitulaire de Kiery-sur-Oise* (Paris, 1885); V. Krause, *Geschichte des Institutes der missi dominici in den Mithelungen des Instituts für österreichische Geschichtsforschung*, Band XI, (Innsbruck, 1880). E. Dobbert, *Über das Wesen und den Geschäftsbereich der missi dominici* (Heidelberg, 1861); N. D. Fustel de Coulanges, *Histoire des institutions politiques de l'ancienne France* (Paris, 1889-1890); L. Beauchet, *Histoire de l'organisation judiciaire en France, époque franque* (Paris, 1865).

MISSIONS (Lat. *missio*, a sending) the term used specially for the propagandist operations of the Christian Church among the heathen, the executors of this work being missionaries. Both "mission" and "missionary" have hence come to be used of similar works in other spheres. The history of Christian missions may, for practical purposes, be divided into three chief periods: (1) the primitive, (2) the medieval and (3) the modern.

THE PRIMITIVE PERIOD

There can be little doubt that the Christian Church derived its missionary impulse from the teaching of its founder. Even though we may feel some hesitancy, in the light of modern criticism, about accepting as authentic the specific injunctions ascribed to Jesus by Matthew (ch. xviii. 19) and Luke (ch. xxiv. 47; Acts i. 8), it must be admitted that the teaching of Jesus, in the emphasis which it laid on the Fatherhood of God and the brotherhood of man, was bound sooner or later to break away from the trammels of Judaism, and assert itself in the form of Christian missions. The triumph of this "universalistic" element in the teaching of Christ is vividly portrayed in the Acts of the apostles. At the beginning of the Acts the Christian Church is a little Jewish sect; long before the end is reached it has become a world-conquering spiritual force. The transformation was due in its initial stages to broad-minded men like Stephen, Philip and Barnabas who were the first pioneers of missionary work. Their efforts, however, were soon completely eclipsed by the magnificent achievements of the apostle Paul, who evangelized a large part of Asia Minor and the most important cities of Greece. The success which attended the work of the great apostle to the Gentiles stamped Christianity as a missionary religion for ever. From this point onwards Christianity pushed its way into all the great centres of population. We know very little about the missionaries of the first three centuries. We suddenly find province after province christianized though there is nothing to show how and by whom the work was done. The case of Bithynia is an excellent illustration of this. When Pliny wrote his famous letter to Trajan (A.D. 112), Christianity had taken such a firm hold of the province that its influence had penetrated into remote country districts, pagan festivals were almost entirely neglected, and animals for sacrifice could scarcely find purchasers. Yet the history of the conversion of Bithynia is absolutely buried in oblivion. By the time of Constantine, Christianity had practically covered the whole empire. Harnack has tabulated the results which our scanty data allow us to reach in his *Expansion of Christianity*. He divides the countries which had been evangelized by the close of the 3rd century into four groups: (1) Those countries in which Christianity numbered nearly one-half of the population and represented the standard religion of the people, viz. most of what we now call Asia Minor, that portion of Thrace which lay over against Bithynia, Armenia, the city of Edessa. (2) Those districts in which Christianity formed a very material portion of the population, influencing the leading classes and being able to hold its own with other religions, viz. Antioch and Coele-Syria, Cyprus, Alexandria together with Egypt and the Thebais, Rome and the lower parts of Italy, together with certain parts of middle Italy, Proconsular Africa and Numidia, Spain, the maritime parts of Greece, the southern coasts of Gaul.

(3) Those districts in which Christianity was sparsely scattered, viz. Palestine, Phoenicia, Arabia, certain parts of Mesopotamia, the interior districts of Greece, the provinces on the north of Greece, the northern districts of middle Italy, the provinces of Mauretania and Tripolis. (4) Those districts in which Christianity was extremely weak or where it was hardly found at all: the districts to the north and north-west of the Black Sea, the western section of upper Italy, middle and upper Gaul, Belgica, Germany, Rhaetia, the towns of ancient Philistia. It is not possible to obtain even an approximate estimate of the numbers of the Christians at the time of Constantine. Friedländer, for instance, does not think that they exceeded by much Gibbon's estimate for the reign of Decius, viz. one-twentieth of the population. La Bastie and Burckhardt put the ratio at one-twelfth, Matter at a fifth and Stäudlin even at a half (see Harnack ii. 453).

After the end of the 3rd century missionary enterprise was mainly concentrated on the outlying borders of the empire. In the 4th and 5th centuries may be mentioned Gregory the Illuminator, the "apostle of Armenia" (about 300), Ulfilas, the "apostle of the Goths," about 325; Frumentius,¹ a bishop of Abyssinia, about 327; Nino, the Armenian girl who was the means of converting the kingdom of Iberia (now Georgia), about 330;² Chrysostom, who founded at Constantinople in A.D. 404 an institution in which Goths might be trained to preach the Gospel to their own people;³ Martin of Tours, who evangelized the central districts of Gaul; Valentinus, the "apostle of Noricum," about 440; Honoratus, who from his monastic home in the islet of Lerins, about 410, sent missionaries among the masses of heathendom in the neighbourhood of Arles, Lyons, Troyes, Metz and Nice; and St Patrick, who converted Ireland into "the isle of saints" (died either in 463 or 495).

THE MEDIEVAL PERIOD

With the 5th century the Church was confronted with numberless hordes, which were now precipitated over the entire face of Europe. Having for some time learnt to be aggressive, she girded herself for the difficult work of teaching the nations a higher faith than a savage form of nature-worship, and of fitting them to become members of an enlightened Christendom.

(a) *The Celtic Missionaries.*—The first pioneers who went forth to engage in this difficult enterprise came from the secluded Celtic Churches of Ireland and the Scottish Highlands. Of many who deserve mention in connexion with this period, the most prominent were: Columba, the founder of the famous monastery of Iona in 563 and the evangelizer of the Albanian Scots and northern Picts; Aidan, the apostle of Northumbria; Columbanus, the apostle of the Burgundians of the Vosges (590); Callich or Gallus (d. 646), the evangelizer of north-eastern Switzerland and Alemannia; Kilian, the apostle of Thuringia; and Trudpert, the martyr of the Black Forest. The zeal of these men seemed to take the world by storm. Travelling generally in companies, and carrying a simple outfit, these Celtic pioneers flung themselves on the continent of Europe, and not content with reproducing at Annegray or Luxeuil the willow or brushwood huts, the chapel and the round tower, which they had left behind in Derry or in the island of Hy (Iona), they braved the dangers of the northern seas, and penetrated as far as the Faeroes and even far distant Iceland.⁴ "Their zeal and success," to quote the words of Kurtz, "are witnessed to by the fact that at the beginning of the 8th century, throughout all the district of the Rhine, as well as Hesse, Thuringia, Bavaria and Alemannia, we find a network of flourishing churches bearing the impress of Celtic institutions."

(b) *The English Missionaries.*—Thus they laid the foundations, aweing the heathen tribes by their indomitable spirit of self-sacrifice and the sternness of their rule of life. But, marvellous as it was, their work lacked the element of permanence; and it

became clear that a more practical system must be devised and carried out. The men for this work were now ready, and the sons of the newly evangelized English Churches were ready to go forth. The energy which warriors were accustomed to put forth in their efforts to conquer was now "exhibited in the enterprise of conversion and teaching" by Wilfrid on the coast of Friesland,⁵ by Willibrord (658-715) in the neighbourhood of Utrecht,⁶ by the martyr-brothers Ewald or Heward amongst the "old" or continental Saxons,⁸ by Swidbert the apostle of the tribes between the Ems and the Yssel, by Adalbert, a prince of the royal house of Northumbria, in the regions north of Holland, by Wursing, a native of Friesland, and one of the disciples of Willibrord, in the same region, and last, not least, by the famous Winfrid or Boniface, the "apostle of Germany" (680-755), who went forth first to assist Willibrord at Utrecht, then to labour in Thuringia and Upper Hessa, then with the aid of his kinsmen Wunibald and Willibald, their sister Walpurga, and her thirty companions, to consolidate the work of earlier missionaries, and finally to die a martyr on the shores of the Zuider Zee.

(c) *Scandinavian Missions.*—Devoted, however, as were the labours of Boniface and his disciples, all that he and they and the emperor Charlemagne after them achieved for the fierce untutored world of the 8th century seemed to have been done in vain when, in the 9th "on the north and north-west the pagan Scandinavians were hanging about every coast, and pouring in at every inlet; when on the east the pagan Hungarians were swarming like locusts and devastating Europe from the Baltic to the Alps; when on the south and south-east the Saracens were pressing on and on with their victorious hosts. It seemed then as if every pore of life were choked, and Christendom must be stifled and smothered in the fatal embrace."⁹ But the devoted Anskar (801-805) went forth and sought out the Scandinavian viking, and handed on the torch of self-denying zeal to others, who saw, after the lapse of many years, the close of the monotonous tale of burning churches and pillaged monasteries, and taught the fierce Northman to learn respect for civilized institutions.¹⁰ The gospel was first introduced into Norway in the 10th century by an Englishman named Hacon, though the real conversion of the country was due to Olaf Tryggvason. About the same time, and largely owing to the exertions of Olaf, Iceland, Greenland and the Orkney and Shetland islands were also evangelized.

(d) *Slavonic Missions.*—Thus the "gospel of the kingdom" was successively proclaimed to the Roman, the Celtic, the Teutonic and the Scandinavian world. A contest still more stubborn remained with the Slavonic tribes, with their triple and many-headed divinities, their powers of good and powers of evil, who could be propitiated only with human sacrifices. Mission work commenced in Bulgaria during the latter part of the 9th century; thence it extended to Moravia, where in 863 two Greek missionaries—Cyril and Methodius—provided for the people a Slavonic Bible and a Slavonic Liturgy; thence to Bohemia and Poland, and so onwards to the Russian kingdom of Ruric the Northman, where about the close of the 10th century the Eastern Church "silently and almost unconsciously bore into the world her mightiest offspring."¹¹ But, though the baptism of Vladimir (c. 956-1015) was a heavy blow to Slavonic idolatry, mission work was carried on with but partial success; and it taxed all the energies of Adalbert, bishop of Bremen, of Vicilin, bishop of Oldenburg, of Bishop Otto of Bamberg the apostle of the Pomeranians, of Adalbert the martyr-apostle of Prussia, to spread the word in that country, in Lithuania, and in the territory of the Wends. It was not till 1168 that the gigantic four-headed image of Swantevit was destroyed at Arcona, the capital of the island of Rügen, and this Mona of Slavonic superstition was included in the advancing circle of Christian

⁵ Church, *Gifts of Civilization*, p. 330. ⁶ Bede, *H.E.* v. 19.

⁷ "Annal. Xantenses," Pertz, *Mon. Germ.* ii. 220.

⁸ Bede, *H.E.* v. 10.

⁹ See Lightfoot, *Ancient and Modern Missions*.

¹⁰ See Hardwick, *Middle Ages*, pp. 109-114.

¹¹ Stanley, *Eastern Church*, p. 294.

¹ Socrates, *H.E.* i. 15; Sozomen ii. 24; Theodoret i. 22.

² Socrates, *H.E.* i. 20; Sozomen ii. 7; Theodoret i. 24.

³ Theodoret, *H.E.*, v. 30.

⁴ See A. W. Haddan, "Scots on the Continent," *Remains*, p. 256.

civilization. As late as 1230 human sacrifices were still being offered up in Prussia and Lithuania, and, in spite of all the efforts of the Teutonic Knights, idolatrous practices still lingered amongst the people, while amongst the Lapps, though successful missions had been inaugurated as early as 1335, Christianity cannot be said to have become the dominant religion till at least two centuries later.

(c) *Moslem Missions.*—The mention of the order of the Teutonic Knights reminds us how the crusading spirit had affected Christendom. Still even then Raimon Lull protested against propagandism by the sword, urged the necessity of missions amongst the Moslems, and sealed his testimony with his blood outside the gates of Bugiah in northern Africa (June 30, 1315). Out of the crusades, however, arose other efforts to develop the work which Nestorian missionaries from Bagdad, Edessa and Nisibis had already inaugurated along the Malabar coast, in the island of Ceylon, and in the neighbourhood of the Caspian Sea. In 1245 the Roman pontiff sent two embassies—one, a party of four Dominicans, sought the commander-in-chief of the Mongol forces in Persia; the second, consisting of Franciscans, made their way into Tartary, and sought to convert the successor of Oktai-Khan. Their exertions were seconded in 1253 by the labours of another Franciscan whom Louis IX. of France sent forth from Cyprus,¹ while in 1274 the celebrated traveller Marco Polo, accompanied by two learned Dominicans, visited the court of Kublai-Khan, and at the commencement of the 14th century two Franciscans penetrated as far as Peking, even translating the New Testament and the Psalter into the Tatar language, and training youths for a native ministry.²

(f) *Missions to India and the New World.*—These tentative missions were now to be supplemented by others on a larger scale. In 1488 the Cape of Good Hope was rounded by Diaz, and in 1508 the foundations of the Portuguese India empire were laid by Albuquerque. Columbus also in 1492 had landed on San Salvador, and the voyages of the Venetian Cabot along the coast of North America opened up a new world to missionary enterprise. Thus a grand opportunity was given to the churches of Portugal and Spain. But the zeal of the Portuguese took too often a one-sided direction, repressing the Syrian Christians on the Malabar coast, and interfering with the Abyssinian Church,³ while the fanatic temper of the Spaniard consigned, in Mexico and Peru, multitudes who would not renounce their heathen errors to indiscriminate massacre or abject slavery.⁴ Las Casas has drawn a terrible picture of the oppression he strove in vain to prevent.⁵ Some steps indeed were taken for disseminating Christian principles, and the pope had induced a band of missionaries, chiefly of the mendicant orders, to go forth to this new mission field.⁶ But only five bishoprics had been established by 1520, and the number of genuine converts was small. However, every vestige of the Aztec worship was banished from the Spanish settlements.⁷

(g) *The Jesuit Missions.*—It was during this period that the Jesuits came into existence. One of the first of Loyola's associates, Francis Xavier, encouraged by the joint co-operation of the pope and of John III. of Portugal, disembarked at Goa on the 6th of May 1542, and before his death on the Isle of St John (Hiang-Shang), on the 2nd of December 1552, roused the European Christians of Goa to a new life, laboured with singular success amongst the Paravars, a fisher caste near Cape Comorin, gathered many converts in the kingdom of Travancore, visited Malacca, and founded a mission in Japan.

The successor of Xavier, Antonio Criminalis, was regarded by the Jesuits as the first martyr of their society (1562). Matteo Ricci, an Italian by birth, was also an indefatigable missionary in China for twenty-seven years, while the unholy compromise

with Brahminism in India followed by Robert de' Nobili was fatal to the vitality of his own and other missions. Others of the same order evangelized Paraguay in 1582, while the Huguenots sent forth under a French knight of Malta a body of devoted men to attempt the formation of a Christian colony at Rio Janeiro. By the close of the 16th century a committee of cardinals was appointed under the name of the "Congregatio de propaganda fide," to give unity and solidity to the work of missions. The scheme originated with Gregory XIII., but was not fully organized till forty years afterwards, when Gregory XV. gave it plenary authority by a bull dated the 2nd of June 1622. Gregory's successor, Urban VIII., supplemented the establishment of the congregation by founding a great missionary college, where Europeans might be trained for foreign labours, and natives might be educated to undertake mission work. At this college is the missionary printing-press of the Roman Church, and its library contains an unrivalled collection of literary treasures bearing on the work.

MODERN MISSIONS

Missionary Societies.—Modern missionary activity is distinguished in a special degree by the exertions of societies for the development of mission work.

As contrasted with the colossal display of power on the part of the Church of Rome, it must be allowed that the churches which in the 16th century broke off from their allegiance to the Latin centre at first showed no great anxiety for the extension of the gospel and the salvation of the heathen. The causes of this are not far to seek. The isolation of the Teutonic churches from the vast system with which they had been bound up, the conflicts and troubles among themselves, the necessity of fixing their own principles and defining their own rights, concentrated their attention upon themselves and their own home work, to the neglect of work abroad.⁸

Still the development of the maritime power of England, which the Portuguese and Spanish monarchies noted with fear and jealousy, was distinguished by a singular anxiety for the spread of the Christian faith. Edward VI. in his instructions to the navigators in Sir Hugh Willoughby's fleet, Sebastian Cabot in those for the direction of the intended voyage to Cathay, and Richard Hakluyt, who promoted many voyages of discovery in addition to writing their history, agree with Sir Humphrey Gilbert's chronicler that "the sowing of Christianity must be the chief intent of such as shall make any attempt at foreign discovery, or else whatever is builded upon other foundation shall never obtain happy success or continuance." When on the last day of the year 1600 Queen Elizabeth granted a charter to George, earl of Cumberland, and other "adventurers," to be a body-corporate by the name of "The Governor and Company of Merchants of London trading with the East Indies," the expressed recognition of higher duties than those of commerce may by some be deemed a mere matter of form, and, to use the words of Bacon, "what was first in God's providence was but second in man's appetite and intention." Yet a keen sense of missionary duty marks many of the chronicles of English mariners. Notably was this the case with the establishment of the first English colony in America, that of Virginia, by Sir Walter Raleigh. The philosopher Thomas Harriot (1560-1621), one of his colleagues, laboured for the conversion of the natives, amongst whom the first baptism is recorded to have taken place on the 13th of August 1587.⁹ Raleigh himself presented as a parting gift to the Virginian Company the sum of £100¹⁰ for the propagation of the Christian religion" in that settlement.¹¹ When James I. granted letters patent for the occupation of Virginia it was directed that the "word and service of God be preached,

⁸ We must not, however, overlook the remarkable appeal made by Erasmus in the first book of his treatise on the art of preaching (*Ecclesiastes sive concinator evangelicus*). The salient passages are quoted in G. Smith, *Short History of Christian Missions*, pp. 116-118; Gustavus Vasa in 1559 made an effort to educate and evangelize the Lapps.

⁹ Hakluyt, *Voyages*, iii. 345.

¹⁰ Oldy, *Life of Raleigh*, p. 118.

¹ Neander vii. 69; Hakluyt 171; Huc i. 207.

² Neander vii. 79; Gieseler iv. 259, 260; Hardwick, *Middle Ages*, p. 337.

³ Geddes, *History of the Church of Malabar*, p. 4; Neale, *Eastern Church*, ii. 343.

⁴ Prescott, *Conquest of Mexico*, i. 318, iii. 218.

⁵ *Relacion de la destruccion de las Indias*.

⁶ Prescott, *Mexico*, iii. 218 n.

⁷ Prescott iii. 219.

planted and used as well in the said colonies as also as much as might be among the savages bordering among them"; and the honoured names of Nicolas Ferrar, John Ferrar, John Donne and Sir John Sandys, a pupil of Hooker, are all found on the council by which the home management of the colony was conducted.

In the year 1618 was published *The True Honour of Navigation and Navigators*, by John Wood, D.D., dedicated to Sir Thomas Smith, governor to the East India Company, and about the same time appeared the well-known treatise of Hugo Grotius, *De veritate religionis christianae*, written for the express use of settlers in distant lands. Grotius also persuaded seven law students of Lübeck to go to the East as missionaries; the best known of them was Peter Helling, who worked for 20 years in Abyssinia. A good deal of work was done by Dutch evangelists in Java, the Moluccas, Formosa and Ceylon, but it was not permanent.

The wants, moreover, of the North American colonies did not escape the attention of Archbishop Laud during his official connexion with them as bishop of London, and he was developing a plan for promoting a local episcopate there when his troubles began and his scheme was interrupted. During the Protectorate, in 1649, an ordinance was passed for "the promoting and propagating of the gospel of Jesus Christ in New England" by the erection of a corporation, to be called by the name of the President and Society for the Propagation of the Gospel in New England, to receive and dispose of moneys for the purpose, and a general collection was ordered to be made in all the parishes of England and Wales; and Cromwell himself devised a scheme for setting up a council for the Protestant religion, which should rival the Roman Propaganda, and consist of seven councillors and four secretaries for different provinces.¹ On the restoration of the monarchy, through the influence of Richard Baxter with Lord Chancellor Hyde, the charter already granted by Cromwell was renewed, and its powers were enlarged. For now the corporation was styled "The Propagation of the Gospel in New England and the parts adjacent in America," and its object was defined to be "not only to seek the outward welfare and prosperity of those colonies, but more especially to endeavour the good and salvation of their immortal souls, and the publishing the most glorious gospel of Christ among them." On the list of the corporation the first name is the earl of Clarendon, while the Hon. Robert Boyle was appointed president. Amongst the most eminent of its missionaries was the celebrated John Eliot, the Puritan minister of Roxbury, Massachusetts, who, encouraged and financially assisted by Boyle, brought out the Bible in the Indian language in 1661-1664. Boyle displayed in other ways his zeal for the cause of missions. He contributed to the expense of printing and publishing at Oxford the four Gospels and the Acts of the Apostles in the Malay language, and at his death left £5400 for the propagation of the gospel in heathen lands.

The needs of the colonial church soon excited the attention of others. George Fox, the Quaker, wrote to "All Friends everywhere that have Indians or blacks, to preach the Gospel to them and their servants." Great efforts were made by William Beveridge (1637-1708), bishop of St Asaph, William Wake (1657-1737), archbishop of Canterbury, John Sharp (1645-1714), archbishop of York, Edmund Gibson (1669-1748), bishop of London, and afterwards by the philosophic Bishop Berkeley, and Bishop Butler, the famous author of the *Analogy*, to develop the colonial church and provide for the wants of the Indian tribes. In 1666 Dr Thomas Bray, at the request of the governor and assembly of Maryland, was selected by the bishop of London as ecclesiastical commissary; and, having sold his effects, and raised money on credit, he sailed for Maryland in 1690, where he promoted, in various ways, the interests of the Church. Returning to England in 1700-1701, and supported by all the weight of Archbishop Tenison and Henry Compton, bishop of London, he was graciously received by William III., and received letters

patent under the great seal of England for creating a corporation by the name of the "Society for the Propagation of the Gospel in Foreign Parts" on the 16th of June 1701.

Meanwhile, in 1664, Von Welz, an Austrian baron, issued a stirring appeal to the Church at large for a special association devoted to extending the evangelical religion and converting the heathen. He was told that each Christian country should be responsible for its non-Christian neighbours, e.g. the Greeks for the Turks, and that as for the heathen it was no good casting pearls before swine. Finding no better response, he went himself as a missionary to Dutch Guiana. The opening of the 18th century saw other movements set on foot. Thus in 1705 Frederick IV. of Denmark founded a mission on the Coromandel coast, and inaugurated the labours of Bartholomew Ziegenbalg, Henry Plutschau and C. F. Schwartz, whose devotion and success told with such remarkable reflex influence on the Church at home. Again in 1731 the Moravians (*q.v.*) illustrated in a signal degree the growing consciousness of obligation towards the heathen. Driven by persecution from Moravia, hunted into mountain-caves and forests, they had scarcely secured a place of refuge in Saxony before, "though a mere handful in numbers, yet with the spirit of men banded for daring and righteous deeds, they formed the heroic design, and vowed the execution of it before God, of bearing the gospel to the savage and perishing tribes of Greenland and the West Indies, of whose condition report had brought a mournful rumour to their ears." And so, literally with "neither bread nor scrip," they went forth on their pilgrimage, and, incredible as it sounds, within ten years they had established missions in the islands of the West Indies, in South America, Surinam, Greenland, among the North American tribes, in Lapland, Tartary, Algiers, Guinea, the Cape of Good Hope and Ceylon.² Up till this time all missionary enterprises had been more or less connected with the state. The era of modern missions, based on associate organizations, begins with William Carey (*q.v.*), and is closely connected with the great evangelical revival of the latter part of the 18th century. That revival had intensified the idea of the worth of the individual soul, whether Christian or heathen, and "to snatch even one brand from the burning" became a dominant impulse. In 1792, Carey, a Baptist, who was not only a cobbler, but a linguist of the highest order, a botanist and zoologist, published his *Enquiry into the Obligations of Christians to use Means for the Conversion of the Heathens*, and the book marks a distinct point of departure in the history of Christianity. Under its influence twelve ministers at Kettering in October 1792 organized the Baptist Society for Propagating the Gospel among the Heathen, and subscribed £13, 2s. 6d. In June 1793 Carey was on his way to India. Letters from him quickened interest outside his own communion, and in the autumn of 1794 a meeting of Evangelical ministers of all denominations resolved to appeal to their churches, especially with a view to work being started in the South Sea Islands. The chief movers in the enterprise were the Congregationalist, David Bogue of Gosport, and the Episcopalian, Thomas Haweis, rector of Aldwinkle, Northamptonshire. With them were associated Wesleyan and Presbyterian divines, and in September 1795 the London Missionary Society, emphasizing no one form of church government, was formed. £10,000 was subscribed by June 1796, and in August 20 missionaries sailed for Tahiti. Societies formed in Glasgow and Edinburgh in the spring of the same year gave their attention to the continent of Africa.

The need of this continent was also the means of creating the distinctively Anglican organization known as the Church Missionary Society. The evangelical movement had produced philanthropists like Wilberforce and Granville Sharp, and the Eclectic Society, a group of clergy and laymen who fell to discussing the new missionary movements. In April 1790, under the guidance of John Venn and Thomas Scott, was established the Church Missionary Society, originally known as the "Society for Missions to Africa and the East." Its promoters declared their intention of maintaining cordial relations with nonconformist

¹ Neale, *History of New England*, i. 260; Burnet, *History of his own Times*, i. 132 ("Everyman's Library" ed., p. 27).

² J. B. Holmes, *Hist. Sketches of the Missions of the United Brethren*, p. 3; A. Grant, *Bampton Lectures* (1843), p. 190.

missionary societies, and this has largely been done, the older Society for the Propagation of the Gospel, manned by "High" Churchmen, standing more aloof. In 1814 the Wesleyan Missionary Society was formed, Methodist effort of this kind having previously been left to the individual enterprise of Dr Thomas Coke. Thus shorn of two chief bodies of supporters, and Presbyterians in England being then comparatively few, the London Missionary Society became in effect a Congregationalist organization, though it has never departed from the broad spirit of its founders. In Scotland Robert Haldane sold his estate and devoted £25,000 to the cause; with others he would have gone to India himself but for the prohibition of the East India Company, one of whose directors said he would rather see a band of devils in India than a band of missionaries. What Carey did for England was largely done for Scotland by Alexander Duff, who settled in Calcutta in 1830, and was a pioneer of higher education in India. On the Continent the Basel Mission (1815) grew out of a society founded in 1780 to discuss the general condition of Christianity; "Father" Jänicke, a Bohemian preacher in Berlin, founded a training school which supplied many men to the Church Missionary Society and the London Missionary Society; and Van der Kemp, who pioneered the London Missionary Society work in South Africa, organized in 1797 the Netherland Missionary Society, which turned its attention chiefly to Dutch Colonial possessions.

In America as in England the sense of individual responsibility had been developed. In 1796 and 1797 respectively the New York and the Northern societies were formed for work among Indians by Presbyterians, Baptists and Reformed Dutch, acting in concert. News of the London Society stimulated interest in New England, and in 1806 Andover Seminary was founded as a missionary training college. In the same year Samuel J. Mills, Gordon Hall and James Richards, three students at Williams College, Massachusetts, formed themselves into a mission band which ultimately became the American Board of Commissioners for Foreign Missions (June 1810), an organization which, like the London Mission, originally undenominational and still catholic, has become practically Congregational. The first offshoot from it was the American Baptist Missionary Union in 1814.

The following chronological lists illustrate the growth of missionary societies in Britain and the United States:—

Great Britain and Ireland.

1691. Christian Faith Society for the West Indies.
1698. Society for Promoting Christian Knowledge.
1701. Society for the Propagation of the Gospel in Foreign Parts.
1703. Moravian Mission.
1702. Baptist Missionary Society.
1795. London Missionary Society.
1796. Scottish Missionary Society.
1799. Church Missionary Society.
1799. Religious Tract Society.
1804. British and Foreign Bible Society.
1808. London Society for Promoting Christianity among the Jews.
1813. Wesleyan Missionary Society.
1817. General Baptist Missionary Society.
1823. Colonial and Continental Church Society.
1825. Church of Scotland Mission Boards.
- National Bible Society of Scotland.
1831. Trinitarian Bible Society.
1832. Wesleyan Ladies' Auxiliary for Female Education in Foreign Countries.
1835. United Secession (afterwards United Presbyterian) Foreign Missions.
1836. Colonial Missionary Society.
1840. Irish Presbyterian Missionary Society.
1841. Welsh Calvinistic Methodist Missionary Society.
1841. Colonial Bishops Fund.
1841. Edinburgh Medical Missionary Society.
1843. British Society for the Propagation of the Gospel among the Jews.
1843. Free Church of Scotland Missions.
1843. Primitive Methodist African and Colonial Missions.
- Methodist New Connexion in England Foreign Missions.
1844. South American Missionary Society.
1847. Presbyterian Church in England Foreign Missions.
1858. Christian Vernacular Education Society for India.
1860. Central African Mission of the English Universities.
1862. China Inland Mission.

1865. Friends' Foreign Mission Association.
1866. Delhi Female Medical Mission.
1867. Friends' Mission in Syria and Palestine.
1876. Cambridge Mission to Delhi.
1880. Church of England Zenana Missionary Society.
1884. Presbyterian Mission to Korea.
1892. Student Volunteer Missionary Union.
- United States of America.
1733. Corporation for the Propagation of the Gospel in New England.
1797. Society for Propagating the Gospel among the Indians at Boston.
1795. Friends' Missionary Society.
1800. New York Missionary Society.
- Connecticut Missionary Society for Indians.
1803. United States Mission to the Cherokees.
1806. Western Missionary Society for Indians.
1810. Board of Commissioners for Foreign Missions.
1814. Baptist Missionary Union.
1819. Methodist Episcopal Church Missionary Society.
1833. Free-will Baptist Foreign Missionary Society in India.
1835. Foreign Missions of the Protestant Episcopal Church.
1837. Board of Foreign Missions of the Presbyterian Church (North).
1837. Evangelical Lutheran Foreign Missionary Society.
1842. Seventh Day Baptist Missionary Society.
- Strict Baptist Missionary Society.
1843. Baptist Free Missionary Society.
1845. Methodist Episcopal Church (South).
1845. Southern Baptist Convention.
1846. American Missionary Association.
1857. Board of Foreign Missions of (Dutch) Reformed Church.
1859. Board of Foreign Missions of United Presbyterian Church.
1862. Board of Foreign Missions of the Presbyterian Church (South).
1878. Evangelical Association Missionary Society.
1886. Student Volunteer Missionary Union.

It is not possible to follow in detail the history of the hundred or more organized societies of some size that have thus come into being since the end of the 18th century, still less that of the three or four hundred smaller agencies.¹ It may be noted, however, that the enterprise has followed certain more or less clearly defined lines. These are described as follows by Dr E. M. Bliss, editor of the *Encyclopedia of Missions*.

1. *The Denominational*.—The course of denominational work may be seen in the way in which the London Society and the American Board were gradually left to the Congregationalists, it being recognized that while fraternity was maintained, the widest results could only be obtained as appeal was made directly to the members of each separate denomination. To some extent a similar development is traceable in other lands. In Germany the Rhenish Society (1825) became independent of the Basel Mission, but like it and the Berlin Society founded by Neander and Thuluck has preserved a broad basis and includes both Lutheran and Reformed constituents. The North German or Bremen Society split into a strict Lutheran or Leipzig agency and the Hermannsburg Mission, which aimed at a more primitive and apostolic method. In Denmark, the Danish Missionary Society, founded by Pastor Bone Falck Ronne in 1821, worked through the Moravian and Basel societies until 1862, when it began independent work and concentrated on the Tamil population of South India. In Norway and Sweden missionary activity kept pace with the development of the national life; in the former country the Free Church, in the latter the State Church has been the most successful agency.

In Holland a religious revival in 1846 led to the foundation of several organizations which supplemented the work of the original Netherland Missionary Society. In France protestant missionary effort began after the overthrow of the empire, and in 1822 several isolated committees united to form the Société des Missions Évangéliques, better known as the Paris Evangelical Society. In Tahiti, Madagascar and other fields this society has largely taken over work begun by the London Society, whose operations were viewed with suspicion by the French government.

2. *Collateral Aid*.—Side by side with the founding of the great missionary societies, Bible and Tract societies sprang up. The dates are significant: Society for Promoting Christian Knowledge (1698), Religious Tract and Book Society of Scotland (1793), Religious Tract Society in London (1799), British and Foreign Bible Society (1804), American Bible Society (1816), American Tract Society (1823). (See further BIBLE SOCIETIES.) Medical Missions have not been so good collateral organizations as departments of the work of the general societies, and the same is generally true of women's missions. Both of these will be discussed in more detail.

3. *Independent and Special Agencies*.—The individual element that was so marked a feature in Carey's generation has never vanished, in spite of the tendency to central control. J. Hudson Taylor in 1853 went to China as the agent of a number of folk in England who feared that missionary work was becoming too mechanical. His aim was to push inland and to work through native evangelists. Out of his endeavours sprang a new organization, the China Inland

¹ For complete directory see *Statistical Atlas of Foreign Missions* (1910).

Mission; and similar undenominational societies, e.g. the Regions Beyond Missionary Union in England, and the Christian and Missionary Alliance in America, have since been founded. Other individual enterprises have been launched by persons or single churches, but such have not usually flourished for any length of time, their workers gradually attaching themselves to the larger associations.

Protestant Missions.—It is generally agreed that the period since 1885 has witnessed a very marked increase of missionary zeal and interest in Great Britain, both in the Church of England and among the Nonconformists. The improvement, indeed, dates back somewhat earlier. So far as the Church of England is concerned it may fairly be said to have started afresh in the year following the first observance of the Day of Intercession for Missions, on the 20th of December 1872. Both the Society for the Propagation of the Gospel and the Church Missionary Society were at that time suffering from a general coldness which, in the case of the latter society, had led in that very year to the committee reporting "a failing treasury and a scanty supply of men." The observance of that first Day of Intercession was followed by an immediate change, and unquestionably there has been progress ever since. Then, less than five months afterwards, David Livingstone died at Ilala; and no event of the whole century did so much to wake up Protestant Christendom. Most of the missions in Central Africa owe their origin to the spirit it aroused. But the year 1884 was also an epoch to be marked. In that year Bishop Hannington went to Africa; and his murder in 1885 (first reported in England on New Year's Day, 1886) deeply touched the Christian conscience. The speedy publication of E. C. Dawson's biography of him worked a revolution in the circulation of missionary literature. Another event of 1884-1885 was the going forth to China of "The Cambridge Seven," in connexion with the China Inland Mission. All were men of good family; some of them went at their own charges; and among them were the stroke-oar of the University Eight (Mr Stanley Smith) and the captain of the University Eleven (Mr C. T. Studd). Probably no event of recent years has exercised a wider influence in the cause of missions. In particular, university graduates have since then gone out as missionaries in much larger numbers than before. There are now five missions definitely linked with the universities. The Central African Mission (1858), indeed, is not for the most part manned by graduates, though it is led by them; but the Cambridge Mission at Delhi (1878), the Oxford Mission at Calcutta (1880), and the Dublin Missions in Chota Nagpur (Society for the Propagation of the Gospel, 1891) and the Fuh-Kien Province of China (Church Missionary Society, 1887) consist of university men. Moreover, the older and larger societies have much increased the proportion of graduates on their staffs.

The cause of missions in the universities has been fostered greatly by the Student Volunteer Missionary Movement, initiated in America in 1886, and organized in England in 1892. The Union has over 3000 members (of whom 1400 have gone to the field), and has adopted as its watchword, "The Evangelization of the World in this Generation"; and this motto has been approved by several bishops and other Christian leaders. Another influence upon university men and others who have taken holy orders is that of the Younger Clergy Union of the Church Missionary Society (1885) and the Junior Clergy Association of the Society for the Propagation of the Gospel (1891). At the same time there has been a great accession of men to the missionary ranks from among other classes of society. The Anglican societies and the regular and older Nonconformist societies (Methodist, Baptist, Presbyterian and the London Missionary Society, which is virtually Congregationalist) have shared in these humbler recruits; but a large proportion of them have joined several younger "non-denominational" or "inter-denominational" missions. Of these the China Inland Mission is the largest and most influential; and while it has sent forth many of this class, it has also enrolled not a few men and women of considerable wealth, education and social status. The South Africa General Mission, the North Africa Mission, and the Congo Balolo Mission come next in importance; but there are several

smaller bodies working in different countries. The Salvation Army also has missions in India, Ceylon and Japan; but these cannot be called "non-denominational," because the Army has gradually become a very strict denomination itself. There is one Anglican society working, like some of those just mentioned, in one particular field, viz. the South American Missionary Society, founded in 1844. Many foreign dioceses also have associations in England for their help and support. Medical men have come forward in increasing numbers for missionary service, and medical missions are now regarded as a very important branch of the work of evangelization. They are especially valuable in Mahomedan countries, where open preaching is difficult and sometimes impossible, and also in works of mercy among barbarous tribes; while in China, which comes under neither of these two categories, they have been largely developed. There are 980 doctors (most of them fully qualified) labouring in British and American missions; and in 1910 it was calculated that the in-patients in mission hospitals exceeded 160,000, while the visits of out-patients in a year were about 5,000,000. In several of the great London hospitals there are missionary associations, the members of which are medical students; but a chief source of supply in the past has been the Edinburgh Medical Mission, founded in 1841, which, while working among the poor in that city, has trained many young doctors for missionary service.

The most remarkable development of missionary enterprise has been the employment of women. From an early date many of the wives of missionaries have done good service; but the going forth of single women in any appreciable number has only been encouraged by the societies in the last quarter of the 19th century. The Society for Promoting Female Education in the East (now absorbed by others, chiefly by the Church Missionary Society) was founded in 1834; the Scottish Ladies' Association for the Advancement of Female Education in India (which subsequently became two associations, for more general work, in connexion with the Established and Free Churches of Scotland respectively) in 1837; the Indian Female Normal School Society (now the Zenana Bible and Medical Mission) in 1861 (taking over an association dating from 1854); the Wesleyan Ladies' Auxiliary in 1859; the Women's Association of the Society for the Propagation of the Gospel, and the Baptist Zenana Mission, in 1867; The London Society's Female Branch, in 1875; the Church of England Zenana Society (an offshoot from the Indian Female Society) in 1880. But the earlier of these organizations only contemplated employing women for educational work on a very small scale. Out of it grew the visitation of Indian zenanas. The employment of women in general evangelistic work, such as village itineration, house-to-house visiting in towns, classes for female inquirers, training of native female workers, &c., although recent, has rapidly extended. The Church Missionary Society, besides relying on the above-named Zenana Bible and Medical Mission and Church of England Zenana Missionary Society for women's work at several of its stations in India and China, sent out 500 single women in the fifteen years ending 1900; and the non-denominational missions above referred to have (including wives) more women than men engaged in their work—especially the China Inland Mission, which has sent out several hundreds to China. Women's work and medical work are combined in the persons of nearly 300 fully-qualified lady doctors in various missions. Although nearly half the male missionaries (Protestant) are unmarried, these are exceeded in number by the unmarried women; and consequently, the husbands and wives being equal, the aggregate of women in the Missions is greater than the aggregate of men.

The home organization of missions is a subject that has been much considered. The bulk of the work has been done by voluntary societies, membership in which depends upon a pecuniary subscription, and the administration of which is entrusted to elected committees. These committees comprise not only real experts, such as retired veteran missionaries, and retired civil and military officers who have been active friends of missions while on foreign service, but also leading clergymen and laymen

who, though not personally acquainted with the mission fields, become almost equal experts by continuous attendance and careful study. In the case of the two leading Church of England societies, the bishops (being members) are *ex officio* on all executive committees; but their labours in other directions prevent their ordinarily attending. The numerous non-denominational missions previously referred to are differently worked. There is no membership by subscription, nor any elected committee. The "mission" consists of the missionaries themselves, and they are governed by a "director," with possibly small advisory councils in the field and at home, the latter undertaking the duty of engaging missionaries and raising funds.

On the other hand, there is a growing sense that missions should be the work of the Church in its corporate capacity, and not of voluntary associations. This is the system of the Presbyterian Churches, the missions of which are entirely controlled by the General Assemblies in Edinburgh, Belfast and London respectively. The Wesleyan Society also is under the authority of the Conference. In the Church of England the question was broached in Convocation, shortly after the revival of that body, in 1859; and during the next few years many suggestions were put forth for the establishment of a Board of Missions which should absorb the societies, or at least direct their work. It soon appeared, however, that neither the Society for the Propagation of the Gospel nor the Church Missionary Society was willing to be absorbed; and it was urged by some that in a great comprehensive national Church, comprising persons of widely different views, more zeal was likely to be thrown into voluntary than into official enterprises. Eventually, in 1887, the Canterbury Convocation and Archbishop Benson formed a Board of Missions; and York followed shortly afterwards. These boards, however, were not to supersede the societies, but to supplement their work, by collecting information, fostering interest, registering results and acting as referees when required. They have already done some useful work, and will probably do more. Their most active members are men who are also leaders in their respective societies, and have thus gained experience in missionary administration. But the Church of England has not yet put missions in the prominent place they occupy in the Nonconformist denominations.

The closing years of the 19th century were remarkable for the centenary commemorations of the older missionary societies. The Baptist Society celebrated its centenary in 1892; the London Missionary Society (Congregational) did the same in 1895; the Society for Promoting Christian Knowledge kept its bicentenary in 1898; the Church Missionary Society its centenary in 1899; the Society for the Propagation of the Gospel its bicentenary in 1900-1901; and the British and Foreign Bible Society its centenary in 1904. Considerable special funds have been raised in connexion with these commemorations. A good deal of interest has also been awakened and maintained by missionary exhibitions, and by a more intelligent type of missionary literature.

Colonial missions next claim attention. By "colonial" is meant, not missions to the British colonial population, but missions from the colonial population to the heathen.

2. Colonial. The former have been very largely the work of the Society for the Propagation of the Gospel, and, in a smaller degree, of the Colonial Church Society (Church of England) and the Colonial Missionary Society (Congregational). Those missions, however, are more properly an outlying branch of home missions, being to the professing Christian settlers or their descendants. But these Christian settlers have their own missions to the heathen—both to the heathen at their doors and to the great heathen lands beyond.

In Canada and Australia, the Anglican, Presbyterian, Methodist, Baptist and other communities have regular organizations for foreign missions. The non-episcopal missions thus formed and supported are worked quite independently of the home societies of the denominations respectively. The Australian Presbyterians have important agencies in the South Seas and in Korea, the Australian Baptists in Bengal, the Canadians of

various denominations in the Far North-West of the Dominion, and in India and China. The Anglican Church in Canada has its Domestic and Foreign Missionary Society, working in the North-West and in Japan; and in Australia it has a Board of Missions, working amongst the Australian aborigines and in New Guinea. The Melanesian Mission, associated with the names of Selwyn and Patteson, is officially connected with the Church of New Zealand, but is also largely supported in Australia. In New South Wales, Victoria, New Zealand and Canada there are also Church missionary associations which supply missionaries, and support them, for the mission fields of the Church Missionary Society.

The German societies are numerous and important, and have increased in number and in vigorous work. The *Moravian Church*, whose missions are the oldest (1733), is itself a missionary organization in a sense in which no other Christian community rivals it. Its total membership is under 100,000, and it has some 350 missionaries, labouring in the most unpromising fields—Greenland, Labrador, Alaska, Central America, Tibet, and among the Hottentots. The *Basel Society*, with its famous seminary at Basel, which formerly supplied many able German missionaries to the Church Missionary Society, has extensive work in India, West Africa and South China. The *Berlin Society* and the *Rhenish Society* labour in South Africa and China, the *Hermannsburg Mission* (Hanover) in South Africa and India; *Gossner's Mission* (Berlin) and the *Leipzig Lutherans* in India. At least two of these societies, and other new associations formed for the purpose, and the Moravians, have taken up work in German East Africa. The principal organizations in Holland are the Netherlands Missionary Society and the Utrecht Missionary Society, working mainly in the Dutch colonies. A Danish society has a mission in South India. The old *Swedish* and *Norwegian* missionary societies work in South Africa, Madagascar and India; but large numbers of Scandinavians have been stirred up in missionary zeal, and have gone out to China in connexion with the China Inland Mission; several were massacred in the Boxer outbreaks. The French Protestants support the *Société des Missions Évangéliques*, founded in 1822. Its chief mission has been in Basutoland, since extended to the Zambesi; but it has also followed French colonial extension, establishing missions in Senegambia, the French Congo, Madagascar and Tahiti.

The newer American organizations are, as in England, non-denominational and "free-lance," especially the Christian and Missionary Alliance (1897), developed from the *American International Missionary Alliance* (1887), which has sent many missionaries to India and China. The older societies attribute to these new agencies more zeal than discretion, while the newer credit the older with a discretion that cripples zeal. The Student Volunteer Movement, already referred to, has had large influence in the United States, where it arose; and its leaders have proved themselves men of rare intellectual and practical capacity. In a journey round the world in 1895-1897, J. R. Mott succeeded in forming students' associations in universities and colleges in several European countries, as well as in Turkey in Asia, Syria, India, Ceylon, China, Japan and Australia; and all these associations, over 150 in number, are now linked together in a great International Student Federation. The older American societies, especially the American Board (Congregational), the Presbyterian Boards, the Methodist Episcopal Church Society, the Baptist Missionary Union, and the Missionary Society of the Protestant Episcopal Church, have much extended their work. The "Ecumenical Missionary Conference," held at New York in April 1900, was an astonishing revelation to the American public of the greatness of missions generally and of the missions of their own churches in particular. The Laymen's Missionary movement is a significant outcome of the interest then awakened.

Missions to the Jews are worked by distinct organizations. There are several societies in England, Scotland, Germany and America. No special development has to be reported, except the great extension of John Wilkinson's *Mildmay Mission* to

J. Continental.

A. American.

the Jews, and its energy in the free distribution of Hebrew New Testaments. Converted Jews are commonly supposed to be very few, and in numbers they do not compare with converted heathen; but they are more numerous than is usually imagined, especially if the second and third generations of Christians of Hebrew race are included. A number of them find in Unitarianism a form of Christianity that appeals to them. It is estimated that 250 Anglican clergymen are converted Jews or the sons of converted Jews. The London Society for Promoting Christianity among the Jews includes among its missionaries about 80 who are converts. Professor Delitzsch estimated that 100,000 Jews had embraced Christianity in the first three quarters of the 19th century; and Dr Dalman of Leipzig says that "if all those who have entered the Church and their descendants had remained together, instead of losing themselves among the other peoples, there would now be a believing Israel to be counted by millions, and no one would have ventured to speak of the uselessness of preaching the Gospel to the Jews."

Interesting as is the story of Protestant mission work in Austria, Spain, Italy and Russia, it does not fall within the scope of this article. Nor do the proselytizing enterprises of Seventh Day Adventists, Christian Scientists, Mormons and other American bodies rightly find a place here.

Roman Catholic Missions.—At the beginning of the 19th century the Roman Communion seems to have shared to some extent in the torpor and stagnation as regards missions that characterized the Protestant churches. There was little of the zeal which had carried the Franciscans all over Asia in the 13th century, and the Jesuits to South America, India and Japan in the 16th. But the 19th century witnessed a great change, and Roman Catholic missions have been extended *pari passu* with Protestant. The revival was not a little due to the foundation in 1822, by a few earnest but (as they called themselves) "humble and obscure" Catholics at Lyons, of a new voluntary society, called the Institution for the Propagation of the Faith. It collected in its first year about £2000 from the shopkeepers and artisans of Lyons. Thirty years later its income was £200,000 a year; and now it is £300,000. It has sent out no missionaries of its own. It merely makes grants to the various missionary parties sent forth, and it has done much in this direction. Roman missions are carried on both by missionary societies and by religious orders, all under the supreme direction of the pope, and also more or less under the general supervision of the *Sacra Congregatio de Propaganda Fide* at Rome since its foundation by Gregory XV. in 1622. This important congregation has been described as corresponding pretty much in the Catholic Church to the colonial office in the British empire, and its head, the "Prefect of Propaganda," to the secretary of state for the colonies. It holds supreme control over all the foreign missions in heathen countries, and also over large and important parts of the church in Christian countries whose governments are not Catholic—including the British empire, the United States, Holland, the Norse kingdoms, Greece, and some parts of Germany and Switzerland. A special section (erected by Pius IX.) has charge of the affairs of all the Oriental rites in union with the Roman see. Confining our attention at present to the missions strictly understood under "foreign," i.e. to heathen or non-Christian countries, we shall find the whole of these parts of the globe carefully mapped and parcelled out by propaganda to a variety of missionary agencies or religious orders. The government of the various mission fields is generally carried on by "Vicars-Apostolic" (i.e. titular bishops acting as vicars or delegates of the Apostolic see) or "Prefects-Apostolic" (i.e. priests with similar powers, but without episcopal rank). In some few cases (notably India and Japan) a regular territorial hierarchy has been established, just as in the United Kingdom and the Netherlands. Of the religious societies engaged in the evangelization of these many fields of labour, some have been established exclusively for foreign missionary work among the heathen—notably the famous *Société des Missions Étrangères de Paris*, the oldest and greatest of all (dating from 1658, and consisting of 34 bishops,

1200 European missionaries and 700 native priests); the German "Society of the Divine Word," whose headquarters are at Steyl in Holland; the Belgian Society of Scheat; the celebrated French Society of the "White Fathers," founded by the late Cardinal Lavigerie for African missions; the English Society of St Joseph, founded at Mill Hill by Cardinal Vaughan; and some others. The other missions are entrusted to the care of various religious orders and congregations, which take up foreign missionary work in addition to their labours in Christian countries. Such are the Franciscans, Dominicans, Jesuits, Lazarists, Augustinians, Marists, &c. Besides the above orders of priests, an immense number of religious societies of women are engaged in works of education and charity throughout the whole of the foreign mission field. These have been reckoned at about 42,000 European and 10,000 native sisters. Again, there are some 20 congregations of "Brothers" (not priests) engaged in teaching, and numbering some 4500 members.

By far the greater part of the Roman missionary work is done by France. The majority of the missionaries are French (over 7000); the bulk of the money—so far as it is voluntary contribution (but the propaganda at Rome has large endowments)—is raised in France. The French government, antipathetic as it is at home, is the watchful and strenuous protector of the missions abroad; and it is evident that not a little political influence in foreign countries is gained thereby. *L'Année de l'Église*, in reporting on the missions in all parts of the world, dwells continually on this with satisfaction. Protestant missionaries are opposed, not merely because they are heretical, but because they are English or (if American) English-speaking; and the Greek Church missionaries in Persia and Japan, not only because they are schismatic, but because they are Russian—the Franco-Russian alliance notwithstanding. This is a feature in French Catholic missions which cannot be overlooked in the briefest account of them.

The following list shows the principal foreign Roman Catholic missionary societies and their fields of work:—

- I. *Société des Missions Étrangères* (Paris, 1658).—*Missions*: Manchuria, Korea, Tibet, Japan, China. (Sze-Chuen, Kwei-Chow, Kwang-tong, Yunnan), Indo-China (W. S. and Upper Tongking, E. W. and N. Cochinchina); Cambodia, Siam, Malay Peninsula, Burma (S. and N.), S. India (dioceses of Pondicherry, Kombackanam, Mysore, Coimbatore).
- II. *Society of "White Fathers"* (founded by Cardinal Lavigerie, 1868).—*Missions*: Algeria, Sahara, Nyasa, Victoria Nyanza, Tanganyika, Unyanymbe, Upper Congo.
- III. *Lyons Seminary for Foreign Missions* (1856).—*Missions*: Nile Delta, Benin, Ivory Coast, Gold Coast, Dahomey, Upper Niger.
- IV. *Congregation of the Holy Ghost* (1703 and 1848).—*Missions*: Senegambia, Gambia, Sierra Leone, Lower Niger, Gaboon, French Congo, Lower Congo, Mayotte, Nossibé and Comoro Islands.
- V. *Milan Seminary for Foreign Missions* (1850).—*Missions*: China (Hong Kong, N. and S. Ho-nan), East Burma, India (dioceses of Kishnagar and Haidarabad).
- VI. *Steyl Society for Foreign Missions* (German, 1875).—*Missions*: S. Shan-tung, China; Togo, W. Africa.
- VII. *Scheat Society of Foreign Missions* (Belgian, 1863).—*Missions*: Mongolia, Kang-Su (China), Belgian Congo.
- VIII. *Picpus Society* (Paris, 1817).—*Missions*: Hawaii, Tahiti, Marquesas Islands.
- IX. *Mill Hill Society* (English, 1866).—*Missions*: N. Borneo and Labuan; N. Punjab, Kashmir and Ladak; Telugu missions of Madras; Maori missions of N. New Zealand; N. Uganda.
- X. *Congregation of the Sacred Heart* (Issoudun, France, 1855).—*Missions*: New Guinea, New Pomerania, Gilbert Islands.
- XI. *Society of the Divine Saviour* (Rome, 1881).—*Mission*: Assam.
- XII. *Verona Society for African Missions*.—*Mission*: The Sudan, Upper Egypt.

The following societies are engaged in home as well as foreign missions:—

- XIII. *Marists* (French, 1816).—*Missions*: Fiji, Navigator's Island, New Caledonia, Central Oceania, Solomon Islands, parts of New Zealand (dioceses of Wellington and Christchurch).

¹ Father Damien belonged to this society, which takes its popular name from the Rue de Picpus, Paris.

- XIV. *Lazarists* (founded by St Vincent de Paul, 17th century).—*Missions*: Abyssinia, Persia, China (Peking or N. Chih-li, S.-W. Chih-li, Kiang-si, Che-Kiang, S. Madagascar).
- XV. *Oblates of Mary Immaculate* (1840).—*Missions*: Ceylon (nearly all), S. Africa (Basutoland, Natal, Transvaal, Orange River Colony), the "Great North-West" of Canada (Athabasca-Mackenzie, Saskatchewan, St Boniface, New Westminster).
- XVI. *Salesians* (founded by Don Bosco).—*Missions*: Patagonia and Tierra del Fuego, Falkland Islands, Indians of S. America (Ecuador, Brazil, Argentine); some missions in Palestine.
- XVII. *Pallottines*.—*Missions*: Cameroon, W. Africa; Australia (Beagle Bay, native settlement).
- XVIII. *Jesuits*.—*Missions*: India (dioceses of Bombay, Poona, Calcutta, Madura, Mangalore, Trichinopoly), Ceylon (dioceses of Galle and Trincomalee), China (Kiang-nan, S.-E. Chih-li), Madagascar, Koango (W. Africa), Zambezia, Jamaica, British Guiana, British Honduras, Alaska.
- XIX. *Dominicans*.—*Missions*: Asiatic Turkey (Mosul), Tongking (N., E. and Central), China (Amoy, Fokien), Curaçao, Trinidad.
- XX. *Franciscans*.—*Missions*: Egypt, Tripoli, Morocco, China (N. and S. Shan-si, N. and E. Shan-tung, N. Shen-si, E., N.-W. and S.-W. Hu-pe). *Capuchins*: Aden and Arabia, India (dioceses of Agra, Allahabad, Lahore), Seychelles, Eritrea (Red Sea), Gallas, Cephalonia, Trebizond, Mardin, Crete, Caroline Islands, Arucania, Brazil, Bulgaria. *Conventuals*: Jassy (Rumania).
- XXI. *Benedictines*.—*Mission*: Ceylon (diocese of Kandy), New Zealand (diocese of Auckland), N. American Indians (Indian Territory and Oklahoma), Australian natives (New Nersia).
- XXII. *Trappists*.—*Missions*: Settlements in Natal (Marianhill), West Africa (Congo), China, Japan.
- XXIII. *Augustinians*.—*Missions*: Philippines, China (N. Hu-nan), Balkan Peninsula, Asia Minor ("Assumptionists" V).
- XXIV. *Carmelites*.—*Missions*: Bagdad, India (dioceses of Verapoly and Quilon).
- XXV. *Redemptorists*.—*Missions*: Dutch Guiana.
- XXVI. *Passions*.—*Mission*: Bulgaria (diocese of Nicopolis).

These missions are largely supported by the Society of the Propagation of the Faith (est. in Lyons, 1822), Society of the Holy Childhood (est. 1843 as auxiliary to the former; "children for children") and Society of the Schools of the East (est. 1855).

On figures given in H. A. Krose's *Katholische Missionsstatistik* (1908), the following totals of Roman Catholic Missions amongst non-Christians have been compiled: European priests, 7933; native priests, 5837; lay brothers, 5270; sisters, 21,320; catechists, 24,524; native membership, 7,441,215; catechumens, 1,517,909. The annual baptisms of adult heathen are 100,000; those of heathen children at the point of death, 450,000. Over 840,000 children are in lower schools, 66,000 in middle schools, and 90,000 in orphanages. The total number of schools is 24,000, of churches and chapels 28,000, and of mission stations 43,000.

Note.—Where figures for 1910 are quoted in this article they are really those of two or three years earlier, collected for the World Conference of 1910.

Orthodox Eastern Church.—When the tsar Ivan the Terrible (1533-1584) began the great advance of Russia into Northern Asia, a large number of missionaries accompanied the troops, and during the 17th century many thousands of Tatars were baptized, though from lack of fostering influences they lapsed into heathenism. Very little was done until 1824, when John Veniaminov (d. 1879), a priest of Irkutsk, afterwards Archbishop Innocent, began a career of evangelistic activity which has few parallels. He founded missions in Alaska and the Aleutian Islands, Kamtchatka and throughout Eastern Siberia, and established the Orthodox Missionary Society at Moscow. In Altai (Central Siberia) the Archimandrite Macarius, and among the Tatars in south-east Russia with headquarters at Kazan the great linguist Iminski, did similar work. In addition to the nine distinct missions (300 workers) in Siberia and the six (with 50 workers) in European Russia, the Orthodox Church (Russian) has three foreign missions: (1) in China, founded at Peking 1714, in the face of Jesuit opposition; (2) in Japan, established about 1863 by Bishop Nicolai, a chaplain at Nagasaki; (3) in Alaska and the Aleutian Islands, the bishop residing

at San Francisco and having jurisdiction also over members of the church settled in the United States of America. Altogether the Russian Church spends over £30,000 annually on these missions, and works with the British and Foreign Bible Society in translating and distributing the Scriptures. In Japan the mission has become a practically independent branch of the Church.

HISTORY OF MISSION FIELDS

The continuity of missionary enthusiasm maintained through the primitive, the medieval, and the modern periods of the Church's history, operating at every critical epoch, and surviving after periods of stagnation and depression, is a very significant fact. It is true that other religions have been called missionary religions, and that one of them long held first place in the religious census of mankind. The missionary activity of Buddhism is a thing of the past, and no characteristic rite distinguishing it has found its way into a second continent. Mahomedanism indeed is active, and is the chief opponent of Christianity to-day, but the character of its teaching is too exact a reflection of the race, time, place and climate in which it arose to admit of its becoming universal. It is difficult to trace the slightest probability of its harmonizing with the intellectual, social and moral progress of the modern world. With all its deficiencies, the Christian church has gained the "nations of the future," and whereas in the 3rd century the proportion of Christians to the whole human race was only that of one in a hundred and fifty, this has now been exchanged for one in three, and it is indisputable that the progress of the human race at this moment is identified with the spread of the influence of the nations of Christendom.

Side by side with this continuity of missionary zeal, a noticeable feature is the immense influence of individual energy and the subduing force of personal character. Around individuals penetrated with Christian zeal and self-denial has centred not merely the life, but the very existence of primitive, medieval and modern missions. What Ufilias was to the Gothic tribes, what Columba and his disciples were to the early Celtic missions, what Augustine or Aidan was to the British Isles, what Boniface was to the churches of Germany and Anskar to those of Denmark and Sweden, that, on the discovery of a new world of missionary enterprise, was Xavier to India, Hans Egede to Greenland, Eliot to the Red Indians, Martyn to the church of Cawnpore, Marsden to the Maoris, Carey, Heber, Wilson, Duff and Edwin Lewis to India, Morrison, Gilmour, Legge, Hill, Griffith John to China, Gray, Livingstone, Mackenzie, Moffat, Hannington, Mackay to Africa, Broughton to Australia, Patteson to Melanesia, Crowther to the Niger Territory, Chalmers to New Guinea, Brown to Fiji.² At the most critical epochs such men have ever been raised up, and the reflex influence of their lives and self-denial has told upon the Church at home, while apart from their influence the entire history of important portions of the world's surface would have been altered.

If from the agents themselves we turn to the work that has been accomplished, it will not be disputed that the success of missions has been marked amongst rude and aboriginal tribes. What was true in the early missions has been found true in these latter times. The rude and barbarous northern peoples seemed to fall like "full ripe fruit before the first breath of the gospel." The Goths and the Vandals who poured down upon the Roman Empire were evangelized so silently and rapidly that only a fact here and there relating to their conversion has been preserved. This is exactly analogous to modern experience in the South Seas, Asia and Africa, to a survey of which we now turn.

The South Seas.—Missionary work in the Pacific began with Magellan (1521), when in a fortnight he converted all the inhabitants of Cebú and the adjacent Philippine Islands! The Jesuits, Recollets and Augustinians also worked in Mariana, Pelews and Caroline Islands, though the two latter were soon abandoned. The beginning of modern effort was made by the London Missionary Society in 1797.

¹ See E. Smirnof, *Russian Orthodox Missions*; an article in *The East and the West* (April, 1904); and the *Statistical Atlas* (1910); p. 99.

² E. Stock's *Short Handbook of Missions* has a chapter on "Some Notable Missionaries" and another on "Some Prominent Native Christians."

Australia and New Zealand.—The earliest attempt to evangelize the aborigines of Australia by a separate mission was that of the Church Missionary Society in 1825. This work centred at Wellington Valley and Moreton Bay, but was given up in 1842. A new beginning was made in 1850 by the Anglican Board of Missions for Australia and Tasmania, and now each diocese is responsible for its own area. At Bellenden Ker, near Cairns, in North Queensland (diocese of Carpentaria), many natives have settled upon a reserve granted by government to the Anglican Church, and at another reserve, Fraser Island, the diocese of Brisbane has also undertaken successful work. Nomadic aborigines have hardly been touched. Apart from Queensland most of the black population is in West Australia; here the Roman Catholic Church is the main evangelizing agency. In the north and central districts the German missions have been active. Both in Australia (especially in Sydney and Melbourne) and at Thursday Island there is work among the Chinese.

In Tasmania the aborigines are extinct, the last pure-blooded native dying in 1876. The half-castes settled in the Bass Straits are ministered to by the bishop of Tasmania. The Maoris of New Zealand first came under Christian influence through the efforts of Samuel Marsden, a colonial chaplain in New South Wales about 1808. In 1822 Wesleyan missionaries reached the island. The first baptism was in 1825 but during the next five years there was a great mass movement. In 1840 the country became a British colony, and soon afterwards George Selwyn was consecrated bishop. He was so impressed with the work of native evangelists that he founded a college in Auckland where such teachers could be trained. In this he was helped by J. C. Patteson, and out of it grew the Melanesian Mission. The Maori rebellion, fomented by French Catholics, was an outbreak against everything foreign, and the strange religion Hau-hauism, a blend of Old Testament history, Roman Catholic dogmas, pagan rites and ventriloquism, found many adherents. Yet the normal missionary organization suffered very little. Later came Mormon missionaries, and these have to some extent further depleted the Christian ranks.

New Guinea.—In this large island some Gossner missionaries (1854) were the pioneers. They could not do much, but their successors, the Utrecht Missionary Union, who began work when the Dutch took possession of the north-west of the island, are making themselves felt through their six stations. In German New Guinea the Neundethelsau (1886) and Rhenish (1887) Societies have fourteen stations. In British New Guinea, the south-east portion of the island, the London Mission (1871), the Australian Wesleyans (1892) and the Anglican Church of Australia (1892), have arranged a friendly division of the field and met with gratifying success. Work was begun in 1871–1872 when under the oversight of S. Macfarlane and A. W. Murray a number of native teachers from the Loyalty Islands Rarotonga and Mare settled on the island. The first converts were baptized in 1882 and the establishment of a British Protectorate (1884–1888) gave the work a new impetus. The name of W. G. Lawes and James Chalmers (who with O. Tompkins was killed by cannibals, 1901) of the London Missionary Society, and that of MacLaren, the pioneer of the Church Missionary Society's work, are immortally associated with Papua. The history of mission work here is one of exploration and peril amongst savage peoples, multitudinous languages and an adverse climate, but it has been marked by wise methods as well as enthusiastic devotion, industrial work being one of the basal principles. Besides the Protestant agencies already named, the Roman Catholic Order of the Sacred Heart has been working in the island since 1886; its centre is at Yule Island, and it works up the St Joseph's river.

Other Islands.—The London Mission ship "Duff" in 1797 landed eighteen missionaries (mainly artisans) at Tahiti, ten more in the Tonga or Friendly Islands, and one on the Marquesas. Those in Tahiti had a varying experience, and their numbers were much reduced, but in July 1812 King Pomare II. gave up his idols and sought baptism. By 1815 idolatry was abolished in the larger islands of the group and there ensued the task of building up a Christian community. Foremost in this work

were William Ellis (*q.v.*) and John Williams (*q.v.*), who formed a native agency to carry the gospel to their fellow islanders, and so inaugurated what has since been a characteristic feature of South Sea Missions. In 1818 two Tahiti teachers settled in the Tonga Islands, which the "Duff" pioneers had abandoned after half of them had been killed for a cannibal feast. When the Wesleyans came in 1821 the way had been prepared, and soon after, led by their king, George, the people turned to the new faith. About the same time Rurutu in the Austral Islands and Aitutaki in the Cook Islands were evangelized, also by natives, and Christianity spread from island to island. John Williams himself removed in 1827 to Rarotonga and from there influenced Samoa, the Society Islands and Fiji. To Fiji in 1834 came James Calvert and other Wesleyan missionaries beginning a work which under them and their successors had extraordinary success. Williams met his death at Erromanga in 1839, but he had established a training school on Rarotonga, and bought a ship, the "Camden," which was of the greatest service for the work. In 1841 Camden was begun in New Caledonia, in 1842 in the Loyalty Isles and in the New Hebrides, associated from 1857 with the memorable name of John G. Paton. In 1846 a teacher was placed on Niuf, Savage Island, and in ten years it was evangelized. Meanwhile the original work in Tahiti had been taken over by missionaries of the Paris Society, though the last London Missionary Society agent did not leave that group till 1890. In 1861 Patteson was consecrated bishop of Melanesia, and the Auckland training school was removed to Norfolk Island. By arrangement with the Presbyterians the area of the mission includes the Northern New Hebrides, Banks, Torres, Santa Cruz and Solomon Islands. Patteson was murdered in 1871, a victim of the mistrust engendered in the natives by kidnapping traders. In 1877 John Selwyn was consecrated bishop. Wesleyan native evangelists from Fiji and Tonga carried Christianity in 1875 to the Bismarck Archipelago.

The solitary worker (W. P. Crook) on the Marquesas did not remain long, and after he went nothing was done till 1833–1834, when first some American and then some English missionaries arrived, but met with scant success and gave it up in 1841. Since 1854 teachers from the Hawaiian Islands have worked in the Marquesas, but results here have been less fruitful than anywhere else in the South Seas. In Hawaii itself much was accomplished by American missionaries, the first of whom were H. Bingham and A. Thurston (1820), and the most successful, Titus Coan, under whose leadership over 20,000 people were received into the churches between 1836 and 1839. Under the reign of Kalakaua (1874–1891) there was a strong reaction towards heathenism, but since the annexation of the islands by the United States of America the various churches of that land have taken up the task of evangelization and consolidation.

In the Micronesian Islands, while animism and tabu were strong, there was not the cannibalism of the southern islands. Work was begun in the Caroline Isles in 1852 and in time spread to the Gilbert and Marshall groups. In the Carolines and Marshalls it has now largely passed to German missionaries, but Americans having enough to do in the Philippines, where there are already over 27,000 Protestants.

The outstanding features of missionary work in the South Seas are (1) its remarkable success: cannibalism, human sacrifice and infanticide have been suppressed, civilization and trade have marvelously advanced; (2) the evangelical devotion of the natives themselves; (3) the need of continued European supervision, the natives being still in many ways little better than grown-up children.

Africa.—In Africa, as in the South Seas, mission work has gone hand in hand with geographical discovery. It is in every sense a modern field, or rather a collection of fields, varying in physical, racial, social and linguistic character. The unaccustomed conditions of life and the fatal influence of the climate have claimed as many victims here as did savagery in the Pacific

¹ See F. P. Noble, *The Redemption of Africa*; J. Stewart, *Down in the Dark Continent*; Sir Harry Johnston, "The Negro and Religion" in *Nineteenth Century*, June 1910.

Islands. The partition of the continent among the various European nations has been on the whole favourable to mission work. The nature of the task and of the results may be best approached by considering the different divisions—North, South, East, West and Central Africa.

North Africa, along the Mediterranean from Morocco to Egypt, is distinctly Mohammedan. To these regions came St Louis and Raimon Lull, and one may in passing remember the strength of Christianity in Proconsular Africa in the days of Tertullian and Cyprian, and in Egypt under Clement of Alexandria, Origen and Athanasius. To-day Islam is supreme, though the North Africa Mission, working largely on medical lines, has penetrated into many cities. In Egypt the United Presbyterians of America have met with considerable success among the Copts, and their fine educational work has proved a valuable asset both to themselves and the country. The Church Missionary Society is doing steady work in Cairo and in Upper Egypt. In the Eastern Sudan a promising beginning has been made, but the regions south of Kordofan have hardly been touched. In Nigeria the Hausa tribes are coming to be better known, and to respond to the Christian teaching. In the Sahara and at Suakin there are Roman Catholic missions. There is a Roman mission to the Gallas in Abyssinia. That country has its own crude form of Christianity, and is much the same today as when Peter Heiling in the 17th century endeavoured to propagate a purer faith. A mission undertaken by the Church Missionary Society in 1830 was closed by French Jesuit intrigue in 1838.

South Africa.—The Moravians, represented by George Schmidt, who arrived at Cape Town in July 1737, were the first to undertake mission work in South Africa. Schmidt won the confidence of the Hottentots, but the Dutch authorities stopped his work. In 1798 John T. Vanderkemp, an agent of the London Missionary Society, founded a mission to the Kafirs east of Cape Town, and Robert Moffat (1818) went to the Bechuans. David Livingstone was as determined to open the interior as the Boers were to keep it shut, and he succeeded, pushing north, discovering Lake Ngami, and consecrating a remarkable life to the evangelization of Central Africa. The London Mission has also largely evangelized the Matabele. In 1814 the Wesleyans began work among the Namaquas and Hottentots, and afterwards went into Kaffraria, Bechuanaland and Natal. They were followed by the Glasgow Missionary Society (1821), the Paris Evangelical Society (1829), the Moravian, Rhenish and Berlin Societies, and the American Board. The Society for the Propagation of the Gospel came in 1819, mainly for colonists, the Church Missionary Society in 1837. The province of South Africa has ten dioceses, the bishop of Cape Town being metropolitan. The Glasgow Society's work was ultimately taken over by the Free Church of Scotland, whose great achievement is the Lovedale Institute, combining industrial and mission work. The Germans and Scandinavians have also been ardent workers in South Africa, and the Dutch Reformed Church has not entirely neglected the natives. One Dutch society gives its attention to the northern part of the Transvaal. The chief difficulties in the way of evangelization have been (1) the hostility of natives races aroused by European annexations, (2) the introduction of European vices, (3) the movement known as Ethio-pianism. The British Wesleyans refused to confer full rights on negro pastors, who then appealed to the African Methodist Episcopal Church, a product of American evangelization. One of them, J. M. Dwane, was made Vicar-Bishop, and a large and powerful independent negro church organized. Dwane afterwards approached the Anglicans, and in 1900 that church formed the "Ethiopian Order," ordaining Dwane a deacon and making him Provincial of the Order. Each bishop now deals with the Ethiopians in his own diocese. The South African governments foresaw dangerous developments in the Ethiopian movement, and steps were taken to restrain its growth. Ethio-pianism, if ecclesiastical in its origin, gained strength from racial base. The task of averting the racial bitterness so dominant in the United States of America is a most formidable one. There

are in South Africa several vicariates and prefectures of the Roman Church, the principal missions being French, those of the Congregation of the Holy Ghost and the Oblates of Mary.

West Africa was first visited by the Society for the Propagation of the Gospel in 1752. Its agent, T. Thompson, trained Philip Quaque, said to be "the first convert who ever received ordination since the Reformation in the Reformed Church." The Church Missionary Society came in 1804 and has worked heroically and successfully, though the largest mission now is that of the Wesleyans, who came in 1811, settling first at Sierra Leone. The American Baptists in Liberia (1821) and the Basel Mission in the Gold Coast (1827), the Congregationalists of the United States of America and Canada in Angola, and the English and American Baptists on the Congo (since 1875) have also extensive and prospering agencies. West Africa has taken heavy toll not only in money but in life, but the lesson has now been learned, and a system of frequent furloughs combined with a better understanding of the climatic requirements have appreciably lessened the peril. This region is linked with the name of the Anglican negro Bishop, Samuel Crowther, and with one phase of the ceaseless strength of Islam, which has so far failed to reach the west coast, finding itself confronted by the Christian influences which are at work among the great Hausa tribes and other peoples within the area of the Niger mission. The Portuguese in Angola and the agents of King Leopold in the Congo State have not been conspicuous friends of missionary enterprise, and the light-hearted childishness of the native character, so well portrayed in Miss Kingsley's writings, shows how difficult it is to build up a strong and stable Christian church. Bishop Taylor's effort at creating a self-supporting mission proved fruitless. The American Lutherans are attempting the same task on rather different lines, and with more promise. The Roman Catholic missions are chiefly French, and organized by the Congregation of the Holy Ghost and the Lyons African Mission.

Central Africa.—The upper Congo region opened up by Livingstone and Stanley has been a favourite sphere for what are known as "faith societies," e.g. the Plymouth Brethren, the Christian and Missionary Alliance, the Regions Beyond Missionary Union. The American Baptists continue the work started by the Livingstone Inland Mission in 1878, and the Southern Presbyterian Board (American) have done notable work. The Paris Society, represented especially by François Collard, has been successful along the Zambezi, and Scottish, German, Moravian and Jesuit agencies are also well represented. Northward, Central and East African organizations, following the Cape to Cairo route, are in touch with North African agencies working up the Nile.

East Africa.—When the Abyssinia mission was closed in 1838 one of the missionaries, Krapf, went among the Gallas and then on to Mombasa, working in company with Rebmann. Since H. M. Stanley's appeal (1875) most satisfactory work, extensive and intensive, has been accomplished in Uganda, by the Church Missionary Society. The names of Mackay, Hannington and Pilkington, who lived and died here, are amongst the greatest in the roll of missionary heroes. The Roman Mission too has been very successful; for some years a French agency, the White Fathers of Algeria, carried it on, but they were afterwards joined by English helpers from St Joseph's Society at Mill Hill. The White Fathers also work in the Great Lakes region, and on the Zanzibar coast are the French Congregation of the Holy Ghost and German Benedictines. Zanzibar is also one of the centres of the Universities Mission, another being Likoma on Lake Nyasa. Near this lake the Scottish churches are also doing noble work. Besides Uganda the Church Missionary Society is responsible for Mombasa. The London Mission is meeting with success at the south end of Lake Tanganyika in North-east Rhodesia. The English United Methodists and some Swedish societies have begun work among the Gallas. German Missionary agencies have also come in with German colonization. In East Africa, as in the West, Christian missionaries fear most the aggressive Moslem propaganda.

*Madagascar*¹ is one of the most interesting mission fields. Work was begun by the London Mission in 1810, and the work of civilization and evangelization went steadily forward till 1835, when a period of repression and severe persecution set in, which lasted till 1861. When the work was recommenced it was found that the native Christians had multiplied and developed during the harsh treatment of the 25 years. In 1869 the idols were publicly destroyed and the island declared Christian by royal proclamation. The Society for the Propagation of the Gospel (1864), the Norwegian Missionary Society (1866), and the Friends' Foreign Missionary Association joined in the work, the prosperity of which received a severe check by the French annexation in 1866. The French authorities were hostile to the English missionaries, and even the handing over of part of the field to the Paris Evangelical Society did not do much to ease the situation. Laws were first enacted against private schools, then against elementary schools, and in 1906-1907 measures were passed which practically closed all mission schools. Family prayers were forbidden if any outside the immediate family were present, and religious services at the graveside were prohibited. Missionary work in the island has thus passed through a peculiarly trying experience, but happier conditions are now likely to prevail. In Mauritius and the Seychelles the Church Missionary Society and the Society for the Propagation of the Gospel are at work, especially among the coolies on the sugar plantations.

The outstanding problem of African missions at least north of the Equator (south there is the Ethiopian question) is not the degradation of the black races, nor the demoralizing influences of heathen Christians, nor even the slave trade, though all these obstacles are present and powerful. The all-decisive conflict is that between Christianity and Islam, and the Christian agencies must show much more co-operation if they are to be successful. The lines of mission-work have been, generally speaking, simple gospel preaching followed by education and industrial work. So rare were the ordinary comforts, and even necessities of life, that the latter had to take a prominent place from the beginning: the missionary had to be farmer, carpenter, brickmaker, tailor, printer, house and church builder, not only for himself but for his converts. The work of Bible translation has been particularly long and difficult; for the innumerable peoples who did not speak some form of Arabic the languages had first to be reduced to writing, and many Christian terms had to be coined.

India.²—The earliest missionaries to India, with the possible exception of Pantaenus of Alexandria (c. A.D. 180), were the Nestorians from Persia. The record of their work is told elsewhere (see NESTORIANS and NESTORIANS). The Jesuits came in the 16th century, but were more successful quantitatively than qualitatively; in the 18th century the Danish coast mission on the coast of Tranquebar made the first Protestant advance, Bartholomæus, Ziegenbalg (1683-1719), Plutschau and Christian Friedrich Schwartz (1726-1798) being its great names. Up to this time the chief results were that (1) Christianity had gained a footing, (2) it had continued the monotheistic modification of Indian thought begun by Mahomedanism, and (3) the utility of sporadic and fanatical proselytism had been shown. A new era began with the arrival of William Carey and the founding of the Serampur Mission (15 m. north of Calcutta), though the hostility of the East India Company made the early years of the 19th century very unproductive. When Carey died in 1834 he and his colleagues Marshman and Ward had translated the Bible into seven languages, and the New Testament into 23 more, besides rendering services of the highest kind to literature, science and general progress. They founded agricultural societies and savings' banks, and helped to abolish suttee, infanticide and other cruelties. At Travancore in the south, Ringeltaube, an agent of the London Missionary Society, had begun a work, especially among the Shanars or toddy drawers, which by 1840 had 15,000 Christians; and the Church Missionary Society, led by Rhenius, had equal success in Tinnevely. The Baptists, drawn by the fame of the temple of Jagannath at Puri on the

east coast, established a mission in Orissa in 1821 which soon bore fruit; the Wesleyans were in Ceylon, Mysore and the Kaveri valley, the London Missionary Society at the great military centres Madras, Bangalore and Bellary, agents of the American Board at Ahmednagar and other parts of the Mahratta country around Bombay. The headquarters of Hinduism, the Ganges valley, was occupied by the Baptists, the Church Missionary Society and the London Missionary Society, these entering Benares in 1816, 1818 and 1820 respectively. Alexander Duff, a Scottish Presbyterian, had begun his great educational work in Calcutta, and Bible tract and book societies were springing up everywhere. Chaplains and bishops of the Anglican Church like James Hough in Tinnevely, Henry Martyn in the north, Daniel Corrie in Agra, T. F. Middleton in Calcutta, and Reginald Heber all over India, were eagerly using their opportunities. In 1830 ten societies with 106 stations and 147 agents were at work; 1834 saw the founding of the Basel Mission on the west coast, the American Mission in Madura, the American Presbyterian Mission in Luddiana. It would be impossible to trace in detail the work done by the different societies since Carey's time. The task as it presented itself may be analysed as follows: (1) to replace the caste system and especially the oppressive supremacy of the Brahmins by a spirit of universal brotherhood and the establishment of social and religious liberty; (2) to correct and raise the standard of conduct; (3) to attack polytheistic idolatry with its attendant immoralities; (4) to replace the pantheistic by a theistic standpoint; (5) to elevate woman and the pariah. Besides these matters which concerned Hinduism there was the problem of converting sixty million Mahomedans. The chief methods adopted have been the following: (1) vernacular preaching in the large towns and on itineraries through the rural districts, a work in which native evangelists guided by Europeans and Americans played a large part. (2) Medical missions, which have done much to break down barriers of prejudice, especially in Kashmir under Dr Elmslie of the Church Missionary Society, and in Rajputana at Jaipur under Dr Valentine of the United Presbyterians. (3) Orphanages, in which the Roman Catholics led the way and have maintained their lead. (4) Vernacular schools, a good example of which is seen in the American Board's Madura Mission. (5) English education, in which the missionary societies have amply supplemented the efforts of the government, outstanding examples being the Madras Christian College (Free Church of Scotland), so long connected with the name of Dr William Miller, the General Assembly of Scotland's Institution at Calcutta, founded by Duff, Wilson College, Bombay (Free Church of Scotland), and St Joseph's College (Roman Catholic) at Trichinopoly. Work of this kind is followed up in some centres by lectures and conversations with educated Hindus. The Haskell Lectureship, which grew out of the Parliament of Religions in Chicago, belongs here. (6) Female education and zenana work. (7) Uplifting work among the Panchamas or low-castes, which has been strikingly successful among the Malas (American Baptists) and the Madigas (London Missionary Society) of the Telugu-speaking country, who come in mass movements to the Christian faith. (8) Missions among aboriginal tribes, e.g. the Kols and Santals of Chota Nagpur (Berlin Gossner Mission and the Society for the Propagation of the Gospel), and the tribes of the Khasia Mountains east of Bengal (Welsh Calvinistic Methodists). (9) Christian literature, in which connexion the name of Dr John Murdoch will always be honourably remembered. (10) Pastoral work and the care of the churches.

The great changes that have been wrought in India, politically, commercially, intellectually and religiously, by the combined action of the British government and the Christian missions, are evidenced among other tokens by the growth of such societies as the Arya Samaj and the Brahm Samaj. Orthodox Hindus, especially those whose social status and very livelihood are imperilled by the revolution, have shown their alarm either by open opposition, subjecting converts to every sort of caste coercion, or by methods of defence, e.g. Hindu tract societies and young men's associations, which are modelled on

¹ See T. T. Matthews, *Thirty Years in Madagascar*.

² See E. P. Rice in *A Primer of Modern Missions*, ed. R. Lovett (London, 1896); J. Richter, *A History of Missions in India* (1908); *The Church Missionary Review* (July 1908); *Contemporary Review* (May 1908 and June 1910).

Christian organizations. A counter reformation can also be traced which attempts to revive Hinduism by purging it of its grossness and allegorizing its fables and legends. A new Islam is also a factor of the situation. Comparatively few converts have been made from Mahomedanism to Christianity, and these have been chiefly among the learned. But there is a wide prevalence of free-thinking, especially among the younger and educated classes of the community.

The special difficulties of mission work in India may be thus summarized. (1) Racial antipathy. (2) The speculative rather than experimental and practical nature of the Hindu consciousness—historical power makes no appeal to it. (3) The lack of initiative; in a land where the joint family system is everywhere and all powerful, individualism and will-power are at a discount. (4) The ignorance and conservatism of the women. (5) An inadequate sense of sin. (6) The introduction of European forms of materialism and anti-Christian philosophy. Perhaps, too, the methods adopted by missionaries have not always been the wisest, and they have sometimes failed to remember the method of their Master, who came "not to destroy, but to fulfil." In spite, however, of all the difficulties, permanent and increasing results have been achieved along all the lines indicated above. The establishment of a strong native church is far from being the only fruit of the enterprise, but it is a fruit that can be gauged by statistics, and these are sufficiently striking. In a necessarily inadequate sketch it is impossible to give more than the barest mention to one or two other features of modern missionary achievement in India, e.g. the development of industrial schools, the establishment of a South India United Church, in which the Congregationalist agencies (London Missionary Society and American Board) and the Presbyterians have joined forces, and the endeavour to train an efficient and educated native ministry, which is being promoted especially at Serampur, where an old Danish degree-granting charter has been revived in what should be a Christian university, and at Bangalore, where Presbyterians, Congregationalists and Wesleyans collaborate to staff and maintain a united theological college. The government census for India and Burma (1901) gives a Christian population of 2,923,241 (native Christians 2,664,313) out of a total population of 294,361,056, or about 3%. The inclusion of Portuguese and French possessions would add about 350,000 to the Christian total. Though the number does not seem relatively high, it is significant when compared with that of former censuses—in 1872, 1,517,997; in 1881, 1,862,525 (increase 22.7%); in 1891, 2,284,386 (increase 22.6%); in 1901, 2,923,241 (increase of 28%). The increase of 28% between 1891 and 1901 has often been compared with the fact that the total population of India only registered an increase of 2½% in that decade. In the words of *The Pioneer*, "this is a hard fact which cannot be explained away" and "the most remarkable feature of the returns." The increase was shared by every province and state in India. In 1910 there were 4614 missionaries (including wives), representing 122 societies, 1272 Indian ministers, and 34,095 other native workers, including teachers and Bible-women.

The growth of the Protestant Native Christian community between 1851 and 1910 is shown in the following table:—

Native Christian Community.			Communicants.			Native Agents.	
Number.	Rate of Increase.		Number.	Rate of Increase.	Proportion of the Community.	Ordained.	Unordained Preachers.
	%			%	%		
1851	91,092		14,661		16.0	21	493
1861	138,731	52.3	24,976	70.3	18.0	97	1266
1871	224,258	61.6	52,816	114.4	23.5	225	1985
1881	417,372	86.1	113,325	114.5	27.1	461	2488
1891	589,722	34.8	182,722	61.2	32.6	797	3491
1900	854,867	52.8	301,699	65.5	35.3	1,272	—
1910	1,472,448	72.2	522,743	73.3	—	—	—

The Protestant community in India in 1910 was over a million strong, well distributed among the chief provinces, a fine spiritual force, easily first in female education, and rapidly growing in wealth, position and influence. A recent report of the Director of Public Instruction for the Madras Presidency says: "I have frequently called attention to the educational progress of the native Christian community. There can be no question, if the community pursues with steadiness the present policy of its teachers, that in the course of a generation it will have secured a preponderating position in all the great professions."

What India wants (as Nobili 300 years ago saw, and attempted, though by fatal methods of deceit, to supply) is a Christianity not foreign but native, not dissociated from the religious life of the land but its fulfilment. Though there are many Christians in India to-day, the Hindu still looks askance at Christianity, not because it is a religion but because it is foreign. "India is waiting for her own divinely appointed apostle, who, whether Brahmin or non-Brahmin,

shall connect Christianity with India's religious past, and present it as the true Vedanta or completion of the Veda and thus make it capable of appealing to the Hindu religious nature."

It only remains to be said that the work of the missionaries individually and collectively has over and over again received the warmest recognition and praise from the highest officials of the Indian government.

China.—The earliest Christian missionaries to China, as to India, were the Nestorians (*q.v.*). Their work and that of the Roman Church, begun as the result of Marco Polo's travels about 1290, faded away under the persecution of the Ming dynasty which came to power about 1350. The next attempt was that of the French Jesuits, following on the visit and death of Xavier. They established themselves at Canton in 1582, and on the accession of the Manchu dynasty (1644) advanced rapidly. In 1685 there were three dioceses, Peking, Nanking and Macao, with a hundred churches. The Orthodox Eastern Church gained a footing in Peking in the same year, and established a college of Greek priests. Friction between Jesuits and Dominicans led to the proscription of Christianity by the emperor in 1724, missionaries and converts being banished. The story of modern missions in China begins with Robert Morrison (*q.v.*) of the London Missionary Society, who reached Canton in 1807, and not being allowed to reside in China entered the service of the East India Company. In 1813 he was joined by a colleague, William Milne, and in 1814 baptized his first convert. In 1829 came representatives of the American Board, in 1836 Peter Parker began his medical mission, and on the opening of the Treaty Ports the old edicts were withdrawn, and other societies crowded in to a field more than ample. After the war of 1856 a measure of official toleration was obtained, and the task of evangelizing the country was fairly begun. Though the missionaries were chiefly concentrated in the treaty ports they gradually pushed inland, and here the names of W. C. Burns, a Scottish evangelist, J. Hudson Taylor, the founder of the China Inland Mission, and James Gilmour, the apostle of Mongolia, are pre-eminent. But for more than half a century China seemed the most hopeless of mission fields. The upper classes were especially anti-foreign, and the whole nation vaunted its superiority to the rest of mankind. In 1857 there were only about 400 baptized Protestant Christians in the whole of China. Even after the removal of the edicts the old prejudices remained, and the missionaries were regarded as political emissaries, the forerunners of military aggression. Native Christians were stigmatized as traitors, "followers of the foreign devils." In 1870 there was a great outbreak concentrating in the massacres at Hankow and Tientsin; in

1891 at Hunan and in 1895 at Ku Cheng there were other attacks which were only preliminary to the Boxer uprising of 1899-1900, when 135 missionaries, besides 52 children and perhaps 16,000 native Christians, whose heroism will always be memorable, perished, often after horrible tortures. There is little doubt that this savage outburst was directed not against religious teaching as such, but against the introduction of customs and ideas which tended to weaken the old power of the mandarins over the people. These leaders skillfully seized upon every breach of tradition to inflame popular passion, attacking especially the medical work as a pretext for mutilation, the schools as hotbeds of vice, and the orphanages as furnishing material for witchcraft. Out of the agony, however, a new China was born. The growing power of Japan, seen in her wars with China and Russia, and the impotence of the Boxers against the European allies, made all classes in China realize their comparative impotence, and the central government began a series of reforms, reorganizing the military, educational, fiscal and political systems on Western lines. Educational reforms became especially insistent, and modern methods and studies supplanted

¹ See A. H. Smith, *Chinese Characteristics: Village Life in China*; and J. C. Gibson, *Mission Problems and Mission Methods in South China*.

the immemorial Confucian type. Students went in great numbers to Japan, Europe and America, and the old contempt and hostility toward things Western gave place to respect and friendliness. Early in the 19th century the missionaries had not been able to do much by way of education, but the new openings were seized with such power as was possible, and while in 1876 there were 289 mission schools with 4900 pupils, in 1910 there were 3129 schools with 79,823 scholars. More significant still is the way in which the foremost Chinese officials have turned to missionaries like Timothy Richard and Griffith John for assistance in guiding the new impulse. The universities of Oxford and Cambridge, under the inspiration of Lord William Cecil, were interesting themselves in 1910 in a scheme for establishing a Christian university in China.

One of Morrison's contemporaries hoped that after a century of mission work there might possibly be 2000 Christians in China. That number was reached in 1865, and in 1910 there was a Protestant community of 214,546 church members and baptized Christians. These numbers are more than double what they were in 1900. In addition there are more than as many adherents.¹ The excellence of the converts, upon the whole, is testified to by travellers who really know the case; particularly by Mrs Bishop, who speaks of the "raw material" out of which they are made as "the best stuff in Asia." The total number of Protestant missionaries (including wives) in China in 1910 was 4175, one to about 1100 sq. m., or to more than 100,000 Chinese. There are over 12,000 Chinese evangelists, Bible-women, teachers, &c. The Roman Catholic returns give 902,478 members and 390,617 catechumens. The work is carried on by eleven societies or religious orders with over 40 bishops and 1000 European priests, mostly French. A large feature of the work is the baptism of children. An important concession was obtained in 1809 by the French minister at Peking, with a view to the more effective protection of the Roman missions. The bishops were declared "equal in rank to the viceroys and governors," and the priests "to the prefects of the first and second class"; and their influence and authority were to correspond. The Anglican bishops agreed to decline these secular powers, as also did the heads of other Protestant missions. It is alleged by some that the exercise of the powers gained by the Roman hierarchy was one cause of the Boxer outbreaks. Certainly their native adherents had their full share of persecution and massacre.

The Anglican Church is not so strong in China as in some other fields; the American Episcopalians were first in the field in 1835, followed by the Church Missionary Society (in 1844), which has had stirring success in Fu-Kien, and the Society for the Propagation of the Gospel in 1874. There are five dioceses, and in 1897 an episcopal conference was held in Shanghai. Since the Japanese War the Scottish and Irish Presbyterians have made wonderful progress in Manchuria; native evangelists do an increasing share of the work, and there is hardly any town or village without Christians. The London Mission has always been conspicuous for the contribution made by its agents to linguistic and literary knowledge, the name of James Legge being an outstanding example; it is now, in co-operation with other societies, earnestly taking up the new educational and medical openings. One of the most interesting features of mission work in China is the comity that prevails among the workers of different societies and ages. Thus in 1907 at the Centenary Conference in Shanghai, when many topics were discussed centering in the question of the native Chinese Church, a general declaration of faith and purpose was adopted, which, after setting out the things held in common, proceeded, "We frankly recognize that we differ as to methods of administration and of church government; that some among us differ from others as to the administration of baptism; and that there are some differences as to the statement of the doctrine of predestination, or the election of grace. But we unite in holding that these exceptions do not invalidate the assertion of our real unity in our common witness to the Gospel of the Grace of God." The conference reported, "We have quite as much reason to be encouraged by the net results of the progress of Christianity in China during the 19th century as the early Christians had with the progress of the Gospel in the Roman Empire during the first century."

Japan and Korea.—The Christian faith was brought to Japan by Portuguese traders in 1542, followed by Xavier in 1549.

¹ See *Contemporary Review* (Feb. 1908), "Report on Christian Missions in China," by Mr F. W. Fox, Professor Macalister and Sir Alex. Simpson.

This great missionary was well received by the daimios (feudal lords), and though he remained only 2½ years, with the help of a Japanese whom he had converted at Malacca he organized many congregations. In 1581 there were 200 churches and 150,000 Christians; ten years later the converts numbered 600,000, in 1594 a million and a half. Then came a time of repression and persecution under Iyeyasu, whose second edict in 1614 condemned every foreigner to death, forbade the entry of foreigners and the return of Japanese who had left the islands, and extinguished Christianity by fire and sword. The reopening of the country came in 1859, largely through American pressure, and in May of that year two agents of the Protestant Episcopal Church began work at Nagasaki. They were followed by others from the Presbyterian and Reformed Churches, and by their great intellectual ability, patience and tact these pioneers (S. R. Brown, J. C. Hepburn and G. F. Verbeck), as the Marquis Ito said, contributed very largely to the progress and development of Japan in the days when she was first studying the outer world. They did an immense amount of preparatory work along evangelistic, medical and educational lines, and skillfully gathered the youths of the country around them. The accession of a new mikado in 1868 finally ended the old seclusion; financiers, engineers, artisans poured in from Western Europe, and from America came bands of teachers, largely under missionary influence. In 1869 the American Board (Congregational) sent its first band; in 1870 Verbeck was called on to organize a scheme for national education. In 1872 the first Japanese church was formed; in 1875 Joseph Neesima, who had been converted by a Russian missionary and then educated in America, founded a Christian Japanese College, the Doshisha, in the sacred city of Kyoto. Meanwhile the Christian calendar had been adopted and the old anti-Christian edicts removed. By 1889 there were 30,000 Protestant communicants. It was at this time that the nation, conscious of its new life, began to be restive under the supercilious attitude of foreign nations, and the feeling of irritation was shared by the native Christian communities. It showed itself in a desire to throw off the governance of the missionaries, in a criticism of Protestant creeds as not adapted to Japanese needs, and in a slackened growth numerically and intensively. After a period of stress and uncertainty, due very largely to the variety of denominational creed and polity, matters assumed an easier condition, the missionaries recognizing the national characteristics and aiming at guidance rather than control. The war with China in 1894 marked a new chapter and initiated a time of intense national activity; education and work for women went forward rapidly. Missionaries went through the island as never before, and their evangelistic work was built upon by Japanese ministers. In the war with Russia Japanese Christianity found a new opportunity; on the battlefield, in the camp, at home, Christian men were pre-eminent. In 1902 there were 50,000 church members; in 1910, 67,043; the total Protestant community in 1910 was about 100,000, and had an influence out of all proportion to its numbers; the Roman Church was estimated at 79,000, and the Orthodox Eastern Church (Russian) at 30,000.

No sketch, however brief, can omit a reference to the Anglican bishop of South Tōkyō, Edward Bickersteth (1850-1897), who from his appointment in 1886 guided the joint movement of English and American Episcopalians which issued in the Nippon Sei Kokwai or Holy Catholic Church of Japan, a national church with its own laws and its own missions in Formosa. In April 1907 the Conference of the World's Student Christian Federation (700 students from 25 different countries) met in Tōkyō, and received a notable welcome from the national leaders in administration, education and religion.

In Korea, the "Hermit Nation," or as the Koreans prefer to say, "The Land of the Morning Calm," Christianity was introduced at the end of the 18th century by some members of the Korean legation at Peking who had met Roman Catholic missionaries. It took root and spread in spite of opposition until 1864, when an anti-foreign outbreak exterminated it. The door was re-opened by the treaties of 1882-1886, and even before that

copies of the gospels had been circulated from the Manchuria side. The Methodist Episcopal Church and the Presbyterian Board, both of America, entered the country in 1835, and were soon joined by similar agencies from Canada and Australia. The Anglican Church began work in 1890, the work was thoroughly planned, the characteristics of the people were carefully considered, and the successes and failures of other mission-fields were studied as a guide to method. The medical work won the favour of the government, and so wisely did the missionaries act, that during all the turbulent changes since 1884 they escaped entanglement in the political disturbances and yet held the confidence of the people. The persistence and growth of Christianity among the Koreans is largely due to the fact that Christianity had not been superimposed on them as a foreign organization. They had built their own churches and schools, adopted their own forms of worship and phrased their own beliefs. Korea vies with Uganda as a triumph of modern missionary enterprise. In 1866 there were not more than 100 Christians; official returns in 1910 show 178,686 Protestants, including 72,000 church members and probationers; and 72,290 Roman Catholics. Theological colleges, normal training colleges and higher and lower grade schools bear witness to an activity and a success which are truly remarkable.

South-East Asia and the East Indies.—The work of Christian missions in this area has had the double advantage of freedom from political and social unrest, and of comparatively little overlapping, each country as a rule being taken over by a single society. In Burma the American Baptists, whose work began with Adoniram Judson in 1813, are conspicuous, and have had marked success among the Karens or peasant class, where the pioneer was George Dana Boardman (1827). The Karen Christian communities are strong numerically and have a good name for self-support. The Baptists have also stations in Arakan and Assam where they link up with the Welsh Calvinistic Methodists (1845). The Society for the Propagation of the Gospel and the Methodist Episcopal Church work in and around Rangoon. In Siam again the Americans, especially the Presbyterians, have been most prominent. Medical work made an impression on the people and won the favour of the government, which has always been cordial and has employed missionaries as court-tutors. Buddhism is at its best at Siam, and this and the enervating climate are responsible for the comparatively small direct success of Christian propaganda in Siam proper. In the Laos country to the north, however, much more has been done, and a healthy type of Christian community established. Native workers have done something to carry the Gospel into the French colonies of Tongking and Annam. Here the Roman missions are very extensive, and have over a million adherents, despite violent persecution before the French occupation.

The peninsula and archipelago known as *Malaysia* presents a remarkable mingling of races, languages and beliefs. Tatar, Mahomedan and Hindu invasions all preceded the Portuguese who brought Roman Catholicism, and the Dutch who brought Protestantism. This last resulted in a great number of nominal conversions, as baptism was the passport to government favour, and church membership was based on the learning of the Decalogue and the Lord's Prayer, and on the saying of grace at mealtimes. In the Straits Settlement the foundations of modern missionary effort were laid by the London Missionary Society pioneers who were waiting to get into China; they were succeeded by the Society for the Propagation of the Gospel (1856), English Presbyterians (1875), Methodist Episcopalians (1884), who have a fine Anglo-Chinese College at Singapore, and the Church of England Zenana Society (1900).

In the *Archipelago* most of the work has naturally been in the hands of the Netherlands Missionary Society (1812) and other Dutch agencies, who at first were not encouraged by the colonial government, but have since done well, especially in the Minahassa district of Celebes (150,000 members) and among the Batak of Sumatra (Rhenish Mission). In Celebes and the Moluccas the work is now under the Colonial State Church. In Java the government has favoured Mahomedans (there is

active intercourse between the island and Mecca), but there are some 25,000 Christians and a training school and seminary at Depok near Batavia. In Dutch Borneo the Rhenish Society is slowly making headway among the Dyaks; in British Borneo the Society for the Propagation of the Gospel (1848) and the Methodist Episcopalians occupy the field. The total number of Christians in British Malaya and the Dutch East Indies is about 600,000 (including 57,000 Roman Catholics).

Western Asia and the Turkish Empire.—The American Presbyterians and Congregationalists have the largest Protestant missions in these lands, working, however, mainly for the enlightenment and education of the Oriental Christians. With the same object, though on different lines, the archbishop of Canterbury's Assyrian Mission seeks to influence the Nestorians. The Roman Catholics have extensive missions in these countries, directed at winning adherents to the unity of the Holy See from the Oriental Churches, which are regarded as schismatic and heretical. In this enterprise there has been great advance in Egypt among the Copts, and in 1890 the Pope signaled "the resurrection of the Church of Alexandria" by appointing a Patriarch for Egypt, Libya and Nubia. Farther east, on the borders of Turkey and Persia, the Roman and Russo-Greek Churches compete for the adhesion of the Nestorians, Chaldeans and Armenians. The Franciscans, Dominicans, Lazarists and Jesuits are engaged in all these works. Direct work among Mahomedans is done, though with small result, by the North Africa Mission (non-denominational) and the Church Missionary Society. The Egypt, Palestine and Persia missions of the latter society have been largely reinforced and extended since 1884, medical work and women's work being especially prominent. Four cities in southern Persia are now occupied. Three missions just touch the border of *Arabia*, viz. the United Free Church of Scotland at Aden, founded by Ion Keith-Falconer (1836-1887) son of the 9th earl of Kintore and Arabic professor at Cambridge; an American Presbyterian Mission on the Persian Gulf; and the Church Missionary Society's Mission at Bagdad. The American Robert College at Constantinople and the work of the Friends' Missionary Association in Syria are honourable and successful enterprises. The chief difficulties have been (1) the antagonism of the officials of the Oriental churches, (2) the suspicion and hostility of Islam, (3) the jealousies, religious and political, connected with the Eastern Question.

Missions in Christian Lands.—Australia has been referred to already (see *South Seas*, above). In the Western Hemisphere we may distinguish the following: (1) *Early Roman Missions* began with the discovery of the continent and practically ceased in the middle of the 18th century. Conspicuous among their achievements was the conversion of Mexico, 200,000 converts being enrolled within six years after the capture of the capital (1521), and a million baptized by the Franciscans alone within thirty years. In South America the passive character of the population made them submissive alike to the Spanish government and the Roman faith. Their natural devotion and their susceptibility to pomp and ritual was a factor skilfully used by the priests, but hardly anything was done to strengthen their spiritual power. The many brave European strata helped to reduce the whole continent south of Mexico in about a century to a level as low as that preceding the first mission. About 1600 the Franciscans and French Jesuits began their work in North America and among the Indians did a successful work marked by much heroism. They also enabled the Roman Church to keep its hold on the French colonists of Quebec and Montreal, and were pioneers in California. (2) *Modern Missions in North America.*—Missions among the Red Indian tribes in the North-West Territories of both the United States and Canada have been carried on by several societies. The first workers were Thomas Mayhew, junior and John Eliot at Martha's Vineyard (1643) and Roxbury (1646). Bishop Whipple of Minnesota was justly called the Apostle of the Indians, so far as the work of the American Episcopal Church was concerned. In the Canadian North-West the Church Missionary Society's Missions have reached many tribes up to the shores of the Polar sea, and made some thousands of converts. Even the wandering Eskimos, thanks to the Moravians, are mainly Christians. The Anglican Church has nine dioceses in the province of Rupert's Land. The Roman Catholic missionaries also are scattered over these immense territories, and have a large number of Indian adherents. Besides the Oblate many admit to the French Canada. The Russo-Greek Church has a mission in Alaska, dating

¹ See J. Richter, *A History of Protestant Missions in the Near East* (1910).

from the time when it was Russian territory, and various American societies are also represented. The total number of Indians in British North America is 99,000, of whom about 27,000 are still pagan, and the rest are about equally divided between the Protestant and Roman Catholic Missions. (3) *Central and South America*.—Protestant missions to Indians here have been very limited. Von Weltz did something in Dutch Guiana (c. 1670), and the Moravians among the Arrawak Indians of Surinam (1738-1808). Since 1847 they have worked on the Mosquito coast of Central America. American Missions are at work in Mexico and adjacent countries. In the West India Islands the negro population has been reached by most of the larger British societies. The South American Missionary Society, founded by the ill-fated Captain Allen Gardiner, has much extended its work among the Indians of the interior of what has been well called "the Neglected Continent"; it has been specially successful among the Araucanians of Chile and the Paraguayan Chaco. Their work among the Fuegians drew a warm tribute from Charles Darwin. Several American missions are also at work. The Society for the Propagation of the Gospel has an important mission in British Guiana. But there are numerous heathen tribes never yet reached. The Roman Church, which is dominant throughout the continent, has been engaged in serious struggles with the anti-religious tendencies of the Republican governments, and *L'Année de l'Église* makes no mention of missions among the Indians. In fact the Pope in 1897 was obliged to send a severe rebuke to the clergy for their lack of consistency and zeal. Protestant societies have done much to bring the Bible to the knowledge of the nominally Roman Catholic population.

RESULTS OF MISSIONS

The Christian Church bases its missionary enterprise upon the spirit, the example, and the commandment of its Founder, and regards the duty as just the same whether the results be

results. If, however, we are to take statistical returns for what they are worth, it is estimated that the Christians in heathen lands gathered by Protestant missions probably amount to five millions, and a similar total may be ascribed to Roman Catholic missions, making ten millions in all. This, however, includes adherents still under instruction for baptism, and their children. The inner circle of communicant members is hardly more than one-third of the total.

Missions are however a far greater thing after all than simple proselytism. It would require many a volume to tell of what they have done for civilization, freedom, the exploration of unknown regions, the bringing to light of ancient literatures, the founding of the science of comparative religion, the broadening of the horizon of Christian thought in the homelands, and the bringing of distant peoples into the brotherhood of nations. These are results that cannot be put into figures. While it is true that very diverse opinions are held concerning missions, it is indisputable that the most favourable testimonies come from those who have really taken the most pains to examine and understand their work. The one discouraging feature, from the Christian point of view, is the backwardness of Christendom in its great enterprise. If the Churches did their foreign work with the same energy which they throw into their home work, the results would be very different.

The figures given below are taken from a table compiled by Dr D. L. Leonard, and refer only to Protestant missions to non-

I.—STATISTICS OF THE GREAT RELIGIONS OF THE WORLD.

(From *The Blue Book of Missions*, 1907.)

	Christians.			Jews.	Moham- medans.	Buddhists.	Hindus.	Confucian- ists and Taoists.	Shintoists.	Animists, Fetichists, &c.	Unclassed.	Totals.
	Protestants.	Roman Catholics.	Eastern Churches.									
Africa	2,065,000	2,493,000	3,799,000	381,000	50,810,000	11,000	27,000	31,000	—	97,179,500	125,500	157,799,000
America, N.	64,488,000	36,693,000	1,000,000	1,069,000	15,000	—	96,000	85,000	—	80,000	8,000	111,651,000
America, S.	362,000	36,125,000	—	22,000	10,000	—	108,000	4,000	—	1,262,000	63,000	37,956,000
Asia	1,542,000	5,385,000	17,144,000	482,000	141,450,000	137,000,000	209,152,000	291,030,000	24,900,000	41,430,000	5,693,000	876,320,000
Australasia	3,846,000	964,000	—	—	—	4,000	1,000	21,000	—	40,000	70,000	4,355,000
Europe	94,029,000	183,754,000	98,211,000	9,247,000	3,576,000	—	—	—	—	—	1,319,000	389,031,000
Malaysia	419,500	7,065,500	—	3,000	20,700,000	—	27,000	570,000	—	16,445,000	69,000	45,379,000
Oceania	247,000	129,500	—	1,000	—	15,000	—	65,000	—	507,000	18,000	992,000
Aggregate	166,066,500	272,638,500	120,157,000	11,222,000	216,610,000	137,935,000	209,659,000	291,816,000	24,900,000	157,069,500	15,352,500	1,623,445,000
	558,862,000											

large or small. It appeals to common sense, saying in effect, "If it be a fact that a Divine Person came into the world to bless mankind, all men ought to know it, and have a right to know it. However much or (if you will) little a Buddhist or a

Christian and non-Protestant peoples. The figures are for 1907, and should be compared with those in the *Statistical Atlas*. This list gives a total of 69 Foreign Missionary Societies, of which 34 are American, 19 British, 10 German, and 6 other societies. The statistics for these 69 societies may be grouped as follows:—

II.—SUMMARY OF PROTESTANT MISSIONARY WORK.

	AMERICAN.			OTHER SOCIETIES, viz. Paris Society, Swiss Romande, Netherlands Societies, Scandinavian Societies, &c.	Totals for Christendom.	Totals for 1895 (showing growth between 1895 and 1907).
	AMERICAN.	BRITISH.	GERMAN.			
Ordained Missionaries	1,911	1,980	932	912	5,735	4,028
Laymen	535	1,738	168	361	2,802	1,477
Unmarried women	1,527	2,332	150	378	4,387	2,578
Ordained natives	2,312	2,141	197	623	5,273	4,295
Communicants (full members)	545,180	565,179	240,883	466,208	1,817,450	995,793
Numbers added in 1906	63,916	38,614	25,983	12,336	140,849	63,081
Adherents	1,286,259	1,398,306	540,073	1,136,500	4,361,138	2,770,801
Schools	8,855	11,789	2,878	5,346	28,868	19,384
Scholars	344,213	619,399	139,891	199,402	1,302,905	786,002

Moslem may need to know of Christ, he certainly has a claim to be told of Him. The responsibility, if there be any, of believing, rests with the individual told; the responsibility of telling him rests with the Christian Church." On this view of the matter, results, however desirable, are no certain test of a mission doing its work. A mission in Persia, with its handful of converts, has, on this view, as much right to support and appreciation as a mission in southern India with its tens of thousands. Again, on the hypothesis that Christianity is true, the statistics at a particular period are no test of success at all. For in them the dead are not counted; and the converts who are already dead are—at least in respect of individual salvation—the surest of

III.—PROTESTANT MISSIONARY INCOME.

1895	£2,724,194	1906	£4,256,029
1900	£3,095,915	1907	£4,473,933
1905	£3,932,377		

A world missionary conference was held at Edinburgh in June 1910, which aimed at making, on a scale far more comprehensive than had been previously attempted, a thorough and scientific study of the problems involved in the relation of Christianity to the non-Christian world. For two years preceding the conference eight representative commissions investigated the following questions:

1 The *Statistical Atlas* (1910) puts it at £5,071,225, of which British and American societies each find about £2,000,000, and German societies £427,455.

(1) Carrying the Gospel to all the non-Christian world; (2) the Church in the mission field; (3) education in relation to the Christianization of national life; (4) the missionary message in relation to non-Christian religions; (5) the preparation of missionaries; (6) the home base of missions; (7) missions and governments; (8) co-operation and the promotion of unity. The reports on these subjects in eight volumes, together with a ninth volume giving the proceedings of the conference and a statistical atlas, will for some time be the medium of information on Christian missions, and precludes the need of any attempt at a bibliography here, an attempt which would indeed be doomed to failure. It may not, however, be out of place to call attention, in addition to literature already cited, to a few recent books, chiefly manuals, in several of which full lists of missionary books are given.

E. M. Bliss, *The Missionary Enterprise* (1908); E. Stock, *A Short Handbook of Missions* (1904); H. H. Montgomery, *Foreign Missions* (1904); T. Moscrop, *The Kingdom Without Frontiers* (1910); W. T. Whitley, *Missionary Achievement* (1908); S. L. Gulick, *The Growth of the Kingdom of God* (1897); B. Lucas, *The Empire of Christ*, a study of the missionary enterprise in the light of modern religious thought (1907); R. H. Malden, *Foreign Missions*, a study of some principles and methods (1910); G. Smith, *Short History of Christian Missions* (1897); G. Warneck, *Outline of a History of Protestant Missions* (1901; new German ed., 1910). See also J. S. Dennis, *Centennial Survey of Foreign Missions* (1902), *Christian Missions and Social Progress* (3 vols., 1897); G. Warneck, *Modern Missions and Culture* (1882); E. Stock, *History of the Church Missionary Society* (3 vols., 1899); J. B. Myers, *Centenary Volume of the Baptist Missionary Society* (1892); K. Lovett, *History of the London Missionary Society* (2 vols., 1899); J. Love, *Medical Missions, Their Place and Power*, a somewhat overlooked side of missions, viz. the "attempt to estimate the contribution of great races to the fulness of the Church of God," is presented in *Mankind and the Church*, edited by Bishop H. H. Montgomery (1907). *The Encyclopaedia of Missions* (2nd ed., 1904) edited by Bliss, Dwight and Tupper; *The Blue Book of Missions* by H. O. Dwight (1907); and the already mentioned *Statistical Atlas of Missions* (1910) by H. P. Beach, are all of the highest value. For Roman Catholic Missions see *Missiones Catholicae cura S. Congregationis de Propaganda Fide descriptae* (Romae, ex Typographia polygraphica S. C. Prop. Fid. [official ecclesiastical publication]) (1907), *Missiones Catholicae [au]stralis*, *Siedle* (Lyon, Bureau des Missions Catholiques, 14 Rue de la Charité, 1900); Piolet, *Les Missions Catholiques Françaises [au]x Indes*, *Siedle* (6 vols., Paris, A. Colin, 5 Rue des Mézières); H. A. Krose, *Katholische Missionsstatistik* (1908); K. Streit, *Katholischen Missionsstatistik* (1908).

(E. Sr; H. T. A.; A. J. G.)

MISSISSIPPI, a South Central state of the United States, situated between 35° N. lat. and 31° N. lat., with its S.E. part extending to the Gulf of Mexico, the extreme southern point being in 30° 13' N. lat. near the mouth of the Pearl River. On the E. the line is mostly regular, its extreme E. point being at 88° 7' W. long. in the N.E. corner of the state; the W. boundary has its extreme W. point at 91° 41' W. long. in the S.W. corner of the state. Mississippi is bounded N. by Tennessee, E. by Alabama, S. by the Gulf of Mexico and Louisiana, W. by Louisiana, from which it is separated by the Pearl River and by the Mississippi, and by Arkansas, from which also it is separated by the Mississippi. The total area is 46,865 sq. m., of which 503 sq. m. are water surface.

Physical Features.—Mississippi lies for the most part in the Mississippi embayment of the Gulf Coastal Plain. A feature of its surface is a strip of bottom land between the Mississippi and Yazoo rivers, known as the Yazoo Delta; it extends from north to south about 175 m., and has an average width of more than 60 m., and covers an area of about 7000 sq. m. With the exception of a few flat ridges running from north to south, it is so low that it requires, to protect it from overflows, an unbroken line of levees averaging 15 ft. in height; these were built and are maintained by the state in part from a special tax on the land and in part from the sale of swamp lands of the United States (under an act of 1850). Along the eastern border of this delta, and southward of it, along the Mississippi itself, extends a belt of hills or bluffs (sometimes called "cane-hills"), which is cut by deep ravines and, though very narrow in the north, has in the south an average width of about 10 m. East of the hills are level or gently rolling prairies, and along the Gulf Coast is a low, marshy tract. The highest elevations, from 800 to 1000 ft. above the sea, are on the Pontotoc ridge in Tippah and Union counties; and from this ridge there is an almost imperceptible slope south and west from the Appalachian Mountain system. Along the margins of valleys there are hills rising from 30 to 120 ft., but farther back from the water courses the differences of elevation are much less. The coast-line, about 85 m. long, is bordered by a beach of white sand, and broken by several small and shallow indentations, among which are St. Louis, Biloxi, Pascagoula and Point aux Chenes bays; separated from it by a shallow and protected bay, the considerable Mississippi Sound is a chain of low, long and narrow sand islands,

the largest of which are Petit Bois, Horn, Ship and Cat. The principal rivers are: the Mississippi on the western border, and its tributaries, the Yazoo and the Big Black; the Pearl and Pascagoula, which drain much of the southern portion of the state and flow into the Gulf; and the Tombigbee, which drains most of the north-eastern portion. The Pontotoc ridge separates the drainage system of the Mississippi from that of the Tombigbee; extending from the north-east coast part of the state southward, this ridge divides in Choctaw county, the eastern branch separating the drainage basin of the Pascagoula from that of the Pearl, and the western branch separating the drainage basin of the Pearl from that of the Big Black and the Mississippi. The Delta is drained chiefly by the Yazoo. A small area in the north-eastern corner of the state is drained northward by the Tennessee and the Hatchie. Each of the larger rivers is fed by smaller streams; their fall is usually gentle and quite uniform. The valleys vary in width from a few hundred yards to several miles. In the east of the state much of the valley of each of the larger streams is several feet above the stream's present high-water mark and forms the "hommock," or "second bottom" lands. Most of the rivers flowing into the Gulf are obstructed by sand bars and navigable only during high-water from January to April. Oxbow lakes and bayous are common only in the Delta.

Geology.—The older formations are nearly all overlaid by deposits of the Quaternary period, which will be described last. In the extreme north-east are found the oldest rocks of the state, lower Devonian (the New Scotland beds of New York) and, not so old, an extension of the Lower Carboniferous which underlies the Warrior coals of Alabama, and which consists of cherts, limestones, sandstones and shales, with a depth of 800 to 900 ft. The strata here show some traces of the upheaval which formed the Appalachian Mountain chain. When this chain formed the Atlantic mountain-border of the continent excepting this north-eastern corner, Mississippi had not emerged from the waters of the ancient Gulf of Mexico. As the shore line of the Gulf slowly receded southward and westward, the sediments at the bottom gradually came to the surface, and constituted the Cretaceous and Tertiary formations. Wherever stratification is observed in these formations in Mississippi, it shows a dip west and south of 20 or 30 ft. to the mile.

The Cretaceous region includes, with the exception of the Lower Carboniferous, all that part of the state eastward of a line cutting the Tennessee boundary in 88° 50' W. long., and drawn southward and eastward near Ripley, Pontotoc, and Starkville, crossing into Alabama in latitude 32° 45'. There are four formations of Cretaceous strata in Mississippi, defined by lines having the same general direction as the one just described. The oldest, bordering the Lower Carboniferous, is the Tuscaloosa formation, the strata being arranged as follows: dark clays, thin lignite seams, lignitic clays, sands and chert, and light clays; this formation is 5-15 m. wide and reaches from about 33° 30' on the Alabama boundary north to the Tennessee boundary. It is about 270 ft. thick. Tuscaloosa clays are used in the manufacture of pottery. Overlying the Tuscaloosa are the Eutaw sands, characterized by sandy laminated clays, and yellow, orange, red and blue sands, containing lignite and fossil resin. The Eutaw formation is a strip about 5 to 12 m. wide with a maximum depth of 300 ft. Westward to Houston and southward to about 32° 48' on the Alabama boundary, and occupying a much larger area than the other Cretaceous formations, is the Selma chalk called "Rotten Limestone" by Hilgard; it is made up of a material of great uniformity,—a soft chalky rock, white or pale blue, composed chiefly of tenacious clay, and white carbonate of lime in minute crystals. Borings show that the thickness of this group varies from 350 ft. in the north to about 1000 ft. at Starkville. Fossils are abundant, and forty species are recorded. The latest Cretaceous is the Ripley formation, which lies west of the northern part of the last-named, and, about Scooba, in a small strip, the most southerly of the Cretaceous—it is composed of coarse sandstones, hard crystalline white limestones, and shales, with thin beds of bluish and dark-coloured, micaceous, glauconitic marls; its greatest thickness is about 280 ft. Its marine fossils are admirably preserved, and one hundred and eight species have been described.

Deposits of the Tertiary period form the basis of more than half the state, extending from the border of the Cretaceous westward nearly to the Yazoo Delta and the Mississippi Bottom, and southward to within a few miles of the Gulf coast. Seven formations (or groups) of the Tertiary strata have been distinguished in Mississippi. The oldest is the Midway limestone and clays in a narrow belt in the western part of the state, nearly parallel to the western boundary of the Selma chalk; it includes the Clayton formation, characterized by the hard blue Turritella limestone (so named from the frequent fossil (*Turritella mortoni*)) and Porters Creek (previously called Flatwoods) clay, which is grey, weathering white, and is occasionally overlain by grey fossiliferous sandstone. The Wilcox formation (called Lignitic by Hilgard, and named by Safford the Lagrange group) lies to the west of the last, and its western limit is from about 32° 12' on the Alabama boundary about due north-west; in its north-westernmost part it is on the western edge of the Tertiary in this state. Its minimum depth is 850 ft. It is marked by grey clays and sands, lignitic fossiliferous clays, blue, lignitic or brown clay, sometimes 8 ft. in thickness, and brownish clays. The siliceous Claiborne

(or Tallahatta Buhström) formation lies south-westward from the last-named in a strip 10-30 m. wide, whose south-eastern extremity is the intersection of the 32nd meridian with the Alabama boundary, is characterized by beds of aluminous grey and white sandstone, aluminous and siliceous clay-stone, quartzitic sandstone, and green sand and marls. The calcareous Claiborne or Claiborne-Lisbon formation-group lies south of the last, in a wedge-like strip with the apex on the Alabama boundary; it is a series of clays and sands, richly fossiliferous. The Jackson formation south-west of the Lisbon bears the man up chiefly of grey calcareous clay marls, bluish lignitic clays, green-sand and grey siliceous sands. *Baculosa* (or *Zenagodon*) bones are found only in the Jackson marls, and other marine fossils are abundant. The minimum thickness of the formation is 240 ft. The Vicksburg formation lies next in order south-west, in a narrow strip of fairly regular width which alone of the Tertiary formations runs as far west as the Mississippi River; it is probably nowhere more than 110 ft. deep. It is characterized by semi-crystalline limestones and blue and white sandy marls. Marine fossils are very abundant in the marl. The Grand Gulf group, of formations of different ages, consisting of sands, sandstones and clays, and showing a few fossil plants, but no marine fossils, extends south-westward from the last to within a few miles of the coast, and is 750-800 ft. deep.

The older formation of the Quaternary period is the Lafayette (also called "Orange-sand" or "stratified drift"), which immediately overlies all the Cretaceous groups except the prairies of the Selma chalk, and all the Tertiary except the Porters Creek and Vicksburg formations and parts of the Jackson. Its depth varies from a few feet to over 200 ft. (in the southern part of the state), and it forms the body of most of the hills in the state. Its materials are pebbles, clays and sands of various colours from white to deep red, tinged with peroxide of iron, which sometimes cements the pebbles and sands into compact rocks. The shapes of these ferruginous sandstones are very fantastic—tubes, hollow spheres, plates, &c., being common. The name stratified drift has been used to indicate its connexion with the northern drift. The fossils are few, and in some cases probably derived from the underlying formations. Well-worn pebbles of amorphous quartz (agate, chalcedony, jasper, &c.) are found in the stratified drift along the western side of the Tertiary region of the state, and from Columbus northward. The second Quaternary formation is the Port Hudson, occurring within 20 m. of the Gulf coast, and, with alluvium, in the Yazoo Delta. Heavy clays, gravel and sands, containing cypress stumps, drift-wood and mastodon bones, are characteristic. The loess or bluff formation lies to the north-west of the Port Hudson, and extends continuously through the state. Its fine-grained, unstratified silt contains the remains of many terrestrial animals, including fifteen mammals.

Fauna.—Among the more common species of game are squirrels, opossums, musk-rats, rabbits, racoons, wild turkeys, "partridges" (quail, or Bob White), geese, and ducks; deer, black bears, grey (or timber) wolves, black wolves and "wild cats" (lynx), once common, have become rare. Alligators inhabit the southern river-bottoms, and there are some rattlesnakes on the uplands. Among a great variety of song-birds the mocking-bird is prominent; the parakeet is found in the southern part of the state. Cat-fish, paddle-fish, cat-fish, drum, crappie, black bass, rock bass, German carp, sturgeon, pike, perch, eels, suckers and shrimp inhabit the waters of the Mississippi and its tributaries, and oysters, shrimp, trout, Spanish mackerel, channel bass, black bass, sheepshead, mullet, croakers, pompano, pin-fish, blue-fish, flounders, crabs and terrapin are obtained from the Mississippi Sound and the rivers flowing into it.

Flora.—Originally Mississippi was almost entirely covered with a growth of forest trees of large size, mostly deciduous; and in 1900 about seven-tenths of its area was still classed as timber-land. The north-central part of the state, known as the "flat woods," is level and heavily forested. There are more than 120 species of trees in the state, 15 of oak alone. The most valuable species for lumber are the long-leaf pine which is predominant in the low southern third of the state, sometimes called the "cow-country"; the short-leaf pine, found farther north; the white oak, quite widely distributed; cotton-wood and red gum, found chiefly on the rich alluvial lands; and the cypress, found chiefly in the marshes of the Delta. The beautiful live oaks and magnolias grow only in the south of the state; the holly in the lowlands; and the finest species of pecan, in the Delta. The sassafras, persimmon, wild cherry and Chickasaw plum are found in all parts of the state. The grape, *Ogechee* lime (*Nyssa cypripata*) and pawpaw are also native fruits. Among indigenous shrubs and vines are the black-berry, dewberry, strawberry, yellow jasmine, mistletoe and poison-oak; and among medicinal herbs are horshound, ginger and pepper-mint. Here, too, grows Spanish moss, used by upholsters.

Climate.—The southern latitude, the low elevation and the proximity to the Gulf of Mexico produce in southern Mississippi a rather mild and equable climate, but to the northward the extremes increase. The normal annual temperature for the state is 64° F.; on the coast it is 67° F., and on the northern border it is 61° F. During a period of twenty years, from January 1887 to December 1906, extremes of temperature at Biloxi, on the coast, ranged from 1° F. to 100° F.; during nearly the same period at Pontotoc, in the north-eastern part

of the state, they ranged from -11° F. to 105° F. The greatest extremes recorded were -15° F. at Aberdeen, Monroe county, on the 13th of February 1899, and 107° F. at several places in July and August of different years. January is the coldest month, and July is the warmest. During the winter the normal temperature decreases quite steadily from south to north; thus the mean temperature in January at Biloxi is 51° F., at Meridian, in the east central part, it is 46° F., and at Pontotoc it is 43° F. But during the summer, temperatures are affected as much by altitude as by latitude, and the coast is cooled at night by breezes from the Gulf. The July mean is 82° F. at several places in the southern part of the state, and at Yazoo city, in the west central part, it is 83° F. The normal annual precipitation for Mississippi is about 51 in.; for the southern half, 54 in., and for the northern half, 49 in. An average of 4 in. of snow falls in the northern half, but south of Natchez snow is seldom seen. Nearly one-third of the rain falls in January, February and March; July, also, is one of the wet months. The driest season is in September and October. The prevailing winds are from the south-east; but the rain-bearing winds are chiefly from the south-west, and the high winds from the west and north-west.

Soils.—The most fertile soil is the alluvium of the Delta, deposited during the overflow of the Mississippi. Others that are exceedingly productive are the black calcareous loam of the prairies, the calcareous silt of the bluff belt along the eastern border of the Delta, and the brown loam of the tableland in the central part of the state. Of inferior quality are the yellow loam of the hills in the north-east and the sandy loam in the pine belt of the south. Throughout the southern portion sand is a large ingredient, and to the northward there is more or less lime.

Agriculture.—Mississippi is devoted largely to the cultivation of cotton. Of the total land area of the state, 18,240,736 acres (61.3%) were, in 1900, included in farms, and the improved farm land in 1900 was 4,209,146 acres in 1870 to 7,594,428 acres (41.6% of all farm land in 1900). After the abolition of slavery, farms greatly decreased in size and increased in number; the number was 68,023 in 1870 to 220,803 in 1900; the average size fell from 369.7 acres in 1860 to 82.6 acres in 1900. Of the total number of farms in 1900, 81,412 were worked by owners or part owners (60,585 by whites and 20,827 by negroes); 70,699 were worked by cash tenants (13,505 by whites and 57,194 by negroes); and 67,153 were worked by share tenants (16,748 by whites and 50,405 by negroes).

The acreage of cotton increased from 2,106,215 acres in 1879 to 3,220,000 in 1907; the yield increased from 936,111 bales in 1879 to 1,468,177 bales in 1907. Cotton is grown in every county of the State, but the greatest quantities are raised in Delta (Bolivar, Coahoma, Washington, Yazoo and Lefflore counties), the greatest cotton-producing region of the world, and in Monroe, Lowndes and Noxubee counties on the Alabama border. The acreage of Indian corn in 1907 was 2,500,000 acres and the crop 42,500,000 bushels. The production of other cereals decreased during the latter half of the 19th century: oats, from 1,959,620 bushels in 1879 to 1,611,000 bushels in 1907; wheat, from 587,925 bushels in 1859 to 22,000 in 1907; rye, from 39,474 bushels in 1859 to 963 bushels in 1899, after which year the crop has been negligible; and rice, from 2,719,856 lb in 1849 to about 1,080,000 lb in 1907. The largest Indian-corn producing districts are nearly the same as those which produce the most cotton; oats and wheat are grown chiefly in the north-eastern quarter of the state, and rice in the south-western quarter.

Between 1850 and 1907 dairy cows increased from 214,231 to 330,000; other neat cattle from 519,739 to 589,000; sheep decreased from 304,929 to 181,000; swine decreased from 1,582,734 to 1,316,000; horses increased from 115,460 to 260,000, and mules from 54,547 to 279,000.

Sugar-cane is grown principally in the southern part of the state, but sorghum-cane is grown to some extent in nearly every county. Sweet potatoes, white potatoes and onions also are important crops. The greatest relative advantage between 1889 and 1899 in any of the agriculture was made in the growth of market-garden produce and small fruits; for old pine lands, formerly considered useless, had been found valuable for the purpose. The number of orchard trees increased nearly 100% within the same decade. At Crystal Springs tomatoes were first successfully grown for the market (1874-1876). Orchard trees and grape-vines are widely distributed throughout the state, but with the exception of peaches their yield is greater in the northern portion.

Lumber.—Mississippi ranks high among the southern states in the production of lumber. Its timber-land in 1900 was estimated at 37,300 sq. m. From the extreme south most of the merchantable timber had been cut, but immediately north of this there were still vast quantities of valuable long-leaf pine; in the marshes of the Delta was much cypress, the cotton-wood was nearly exhausted, and the gum was being used as a substitute for it; and on the rich upland soil were oak and red gum, also cotton-wood, hickory and maple. The lumber and timber product increased in value from \$1,920,335 in 1880 to \$24,035,539 in 1905. Pine stumps and waste limbs are utilized, notably at Hattiesburg, for the manufacture of charcoal, tar, creosote, turpentine, &c.

Fisheries.—Fishing is a minor industry, confined for the most part to the Mississippi Sound and neighbouring waters and to the Mississippi and Yazoo rivers. The most valuable branch is the oyster

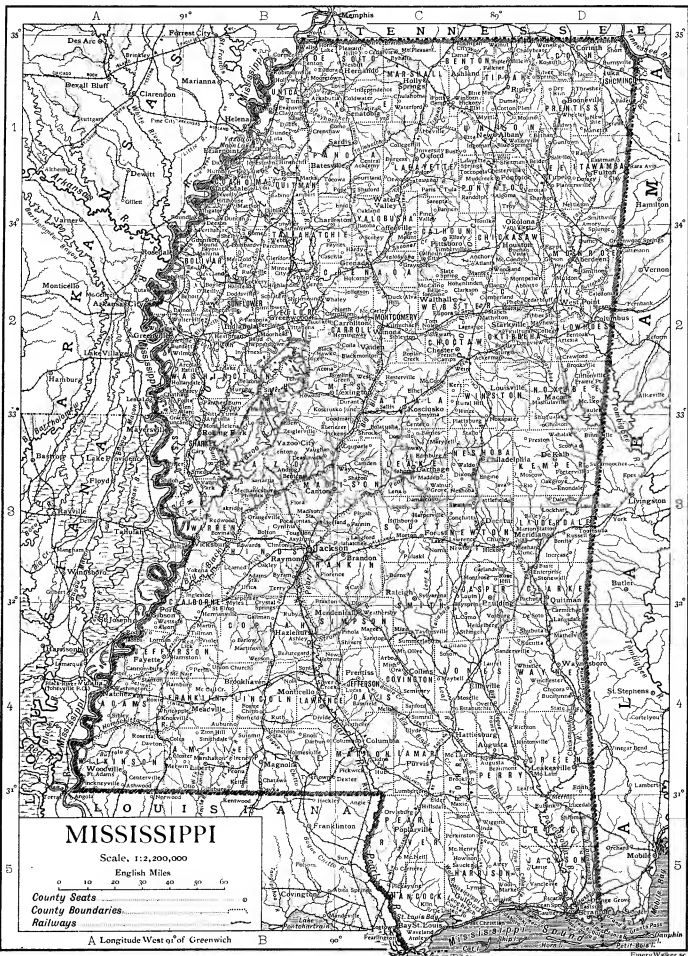

MISSISSIPPI

Scale: 1:2,200,000

English Miles

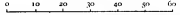

- County Seats
- County Boundaries
- Railroads

A Longitude West of Greenwich B

fishery on the reefs in the Sound, much developed since 1880. The shrimp fishery, too, grew during the same period. About 40% of the total catch of the state is made by the inhabitants of Harrison county on the Gulf of Mexico.

Minerals.—The mineral wealth of the state is limited. Clays and mineral waters are, however, widely distributed. Large quantities of mineral water, sulphur, chalybeate and lithia, bottled at Meridian, Raymond and elsewhere, are sold annually. The state contains deposits of iron, gypsum, marl, phosphate, lignite, ochre, glass-sand, tripoli, fuller's earth, limestones and sandstones; and there are small gas flows in the Yazoo Delta.

Manufactures.—The lack of mineral resources, especially of coal and iron, of a good harbour (until the improvement of Gulfport), and of an adequate supply of labour has discouraged most kinds of manufacturing. The value of the total factory product was \$57,451,445 in 1905, when a little more than three-fourths was represented by lumber and timber products, cotton-seed oil and cake, and cotton goods. The leading manufacturing centres are Meridian, Vicksburg, Jackson, Natchez and Biloxi.

Transport.—Along the entire western border of the state the Mississippi River is navigable for river steamboats. On the southern border, the Mississippi Sound affords safe navigation for small coasting vessels and from Gulfport (13 m. S.W. of Biloxi) to Ship Island, which has one of the best harbours on the entire Gulf Coast, the Gulf & Ship Island Railroad Company, with the co-operation of the United States Government, in 1901 began to dredge a channel 300 ft. wide and 19 ft. at mean low water, and to construct an anchorage basin (completed in 1906) at Gulfport, $\frac{3}{4}$ m. long and $\frac{1}{2}$ m. wide, and 19 ft. deep. In June 1908 the maximum low-water draft of the channel and the basin was 19 ft. The Gulfport project reduced freight rates between Gulfport and the Atlantic seaboard cities and promoted the trade of Gulfport, which is the port of entry for the Pearl River customs district. Its imports for 1909 were valued at \$82,028 and its exports at \$8,581,471. The Yazoo, Tallahatchie, Yalobusha, Sunflower, Big Black, Pascagoula and Pearl rivers are also navigable to a limited extent. The first railway in Mississippi was completed from Vicksburg to Clinton in 1840, but the state had suffered severely from the panic of 1837, and in 1850 it had only 75 m. of railway. This was increased to 862 m. by 1860. The Civil War then interfered, and in 1880 the mileage was only 1127 m. During the next decade it was a little more than doubled, and at the close of 1908 it was 3916.85 m. The principal lines are the Illinois Central, the Yazoo & Mississippi Valley, the Southern, the Mobile & Ohio, the New Orleans & North-eastern, the Kansas City, Memphis & Birmingham, the Mobile, Jackson & Kansas City, the Alabama & Vicksburg, and the Gulf & Ship Island.

Population.—The population increased from 1,131,597 in 1880¹ to 1,289,600 in 1890, of 14% within the decade, and by 1900 it had grown to 1,551,270 (90.48% native-born), and by 1910 to 1,797,114. The density of population in 1900 was 33.5 per sq. m.; 641,200, or 41.3%, were whites; 907,030, or 58.5%, were negroes; 2203 were Indians, and 237 were Chinese; in eight counties of the Delta the ratio of negroes to whites was almost 7 to 1. The Indians are descendants of the Choctaw tribe; they are all subject to taxation, and most of them live in the east central part of the state. The principal religious denominations are the Baptist (371,518 in 1906) and the Methodist (212,105 in 1906). The cities and towns having a population in 1900 of 4000 or more were: Vicksburg, Meridian, Natchez, Jackson, Greenville, Columbus, Biloxi, Yazoo City, McComb and Hattiesburg.

Government.—The chief special object of the present constitution, adopted on the 1st of November 1890, was to preserve in a legal manner the supremacy of the whites over the ignorant negro majority. In addition to the ordinary suffrage qualifications of age, sex, and residence, the voter must have paid all taxes due from him for the two years immediately preceding the election, and he must be able to read any section of the constitution or "be able to understand the same when read to him, or give a reasonable interpretation thereof." The former provision, strengthened by a poll-tax for school purposes assessed on adult males, affects both white and blacks; the latter, owing to the discretion vested in the election officers, affects (in practice) mainly the blacks. The chief executive officials are the governor, lieutenant-governor, secretary of state, treasurer, auditor, attorney-general, and superintendent of education. All are chosen for terms of four years, and the governor, treasurer, and auditor are ineligible for immediate re-election.

¹ The population at each of the preceding censuses was: 8850 in 1840; 40,352 in 1850; 75,448 in 1860; 136,621 in 1870; 375,651 in 1880; 606,526 in 1890; 791,305 in 1890; and 827,922 in 1870.

The method of election is peculiar, being based in part upon the national presidential model. Each county or legislative district casts as many electoral votes as it has members in the state house of representatives, and a majority of both the electoral and the popular vote is required. If no one has such a majority, the house of representatives chooses one of the two who have received the highest number of popular votes; but this is really a provision never executed, as the Democratic nominees are always elected without any serious opposition. The governor is empowered to call extraordinary sessions of the legislature, to grant pardons and reprieves, and to exercise a power of veto which extends to items in appropriation bills; a two-thirds majority of the legislature is necessary to pass a bill over his veto. His appointing power is not very extensive, as nearly all officials, except judges, are elected by popular vote.

The legislature consists of a senate and a house of representatives, chosen every four years. It meets in regular session quadrennially, in special sessions in the middle of the interval to pass the appropriation and revenue bills, and in extraordinary session whenever the governor sees fit to call it. Revenue measures may originate in either house, but a three-fifths vote in each is necessary to their enactment. The constitution goes into minute detail in prohibiting local, private and special legislation.

The judiciary consists of a supreme court of three judges, thirteen (1908) circuit courts, seven (1908) chancery courts, county courts and justice of the peace courts. Under the constitution of 1890 the governor, with the consent of the senate, appoints supreme court judges for a term of nine years, and circuit and chancery judges for four years. The local judicial authorities are the county board of supervisors of five members and the justices of the peace.

The other county officials are the sheriff, coroner, treasurer, assessor, surveyor and superintendent of education. The superintendent is chosen by the state board of education except in those counties (now all or nearly all) in which the legislature has made the office elective. The courts have interpreted this to mean that the manner of selection need not be uniform (*Wynn v. State*, 67 Miss. 312), a rule which would possibly apply to other local offices. The intention seemed to be to permit the appointment of officials in counties and districts where there was any likelihood of negro supremacy.

Mississippi has taken a leading part in the movement to bring about the removal of the common law disabilities of married women, the first statute for that purpose having been passed in 1839. Under the present constitution they are "fully emancipated from all disability on account of coverture," and are placed on an equality with their husbands in acquiring and disposing of property and in making contracts relative thereto. A divorce may be granted only to one who has lived for at least one year in the state; among the recognized causes for divorce are desertion for two years, cruelty, insanity or physical incapacity at time of marriage, habitual drunkenness or excessive use of opium or other drugs, and the conviction of either party of felony. The homestead of a householder (with a family) who occupies it may be held exempt from sale for the collection of debts other than those for purchase-money, taxes, or improvements, or for the satisfaction of a judgment upon a forfeited recognizance or bail-bond, but a homestead so exempted is limited to \$5000 in value and to 160 acres of land. A considerable amount of personal property, including furniture, a small library, provisions, tools, agricultural implements, livestock and the proceeds of a life insurance policy, is also exempt from seizure for the satisfaction of debts. Since 1909 the sale of intoxicating liquors has been prohibited by statute.

Penal and Charitable Institutions.—The penitentiary at Jackson was established under an Act of 1836, was erected in 1838-1839, was opened in 1840, was burned by the Federals in 1863, and was rebuilt in 1866-1867. The board of control is composed of the governor, attorney-general and the three railroad commissioners. The convict lease system was abolished by the constitution of 1890 (the provision to take effect on the 31st of December 1894), and state farms were purchased in Rankin, Hinds and Holmes counties. As these were insufficient to give employment to all the prisoners, some were put to work on Yazoo Delta plantations on partnership contracts. Under an act of 1900, however, 13,880 acres of land were purchased in Sunflower county, and the land at Tchula, Holmes county, and at Oakley, Hinds county, the negro convicts—the white convicts are on the Rankin county farm—are kept on several large plantations, with saw-mills, cotton gins, &c. Under a law of 1906 these farm penitentiaries are controlled by a board of three trustees, elected by the people; they are managed by a superintendent.

appointed once every four years by the governor. The charitable institutions of the state are supervised by separate boards of trustees appointed by the governor. The state insane hospital, opened at Jackson in 1856 (act of 1848), in time became overcrowded and the East Mississippi insane hospital was opened, 2 m. west of Meridian in 1885 (act of 1882). The state institution for the education of the deaf and dumb (1854) and the state institution for the blind (1848) are at Jackson. State aid is given to the hospitals at Vicksburg and Natchez.

Education.—Educational interests were almost entirely neglected during the colonial and territorial periods. The first school established in the state was Jefferson College, now Jefferson Military College, near Natchez, Adams county, incorporated in 1802. Charters were granted to schools in Claiborne, Wilkinson and Amite counties in 1809–1815, and to Port Gibson Academy and Mississippi College, at Clinton, in 1826. The public school system, established in 1846, never was universal, because of special legislation for various counties; public education was retarded during the Civil War and the Reconstruction period (when immense sums appropriated for schools were grossly mismanaged), but conditions gradually improved after 1875, especially through the concentration of schools. The sessions are still too short, teachers are poorly paid and attendance is voluntary. The long lack of normal training for white teachers (from 1870 to 1876 there was a normal school for negroes at Holly Springs) lasted until 1890, when a teacher's training course was introduced into the curriculum of the state university. There are separate schools for whites and blacks, and the equipment and service are approximately equal, although the whites pay about nine-tenths of the school taxes. The schools are subject to the supervision of a state superintendent of public education and of a board of education, composed of the superintendent, the secretary of state, and the attorney-general, and within each county to a county superintendent. The schools are supported by a poll-tax, by general appropriations, by local levies, and by the Chickasaw school fund. An act of Congress of the 3rd of March 1803 reserved from sale sixteen of the public lands in each township for educational purposes. When the Chickasaws ceded their lands to the national government, in 1830 and in 1832, the state made a claim to the sixteenth sections, and finally in 1856 received 174,550 acres—one thirty-sixth of the total cession of 6,283,804 acres. The revenue derived from the sales and leases of this land constitutes an endowment fund upon which the state as trustee pays 6% interest. It is used for the support of the schools in the old Chickasaw territory in the northern part of the state.

Among the institutions for higher education are the university of Mississippi (chartered 1844; opened 1848), at Oxford, which was opened to women in 1882; the Agricultural and Mechanical College (opened 1880), at Agricultural College, near Stennisville, and the Industrial Institute and College for Girls (opened 1885), at Columbus; and the Alcorn Agricultural and Mechanical College for negroes (1871; reorganized in 1878), at Westside. In 1819 Congress granted thirty-six sections of public land for the establishment of a university. This land was sold in 1833 for \$277,332.52, but the entire sum was lost in the failure of the Planters' Bank in 1840. In 1880 the state assumed liability for the full amount plus interest, and this balance, \$544,061.23, now constitutes an endowment fund, upon which the state pays 6% interest. Congress granted another township (thirty-six sections) for the university in 1892, and its income is supplemented by legislative appropriations for current expenses and special needs. The two agricultural and mechanical colleges were founded by the sale of public lands given by Congress under the Morrill Act of 1862. An agricultural experiment station established in 1887 under the Hatch Act, is at Agricultural College; and there are branch experiment stations at McNeill, Pearl River county (1906), near Holly Springs, and at Stennisville, near Greenville.

Finance.—The chief sources of revenue are taxes on realty, personality and corporations, a poll-tax, and licences. The more important expenditures are for public schools, state departments, educational and charitable institutions and pensions for Confederate veterans. The early financial history of the state is not very creditable. The Bank of Mississippi, at Natchez, incorporated by the Territorial legislature in 1809, was rechartered by the state in 1818, and guaranteed a monopoly of the banking business until 1840. In violation of this pledge, and in the hope that a new bank would be more tractable than the Bank of Mississippi, the Planters' Bank was established at Natchez, in 1830, with a capital of \$3,000,000, two-thirds of which was subscribed by the state. During the wild era of speculation which followed (especially in 1832—upon the opening of the Chickasaw Cession to settlement) a large number of banks and railroad corporations with banking privileges were chartered. The climax was reached in 1838 with the incorporation of the Union Bank. This, the most pretentious of all the state banks of the period, was capitalized at \$15,500,000. The state subscribed \$5,000,000, which was raised on bonds sold to Nicholas Biddle, president of the United States Bank of Pennsylvania. As the Union Bank was founded in the midst of a financial panic and was mismanaged, its failure was a foregone conclusion. Agitation for repudiation was begun by Governor A. G. McNutt (1801–1848), and that question became the chief issue in the gubernatorial campaign of 1841,

Tilghman M. Tucker (1802–1859), the Democratic candidate, representing the repudiators and David O. Shattuck, Whig, representing the anti-repudiators. The Democrats were successful, and the bonds were formally repudiated in 1842. In 1853 the High Court of Appeals and Errors of the state in the case of *Mississippi v. Hession Johnson* (35 *Miss. Reports*, 625) decided unanimously that nothing could absolve the state from its obligation. The decision was disregarded, however, and in the same year the Planters' Bank bonds were also repudiated by popular vote. These acts of repudiation were sanctioned by the constitution of 1890. The \$7,000,000 saved in this manner has doubtless been more than offset by the additional interest charges on subsequent loans, due to the loss of public confidence. Mississippi suffered less than most of the other Southern states during the Reconstruction period; but expenditures rose from \$463,219.71 in 1869 to \$1,729,046.34 in 1871. At the close of the Republican régime in 1876 its total indebtedness was \$2,631,704.24, of which \$814,743 belonged to the Chickasaw fund (see above) and \$718,946.22 to the general school fund. As the principal of these funds is never to be paid, the real debt was slightly over \$1,000,000. On the 1st of October 1907 the payable debt was \$1,253,029.07, the non-payable \$2,336,197.58, a total of \$3,589,226.65. Since the Civil War the banking laws have become more stringent, and the national banks have exercised a wholesome influence. There were, in 1906, 24 national banks and 269 state banks, but no trust companies, private banks or savings banks.

History.—At the beginning of the 16th century the territory included in the present state of Mississippi was inhabited by three powerful native tribes: the Natchez in the south-west, the Choctaws in the south-east and centre, and the Chickasaws in the north. In addition, there were the Yazoois in the Yazoo valley, the Pascagoulas, the Biloxis, and a few weaker tribes on the borders of the Mississippi Sound. The history of Mississippi may be divided into the period of exploration (1540–1699), the period of French rule (1699–1763), the period of English rule (1763–1781), the period of Spanish rule (1781–1798), the territorial period (1798–1817), and the period of statehood (1817 seq.).

Hernando de Soto (*q.v.*) and a body of Spanish adventurers crossed the Tombigbee river, in December 1540, near the present city of Columbus, marched through the north part of the state, and reached the Mississippi river near Memphis in 1541. In 1673 a French expedition organized in Canada under Jacques Marquette and Louis Joliet sailed down the Mississippi to the mouth of the Arkansas, and nine years later (1682) René Robert Cavalier, sieur de la Salle, reached the mouth of the river, took formal possession of the country which it drains, and named it Louisiana in honour of Louis XIV. The first European settlement in Mississippi was founded in 1699 by Pierre Lemoine, better known as Iberville, at Fort Maurepas (Old Biloxi) on the north side of Biloxi Bay, in what is now Harrison county. The site proving unfavourable, the colony was transferred to Twenty-seven Mile Bluff, on the Mobile River, in 1702, and later to Mobile (1710). The oldest permanent settlements in the state are (New) Biloxi (*c.* 1712), situated across the bay from Old Biloxi and nearer to the Gulf, and Natchez or Fort Rosalie (1716). During the next few years Fort St Peter and a small adjoining colony were established on the Yazoo River in Warren county, and some attempts at settlement were made on Bay St Louis and Pascagoula Bay. The efforts (1712–1721) to foster colonization and commerce through trading corporations established by Antoine Crozat and John Law failed, and the colony soon came again under the direct control of the king. It grew very slowly, partly because of the hostility of the Indians and partly because of the incapacity of the French as colonizers. In 1729–1730 the Natchez tribe destroyed Fort St Peter, and some of the small outposts, and almost destroyed the Fort Rosalie (Natchez) settlement.

At the close of the Seven Years' War (1763) France ceded to Great Britain all her territory east of the Mississippi except New Orleans, and Spain ceded Florida to Great Britain. By a royal proclamation (Oct. 7, 1763) these new possessions were divided into East Florida and West Florida, the latter lying S. of the 31st parallel and W. of the Chattahoochee and Apalachicola rivers. Crown orders of 1764 and 1767 extended the limits N. to

¹ The increase is due mainly to the assumption of the university obligations in 1880.

a line due E. from the mouth of the Yazoo at about 32° 28' N. lat. Under English rule there was an extensive immigration into this region from England, Ireland, Georgia and South Carolina. A settlement was made on the Big Black, 17 m. from its mouth, in 1774 by Phineas Lyman (1716-1774) of Connecticut and other "military adventurers," veterans of the Havana campaign of 1762; this settlement was loyal during the War of Independence. Spain took military possession in 1781, and in the Treaty of Paris (1783) both of the Floridas were ceded back to her. But Great Britain recognized the claims of the United States to the territory as far south as the 31st parallel, the line of 1763. Spain adhered to the line of 1764-1767, and retained possession of the territory in dispute. Finally, in the treaty of San Lorenzo el Real (ratified 1796) she accepted the 1763 (31°) boundary, and withdrew her troops in 1798. Mississippi Territory was then organized, with Winthrop Sargent as governor. The territorial limits were extended on the north to the state of Tennessee in 1804 by the acquisition of the west cessions of South Carolina and Georgia, and on the south to the Gulf of Mexico by the seizure of West Florida in 1810-1813,¹ but were restricted on the east by the formation of the Territory of Alabama in 1817. Just after the uprising of 1720-1730 the French, with the help of the Choctaws, had destroyed the Natchez nation, and the shattered remnants were absorbed by the neighbouring tribes. The Chickasaws ceded their lands to the United States in 1816 and the Choctaws theirs in 1830-1832; and they removed to the Indian Territory. The smaller tribes have been exterminated, absorbed or driven farther west.

An Enabling Act was passed on the 1st of March 1817, and the state was formally admitted into the Union on the 10th of December. The first state constitution (1817) provided a high property qualification for governor, senator and representative, and empowered the legislature to elect the judges and the more important state officials. In 1822 the capital was removed to Jackson from Columbia, Marion county.² The constitution of 1832 abolished the property qualification for holding office and provided for the popular election of judges and state officials. Mississippi thus became one of the first states in the Union to establish an elective judiciary.³ The same constitution prohibited the importation of negro slaves from other states; but this prohibition was never observed, and the United States Supreme Court held that it was ineffective without an act of the legislature. On the death of John C. Calhoun in 1850 the state, under the leadership of Jefferson Davis, began to rival South Carolina as leader of the extreme pro-slavery States' Rights faction. There was a brief reaction: Henry Stuart Foote (1800-1880), Unionist, was elected governor in 1851 over Davis, the States' Rights candidate, and in the same year a Constitutional Convention had declared almost unanimously that "the asserted right of secession" . . . "is utterly unsanctioned by the Federal Constitution." But the particularistic sentiment continued to grow. An ordinance of secession was passed on the 9th of January 1861, and the constitution was soon amended to conform to the new constitution of the Confederate States. During the Civil War battles were fought at Corinth (1862), Port Gibson (1863), Jackson (1863) and Vicksburg (1863). In 1865 President Johnson appointed as provisional governor William Lewis Sharkey (1797-1873), who had been chief justice of the state in 1832-1850, and a convention which assembled on the 14th of August recognized the "destruction" of slavery and declared the ordinance of secession null and void. The first reconstruction legislature met on the 16th of October 1865, and at once proceeded to enact stringent vagrancy laws and other measures against the freedmen; these laws the North

interpreted as an effort to restore slavery. Under the Reconstruction Act of the 2nd of March 1867 Mississippi with Arkansas formed the fourth military district, commanded successively by Generals E. O. C. Ord (1867), Alvan C. Gillem (1868) and Irvin McDowell (June-July 1868), and by Gillem (1868-1869) and Adelbert Ames (1869-1870). The notorious "Black and Tan Convention" of 1868 adopted a constitution which conferred suffrage upon the negroes and by the imposition of test oaths disfranchised the leading whites. It was at first rejected at the polls, but was finally ratified in November 1869 without the disfranchising clauses. The fourteenth and fifteenth amendments to the Federal Constitution were ratified in 1870, and the state was formally readmitted into the Union on the 23rd of February of that year.

From 1870 to 1875 the government was under the control of "carpet-baggers," negroes and the most disreputable element among the native whites. Taxes were increased—expenditure increased nearly threefold between 1869 and 1871—and there was some official corruption; but the state escaped the heavy burden of debt imposed upon its neighbours, partly because of the higher character of its reconstruction governors, and partly because its credit was already impaired by the repudiation of obligations contracted before the war. The Democrats carried the legislature in 1875, and preferred impeachment charges against Governor Adelbert Ames (b. 1835), a native of Maine, a graduate of the United States Military Academy (1861), a soldier in the Union army, and military governor of Mississippi in 1868-1870. The lieutenant-governor, A. K. Davis, a negro, was impeached and was removed from office; T. W. Cardoza, another negro, superintendent of education under Ames, was impeached on twelve charges of malfeasance, but was permitted to resign. Governor Ames, when the impeachment charges against him were dismissed on the 20th of March 1876, immediately resigned. The whites maintained their supremacy by very dubious methods until the adoption of the constitution of 1890 made it no longer necessary. The state has always been Democratic in national politics, except in the presidential elections of 1840 (Whig) and 1872 (Republican). The electoral vote was not counted in 1864 and 1868.

GOVERNORS

Territorial Period (1798-1817).

Winthrop Sargent	1798-1801
William C. C. Claiborne	1801-1805
Robert Williams	1805-1809
David Holmes	1809-1817

Statehood Period (1817 seq.).

David Holmes	Democrat	1817-1820
George Poindexter		1820-1822
Walter Leake	Democrat (died in office)	1822-1825
Gerard C. Brandon (ad int.)	Democrat	1825-1826
David Holmes	Democrat (resigned)	1826
Gerard C. Brandon (ad int. 1826-1828)		1826-1832
Abram M. Scott	Democrat (died in office)	1832-1833
Charles Lynch ⁴ (ad int.)	Democrat	1833
Hiram G. Runnels		1833-1835
John Anthony Quitman (ad int.)	Whig	1835-1836
Charles Lynch	Democrat	1836-1838
Alexander Gallatin McNutt	"	1838-1842
Tilghman M. Tucker	"	1842-1844
Albert Gallatin Brown	"	1844-1848
Joseph W. Matthews	"	1848-1850
John Anthony Quitman ⁵	"	1850-1851
John Isaac Guion ⁶ (ad int.)	"	1851
James Whitfield (ad int.)	"	1851-1852
Henry Stuart Foote	Unionist	1852-1854
John Jones Pettus ⁷ (ad int.)	Democrat	1854
John J. McRae	"	1854-1857
William McWillie	"	1857-1859
John Jones Pettus	"	1859-1863

¹ Under the constitution of 1832 the president of the senate succeeded the governor in case of a vacancy.

² Governor Quitman resigned because of charges against him of aiding Lopez's expedition against Cuba.

³ On the 4th of November the term for which Guion had been elected as a senator expired and he was succeeded in the governorship by Whitfield, elected by the senate to be its president.

⁴ Served from the 5th of January (when Foote resigned) to the 10th, when McRae was inaugurated.

¹ South Carolina ceded its western lands to the United States in 1787 and Georgia in 1802. The government added them to Mississippi in 1804. The seizure of West Florida was supplemented by the treaty of 1819-1821, in which Spain surrendered all of her claims.

² The seats of government have been Natchez (1798-1802), Washington (1802-1817), Natchez (1817-1821), Columbia (1821-1822), Jackson (1822-sec.).

³ This system proved unsatisfactory, and in 1869 was abandoned.

Charles Clark ¹	Democrat	1863-1865
William Lewis Sharkey	Provisional	1865
Benjamin Grubb Humphreys ²	Republican	1865-1868
Adelbert Ames	Republican (Military Governor)	1868-1870
James Lusk Alcorn ³	Republican	1870-1871
Ridley Ceylon Powers (ad int.)	"	1871-1874
Adelbert Ames ⁴	"	1874-1876
John Marshall Stone (ad int. 1876-78)	Democrat	1876-1882
Robert Lowry	"	1882-1890
J. M. Stone	"	1890-1896
Anselm Joseph McLaurin	"	1896-1900
Andrew Houston Longino	"	1900-1904
James Kimble Vardaman	"	1904-1908
Edmund Favor Noel	"	1908

See T. A. Owen, "A Biography of Mississippi," in the *Annual Report of the American Historical Association, 1890*, i. 533-828 (Washington, 1900); "Report of the Mississippi Historical Commission" in the *Publications of the Mississippi Historical Society*, v. 52-310 (Oxford, Miss., 1902). J. F. H. Claiborne's *Mississippi as a Province, Territory and State* (Jackson, 1880), gives the best account of the period before the Civil War. R. Lowry and W. H. McCardle, *History of Mississippi* (New York, 1893), is useful for local history. Of most value for the history are the writings of P. J. Hamilton, J. W. Garner and F. L. Riley. Hamilton's *Colonial Mobile* (Boston and New York, 1898), and the *Colonization of the South* (Philadelphia, 1904) are standard authorities for the French and English periods (1699-1781). Garner's *Reconstruction in Mississippi* (New York, 1902) is judicial, scholarly and readable. Most of Riley's work is in the *Publications of the Mississippi Historical Society* (Oxford, 1898 seq.), which he edited; see his *Spanish Policy in Mississippi after the Treaty of San Lorenzo*, i. 50-66; *Location of the Boundaries of Mississippi*, iii. 167-184; and *Transition from Spanish to American Rule in Mississippi*, iii. 261-311. There is much material in the *Encyclopaedia of Mississippi History* (2 vols., Madison, Wisconsin, 1907), edited by Dunbar Rowland. There is a state Department of Archives and History.

MISSISSIPPI + RIVER, the central artery of the river system which drains the greater part of the United States of America lying between the Appalachian Mountains on the east and the Rocky Mountains on the west. It rises in the basin of Itasca Lake, in northern Minnesota, and flows mostly in a southerly direction to the Gulf of Mexico. In the region of its headwaters are numerous lakes which were formed by glacial action, but the river itself was old before the glacial period, as is shown by the crumbling rocks on the edges of the broad and driftless valley through which it flows along the S.E. border of Minnesota and the S.W. border of Wisconsin, in contrast with the precipitous bluffs of hard rock on the edges of a valley that is narrow and steep-sided farther down where the river was turned from its ancient course by the glacier. So long as the outlet of the Great Lakes through the St. Lawrence Valley was blocked by the icy mass, they were much larger than now and discharged through the Wabash, Illinois and other rivers into the Mississippi. Below the glaciated region, that is from southern Illinois to the Gulf, the river had carved before the close of the glacial period a flood-plain varying in width from 5 to 80 m., but this has been filled to a depth of 100 ft. or more with alluvium, and in the post-glacial period an inner valley has been formed within the outer one. The total length of the river proper from the source near Lake Itasca to its mouth in the Gulf of Mexico is 2553 m.; but the true source of the river is at the fountain-head of the Missouri, in the Rocky Mountains, on the S.W. border of Montana, 8000 ft. above the sea, and from this source there is a continuous stream to the Gulf which is 4221 m. long—the longest in the world. The Mississippi and its tributaries have more than 15,000 m. of navigable waterways and drain an area of approximately 1,250,000 sq. m. The system extends through the heart of the continent and affords a direct line of communication between temperate and tropical regions. Certain physical and hydrographic features, however, make the regulation and

control of the Mississippi below the influx of the Missouri an exceedingly difficult problem.

The Upper Mississippi, that is the Mississippi from its source to the mouth of the Missouri, drains 173,000 sq. m., over which the annual rainfall averages 34.7 in., and its discharge per second into the Lower Mississippi varies from 25,000 cub. ft. to 550,000 cub. ft. The Missouri drains 528,000 sq. m., over which the annual rainfall averages 19.6 in., and its discharge per second into the Mississippi varies from 25,000 cub. ft. to 600,000 cub. ft. The Ohio drains 214,000 sq. m., over which the annual rainfall averages 43 in., and its discharge per second varies from 35,000 cub. ft. to 1,200,000 cub. ft. The Arkansas drains 161,000 sq. m., over which the annual rainfall averages 28.3 in., and its discharge per second varies from 4000 cub. ft. to 250,000 cub. ft. The Red drains 97,000 sq. m., over which the annual rainfall averages 38.3 in., and its discharge per second varies from 3500 cub. ft. to 180,000 cub. ft. These and a few smaller tributaries produce a river which winds its way from Cape Girardeau, Missouri, to the passes through a flood plain averaging about 40 m. in width and having a general southern slope of 8 in. to the mile. The general lateral slope towards the foothills is about 6 in. in 5000 ft., but the normal fall in the first mile is about 7 ft. Thus the river sweeps onward with great velocity, eroding its banks in the bends and rebuilding them on the points, now forming islands by its deposits, and now removing them. Chief among the changes is the formation of cut-offs. Two eroding bends gradually approach each other until the water forces a passage across the narrow neck. As the channel distance between these bends may be many miles, a cascade perhaps 5 or 6 ft. in height is formed, and the torrent rushes through with a roar audible for miles. The checking of the current at the upper and lower mouths of the abandoned channel soon obstructs them by deposit, and forms in a few years one of the crescent lakes which are so marked a feature on the maps. At the mouth of the Red river, 316 m. above the passes, the water surface at the lowest stage is only 5 ft. above the level of the Gulf, where the mean tidal oscillation is about 1 ft. The river channel in this section is therefore a fresh-water lake. At the flood stage the surface rises 50 ft. at the mouth of Red river, but of course retains its level at the Gulf, thus giving the head necessary to force forward the increased volume of discharge. Above the mouth of the Red river the case is essentially different. The width increases and the depth decreases. Hence the general slope in long distances is here nearly the same at all stages. The effect of these different physical conditions appears in the comparative volumes which pass through the channel. At New Orleans the maximum discharge hardly reaches 1,200,000 cub. ft. per second, and a rising river at high stages carries only about 100,000 cub. ft. per second more than when falling at the same absolute level; but just below the mouth of the Ohio the maximum flood volume reaches 1,400,000 cub. ft. per second, and at some stages a rising river may carry one-third more water than when falling at the same absolute level. The river is usually lowest in October. It rises rapidly until checked by the freezing of the northern tributaries. It begins to rise again in February, as a consequence of the storms from the Gulf which traverse the basin of the Ohio, and attains its highest point about the 1st of April. It then falls a few feet, but the rains in the Upper Mississippi basin cause it to rise again and high water is maintained until some time in June by the late spring and early summer rains in the Missouri basin. As a rule the river is above mid-stage from January to August inclusive, and below that level for the remainder of the year.

Engineering Works.—Below Cape Girardeau there are at least 29,790 sq. m. of rich bottom lands which require protection from floods, and this has been accomplished to a great extent by the erection of levees. The first levee was begun in 1717, when the engineer, Le Blond de La Tour (d. about 1725) erected one a mile long to protect the infant city of New Orleans from overflow. Progress at first was slow. In 1770 the settlements extended only 30 m. above and 20 m. below New Orleans; but in 1828 the levees, although quite insufficient in dimensions, had become continuous nearly to the mouth of the Red river. In 1850 a great impulse was given to systematic embankment by the United States government, which turned over to the several states all unsold swamps and overflowed lands within their limits, to provide a fund for reclaiming the districts liable to inundation. The action resulting from this caused alarm in Louisiana. The aid of the government was invoked, and Congress immediately ordered the necessary investigations and surveys. This work was placed in charge of Captain (later General) Andrew A. Humphreys (1810-1883), and an elaborate report covering the results of ten years of investigation was published, just after the outbreak of the Civil War in 1861. In this report it was demonstrated that the great bottom lands above the Red river before the construction of their levees did

¹ Removed from office by Federal troops, 22nd of May 1865; W. L. Sharkey was appointed provisional governor by President Johnson.

² Removed from office by U.S. troops 15th of June 1868.

³ Resigned 30th of November 1871.

⁴ Resigned 29th of March 1876; succeeded by the president of the senate.

⁵ The name is from the Algonkin *missi-sepe*, literally "father of waters."

not, as had been supposed, in Louisiana, serve as reservoirs to diminish the maximum wave in great flood seasons. Furthermore, the report argued that no diversion of tributaries was possible; that no reservoirs artificially constructed could keep back the spring freshets which caused the floods; that the making of cut-offs, which had sometimes been advocated as a measure of relief, was in the highest degree injurious; that outlets were impracticable from the lack of suitable sites; and, finally, that levees properly constructed and judiciously placed would afford protection to the entire alluvial region.

During the Civil War (1861-65) the artificial embankments were neglected; but after its close large sums were expended by the states directly interested in repairing them. The work was done without concert upon defective plans, and a great flood early in 1874 inundated the country, causing terrible suffering and loss. Congress, then in session, passed an act creating a commission of five engineers to determine and report on the best system for the permanent reclamation of the entire alluvial region. Their report, rendered in 1875, endorsed the conclusions of that of 1861, and advocated a general levee system on each bank. This system comprised: (1) a main embankment raised to specified heights sufficient to restrain the floods; and (2) where reasonable security against caving required considerable areas near the river to be thrown out, exterior levees of such a height as to exclude ordinary high waters, but to allow free passage to great floods, which as a rule occur only at intervals of five or six years. An engineering organization was proposed for constructing and maintaining these levees, and a detailed topographical survey was recommended to determine their precise location. Congress promptly approved and ordered the survey; but strong opposition on constitutional grounds was raised to the construction of the levees by the government.

In the meantime complaints began to be heard respecting the low-water navigation of the river below the mouth of the Ohio. A board of five army engineers, appointed in 1878 to consider a plan of relief, reported that a depth of 10 ft. could probably be secured by narrowing the wide places to about 3500 ft. with hurdle work, brush ropes or brush dykes designed to cause a deposit of sediment, and by protecting caving banks by light and cheap mattresses. Experiments in these methods were soon begun and they proved to be effective.

The bars at the efflux of the passes at the mouth of the Mississippi were also serious impediments to commerce. The river naturally discharges through three principal branches, the south-west pass, the south pass and the north-east pass, the latter through two channels, the more northern of which is called Pass à l'Outre. In the natural condition the greatest depth did not exceed 12 or 13 ft. After appropriations by Congress in 1837, 1852 and 1856, a depth of 18 ft. was finally secured by dredging and scraping. The report of 1861 discussed the subject of bar formation at length, and the stirring up of the bottom by scrapers during the flood stages of the river (six months annually) was recommended by it. After the war this recommendation was carried into effect for several years, but experience showed that not much more than 18 ft. could be steadily maintained. This depth soon became insufficient, and in 1873 the subject was discussed by a board of army engineers, the majority approving a ship canal. In 1874 Congress constituted a special board which, after visiting Europe and examining similar works of improvement there, reported in favour of constructing jetties at the south pass, substantially upon the plan used by Pieter Caland (b. 1826) at the mouth of the Meuse; and in 1875 Captain James B. Eads (1820-1887) and his associates were authorized by Congress to open by contract a deep channel through the south pass upon the general plan proposed by this board. As modified in 1878 and 1879 the contract called for the maintenance for twenty years of a channel through the pass and over the bar not less than 26 ft. in depth throughout, a width of not less than 200 ft. and with a middle depth of 30 ft. The work was begun on the 2nd of June 1875. The required depth was obtained in 1879, and with few interruptions has been

maintained. In 1902 Congress authorized preparations for the construction of a deeper (35 ft.) and a wider channel through the south-west pass; the work was begun in 1903 and virtually completed in 1909.

In the year in which Captain Eads opened the south pass of deep-water navigation Congress created a commission of seven members to mature plans for correcting and deepening the channel of the river, for protecting its banks and for preventing floods, and since then large expenditures for improvement between the head of the passes and the mouth of the Ohio have been under the control of this commission. In protecting the banks, mattresses of brush or small trees, wove like basket-work, were sunk on the portion of the bank at the time under water, by throwing rubble stone upon them, an excess of stone being used. A common size of mattress was 800 ft. long, counted along the bank, by 250 ft. wide. Sometimes a width of 300 ft. was used, and lengths have reached 2000 ft. The depth of water was often from 60 to 100 ft. At first these mats were light structures, but the loss of large quantities of bank protection by the caving of the bank behind them, or by scour at their channel edges, forced the commission steadily to increase the thickness and strength of the mattress, so that the cost of the linear foot of bank protection, measured along the bank, rose from \$8 or \$10 to \$30 in the later work. The contraction works adopted were systems of spurs or pile dykes running out from the shore nearly to the line of the proposed channel. Each dyke consisted of from one to four parallel rows of piles, the interval between rows being about 20 ft. and between piles in a row 8 or 10 ft. The piles and rows were strongly braced and tied together, and in many cases brush was woven into the upper row, forming a hurdle, in order further to diminish the velocity of the water below the spur. By 1893 it was evident that the cost, which had been estimated at \$33,000,000 in 1881, would really be several times that amount, and that the works would require heavy expense for their maintenance and many years for their execution. Navigation interests demanded more speedy relief. The commission then began experimenting with hydraulic dredges, and in 1896 it adopted a project for maintaining a channel from the mouth of the Ohio to the passes that should be at least 9 ft. deep and 250 ft. wide throughout the bar. Centrifugal pumps are used, the suction pipes being at the bow and the discharge at the stern through a line of pipes about 1000 ft. long, supported on pontoons. Water jets or cutters stir up the material to be dredged before it enters the suction pipes. The latter dredges have a capacity of about 1000 cu. yds. per hour, and the water is raised in the 32-in. discharge pipes being from 10 to 15 ft. per second. They cost from \$86,000 to \$120,000, and their working during a low-water season costs about \$20,000. These dredges begin work on a bar where trouble is feared before the river reaches its lowest stage, and make a cut through it. A common cut is 2000 ft. long by 250 ft. wide, and 3 or 4 ft. deep. Since 1903 a channel of the proposed depth or more has been maintained.

In 1882 occurred one of the greatest floods known on the Mississippi, and extensive measurements of it were made. A maximum flood of 1,900,000 cu. ft. per second crossed the latitude of Cairo. Much of it escaped into the bottom lands, which are below the level of the great floods, and flowed through them to rejoin the river below. The flow in the river proper at Lake Providence, 542 m. below Cairo, was thus reduced to about 1,000,000 cu. ft. per second, while if the river had been confined by levees the flow between them would have been double, or about 2,000,000 cu. ft. per second. The volume of the levees in 1882 was about 33,000,000 cu. yds., and by the 30th of June, 1908 had been increased to 219,621,594 cu. yds., of which the United States had built about one-half, and has expended on them \$22,562,544. The length of the levees is about 1486 m., and they are continuous save where interrupted by tributaries or by high lands, from New Madrid, or 80 m. below Cairo, to Fort Jackson, 1039 m. below Cairo. The width of the interval between levees on the opposite banks of the river varies greatly; in many places the levees are built much nearer the normal margin of the river than is consistent with keeping the flood heights as low as possible. This has arisen from two causes: first, to give protection to lands already cultivated, which lie usually near the bank of the river; secondly, to avoid the lower ground, which, owing to the peculiar formation, is found as one goes back from the river. Another bad result of this nearness of the levees to the bank of the river is the loss of levees by caving, which was nearly 5,000,000 cu. yds. in 1904-1905, and can only be prevented by bank protection, costing \$150,000 per mile, to protect a levee perhaps 16 ft. high costing about \$30,000 per mile. The levees have top widths of 8 ft., side slopes of one-third, and the banquettes between two crests exceed 20 to 10 ft. The grades of the levees are usually 3 ft. above the highest water, and have to be raised from year to year as greater confinement of water gives greater flood heights. When this system is completed there will probably be hundreds of miles of levee with heights exceeding 14 ft. In 1899, after about \$28,000,000 had been spent on levees by the United States and by the local authorities, the commission submitted an estimate for additional work on levees, amounting to 124,000,000 cu. yds. and costing \$22,000,000. The effect of the levees has been to increase flood heights. Though the

Mississippi River Commission was forbidden by Congress to build levees to protect lands from overflow, a majority of its members believed them useful for the purpose of navigation improvement. They have, however, effected no sensible improvement in the navigation of the river at low stages, and at other stages no improvement was needed for the purposes of navigation. Neither did they prevent a destructive flood in 1897 and again in 1903. By the 30th of June 1898, \$57,510,216.81 had been appropriated for the commission's work below the mouth of the Ohio.

From the mouth of the Ohio to the mouth of the Missouri, a distance of about 210 m., the river is affected by back water from the Ohio which increases the deposit of sediment, and although the banks increase in height above Cape Girardeau the channel was in its natural state frequently a mile or more in width, divided by islands, and constructed by bars on which the low-water depth was only 3½ to 4 ft. The improvement was begun in 1872, and in 1881 a project was adopted for narrowing the channel to approximately 2500 ft.

In 1896 dredging was begun and in 1905 the further execution of the original project of 1881 was discontinued, because of a new plan for a channel 14 ft. deep from the Great Lakes to the Gulf.

The Upper Mississippi carries only a small amount of sediment and was navigable in its natural state to St Paul, although at low water the larger river boats could ascend no farther than La Crosse, Wisconsin. In 1879 Congress adopted a project for obtaining a channel with a minimum depth at low water of 4½ ft., chiefly by means of contraction works. In 1907 Congress authorized further contraction, dredging, the construction of a lateral canal at Rock Island Rapids, and the enlargement of that at Des Moines Rapids with a view to obtaining a channel nowhere less than 6 ft. in depth at low water. By means of two locks and dams, which were begun in 1894 and were about three-fourths complete in 1908, a navigable channel of the same depth will be extended from St Paul to Minneapolis. The United States government has constructed dams at the outlets of lakes Winnibigishish, Cass, Leech, Pine, Sandy and Pokegama, and thereby created reservoirs having a total storage capacity of about 95,000,000,000 cub. ft. This reservoir system, which may be much enlarged, is also beneficial in that it mitigates floods and regulates the flow for manufacturing purposes and for logging.

Although the United States government has expended more than \$7,000,000 on the Mississippi river between the mouth of the Missouri and the head of the rapids, the improvement in navigation thereon has not been great enough to make it possible for river freighters to force down railway rates by competition. But it is no longer merely a question of competition. The productivity of this region has become so enormous that railways alone cannot meet the requirements of its commerce, and a persistent demand has arisen for a channel 14 ft. deep from the Great Lakes to the Gulf. The first great impetus to this demand was given in 1900, when a canal 24 ft. in depth, and known as the Chicago Drainage Canal, was opened from the Chicago river at Lockport, Illinois, to the Des Plaines river, 24 m. from Lake Michigan. In two years later Congress appropriated \$200,000 for the Mississippi River Commission to make a survey and prepare plans, with estimates of cost, for a navigable waterway 14 ft. in depth from Lockport to St Louis. The commission reported favourably in 1905, and in 1907 Congress provided for another commission, which in June 1909 reported against the 14 ft. channel, estimating that it would cost \$128,000,000 for construction and \$6,000,000 annually for maintenance, and considered a 9-ft. channel (8 ft. between Ohio and St Louis) sufficient for commercial purposes.

The Ohio is commercially the most important tributary, and in flood time most of the commerce on the Lower Mississippi consists of coal and other heavy freight received from the mouth of this river. Its navigation at low water has also been improved by dredging, rock excavation and contraction works. In its upper reaches a channel 9 ft. in depth had been obtained before 1909 by the construction of a number of locks with collapsible dams which are thrown down by a flood. It is the plan of the government to extend this system to the mouth of the river, and it has been estimated that a channel 12 to 14 ft. in depth may ultimately be obtained by a system of mountain reservoirs. Furthermore, the government has given to a corporation 24 m. from Lake Michigan to the mouth of the Ohio at Pittsburg, with Lake Erie near Ashtubula, Ohio, by means of a canal to make it, in depth. The Missouri is navigable from its mouth to Fort Benton, a distance of 2285 m., and it had become a very important highway of commerce when the first railway, the Hannibal & St Joseph, reached it in 1859. Its commerce then rapidly disappeared, but regular navigation between Kansas City and St Louis was re-established in 1907 and a demand has arisen for a 12-ft. channel from the mouth of the river to Sioux City, Iowa. The Red, Arkansas, White, Tennessee, and Cumberland rivers, which are parts of the Mississippi system, have each a navigable mileage exceeding 600 m.

History.—Although the Mississippi river was discovered in its lower course by Hernando de Soto in 1541, and possibly by Alonso Alvarez de Pineda in 1519, Europeans were not yet prepared to use the discovery, and two Frenchmen, Louis Joliet and Father Jacques Marquette, first made it generally known to the civilized world by a voyage down the river from

the mouth of the Wisconsin to the mouth of the Arkansas in 1673.¹ In 1680 Louis Hennepin, sent by La Salle, who planned to acquire for France the entire basin drained by the great river and its tributaries, explored the river from the mouth of the Illinois to the Falls of St Anthony, where the city of Minneapolis now stands, and two years later La Salle himself descended from the mouth of the Illinois to the Gulf, named the basin "Louisiana," and took formal possession of it in the name of his king, Louis XIV. By the war which terminated (1763) in the Treaty of Paris, Great Britain wrested from France all that part of the basin lying east of the middle of the river (except the island of New Orleans at its mouth), together with equal rights of navigation; and the remainder of the basin France had secretly ceded to Spain in 1762. During the War of Independence the right to navigate the river became a troublesome question. In 1779 the Continental Congress sent John Jay to Spain to negotiate a treaty of commerce, and to insist on the free navigation of the Mississippi, but the Spanish government refused to entertain such a proposition, and new instructions that he might forego that right south of 31° N. latitude reached him too late. While the commissioners from Great Britain and the United States were negotiating a treaty of peace at Paris, Spain, apparently supported by France, sought to prevent the extension of the western boundary of the United States to the Mississippi, but was unsuccessful, and the United States acquired title in 1783 to all that portion of the basin east of the middle of the river and north of 31° N. lat. In 1785 Congress appointed John Jay to negotiate a commercial treaty with Don Diego de Gardoqui, the Spanish minister to the United States, but the negotiations resulted in nothing. For the next ten years the Spaniards imposed heavy burdens on the American commerce down the Mississippi, but in 1794 James Monroe, the United States minister to France, procured the aid of the French government in further negotiations, for which Thomas Pinckney had been appointed envoy extraordinary, and in 1795 Pinckney negotiated a treaty which granted to the United States the free navigation of the river from its source to the Gulf and the privilege of depositing American merchandise at the port of New Orleans or at some other convenient place on the banks. Spain retroceded Louisiana to France in 1800, but the Louisiana Purchase in 1803 left very little of the Mississippi basin outside of the United States.

As the headwaters of the river were not definitely known, the United States government sent Zebulon M. Pike in 1805 to explore the region, and on reaching Leech Lake, in February 1806, he pronounced that the main source. In 1820 Lewis Cass, governor of Michigan territory, which then had the Mississippi for its western boundary, conducted an expedition into the same region as far as Cass Lake, where the Indians told him that the true source was about 50 m. to the W.N.W., but as the water was too low to proceed by canoe he returned, and it remained for Henry Schoolcraft, twelve years later, to discover Lake Itasca, which occupies a low depression near the centre of the basin in which the river takes its rise. Jean N. Nicollet, while in the service of the United States government, visited Lake Itasca in 1836, and traced its principal affluent, since known as Nicollet's Infant Mississippi river, a few miles S.S.W. from the lake's western arm. Jacob Vradenburg Brower (1844-1905), who was commissioned by the Minnesota Historical Society in 1880 to make a more detailed survey, traced the source from Nicollet's Infant Mississippi to the greater ultimate reservoir, which contains several lakelets, and lies beyond Lake Itasca, 2553 m. by water from the Gulf of Mexico, and 1588 ft. above the sea. Soon after this survey the state of Minnesota created Itasca State Park, which contains both Itasca Lake and its affluents from the south.

¹ It seems probable that Joliet and Marquette were preceded by two other Frenchmen, Pierre Esprit Radisson and Menard Chouart des Grosseillers, who apparently reached the Upper Mississippi in or about 1665; but their claim to priority has been the subject of considerable controversy, and, at all events, there was no general knowledge of the river until after the voyage of Joliet and Marquette.

From the close of the 17th century until the building of the first railways in the Mississippi basin, in the middle of the 19th century, the waterways of the Mississippi system afforded practically the only means of communication in this region. During the early years of the French occupancy trade with the Indians was the only important industry, and this was carried on almost wholly with birch canoes and a few pirogues; but by 1720 immigrants were coming in considerable numbers both by way of the Great Lakes and the mouth of the Mississippi, and to meet the demands of a rapidly expanding commerce barges and keelboats were introduced. The development of the Mississippi Valley must have been slow until the railways came had it not been for the timely application of the power of steam to overcome the strong current of the Lower Mississippi. Even without the steamboat, however, the Mississippi was indispensable to the early settlers, and the delay of the United States in securing for them its free navigation resulted in threats of separation from the Union. The most formidable movement of this kind was that of 1787-1788, in which James Wilkinson, who had been an officer in the War of Independence, plotted for a union with Spain. Steamboat navigation on this river system was begun in 1811, when the "New Orleans," which had been built by Nicholas Roosevelt (1767-1854), made the trip from Pittsburg to New Orleans, but it was six years later before the steamboat was sufficiently improved to ascend to St. Louis. In 1817 the commerce from New Orleans to the Falls of the Ohio, at Louisville, was carried in barges and keel-boats having a capacity of 60 to 80 tons each, and 3 to 4 months were required to make a trip. In 1820 steamboats were making the same trip in 15 to 20 days, by 1838 in 6 days or less; and in 1834 there were 230 steamboats, having an aggregate tonnage of 30,000 tons, engaged in trade on the Mississippi. Large numbers of flat boats, especially from the Ohio and its tributaries, continued to carry produce down stream; an extensive canal system in the state of Ohio, completed in 1842, connected the Mississippi with the Great Lakes; these were connected with the Hudson river and the Atlantic Ocean by the Erie Canal, which had been open since 1825. Before the steamboat was successfully employed on the Mississippi the population of the valley did not reach 2,000,000, but the population increased from approximately 2,500,000 in 1820 to more than 6,000,000 in 1840, and to 14,000,000 or more in 1860. The well-equipped passenger boats of the period immediately preceding the Civil War were also a notable feature on the Ohio and the Lower Mississippi.

In the Civil War the Lower Mississippi, the Ohio, and its two largest tributaries—the Cumberland and the Tennessee—being still the most important lines of communication west of the Appalachian Mountains, determined largely the movements of armies. The adherence of Kentucky to the Union excluded the Confederacy from the Ohio, but especially disastrous was the fall of Vicksburg and Port Hudson, whereby the Confederacy was cut in two and the entire Mississippi became a Federal highway. Under Federal control it was closed to commerce, and when the war was over the prosperity of the South was temporarily gone and hundreds of steamboats had been destroyed. Moreover, much of the commerce of the West had been turned from New Orleans, via the Mississippi, to the Atlantic seaboard, via the Great Lakes and by new lines of railways, the number of which rapidly increased. There was, of course, some revival of the Mississippi commerce immediately after the war, but this was checked by the bar at the mouth of the south-west pass. Relief was obtained through the Eads jetties at the mouth of the south pass in 1879, but the facilities for the transfer of freight were far inferior to those employed by the railways, and the steamboat companies did not prosper. But at the beginning of the 20th century the prospects of communication with the western coast of North America and South America, and with the Orient by way of an isthmian canal, the inadequate means of transportation afforded by the railways, the efficiency of competing waterways in regulating freight rates, and the consideration of the magnificent system of inland waterways which the Mississippi and its tributaries would afford when

fully developed, have created the strong demand for river improvement.

BIBLIOGRAPHY.—A. P. C. Griffin, *The Discovery of the Mississippi: a Bibliographical Account* (New York, 1883); J. G. Shea, *The Discovery of the Mississippi*, in Report and Collections of the State Historical Society of Wisconsin, vol. vii. (Madison, 1876); J. V. Brower, *The Mississippi River and its Sources: a Narrative and Critical History of the Discovery of the River and its Headwaters* (Minneapolis, 1893); F. A. Ogg, *The Opening of the Mississippi: a Struggle for Supremacy in the American Interior* (New York, 1904); E. W. Gould, *Fifty Years on the Mississippi; or, Gould's History of River Navigation* (St. Louis, 1886); J. W. Monette, *The Progress of Navigation and Commerce on the Waters of the Mississippi River and the Great Lakes*, in the Publications of the Mississippi Historical Society, vol. vii. (Oxford, Miss., 1903); R. B. Houghton, *The Influence of the Mississippi River upon the Early Settlement of Its Valley*, in the Publications of the Mississippi Historical Society, vol. iv.; Mark Twain, *Life on the Mississippi* (Boston, 1883); A. A. Humphreys and H. L. Abbot, *Report on the Physics and Hydraulics of the Mississippi River* (Philadelphia, 1861); *Annual Reports of the Mississippi River Commission* (Washington, 1880 seq.); E. L. Corthell, *A History of the Jetties at the Mouth of the Mississippi River* (New York, 1881); J. A. Ockerson, *The Mississippi River: Some of its Physical Characteristics and Measures employed for the Regulation and Control of the Stream* (Paris, 1900); J. L. Mathews, *Remaking the Mississippi* (Boston, 1909); K. M. Brown, *The Mississippi River from Cape Girardeau to the Head of the Passes*, in *Annals of the American Geographical Society*, vols. xxix, and xxxv. (New York, 1902 and 1903); J. L. Greenleaf, "The Hydrology of the Mississippi," in *American Journal of Science*, vol. ii. (New Haven, 1896); L. M. Haupt, "The Mississippi River Problem," in *Proceedings of the American Philosophical Society*, vol. xliii. (Philadelphia, 1904).

MISSOLOGHI, or **MESOLOGHI** (Μεσολόγγιον), the chief town of the monarchy of Acarnania and Aetolia, Greece. It is on the N. side of the Gulf of Patras, about 7 m. from the coast; pop., about 8300. The place is notable for the siege which Mavrocordato and Botzaris sustained in 1822 and 1823 against a Turkish army 11,000 strong, and for the more famous defence of 1825-26. Byron died here in 1824, and is commemorated by a cenotaph and a statue.

MISSOULA, a city and the county-seat of Missoula county, Montana, U.S.A., on the Clark Fork of the Columbia (here called the Missoula river), about 125 m. W.N.W. of Helena. Pop. (1900), 4366 (1020 foreign-born); (1910), 12,860. It is served by the Chicago, Milwaukee & Puget Sound railway, and by the Northern Pacific railway, which has shops here and of which Missoula is a division headquarters. There is an electric railway from Missoula to Hamilton, about 48 m. south. The Northern Pacific railway maintains a large hospital here, and St. Patrick's hospital is maintained by sisters of charity. Missoula is about 3200 ft. above sea-level, with Mount Jumbo immediately north, and University Mountain immediately south of the Clark Fork, and the Bitter Root range to the west. The city is situated on the bed of a prehistoric lake. Missoula is the seat of the Sacred Heart academy (for girls), of a Christian Brothers' school (for boys), of the Garden City commercial college, and of the state university (founded in 1893, and opened in 1895), which occupies a campus of 40 acres. On the Bitter Root river, 4 m. distant, is the United States army post, Fort Missoula. Missoula has considerable trade with the surrounding country in farming, fruit-growing, lumbering and mining. The Clark Fork furnishes water power, and at Bonner, 6 m. east, is the Clark dam (28 ft.), which furnishes electric power. Missoula was founded in 1864, and chartered as a city in 1887.

MISSOURI, a north-central state of the United States of America, and one of the greatest and richest, and economically one of the most nearly independent, in the Union, lying almost midway between the two oceans, the Gulf of Mexico and Canada. It is bounded N. by Iowa; E. by Illinois, Kentucky and Tennessee; S. by Arkansas; and W. by Oklahoma, Kansas and Nebraska. Its N. and S. limits are mainly coincident with the parallels of 40° 35' and 36° 30' N. lat.—the southernmost boundary, in the S.E. corner, is the meridian of 36° N. lat.—and much of the western border is the meridian of 94° 43' W. long. respectively; but natural boundaries are afforded on the extreme N.E. by the Des Moines river, on the E. by the Mississippi; on the S.E. by the St. Francis and on the N.W. by the

Missouri. Altogether, about 850 m., or considerably more than half of the entire boundary, is water-front: about 500 m. along the Mississippi, about 208 m. along the Missouri, and about 100 m. along the St Francis and Des Moines. The length of the state from north to south, disregarding the St Francis projection southward, is 283 m., the width from west to east varies from 203 to 308 m., and the total area is 69,420 sq. m., of which 693 sq. m. are water surface.

Physical Features.—Missouri has three distinct physiographic divisions: a north-western upland plain, or prairie region; a lowland, in the extreme south-east; and, between these, the Missouri portion of the Ozark uplift. The boundary between the prairie and Ozark regions follows the Missouri river from its mouth to Glasgow, running thence south-westward, with irregular limits, but with a direct trend, to Jasper county at the south-east corner of Kansas; and the boundary between the Ozark and embayment regions runs due south-west from Cape Girardeau.

1. The prairie region embraces, accordingly, somewhat more than "northern" Missouri—i.e. the portion of the state north of the Missouri river—and somewhat more than a third of the state. It is a beautiful, rolling country, with great abundance of streams; more hilly and more wooded than its eastern half. The elevation in the extreme north-west is about 1200 ft. and in the extreme north-east about 500 ft., while the rim of the region to the south-east, along the border of the Ozark region, has an elevation of about 900 ft. The larger streams have valleys 250 to 300 ft. deep and sometimes 8 to 10 m. broad, the country bordering them being the most broken of the region. The smaller streams have so eroded the whole face of the country that little of the original surface plain is to be seen. The Mississippi river is skirted throughout the length of the state by contours of 400 to 600 ft. elevation.

2. The Ozark region is substantially a low dome, with local faulting and minor undulations, dominated by a ridge—or, more exactly, a relatively even belt of highland—that runs from near the Mississippi about Ste Genevieve county to Barry county on the Arkansas border; the contour levels falling with decided regularity in all directions below this crest. High rocky bluffs that rise precipitously on the Mississippi, sometimes to a height of 150 ft. or so above the water, from the mouth of the Meramec to Ste Genevieve, mark where that river cuts the Ozark ridge, which, across the river, is continued by the Hills in the west. The elevations of the great in Missouri (the highest portion of the uplift is in Arkansas) vary from 1100 to 1600 ft. This second physiographic region comprehends somewhat less than two-thirds of the area of the state. The Burlington escarpment, which in places is as much as 250 to 300 ft. in height, runs along the western edge of the Cambro-Ordovician formations and divides the region into an eastern and a western area, known respectively to physiographers as the Salem Upland and the Springfield Upland.² Especially, each is a simple rolling plateau, much broken by erosion (though considerable undisturbed areas drained by underground channels remain), especially in the east, and dotted with hills; some of these are residual outliers of the eroded Mississippian limestones to the west, and others are the summits of an archaic topography above which sedimentary formations that now constitute the valley-floor about them were deposited and then eroded. There is no arrangement in chains, but only scattered rounded peaks and short ridges, with winding valleys about them. The highest points in the state are Tom Sauk Mountain (more than 1800 ft.), in Iron county and Cedar Gap Plateau (1683 ft.), in Wright county. Few localities have an elevation exceeding 1400 ft. Rather broad, smooth valleys, well degraded hills with rounded summits, and, despite the escarpments—generally smooth contours and sky-lines, characterize the whole of this Ozark region.

3. The third region, the lowlands of the south-east, has an area of some 3000 sq. m. It is an undulating country, for the most part well drained, but swampy in its lowest portions. The Mississippi is skirted with lagoons, lakes and morasses from Ste Genevieve to the Arkansas border, and in places is confined by levees.

The drainage of the state is wholly into the Mississippi, directly or indirectly, and almost wholly into either that river or the Missouri within the borders of the state. The latter stream, crossing the state and cutting the eastern and western borders at or near St Louis and Kansas City respectively, has a length between these of 430 m. The areas drained into the Mississippi outside the state through the St Francis, White and other minor streams are relatively small. The larger streams of the Ozark dome are of decided interest to the physiographer. Those of the White system have open-rough valleys bordered by hills in their upper courses and canyons in their lower courses; others, notably the Gasconade, exhibit re-

markable differences in the drainage areas of their two sides, with interesting illustrations of shifting water-partings; and the White, Gasconade, Osage and other rivers are remarkable for upland meanders, lying, not on flood-plains, but around the spurs of a highland country.³

Caves, chiefly of limestone formation, occur in great numbers and near the Ozark Mountain region in the south-western part of Missouri. There are a hundred or more, best preserved in Stone county alone, and there are many in Christian, Greene and McDonald counties. The most remarkable is Marble Cave, a short distance south-east of the centre of Stone county. The entrance is through a large sink-hole at the top of Roark Mountain, from which there is a passage-way to an open chamber. This extraordinary hall-like room is about 350 ft. long and about 125 ft. wide, has bluish-grey limestone walls, and an almost perfectly vaulted roof, rising from 100 to 105 ft. Its acoustic properties are said to be almost perfect, and it has been named "the Auditorium." At one end is a remarkable almagict formation of white and gold ovals about 65 ft. in height and about 200 ft. in girth, called "the White Throne." Jacob's Cavern (g.c.), near Pineville, McDonald county, disclosed on exploration skeletons of men and animals, rude implements, &c. Crystal Cave, near Joplin, Jasper county, has its entire surface lined with calcite crystals and scalenohedron formations, from 1 ft. to 2 ft. in length. Knox Cave, in Greene county, and several caverns near Ozark, in Christian county, are also of interest. Other caves include Fried's Cave, about 6 m. north-east of Kolla, Phelps county, Hannibal Cave (in Kalls county, about 1 m. south of Hills in the west), and several containing narrow passages or shafts; and various caverns in Miller, Ozark, Greene and Parry counties.

Geology.—The geological history of the state covers the period from Algonkian to late Carboniferous time, after which there is a gap in the record until Tertiary time, except that there was apparently a temporary depression of the north-western and south-western corners in the Cretaceous age. Northern Missouri is covered with a mantle of glacial deposits, generally thick, although in the stream valleys of the north-east the bed-rocks are widely exposed. The southern limit of these glacial deposits is practically the bluffs bordering the Missouri river, except for a narrow strip along the Mississippi below St Louis. These Pleistocene deposits include bouldery drift, loess, terrace deposits and alluvium. The till is generally less than 5 ft. and rarely more than 40 ft. deep, but in some localities it reaches a thickness of 200 ft., or even more. Modified drift and erratics were also widely deposited. The loess, however—reddish-brown, buff or grey in colour, according to the varying proportions of iron oxide—is almost everywhere spread above the drift. It is exposed in very deep cuts along the bluffs of Missouri. Southeastern Missouri, generally speaking, with residual rocks. The embayment region of Tertiary origin containing deposits of both neocene and eocene periods. Regarding now the outcrops of bed-rock, there are exposures of Algonkian (doubtful, and at most a mere patch on Pilot Knob), Archean, Cambrian, Ordovician, Silurian, Devonian, sub-Carboniferous and Carboniferous. The St Francois Mountains and the neighbouring portion of the Ozark region are capped with Archean rocks. All the rest of the Ozark region except the extreme south-western corner of the state is Cambro-Ordovician. Along the margin of this great deposit, on the Mississippi river below St Louis and along the northern slope of the Missouri near its mouth, is an outcrop of Silurian. Parallel to this in the latter locality, and lying also along the Mississippi near by to the north, as well as in the intervening country between the two rivers, are strips of Devonian. Both this and the Silurian are mere fringes on the great area of Cambro-Ordovician. Next, covering the north-eastern and south-western corners of the state, and connecting them with a narrow belt, are the lower Carboniferous measures (which also appear in a very narrow band along the Mississippi for some distance below St Louis). The western edge of these Missourian measures is the irregular Schuyler county on the northern border, to Barton county, on the western border, of the state, but with a great eastward projection north of the Missouri river, to Montgomery county. This line defines the eastern limit of the Coal Measures proper, which cover a belt 20 to 80 m. in width. Finally, to the west of these, and covering the north-western corner of the state, are the upper coal measures. Thus the state is to be conceived, in geological history, as gradually built up around an Archean island in successive seas, the whole of the state becoming dry land after the post-Carboniferous uplift. Until the post-Mesozoic uplift of the Rocky Mountain region the north-western portion of the state drained westward.

Fauna.—Excepting the embayment region, Missouri lies wholly within the Carolinian area of the Upper Austral life-zone; the

² There has been some controversy as to whether this condition is due to the elevation and corrosion of original flood-plain meanders after their development in a past basinal or continental stage. The theory is probably correct—that of the natural, simultaneous lateral and vertical cut of an originally slightly sinuous stream, under such special conditions of stream declivity and horizontal bedstrata (conditions supposed by some to be peculiarly fulfilled in this region) as would be favourable to the requisite balance of bank cutting and channel incision.

¹ Counting the St Francis projection the length is 328 m.

² Both the Ozark region and the prairie region are divided by minor escarpments into ten or twelve sub-regions.

MISSOURI

Scale, 1:1,850,000
English Miles
0 10 20 30 40
County Seats
County Boundaries

ENVIRONS OF ST. LOUIS

Scale, 1:1,850,000
English Miles
0 10 20 30 40
County Seats
County Boundaries

ENVIRONS OF KANSAS CITY

Scale, 1:1,850,000
English Miles
0 10 20 30 40
County Seats
County Boundaries

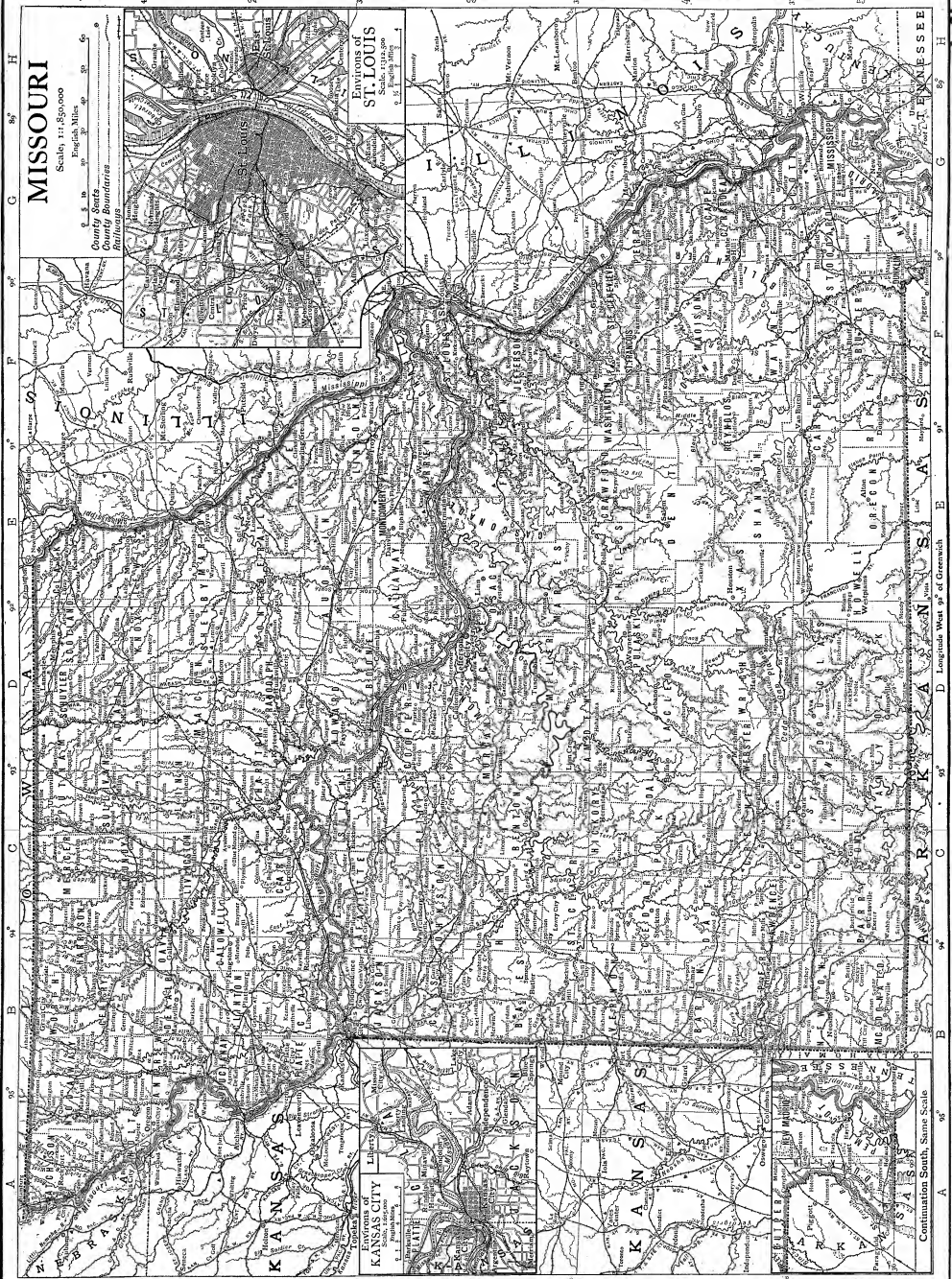

Continuation South, Same Scale

Latitude West 90° of Greenwich

embayment lies in the Austro-riparian area of the same zone. Among wild animals, deer and bear are not uncommon. Opossums, raccoons, woodchucks, foxes, grey squirrels and fox-squirrels are common. The game birds include quail ("Bob White") and partridges. Prairie chickens (pinnated grouse), pheasants and wild turkeys, all very common as late as 1880, are no longer to be found save in remote and thinly-settled districts. A state fish commission has endeavored to broaden the common varieties of river fish. So far as these are an article of general commerce, they come, like frogs, terrapin and turtles, mainly from the counties of the embayment region. Mussel fisheries, an industry confined to the Mississippi river counties from Lincoln to Lewis, are economically important, as the shells are used in the manufacture of pearl buttons. There are state fish-hatcheries at St. Louis and St. Joseph.

Flora.—The most valuable forests are in the southern half of the state, which, except where cleared for farms, is almost continuously wooded. An almost entire absence of underbrush is characteristic of Missouri forests. The finest woods are on the eastern upland and on the Mississippi lowlands. The entire woodland area of the state was estimated at 41,000 sq. m. by the national census of 1900. Ash, oaks, black and sweet gums, chestnuts, hickories, hard maple, beech, walnut and short-leaf pine are noteworthy among the trees of the Carolinian area; the tupelo and bald cypress of the embayment region, and long-leaf and loblolly pines, pecans and live oaks of the uplands, among those characteristic of the Austro-riparian. But the habitats overlap, and persimmons and magnolias, different trees are common with oaks. The heavy timber districts in the south-eastern counties (cypress, &c.), and even scattered stands of such valuable woods as walnut, white oak and red-gum, have already been considerably exploited.

Climate.—Missouri has a continental climate, with wide range of moisture and temperature. The Ozark uplift tempers very agreeably the summers in the south, but does not affect the climate of the state as a whole. The normal mean annual temperature for the entire state is about 54° F.; the normal monthly means through the year are approximately 29.6, 30°, 42°, 55.4, 64.6, 73.2, 77.1, 75.7, 68.2, 57°, 42° and 33.1° F. The south-eastern corner is crossed by an annual isotherm of 60°, the north-western by one of 50°; and although in the former region sometimes not a day in the year may show an average temperature below freezing-point, at Jefferson City there are occasionally two months of freezing weather, and at Rockport three. Nevertheless, the yearly means of the five districts into which the state is divided by the national weather service exhibit very slight differences: approximately 52.1, 52.7, 54.4, 56.1 and 55.7° respectively. The range of temperature in the north-east and south-west. On the other hand, the range in any month of local absolute temperatures over the state is habitually great (normally about 50° in the hottest and 100° or more in the coldest months), and likewise the annual range for individual localities (90° to 140°). Temperatures as high as 100° to 105° and as low as -20° or -30° are recorded locally almost every year, and the maximum range of extremes shown by the records is from 116° at Marble Hill, Bollinger county, in July, 1901, to -40° at Warsaw, Benton county, in February, 1905. The average fall of snow, which is mostly within the months from November 1 to March inclusive, ranges from about 8 in. in the south-east counties to 30 in. in the north-west counties. The Missouri river is often closed by ice, and the Mississippi at St. Louis, partly because it is obstructed by bridges, sometimes freezes over so that for weeks together horses and wagons can cross on the ice.

The average yearly rainfall for the state as a whole is about 39 in., ranging from 53.7 in. in 1898 to 25.3 in. in 1901. The prevailing winds are southerly, although west winds are common in the north. Winter storms are few and are generally dry, cool, clear and invigorating; winds from the south and east are warm, moist and depressing. Rainfall comes from the Gulf of Mexico. The south-east winds blow from the arid lands and carry rising temperatures across the state; and the winter anti-cyclones from the north-west carry low temperatures even to the southern border. Missouri lies very frequently in the dangerous quadrant of the great cyclonic storms passing over the Mississippi valley—indeed, northern Missouri lies in the area of maximum frequency of tornadoes. Few states in New States have a more varied character of soil. This variety is due to the presence of different forms of glacial drift, and to the variety of surface rocks. The northern half of the state is well watered and extremely fertile. The south-eastern embayment is rich to an exceptional degree. Speaking generally, the Ozark region is characterized by reddish clays, mixed with gravels and stones, and cultivable in inverse proportion to the amount of these elements; northern Missouri by a generally black clay loam over a clay subsoil, with practically no admixture of stones; of the southern prairies, as before referred to, share the characteristics of those parts of the Missouri; the Mississippi embayment is in parts predominantly sandy, in others clayey; it is mainly under timber. The state as a whole is devoted predominantly to agriculture. Within its borders or close about them are the centres of total and of improved farm acreage, of total farm values, of gross farm income, of the growth of Indian corn, of wheat, and of oats. In 1900 agriculture absorbed the labour of 41.3% of the total working population of the state. Of the area of the state 77.3% was

included in that year in farm land (33,997,873 acres); and of this, 67.4% was improved. The average size of a farm was 119.3 acres; 39.9% of all farm families owned a home clear of all incumbrance; and the percentages of farms operated by owners, cash tenants and share tenants were respectively 69.5, 11.0 and 19.5. Negroes worked 1.7% of the total acreage. The total value of farm-property was \$1,033,121,897. The aggregate value of farm products in 1900 was \$219,206,070, and the total value consisted of \$117,012,895 in crops (area in crops, 14,827,620 acres), \$97,841,044 in animal products, and \$4,442,131 of forest-by-products of farm operations. Indian corn is the most prominent single crop; in 1899 it was valued at \$61,246,305. Of other cereals none except wheat is produced in any quantity as compared with other states. Tobacco is grown over half the area of the state, but especially in the central and north-central counties, and cotton along the Arkansas border counties, but especially in the embayment lowlands. Orchard fruits, small fruits and grapes are produced in large quantities, and a fruit experiment station, the only institution of its kind in the country in 1900, is maintained by the state at Mountain Grove, in Wright county. To a slight extent it is possible to grow fruit of distinctively southern habit, but even pears (a prominent and valuable crop) are uncertain in returns. Apples are grown to best advantage in the north-west quarter; peaches on the Arkansas border; pears along the Mississippi; melons in the sandy regions of the embayment; small fruits in the south-west. Grapes are mainly grown in the Ozark region, and the production in amounts sufficient to place Missouri, California aside, in the front rank of wine states in the Union. Indian corn and abundant grasses give to Missouri, as to the other central prairie states, a sound basis for her livestock-interests. In 1900 the value of her live stock was \$160,540,004. Two of the four remount purchasing stations of the United States Army are at St. Louis and Kansas City. As a mule market Missouri has no rival. Sheep are herded in the southern Ozarks.

Minerals.—Coal, lead, zinc, clay, building stones and iron are the most important minerals. Cobalt and nickel are associated with lead in the St. Francois field; but though the American output is almost exclusively derived from Missouri the production is small in comparison with the amount derived from abroad. Practically the whole comes from Miue La Motte, in Madison county. Missouri is also the largest producer in the Union of tripoli and of barytes. Copper occurs in various localities, but is of economic importance only in the Ozark uplift; it was first mined in small quantities in 1837. The value of the copper mined in 1906 (based on 1905 figures) was \$54,347. Lead is produced in Missouri in alkaline chalybeate and sulphate forms, but occurs widely. Various mineral paint bases (apart from lead, zinc, baryta and kaolin) are produced in small quantities. Iron, once an extremely important product, has ceased since about 1880 to be significant in the general production of the country. But it is of great importance to the state, nevertheless, and its production has possibilities much beyond present realization. The ore occurs in two forms, haematites and limonites; the specular haematites often being grouped, for practical purposes, into two classes—those occurring in porphyry and those occurring in sandstone. The haematites are found not only in the archaic porphyries but in Cambrian limestone and sandstone, and in the sub-Carboniferous formations; while the limonites are confined almost exclusively to the Cambrian. The bedded haematites and limonites have been little exploited. Mining was begun in Iron and Crawford counties in the second decade of the 19th century; at Iron Mountain in 1846, and at Pilot Knob in the next year. Since 1880 the output of the state has been falling, and the total production up to 1902 did not exceed 9,000,000 tons of ore; in 1902 the output was 80,910 tons. Iron pyrites, which occurs widely and abundantly, has become of value as material for the preparation of sulphuric acid.

The limits of the coal belt have already been defined. The area of the Coal Measures is about 23,000 sq. m., and that of those classed by the National Geological Survey as probably productive is about 14,000 sq. m., or nearly the entire area of the lower measures. The coal is almost wholly bituminous, with very little cannelite. The seams are generally from one to five feet in thickness. Macon, Leadon and the Pilot Knob fields are the principal ones. Leadon and Bevier are the leading mining centres. The total output from 1810 to 1902 was about 78,500,000 short tons; the annual output first passed 1,000,000 tons in 1876, and 2,000,000 tons in 1882; and from 1901 to 1905 the yearly output, steadily increasing, averaged 4,196,688 tons, of a value at the mines of \$6,266,154; the output in 1908 was 5,317,315 tons, with a spot value of \$5,444,907. Superficial evidences of natural gas and petroleum are abundant in western and north-western Missouri, but these have not been found in commercially profitable quantities. The total value of natural gas from wells in Missouri in 1908 was \$22,592. A few small oil wells are open near the Kansas line. Both crude oil and natural gas are drawn from Kansas for the supply of Kansas City and other parts of western Missouri.

Lead occurs in three areas in southern Missouri. In the first, of which St. Francois county is the centre, it occurs generally alone disseminated in Cambrian limestone; in the second, of which the counties immediately south-west of Jefferson City are the centre,

it occurs with zinc in reticulated deposits and fissure veins in clays and clastic limestones; and in the third, of which Jasper county is much the most important county, the two metals occur in pockets and joints in the Burlington-Keokuk beds of the sub-Carboniferous. The first is the great lead area, the third the great zinc area; and the second is no longer of relative importance. The lead ores are galena and carbonate; the zinc ores, calamine, smithsonite and blende. The mines in the St Francois field were worked by the French from early in the 18th century. The oldest, Mine La Motte (Madison county), discovered in 1715 by De la Motte Cadillac, is still a heavy producer. St Francois county alone produces about nine-tenths the yield of the field; Madison, Washington, Jefferson and Franklin counties furnish most of the remainder. Large quantities of lead are also obtained from the zinc field of the south-west. Both the St Francois and Jasper ores yield from 70 to 75% of metal in final product, and assay even higher. It has been estimated that down to 1893 1,100,000 tons of ore, yielding metal worth \$74,000,000, had been taken from the state, fully half of this having been mined in the preceding twenty years. The total output for the state in 1908 was 114,459 tons, valued at \$12,134,556; of this 116,531 tons came from the central and south-east field, and of the remainder 15,240 tons from the Webb City—Prosperity camp. Lead was originally a leading by-product of lead mining in the south-west, and was thrown away; but it long ago became the chief product in value in this field. The so-called "Joplin district" of south-western Missouri and south-eastern Kansas—three-fourths of it being in Missouri—produces nine-tenths of all the zinc mined in the United States. Mining in south-western Missouri began about 1851, but zinc was of no importance in the output until 1872. In the next thirty-one years the aggregate product was about 3,000,000 tons of ore, worth some \$100,000,000. The output from 1894 to 1905 averaged 219,874 tons of ore yearly; in 1908 it was 107,404 tons. The history of the St Francois, Granby and Joplin districts has been sensational. The fortunes of the last few years largely revolutionized the conditions and prospects of the south-western country. Silver is found in connexion with lead and zinc mining; in 1908 the total output was 49,131 oz., valued at \$26,039. Clays occur in amounts and varieties surpassed by the deposits in very few if any states of the Union. They are in every form from the rare to the common—glass pot clay, ball clays, kaolins, flint freclays, plastic freclays, stone-ware clays, paving-brick shales, building-brick and gumbo clays. Plastic freclays, paving and brick clays are available in seemingly limitless quantities. The loess, the re-sorted residual clays, and the glacial clays are all used for the production of brick. Clays occur, in short, all over the state; and their use is almost as general. In 1905 and 1907 the rank of Missouri was sixth in the Union in the value of brick produced annually, \$6,203,411 being \$6,898,871 in 1907. There has been no more than a slight increase in the maximum utilization of these resources. Stone resources are also large. Limestones are by far the most important; red and gray granites, sandstones and marble (Ste Genevieve county) being of little more than local importance. In 1908 the total value of stone quarried was \$2,306,058. Tripoli is quarried particularly in Newton county, where it has been produced since 1872, and though not produced in great quantities has value from its general scarcity. This Missouri tripoli is a finely decomposed light rock, about 98% silica, and is used for filter stones and as an abrasive. "Chat"—finely crushed flint and limestone yielded as tailings in the lead and zinc mines—finds many uses. Limestone is quarried all over the state (except in the embayment region). There are unlimited supplies of clay, shale and limestone, the three essential constituents of Portland cement, and the manufacture of this, begun in 1902, at once assumed important proportions. Quicklime manufacture is also an important industry. In 1908 the product of quicklime was 167,060 tons.

Manufactures.—Manufacturing and mechanical pursuits absorbed in 1900 the labours of 19.5% of all persons engaged in gainful occupations, less than half as many as were engaged in agriculture. Though an agricultural state, Missouri had in 1900 three cities with populations of above 100,000, whose wealth is based on manufactures and trade. Missouri is the leading manufacturing state west of the Mississippi. Between 1880 and 1900 the value of the product increased from \$165,386,205 to \$3,629,584,984, of which in 1905, \$16,304,095 was the value of products of the "factory system". In 1905 the factory product was valued at \$439,548,957. Of the total output in 1900, three-fourths were made up by the output of St Louis (\$233,629,733; of which \$193,732,788 was from establishments under the "factory system"), Kansas City (\$36,527,392; \$23,588,653 being "factory product"), St Joseph (\$31,690,736, including the product of some establishments outside the city limits; \$11,361,939 being "factory product" within the city limits), and Springfield (\$4,126,871; \$3,433,800 being "factory product"); for the same four cities in 1905 the proportion of the state's total product (\$439,548,957) manufactured under the "factory system" is smaller, and less than three-fourths was made up by the following seven cities: St Louis (\$267,307,038), Kansas City (\$35,573,049), St Joseph (\$11,573,720), Springfield (\$5,293,333), Hannibal (\$4,442,099), Jefferson (\$3,926,633), and Joplin (\$3,006,203). In 1905 the eleven municipalities with a population of at least 8000 each (including the seven above, and Carthage,

Moberly, Sedalia and Webb City) produced, under the "factory system", goods valued at \$335,431,978. Eighteen industries in 1905 employed nearly three-fifths of the wage-earners in factories and were represented by nearly two-thirds (\$293,882,705) of the total product. The most prominent items in this were slaughtering and meat-packing products (value \$60,031,133 in 1905); tobacco (in 1905, \$30,884,182), flour and grist-mill products (in 1905, \$38,026,142); malt liquors (in 1905, \$24,154,264), boots and shoes (in 1905, \$23,493,552), lumber and timber products (in 1905, \$10,903,783), men's factory-made clothing (in 1905, \$8,872,831), and hats and general shop construction and repairs by street railways (in 1905, \$8,720,433). The increase in the slaughtering industry between 1890 and 1900 (134.9%) was chiefly due to remarkable growth in St Joseph—or, to be more precise, just outside the city limits of St Joseph; between 1900 and 1905 the increase was 39.5%. Although Missouri is not a great tobacco state, St Louis is one of the greatest centres of the country in the output of tobacco products. It is also, for the state, the great centre of all the leading interests with the exception of slaughtering. The boot and shoe industry is new west of the Mississippi, but Missouri holds in it a high and rising rank. In the Joplin mining region a considerable amount of ores is smelted, but the bulk of the ores is sent into Kansas for smelting. The finer clays, also, are mainly shipped from the state in natural form, but in the manufacture of sewer-pipe and fire-brick, Missouri is a very prominent state. St Louis and Kansas City are the centres of the clay industries.

Communications.—In 1900 rather under a fifth of the working population were engaged in trade and transportation. In commerce as well as in manufactures St Louis is first among the cities of the state, but Kansas City also is one of the greatest railway centres of the country, and the trade with the south-west, which St Louis once held almost undisputed, has been greatly cut into by Kansas City, as well as by Galveston and other ports on the Gulf. There is still considerable commerce on the Mississippi from St Louis to New Orleans, and a few passenger steamers are still in service. In 1906-1907 there was a notable agitation for improvement of the state in natural voyages that proved the navigability of the Missouri up to Kansas City. For this part of the river the maximum draft at mean low water was 4 ft. in 1908. In 1907 the amount of freight carried from the mouth of the Missouri to Sioux City, Iowa, was 843,863 tons, and river rates were about 60% of railway rates. In 1907 estimates were made for 6 ft. and 12 ft. channels from Sioux City to Kansas City, and from Kansas City to the mouth of the river. The improvement of the Missouri—which is far more difficult to navigate than the Mississippi—was begun by Congress in 1832, and (in addition to large joint appropriations for the Missouri, Mississippi, Arkansas and Ohio rivers from 1832 to 1882) cost \$11,130,560 between 1876 and 1900. Also \$65,000 were expended between 1882 and 1876. In nothing except the freighting of bulky and imperishable products, like cotton, coal and cereals, was the river ever able to contest the monopoly of the railways. The mileage of these within the state rose from 3960 in 1880 to 6142 in 1890, and to 8023.94 in 1908; the Missouri Pacific being far the greatest system of the state. St Louis, Kansas City and St Joseph are ports of entry for foreign commerce.

Population.—The total population of Missouri in 1900 was 3,106,665 and in 1910, 3,293,335. The population in 1810 was 20,845; in 1820, 66,586; in 1830, 140,455; in 1840, 383,702; in 1850, 682,044; in 1860, 1,182,012; in 1870, 1,721,295; in 1880, 2,168,380; and in 1890, 2,679,184. Thus, even in the years of the Civil War, there was no apparent set-back. Of the aggregate of 1900, 63.7% lived in "rural districts" (i.e. those outside all places of a population of 2500 or upwards), and 27.1% in the three great cities of the state, St Louis (pop. 575,238), Kansas City (163,752) and St Joseph (102,079); 5.2% were negroes—their increase from 1890 to 1900 being less than half as rapid as that of the whites; and 7.0% only were foreign-born. Slightly more than half of all foreigners are Germans; Irish, English and Scotch, French and English Canadians, Swiss and Scandinavians following. The German element is, and has been since about 1850, of great importance—an importance not indicated at all by its apparently small strength in the population to-day. The German immigration began about 1845, and long ago passed its maximum, so that in 1900 more than half of all the foreign-born (not only the Germans, but also the later-coming nationalities) had lived within Missouri for more than twenty years, and more than three-fourths of all had been residents of the state for ten

1 Omitting here printing and publishing, and foundry and machine-shop products, which (like carpentering, bakery products, &c., in cities) have little distinctive in them to set Missouri off from other states. But it is to be noted that St Louis is one of the leading producers of street-railway cars.

years or more. Thus the foreign element is an old one, and other statistics show that it is being effectively absorbed into the native mass by intermarriage.¹ The German influence has been felt in education and in the anti-slavery cause. The early settlers of the state were practically all from Kentucky, Tennessee, Virginia and the old slave-states of the south-east, and their influence was easily dominant in the state until well after the Civil War (about 1875), when northerners first began to enter the state in large numbers. The south-western Ozarks were settled originally by mountaineers from Kentucky and Tennessee, and retained a character of social primitiveness and industrial backwardness until after the Civil War. This region has been industrially regenerated by the mine development. In addition to St Louis,² Kansas City and St Joseph, the leading cities in 1900 were Joplin, Springfield, Sedalia, Hannibal, Jefferson City, Carthage, Webb City and Moberly.

As Missouri was originally a French colony the Roman Catholic is its oldest church; and it is still the strongest with 382,642 communicants in 1906 out of a total of 1,199,239 for all denominations. In the same year there were 218,353 Baptists, 214,004 Methodists, 166,137 Disciples of Christ, 71,599 Presbyterians, 45,018 Lutherans, and 32,715 members of the German Evangelical Synod of North America.

Administration.—Three constitutions, framed by conventions in 1820, 1865 and 1875, have been adopted by the people of the state, and a fourth (1845) was rejected, principally because it provided for popular election of the state judiciary, which was then appointed. In addition to these four constitutional conventions, mention should be made of the special body chosen in 1861 to decide the question of secession, which retained supreme though irregular control of the state during the Civil War, and some of whose acts had all the force of promulgated constitutional amendments. Universal manhood suffrage was established by the first constitution. The constitution of 1865 was a partisan and intolerant document, a part of the evil aftermath of war; it was adopted by an insignificant majority and never had any strength in public sentiment.³ The present constitution (that of 1875) was a notable piece of work when framed. The term of the governor and other chief executive officers, which had been four years until the adoption of the constitution of 1865, under which it was two years, was restored to the long term (unusual in American practice). The legislature (or, as it is called in Missouri, General Assembly) had been permitted to hold adjourned sessions under the constitution of 1865. This expensive practice was abolished; various checks were placed upon legislative extravagance, and upon financial, special and local legislation generally; and among reform provisions, common enough to-day, but uncommon in 1875, were those forbidding the General Assembly to make irrevocable grants of special privileges and immunities; requiring finance officials of the state to clear their accounts precedent to further eligibility to public office; preventing private gain to state officials through the deposit of public moneys in banks, or otherwise; and permitting the governor to veto specific items in general appropriation bills. The grand jury was reduced to twelve members, and nine concurring may indict. The township system may be adopted by county option, but has not been widely established, though purely administrative (not corporate) "townships" are an essential part of state administration. St Louis and Kansas City have adopted their own charters under constitutional provision. Up to 1909 37 constitutional amendments were submitted to the people for adoption or rejection, and 22 were adopted. Three of these (1900) restrict the calling of the grand jury, permit two-thirds of a petit jury to render verdicts in courts not of record, and three-fourths to give verdict in civil

¹ In 1900 only one person in six had both parents of foreign birth.

² St Louis was the capital in 1812-1820, St Charles in 1820-1826, and Jefferson City since 1826.

³ After the proscriptive features of this constitution were abolished by amendments in 1870, however, there was no great discontent, and the vote for holding a constitutional convention in 1875 was very close: 111,299 to 111,016.

cases in courts of record. Cities have been allowed (1892), upon authorization by the General Assembly, to organize pension systems for disabled firemen, but not allowed (1904) to organize the same for police forces. An amendment which was adopted (177,615 for; 147,290 against) in November 1908, and came in effect on the 4th of December 1908, provides for initiative and referendum applying to statutory law and to constitutional amendments, but emergency measures, and appropriations for the state government, for state institutions, and for public schools are exempt from referendum. Initiative petitions, signed by at least 8% of the legal voters in each of two-thirds (at least) of the congressional districts of the state, must be filed not later than four months before the election at which the measure is to be voted upon. The referendum may be ordered by the legislature or by a petition signed by at least 5% of the legal voters in each of two-thirds (at least) of the congressional districts of the state; such petition must be filed not more than 90 days after the final adjournment of the legislature; referred measures become law upon receiving a favourable majority of the popular vote. Among defeated amendments that are indicative of socio-political tendencies was one (1896) to authorize cities of a population of 30,000 or more to purchase, erect or maintain waterworks or lighting plants.

There is nothing extraordinary in the general judicial system. The civil law seems to have had only a tacit, and as soon as American immigration became a limited, application. The common law was introduced with the American settler, and after 1804 was the explicitly declared basis of judicature. Practically no trace of French and Spanish administration was left except in the land registers. The metropolitan primacy of St Louis and Kansas City is reflected in the general organization of the courts. The Bureau of Labor Statistics maintains free employment-bureaus in St Louis, Kansas City and St Joseph. There is also a State Board of Mediation and Arbitration to settle labour disputes. A Board of Railroad and Warehouse Commissioners, elected by the people, was established in 1875, under a provision of the constitution requiring the General Assembly to establish maximum rates and provide against discriminations.⁴

The homestead of a housekeeper or head of a family, together with the rents and products of the same, is exempt from levy and attachment except to satisfy its liabilities at the time he acquired it. A homestead so exempted is, however, limited to 18 sq. rods of ground and to \$3000 in value if it is in a city having a population of 40,000 or more, to 30 sq. rods and \$1500 in value if it is in a city having a population of 10,000 and less than 40,000, to 5 acres and \$7500 in value if it is in an incorporated place having a population of less than 10,000, and to 160 acres and \$1500 in value if it is in the country. A husband owning a homestead is debarred from selling or mortgaging it without the joinder of his wife, and if the husband dies leaving a widow or minor children the homestead passes to either or to both jointly, and may be so held until the youngest child is twenty-one years of age or until the marriage or death of the widow. The principal grounds for divorce are impotence, bigamy, adultery, conviction of felony or other infamous crime subsequent to the marriage or before the marriage if unknown to the other party, desertion or habitual drunkenness for one year, such cruel or barbarous treatment as to endanger the life of the other, such conduct as to render the condition of the other intolerable, and vagrancy of the husband; but before applying for a divorce the plaintiff must reside in the state for one year immediately preceding, unless the cause of action was given within the state or while the plaintiff was a resident of the state. A married woman may hold and manage property as if she were single. She is entitled to the wages for her separate labour and that of her children, and is not liable for her husband's debts. A widow has a dower right to his personal or her husband's real estate and to the share of a child in his personal estate. If a husband dies without leaving children, or other descendants, the wife is entitled to all the real and personal estate which came to him by marriage, to what remains of the personal property which came into his possession by the written consent of his wife, and to one-half his other real and personal property at the time of his death. If a husband dies leaving descendants only by a former marriage, the widow may take in lieu of dower the personal property that came to him by means of marriage, or if there be children by both marriages she may take in lieu of her dower right to his real estate an absolute right therein equivalent to the share of a child. Her dower is not lost by a divorce resulting from the fault or misconduct of the husband. A widow is entitled to a share in his wife's personal estate equal to the share of a child, and if there are

⁴ In 1907, in Missouri, as in various other states, passenger rates were reduced by law to 2 cents per mile; but this law was declared unconstitutional in 1909.

no descendants he has an absolute right to one-half of her property, both real and personal.

Finance.—Revenue is drawn mainly from a general property tax. In 1904 the gross valuation of all taxable wealth was put at \$1,155,402,647, and taxation for state purposes aggregated \$0.17 per \$1000.¹ In the years 1851-1857 a debt of \$23,701,000 was incurred in aiding railways, and all the roads made default during the Civil War. The state could not meet its guarantee obligations (under the strict bonding provisions of the constitution of 1875), and in 1865 had a bonded debt of above \$36,000,000. This was reduced to \$21,675,000 by 1869, and in 1903 was wholly extinguished, every obligation having been fully discharged. A small debt² (at the close of 1906, \$4,398,839) is carried in the form of non-negotiable state certificates of indebtedness issued in exchange for money taken from the educational funds of the state, and is intended as a permanent obligation to those funds. An amendment to the constitution adopted in 1908 permitted counties to make an extra levy of 25 cents on each 100 dollars valuation for the construction and repair of roads and bridges.

Charitable and Penal Institutions.—The charitable and penal institutions of the state include the penitentiary at Jefferson City, opened in 1836, which is self-supporting; a training school for boys at Boonville (opened 1889), an industrial home for girls at Chillicothe (established 1887), hospitals for the insane at Fulton (1847), St Joseph (opened 1874), Nevada (1887), and Farmington (1890); a school for the blind at St Louis (opened 1851); a school for the deaf at Fulton (opened 1851); a colony for the feeble-minded and epileptic at Marshall (established 1890); a state sanatorium, for consumptives, at Mount Vernon (established 1905, opened 1907); a Federal soldiers' home at St James, and a Confederate soldiers' home at Higginsonville (established 1897).

Education.—The expenditure upon public schools is much greater in Missouri than in any other of the old slave states. Most of the total expenditure (in 1908, \$12,769,690) is made possible by local taxation. The percentage of the enumerated school-population (children 6 to 20 years of age) attending school in 1908 was 48, and the percentage of the total enumeration enrolled was about 71; the general showing being excellent, and that for negroes remarkably so. Blacks and whites are segregated in all schools. Various high-schools scattered over the state are given over to the negroes; and in 1904 the number of pupils attending these was exceeded only by the corresponding number in Tennessee and Mississippi—with first prizes being held by the negro population of Missouri. Illiterate persons above 10 years of age constituted in 1900 6.4% of the total population—28.1% of the negroes, 7.1% of the natives, 6.9% of the foreign-born. The idea of providing a university and free local schools as parts of a public school system occurs in the constitution of 1820 (and in the Acts of Congress that prepared the way for statehood), and the occurrence is noteworthy; but the real beginnings of the system scarcely go back further than 1850. Nor was very much progress made until a law was passed in 1853 requiring a quarter of the general yearly revenue of the state to be distributed among the counties for schools. This appropriation was made regularly after 1855 (save in 1861-1867), and since 1875 has rested on a constitutional provision. The maintenance of a free public school system was placed on a firm and broad foundation by the constitution adopted in that year. In the years after 1887 one-third of the total revenue was appropriated to the public common schools; and in 1908 the total appropriation for public schools, normal schools and the state university was about three-fifths of the entire state revenue. Local taxation is another source of the school funds. In 1908 the total school fund, including state, county, township and special district funds, was about \$14,000,000, of which the state fund was nearly one-third. The schools of St Louis have a very high reputation.

Among institutions of higher learning the university of Missouri at Columbia is the chief one maintained by the state. It was opened to students in 1841, received aid for the first time from the state in 1867; women were first admitted to the normal department in 1869, to the academic department in 1870, and soon afterwards to all departments. In addition to the academic department or college proper, the university embraces special schools of pedagogy (1868), agriculture and mechanic arts (1870), mines and metallurgy (1870, at Rolla), law (1872), medicine (1873), fine arts (1878), engineering (1877), military science, commerce, a graduate school of arts and sciences (1896), and a department of journalism (1908). An experiment station supported by the national government was established in 1888, and is part of the school of agriculture. The state Board of Agriculture organizes educational farmers' institutes; and agriculture is taught, moreover, in the normal schools of the

state. Of these five are maintained as follows: at Kirksville (1870), at Warrensburg (established 1870), at Cape Girardeau (established 1873), at Springfield (established 1905), at Maryville (established 1905), and there is a normal department in connexion with the Lincoln Institute, for negroes, at Jefferson City. Lincoln Institute (opened in 1866) is for negro men and women. The basis of its endowment was a fund of \$6379 contributed in 1866 by the 62nd and 65th regiments U.S. Colored Infantry upon their discharge from the service; it has agricultural, industrial, sub-normal, normal and collegiate departments. Among privately endowed schools the greatest is Washington University in St Louis; it is non-sectarian and was opened in 1857. Noteworthy, too, is the St Louis University, opened in 1829, the oldest institution for higher learning west of the Mississippi; it is a Jesuit college and the parent school of six other Jesuit institutions in the states of the middle west. There are many minor colleges and schools, most of them co-educational, and special colleges or academies for women are maintained by different religious sects. Finally, there are various professional schools, most of them in St Louis and Kansas City.

History.—The early French explorers of the Mississippi valley left the first trace of European connexion in the history of Missouri. Ste Genevieve was settled in 1733; Fort Orleans, two-thirds of the way across the state up the Missouri river, had been temporarily established in 1720; the famous Mine La Motte, in Madison county, was opened about the same time; and before the settlement of St Louis, the Missouri river was known to trappers and hunters for hundreds of miles above its mouth. It was in 1764 that St Louis (*q.v.*) was founded. Two years before, the portion of Louisiana west of the Mississippi had secretly passed to Spain, and in 1763 the portion east passed to England. When the English took possession a large part of the people in the old French settlements removed west of the river. Not until 1770, after O'Reilly had established Spanish rule by force at New Orleans, did a Spanish officer at St Louis take actual possession of the upper country; another on the ground, in 1768-1769, had forborne to assert his powers in the face of the unfriendly attitude of the inhabitants. Spanish administration began in 1771. French remained the official language, and administration was so little altered that the people quickly grew reconciled to their changed allegiance. Settlement was confined to a fringe of villages along the Mississippi. French-Canadian hunters and trappers, and soon the river boatmen, added an element of adventure and colour in the primitive life of the colony. Lead and salt and peltries were sent to Montreal, New Orleans, and up the Ohio river to the Atlantic cities.

The Americans were hospitably received; the immigrants, even Protestant clergymen, enjoyed by official goodwill complete religious toleration; and after about 1796 lavish land grants to Americans were made by the authorities, who wished to strengthen the colony against anticipated attacks by the British, from Canada. Kentucky, Tennessee and Virginia furnished most of the new-comers. The French had lived in villages and maintained considerable communal life; the Americans scattered on homesteads. With them came land speculation, litigiousness, the development of mines and mining-camp law, and the passion of politics, of which duels were one feature of early days. In 1804 there were some 10,000 inhabitants in Upper Louisiana (mainly in Missouri), and of these three-fifths were Americans and their negroes. Racial antipathies were unimportant, and all parties were at least passively acquiescent when Louisiana became a part of the United States. On the 9th of March 1804, at St Louis, Upper Louisiana was formally transferred. In 1818, after passing meanwhile through four stages of limited self-government,³ that portion of the Purchase now included in the state of Missouri made application for admission to the Union as a state.⁴ In 1812-1813 a remarkable earthquake devastated the region about New Madrid. A large region was sunken, enormous fissures were opened in the earth, the surface soil was displaced

¹ The constitutional provision requiring assessments at cash valuations is not at all observed; according to the State Revenue Commission of 1902 the average tax valuation was 40 to 50% of the real value. The national censuses of 1880 and 1890 (no estimate being made in 1900) put the total value of all property at \$1,562,000,000 and \$2,397,902,945 respectively.

² In 1902 the bonded debts of counties and townships aggregated \$8,066,878; that of towns and cities (mostly that of St Louis), \$31,193,870.

³ In 1804, the District of Louisiana, in the administrative system of the Territory of Indiana; in 1805, an independent government, renamed the Territory of Louisiana; in 1812, the Territory of Missouri; in 1816, another grade of territorial government.

⁴ Until 1836 the state boundary in the north-west was the meridian of the mouth of the Kansas river drawn due north to the Iowa line. The addition of the triangle west of that line—the so-called Platte Purchase—violated the Missouri Compromise.

and altered, and great lakes were formed along the Mississippi. One of these, Reelfoot Lake, east of the river, is 20 m. long and 7 wide, and so deep that boats sail over the submerged tops of tall trees. Indian troubles again disturbed the peace during the second war with Great Britain. By 1808 the Indian title was extinguished to two-thirds of the state, though actual settlement did not extend more than a few miles westward from the Mississippi; in 1825, by a treaty with the Shawnee made at St Louis on the 7th of November, the title to the rest of the state was cleared, and a general removal of the Indians followed. Meanwhile, after the peace of 1815 a great immigration had set in, many settlers coming from the free states north of the Ohio. The application for statehood precipitated one of the most famous and significant episodes of national history—the Missouri Compromise (*q.v.*). In August 1821, after three years of bitter controversy, Missouri was formally admitted to statehood.

In the four decades before the Civil War, two matters stand out as most distinctive in the history of the state: the trouble with the Mormons, and the growth of river and prairie trade. In 1831–1832 Joseph Smith, the Mormon leader, selected a tract at the mouth of the Kansas river as the site of the New Jerusalem, to which his followers came from Ohio in 1832. They were not welcome. Their "revelations" in their papers predicted dire things for the Gentiles; they were thrifty and well-to-do, and were rapidly widening their lands; they were accused of disregard for Gentile property titles, and they obstructed the processes of Gentile law within their lands. In 1833 the Missourians, in mass meeting, resolved to drive them from the country. The five years thereafter were marked by plunder and abuse of the sect. The militia and the courts gave them no protection. They were driven out, and went to Illinois, but continued to hold part of their abandoned lands. First St Louis, and then other towns on the Missouri river in succession westward, as they were settled and became available as *dépôts*, served as the outfit points for the Indian trade up the Missouri and the trade with Mexico through Santa Fé. The trail followed by the latter had its beginning about 1812, and (beginning in 1825) was surveyed by the national government. In early days Mexican and American military detachments escorted the caravans on either side of the international line. Independence, Missouri (after about 1831) and Kansas City (after 1844) were the great centres of this trade, which by 1860 was of national importance.¹ After the Civil War the railways gradually destroyed it, the Atchison Topeka & Santa Fé railroad running along the old wagon trail. No steamer traversed the Mississippi above the Ohio until 1817, nor was a voyage made from New Orleans and St Louis, nor the lower Missouri entered, until 1819. In 1832 a steamer ran to the mouth of the Yellowstone, and in 1890 the last commercial trip was made to old Fort Benton (Great Falls), Montana. The interval of years witnessed the growth of a river trade and its gradual decline as point after point on the river—Kansas City, St Joseph, Council Bluffs (Iowa), Sioux Falls (South Dakota) and Helena (Montana)—was reached and commanded by the railways. In 1906–1907 an active campaign was begun at Kansas City for improving the channel of the Missouri and stimulating river freighting below that point.

Among events leading up to the Civil War, first the annexation of Texas and then the war with Mexico left special impress on Missouri history. Since 1828, when national political parties were first thoroughly organized in the state, the Democrats had been supreme, and carried Missouri on the pro-slavery side of every issue of free and slave territory. But there was always a strong body of anti-slavery sentiment,² nevertheless; and this

¹ In 1855 its value was estimated at \$5,000,000. In 1860 it was much greater. In the latter year the trade employed 3000 wagons, 62,000 oxen and mules, and 7000 men.

² Under the constitution of 1820 the General Assembly had power to emancipate the slaves with the consent of their masters. In 1828 Senator T. H. Benton and others prepared a plan for educating the slaves and gradually emancipating them under state law; and undoubtedly a considerable party would have supported such a project, for the Whigs and Democrats were then divided along party lines on the slavery issue; but nothing

took organized form in 1849, when Senator Benton repudiated certain ultra pro-slavery instructions, breathing a secession spirit, passed by the General Assembly for the guidance of the representatives of the state in Congress. From that time until his death he organized and led the anti-disunion party of the state, Francis Preston Blair, jun., succeeding him as leader. The struggle over Kansas (*q.v.*) aroused tremendous passion in Missouri. Her border counties furnished the bogus citizens who invaded Kansas to carry the first territorial elections, and soon guerrilla forays back and forth gave over the border to a carnival of crime and plunder. Political conditions were chaotic. In the presidential election of 1860, Douglas received the electoral vote of the state, the only one he carried in the Union. The Republicans had little strength outside St Louis, where the German element was strong. A party led by Claiborne F. Jackson, the governor-elect, was resolved to carry the state out of the Union. Such secession, it was supposed, would carry the other border states out also. With equal blindness the Secessionists favoured, and the Republicans opposed, the calling of a special state convention to decide the issue of secession. The election showed that popular sentiment was overwhelmingly hostile to secession; and the convention, by a vote of 80 to 1, resolved (March 4, 1861) that Missouri had "no adequate cause" therefor. Governor Jackson thereupon sought to attain his ends by intrigue, and the national arsenal at St Louis became the objective of both parties. It was won by the unconditional-union men, but a smaller arsenal at Liberty was seized by the Secessionists. Governor Jackson refused point-blank to contribute the quota of troops from Missouri called for by President Lincoln. Aggressive hostility really opened at St Louis on the 10th of May, and armed conflicts began in June. On the 10th of August 1861 at Wilson's Creek, near Springfield, General Nathaniel Lyon was defeated by a superior Confederate force in one of the bloodiest battles of the war. After this the Confederates held much of southern Missouri until the next spring, when they were driven into Arkansas, never afterward regaining foothold in the state. In the autumn of 1864 Sterling Price led a brilliant but rather bootless Confederate raid across the state, along the Missouri River, and was only forced to retreat southward by defeat at Westport (Kansas City). The western border was rendered desolate and deserted by guerrilla forays throughout the war. Probably 25,000 or 30,000 soldiers served in the Confederate armies, and 109,111 were furnished to the Union arms.³ This was a remarkable showing. There was more or less internecine conflict throughout the war, and local disaffection under Union rule; and Confederate recruiting was carried on even north of the Missouri.

Altogether, the state offered a difficult civil and military problem throughout the Civil War. An emancipation proclamation issued by General J. C. Frémont at St Louis in August 1861, though promptly disavowed by President Lincoln, precipitated the issue. The state convention, after voting against secession, had adjourned, and after various sessions was dissolved in October 1863. Assuming revolutionary powers, it deposed Governor Jackson and other state officers, appointed their successors, declared vacant the seats of members of the Assembly, and abrogated the disloyal acts of that body. In October 1861 a rump of the deposed Assembly passed an act of secession, which the Confederate States saw fit to regard as legitimate, and under which they admitted Missouri to their union by declaration of the 28th of November. In 1862 the convention rejected the President's suggestion of gradual emancipation, disfranchised Secessionists, and prepared a strong oath of allegiance. In the summer of 1863 the convention decreed emancipation with compensation to owners. This did not satisfy the Radical Republicans, and on the issue of

came of the plan, and the manner of its defect proves that it could not possibly have been pushed to success. The trouble over Lovejoy's printing office at St Louis (1833–1836) put an effectual end to the movement for emancipation.

³ Compare the vote of 1861. The Union death-roll of Massachusetts (troops furnished, 159,165) was 13,942, that of Missouri 13,887.

immediate and unconditional emancipation they swept the state in November 1864. By the constitution of 1865 slavery was abolished outright.¹ The convention of 1861, by maintaining continuous government, had saved the state from anarchy and from reconstruction by the national power; but an ironclad test oath (it required denial of forty-five distinct offences) was provided, to be taken by all voters, state, county and municipal officers, lawyers, jurors, teachers and clergymen. Its attempted enforcement was a grave error of judgment, and was attended by great abuses, and it was finally held unconstitutional by the United States Supreme Court. The legislature, however, maintained its ends by registration laws that reduced to impotence the Democratic electorate. The Radical Republicans held control until 1870, when they were defeated by a combination of Liberal Republicans and Democrats,² and the test-oath and the rest of the intolerant legislation of the war period were swept away. In 1872 the Democrats gained substantial control, and after 1876 their power was established beyond challenge. The constitution of 1875 closed the war period with blanket amnesties. Though in politics habitually Democratic, Missouri has generally had a strong opposition party—Whig in antebellum days, and since the war, Republican—which in recent years has made political conditions increasingly unstable. This instability is shown in congressional and local rather than in general state elections. In 1908 a Republican governor was elected, the first for more than thirty years.

The Governors of Missouri since 1804 have been as follows:—
Territorial Period.

	Party Affiliation.	Service.
James Wilkinson	Appointed	1805-1806
Joseph Brown (acting governor)		1806-1807
Frederick Bates		1807
Meriwether Lewis	Appointed	1807-1809
Frederick Bates (acting governor)		1809-1810
Benjamin Howard	Appointed	1810-1812
Frederick Bates (acting governor)		1812-1813
William Clark	Appointed	1813-1820
<i>State Period.</i>		
Alexander McNair	Democrat	1820-1824 ³
Frederick Bates (died in office)		1824-1825
Abraham J. Williams (acting governor)		1825
John Miller (special election to fill out term)		1825-1828
John Miller	Democrat	1828-1832
Daniel Dunklin (resigned office)		1832-1836
Lilburn W. Boggs (acting governor)		1836
Lilburn W. Boggs	Democrat	1836-1840
Thomas Reynolds (died in office)		1840-1844
M. M. Marmaduke (acting governor)		1844
John C. Edwards	Democrat	1844-1848
Austin A. King		1848-1853
Sterling Price		1853-1857
Truster Polk (elected to United States Senate)		1857
Hancock Jackson (acting governor)		1857
Robert M. Stewart (elected to serve out term)	Democrat	1857-1861
Claiborne F. Jackson (deposed by state convention)		1861

¹ Thus liberating about 114,000 blacks, of a tax valuation of \$40,000,000.

² The Liberals were those who thought unjust the proscriptionary legislation passed against the Secessionists and Democrats; and to this issue of local politics were added the issues of national reform which the course of President Grant's administration had forced upon his party. A convention of Liberals that met at Jefferson City in January 1872 issued to all Republicans favourable to reform within the party an invitation to meet at Cincinnati in May; and this was the convention of revolvers against General Grant that nominated Horace Greeley of New York and B. Gratz Brown of Missouri as Liberal Republican candidates for the presidency and vice-presidency respectively. The first definite organization of the Liberal Republican party may therefore be said to have been made in Missouri in 1870.

³ From 1820-1844 the elections were in August and inaugurations in November; Governor King served from the 27th of December 1848 till January 1853; thereafter the inauguration was in January, and beginning with 1864 the election was in November. The term was four years except under the constitution of 1865.

	Party Affiliation.	Service.
Hamilton R. Gamble (appointed by state convention; died in office), provisional governor		1861-1864
Willard P. Hall (Lieut.-governor by same power, acting provisional governor)		1864-1865
Thomas C. Fletcher	Republican	1865-1869
Joseph W. McClurg		1869-1871
B. Gratz Brown	Liberal Republican (and Democrat)	1871-1873
Silas Woodson		1873-1875
Charles H. Hardin	Democrat	1875-1877
John S. Phelps		1877-1885
Thomas T. Crittenden		1881-1885
John S. Marmaduke (died in office)		1885-1887
Albert P. Morehouse (acting governor)		1887-1889
David R. Francis	Democrat	1889-1893
William J. Stone		1893-1897
Lon V. Stephens		1897-1901
Alexander M. Dockerey		1901-1905
Joseph W. Folk		1905-1909
Herbert S. Hadley	Republican	1909

BIBLIOGRAPHY.—For Physiography: See *Surface Features of Missouri* (in Missouri Geological Survey Reports, vol. x., Jefferson City, 1896); publications of the State Bureau of Geology and Mines, including bulletins and reports of the Missouri Geological Survey (483 seq.; new series, 15 vols., 1891-1904); publications of United States Geological Survey, particularly *Bulletins* 132, 213, 267, the 22nd *Annual Report*, part ii, pp. 23-27, &c.; and reports of state departments. On administration: the annual *Official Manual of the State of Missouri* (really private, Jefferson City); also F. N. Judson, *Law and Practice of Taxation in Missouri* (Columbia, 1900); M. S. Snow, *Higher Education in Missouri* (U.S. Bureau of Education, Washington, 1898). On History: Lucian Carr, *Missouri ("American Commonwealths" Series, Boston, 1892)*; L. Houck, *Spanish Régime in Missouri* (3 vols., Chicago, 1910); T. L. Sneed, *The Fight for Missouri* (New York, 1886); Wiley Britton, *The Civil War on the Border* (2 vols., New York, 1891-1899; 3rd ed. of vol. 1, revised, 1899); H. M. Crittenden, *History of Early Steamboat Navigation on the Missouri River* (2 vols., New York, 1901); W. B. Davis and D. S. Durrie, *An Illustrated History of Missouri* (St. Louis, 1876); *Encyclopedia of the History of Missouri* . . . ed. by H. L. Conrad (6 vols., New York, St. Louis, 1901).

MISSOURI COMPROMISE, an agreement (1820) between the pro-slavery and anti-slavery factions in the United States, involving primarily the regulation of slavery in the public territories. A bill to enable the people of Missouri to form a state government preliminary to admission into the Union came before the House of Representatives in Committee of the Whole, on the 13th of February 1819. An amendment offered by James Tallmadge (1778-1853) of New York, which provided that the further introduction of slaves into Missouri should be forbidden, and that all children of slave parents born in the state after its admission should be free at the age of twenty-five, was adopted by the committee and incorporated in the Bill as finally passed (Feb. 17) by the house. The Senate refused to concur in the amendment and the whole measure was lost. During the following session (1819-1820), the house passed a similar bill with an amendment introduced on the 26th of January 1820 by John W. Taylor (1784-1854) of New York making the admission of the state conditional upon its adoption of a constitution prohibiting slavery. In the meantime the question had been complicated by the admission in December of Alabama, a slave state (the number of slave and free states now becoming equal), and by the passage through the house (Jan. 3, 1820) of a bill to admit Maine, a free state. The Senate decided to connect the two measures, and passed a bill for the admission of Maine with an amendment enabling the people of Missouri to form a state constitution. Before the bill was returned to the house a second amendment was adopted on the motion of J. B. Thomas (1777-1850) of Illinois, excluding slavery from the "Louisiana Purchase" north of 36° 30' (the southern boundary of Missouri), except within the limits of the proposed state of Missouri. The House of Representatives refused to accept this and a conference committee was appointed. There was now a controversy between the two houses not only

on the slavery issue, but also on the parliamentary question of the inclusion of Maine and Missouri within the same bill. The committee recommended the enactment of two laws, one for the admission of Maine, the other an enabling act for Missouri without any restrictions on slavery but including the Thomas amendment. This was agreed to by both houses, and the measures were passed, and were signed by President Monroe respectively on the 3rd and on the 6th of March 1820. When the question of the final admission of Missouri came up during the session of 1820-1821 the struggle was revived over a clause in the new constitution (1820) requiring the exclusion of free negroes and mulattoes from the state. Through the influence of Henry Clay an act of admission was finally passed, to come into operation as soon as the state legislature would pledge itself not to pass any legislation to enforce this clause. This is sometimes known as the second Missouri Compromise.

These disputes, involving as they did the question of the relative powers of Congress and the states, tended to turn the Democratic-Republicans, who were becoming nationalized, back again toward their old state sovereignty principles—to prepare the way for the Jacksonian-Democratic Party. On the other hand, the old Federalist nationalistic element was soon to emerge first as National Republicans, then as Whigs, and finally as Republicans. On the constitutional side the Compromise of 1820 was important as the first precedent for the congressional exclusion of slavery from public territory acquired since the adoption of the Constitution, and also as a clear recognition that Congress has no right to impose upon a state asking for admission into the Union conditions which do not apply to those states already in the Union. The compromise was specifically repealed by the Kansas-Nebraska Bill of 1854.

See J. A. Woodburn, "The Historical Significance of the Missouri Compromise" in the *Annual Report of the American Historical Association* for 1893 (Washington, D.C.); Dixon, *History of the Missouri Compromise* (Cincinnati, 1899); Schouler's and McMaster's *Histories of the United States*. (W. R. 5*.)

MISSOURI RIVER, the principal western tributary of the Mississippi river, U.S.A. It is formed at Gallatin City, in the Rocky Mountain region of south-western Montana, by the confluence of the Jefferson, Madison and Gallatin forks; thence it flows N. into the plains, which it traverses in a course at first N.E., then E. Entering North Dakota, the river turns gradually to the S.E., then S., and again S.E., traversing both North and South Dakota. It forms the eastern boundary of Nebraska and in part of Kansas, and crosses Missouri in an easterly course to its junction with the Mississippi 20 m. above St. Louis, and 2547 m. below the confluence of the three forks. The stream which is known as the Jefferson Fork in its lower course, Beaver Head River in its middle course, and Red Rock Creek in its upper course, is really the upper section of the Missouri; it rises on the border between Montana and Idaho, 20 m. west of the western boundary of the Yellowstone National Park, near the crest of the Rocky Mountains, 8000 ft. above the sea, and 398 m. beyond Gallatin City; and with this and the Lower Mississippi the Missouri forms a river channel 4221 m. in length, the longest in the world. The Madison and Gallatin forks rise within the Yellowstone Park, where the former is fed by geysers and hot springs and the latter by both hot springs and melting snow. The Yellowstone river, which is the principal tributary of the Missouri, traverses the park. The Missouri drains a basin having an area of about 580,000 sq. m.; this includes the eastern slope of the Rocky Mountains from the northern border of the United States to the middle of Colorado, and its larger tributaries take their rise in those mountains. Besides the Yellowstone and the three forks there are the Platte, which rises in two large branches in Colorado, and the Milk, which rises in north-western Montana. The Kansas in Kansas, the James and Big Sioux in the Dakotas, and the Niobrara in Nebraska, are the principal tributaries wholly of the plains. In the mountain region the Missouri flows through deep canyons and over several cascades. Below Great Falls the slower current is unable to carry all the silt brought down from the mountains

and plains, and consequently a winding and unstable channel has been formed on deposits of silt 50 to 100 ft. or more in depth. Bends in the river continue to develop by erosion until the neck between two of them is cut off, and in the process numerous islands, sand-bars, and crescent-shaped lakes are formed. Cottonwood, willow, cedar and walnut trees grow upon the banks that are for a time left undisturbed, but years later the eroding current returns to undermine these banks, the trees fall in and are carried down stream as snags (or "sawyers"), which are especially dangerous to navigation. The variation of level is great and it varies greatly in different parts of the river's course: it is about 10 ft. at Kansas City, about 25 ft. at St. Charles, Missouri, and about 8 ft. at Fort Benton, Montana. It is estimated that the Missouri's average discharge per second amounts to about 94,000 cub. ft., and that each year it carries into the Mississippi 550,000 tons of silt. The waters of the Missouri begin to rise in March, and a high-water stage is reached in April as a result of the spring rains and the melting snow on the plains; a second high stage is produced in June by the melting of snow on the mountains, and the river is navigable from early spring to midsummer as far as Fort Benton, within 40 m. of the Great Falls and 2285 m. above the mouth. Above Great Falls the river is navigable to Three Forks.

The mouth of the Missouri was discovered in 1673 by Marquette and Joliet, while they were coming down the Mississippi. Early in the 18th century French fur-traders began to ascend the river, and in 1764 St. Louis was established as a *dépôt*; but the first exploration of the river from its mouth to its headwaters was made in 1804-1805 by Meriwether Lewis and William Clark. Until many years later the commerce on the river was restricted to the fur trade and was carried on with such primitive craft as the canoe (made from the log of a cottonwood tree); the pirogue (usually two canoes side by side and with a floor over them on which to place the cargo); the bullboat (made by covering a framework of willow poles with the hides of bison bulls); the mackinaw boat (made of boards and having a flat bottom); and the keelboat (a vessel of some pretensions, with a keel from bow to stern, 60 to 70 ft. in length, with a breadth of beam from 15 to 18 ft., and drawing 20 to 30 in. of water). A canoe, pirogue, bullboat, or mackinaw boat was propelled by two or more men with paddles, poles, or oars; but to propel a keelboat up the river required 20 to 40 men who walked along the shore and pulled a *corcelle*, a line about 1000 ft. long and fastened to the mast. An average of about 15 m. a day was made with a keelboat going up the river. The first attempt to navigate the Missouri with steamboats was made in the spring of 1819, when the "Independence" made a trip from St. Louis to the mouth of the Chariton river and back. The American Fur Company began to use steamers in 1830, and from then until the advent of railways the steamboat on the Missouri was one of the most important factors in the development of the Northwest. The traffic was at its height in 1858, when no fewer than 60 regular packets were engaged in it, but its decline began in the following year with the completion of the Hannibal & St. Joseph railway to St. Joseph, Missouri, and 20 years later it had nearly disappeared. In an attempt to regulate railway rates, however, four boats were run between Kansas City and St. Louis between 1890 and 1894 by the Kansas City & Missouri Transportation Company, and in 1906 the Missouri River Valley Improvement Association was formed at Kansas City. Congress began to make appropriation for the removal of snags about 1838, and forty years later appropriations were begun for a general improvement which in 1884 was placed under the charge of the Missouri River Commission. In 1890 its work was restricted to that part of the river below Sioux City and in 1902 the Commission was abolished. Up to the 30th of June 1908 the Federal government had expended \$11,398,881 for the improvement of the river.

See H. M. Chittenden, *History of Early Navigation on the Missouri River* (New York, 1903); P. E. Chappel, *A History of the Missouri River* (Kansas City, 1905); J. V. Brower, *The Missouri River and*

its *Ultimate Source* (St Paul, 1896); J. M. Hanson, *The Conquest of the Missouri* (New York, 1909); L. M. Jones, "The Improvement of the Missouri River and its Usefulness as a Traffic Route," in *Annals of the American Academy of Political and Social Science* (Jan. 1908), and the *Annual Reports of the Chief of Engineers, U.S. Army*.

MISTAKE (*i.e.* take amiss), a misconception or error in thought or action. In law, the word is often used in the sense of ignorance or error, as when it is said that mistake of law affords no excuse for crime. In the law of contract, mistake is of special importance, and may occur either in a matter of law or in a matter of fact. In general, a mistake of law cannot be alleged in avoidance of the consequences of contracts or acts, although there are exceptions in which relief may be given. Mistake of fact, however, may be ground for avoidance, provided the mistake was not due to negligence. (See further CONTRACT.)

MISTLETOE¹ (*Viscum album*), a species of *Viscum*, of the botanical family Loranthaceae. The whole genus is parasitical, and contains about twenty species, widely distributed in the warmer parts of the old world; but only the mistletoe proper is a native of Europe. It forms an evergreen bush, about 4 ft. in length, thickly crowded with forking branches and opposite leaves, which are about 2 in. long, obovate-lanceolate in shape and yellowish-green; the dioecious flowers, which are small and nearly of the same colour but yellower, appear in February and March; the white berry when ripe is filled with a viscous semi-transparent pulp (whence bird-lime is derived). The mistletoe is parasitic both on deciduous and evergreen trees and shrubs. In England it is most abundant on the apple-tree, but rarely found on the oak. Poplars, willows, lime, mountain-ash, maples, are favourite habitats, and it is also found on many other trees, including cedar of Lebanon and larch. The fruit is eaten by most frugivorous birds, and through their agency, particularly that of the species which is accordingly known as mistle-thrush or mistle-thrush, the plant is propagated. The Latin proverb has it that "Turdus malum sibi cacat"; but the sowing is really effected by the bird wiping its beak, to which the seeds adhere, against the bark of the tree on which it has alighted. The viscid pulp soon hardens, affording a protection to the seed; in germination the sucker-root penetrates the bark, and a connexion is established with the vascular tissue of the first plant. The growth of the plant is slow, and its durability proportionately great, its death being determined generally by that of the tree on which it has established itself. The mistletoe so extensively used in England at Christmas is largely derived from the apple orchards of Normandy; a quantity is also sent from the apple orchards of Herefordshire.

Pliny (*H. N.*, xvi. 92-95; xxiv. 6) has a good deal to tell about the *viscum*, a deadly parasite, though slower in its action than ivy. He distinguishes three "genera." "On the fir and larch grows what is called *steltis* in Euboea and *hyphear* in Arcadia." *Viscum*, called *dyros hyphear*, is most plentiful on the esculent oak, but occurs also on the robur, *Prunus sylvestris* and terebinth. He is useful for fattening cattle if they are hardy enough to withstand the purgative effect it produces at first; *viscum* is medicinally of value as an emollient, and in cases of tumour, ulcers and the like. Pliny is also our authority for the reverence in which the mistletoe when found growing on the robur was held by the Druids. Prepared as a draught, it was used as a cure for sterility and a remedy for poisons. The mistletoe figures also in Scandinavian legend as having furnished the material of the arrow with which Balder (the sun-god) was slain by the blind god Höder. Most probably this story had its origin in a particular theory as to the meaning of the word mistletoe.

MISTRAL, FÉDÉRIC (1830-), Provençal poet, was born at Maillane (Bouches-du-Rhône) on the 8th of September 1830. In the autobiographical sketch prefixed to the *Isdo d'or* (1876) he tells us, with great simplicity and charm, all that is worth knowing of his early life. His father was a prosperous farmer,

¹ Gr. *kifa* or *ifés*, hence Lat. *viscum*, Ital. *vischio* or *visco*, and Fr. *gué*. The English word is the O.E. *mistelstan*, Icelandic *mistletein*, in which *tan* or *tein* means a twig, and *mistel* may be associated either with *mist* in the sense of fog, gloom, because of the prevalence of mistletoe in the dark season of the year, or with the same root in the sense of dung (from the character of the berries or the supposed mode of propagation).

and his mother a simple and religious woman of the people, who first taught him to love all the songs and legends of the country. In these early days on the farm he received those first impressions which were destined to constitute one of the chief beauties of *Mirèio*. In his ninth year Mistral was sent to a small school at Avignon, where he was very wretched at first, regretting the free outdoor life of the country. Gradually, however, his studies attracted him, above all the poetry of Homer and Virgil; and he translated the latter's first eclogue, showing his efforts to a young schoolfellow, A. Mathieu, who was destined to play a part in the foundation of the Félibrige. When Roumanille (see PROVENÇAL LITERATURE) became an usher at Mistral's school, the two, fired by the same love of poetry and of their native Provence, soon became close friends. "Voilà l'aube que mon âme attendait pour s'éveiller à la lumière," he exclaimed, on reading Roumanille's first dialect poems; and he goes on to say: "Embrasés tous les deux le désir de relever le parler de nos mères, nous étudîmes ensemble les vieux livres Provençaux, et nous nous proposâmes de restaurer la langue selon ses traditions et caractères nationaux." On leaving school (1847) he returned to Maillane, where he sketched a pastoral poem in four cantos (*Li Meïsson*). With all his love for the country, he soon realized that life on a farm did not satisfy his ambition. So he went to study law at Aix, where he contributed his first published poems to Roumanille's *Li Provençalo* (1852). He had become licencé en droit the year before, but now decided on a literary career. The Félibrige was founded in 1854, and five years later appeared *Mirèio*, the masterpiece not only of Mistral, but so far of the entire school. The tale itself was nothing—the old story of a rich girl and her poor lover, kept apart by the girl's parents. Mireille, in despair, wanders along a wide tract of country to the church of the Trois-Maries, in the hope that these may aid her. But the effort was too great: she sinks exhausted, and dies in the presence of her stricken parents and her frenzied lover. Into this simple web Mistral has woven descriptions of Provençal life, scenery, character, customs and legends that raise the poem to the dignity of a rustic epic, unique in literature. Nothing is forced: every detail is filled into the framework of the whole with a cunning which the poet was never again to attain. There is no deep psychology in the characters, but then the people depicted are simple rustic folk, who wear their hearts on their sleeve. *Calendau* (1867), the story of a princess held in bondage by a ruthless brigand, and eventually rescued by a youthful hero, is a comparative failure. The description of scenery is again masterly; but the old lore, which had charmed all readers in *Mirèio*, here becomes forced, not inevitable. The characters are mere symbols—indeed the whole poem is obviously an allegory, the princess standing for Provence, the brigand for France, and the young lover for the Félibrige. Mistral lavished enormous labour on this work, which probably accounts for its lack of spontaneity, as also for the love he bears it. In 1876 (the same year in which he married Mlle Marie Rivière, of Dijon) was published the volume *Lis Isdo d'Or*—a collection of the shorter poems Mistral had composed from the year 1848 onwards. Here he is again at his very best. Old legends, *sirventes* (mostly, as in medieval times, poems with a tendency), and lyrics—all are admirable. Even the *pièces d'occasion* may be reckoned with the best of their kind. Two pieces, the *Coupe* and the *Princesse*, aroused violent controversy on their first appearance. They reproduce, in effect, the theme of *Calendau*, and Mistral was accused of trying to sow discord between the north and south of France. Needless to say he was altogether innocent of such a design. *Nerto* (1884) is a charming tale of Avignon in the olden days, in which a girl's purity triumphs over her lover's base designs and leads him to nobler thoughts. There is little individuality in the characters, which should rather be regarded as types; and we feel no terror or pity at the tragic close. But we are carried along by Mistral's art and by the brilliancy of his episodes; and he achieved the object he had in view: a pretty tale imbued with the proper touch of local colour and with the true spirit of romance. The play *La Rèino Jano* (1890) is a complete failure, if judged from the dramatic

standpoint: it is rather a brilliant panorama, a series of stage pictures, and the characters neither live nor arouse our sympathy. In the great epic on the Rhone (*Lou Pouëmo dôu Rouer*, 1897) the poet depicts the former barge-life of that river, and intertwines his narrative with the legends clustering round its banks, and with a graceful love episode. For the first time he employs blank verse, and uses it with great mastery, but again the ancient love is overdone. A splendid piece of work is *Lou Tresor dôu Félibrige* (1886). In these two volumes Mistral has deposited with loving care every word and phrase, every proverb, every scrap of legend, that he had gathered during his many years' journeyings in the south of France. In 1904 he was awarded one of the Nobel prizes for literature.

An excellent literary appreciation of the poet is that by Gaston Paris, "Frédéric Mistral" (originally in the *Revue de Paris* (Oct. and Nov. 1894); then in *Penseurs et Poètes* (Paris, 1896). More elaborate accounts are Welter, *Frédéric Mistral* (Marburg, 1899); and Downer, *Frédéric Mistral* (New York, 1901), with a full bibliography.

(H. O.)

MISTRAL, a local wind similar to the bora (*q.v.*), met with on the French Mediterranean coast. The warm Gulf of the Lion (Golfe du Lion) has to the north the cold central plateau of France, which during winter is commonly a centre of high barometric pressure, and the resulting pressure gradient causes persistent currents of cold dry air from the north-west in the intermediate zone. The mistral occurs along the coast from the mouth of the Ebro to the Gulf of Genoa, but attains greatest strength and frequency in Provence and Languedoc, *i.e.* the district of the Rhone delta, where it blows on an average one day out of two; the record at Marseilles is 175 days in the year. It is usually associated with cloudless skies and brilliant sunshine, intense dryness and piercing cold. With the passage of a cyclone over the gulf, or a rapid rise of pressure following a fall of snow on the central plateau, the mistral develops into a stormy wind of great violence.

MISTRESS (adapted from O. Fr. *maistrresse*, mod. *maitresse*, the feminine of *maître*, *maître*, master), a woman who has authority, particularly over a household. As a form of address or term of courtesy the word is used in the same sense as "madam." It was formerly used indifferently of married or unmarried women, but now, written in the abbreviated form "Mrs." (pronounced "missis"), it is practically confined to married women and prefixed to the surname; it is frequently retained, however, in the case of spinster cooks or housekeepers, as a title of dignity; as the female equivalent of "master" the word is used in other senses by analogy, *e.g.* of Rome as "the mistress of the world," Venice "the mistress of the Adriatic," &c. From the common use of "master" as a teacher, "mistress" is similarly used. The old usage of the word for a lady-love or sweetheart has degenerated into that of paramour. "Miss" a shortened form of "mistress," is the term of address for a girl or unmarried woman; it is prefixed to the surname in the case of the eldest or only daughter of a family, and to the Christian names in the case of the younger daughters.

MITAU (Russian, *Mitava*; Lettish, *Yelgava*), a town of Russia, capital of the government of Courland, 29 m. by rail S.W. of Riga, on the right bank of the river Aa, in a fertile plain which rises only 12 ft. above sea level, and has probably given its name to the town (*Mitte in der Aue*). Pop. (1897), 35,011 inhabitants, mainly Germans, but including also Jews (6500), Letts (5000) and Russians. At high water the plain and sometimes also the town are inundated. Mitau is surrounded by a canal occupying the place of former fortifications. It has regular, broad streets, bordered with the mansions of the German nobility, who reside at the capital of Courland. Mitau is well provided with educational institutions, and is also the seat of the Lettish Literary Society. The old castle (1266) of the dukes of Courland, situated on an island in the river, was destroyed by Duke Biren, who erected in its place (1738-1772) a spacious palace, now occupied by the governor and the courts. Manufactures are few, those of wax-cloth, linen, soap, ink and beer being the most important.

Mitau is supposed to have been founded in 1266 by Conrad

Mandern, grand-master of the order of the Brethren of the Sword. In 1345, when it was plundered by the Lithuanians, it was already an important town. In 1561 it became the residence of the dukes of Courland. During the 17th century it was thrice taken by the Swedes. Russia annexed it with Courland in 1795. It was the residence (1798-1801 and 1804-1807) of the count of Provence (afterwards Louis XVIII.). In 1812 it was taken by Napoleon I.

MITCHAM, a suburb of London, in the Wimbledon parliamentary division of Surrey, England, 10 m. S. of London Bridge by the London, Brighton & South Coast railway. Pop. (1901), 14,903. Mitcham Common covers an area of 480 acres, and affords one of the best golf courses near London. The neighbourhood abounds in market gardens and plantations of aromatic herbs for the manufacture of scents and essences.

MITCHEL, ORMSBY MACKNIGHT (1809-1862), American astronomer, was born at Morganfield, Kentucky, on the 28th of July, 1809. He began life as a clerk, but, obtaining an appointment to a cadetship at West Point in 1825, he graduated there in 1829, and acted as assistant professor of mathematics 1829-1832. He was then called to the bar, but in 1836 became professor of mathematics and natural philosophy at Cincinnati College. In 1845 he was made director of an observatory established there through his initiative, and also in 1859 superintendent of the Dudley observatory at Albany. In 1861 he took part in the war as brigadier-general of volunteers, and for his skill in seizing certain important strategic points was on the 11th of April 1862 made major-general. He died of yellow fever at Beaufort, South Carolina, on the 30th of October 1862. He founded the *Sideral Messenger* in 1846, was one of the first to adopt (in 1848) the electrical method of recording observations, and published besides other works, *The Orbs of Heaven* (1848, &c.), and *Popular Astronomy* (1860), both reissued at London in 1892.

See *Ormsby MacKnight Mitchel; a Biographical Narrative*, by his son, F. A. Mitchel (1887); P. C. Headley, *The Patriot Boy* (1865); *Amer. Journal of Science*, xxiv, 451 (1862); *Month. Notices Roy. Astr. Society*, xxiii, 133, xxxvii, 121 (C. Abbe); *Astr. Nach.*, No. 1401 (G. W. Hough).

MITCHELL, DONALD GRANT (1822-1908) American author, was born in Norwich, Connecticut, on the 12th of April 1822. He graduated at Yale College in 1841; studied law, but soon took up literature. Throughout his life he showed a particular interest in agriculture and landscape-gardening, which he followed at first in pursuit of health. He produced books of travel, volumes of essays on rural themes, of which *My Farm of Edgewood* (1863) is the best; sketchy studies of English monarchs and of English and American literature; and a character-novel entitled *Doctor Johns* (1866), &c.; but is best known as the author (under the pseudonym of "Ik Marvel"), of the sentimental essays contained in the volumes *Reveries of a Bachelor*, or *a Book of the Heart* (1850), and *Dream Life, a Fable of the Seasons* (1851).

MITCHELL, MARIA (1818-1889), American astronomer, was born of Quaker ancestry on the island of Nantucket on the 1st of August 1818. Her father, William Mitchell (1791-1869), was a school teacher and self-taught astronomer, who rated chronometers for Nantucket whalers, was an overseer of Harvard University (1857-1865), and for a time was employed by the United States Coast Survey. As early as 1831 (during the annular eclipse of the sun) she had been her father's assistant in his observations. On the 1st of October 1847 she discovered a telescopic comet (seen by De Vico Oct. 3, by W. R. Dawes Oct. 7, by Madame Rümker Oct. 11), and for this discovery she received a gold medal from the King of Denmark, and was elected (1848) to the American Academy of Arts and Sciences, and (1850) to the American Association for the Advancement of Science. In 1861 she removed from Nantucket to Lynn, where she used a large equatorial telescope presented to her by the women of America; and there she lived until 1865, when she became professor of astronomy and director of the observatory at Vassar College; in 1888 she became professor emerita. In 1874 she began making photographs of the sun, and for years she made a special study of Jupiter and Saturn. She died at

Lynn on the 28th of June 1889. In 1908 an observatory was established in her honour at Nantucket.

See Phebe Mitchell Kendall, *Maria Mitchell: Life, Letters and Journals* (Boston, 1896); *In Memoriam* (Poughkeepsie, 1889), by her pupil and successor at Vassar, Mary W. Whitney; and a sketch by her brother, Henry Mitchell (1830-1902), himself a well-known hydrographer, in the *Proceedings of the American Academy of Arts and Sciences*, vol. xxv. (1889-1890), pp. 331-343.

MITCHELL, SILAS WEIR (1830-), American physician and author, son of a Philadelphia doctor, John Kearsley Mitchell (1798-1858), was born in Philadelphia on the 15th of February 1830. He studied at the University of Pennsylvania in that city, and received the degree of M.D. at Jefferson Medical College in 1850. During the Civil War he had charge of nervous injuries and maladies at Turner's Lane Hospital, Philadelphia, and at the close of the war became a specialist in nervous diseases. In this field Weir Mitchell's name became prominently associated with his introduction of the "rest cure," subsequently taken up by the medical world, for nervous diseases, particularly hysteria; the treatment consisting primarily in isolation, confinement to bed, dieting and massage. In 1863 he wrote a clever short story, combining physiological and psychological problems, entitled "The Case of George Dedlow," in the *Atlantic Monthly*. Thenceforward Dr Weir Mitchell, as a writer, divided his attention between professional and literary pursuits. In the former field he produced monographs on rattlesnake poison, on intellectual hygiene, on injuries to the nerves, on neurasthenia, on nervous diseases of women, on the effects of gunshot wounds upon the nervous system, and on the relations between nurse, physician, and patient; while in the latter he wrote juvenile stories, several volumes of respectable verse, and prose fiction of varying merit, which, however, gave him a leading place among the American authors of the close of the 19th century. His historical novels, *Hugh Wynne*, *Free Quaker* (1897), *The Adventures of François* (1898) and *The Red City* (1909), take high rank in this branch of fiction.

MITCHELL, SIR THOMAS LIVINGSTONE (1792-1855), Australian explorer, was born at Craigend, Stirlingshire, Scotland, on the 16th of June 1792. From 1808 to the end of the Peninsular War he served in Wellington's army, and was raised to the rank of major. He was appointed to survey the battlefields of the Peninsula, and his map of the Lower Pyrenees is still admired. In 1827 he was appointed deputy surveyor-general, and afterwards surveyor-general of New South Wales. He made four exploring expeditions between 1831 and 1846, and discovered the Peel, the Namoi, the Gwyder and other rivers, traced the course of the Darling and Glenelg, and was the first to penetrate into that portion of the country which he named Australia Felix. His last expedition was mainly devoted to the discovery of a route between Sydney and the Gulf of Carpentaria, and during the journey he explored the Fitzroy Downs, and discovered the Balonne, Victoria, Warrego and other streams. In 1838, while in England, Mitchell published his *Three Expeditions into the Interior of East Australia*. In 1839 he was knighted and made a D.C.L. of Oxford. During this visit he took with him some of the first specimens of gold and the first diamond found in Australia. In 1848 the narrative of his second expedition was published in London, *Journal of an Expedition into the Interior of Tropical Australia*. In 1851 he was sent to report on the Bathurst goldfields, and in 1853 he again visited England and patented his boomerang propeller for steamers. He died at Darling Point, Sydney, on the 5th of October 1855.

Besides the above works, Mitchell wrote a book on *Geographical and Military Surveying* (1827), an *Australian Geography*, and a translation of the *Lusid* of Camoens. During his tenure of office as surveyor-general he published an admirable map (still in use) of the settled districts of New South Wales.

MITCHELL, a city and the county-seat of Davison county, South Dakota, U.S.A., about 70 m. W.N.W. of Sioux Falls. Pop. (1905), 5719; (1910), 6515. Mitchell is served by the Chicago, Milwaukee & St Paul and the Chicago, St Paul, Minneapolis & Omaha railways. Among its buildings and institutions are the city hall, the Federal building, a Carnegie library, a

hospital, and a sanatorium. Mitchell is the seat of the Dakota Wesleyan University (1885; Methodist Episcopal). At Mitchell is a "corn palace," which is decorated each autumn with split ears of Indian corn, and is the centre of an annual festival, held in September and October. The city is an important shipping point for grain and livestock, and has a large wholesale trade. There are railway repair shops of the Chicago, Milwaukee & St Paul railway, machine shops, and manufactories of bricks and dressed lumber. Mitchell was settled in 1879 and chartered as a city in 1883.

MITCHELSTOWN, a market town of Co. Cork, Ireland, situated between the Kilworth and Galty Mountains, on a branch of the Great Southern & Western railway. Pop. (1901), 2146. Here is the Protestant Kingston College, a home for poor gentlefolk, founded by James, Lord Kingston, in 1766. The seat of the earls of Kingston was built in 1823. It is a massive castellated structure, among the finest of its kind in Ireland. The Mitchelstown limestone caves, exhibiting beautiful stalactite formations, are 6 m. distant in Co. Tipperary (*q.v.*). On the 9th of September 1887 Mitchelstown was the scene of a riot in connexion with the Irish Nationalist "plan of campaign." The police were compelled to fire on the rioters, and two men were killed, after which the coroner's jury brought in a verdict of wilful murder against the police. This verdict was ignored by the government, and subsequently quashed by the Queen's Bench in Dublin, but additional feeling was roused in respect of the incident owing to a message later sent by Mr Gladstone ending with the words "Remember Mitchelstown."

MITE, a name applied to an order of small Arachnida, with which this article deals, and to a coin of very slight value. The origin of both would appear to be ultimately the same, viz. a root *mei-*, implying something exceedingly small. It has been suggested that the name for the animal comes from a secondary root of the root *mei-*, to cut, whence come such words as Goth. *malan*, to cut, and Ger. *messer*, knife. In this case mite would mean "the biter" or "cutter." The coin was originally a Flemish copper coin (Dutch *mijt*) worth one-third or, according to some authorities, a smaller fraction of the Flemish *penning*, penny. It has become a common expression in English for a coin of the smallest value, from its use to translate Gr. *πέννις*, two of which make a *κοδράντης*, translated "farthing" (Mark xii. 43).

In zoology, "mite" is the common name for minute members of the class Arachnida (*q.v.*), which, with the ticks, constitute the order Acari. The word "mite," however, is merely a popular and convenient term for certain groups of Acari, and does not connote a natural assemblage as contrasted with the ticks (*q.v.*). Mites are either free-living or parasitic throughout their lives or parasitic at certain periods and free-living at others. They are almost universally distributed, and are found wherever terrestrial vegetation, even of the lowliest kind, occurs. They are spread from the arctic to the antarctic hemisphere, and inhabit alike the land, fresh-water streams and ponds, brackish marshes and the sea. The largest species, which occur in the tropics, reach barely half an inch in length; while the smallest, the most diminutive of the Arthropoda, are invisible to the naked eye.

Mites are divided into a considerable number of families. The Bdellidae (*Bdella*) are free-living forms with long antenniform palpi. The large tropical forms above mentioned belong to the genus *Trombidium* of the family Trombididae. The members of this genus are covered with velvety push-like hairs, often of an exquisite crimson colour. The legs are adapted for crawling or running, and the palpi are raptorial. They are non-parasitic in the adult stage; but immature individuals of a British species (*T. holosericeum*) are parasitic upon various animals (see HARVEST BUG). The Tetranychidae are nearly related to the last. A well-known example, *Tetranychus telarius*, spins webs on the backs of leaves, and is sometimes called the money spider. The fresh-water mites or Hydrachnidae are generally beautifully coloured red or green, and are commonly globular in shape. Their legs are furnished with

long hairs for swimming. The marine mites of the family Halacaridae, on the contrary, are not active swimmers but merely creep on the stems of seaweeds and zoophytes. The Gamasidae are mostly free-living forms with a thick exoskeleton, and are allied to the Ixodidae or ticks (q.v.). A common species is *Gamasus coleoptratorum*, the female and young of which may be found upon the common dung-beetle. The Oribatidae or beetle-mites, so called from their resemblance to minute beetles, are non-parasitic, and often go through remarkable metamorphoses during development. The Sarcoptidae, as stated below, are mostly parasitic forms. Some members of this family, however, live in decaying animal substances, the best known perhaps being the cheese-mite (*Tyroglyphus siro*) which infests cheese, especially Stilton, in thousands. An allied species (*T. entomophagus*) often causes great damage to collections of insects by destroying the dried specimens. They may be easily exterminated by application of benzine, which does not harm the contents of the cabinet.

From the economic standpoint the most important mites are those which are parasitic upon mammals and birds. They belong to the four families, Gamasidae, Trombididae, Sarcoptidae and Demodicidae. Most of the Gamasidae are free-living mites. The family, however, contains an aberrant genus, *Dermanyssus*, of which several species have been described, although they are all perhaps merely varieties of one and the same species commonly known as *D. gallinae* or *D. avium*. This species is found in lark-houses, dove-cotes and bird-cages. During the day they lurk in cracks in the floor, walls or perches, and emerge at night to attack the roosting birds. They are a great pest, and frequently do much damage to birds both by sucking their blood and by depriving them of rest at night. They are sometimes transferred from birds to mammals. The Trombididae also are mostly free-living predaceous mites. A few, however, are parasitic upon mammals and birds, the best-known being *Trombidium holosericeum*, the larva of which attacks human beings, as well as chickens and other birds, sometimes producing considerable mortality amongst them (see HARVEST BUG). Another genus, *Cheyletiella*, affects rabbits as well as birds. Birds are also attacked by many species of Sarcoptidae, which according to the organs infected are termed pulmicolae (Analgesinae), epidermicolae (Epidermoptinae), and cysticcolae (Cytoditinae). The Analgesinae (*Pterolichus*, *Analges*) live almost wholly upon and between the barbles of the feathers. They are found in nearly every species of bird without apparently affecting the health in any way. The Epidermoptinae (*Epidermoptes*) occur on diseased fowls and live, as their name indicates, upon the skin at the base of the feathers, where their presence gives rise to an accumulation of yellowish scales. The Cytoditinae (*Cytodites*), on the other hand, live in the subcutaneous or intermuscular connective tissue round the respiratory organs, or in the air sacs, especially of gallinaceous species. They also penetrate to certain internal organs, and may become encysted and give rise to tubercle-like nodules. Sometimes they exist in such quantities in the air passages as to cause coughing and asphyxia.

The cutaneous mites, mentioned above, and others akin to them, produce no very marked disturbance in the skin of the species they infest. They merely suck the blood or feed upon the feathers, scurf and desquamating epidermis. Hence they are termed "non-psoric" mites. A certain number of species, however, called in contradistinction "psoric" mites, give rise by their bites, by the rapidity of their multiplication, and by the excavation of galleries in the skin, to a highly contagious disease known as scabies or mange, which if not treated in time produces the gravest results. These mites belong exclusively to the Sarcoptidae and Demodicidae. A variety of species are responsible for Sarcoptic mange, *Sarcoptes mutans* producing it in the feet of gallinaceous and passerine birds by burrowing beneath the scales and giving rise to a crusted exudation which pushes up beneath and between the scales. Feather scabies or depilating scabies of poultry is caused by another species, *S. laevis*. Three genera of Sarcoptidae, namely *Sarcoptes Chorioptes* and *Psoroptes* cause mange or scabies in mammals,

the mange produced by *Sarcoptes* being the most serious form of the disease, because the females of the species which produces it, *Sarcoptes scabiei*, burrow beneath the skin and are more difficult to reach with acaricides. A considerable number of varieties of this species have been named after the hosts upon which they most commonly and typically occur, such as *S. scabiei hominis, equi, bovis, caprae, ovis, cameli, lupi, vulpis, &c.*; but they are not restricted to the mammals from which their names have been derived and structural differences between them are often difficult to define and sometimes non-existent. Under favourable conditions the multiplication of this species is very rapid. It has been computed indeed that a single pair may give rise to one million and a half individuals in about three months. *Psoroptes* lives in the epidermic incrustations to which it gives rise, without, however, excavating subcutaneous burrows. One species, *P. communis*, is known to affect various domestic animals. Of the genus *Chorioptes* two species have been described on domestic animals, viz. *Ch. symbiotes*, which has the same mode of life as *Psoroptes communis* and *Ch. cynotis*, which has been detected only in the ears of certain carnivora such as dogs, cats and ferrets. Mange, if taken in time, can be cured by applications of sulphur ointment or of sulphur mixed with an animal or vegetable oil. Mites of the family Demodicidae give rise to a skin disease called "Demodic or follicular mange," which is often serious and always difficult to cure on account of the deep situation taken up by the parasites. These infest the hair follicles and sebaceous glands, and are therefore termed *Demodex folliculorum*. These mites differ greatly from those previously noticed—in the reduction of their legs to short three-jointed tubercles, and in the great elongation of the abdomen to form an annulated flexible postanal area to the body. They live not uncommonly in small numbers in the skin of the human face and their presence may never be detected. They also occur on dogs, pigs and other domesticated animals, as well as on mice and bats, and numerous varieties named after their hosts, *hominis, bovis, canis, cati, &c.*, have been described, but they apparently differ from each other, principally in size.

The mites of the family Eriophyidae or Phytoidae produce in various plants pathological results analogous to those produced in animals by parasitical Sarcoptidae and by Demodicidae. As in the Demodicidae the abdomen is elongate and annulate, but the Eriophyidae differ from all other mites in having permanently lost the last two pairs of legs. The excrescences and patches they produce on leaves are called "galls," the best known of which are perhaps the nail-galls of the lime caused by *Eriophyes tiliae*. A very large number of species have been described and named after the plants upon which they live. They often inflict very considerable loss upon fruit-growers by destroying the growing buds of the trees.

(R. I. P.)

MITFORD, MARY RUSSELL (1787-1855), English novelist and dramatist, only daughter of Dr George Mitford, or Midford, was born at Alresford, Hampshire, on the 16th of December 1787. She retains an honourable place in English literature as the authoress of *Our Village*, a series of sketches of village scenes and characters unsurpassed in their kind, and as fresh as if they had been written yesterday. Her father was a curious character. He first spent his wife's fortune in a few years; then he spent the greater part of £20,000, which in 1797 his daughter, then at the age of ten, drew as a prize in a lottery; then he lived on a small remnant of his fortune and the proceeds of his daughter's literary industry. The father kept fresh in his daughter the keen delight in incongruities, the lively sympathy with self-willed vigorous individuality, and the womanly tolerance of its excess, which inspire so many of her sketches of character. Miss Mitford lived in close attendance on him, refused all holiday invitations because he could not live without her, and worked incessantly for him except when she broke off her work to read him the sporting newspapers. Her writing has all the charm of perfectly unaffected spontaneous humour, combined with quick wit and exquisite literary skill. Miss Mitford met Elizabeth Barrett (Mrs Browning) in 1836, and the acquaintance ripened into a warm friendship. The strain of poverty began to tell on her

work, for although her books sold at high prices, her income did not keep pace with her father's extravagances. In 1837, however, she received a civil list pension, and five years later her father died. A subscription was raised to pay his debts, and the surplus increased the daughter's income. Miss Mitford eventually removed to a cottage at Swallowfield, near Reading, where she died on the 10th of January 1855.

Miss Mitford's youthful ambition had been to be "the greatest English poetess," and her first publications were poems in the manner of Coleridge and Scott (*Miscellaneous Verses*, 1810, reviewed by Scott in the *Quarterly*; *Christine*, a metrical tale, 1811; *Blanche*, 1813). Her play *Julian* was produced at Covent Garden, with Macready in the title-rôle, in 1823; *The Foscari* was performed at Covent Garden, with Charles Kemble as the hero, in 1826; *Rienzi*, 1828, the best of her plays, had a run of thirty-four nights, and Miss Mitford's friend, Talfourd, imagined that its vogue militated against the success of his own play *Ion*. *Charles the First* was refused a licence by the Lord Chamberlain, but was played at the Surrey Theatre in 1834. But the prose, to which she was driven by domestic necessities, has rarer qualities than her verse. The first series of *Our Village* sketches appeared in 1824, a second in 1826, a third in 1828, a fourth in 1830, a fifth in 1832. *Our Village* was several times reprinted; *Belford Regis*, a novel in which the neighbourhood and society of Reading were idealized, was published in 1835.

Her *Recollections of a Literary Life* (1852) is a series of causeries about her favourite books. Her talk was said by her friends, Mrs Browning and Hengist Horne, to have been even more amusing than her books, and five volumes of her *Life and Letters*, published in 1870 and 1872, show her to have been a delightful letter-writer.

MITFORD, WILLIAM (1744-1827), English historian, was the elder of the two sons of John Mitford, a barrister, who lived near Beaulieu, at the edge of the New Forest. Here, at Exbury House, his father's property, Mitford was born on the 10th of February 1744. He was educated at Cheam School, under the picturesque writer William Gilpin, but at the age of fifteen a severe illness led to his being removed, and after two years of idleness Mitford was sent, in July 1761, as a gentleman commoner to Queen's College, Oxford. In this year his father died, and left him the Exbury property and a considerable fortune. Mitford, therefore, being "very much his own master, was easily led to prefer amusement to study." He left Oxford (where the only sign of assiduity he had shown was to attend the lectures of Blackstone) without a degree, in 1763, and proceeded to the Middle Temple. But when he married Miss Fanny Molloy in 1766, and retired to Exbury for the rest of his life, he made the study of the Greek language and literature his hobby and occupation. After ten years his wife died, and in October 1776 Mitford went abroad. He was encouraged by French scholars whom he met in Paris, Avignon and Nice to give himself systematically to the study of Greek history. But it was Gibbon, with whom he was closely associated when they both were officers in the South Hampshire Militia, who suggested to Mitford the form which his work should take. In 1784 the first of the volumes of his *History of Greece* appeared, and the fifth and last of these quartos was published in 1810, after which the state of Mitford's eyesight and other physical infirmities, including a loss of memory, forbade his continuation of the enterprise, although he painfully revised successive new editions. While his book was progressing, Mitford was a member of the House of Commons, with intervals, from 1785 to 1818, and he was for many years verderer of the New Forest and a county magistrate; but it does not appear that he ever visited Greece. After a long illness, he died at Exbury on the 10th of February 1827. In addition to his *History of Greece*, he published a few smaller works, the most important of which was an *Essay on the Harmony of Language*, 1774. The style of Mitford is natural and lucid, but without the rich colour of Gibbon. He affected some oddities both of language and of orthography, for which he was censured and which he endeavoured to revise. But his political opinions were still more severely treated, since Mitford was an impassioned anti-Jacobin, and his partiality for a monarchy led him to be

unjust to the Athenians. Hence his *History of Greece*, after having had no peer in European literature for half a century, faded in interest on the appearance of the work of Grote. Clinton, too, in his *Fasti hellenici*, charged Mitford with "a general negligence of dates," though admitting that in his philosophical range "he is far superior to any former writer" on Greek history. Byron, who dilated on Mitford's shortcomings, nevertheless declared that he was "perhaps the best of all modern historians altogether." This Mitford certainly is not, but his pre-eminence in the little school of English historians who succeeded Hume and Gibbon it would be easier to maintain.

William Mitford's cousin, the Rev. John Mitford (1781-1859), was editor of the *Gentleman's Magazine* and of various editions of the English poets. For the Freeman-Mitfords, who were also relatives, see REDESDALE, EARL OF.

MITHILA, an ancient kingdom of India, corresponding to that portion of Behar lying N. of the Ganges, with an extension into Nepal, where was the capital of Janakpur. Its early history is obscure, but it has always been noted for its peculiar conservatism and the learning of its Brahmins. They form to this day one of the five classes of northern Brahmins, and their head is the Maharaja of Darbhanga. The language, known as Maithili, is a dialect of Bihari, with an archaic system of grammar and a literature of its own.

MITHRADATES, less correctly MITHRIDATES, a Persian name derived from Mithras (*g.v.*), the sun-god, and the Indo-European root *da*, "to give," i.e. "given by Mithras." The name occurs also in the forms Mitradates (Herod. i. 110) and Meherdates (Tac. *Ann.* xii. 10). It was borne by a large number of Oriental kings, soldiers and statesmen. The earliest are Mithradates, the eunuch who helped Artabanus to assassinate Xerxes I. (Diod. xi. 69), and the Mithradates who fought first with Cyrus the Younger and after his death with Artaxerxes against the Greeks (Xen. *Anab.* ii. 5, 35; iii. 3, 1-10; iii. 4, 1-5), and is the ancestor of the kings of Pontus. The most important are three kings of Parthia of the Arsacid dynasty, and six (or four) kings of Pontus. There were also two kings of Commagene, two of the Bosphorus and one of Armenia (A.D. 35-51).

MITHRADATES I. (Arsaces VI.), successor of his brother, Phraates I., came to the Parthian throne about 175 B.C. The first event of his reign was a war with Eucratides of Bactria, who tried to create a great Greek empire in the East. At last, when Eucratides had been murdered by his son about 150, Mithradates was able to occupy some districts on the border of Bactria and to conquer Arachosia (Kandahar); he is even said to have crossed the Indus (Justin 41, 6; Strabo xi. 515, 517; cf. Orosius v. 4, 16; Diod. 33, 18). Meanwhile the Seleucid kingdom was torn by internal dissensions, fostered by Roman intrigues. Phraates I. had already conquered eastern Media, about Rhagae (Rai), and subjected the Mardi on the border of the Caspian (Justin 41, 5; Isidor. *Charac.* 7). Mithradates I. conquered the rest of Media and advanced towards the Zagros chains and the Babylonian plain. In a war against the Elymaeans (in Susiana) he took the Greek town Seleucia on the Hedyphion, and forced their king to become a vassal of the Parthians (Justin 41, 6; Strabo xv. 744). About 141 he must have become master of Babylonia. By Diodorus 33, 18 he is praised as a mild ruler; and the fact that from 140 he takes on his coins the epithet *Philhellen* (W. Wroth, *Catalogue of the Coins of Parthia*, p. 14 seq.; till then he only calls himself "the great king Arsakes") shows that he tried to conciliate his Greek subjects. The Greeks, however, induced Demetrius II. Nicator to come to their deliverance, although he was much pressed in Syria by the pretender Diodotus Tryphon. At first he was victorious, but in 138 he was defeated. Mithradates settled him with a royal household in Hyrcania and gave him his daughter Rhodogune in marriage (Justin 36, 1, 38, 9; Jos. *Ant.* 13, 5, 11; Euseb. *Chron.* I. 257; Appian *Syr.* 67). Shortly afterwards Mithradates I. died, and was succeeded by his son Phraates II. He was the real founder of the Arsacid Empire.

MITHRADATES II. the Great, king of Parthia (c. 120-88 B.C.), saved the kingdom from the Mongolian Sacae (Tochari),

Kings of Parthia.

who had occupied Bactria and eastern Iran, and is said to have extended the limits of the empire (Justin 42, 2, where he is afterwards confused with Mithradates III.). He defeated King Artavasdes of Armenia and conquered seventy valleys; and the prince Tigranes came as hostage to the Parthians (Justin 42, 2; Strabo, iii. 532). In an inscription from Delos (Dittenberger, *Or. gr. inscr.* 430) he is called "the great King of Kings Arsakes." He also intervened in the wars of the dynasts of Syria (Jos. *Ant.* xiii. 14, 3). He was the first Parthian king who entered into negotiations with Rome, then represented by Sulla, praetor of Cilicia (92 B.C.).

MITHRADATES III. murdered his father Phraates III. about 57 B.C., with the assistance of his brother Orodes. He was made king of Media, and waged war against his brother, but was soon deposed on account of his cruelty. He took refuge with Gabinius, the Roman proconsul of Syria. He advanced into Mesopotamia, but was beaten at Seleucia by Surenas, fled into Babylon, and after a long siege was taken prisoner and killed in 54 by Orodes I. (Dio Cass. 39, 56; Justin 42, 4; Jos. *Bell.* i. 8, 7, *Ant.* 14, 6, 4).

A Parthian king, Mithradates, who must have occupied the throne for a short time during the reign of Phraates IV., is mentioned by Jos. *Ant.* xvi. 8, 4, in 10 B.C.; another pretender Meherdates was brought from Rome in A.D. 49 by the opponents of Gotarzes, but defeated (*Tac. Ann.* xi. 10, xii. 10 sqq.). The name of another pretender Mithradates (often called Mithradates IV.) appears on a coin of the first half of the 2nd century, written in Aramaic accompanied by the Arsacid titles in Greek (Wroth, *Catal. of the Coins of Parthia*, p. 219); he appears to be identical with Meherdates, one of the rival kings of Parthia who fought against Trajan in 116; he died in an attack on Commagene and appointed his son Sanatruces successor, who fell in a battle against the Romans (Arrian *op. Malalas, Chron.* pp. 270, 274). (Ed. M.)

The kings of Pontus were descended from one of the seven Persian conspirators who put the false Smerdis to death (see

DARIUS I.). According to Diodorus Siculus, three members of his family—Mithradates, Ariobarzanes,

Mithradates—were successively rulers of Cius on the Propontis and Carine in Mysia. The last of these was put to death in 302 B.C. by Antigonos, who suspected him of having joined the coalition against him. He was succeeded by his son Mithradates I. or III. (if the two dynasts of Cius be included¹) the founder (*ἄρχων*) of the Pontic kingdom, although this distinction is by some attributed to the father. Warned by his friend Demetrius, the son of Antigonos, that he was threatened with the same fate as his father, he fled to Paphlagonia, where he seized Cimiata, a fort at the foot of the Olgassyus range. Being joined by the Macedonian garrison and the neighbouring populations, he conquered the Cappadocian and Paphlagonian territories on both sides of the Halys and assumed the title of king. Before his death he further enlarged Pontic Cappadocia. He was succeeded by Ariobarzanes, who left the throne to MITHRADATES II. (c. 256–190, according to Meyer, *Mithradates II. and III.*), a mere child. Early in his reign the Gauls of Galatia invaded his territory. Mithradates was at the battle of Ancyra (c. 241), in which he assisted Antiochus Hierax against his brother Seleucus Callinicus, in spite of the fact that he had married the daughter of the latter with Greater Phrygia as her dowry. His two daughters, both named Laodice, were married, one to Antiochus the Great, the other to his cousin Achaeus, a dynast of Asia Minor. He unsuccessfully attacked Sinaeus, which was taken by his successor Pharnaces, the brother (not the son) of MITHRADATES III. (169–121), surnamed *Philopator*, *Philadelphus*, and *Euergetes*. According to Meyer, however, there were two kings (Mithradates IV. *Philopator* and V. *Euergetes*). He was the first king of Pontus to recognize the suzerainty of the Romans, of whom he was a loyal ally. He assisted Attalus II. of Pergamum to resist Prusias II. of Bithynia; furnished a contingent during the Third Punic War; and aided the Romans in obtaining possession of Pergamum, bequeathed to them by Attalus III., but claimed by Aristonicus, a natural son of

Eumenes II. Both Mithradates and Nicomedes of Bithynia demanded Greater Phrygia in return for their services. It was awarded to Mithradates, but the senate refused to ratify the bargain on the ground of bribery. For several years the kings of Pontus and Bithynia bid against each other, till in 116 Phrygia was declared independent, although in reality it was treated as part of the province of Asia. Mithradates appears to have taken it without waiting for the decision of the senate. He invaded Cappadocia, and married his daughter to the young king, Ariarathes Epiphanes; bought the succession from the last king of Paphlagonia, and obtained a kind of protectorate over Galatia. He was a great admirer of the Greeks, who called him *Euergetes*; he removed his capital from Amasia to Sinope, and bestowed liberal gifts upon the temples of Delos and Athens. At the height of his power he was assassinated by his courtiers during a banquet in his palace at Sinope.

MITHRADATES VI. *Eupator*, called the Great, a boy of eleven, now succeeded his father. Alarmed at the attempts made upon his life by his mother, he fled to the mountains and was for many years a hunter. In 111 he returned to Sinope, threw his mother into prison, and put his younger brother to death. Having thus established himself on the throne, he turned his attention to conquest. In return for his assistance against the Scythians, the Greeks of the Cimmeric Bosphorus and the Tauric Chersonese recognized his suzerainty. He occupied Colchis, Paphlagonia and part of Galatia; set his son Ariarathes on the throne of Cappadocia and drove out Nicomedes III., the young king of Bithynia. The Romans restored the legitimate kings, and, while apparently acquiescing, Mithradates made preparations for war. He had long hated the Romans, who had taken Phrygia during his minority, and he aimed at driving them from Asia Minor. The cause of rupture was the attack on Pontic territory by Nicomedes at the instigation of the Romans. Mithradates, unable to obtain satisfaction, declared war (88 B.C.). He rapidly overran Galatia, Phrygia and Asia, defeated the Roman armies, and ordered a general massacre of the Romans in Asia. He sent large armies into European Greece, and his generals occupied Athens. But Sulla in Greece and Fimbria in Asia defeated his armies in several battles; the Greek cities were disgusted by his severity, and in 84 he concluded peace, abandoning all his conquests, surrendering his fleet and paying a fine of 2000 talents. During what is called the Second Mithradatic War, Murena invaded Pontus without any good reason in 83, but was defeated in 82. Hostilities were suspended, but disputes constantly occurred, and in 74 a general war broke out. Mithradates defeated Cotta, the Roman consul, at Chalcedon; but Lucullus worsted him, and drove him in 72 to take refuge in Armenia with his son-in-law Tigranes. After two great victories at Tigranocerta (69) and Artaxata (68), Lucullus was disconcerted by mutiny and the defeat of his lieutenant Fabius (see LUCULLUS). In 66 he was superseded by Pompey, who completely defeated both Mithradates and Tigranes. The former established himself in 64 at Panticapaeum, and was planning new campaigns against the Romans when his own troops revolted, and, after vainly trying to poison himself, he ordered a Gallic mercenary to kill him. So perished the greatest enemy that the Romans had to encounter in Asia Minor. His body was sent to Pompey, who buried it in the royal sepulchre at Sinope.

Ancient authorities have invested Mithradates with a halo of romance. His courage, his bodily strength and size, his skill in the use of weapons, in riding, and in the chase, his speed of foot, his capacity for eating and drinking, his penetrating intellect and his mastery of 22 languages are celebrated to a degree which is almost incredible. With a surface gloss of Greek education, he united the subtlety, the superstition, and the obstinate endurance of an Oriental. He collected curiosities and works of art; he assembled Greek men of letters round him; he gave prizes to the greatest poets and the best eaters. He spent much of his time in practising magic, and it was believed that he had so saturated his body with poisons that none could injure him. He trusted no one; he murdered

¹ There is much difference of opinion in regard to the kings of Pontus called Mithradates to the accession of Mithradates Eupator. Ed. Meyer reckons five, T. Reinach three.

his mother, his sons, the sister whom he had married; to prevent his harem from falling to his enemies he murdered all his concubines, and his most faithful followers were never safe. For eighteen years he showed himself no unworthy adversary of Sulla, Lucullus and Pompey.

See T. Reinach, *Mithridate Eupator* (1890; Ger. trans. by A. Goetz, 1895, with the author's corrections and additions); also E. Meyer, *Geschichte des Königreichs Pontos* (1879).

MITHRAS, a Persian god of light, whose worship, the latest one of importance to be brought from the Orient to Rome, spread throughout the empire and became the greatest antagonist of Christianity.

I. History and Distribution.—The cult goes back to a period before the separation of the Persians from the Hindus, as is shown by references in the literatures of both stocks, the Avesta and the Vedas. Though but faintly pictured in the Vedic hymns, he is there invoked with Ormazd, or Ahuramazda, the god of the sky, and is clearly a divinity of light, the protector of truth and the enemy of error and falsehood. In the Avesta, after the separation of the Iranian stock from the Hindu and the rise of Zoroastrianism, which elevated Ormazd to the summit of the Persian theological system, his rôle was more distinct, though less important; between Ormazd, who reigned in eternal brightness, and Ahriman, whose realm was eternal darkness, he occupied an intermediate position as the greatest of the *yoastas*, beings created by Ormazd to aid in the destruction of evil and the administration of the world. He was thus a deity of the realms of air and light, and, by transfer to the moral realm, the god of truth and loyalty. Because light is accompanied by heat, he was the god of vegetation and increase; he sent prosperity to the good, and annihilated the bad; he was the god of armies and the champion of heroes; as the enemy of darkness and of all evil spirits, he protected souls, accompanying them on the way to paradise, and was thus a redeemer. Animals and birds were sacrificed and libations poured to him, and prayers were addressed to him by devotees who had purified themselves by ablation and repeated flagellation. As a god who gave victory, he was prominent in the official cult of Persia, the seventh month and the sixteenth day of other months being sacred to him. His worship spread with the empire of the Persians throughout Asia Minor, and Babylon was an important centre. Its popularity remained unimpaired after the fall of Persia, and it was during the ferment following the conquests of Alexander that the characteristics which mark it during the Roman period were firmly fixed. Mithraism was at full maturity on its arrival at Rome, the only modifications it ever suffered having been experienced during its younger days in Asia.

Modified though never essentially changed, (1) by contact with the star-worship of the Chaldaeans, who identified Mithras with Shamash, god of the sun, (2) by the indigenous Armenian religion and other local Asiatic faiths and (3) by the Greeks of Asia Minor, who identified Mithras with Helios, and contributed to the success of his cult by equipping it for the first time with artistic representations (the famous Mithras relief originated in the Pergamene school towards the 2nd century B.C.), Mithraism was first transmitted to the Roman world during the 1st century B.C. by the Cilician pirates captured by Pompey. It attained no importance, however, for nearly two centuries. The lateness of its arrival in the West was due to the fact that its centres of influence were not in immediate contact with Greek and Roman civilization. It never became popular in Greek lands, and was regarded by Hellenized nations as a barbarous worship. It was at rivalry with the Egyptian religion. As late as the time of Augustus it was but little known in Roman territory, and gained a firm foothold in Italy only gradually, as a result of the intercourse between Rome and Asia consequent upon the erection of the Eastern provinces and the submission and colonization of Mesopotamia. It seems at first to have had relations with the cult of the Great Mother of the Gods at Rome, whose influence served to protect it and facilitate its growth. The cult of Mithras began to attract attention at Rome about the end

of the 1st century A.D. Statius (c. A.D. 80) mentions the typical Mithraic relief in his *Thebaid* (l. 719,720); from Plutarch's (A.D. 46-125) *Vita Pompei* (24) it is apparent that the worship was well known; and the first Roman reliefs show the characteristics of about the same time.

Towards the close of the 2nd century the cult had begun to spread rapidly through the army, the mercantile class, slaves and actual propagandists, all of which classes were largely composed of Asiatics. It thrived especially among military posts, and in the track of trade, where its monuments have been discovered in greatest abundance. The German frontiers afford most evidence of its prosperity. Rome itself was a favourite seat of the religion. From the end of the 2nd century the emperors encouraged Mithraism, because of the support which it afforded to the divine right of monarchs. The Persian belief that the legitimate sovereign reigned by the grace of Ormazd, whose favour was made manifest by the sending of the *Hvorenô*, a kind of celestial aureole of fire, resulted in the doctrine that the sun was the giver of the *Hvorenô*. Mithras, identified with Sol Invictus at Rome, thus became the giver of authority and victory to the imperial house. From the time of Commodus, who participated in its mysteries, its supporters were to be found in all classes. Its importance at Rome may be judged from the abundance of monumental remains—more than 75 pieces of sculpture, 100 inscriptions, and ruins of temples and chapels in all parts of the city and suburbs.

Finally, philosophy as well as politics contributed to the success of Mithraism, for the outcome of the attempt to recognize in the Graeco-Roman gods only forces of nature was to make the Sun the most important of deities; and it was the Sun with whom Mithras was identified.

The beginning of the downfall of Mithraism dates from A.D. 275, when Dacia was lost to the empire, and the invasions of the northern peoples resulted in the destruction of temples along a great stretch of frontier, the natural stronghold of the cult. The aggression of Christianity also was now more effective. The emperors, however, favoured the cult, which was the army's favourite until Constantine destroyed its hopes. The reign of Julian and the usurpation of Eugenius renewed the hopes of its devotees, but the victory of Theodosius (394) may be considered the end of its existence. It still survived in certain cantons of the Alps in the 5th century, and clung to life with more tenacity in its Eastern home. Its legitimate successor was Manichaeism, which afforded a refuge to those mystics who had been shaken in faith, but not converted, by the polemics of the Church against their religion.

II. Sources, Remains, Ritual.—The sources of present knowledge regarding Mithraism consist of the Vedas, the Avesta, the Pahlavi writings, Greek and Latin literature and inscriptions, and the cult monuments. The monuments comprise the remains of nearly a score of temples and about 400 statues and bas reliefs. The Mithraic temples of Roman times were artificial grottoes (*spelaeae*) wholly or partially underground, in imitation of the original secluded mountain caverns of Asia. The Mithraeum hewn in the tufa quarries of the Capitoline Hill at Rome, still in existence during the Renaissance, is an example. The main room of the ordinary temple was rectangular, with an elevated apsidal arrangement, like a choir, containing the sacred relief on its wall, at the end opposite the entrance, and with continuous benches (*podia*) of masonry, about 5 ft. wide and inclining slightly towards the floor, built against the wall on its long sides. The ceiling was made to symbolize the firmament. There were arrangements for the brilliant illumination of the choir and its relief, which was sometimes sculptured on both sides and reversible, while the *podia* were intentionally more obscure. The choir and the long space between the *podia* were for ministrants, the *podia* themselves for kneeling worshippers. Two altars, to the Sun and the Moon, stood before the former, and cult statues along the latter. The approach to the grotto lay through a portico on the level with and fronting the street, and a *pronaos*, in communication with which was a kind of sacristy. Steps led to the lower level of the sanctuary. The

simplicity and smallness of the Mithraic temples are to be accounted for by structural and financial reasons; an underground temple was difficult to construct on a large scale, and the worshippers of Mithras were usually from the humbler classes. The average grotto held from fifty to a hundred persons. The size of the sanctuaries, however, was compensated for by their number; in Ostia alone there were five.

The typical bas relief, which is found in great abundance in the museums of Europe, invariably represents Mithras, under the form of a youth with conical cap and flying drapery, slaying the sacred bull, the scorpion attacking the genitals of the animal, the serpent drinking its blood, the dog springing towards the wound in its side, and frequently, in addition, the Sun-god, his messenger the raven, a fig-tree, a lion, a ewer, and torch-bearers. The relief is in some instances enclosed in a frame of figures and scenes in relief. The best example is the monument of Osterburken (Cumont, *Textes et monuments figurés*, No. 246). With this monument as a basis, Franz Cumont has arranged the small Mithraic reliefs into two groups, one illustrating the legend of the origin of the gods, and the other the legend of Mithras. In the first group are found Infinite Time, or Cronus; Tellus and Atlas supporting the globe, representing the union of Earth and Heaven; Oceanus; the Fates; Infinite Time giving into the hand of his successor Ormazd the thunderbolt, the symbol of authority; Ormazd struggling with a giant of evil—the Mithraic gigantomachy. The second group represents, first, the birth of Mithras; then the god nude, cutting fruit and leaves from a fig-tree in which is the bust of a deity, and before which one of the winds is blowing upon Mithras; the god discharging an arrow against a rock from which springs a fountain whose water a figure is kneeling to receive in his palms; the bull in a small boat, near which again occurs the figure of the animal under a roof about to be set on fire by two figures; the bull in flight, with Mithras in pursuit; Mithras bearing the bull on his shoulders; Helios kneeling before Mithras; Helios and Mithras clasping hands over an altar; Mithras with drawn bow on a running horse; Mithras and Helios banqueting; Mithras and Helios mounting the chariot of the latter and rising in full course over the ocean. Few of the Mithraic reliefs are of even mediocre art. Among the best is the relief from the Capitoline grotto, now in the Louvre.

Cumont's interpretation of the main relief and its smaller companions involves the reconstruction of a Mithraic theology, a Mithraic legend, and a Mithraic symbolism. Paucity of evidence makes the first difficult. The head of the divine hierarchy of Mithras was Infinite Time—Cronus, Saturn; Heaven and Earth were his offspring, and begat Ocean, who formed with them a trinity corresponding to Jupiter, Juno, and Neptune. From Heaven and Earth sprang the remaining members of a circle analogous to the Olympic gods. Ahriman, also the son of Time, was the Persian Pluto. Owing to Semitic influence every Persian god had in Roman times come to possess a twofold significance—astrological and natural, Semitic and Iranian—the earlier and deeper Iranian significance being imparted by the clergy to the few intelligent elect, the more attractive and superficial Chaldaean symbolism being presented to the multitude. Mithras was the most important member of the circle. He was regarded as the mediator between suffering humanity and the unknowable and inaccessible god of all being, who reigned in the ether.

The Mithras legend has been lost, and can be reconstructed only from the scenes on the above described relief. Mithras was born of a rock, the marvel being seen only by certain shepherds, who brought gifts and adored him. Chilled by the wind, the new-born god went to a fig-tree, partook of its fruit, and clothed himself in its leaves. He then undertook to vanquish the beings already in the world, and rendered subject to him first the Sun, with whom he concluded a treaty of friendship. The most wonderful of his adventures, however, was that with the sacred bull which had been created by Ormazd. The hero seized it by the horns and was borne headlong in the flight of the animal, which he finally subdued and dragged into a cavern.

The bull escaped, but was overtaken, and by order of the Sun, who sent his messenger the raven, was reluctantly sacrificed by Mithras. From the dying animal sprang the life of the earth, although Ahriman sent his emissaries to prevent it. The soul of the bull rose to the celestial spheres and became the guardian of herds and flocks under the name of Silvanus. Mithras was through his deed the creator of life. Meanwhile Ahriman sent a terrible drought upon the land. Mithras defeated his purpose by discharging an arrow against a rock and miraculously drawing the water from it. Next Ahriman sent a deluge, from which one man escaped in a boat with his cattle. Finally a fire desolated the earth, and only the creatures of Ormazd escaped. Mithras, his work accomplished, banqueted with the Sun for the last time, and was taken by him in his chariot to the habitation of the immortals, whence he continued to protect the faithful.

The symbolism employed by Mithraism finds its best illustration in the large central relief, which represents Mithras in the act of slaying the bull as a sacrifice to bring about terrestrial life, and thus portrays the concluding scenes in the legend of the sacred animal. The scorpion, attacking the genitals of the bull, is sent by Ahriman from the lower world to defeat the purpose of the sacrifice; the dog, springing towards the wound in the bull's side, was venerated by the Persians as the companion of Mithras; the serpent is the symbol of the earth being made fertile by drinking the blood of the sacrificial bull; the raven, towards which Mithras turns his face as if for direction, is the herald of the Sun-god, whose bust is near by, and who has ordered the sacrifice; various plants near the bull, and heads of wheat springing from his tail, symbolize the result of the sacrifice; the cypress is perhaps the tree of immortality. There was also an astrological symbolism, but it was superficial, and of secondary importance. The torch-bearers sometimes seen on the relief represent one being in three aspects—the morning, noon and evening sun, or the vernal, summer and autumn sun.

Owing to the almost absolute disappearance of documentary evidence, it is impossible to know otherwise than very imperfectly the inner life of Mithraism. Jerome (*Epist. cvii.*) and inscriptions preserve the knowledge that the mystic, *saceratus*, passed through seven degrees, which probably corresponded to the seven planetary spheres traversed by the soul in its progress to wisdom, perfect purity, and the abode of the blest: *Corax*, Raven, so named because the raven in Mithraic mythology was the servant of the Sun; *Cryphius*, Occult, a degree in the taking of which the mystic was perhaps hidden from others in the sanctuary by a veil, the removal of which was a solemn ceremonial; *Miles*, Soldier, signifying the holy warfare against evil in the service of the god; *Leo*, Lion, symbolic of the element of fire; *Perses*, Persian, clad in Asiatic costume, a reminiscence of the ancient origin of the religion; *Heliodromus*, Courier of the Sun, with whom Mithras was identified; *Pater*, Father, a degree bringing the mystic among those who had the general direction of the cult for the rest of their lives. One relief (Cumont, vol. i. p. 175, fig. 10) shows figures masked and costumed to represent *Corax*, *Perses*, *Miles* and *Leo*, indicating the practice on occasion of rites involving the use of sacred disguise, a custom probably reminiscent of the primitive time when men represented their deities under the form of animals, and believed themselves in closer communion with them when disguised to impersonate them. Of the seven degrees, those mystics not yet beyond the third, *Miles*, were not in full communion, and were called *imperiōdotes* (servants); while the fourth degree, *Leo*, admitted them into the class of the fully initiate, the *perēgōtes* (participants). No women were in any way connected with the cult, though the male sex could be admitted even in childhood. The time requisite for the several degrees is unknown, and may have been determined by the *Patres*, who conferred them in a solemn ceremony called *Sacramentum*, in which the initial step was an oath never to divulge what should be revealed, and for which the mystic had been specially prepared by lustral purification, prolonged abstinence, and severe deprivations. Special ceremonies accompanied

the diverse degrees: Tertullian speaks of "marking the forehead of a *Miles*," which may have been the branding of a Mithraic sign; honey was applied to the tongue and hands of the *Leo* and the *Perses*. A sacred communion of bread, water and possibly wine, compared by the Christian apologists to the Eucharist, was administered to the mystic who was entering upon one of the advanced degrees, perhaps *Leo*. The ceremony was probably commemorative of the banquet of Mithras and Helios before the former's ascension, and its effect strength of body, wisdom, prosperity, power to resist evil, and participation in the immortality enjoyed by the god himself. Other features reminiscent of the original barbarous rites in the primitive caverns of the East, no doubt also occupied a place in the cult; bandaging of eyes, binding of hands with the intestines of a fowl, leaping over a ditch filled with water, witnessing a simulated murder, are mentioned by the Pseudo-Augustine; and the manipulation of lights in the crypt, the administration of oaths, and the repetition of the sacred formulae, all contributed toward inducing a state of ecstatic exaltation. What in the opinion of Albrecht Dieterich (*Eine Mithrasliturgie*, Leipzig, 1903) is a Mithrasliturgy is preserved in a Greek MS. of Egyptian origin of about A.D. 300. It is the ritual of a magician, imbedded in which, and alternating with magic formulae and other occult matter, are a number of invocations and prayers which Dieterich reconstructs as a liturgy in use by the clergy of Mithras between A.D. 100 and 300, and adapted to this new use about the latter date.

The Mithraic priest, *sacerdos* or *antistes*, was sometimes also of the degree of *pater*. Tertullian (*De praescr. haeret.* 40) calls the chief priest *summus pontifex*, probably the *pater patrum* who had general supervision of all the initiates in one city, and states that he could marry but once. According to the same author, there were Mithraic, as well as Christian, *virgines et continentes*. Besides the administration of sacraments and the celebration of offices on special occasions, the priest kept alight the eternal fire on the altar, addressed prayers to the Sun at dawn, midday and twilight, turning towards east, south and west respectively. Clad in Eastern paraphernalia, he officiated at the numerous sacrifices indicated by the remains of iron and bronze knives, hatchets, chains, ashes and bones of oxen, sheep, goats, swine, fowl, &c. There was pouring of libations, chanting and music, and bells and candles were employed in the service. Each day of the week was marked by the adoration of a special planet, the sun being the most sacred of all, and certain dates, perhaps the sixteenth of each month and the equinoxes, in conformity with the character of Mithras mediator, wereset aside for special festivals.

The Mithraic community of worshippers, besides being a spiritual fraternity, was a legal corporation enjoying the right of holding property, with temporal officials at its head, like any other *sodalitas*: there were the *decuriones* and *decem primi*, governing councils resembling assembly and senate in cities; *magistri*, annually elected presidents; *curatores*, financial agents; *defensores*, advocates; and *patroni*, protectors among the influential. It may be that a single temple was the resort of several small associations of worshippers which were subdivisions of the whole community. The cult was supported mainly by voluntary contribution. An abundance of epigraphic evidence testifies to the devotion of rich and poor alike.

III. *Moral Influence*.—The rapid advance of Mithraism was due to its human qualities. Its communities were bound together by a sense of close fraternal relation. Its democracy obliterated the distinctions between rich and poor; slave and senator became subject to the same rule, eligible for the same honours, partook of the same communion, and were interred in the same type of sepulchre, to await the same resurrection. The reward of title and degree and the consequent rise in the esteem of his fellows and himself was also a strong incentive; but the Mithraic faith itself was the greatest factor. The impressiveness and the stimulating power of the mystic ceremonies, the consciousness of being the privileged possessor of the secret wisdom of the ancients, the sense of purification from sin,

and the expectation of a better life where there was to be compensation for the sufferings of this world—were all strong appeals to human nature. The necessity of moral rectitude was itself an incentive. Courage, watchfulness, striving for purity, were all necessary in the incessant combat with the forces of evil. Resistance to sensuality was one aspect of the struggle, and asceticism was not unknown. Mithras was ever on the side of the faithful, who were certain to triumph both in this world and the next. The worthy soul ascended to its former home in the skies by seven gates or degrees, while the unworthy soul descended to the realms of Ahri-man. The doctrine of the immortality of the soul was accompanied by that of the resurrection of the flesh; the struggle between good and evil was one day to cease, and the divine bull was to appear on earth, Mithras was to descend to call all men from their tombs and to separate the good from the bad. The bull was to be sacrificed to Mithras, who was to mingle its fat with consecrated wine and give to drink of it to the just, rendering them immortal, while the unjust, together with Ahri-man and his spirits, were to be destroyed by a fire sent from Heaven by Ormazd. The universe, renewed, was to enjoy eternal happiness.

IV. *Relation to Christianity*.—The most interesting aspect of Mithraism is its antagonism to Christianity. Both religions were of Oriental origin; they were propagated about the same time, and spread with equal rapidity on account of the same causes, viz. the unity of the political world and the debasement of its moral life. At the end of the 2nd century each had advanced to the farthest limits of the empire, though the one possessed greatest strength on the frontiers of the Teutonic countries, along the Danube and the Rhine, while the other thrived especially in Asia and Africa. The points of collision were especially at Rome, in Africa, and in the Rhône Valley, and the struggle was the more obstinate because of the resemblances between the two religions, which were so numerous and so close as to be the subject of remark as early as the 2nd century, and the cause of mutual recrimination. The fraternal and democratic spirit of the first communities, and their humble origin; the identification of the object of adoration with light and the Sun; the legends of the shepherds with their gifts and adoration, the flood, and the ark; the representation in art of the fiery chariot, the drawing of water from the rock; the use of bell and candle, holy water and the communion; the sanctification of Sunday and of the 25th of December; the insistence on moral conduct, the emphasis placed upon abstinence and self-control; the doctrine of heaven and hell, of primitive revelation, of the mediation of the Logos emanating from the divine, the atoning sacrifice, the constant warfare between good and evil and the final triumph of the former, the immortality of the soul, the last judgment, the resurrection of the flesh and the fiery destruction of the universe—are some of the resemblances which, whether real or only apparent, enabled Mithraism to prolong its resistance to Christianity. At their root lay a common Eastern origin rather than any borrowing.

On the other hand, there were important contrasts between the two. Mithraism courted the favour of Roman paganism and combined monotheism with polytheism, while Christianity was uncompromising. The former as a consequence won large numbers of supporters who were drawn by the possibility it afforded of adopting an attractive faith which did not involve a rupture with the religion of Roman society, and consequently with the state. In the middle of the 3rd century Mithraism seemed on the verge of becoming the universal religion. Its eminence, however, was so largely based upon dalliance with Roman society, its weakness so great in having only a mythical character, instead of a personality, as an object of adoration, and in excluding women from its privileges, that it fell rapidly before the assaults of Christianity. Manichaeism, which combined the adoration of Zoroaster and Christ, became the refuge of those supporters of Mithraism who were inclined to compromise, while many found the transition to orthodox Christianity easy because of its very resemblance to their old faith.

See Franz Cumont, *Textes et monuments figurés relatifs aux mystères de Mithra* (Brussels, 1896, 1899), which has superseded all publications on the subject; Albrecht Dieterich, *Eine Mithrasliturgie* (Leipzig, 1903). See also the translation of Cumont's *Conclusions* (the second part of vol. I of the above work, published separately 1902, under the title *Les Mystères de Mithra*), by T. J. McCormack (Chicago and London, 1903). Extended bibliography in Roscher's *Lexicon der Mythologie*. (G. Sn.)

MITRA, RAJENDRA LALA (1824-1891), Indian Orientalist, was born in a suburb of Calcutta on the 15th of February 1824, of a respectable family of the Kayasth or writer caste of Bengal. To a large extent he was self-educated, studying Sanskrit and Persian in the library of his father. In 1846 he was appointed librarian of the Asiatic Society, and to that society the remainder of his life was devoted—as philological secretary, as vice-president, and as the first native president in 1885. Apart from very numerous contributions to the society's journal, and to the series of Sanskrit texts entitled "Bibliotheca indica," he published three separate works: (1) *The Antiquities of Orissa* (2 vols., 1875 and 1880), illustrated with photographic plates, in which he traced back the image of Jagannath (Juggernaut) and also the car-festival to a Buddhist origin; (2) a similarly illustrated work on *Bodhi Gaya* (1878), the hermitage of Sakya Muni, and (3) *Indo-Aryans* (2 vols., 1881), a collection of essays dealing with the manners and customs of the people of India from Vedic times. He received the honorary degree of LL.D. from the university of Calcutta in 1875, the companionship of the Indian Empire when that order was founded in 1878, and the title of raja in 1888. He died at Calcutta on the 26th of July 1891.

MITRE (Lat. *mitra*, from Gr. *μίτρα*, a band, head-band, head-dress), a liturgical head-dress of the Catholic Church, generally proper to bishops.

1. *Latin Rite*.—In the Western Church its actual form is that of a sort of folding cap consisting of two halves which, when not worn, lie flat upon each other. These sides are stiffened, and when the mitre is worn, they rise in front and behind like two horns pointed at the tips (*cornua mitrae*). From the lower rim of the mitre at the back hang two bands (*infulae*), terminating in fringes. In the Roman Catholic Church mitres are divided into three classes: (1) *Mitra pretiosa*, decorated with jewels, gold plates, &c.; (2) *Mitra auriphygiata*, of white silk, sometimes embroidered with gold and silver thread or small pearls, or of cloth of gold plain; (3) *Mitra simplex*, of white silk damask, silk or linen, with the two falling bands behind terminating in red fringes. Mitres are the distinctive head-dress of bishops; but the right to wear them, as in the case of the other episcopal insignia, is granted by the popes to other dignitaries—such as abbots or the heads and sometimes all the members of the chapters of cathedral or collegiate churches. In the case of these latter, however, the mitre is worn only in the church to which the privilege is attached and on certain high festivals. Bishops alone, including of course the pope and his cardinals, are entitled to wear the *pretiosa* and *auriphygiata*; the others wear the *mitra simplex*.

The proper symbol of episcopacy is not so much the mitre as the ring and pastoral staff. It is only after the service of consecration and the mass are finished that the consecrating prelate asperses and blesses the mitre and places on the head of the newly consecrated bishop, according to the prayer which accompanies the act, "the helmet of protection and salvation," the two horns of which represent "the horns of the Old and New Testaments," a terror to "the enemies of truth," and also the horns of "divine brightness and truth" which God set on the brow of Moses on Mount Sinai. There is no suggestion of the popular idea that the mitre symbolizes the "tongues of fire" that descended on the heads of the apostles at Pentecost.

According to the Roman *Caeremoniale* the bishop wears the *mitra pretiosa* on high festivals, and always during the singing of the *Te Deum* and the *Gloria* at mass. He is allowed, however, "on account of its weight," to substitute for the *pretiosa* the *auriphygiata* during part of the services, i.e. at Vespers from the first psalm to the *Magnificat*, at mass from the end of the *Kyrie* to the

canon. The *auriphygiata* is worn during Advent, and from Septuagesima to Maundy Thursday, except on the third Sunday in Advent (*Gaudete*), the fourth in Lent (*Laetare*) and on such greater festivals as fall within this time. It is worn, too, on the vigils of fests, Ember Days and days of intercession, on the Feast of Holy Innocents (if on a week-day), at *Itanies*, penitential processions, and at other than solemn benedictions and consecrations. At mass and vespers the *mitra simplex* may be substituted for it in the same way as the *auriphygiata* for the *pretiosa*. The *simplex* is worn on Good Friday, and at masses for the dead; also at the blessing of the candles at Candlemas, the singing of the absolution at the coffin, and the solemn investiture with the pallium. At provincial synods archbishops wear the *pretiosa*, bishops the *auriphygiata*, and mitred abbots the *simplex*. At general councils bishops wear white mitres, cardinals mitres of white silk damask; this is also the case when bishops and cardinals in *pontificalibus* assist at a solemn pontifical function presided over by the pope.

Lastly, the mitre, though a liturgical vestment, differs from the others in that it is never worn when the bishop addresses the Almighty in prayer—e.g. during mass he takes it off when he turns to the altar, placing it on his head again when he turns to address the people (see 1 Cor. xi. 4).

The origin and antiquity of the episcopal mitre have been the subject of much debate. Some have claimed for it apostolical sanction and found its origin in the liturgical head-gear of the Jewish priesthood. Such proofs Origin and Antiquity. as have been adduced for this view are, however, based on the fallacy of reading into words (*mitra*, *infula*, &c.) used by early writers a special meaning which they only acquired later. *Mitra*, even as late as the 15th century, retained its simple meaning of cap (see Du Cange, *Glossarium*, s.v.); to Isidore of Seville it is specifically a woman's cap, *Infula*, which in late ecclesiastical usage was to be confined to mitre (and its dependent bands) and chasuble, meant originally a piece of cloth, or the sacred fillets used in pagan worship, and later on came to be used of any ecclesiastical vestment, and there is no evidence for its specific application to the liturgical head-dress earlier than the 12th century. With the episcopal mitre the Jewish *misnephet*, translated "mitre" in the Authorized Version (Exod. xxviii. 4, 36), has nothing to do, and there is no evidence for the use of the former before the middle of the 10th century even in Rome, and elsewhere than in Rome it does not make its appearance until the 11th.¹

The first trustworthy notice of the use of the mitre is under Pope Leo IX. (1049-1054). This pope invested Archbishop Eberhard of Trier, who had accompanied him to Rome, with the Roman *mitra*, telling him that he and his successors should wear it *in ecclesiastico officio* (i.e. as a liturgical ornament) according to Roman custom, in order to remind him that he is a disciple of the Roman see (Jaffé, *Regesta pont. rom.*, ed. Leipzig, 1888, No. 4158). This proves that the use of the mitre had been for some time established at Rome; that it was specifically a Roman ornament; and that the right to wear it was only granted to ecclesiastics elsewhere as an exceptional honour.² On the other hand, the Roman *ordines* of the 8th and 9th centuries make no mention of the mitre; the evidence goes to prove that this liturgical head-dress was first adopted by the popes some time in the 10th century; and Father Braun shows convincingly that it was in its origin nothing else than the papal *regnum* or *phrygium* which, originally worn only at outdoor processions and the like, was introduced into the church, and thus developed into the liturgical mitre, while outside it preserved its original significance as the papal

¹ Father Braun, S. J., has dealt exhaustively with the supposed evidence for its earlier use—e.g. he proves conclusively that the *mitra* mentioned by Theodolph of Orleans (*Parænes. ad episc.*) is the Jewish *misnephet*, and the well-known miniature of Gregory the Great (not St Dunstan, as commonly assumed) wearing a mitre (Cotton MSS. Claudius A. iii.) in the British Museum, often ascribed to the 10th or early 11th century, he judges from the form of the pallium and dalmatic to have been produced at the end of the 11th century at earliest. The papal bulls granting the use of mitres before the 11th century are all forgeries (*Liturgische Gewandung*, 431-448).

² That it had been already so granted is proved by a miniature containing the earliest extant representations of a mitre, in the *Exultet rosa* and baptismal *rosula* at Bari (reproduced in Berteaux, *L'Art dans l'Italie méridionale*, I., Paris, 1904).

tiara (*q.v.*). From Leo IX.'s time papal grants of the mitre to eminent prelates became increasingly frequent, and by the 12th century it had been assumed by all bishops in the West, with or without papal sanction, as their proper liturgical head-dress. From the 12th century, too, dates the custom of investing the bishop with the mitre at his consecration.

It was not till the 12th century that the mitre came to be regarded as specifically episcopal, and meanwhile the custom had grown up of granting it *honoris causa* to other dignitaries besides bishops. The first known instance of a mitred abbot is Egelsinus of St Augustine's, Canterbury, who received the honour from Pope Alexander II. in 1063. From this time onward papal bulls bestowing mitres, together with other episcopal *insignia*, on abbots become increasingly frequent. The original motive of the recipients of these favours was doubtless the taste of the time for outward display; St Bernard, zealous for the monastic ideal, denounced abbots for wearing mitres and the like *more pontificum*, and Peter the Cantor roundly called the abbatial mitre "inane, superfluous and puerile" (*Verb. abbrev.* c. xlv. in Migne, *Patrolog. lat.* 205, 150). It came, however, to symbolize the exemption of the abbots from episcopal jurisdiction, their quasi-episcopal character, and their immediate dependence on the Holy See. No such significance could attach to the grant of the *usus mitrae* (under somewhat narrow restrictions as to where and when) to cathedral dignitaries. The first instance is again a bull of Leo IX. (1051) granting to Hugh, archbishop of Besançon, and his seven cardinals the right to wear the mitre at the altar as celebrant, deacon and subdeacon, a similar privilege being granted to Bishop Hartwig of Bamberg in the following year. The intention was to show honour to a great church by allowing it to follow the custom doubtless already established at Rome. Subsequently the privilege was often granted, sometimes to one or more of the chief dignitaries, sometimes to all the canons of a cathedral (e.g. Campostella, Prague).

Mitres were also sometimes bestowed by the popes on secular sovereigns, e.g. by Nicholas II. (1058-1061) on Spitenescu (Spythinev) II., duke of Bohemia; by Alexander II. on Wratislav of Bohemia; by Lucius II. (1144-1145) on Roger of Sicily; and by Innocent III., in 1204, on Peter of Aragon. In the coronation of the emperor, more particularly, the mitre played a part. According to the 14th Roman *ordo*, of 1241, the pope places on the emperor's head first the *mitra clericalis*, then the imperial diadem. Father Braun (*Liturgische Gewandung*, p. 457) gives a picture of a seal of Charles IV. representing him as wearing both.

The original form of the mitre was that of the early papal tiara (*regnum*), i.e. a somewhat high conical cap. The stages of its general development from this shape to the high double-horned modern mitre are clearly traceable (see fig. 1), though it is impossible exactly to distinguish them in point of date. The most characteristic modifications may be said to have taken place from the 11th to the middle of the 13th century. About 1100 the conical mitre begins to give place to a round one; a band of embroidery is next set over the top from back to front, which tends to bulge up the soft material on either side; and these bulges develop into points or horns. Mitres with horns on either side seem to have been worn till about the end of the 12th century, and Father Braun gives examples of their appearances on episcopal seals in France until far into the 13th. Such a mitre appears on a seal of Archbishop Thomas Becket (Father Thurston, *The Pallium*, London, 1892, p. 17). The custom was, however, already growing up of setting the horns over the front and back

of the head instead of the sides (the mitre said to have belonged to St Thomas Becket, now at Westminster Cathedral, is of this type),¹ and with this the essential character of the mitre, as it persisted through the middle ages, was established. The exaggeration of the height of the mitre, which began at the time of the Renaissance, reached its climax in the 17th century.

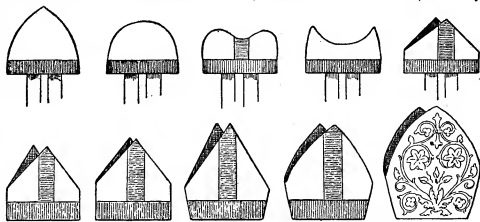

Drawn by Father J. Braun and reproduced from his *Liturgische Gewandung* by permission of B. Herder.

FIG. 1.—Evolution of the Mitre from the 11th century to the present day.

This ugly and undignified type is still usually worn in the Roman Catholic Church, but in some cases the earlier type has survived, and many bishops are also now reverting to it.

The decoration of mitres was characterized by increasing elaboration as time went on. From the first the white conical cap seems to have been decorated round the lower edge by a band or orphrey (*circulus*). To this was added later a vertical orphrey (*titulus*), usually from the centre of the front of the *circulus* to that of the back, partly in order to hide the seam, partly to emphasize the horns when those were to left and right. When the horns came to be set before and behind, the vertical orphrey retained its position. Of the surviving early mitres the greater number have only the orphrey embroidered, the body of the mitre being left plain. Very early, however, the custom arose of ornamenting the triangular spaces between the orphreys with embroidery, usually a round medallion, or a star, set in the middle, but sometimes figures of saints, &c. (e.g. the early example from the cathedral of Anagni, reproduced by Braun, p. 460). The richness and variety of decoration increased from the 14th century onwards. Architectural motives even were introduced, as frames to the embroidered figures of saints, while sometimes the upper edges of the mitre were ornamented with crockets, and the horns with architectural finials. Finally, the traditional *circulus* and *titulus* seem all but forgotten, the whole front and back surfaces of the mitre being ornamented with embroidered pictures or with arabesque patterns. The latter is characteristic of the mitre in the modern Roman Catholic Church, the tradition of the local Roman Church having always excluded the representation of figures on ecclesiastical vestments.

2. *Reformed Churches*.—In most of the reformed Churches the use of mitres was abandoned with that of the other vestments. They have continued to be worn, however, by the bishops of the Scandinavian Lutheran Churches. In the Church of England the use of the mitre was discontinued at the Reformation. There is some evidence to show that it was used in consecrating bishops up to 1552, and also that its use was revived by the Laudian bishops in the 17th century (*Hierurgia anglicana* ii. 242, 243, 240). In general, however, there is no evidence to prove that this use was liturgical, though the silver-gilt mitre of Bishop Wren of Ely (d. 1667), which is preserved, is judged from the state of the lining to have been worn. The instances of the use of the mitre quoted in *Hier. anglic.* ii. 310, as carried by the bishop of Rochester at an investiture of the Knights of the Bath (1725), and by the archbishops and bishops at the coronation of George II. (1727), have no liturgical significance. The tradition of the mitre as an episcopal ornament has, nevertheless, been continuous in the Church of England, "and that on three lines: (1) heraldic usage; (2) its presence on the head of effigies of bishops, of which a number are extant, of the 16th, 17th, 18th and 19th centuries; (3) its presence in funeral processions, where

¹ In Father Braun's opinion, expressed to the writer, this mitre, which was formerly at Sens, belongs probably to the 13th century.

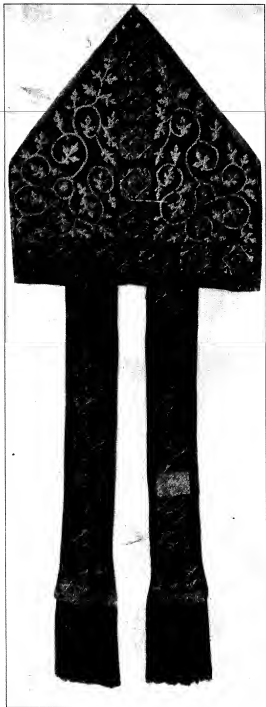

From a photograph by Father Joseph Bevan, S. J., by kind permission.

FIG. 5.—German Mitre, of red velvet embroidered with pearls and silver gilt plaques. 13th century. In the cathedral at Halberstadt.

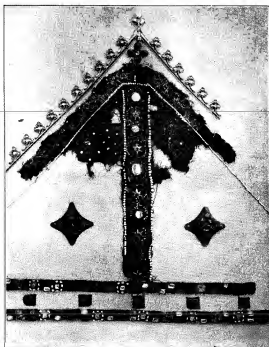

FIG. 6.—Mitre (restored) of William of Wykeham, Bishop of Winchester (d. 1404), preserved at New College, Oxford.

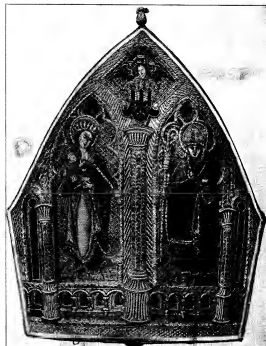

FIG. 7.—Flemish Mitre, embroidered in gold thread, and the panels in colours, with figures of the Virgin and St. Augustine. The other side is similar, with figures of St. Leonardi and St. Mary Magdalene. It is dated 1592, repaired in 1766.

In the Victoria and Albert Museum.

an actual mitre or the figure of one was sometimes carried, and sometimes suspended over the tomb" (*Report on the Ornaments of the Church*, p. 106). The liturgical use of the mitre was revived in the Church of England in the latter part of the 19th century, and is now fairly widespread.

3. *Oriental Rites*.—Some form of liturgical head-dress is common to all the Oriental rites. In the Orthodox Eastern Church the mitre (Gr. *μίτρα*; Slav. *mīra*) is, as in the Western Church, proper only to bishops. Its form differs entirely from that of the Latin Church. In general it rather resembles a closed crown, consisting of a circlet from which rise two arches intersecting each other at right angles. Circlet and arches are richly chased and jewelled; they are filled out by a cap of stiff material, often red velvet, ornamented with pictures in embroidery or *appliqué* metal. Surmounting all, at the intersection of the arches is a cross. In Russia this usually lies flat, only certain metropolitans, and by prescription the bishops of the eparchy of Kiev, having the right to have the cross upright (see fig. 2).



Drawn from a photograph taken by Father I. Braun (reproduced in *Die liturgische Gewandung*). By permission of B. Herder.

FIG. 2.—Greek Mitre.

In the Armenian Church priests and archdeacons, as well as the bishops, wear a mitre. That of the bishops is of the Latin form, a custom dating from a grant of Pope Innocent III.; that of the priests, the *sagahart*, is not unlike the Greek mitre (see fig. 3). In the Syrian Church only the patriarch wears a mitre, which resembles that of the Greeks. The *biruma* of the Chaldaean Nestorians, on the other hand, worn by all bishops, is a sort of hood ornamented with a cross. Coptic priests and bishops wear the *ballin*, a long strip of stuff ornamented with crosses &c., and wound turban-wise round the head; the patriarch of Alexandria has a helmet-like mitre, the origin of which is unknown, though it perhaps antedates the appearance of the *phrygium* at Rome. The Maronites, and the uniate Jacobites, Chaldaeans and Copts have adopted the Roman mitre.



From Braun's *Liturgische Gewandung*. By permission of B. Herder.

FIG. 3.—Mitre of Armenian Priest.

The mitre was only introduced into the Greek rite in comparatively modern times. It was unknown in the earlier part of the 15th century, but had certainly been introduced by the beginning of the 16th. Father Braun suggests that its assumption by the Greek patriarch was connected with the changes due to the capture of Constantinople by the Turks. Possibly, as its form suggests, it is based on the imperial crown and symbolized at the outset the quasi-sovereignty over the *rayah* population which Mahommed II. was content to leave to the patriarch. In 1589 it was introduced into Russia, when the tsar Theodore erected the Russian patriarchate and bestowed on the new patriarch the right to wear the mitre, *sakkos* and *mandyas*, all borrowed from the Greek rite.

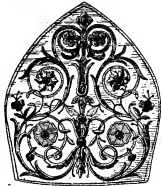

Reproduced by kind permission of the Archbishop of Westminster.

FIG. 4.—Mitre previous of the late Cardinal Vaughan, Roman Catholic Archbishop of Westminster.

mitre, *sakkos* and *mandyas*, all borrowed from the Greek rite.

A hundred years later the mitre, originally confined to the patriarch, was worn by all bishops.

See J. Braun, S.J., *Die liturgische Gewandung* (Freiburg-im-Breisgau, 1907), pp. 424-498. The question of the use of the mitre in the Anglican Church is dealt with in the *Report of the Sub-Committee of the Convocation of Canterbury on the Ornaments of the Church and its Ministers* (1908). See also the bibliography to the article VESTMENTS. (W. A. P.)

MITROVICA (Hungarian, *Mitrovica*; German, *Mitrowitz*), a town of Croatia-Slavonia, Hungary, situated on the river Save, in the county of Syrmia. Pop. (1900), 11,518. Mitrovica is on the railway from Agram, 170 m. W.N.W. to Belgrade, 38 m. E. by S. Roman remains have been discovered in its neighbourhood, and it occupies the site of *Sirmium* or *Syrmium*, the chief city of Lower Pannonia under Roman rule. The emperor Probus (232-282) was born and buried at Sirmium, where, according to some authorities, the emperor Marcus Aurelius (161-180) also died; but this is uncertain. In 351, 357 and 358, ecclesiastical councils of some importance met at Sirmium, which became an episcopal see about 305, and was united with the diocese of Bosnia in 1773. The city was sacked by the Huns in 441, and by the Turks, who destroyed all its ancient buildings, in 1306 and 1521.

MITSCHERLICH, EILHARDT (1794-1863), German chemist, was born on the 7th of January 1794 at Neudene near Jever, in the grand duchy of Oldenburg, where his father was pastor. His uncle, CHRISTOPH WILHELM MITSCHERLICH (1760-1854), professor at Göttingen, was in his day a celebrated scholar. He was educated at Jever under the historian F. C. Schlosser, when he went to Heidelberg in 1811, devoted himself to philology, giving special attention to the Persian language. In 1813 he went to Paris to obtain permission to join the embassy which Napoleon I. was to send to Persia. The events of 1814 put an end to this, and Mitscherlich resolved to study medicine in order that he might enjoy that freedom of travel usually allowed in the East to physicians. He began at Göttingen with the study of chemistry, and this so arrested his attention that he gave up the journey to Persia. From his Göttingen days dates the treatise on certain parts of Persian history, compiled from MSS. in the university library and published in Persian and Latin in 1814, under the title *Mitchondii historia Thaheridarum historicis nostris hucusque incognitorum Persiae principum*. In 1818 he went to Berlin and worked in the laboratory of H. F. Link (1767-1851). There he made analyses of phosphates and phosphites, arsenates and arsenites, confirming the conclusions of J. J. Berzelius as to their composition; and his observation that corresponding phosphates and arsenates crystallize in the same form was the germ from which grew the theory of isomorphism which he communicated to the Berlin Academy in December 1819. In that year Berzelius suggested Mitscherlich to the minister Altenstein as successor to M. H. Klaproth at Berlin. Altenstein did not immediately carry out this proposal, but he obtained for Mitscherlich a government grant to enable him to continue his studies in Berzelius's laboratory at Stockholm. He returned to Berlin in 1821, and in the summer of 1822 he delivered his first lecture as extraordinary professor of chemistry in the university, where in 1825 he was appointed ordinary professor. In the course of an investigation into the slight differences discovered by W. H. Wollaston in the angles of the rhombohedra of the carbonates isomorphous with calc-spar, he observed that the angle in the case of calc-spar varied with the temperature. On extending his inquiry to other aetotropic crystals he observed a similar variation, and was thus led, in 1825, to the discovery that aetotropic crystals, when heated, expand unequally in the direction of dissimilar axes. In the following year he discovered the change, produced by change of temperature, in the direction of the optic axes of selenite. His investigation (also in 1826) of the two crystalline modifications of sulphur threw much light on the fact that the two minerals calc-spar and aragonite have the same composition but different crystalline forms, a property which Mitscherlich called dimorphism. In 1833 he made a series of careful determinations of the vapour densities of a large

number of volatile substances, confirming Gay-Lussac's law. He obtained selenic acid in 1827 and showed that its salts are isomorphous with the sulphates, while a few years later he proved that the same thing is true of the manganates and the sulphates, and of the permanganates and the perchlorates. He investigated the relation of benzene to benzoic acid and to other derivatives. In 1829-1830 he published his *Lehrbuch der Chemie*, which embodied many original observations. His interest in mineralogy led him to study the geology of volcanic regions, and he made frequent visits to the Eifel with a view to the discovery of a theory of volcanic action. He did not, however, publish any papers on the subject, though after his death his notes were arranged and published by Dr. J. L. A. Roth in the *Memoirs of the Berlin Academy* (1866). In December 1861 symptoms of heart-disease made their appearance, but he was able to carry on his academical work till December 1862. He died at Schönberg near Berlin, on the 28th of August 1863.

Mitscherlich's published papers are chiefly to be found in the *Abhandlungen of the Berlin Academy*, in *Poggendorff's Annalen*, and in the *Annales de chimie et de physique*. The 4th edition of the *Lehrbuch der Chemie* was published in 1844-1847, a 5th was begun in 1855, but was not completed.

MITTEN, a covering for the hand, with a division for the thumb only, and reaching to the lower joint of the fingers; it is made of silk, lace, wool or other material. The word is of obscure origin; it has been connected with Ger. *mitte*, middle, half, in the sense of that which half covers the hand. There are several Celtic words which may be cognate, e.g. Irish *miotag*, *mitan*, a thick glove, mitten, such as is worn by hedgers and ditchers. The 16th-century French word *miton* meant a gauntlet. A fine mitten made of lace or open network and extending well up the forearm was much worn by ladies in the early part of the 19th century, and has been fashionable at various times since that date.

MITZPEIDA, a town of Germany in the kingdom of Saxony, on the Zschopau, 12 m. by rail N. of Chemnitz on the railway to Döbeln and Riesa. Pop. (1905), 17,465. It has a handsome Evangelical church, a classical, a modern and a technical school, and cotton and spinning mills. Other industries are the making of furniture, machinery, cigars and cement.

MIVART, ST GEORGE JACKSON (1827-1900), English biologist, was born in London on the 30th of November 1827, and educated at Clapham grammar-school, Harrow, and King's College, London, and afterwards at St Mary's, Oscott, since his conversion to Roman Catholicism prevented him from going to Oxford. In 1851 he was called to the bar, but he devoted himself to medical and biological studies. In 1862 he was appointed lecturer at St Mary's Hospital medical school, in 1869 he became a fellow of the Zoological Society, and from 1874 to 1877 he was professor of biology at the short-lived Roman Catholic University College, London. In 1873 he published *Lessons in Elementary Anatomy*, and an essay on *Man and Apes*. In 1881 appeared *The Cat: an Introduction to the Study of Back-boned Animals*. The careful and detailed work he bestowed on Insectivora and Carnivora largely increased our knowledge of the anatomy of these groups. In 1871 his *Genesis of Species* brought him into the controversy then raging. Though admitting evolution generally, Mivart denied its applicability to the human intellect.

His views as to the relationship existing between human nature and intellect and animal nature in general were given in *Nature and Thought* (1882); and in the *Origin of Human Reason* (1889) he stated what he considered the fundamental difference between men and animals. In 1884, at the invitation of the Belgian episcopate, he became professor of the philosophy of natural history at the university of Louvain, which had conferred on him the degree of M.D. in 1884. Some articles published in the *Nineteenth Century* in 1892 and 1893, in which Mivart advocated the claims of science even where they seemed to conflict with religion, were placed on the *Index expurgatorius*, and other articles in January 1900 led to his excommunication by Cardinal Vaughan, with whom he had a curious correspondence vindicating his claim to hold liberal opinions while

remaining in the Roman Catholic Church. Shortly afterwards he died, in London, on the 1st of April 1900. Mivart was also the author of many scientific papers and occasional articles, and of *Castle and Manor: a Tale of our Time* (1900), which originally appeared in 1894 as *Henry Standon*, by "D'Arcy Drew."

MIZPAH, or **MIZPEH**, the name of several places referred to in the Old Testament, in each case probably derived from a "commanding prospect," the Hebrew name having that significance. (1) **MIZPAH OF GILEAD**, where Jacob was reconciled to Laban (Gen. xxxi. 49); apparently the site of the camp of the Israelites when about to attack the Ammonites under Jephthah's leadership (Judges x. 17). This ancient sanctuary was probably the scene of Jephthah's vow (Judges xi. 29; cf. v. 11). The identification of this Mizpeh is a difficult problem: it is supposed to be the same as Ramoth Gilead, but the evidence is scarcely conclusive. It is referred to in Hos. v. 1. (2) **MIZPAH OF BENJAMIN**. It has been suggested, on hardly sufficient grounds, that the Mizpeh where the Hebrews assembled before the extermination of the Benjamites (Judges xx. 1) was not the shrine where Samuel made his headquarters (1 Sam. vii. 5). It was fortified by Asa (1 Kings xv. 22), and after the destruction of Jerusalem was the seat of government under the viceroy Gedaliah (2 Kings xxv. 23); here Gedaliah was murdered (ibid. 25). After the exile it retained the reputation of being a seat of government (Neh. iii. 7) and a holy place (1 Macc. iii. 46). It is probably to be identified with the mountain, Neby Samwil, north of Jerusalem, still considered sacred by the Moslems: a Crusaders' church (now a mosque), covers the traditional tomb of Samuel. (3) A territory near Mount Hermon, a seat of the Hivites, which joined the coalition of Jabin against Joshua (Joshua xi. 3). In the territory was the "valley of Mizpeh" (v. 8) where the Canaanites were routed. (4) A town in the tribe of Judah (Joshua xv. 38). (5) **MIZPEH OF MOAB**, where David interviewed the king of Moab and found an asylum for his parents (1 Sam. xxii. 3). (R. A. S. M.)

MIZRAIM, the biblical name for Egypt (Gen. x. 6, 13, Hebrew *Misrayim*); the apparently dual termination *-aim* may be due to a misunderstanding; there is an alternative poetical form *Māṣōr* (2 Kings xi. 24, &c.). In Isa. xi. 11 the name is kept distinct from Pathros or Upper Egypt, and represents some portion at least of Lower Egypt. It perhaps means "boundary" or "frontier," a somewhat ambiguous term, which illustrates the topographical problems. First (a), E. Schrader pointed out in 1874 that the Assyrians knew of some *Muṣri* (i.e. Mizraim) in North Syria, and it is extremely probable that this land is referred to in 2 Kings vii. 6 (mentioned with the Hittites), and in 1 Kings x. 28 seq., 2 Chron. i. 16 seq., where the word for "doves" (Heb. *m-q-n-h*) conceals the contiguous land *Kuē* (Cilicia).¹ Next (b), C. T. Beke, as long ago as 1834, concluded in his *Origines biblicæ* (p. 167 et passim) that "Egypt" in the Old Testament sometimes designates a district near Midian and the Gulf of 'Akaba, and the view restated recently and quite independently by H. Winckler on later evidence (1893) has been the subject of continued debate. Egypt is known to have laid claim to the southern half of Palestine from early times, and consequently the extension of the name of Egypt beyond the limits of Egypt and of the Sinaitic peninsula, is inherently probable. When, for example, Hagar, the "Egyptian," is the ancestress of Ishmaelite tribes, the evidence makes it very unlikely that the term is to be understood in the strict ethnical sense; and there are other passages more suitably interpreted on the hypothesis that the wider extension of the term was once familiar. In the second half of the 8th century B.C., Assyrian inscriptions allude to a powerful *Muṣri* at a time when the Nile empire was disintegrated and scarcely in a position to play the part ascribed to it (i.e. if by *Muṣri* we are to understand Egypt).² Not until the supremacy of Tirkahak does the ambiguity begin to disappear, and much depends upon the

¹ See further, H. Winckler, *All. lest. Untersuch.* (1892), pp. 168-174.

² So, too, according to one passage, Tiglath-pileser IV. appoints a governor over *Muṣri* before Egypt itself had actually been conquered.

unbiased discussion of the related biblical history (especially the writings of Isaiah and Hosea) and the Egyptian data. But even in the period of disintegration the minor princes of the Delta were no doubt associated with their eastern neighbours, and although the Assyrian Mušri stands in the same relation to the people of Philistia as do the Edomites and allied tribes of the Old Testament, Philistia itself was always intimately associated with Egypt. (See PHILISTINES.)

The problem is complicated by the obscurity which overshadows the history of south Palestine and the Delta (see EDOM; MIDIAN). The political importance of Egypt was not constant, and the known fluctuations of geographical terms combine with the doubtful accuracy of early writers to increase the difficulties. The Assyrian evidence alone points very strongly to a Mušri in north-west Arabia; the biblical evidence alone suggests an extra-Egyptian Misrayim. On the whole the result of discussion has been to admit the probability that Misrayim could refer to a district outside the limits of Egypt proper. But it has not justified the application of this conclusion to all the instances in which some critics have relied upon it, or the sweeping inferences and reconstructions which have sometimes been based upon it. Each case must be taken on its merits.

See further, H. Winkler, *Altorient. Forschungen*, i. 24 seq; *Mittell. d. vorderasiat. Gesell.* (1898), pp. 1 sqq., 16 sqq.; *IIIbert Journal* (April 1904); *Keilinschr. u. das alte Test.*, 3rd ed., 136 sqq.; and *Im Kampfe um den alten Orient*, ii. (1907); T. K. Cheyne, especially *Kingdom of Judah* (1908), pp. xiv. sqq.; F. Hommel, *Vier neue arab. Landtschaftsnamen in A. T.* For criticisms (many of them somewhat capricious) see König's reply to Hommel (Berlin, 1902); A. Noordtzi, *Theolog. Tijdschr.* (1906, July, September), and E. Meyer, *Israeliten u. ihre Nachbarstämme*, pp. 455 sqq. A valuable survey of the geographical and other conditions is given by N. Schmidt, *IIIbert Journal* (January 1908). (S. A. C.)

MNEMONICS (from Gr. *μνάσθαι*, remember; whence *μνήμων*, mindful; *τὸ μνημονικόν*, sc. *τέχνημα*, that which mechanically aids the memory), the general name applied to devices for aiding the memory. Such devices are also described as *memoria technica*. The principle is to enable the mind to reproduce a relatively unfamiliar idea, and specially a series of dissociated ideas, by connecting it, or them, in some artificial whole, the parts of which are mutually suggestive. A pupil is far more likely to remember the cities which claimed to be the birthplace of Homer when he remembers that their names can be made to form the hexameter line, "Smyrna, Chios, Colophon, Salamis, Rhodos, Argos, Athenae." Among the most famous examples of metrical mnemonics are the "gender rhymes" of the Latin grammars, the hexameter lines (especially that beginning "Barbara Celarent") invented by logicians (for a list see Baldwin's *Dict. of Philos.*, vol. ii., s.v. "Mnemonic Verses"), the verse for remembering the number of days in the months ("Thirty days hath September, April, June and November"). Other devices are numerous. Thus the name and lights of the sides of a ship may be remembered because the three shorter words "port," "left," "red," go together, as compared with the longer, "starboard," "right," "green."

Memory is commonly classified by psychologists according as it is exercised (a) *mechanically*, by attention and repetition; (b) *judiciously*, by careful selection and co-ordination; and (c) *ingeniously*, by means of artifices, i.e. mnemotechny, mnemonics. It must, however, be observed that no mnemonic is of any value which does not possess the qualities of (a) and (b). A mnemonic is essentially a device which uses attention and repetition, and careful selection is equally necessary. A more accurate description of mnemonics is "mediate" or "indirect" memory. In the technical sense the word "mnemonic" is confined to the systems of general application which have been elaborated by various writers.

Systems.—Mnemonic devices were much cultivated by Greek sophists and philosophers, and are repeatedly referred to by Plato and Aristotle. In later times the invention was ascribed to the poet Simonides,¹ perhaps for no other reason than that the strength of his memory was famous. Cicero, who attaches

considerable importance to the art, but more to the principle of order as the best help to memory, speaks of Carneades (or perhaps Charmades) of Athens and Metrodorus of Scepsis as distinguished examples of the use of well-ordered images to aid the memory. The latter is said by Pliny to have carried the art so far "ut nihil non iisdem verbis redderet auditum." The Romans valued such helps as giving facility in public speaking. The method used is described by the author of *Rhet. ad Herem.*, iii. 16-24; see also Quintilian (*Inst. Or. xi.* 2), whose account is, however, somewhat incomplete and obscure. In his time the art had almost ceased to be practised. The Greek and Roman system of mnemonics was founded on the use of mental places and signs or pictures, known as "topical" mnemonics. The most usual method was to choose a large house, of which the apartments, walls, windows, statues, furniture, &c., were severally associated with certain names, phrases, events or ideas, by means of symbolic pictures; and to recall these it was only necessary to search over the apartments of the house till the particular place was discovered where they had been deposited by the imagination. In accordance with this system, if it were desired to fix an historic date in the memory, it was localized in an imaginary town divided into a certain number of districts, each with ten houses, each house with ten rooms, and each room with a hundred quadrates or memory-places, partly on the floor, partly on the four walls, partly on the roof. Thus, if it were desired to fix in the memory the date of the invention of printing (1436), an imaginary book, or some other symbol of printing, would be placed in the thirty-sixth quadrate or memory-place of the fourth room of the first house of the historic district of the town. Except that the rules of mnemonics are referred to by Martianus Capella, nothing further is known regarding the practice of the art until the 13th century. Among the voluminous writings of Roger Bacon is a tractate *De arte memorativa*. Raimon Lull devoted special attention to mnemonics in connexion with his *ars generalis*. The first important modification of the method of the Romans was that invented by the German poet Konrad Celtes, who, in his *Epitoma in utramque Ciceronis rhetoricam cum arte memorativa nova* (1492), instead of places made use of the letters of the alphabet. About the end of the 15th century Petrus de Ravenna (b. 1448) awakened such astonishment in Italy by his mnemonic feats that he was believed by many to be a necromancer. His *Phoenix artis memoriae* (Venice, 1491, 4 vols.) went through as many as nine editions, the seventh appearing at Cologne in 1608. An impression equally great was produced about the end of the 16th century by Lambert Schenkel (*Gasophylacium*, 1610), who taught mnemonics in France, Italy, and Germany, and, although he was denounced as a sorcerer by the university of Louvain, published in 1593 his tractate *De memoria* at Douai with the sanction of that celebrated theological faculty. The most complete account of his system is given in two works by his pupil Martin Sommer, published at Venice in 1619. In 1618 John Willis (d. 1628?) published *Mnemonicis; sive ars reminiscendi* (Eng. version by Leonard Sowersby, 1661; extracts in Feinaigle's *New Art of Memory*, 3rd ed., 1813), containing a clear statement of the principles of topical or local mnemonics. Giordano Bruno, in connexion with his exposition of the *ars generalis* of Lull, included a *memoria technica* in his treatise *De umbris idearum*. Other writers of this period are the Florentine Publicius (1482); Johann Romberch (1533); Hieronimo Morafiot, *Ars memoriae* (1602); B. Porta, *Ars reminiscendi* (1602).

In 1648 Stanislaus Mink von Wenusheim or Winckelmann made known what he called the "most fertile secret" in mnemonics—namely, the use of consonants for figures, so as to express numbers by words (vowels being added as required); and the philosopher Leibnitz adopted an alphabet very similar to that of Winckelmann in connexion with his scheme for a form of writing common to all languages. Winckelmann's method, which in fact is adopted with slight changes by the majority of subsequent "original" systems, was modified and supplemented in regard to many details by Richard Grey (1694-1771), who published a *Memoria technica* in 1730. The

¹ Pliny, *H.N.* vii. 24. Cicero, *De or.* ii. 86, mentions this belief without committing himself to it.

principal part of Grey's method (which may be compared with the Jewish system by which letters also stand for numerals, and therefore words for dates) is briefly this: "To remember anything in history, chronology, geography, &c., a word is formed, the beginning whereof, being the first syllable or syllables of the thing sought, does, by frequent repetition, of course draw after it the latter part, which is so contrived as to give the answer. Thus, in history, the Deluge happened in the year before Christ two thousand three hundred forty-eight; this is signified by the word *Del-elok*, *Del* standing for Deluge and *elok* for 2348." To assist in retaining the mnemonic words in the memory they were formed into memorial lines, which, however, being composed of strange words in difficult hexameter scansion, are by no means easy to memorize. The vowel or consonant, which Grey connected with a particular figure, was chosen arbitrarily; but in 1806 Gregor von Feinaigle, a German monk from Salem near Constance, began in Paris to expound a system of mnemonics, one feature (based on Winkelmann's system) of which was to represent the numerical figures by letters chosen on account of some similarity to the figure to be represented or some accidental connexion with it. This alphabet was supplemented by a complicated system of localities and signs. Feinaigle, who apparently published nothing himself, came to England in 1811, and in the following year one of his pupils published *The New Art of Memory*, which, beside giving Feinaigle's system, contains valuable historical material about previous systems. A simplified form of Feinaigle's method was published by Aimé Paris (*Principes et applications diverses de la mnémotique*, 7th ed., Paris, 1834), and the use of symbolic pictures was revived in connexion with the latter by a Pole, Antoni Jazwiński, of whose system an account was published by the Polish general J. Bem, under the title *Exposé général de la méthode mnémotique polonoise, perfectionnée à Paris* (Paris, 1839). Various other modifications of the systems of Feinaigle and Aimé Paris were advocated by subsequent mnemonists, among them being the *Phrenotypics* of Major Beniowski, a Polish refugee, the *Phreno-Mnemolecty* (1845) of François Fauvel Gouraud the *Mnemolecty* of Karl Otto Reventlow (generally known as Karl Otto), a Dane, and the *Mnemolecty* of the American Pliny Miles.

The more complicated mnemonic systems have fallen almost into complete disuse; but methods founded chiefly on the so-called laws of association (see ASSOCIATION OF IDEAS) have been taught with some success in Germany by, among others, Hermann Kothe, author of *Lehrbuch der Mnemonik* (2nd ed., Hamburg, 1852), and *Katechismus der Gedächtniskunst* (6th ed. by Montag, Leipzig, 1887); and Hugo Weber-Rumpe, author of *Mnemonische Zählwörterbuch* (Breslau, 1885) and *Mnemonische Unterrichtsbriefe* (1887-1888); in England by Dr Edward Pick, whose *Memory and the Rational Means of Improving it* (5th ed., 1873) and *Lectures on Memory Culture* (1899) obtained a wide circulation. Passing over the work of William Day (*New Mnemonic Chart and Guide to the Art of Memory*, 1845), Rev. T. Brayshaw (*Metric Mnemonics*, a very rare work), Fairchild and W. Stokes, the next name of any importance is the Rev. J. H. Bacon, a pupil of Edward Pick. His book (*A Complete Guide to the Improvement of the Memory*, 3rd ed., rev. 1890) contains a good summary of the history of mnemonics and a very reasonable account of the principles; it gains in value by its comparative simplicity. More or less successful systems were issued by Lyon Williams (1866), T. Maclaren (1866), Thomas A. Sayer (1867), Rev. Alexander Mackay (1869), George Crowther (1870), F. Appleby (1880), John Sambrook, who made use of similarities in sounds (gun, 1; Jew, 2), the French scientist Abbé Moigno, J. H. Noble, and Allan Dalzell. Considerable interest was roused both in London and in America by the controversy which raged round the system of "Alphonse Loissette," who taught his "art of never forgetting" successively in London and Washington. It claimed to be original in system, but was attacked in England by F. Appleby and in America by George S. Fellows, and is generally regarded as both unoriginal and inferior on the whole to preceding systems (for the litigation in America see e.g. Part II. of Middleton's

Memory Systems, pp. 96 sqq.). An interesting work (*Memoranda mnemonica*) was published by James Copner in 1893, containing a system based partly on the use of letters for figures and words for dates, as well as a large number of rhymes for remembering facts in biblical, Roman, Greek and English history. He made use of Grey's system, but endeavoured as far as possible to invent, where necessary, words and terminations which in themselves had some special fitness in place of Grey's monstrosities. More complicated systems are the *Keesing Memory System* (Auckland, 1896), the Smith-Watson *System of Memory and Mental Training* (Washington), and the Pelman memory system.

BIBLIOGRAPHY.—A large number of the works referred to in the text contain historical material. Among histories of the subject, see C. F. von Arzin, *Systematische Anleitung zur Theorie und Praxis der Mnemonik* (Sulzburg, 1810); A. E. Middleton, *Memory Systems, Old and New* (spec. 3rd rev. ed., New York, 1888), with bibliography of works from 1325 to 1888 by G. S. Fellows and account of the Loissette litigation; F. W. Colegrove, *Memory* (1901), with bibliography, pp. 353-361. (J. M. M.)

MNESICLES, the architect of the great Propylaea of the Athenian Acropolis, set up by Pericles about 437 B.C.

MOA, apparently the Maori name of the extinct Ratite birds in New Zealand, comprising the group Dinornithes (cf. BIRD: Classification; and RATITAE). The earliest account of these birds is that of Polack (*New Zealand*, London, 1838), who speaks of the former existence of some struthious birds in the north island as proved by fossil bones which were shown to him. "The natives added that, in times long past, they received the tradition that very large birds had existed, but the scarcity of food, as well as the easy method of entrapping them, had caused their extermination." In the North Island the moas seem to have died out soon after the arrival of the Maoris, according to F. W. Hutton, some 700-500 years ago. In the South Island they seem to have lingered much longer, possibly, according to H. O. Forbes (*Nat. Sci. II.* 1893, pp. 374-380), "down even to the time that Captain Cook visited New Zealand." But these are only surmises, based upon the fact that in various dry caves limbs still surrounded by the mummified flesh and skin, feathers, and even eggs with the inner membrane, have been found. Great quantities of bones have been found in caves and in swamps, so that now nearly every part of the skeleton, of some kind or other, is known.

The most striking feature of the moas, besides the truly gigantic size of some species, is the almost complete absence of the wings. In fact, the whole skeletons of the wings and of the shoulder girdle seem to have been lost, excepting *Anomalopteryx dromocoides*, which, according to Hutton, had still some vestiges. Such a complete reduction of the whole anterior limb and girdle is unique among birds, but the cassowaries indicate the process. In conformity with these reductions the breastbone of the moas is devoid of any coracoidal facets; there is no trace of a keel, and the number of sternal ribs is reduced to three or even two pairs. The hind limbs are very strong; the massive femur has a large pneumatic foramen; the tibia has a bony bridge on the anterior surface of the lower portion, a character in which the moas agree only with *Apteryx* amongst the other Ratitae. The number of toes is four, unless the hallux is more or less reduced. The pelvis much resembles that of the kiwis.

The skull has been monographed by T. J. Parker ("On the Cranial Osteology; Classification and Phylogeny of the Dinornithidae," *Tr. Z. Soc.* (1893), xiii. 373-431, pls. 56-62); it resembles in its general configuration that of the emeus and cassowaries, while it differs from that of *Apteryx* most obviously by the short and stout bill.

The feathers have a large after-shaft which is of the size of the other half, likewise in agreement with the Australian Ratitae, while in the others, including the kiwis, the after-shaft is absent. Another important point, in which the moas agree with the other Ratitae and differ from the kiwis, are the branched, instead of simple, porous canals in the eggshell.

¹ "The Moas of New Zealand," *Tr. N. Zea. Inst.* (1892), xxiv. 93-172, pls. xv-xvii.

The affinities of the moas are undoubtedly with the Australian *Ratitae*, and, in spite of the differences mentioned above, with the kiwis. In this respect Max Fürbringer and T. J. Parker are in perfect agreement. The relationship with *Aepyornis* of Madagascar is still problematic. Whilst the moas seem to have been entirely herbivorous, feeding not unlikely upon the shoots of ferns, the kiwis have become highly specialized worm-eaters. In this respect cassowaries and emeus hold an intermediate position, their occasional zoophagous (especially piscivorous) inclination being well known. Unmolested by enemies (*Harpagornis*, a tremendous bird of prey, died out with the Pleistocene), living in an equable insular climate, with abundant vegetation, the moas flourished and seem to have reached their greatest development in specialization, numbers, and a bewildering variety of large and small kinds, within quite recent times. Unfortunately no fossil moas, older than the Pleiocene, are known. Parker recognizes five genera, with about twenty species, which he combines into three sub-families: Dinornithinae with *Dinornis*, Anomalopteryginae with *Pachyornis*, *Mesopteryx* and *Anomalopteryx*, comprising the comparatively least specialized forms; and Emeinae with the genus *Emeus*, not to be confounded with the vernacular emeu. The moas ranged in size from that of a turkey to truly colossal dimensions, the giant being *Dinornis maximus*, which, with a tibial length of 39 in., stood with its small head about 12 ft. above the ground.

(H. F. G.)

MOAB, the name of an ancient people of Palestine who inhabited a district E. of the Jordan and the Dead Sea, lying N. of Edom and S. of Ammon (*q.v.*) and the Israelite Transjordanic districts. There is little material for its earlier history outside the Old Testament, and the various references in the latter are often of disputed reference and date. The national traditions of Israel recognize a close relationship between Moab and Ammon, "sons" of Lot, and the "brothers" Esau (Edom) and Jacob (Israel), and Moab is represented as already a powerful people when Israel fled from Egypt (Exod. xv. 15). The detailed narratives, however, give conflicting views of the exodus and the conquest of Palestine. It was supposed that Moab, having expelled the aboriginal giants, was in turn displaced by the Amorite king Sihon, who forced Moab south of the Arnon (Wadi Mōjib, a natural boundary) and drove Ammon beyond the Jabbok. The Israelites at Kadesh, almost at the gate of the promised land, incurred the wrath of Yahweh, and, deterred by a defeat at Hormah from pursuing their journey northwards, were obliged to choose another route (Num. xiv. 40-45; contrast *xxi. 1-3*). (See *EXODUS, THE*.) Messengers to Edom were repulsed (Num. xx. 14-18), or Israel was met by Edom with force (*v. 19 seq.*); consequently a great détour was made from Kadesh round by the south of Edom (Num. xiv. 25, *xxi. 4*; Judges *xi. 18*). At length the people safely reached Pisgah in Moab (Num. *xxi. 16-20*; cf. Deut. *iii. 27, xxiv. 1*), or, according to another view, passed outside Moab until they reached the border of Sihon's kingdom (Num. *xxi. 13, 26*; Judges *xi. 17 seq.*). There are other details in Deut. *ii.*, and the late list in Num. *xxxiii.* even seems to assume that the journey was made from Kadesh across the northern end of Edom. Apparently no fixed or distinct tradition existed regarding the journeys, and it is extremely probable that some of the most characteristic features belong to much later periods than the latter half of the second millennium B.C., the age to which they are ascribed (e.g. the poem on the fall of Heshbon, Num. *xxi. 27-30*).

The account of Balaam (*q.v.*), the son of Beor, the soothsayer, of the children of Ammon (*xxii. 5*, some MSS.), or of Aram or of Edom (see Cheyne, *Ency. Bib.*, col. 3685 and below), is noteworthy for the prophecies of Israel's future supremacy; but he is passed over in the historical sketch, Deut. *ii. 2*, and even the allusion, *ibid. xxxii. 4 seq.*, belongs to a context which on independent grounds appears to be a later insertion. Israel's idolatry in Moab is supplemented by a later story of the vengeance upon Midian (*xv. 6-18, xxxi.*). In Joshua *xiii. 21* the latter is associated with both Sihon and Balaam, and in some obscure manner Midian and Moab are connected in Num. *xii. 4-7* (cf. *xv. 18, xxxi. 8*). An Edomite list of kings includes Bela (cf. Bil'am, *i.e.* Balaam), son of Beor, and states that a Hadad, son of Bedad, smote Midian in the field of Moab (Gen.

xxxvi. 32, 35); these events, assigned to an early age, have been connected with the appearance of Moabite power west of the Jordan in the days of the "judge" Ehud (*q.v.*). However, all that is recorded in Num. *xxii. sqq.*, together with various legal and other matter, now serves the accounts of the Israelite occupation of east Jordan (Num. *xxi. 33-35, xxxii. 39-42*). For full details see G. B. Gray, "Numbers" (*Internal. Critical Comment.*).

Although Moab and Ammon were "brothers," their history was usually associated with that of Judah and Israel respectively, and naturally depended to a considerable extent upon these two and their mutual relations. Jephthah (*q.v.*), one of the Israelite "judges," delivered Gilead from Ammon, who resumed the attack under its king Nahash, only to be repulsed by Saul (*q.v.*). Ehud (*q.v.*) of Benjamin or Ephraim freed Israel from the Moabite oppression. To the first great kings, Saul and David, are ascribed conquests over Moab, Ammon and Edom. The Judean David, for his part, sought to cultivate friendly relations with Ammon, and tradition connects him closely with Moab. His son Solomon contracted marriages with women of both states (1 Kings *xi. 5, 7*), thus introducing into Jerusalem cults which were not put down until almost at the close of the monarchy (2 Kings *xxiii. 13*). In the 9th century B.C. the two states appear in more historical surroundings, and the discovery of a lengthy Moabite inscription has thrown valuable light upon contemporary conditions.

This inscription, now in the Louvre, was found at Dhifān, the biblical Dibōn, in 1868 by the Rev. F. Klein, a representative of the Church Missionary Society stationed at Jerusalem. It contains a record of the successes gained by the Moabite king Mesha against Israel.¹ Omri (*q.v.*) had previously seized a number of Moabite cities north of the Arnon, and for forty years the Moabite national god Chemosh was angry with his land. At length he roused Mesha; and Moab, which had evidently retreated southwards towards Edom, now began to take reprisals. "The men of Gad had dwelt in the land of 'Atrath from of old; and the king of Israel built 'Atrath for himself." Mesha took the city, slew its people in honour of Chemosh, and dragged before the god the altar-hearth (or the priests?) of D-v-d-h (apparently a divine name, but curiously similar to David). Next Chemosh roused Mesha against the city of Nebo. It fell with its thousands, for the king had "devoted" it to the deity 'Ashtar-Chemosh. Yahweh had been worshipped there, and his . . . (? vessels, or perhaps the same doubtful word as above) were dragged before the victorious Chemosh. With the help of these and other victories (at Jahaz, Aroer, &c.), Moab recovered its territory, fortified its cities, supplied them with cisterns, and Mesha built a great sanctuary to his god. The inscription enumerates many places known elsewhere (Isa. *xv.*; Jer. *xlvi.*), but although it mentions the "meu of Gad," makes no allusion to the Israelite tribe Reuben, whose seat lay in the district (Num. *xxxii.*; Josh. *xiii. 15-23*; see REUBEN). The revolt will have followed Ahab's death (see 2 Kings *i. 1*) and apparently led to the unsuccessful attempt by Jehoram to recover the lost ground (*ibid. iii.*).

The story of Jehoram in 2 Kings *iii.* now gives prominence to Elisha, his wonders, his hostility to the ruling dynasty and his regard for the aged Jehoshaphat of Judah. Following other synchronisms, the Septuagint (Lucian's recension) names Abaziah of Judah; from 2 Kings *i. 17*, the reigning king could only have been Jehoram's namesake. The king of Edom appears as an ally of Israel and Judah (contrast 1 Kings *xxii. 47*; 2 Kings *viii. 20*), and hostile to Moab (comp. above, and the obscure allusion in Amos *ii. 1-2*). But the king of Moab's attempt to break through unto him suggests that in the original story (there are several signs of revision) Moab and Edom were in alliance. In this case the object of Jehoram's march round the south of the Dead Sea was to drive a wedge between them, and the result hints at an Israelite disaster. Singularly enough, Jehoram of Judah suffered some defeat from Edom at Zair, an unknown name for which Ewald suggested (the Moabite) Zoar (2 Kings *viii. 21*; see JEHORAM).

Moab thus retained its independence, even harrying Israel with marauding bands (2 Kings *xiii. 20*), while Ammon was

¹ See edition by M. Lidzbarski, *Altsemitische Texte*, Bd. I. (Giessen, 1907); also G. A. Cooke, *North Semitic Inscriptions*, pp. 1-14, and the articles on "Moab" in Hastings's *Critical Bible* (by W. H. Bennett), and "Mesha" in *Ency. Bib.* (by S. R. Driver).

perpetrating cruelties upon Gilead (Am. i. 13 sqq.). But under Jeroboam II. (q.v.) Israelite territory was extended to the Wadi of the 'Arabah or wilderness (probably south end of the Dead Sea), and again Moab suffered. If Isa. xv. seq. is to be referred to this age, its people fled southwards and appealed for protection to the overlord of Edom (see UZZAIAT). During the Assyrian supremacy, its king Salamannu (probably not the Shalman of Hos. x. 14) paid tribute to Tiglath-Pileser IV., but joined the short-lived revolt with Judah and Philistia in 711. When Sennacherib besieged Jerusalem in 701, Kamus(Chemosh)-nadab also submitted, and subsequently both Esarhaddon and Assur-bani-pal made the Moabite king Mušuri ("the Egyptian," but cf. MIZRAIM) among their tributaries. In fact, during the reign of Assur-bani-pal Moab played the vassal's part in helping to repulse the invasion of the Nabayati and nomads of Kedar, a movement which made itself felt from Edom nearly as far as Damascus. It had its root in the revolt of Samas-sum-yukin (Shamash-shun-ukin) of Babylonia, and coming at a time immediately preceding the disintegration of the Assyrian Empire, may have had most important consequences for Judah and the east of the Jordan.¹ (See PALESTINE: History.)

Moab shares with Ammon and Edom in the general obscurity which overhangs later events. If it made inroads upon Judah (2 Kings xxiv. 2), it joined the coalition against Babylonia (Jer. xvii. 3); if it is condemned for its untimely joy at the fall of Jerusalem (Isa. xxv. 9 seq.; Jer. xlviij. 1; Ezek. xiv. 8-11; Zeph. ii. 8-10), it had offered a harbour to fugitive Jews (Jer. xl. 11). The dates of the most significant passages are unfortunately uncertain. If Sanballat the Horonite was really a native of the Moabite Horonaim, he finds an appropriate place by the side of Tobiah the Ammonite and Gashmu the Arabian among the strenuous opponents of Nehemiah. Still later we find Moab part of the province of Arabia in the hands of fresh tribes from the Arabian desert (Jos. Ant. xiii. 13, 5); and, with the loss of its former independent power, the name survives merely as a type (Dan. xi. 41). (See JEWS; NABATEANS.)

A populous land commanding the trade routes from Arabia to Damascus, rich in agricultural and pastoral wealth, Moab, as Mesha's inscription proves, had already reached a high state of civilization by the 9th century B.C. Its language differed only dialectically from Hebrew; its ideas and religion were very closely akin to the Israelite, and it may be assumed that they shared in common many features of culture.² The relation of Chemosh, the national god, to his "children" (Num. xii. 29) was that of Yahweh to Israel (see especially Judges xi. 24). He had his priests (Jer. xlviii. 7), and Mesha, perhaps himself a priest-king, receives the oracles direct or through the medium of his prophets. The practice of devoting, banning or annihilating city or community was both Moabite and Israelite (cf. above, also Deut. ii. 34, iii. 6, xx. 10-20; 2 Chron. xxv. 12, &c.), and human sacrifice, offered as an exceptional gift to Chemosh in 2 Kings iii. 27, in Israel to Molech (q.v.), was a rite once less rare. Apart from the religious cult suggested in the name Mount Nebo, there were local cults of the Baal of Peor and the Baal of Meon, and Mesha's allusion to 'Ashtar-Chemosh, a compound deity, has been taken to point to a corresponding consort whose existence might naturally be expected upon other grounds (see ASTARTE). The fertility of Moab, the wealth of wine and corn, the temperate climate and the enervating heat supply conditions which directed the form of cult. Nature-worship, as in Israel, lay at the foundation, and the impure rites of Shittim and Baal-Peor (Num. xxxi. 16; Ps. cv. 28) would not materially differ from practices which Israelite prophets were called upon to condemn. Much valuable evidence is to be obtained also from the survival of ancient forms of cult in Moab

and east of the Jordan (e.g. sacrifices on the house roofs) and from a survey of epigraphical and other data from the Greek, Roman, and later periods, allowance being made for contamination. The whole question deserves careful investigation in the light of comparative religion.³

The relationship felt between Israel and the external states (Moab, Edom, Ammon) is entirely justified. It extends intermittently throughout the history, and certain complicated features in the traditions of the southern tribes point to affinities with Moab which find a parallel in the traditions of David (see RUTH) and in the allusions to intercourse between Moab and Benjamin (1 Chron. viij. 8) or Judah (ibid. iv. 21 seq.). But the obscure historical background of the references makes it uncertain whether the exclusiveness of orthodox Judaism (Neh. xiii. 1-3; cf. Deut. xxiii. 3-6; Ezra ix. 1, 12) was imposed upon an earlier catholicity, or represented only one aspect of religious spirit, or was succeeded by a more tolerant attitude. Evidence for the last-mentioned has been found in the difficult narrative in Josh. xxii. But Israel remained a great power in religious history while Moab disappeared. It is true that Moab was continuously hard pressed by desert hordes; the exposed condition of the land is emphasized by the chains of ruined forts and castles which even the Romans were compelled to construct. The explanation of the comparative insignificance of Moab, however, is not to be found in purely topographical considerations. Nor can it be sought in political history, since Israel and Judah suffered as much from external movements as Moab itself. The explanation is to be found within Israel itself, in factors which succeeded in re-shaping existing material and in imprinting upon it a durable stamp, and these factors, as biblical tradition recognizes, are to be found in the work of the prophets.

See the articles on Moab in Hastings's *Dict. Bible* (W. H. Bennett), *Ency. Bib.* (G. A. Smith and Wellhausen), and Hauck's *Realencyclopädie* (F. Buhl) with their references; also the popular description by W. Libbey and F. E. Hoskins, *Jordan Valley and Petra* (1905), and the very elaborate and scientific works by R. E. Brinnow and A. von Domaszewski, *Die Provincia Arabia* (1904-1905), and A. Musil, *Arabia Petraea* (1907-1908). Mention should be made of the mosaic map of Palestine found at Medaba, dating perhaps from the 5th century A.D.; for this, see A. Jacoby, *Das geograph. Mosaik von M.* (1905), and P. Palmer and Guthe (1906). For language and epigraphy see NABATEANS, SEMITIC LANGUAGES; for topography, &c., PALESTINE; and for the later history, JEWS. (S. A. C.)

MO'ALLAKĀT (MO'ALLAQĀT or MU'ALLAQĀT). *Al-Mo'allaqāt* is the title of a group of seven longish Arabic poems, which have come down to us from the time before Islam. The name signifies "the suspended" (pl.), the traditional explanation being that these poems were hung up by the Arabs on or in the Ka'ba at Mecca. The oldest passage known to the present writer where this is stated occurs in the *Iqd* of the Spanish Arab, Ibn 'Abd-Rabbihi (d. A.D. 860-940), *Būlāq* ed. of 1293 A.H. vol. iii. p. 116 seq. We read there: "The Arabs had such an interest in poetry, and valued it so highly, that they took seven long pieces selected from the ancient poetry, wrote them in gold on pieces of Coptic linen folded up, and hung them up (*allaqat*) on the curtains which covered the Ka'ba. Hence we speak of 'the golden poem of Amra'al Qais,' 'the golden poem of Zuhair.' The number of the golden poems is seven; they are also called 'the suspended' (*al-Mo'allaqāt*)." Similar statements are found in later Arabic works. But against this we have the testimony of a contemporary of Ibn 'Abd-Rabbihi, the grammarian Nāḥḥās (d. A.D. 949), who says in his commentary on the Mo'allaqāt: "As for the assertion that they were hung up in [*sic*] the Ka'ba, it is not known to any of those who have handed down ancient poems."⁴ This cautious scholar is unquestionably right in rejecting a story so utterly unauthenticated. The customs of the Arabs before Mahomet

¹ See G. Smith, *Ashurbanipal* (p. 288, cyl. A. viii. 51, B. viii. 37); and L. B. Paton, *Syria and Palestine*, p. 269 seq.; R. F. Harper, *Ass. and Bab. Lit.*, pp. 118 seq.; H. Winckler, *Kleinchr. u. das alte Test.*, 3rd ed., p. 151.

² Excavation alone can supplement the scanty information which the present evidence furnishes. For a representation of a Moabite warrior (god?), see G. Perrot and C. Chipiez, *Art in Phœnicia*, ii. 45 seq.

³ See W. R. Smith, *Religion of the Semites* (2nd ed.), which may be supplemented by the scattered gleanings in Clermont-Ganneau's *Recueil d'archéologie orientale*, and more especially by P. Antonin Jaussen's valuable monograph, *Costumes des Arabes au pays de Moab* (Paris, 1908). (See also HERREW RELIGION.)

⁴ Ernst Frenkel, *An-Nāḥḥās' Commentar zur Mu'allaqa des Imru'ul-Qais* (Halle, 1876), p. viii.

are pretty accurately known to us; we have also a mass of information about the affairs of Mecca at the time when the Prophet arose; but no trace of this or anything like it is found in really good and ancient authorities. We hear, indeed, of a Meccan hanging up a spoil of battle on the Ka'ba (Ibn Hishām, ed. Wüstenfeld, p. 431). Less credible is the story of an important document being deposited in that sanctuary (ibid. p. 230), for this looks like an instance of later usages being transferred to pre-Islamic times. But at all events this is quite a different thing from the hanging up of poetical manuscripts. To account for the disappearance of the Mo'allaqāt from the Ka'ba we are told, in a passage of late origin (De Sacy, *Chrestom.* ii. 480), that they were taken down at the capture of Mecca by the Prophet. But in that case we should expect some hint of the occurrence in the circumstantial biographies of the Prophet, and in the works on the history of Mecca; and we find no such thing. That a series of long poems was written at all at that remote period is improbable in the extreme. Up to a time when the art of writing had become far more general than it was before the spread of Islam, poems were never—or very rarely—written, with the exception, perhaps, of epistles in poetic form. The diffusion of poetry was exclusively committed to oral tradition. Moreover, it is quite inconceivable that there should have been either a guild or a private individual of such acknowledged taste, or of such influence, as to bring about a consensus of opinion in favour of certain poems. Think of the mortal offence which the canonization of one poet must have given to his rivals and their tribes. It was quite another thing for an individual to give his own private estimate of the respective merits of two poets who had appealed to him as umpire, or for a number of poets to appear at large gatherings, such as the fair of 'Oqāz (Okad) as candidates for the place of honour in the estimation of the throng which listened to their recitations. No better is the modifications of the legend, which we find, at a much later period, in the *Muqaddima* of Ibn Khaldūn (A.D. 1332-1406), who tells us that the poets themselves hung up their poems on the Ka'ba (ed. Paris iii. 357). In short, this legend, so often retailed by Arabs, and still more frequently by Europeans, must be entirely rejected.¹ The story is a pure fabrication based on the name "suspended." The word was taken in its literal sense; and as these poems were prized by many above all others in after times, the same opinion was attributed to "the [ancient] Arabs," who were supposed to have given effect to their verdict in the way already described. A somewhat simpler version, also given by Nahhās in the passage already cited, is as follows: "Most of the Arabs were accustomed to meet at 'Oqāz and recite verses; then, if the king was pleased with any poem, he said, 'Hang it up, and preserve it among my treasures.'" But, not to mention other difficulties, there was no king of all the Arabs; and it is hardly probable that any Arabian king attended the fair at 'Oqāz. The story that the poems were written in gold has evidently originated in the name "the golden poems" (literally "the gilded"), a figurative expression for excellence. We may interpret the designation "suspended" on the same principle. It seems to mean those (poems) which have been raised, on account of their value, to a specially honourable position. Another derivative of the same root is 'ilq, "precious thing." A clearer significance attaches to another name sometimes used for these poems—*assumūt*, "the strings of pearls." The comparison of artificially elaborated poems to these strings is extremely apt. Hence it became so popular that, even in ordinary prose, to speak in rhythmical form is called simply *naẓm*—"to string pearls."

The selection of these seven poems can scarcely be alien

¹ Doubts had already been expressed by various scholars, when Henzenberg—rigid conservative as he was in theology—openly challenged it, and Sprenger (*Das Leben des Mohammed*, i. 14, Berlin, 1861) declared it a fable. Since then it has been controverted at length in Nöldeke's *Beiträge zur Kenntnis der Poesie der alten Araber* (Hanover, 1864), p. xvii, seq. Ahlwardt concurs in this conclusion; see his *Bemerkungen über die Aechtheit der alten arabischen Gedichte* (1872), pp. 25, 80q.

the work of the ancient Arabs at all. It is much more likely that we owe it to some connoisseur of a later date. Now Nahhās says expressly in the same passage: "The true view of the matter is this: when Ḥammād ar-Rāwīya (Ḥammād the Rhapsodist) saw how little men cared for poetry, he collected these seven pieces, urged people to study them, and said to them: 'These are the [poems] of renown.'" And this agrees with all our other information. Ḥammād (who lived in the first three quarters of the 8th century A.D.) was perhaps of all men the one who knew most Arabic poetry by heart. The recitation of poems was his profession. To such a rhapsodist the task of selection is in every way appropriate; and it may be assumed that he is responsible also for the somewhat fantastic title of "the suspended."

There is another fact which seems to speak in favour of Ḥammād as the compiler of this work. He was a Persian by descent, but a client of the Arab tribe, Bakr ibn Wā'il. For this reason, we may suppose, he not only received into the collection a poem of the famous poet Ṭarafa, of the tribe of Bakr, but also that of another Bakrite, Ḥārith, who, though not accounted a bard of the highest rank, had been a prominent chieftain; while his poem could serve as a counterpoise to another also received—the celebrated verses of Ḥārith's contemporary 'Amr, chief of the Taghlib, the rival brethren of the Bakr. 'Amr praises the Taghlib in glowing terms: Ḥārith, in a similar vein, extolls the Bakr—ancestors of Ḥammād's patrons. The collection of Ḥammād appears to have consisted of the same seven poems which are found in our modern editions, composed respectively by Amra'al-Qais, Ṭarafa, Zuhair, Labid, 'Antara ibn Shaddād, 'Amr ibn Kulthūm, and Ḥārith ibn Ḥilliza. These are enumerated both by Ibn 'Abd-Rabbih, and, on the authority of the older philologists, by Nahhās; and all subsequent commentators seem to follow them. We have, however, evidence of the existence, at a very early period, of a slightly different arrangement. Certainly we cannot now say, on the testimony of the *Jamharat ash'ar al-'Arab*, that two of the most competent ancient authorities on Arabic poetry, Mofaḍḍal (d. c. 790) and Abū 'Ubayda (d. A.D. 824, at a great age), had already assigned to the "Seven" (viz. "the seven Mo'allaqāt") a poem each of Nābigha and A'shā in place of those of 'Antara and Ḥārith. For meanwhile it has been discovered that the compiler of the above-mentioned work—who, in order to deceive the reader, issued it under a false name—is absolutely untrustworthy. But the learned Ibn Qutaiba (9th century A.D.), in his book *Of Poetry and Poets*, mentions as belonging to the "Seven" not only the poem of 'Amr, which has invariably been reckoned among the Mo'allaqāt (ed. de Goeje, p. 120), but also a poem of 'Abid ibn Abrahā (ibid. 144). In place of which poem he read this we do not know; and we are equally ignorant as to whether he counted other pieces than those indicated above among the seven.

Now Nābigha and A'shā enjoyed greater celebrity than any of the poets represented in the Mo'allaqāt, with the exception of Amra'al-Qais, and it is therefore not surprising that scholars, of a somewhat later date, appended a poem by each of these to the Mo'allaqāt, without intending by this to make them an integral part of that work. This is clear, for instance, from the introductory words of Tibriẓī (d. A.D. 1109) to his commentary on the Mo'allaqāt. Appended to this he gives a commentary to a poem of Nābigha, to one of A'shā, and moreover one to that poem of 'Abid which, as we have just seen, Ibn Qutaiba had counted among the seven. It is a pure misunderstanding when Ibn Khaldūn (*loc. cit.*) speaks of nine Mo'allaqāt; and we ought hardly to lay any stress on the fact that he mentions not only Nābigha and A'shā, but also 'Alqama, as Mo'allaqa—poets. He was probably led to this by a delusive recollection of the Collection of the "Six Poets," in which were included these three, together with the three Mo'allaqa-poets, Amra'al-Qais, Zuhair and Ṭarafa.

The lives of these poets were spread over a period of more than a hundred years. The earliest of the seven was AMRA'AL-QAIS (q.v.), regarded by many as the most illustrious of Arabian

poets. His exact date cannot be determined; but probably the best part of his career fell within the midst of the 6th century. He was a scion of the royal house of the tribe Kinda, which lost its power at the death of King Ḥārith ibn 'Amr in the year 520.¹ The poet's royal father, Ḥojr, by some accounts a son of this Ḥārith, was killed by a Bedouin tribe, the Banū Asad. The son led an adventurous life as a refugee, now with one tribe, now with another, and appears to have died young. The anecdotes related of him—which, however, are very untrustworthy in detail—as well as his poems, imply that the glorious memory of his house and the hatred it inspired were still comparatively fresh, and therefore recent. A contemporary of Amra'al-Qais was 'ABD IBN 'ABRA, one poem of whose, as we have seen, is by some authorities reckoned among the collection. He belonged to the Banū Asad, and is fond of vaunting the heroic deed of his tribe—the murder of Ḥojr—in opposition to the victim's son, the great poet.

The Mo'allaqa of 'AMR hurls defiance against the king of Ḥira, 'Amr son of Mundhir, who reigned from the summer of 554 till 568 or 569, and was afterwards slain by our poet.² This prince is also addressed by Ḥārith in his Mo'allaqa. Of TARĀFA, who is said to have attained no great age, a few satirical verses have been preserved, directed against this same king. This agrees with the fact that a grandson of the Qais ibn Khālid, mentioned as a rich and influential man in Tarāfa's Mo'allaqa (v. 80 or 81), figured at the time of the battle of Dhū-Qār, in which the tribe Bakr routed a Persian army. This battle falls between A.D. 604 and 610.³

The Mo'allaqa of 'ANTARA and that of ZUHĀIR contain allusions to the feuds of the kindred tribes 'Abs and Dhobyān. Famous as these contests were, their time cannot accurately be ascertained. But the date of the two poems can be approximately determined from other data. Ka'b, son of Zuhair, composed first a satire, and then, in the year 630, a eulogy on the Prophet; another son, Bujair, had begun, somewhat sooner, to celebrate Mahomet. 'Antara killed the grandfather of Aḥnaf ibn Qais, who died at an advanced age in A.D. 686 or 687; he outlived 'Abdallah ibn Simma, whose brother Duraid was a very old man when he fell in battle against the Prophet (early in A.D. 630); and he had communications with Ward, whose son, the poet 'Orwa, may perhaps have survived the flight of Mahomet to Medina. From all these indications we may place the productive period of both poets in the end of the 6th century. The historical background of 'Antara's Mo'allaqa lies somewhat earlier than that of Zuhair's.

To the same period appears to belong the poem of 'ALQAMA, which, as we have seen, Ibn Khaldūn reckons amongst the Mo'allaqāt. This too is certainly the date of NĀBĪHA, who was one of the most distinguished of Arabic poets. For in the poem often reckoned as a Mo'allaqa, as in many others, he addresses himself to No'mān, king of Ḥira, who reigned in the two last decades of the 6th century. The same king is mentioned as a contemporary in one of 'Alqama's poems.

The poem of A'SHA, sometimes added to the Mo'allaqāt, contains an allusion to the battle of Dhū Qār (under the name "Battle of Hinw," v. 62). This poet, not less famous than Nābigha, lived to compose a poem in honour of Mahomet, and died not long before A.D. 630.

LĀBĪ is the only one of these poets who embraced Islam. His Mo'allaqa, however, like almost all his other poetical works, belongs to the Pagan period. He is said to have lived till 661, or even later; certainly it is true of him, what is asserted with less likelihood of several others of these poets, that he lived to a ripe old age.

The seven Mo'allaqāt, and also the poems appended to them, represent almost every type of ancient Arabian poetry in its excellences and its weaknesses. In order rightly to appreciate these, we must translate ourselves into the world of the Bedouin,

and seek to realize the peculiar conditions of his life, together with the views and thoughts resulting from those conditions. In the Mo'allaqa of Tarāfa we are repelled by the long, anatomically exact description of his camel; but such a description had an extraordinary charm of its own for the Bedouins, every man of whom was a perfect connoisseur on this subject down to the minutest points; and the remaining parts of the poem, together with the other extant fragments of his songs, show that Tarāfa had a real poetic gift. In the Mo'allaqāt of 'Amr and Ḥārith, for the preservation of which we are especially grateful to the compiler, we can read the haughty spirit of the powerful chieftains, boastfully celebrating the splendours of their tribe. These two poems have also a certain historical importance. The song of Zuhair contains the practical wisdom of a sober man of the world. The other poems are fairly typical examples of the customary *qaṣida*, the long poem of ancient Arabia, and bring before us the various phases of Bedouin life. But even here we have differences. In the Mo'allaqa of 'Antara, whose heroic temperament had overcome the scorn with which the son of a black slave-mother was regarded by the Bedouins, there predominates a warlike spirit, which plays practically no part in the song of Labid.

It is a phenomenon which deserves the fullest recognition, that the needy inhabitants of a barren country should thus have produced an artistic poetry distinguished by so high a degree of uniformity. Even the extraordinary strict metrical system, observed by poets who had no inkling of theory and no knowledge of an alphabet, excites surprise. In the most ancient poems the metrical form is as scrupulously regarded as in later compositions. The only poem which shows unusual metrical freedom is the above-mentioned song of 'Abid. It is, however, remarkable that 'Abid's contemporary Amra'al-Qais, in a poem which in other respects also exhibits certain coincidences with that of 'Abid (No. 55, ed. Ahlwardt), presents himself considerable licence in the use of the very same metre—one which, moreover, is extremely rare in the ancient period. Presumably, the violent deviations from the *schemata* in 'Abid are due simply to incorrect transmission by compilers who failed to grasp the metre. The other poems ascribed to 'Abid, together with all the rest attributed to Amra'al-Qais, are constructed in precise accord with the metrical canons. It is necessary always to bear in mind that these ancient poems, which for a century or more were preserved by oral tradition alone, have reached us in a much mutilated condition. Fortunately, there was a class of men who made it their special business to learn by rote the works either of a single poet or of several. The poets themselves used the services of these rhapsodists (*rāwī*). The last representative of this class is Ḥammād, to whom is attributed the collection of the Mo'allaqāt; but he, at the same time, marks the transition of the rhapsodist to the critic and scholar. The most favourable opinion of these rhapsodists would require us to make allowance for occasional mistakes: expressions would be transposed, the order of verses disarranged, passages omitted, and probably portions of different poems pieced together. It is clear, however, that Ḥammād dealt in the most arbitrary fashion with the enormous quantity of poetry which he professed to know thoroughly. The seven Mo'allaqāt are indeed free from the suspicion of forgery, but even in them the text is frequently altered and many verses are transposed. The loose structure of Arabic poems was extremely favourable to such alterations. Some of the Mo'allaqāt have several preambles: so, especially, that of 'Amr, the first eight verses of which belong not to the poem, but to another poet. Elsewhere, also, we find spurious verses in the Mo'allaqāt. Some of these poems, which have been handed down to us in other exemplars besides the collection itself, exhibit great divergences both in the order and number of the verses and in textual details. This is particularly the case with the oldest Mo'allaqa—that of Amra'al-Qais—the critical treatment of which is a problem of such extreme difficulty that only an approximate solution can ever be reached. The variations of the text, outside the Mo'allaqāt collection, have

¹ See *Tabari's Geschichte der Perser und Araber . . . übersetzt von Th. Nöldeke* (Leiden, 1879), p. 171.

² See *Nöldeke's Tabari*, pp. 170, 172.

³ *Ibid.* p. 311.

here and there exercised an influence on the text of that collection. It would be well if our manuscripts at least gave the Mo'allaqāt in the exact form of Ḥammād's days. The best text—in fact, we may say, a really good text—is that of the latest Mo'allaqa, the song of Labid.

The Mo'allaqāt exist in many manuscripts, some with old commentaries, of which a few are valuable. They have also been several times printed. Especial mention is due to the edition of Charles (afterwards Sir Charles) Lyall with the commentary of *Tibrizī* (Calcutta, 1894). Attempts to translate these poems, verse for verse, in poetical form, could scarcely have a happy result. The strangeness, both of the expression and of the subjects, only admits of a paraphrastic version for large portions, unless the sense is to be entirely obliterated. An attempt at such a translation, in conjunction with a commentary based on the principles of modern science, has been made by the present author: "Fünf Mo'allaqāt übersetzt und erklärt," in the *Sitzungsberichte der kais. Akad. d. Wiss. in Wien. Philos.-hist. Classe*, Bde. cxi.-cxiv. A supplement to this is formed by an article, by Dr Bernh. Geiger, on the Mo'allaqa of Tarafa, in the *Wiener Zeitschrift für die Kunde des Morgenlands*, xix. 323 sqq. See further the separate articles on the seven poets.

(TH. N.)

MOAT, a ditch filled with water surrounding a castle, town or other fortified place for purposes of defence. The word is taken from the O. Fr. *mote*, or *motte*, a mound or embankment of earth used as a means of defence; the transition in meaning from the heap of earth to the trench left by excavating the earth is parallel with the similar interchange of meaning in dike and ditch (see DIKE). In mod. Fr. *motte* means a lump or clod of earth. The word is probably of Teutonic origin, and may be connected with Eng. "mud." (See FORTIFICATION AND SIEGECRAFT.)

MOB. (1) A disorderly crowd, a rabble, also a contemptuous name for the common people, the lower orders, the Greek *ὄχλος*, (whence "ochlocracy," mob-rule). The word is a shortened form of Lat. *mobile* (sc. *vulgus*), the movable or mutable emotional, easily stirred crowd. "Mobile" in the sense of rabble was used in the 17th century, and was still used after the shortened form, for some time considered a vulgarism, had become common. Thus Addison (*Spectator*, No. 135) writes, "It is perhaps this humour of speaking no more than we needs must which has so miserably curtailed some of our words. . . . I dare not answer that 'mob' . . . 'incog,' and the like will not in time be looked at as part of our tongue." Roger North's *Examen*, vii., 574 (1740), dates the beginning of the use of the shortened form "mob." "I may note that the rabble first changed their title and were called the 'mob' in the assemblies of this club. It was their beast of burden, and called first *mobile vulgus*, but fell naturally into the contraction of one syllable, and ever since is become proper English." The club alluded to is the Green Ribbon Club (q.v.), and the date would be about 1680. (2) A kind of head-dress for women, usually called a "mob cap," worn during the 18th and early part of the 19th centuries. It was a large cap covering all the hair, with a bag-shaped crown, a broad band and frilled edge. It seems to have been originally an article of wear for the mornings. It is probably connected with words such as "mop," "mab," meaning untidy, *négligé*.

MOBERLY, GEORGE (1803-1885), English divine, was born on the 10th of October 1803, and educated at Winchester and Balliol. After a distinguished academic career he became head master of Winchester in 1835. This post he resigned in 1866, and retired to Brightstone Rectory, Isle of Wight. Mr. Gladstone, however, in 1866 called him to be bishop of Salisbury, in which see he kept up the traditions of his predecessors, Bishops Hamilton and Denison, his chief addition being the summoning of a diocesan synod. Though Moberly left Oxford at the beginning of the Oxford movement, he fell under its influence: the more so that at Winchester he formed a most intimate friendship with Keble, spending several weeks every year at Otterbourne, the next parish to Hursley. Moberly, however, retained his independence of thought, and in 1872 he astonished his High Church friends by joining in the movement for the disuse of the damnatory clauses in the Athanasian Creed. His chief contribution to theology is his Bampton Lectures of 1868, on

The Administration of the Holy Spirit in the Body of Christ. He died on the 6th of July 1885.

MOBERLY, ROBERT CAMPBELL (1845-1903), English theologian, was born on the 26th of July 1845. He was the son of George Moberly, bishop of Salisbury, and faithfully maintained the traditions of his father's teaching. Educated at Winchester and New College, Oxford, he was appointed senior student of Christ Church in 1867 and tutor in 1869. In 1876 he went out with Bishop Copleston to Ceylon for six months. After his return he became the first head of St Stephen's House, Oxford (1876-1878), and then, after presiding for two years over the Theological College at Salisbury, where he acted as his father's chaplain, he accepted the college living of Great Budworth in Cheshire in 1880, and the same year married Alice, the daughter of his father's predecessor, Walter Kerr Hamilton. In 1892 Lord Salisbury made him Regius Professor of Pastoral Theology of Oxford; and after a long period of delicate health he died at Christ Church on the 8th of June 1903. His chief writings were: An essay in *Lux Mundi* on "The Incarnation as the Basis of Dogma" (1880); a paper, *Belief in a Personal God* (1891); *Reason and Religion* (1896), a protest against the limitation of the reason to the understanding; *Ministerial Priesthood* (1897); and *Atonement and Personality* (1901). In this last work, by which he is chiefly known, he aimed at presenting an explanation and a vindication of the doctrine of the Atonement by the help of the conception of personality. Rejecting the retributive view of punishment, he describes the sufferings of Christ as those of the perfect "Penitent," and finds their expiatory value to lie in the Person of the Sufferer, the God-Man.

MOBERLY, a city of Randolph county, Missouri, U.S.A., in the north central part of the state, about 130 m. E. by N. of Kansas City. Pop. (1890), 8215; (1900), 8012, (923 negroes); (1910), 10,923. It is served by the Missouri, Kansas & Texas and the Wabash railways, and is a division headquarters of the latter. The city is regularly laid out on a level prairie site. There are two public parks, a Carnegie library, a commercial college, a Y.M.C.A. building, and a hospital maintained by the Wabash Employees Hospital Association. The most important industrial establishments are the large machine shops (established here in 1872) of the Wabash railway. Moberly was platted in 1866, was incorporated as a town and became the county-seat in 1868, and in 1873 secured a special city charter, which it surrendered in 1889 for city status under the general statute.

MOBILE, a city and the county-seat of Mobile county, Alabama, U.S.A., in the S.W. part of the state, at the mouth of Mobile River, and the head of Mobile Bay. Pop. (1890), 31,076; (1900), 38,469, of whom 17,945 were negroes and 2111 foreign-born (562 German, 492 Irish, 202 English); (1910 census), 51,521. It is served by the Southern, the Louisville & Nashville, the Mobile & Ohio, the Mobile, Jackson & Kansas City, and the Tombigbee Valley railways; by steamboat lines to ports in Europe, Cuba, Mexico, Central America (especially Panama) and South America; by a coastwise steamboat line to New York; and by river boats on a river system embracing nearly 2000 m. of navigable waters in Alabama, Mississippi, and Georgia. The city occupies about 17 sq. m. of a sandy plain, which rises gradually from a low water front along the river to a range of hills a few miles to the westward. Among the principal buildings are the customs-house and post-office, the court-house, the Battle House (a hotel), the United States marine hospital, the city hospital, the Providence infirmary, Barton Academy (a part of the public school system), a Young Men's Christian Association building, St Joseph's church (Roman Catholic), the cathedral of the Immaculate Conception, the Van Antwerp office building, and the southern market and armoury. Mobile is the see of a Roman Catholic bishopric and the headquarters of the United States district court for the southern district of Alabama. In the city are a public library; the departments of medicine and pharmacy of the university of Alabama; the academy of the Visitation, and the

Immaculate Conception school, both for girls and both Roman Catholic; the Convent of Mercy; the Emerson normal and industrial school (for negroes), McGill Institute, the University military school, and the Mobile military institute; and 5 m. from Mobile, at Spring Hill, is Spring Hill college (Roman Catholic, founded in 1830, chartered 1836), controlled by the Jesuits. There is an annual celebration in Mobile on Mardi Gras (Shrove Tuesday), conducted by the Order of Myths and the Mystics, two social organizations, successors of the Cowbellion de Rakin Society, which was organized in 1830 and long conducted a somewhat similar celebration annually, on New Year's Eve.

Mobile is the only seaport of Alabama. In 1826 the channel from it to the Gulf, about 30 m. distant, had a minimum depth of only $5\frac{1}{2}$ ft. through Choctaw Pass and 8 ft. through Dog River bar; but subsequently the channel has been greatly improved by the United States government, and in June 1908¹ vessels drawing 23 and 24 ft. could pass at low-water to the mouth of Chickasaw Creek above the city. While the channel was still shallow, and rapidly growing railway systems were serving other ports, much foreign commerce was lost to Mobile, the value of the exports falling off from \$12,784,171 in 1877 to \$3,258,605 in 1882, and the value of the imports, during the same period, from \$648,404 to \$396,573; but after the improvement of the channel the value of the exports increased from \$8,140,502 in 1897 to \$26,815,270 in 1908, and the value of the imports rose from \$956,712 in 1897 to \$4,242,169 in 1908. The foreign commerce consists largely in the export of cotton, lumber, timber, cotton-seed oil, coal, provisions and clothing, and in the import of tropical fruits (especially bananas), sisal grass, coffee, mahogany, asphalt, and manganese and sulphur ores. Vegetables, particularly beans and cabbage, and small fruits are grown extensively in the vicinity, and the city has an important domestic trade in market-garden produce, fish and oysters, hardware, dry goods, grain and groceries. In manufacturing Mobile was second (Birmingham being first) among the cities of the state in 1905, when the value of the factory product was \$4,942,331, 41.8% more than in 1900. In 1905 it ranked first in the state in the value of fertilizer, lumber and timber, and in the construction of railway cars; and the manufacture of flour and grist mill products and machinery for lumber mills were important industries.

Founded by Pierre Lemoyné, Sieur d'Iberville (1661-1706), and his brother Jean Baptiste Lemoyné, Sieur de Bienville (1680-1768), in 1702, Mobile² was the capital of the French province of Louisiana until 1720, when the seat of government was transferred to Biloxi, in the present Mississippi. The original settlement was at Twenty-seven Mile Bluff, about 20 m. above the present site, to which it was removed in 1710 as a consequence of floods in 1709. By the Treaty of Paris (1763) Mobile, as a part of Louisiana east of the Mississippi, was ceded to Great Britain; but on the 14th of March 1780 it was captured by a Spanish force under Don Bernardo de Galvez (1755-1786), the governor at New Orleans, and Spain was confirmed in its possession by the treaty of 1783. Spanish civil institutions were introduced, and new names, such as Conception, St Emanuel and St Joseph, which still survive, were given to the streets. Yet neither the English nor the Spanish occupation made any substantial change in the tone of the place or the habits of its people, even the negroes holding to their French jargon. The alliance between Great Britain and Spain, at the outbreak of the war of 1812, gave Mobile strategic importance for the military operations in the south-west. Hence, on the 15th of April 1813 General James Wilkinson, acting on President James Madison's instructions, which were based on the claim that Mobile was a part of Louisiana sold by France to the United States in 1803, seized Mobile for the United States.

¹ Between 1826 and 1908 the Federal government expended \$5,148,179 on the improvement of the harbour. The bar channel also has been improved.

² The city was named from the Mobile or Maubila Indians, a Muskogean tribe, now extinct, who occupied the neighbouring region and were Christianized by the French.

In August 1814 General Andrew Jackson made Mobile his headquarters. He repaired Fort Bowyer, on Mobile Point at the mouth of the bay, and garrisoned it just in time for it to resist attack by the British on the 15th of September. On the 11th of February 1815, forty-two days after peace had been declared and thirty-four days after the battle of New Orleans, a British force captured Fort Bowyer; but it made no move against Mobile, and withdrew on the 1st of April. Now began the Americanization of Mobile, a tide of immigration from the up-country setting in and rapidly changing the character of the place, which had previously been distinctly French. A town charter had been granted by the territorial legislature of Mississippi on the 20th of January 1814, and an interesting feature under the town government was the "tariff for bakers," which fixed the weight of loaves of bread in accordance with the price of flour. A city charter, dated the 17th of December 1819, was granted by the first state legislature of Alabama, and Mobile became the commercial emporium for Alabama and Mississippi, its cotton exports increasing from 7000 bales in 1818 to 100,000 in 1830 and 450,000 in 1840. In 1826 Barton Academy, still one of the landmarks of the city, was built; but it was not until 1852 that common schools were opened in Mobile county. Branches of the United States Bank and of the State bank were established at Mobile, and in the panic of 1837 the Bank of Mobile was one of the few banks in the United States that did not suspend payment. The Mobile & Ohio railroad, begun in 1848, provided ampler communication with the Mississippi valley, and Mobile's export of cotton rose to 1,000,000 bales in 1861.

During the Civil War Mobile was an important seaport of the Confederacy. A Federal blockade was begun as early as the 26th of May 1861, but trade with West Indian and European ports was continued by a line of swift vessels, which regularly escaped the blockading squadron. On the 5th of August 1864 Admiral David G. Farragut (*q.v.*), with a Federal fleet of four iron monitors, seven wooden sloops of war, and several gunboats, entered the channel by passing the Confederate defences, Fort Gaines on Dauphin Island and Fort Morgan occupying the site of old Fort Bowyer on Mobile Point, captured the formidable Confederate ironclad ram "Tennessee," destroyed one gunboat and drove another aground. One of the Federal monitors, the "Tecumseh," was destroyed by torpedoes. The Confederate fleet was commanded by Admiral Franklin Buchanan (1800-1874). Fort Gaines surrendered on the 7th, and Fort Morgan on the 23rd of the same month. In the spring of 1865 General E. R. S. Canby (1819-1873), with a Federal force of about 45,000, laid siege to Fort Blakely and Spanish Fort, on the east side of the bay (opposite the city), defended by General Randall L. Gibson (1832-1892) with 5000 men. After twenty-five days of resistance the Confederates evacuated the fortifications and then the city, the Federals entering on the 12th of April 1865. Losses from railway enterprises and the panic of 1873 resulted in the bankruptcy of the municipality in 1879, whereupon its charter was vacated, its property vested in certain trustees acting under the Chancery Court to adjust its debt, and a municipal government under the name of Port of Mobile succeeded the city of Mobile until 1887, when the latter was again chartered. On the 27th of September 1906 Mobile was swept by a hurricane, which destroyed property valued at \$5,000,000 or more.

See Peter J. Hamilton, *Colonial Mobile* (Boston, 1897); and a chapter by the same writer in L. P. Powell's *Historic Towns of the Southern States* (New York, 1900).

MÖBIUS, AUGUST FERDINAND (1790-1868), German astronomer and mathematician, was born at Schulpforta on the 17th of November 1790. At Leipzig, Göttingen and Halle he studied for four years, ultimately devoting himself to mathematics and astronomy. In 1815 he settled at Leipzig as privat-docent, and the next year became extraordinary professor of astronomy in connexion with the university. Later he was chosen director of the university observatory, which was erected (1818-1821) under his superintendence. In 1844 he was elected ordinary professor of higher mechanics and astronomy, a position

which he held till his death on the 26th of September 1868. His doctor's dissertation, *De computandis occultationibus fixarum per planetas* (Leipzig, 1815), established his reputation as a theoretical astronomer. *Die Hauptsätze der Astronomie* (1836), *Die Elemente der Mechanik des Himmels* (1843), may be noted amongst his other purely astronomical publications. Of more general interest, however, are his labours in pure mathematics, which appear for the most part in *Crelle's Journal* from 1828 to 1838. These papers are chiefly geometrical, many of them being developments and applications of the methods laid down in his great work, *Der barycentrische Calcul* (Leipzig, 1827), which, as the name implies, is based upon the properties of the mean point or centre of mass (see ALGEBRA: *Universal*). This work abounds in suggestions and foreshadowings of some of the most striking discoveries in more recent times—such, for example, as are contained in H. Grassmann's *Ausdehnungslehre* and Sir W. R. Hamilton's *Quaternions*. Möbius must be regarded as one of the leaders in the introduction of the powerful methods of modern projective geometry.

His *Gesammelten Werke* have been published in four volumes at Leipzig (1885-1887).

† **MOCATTA, FREDERICK DAVID** (1828-1905), English Jewish philanthropist, was a member of the London financial firm, Mocatta and Goldsmid, but retired from business in 1874 and devoted himself to works of public and private benevolence. Besides this he was a patron of learning and himself an author of historical works, the chief of which was *The Jews and the Inquisition*. On occasion of his 70th birthday, he was presented with a testimonial from more than 200 philanthropic and literary institutions. The Anglo-Jewish Historical Exhibition (1887) owed its inception to him. He bequeathed his fine library to the Jewish Historical Society of England, of which he was at one time president. This library formed the basis of the collections which are now included in the Mocatta Library and Museum, founded in his memory, and located at the University of London (University College, Gower Street).

See *Trans. Jewish Hist. Soc. Eng. vol. v.*

(I. A.)

MOCCASIN (a North-American Indian word, of which the spelling and pronunciation vary in different dialects), a shoe made of deerskin or other soft leather. It is made in one piece; the sole is soft and flexible and the upper part is often adorned with embroidery, beading or other ornament. It is the footwear of the North American Indian tribes and is also worn by hunters, traders and settlers. In botany, the lady's slipper is known in the United States of America, as the "moccasin flower," from its resemblance to a shoe or moccasin. The name moccasin is also given to a venomous snake, found as far north as North Carolina and westward to the Rocky Mountains, and popularly called "cottonmouth," from the white rim around the mouth. It belongs to the family *Crotalidae*, species *Ancistrodon* (or *Cenchrus*) *piscivorus*, is about two feet long, and is often found in marshy land. It is sometimes called the *water moccasin* to distinguish it from the upland moccasin (*Ancistrodon contortrix* or *atrofuscus*), which is commonly called "copperhead" and is found further north in dry and mountainous regions. The name is possibly a distinct word of which the origin has not been traced.

MOCCENIGO, the name of a noble and ancient Venetian family which gave many doges, statesmen and soldiers to the republic. **TOMMASO MOCCENIGO** (1343-1423) commanded the crusading fleet in the expedition to Nicopolis in 1396, and also won battles against the Genoese. While he was Venetian ambassador at Cremona he was elected doge (1414), and he escaped in secret, fearing that he might be held a prisoner by Gabrino Fondolo, tyrant of that city. He made peace with the Turkish sultan, but when hostilities broke out afresh his fleet defeated that of the Turks at Gallipoli. During his reign the patriarch of Aquileia was forced to cede his territories to the republic (1420), which also acquired Friuli and Dalmatia. Tommaso greatly encouraged commerce, reconstructed the ducal palace and commenced the library. **PIETRO MOCCENIGO**, doge from 1474 to 1476, was one of the greatest Venetian admirals,

and revived the fortunes of his country's navy, which had fallen very low after the defeat at Negropont in 1470. In 1472 he captured and destroyed Smyrna; the following year he placed Catherine Cornaro, queen of Cyprus, under Venetian protection, and by that means the republic obtained possession of the island in 1475. He then defeated the Turks who were besieging Scutari, but he there contracted an illness of which he died. **GIOVANNI MOCCENIGO**, Pietro's brother, who was doge from 1478 to 1485, fought against Mohammed II. and Ercole I., duke of Ferrara, from whom he recaptured Rovigo and the Polesine. **LUIGI MOCCENIGO** was doge from 1570 to 1577. During his reign Venice lost the fortresses Nicopolis and Famagosta in Cyprus. He took part in the battle of Lepanto, but after the loss of Cyprus he was forced to make peace with the Turks and to hand them back his conquests. **ANDREA MOCCENIGO**, who flourished in the 15th and 16th centuries, was a senator of the republic and a historian; he composed a work on the league of Cambrai entitled *Belli memorabilis Cameracensis adversus Venetos historiae libri vi.* (Venice, 1525). Another **LUIGI MOCCENIGO** was doge from 1700 to 1709, and his brother **SEBASTIANO** from 1722 to 1732. **ALVISE MOCCENIGO** (1701-1778), who was doge from 1763 until his death, restricted the privileges of the clergy, and in consequence came into bitter conflict with Pope Clement XIII.

MOCHA STONE, a name applied to chalcodyne with dendritic markings, said to have been obtained originally from Mocha in Arabia. The markings which sometimes simulate with curious fidelity the form of miniature trees and shrubs, are caused by the infiltration of solutions carrying iron and manganese, which are deposited as thin films of oxide along the cracks of the stone, producing black, brown or red dendrites, effectively disposed on a ground of grey or white chalcodyne. Most of the Mocha stones of commerce are obtained from India, where they are found among the agate-pebbles resulting from the disintegration of the trap rocks of the Deccan. In recent years the formation of dendrites has been artificially effected at the agate-works of Oberstein, so as to imitate the true Mocha stones.

MOCK, an adjective meaning sham, feigned, spurious, falsely imitative. As a verb it means to decide or imitate contemptuously. The derivation of *O. Fr. moquer*, mod. *moquer*; Ital. *moccare*, from which the English word is adopted, is disputed. Some authorities refer it to Ger. *mucken*, *mucksen*, to growl, grumble, which is probably echoic in origin; others to a supposed Late Lat. *muccare*, formed from *mucus*—mucus, in the sense of "to wipe the nose at."

MOCKING-BIRD, or **MOCK-BIRD** (as W. Chatterton, J. Ray and M. Catesby called it), the popular name of birds belonging to the American sub-family *Mimainae* of the thrushes, *Turdidae*, differing by having the tarsus scutellate in front, while the typical thrushes have it covered by a single horny plate. *Mimus polyglottus*, the northern mocking-bird, inhabits the southern part of the United States, being in the north only a summer visitant; it breeds rarely in New England, is seldom found north of the 38th parallel, and migrates to the south in winter, passing that season in the Gulf States and Mexico. It appears to be less numerous on the western side of the Alleghanies, though found in suitable localities across the continent to the Pacific coast, but seldom farther north than Virginia and southern Illinois, and it is said to be common in Kansas. J. J. Audubon states that the mocking-birds which are resident all the year round in Louisiana attack their travelled brethren on the return of the latter from the north in autumn. The names of the species, both English and scientific, have been bestowed from its capacity of successfully imitating the cry of many other birds, to say nothing of other sounds, in addition to uttering notes of its own which possess a varied range and liquid fullness of tone that are unequalled, according to its admirers, even by those of the nightingale (*g. n.*).

Plain in plumage, being greyish brown above and dull white below, while its quills are dingy black, variegated with white, there is little about the mocking-bird's appearance beyond its graceful form to recommend it; but the lively gesticulations it exhibits are very attractive, and therein its European rival in melody is far surpassed, for the cock-bird mounts aloft in rapid

circling flight, and, alighting on a conspicuous perch, pours forth his ever-changing song to the delight of all listeners; while his actions in attendance on his mate are playfully demonstrative and equally interest the observer. The mocking-bird is moreover of familiar habits, haunting the neighbourhood of houses, and is therefore a general favourite. The nest is placed with little regard to concealment, and is not distinguished by much care in its construction. The eggs, from three to six in number, are of a pale bluish-green, blotched and spotted with light yellowish-brown. They, as well as the young, are much sought after by snakes, but the parents are often successful in repelling these deadly enemies, and are always ready to wage war against any intruder on their precincts, be it man, cat or hawk. Their food is various, consisting of berries, seeds and insects.

Some twelve or fourteen other species of *Mimus* have been recognized, mostly from South America; but *M. orpheus* seems to be common to some of the Greater Antilles, and *M. hillii* is peculiar to Jamaica, while the Bahamas have a local race in *M. bahamensis*. The so-called mountain mocking-bird (*Oreoscoptes montanus*) is a form not very distant from *Mimus*; but it inhabits exclusively the plains overgrown with sage-brush (*Artemisia*) of the interior tableland of North America, and is not at all imitative in its notes, so that it is an instance of a misnomer. Of the various other genera allied to *Mimus*, the best known are the thrashers (genus *Harporhynchus*) of which six or eight species are found in North America, which are thrush-like and shy in their habits and do not mimic; and the cat-bird (*Galeoscoptes carolinensis*), which in addition to having an attractive song, utters clucks, whistles and mewing sounds. The sooty-grey colour that, deepening into blackish-brown on the crown and quills, pervades the whole of its plumage—the lower tail-coverts, which are of a deep chestnut, excepted—renders it a conspicuous object; and though, for some reason or other, far from being a favourite, it is always willing when undisturbed to become intimate with men's abodes. It has a much wider range on the American continent than the mocking-bird, and is one of the few species that are resident in Bermuda, while on more than one occasion it is said to have appeared in Europe.

The name mocking-bird, or more frequently mock-nightingale, is in England occasionally given to some of the warblers (*g.r.*), especially the blackcap (*Sylvia atricapilla*), and the sedge-bird (*Acrocephalus schoenobaenus*). In India and Australia the same name is sometimes applied to other species. (A. N.)

MODEL (O. Fr. *modèle*, mod. *modèle*; It. *modello*, pattern, mould; from Lat. *modus*, measure, standard), a tangible representation, whether the size be equal, or greater, or smaller, of an object which is either in actual existence, or has to be constructed in fact or in thought. More generally it denotes a thing, whether actually existing or only mentally conceived of, whose properties are to be copied. In foundries, the object of which a cast is to be taken, whether it be for engineering or artistic purposes, is usually first formed of some easily workable material, generally wood. The form of this model is then reproduced in clay or plaster, and into the mould thus obtained the molten metal is poured. The sculptor first makes a model of the object he wishes to chisel in some plastic material such as wax, ingenious and complicated contrivances being employed to transfer this wax model, true to nature, to the stone in which the final work is to be executed. In anatomy and physiology, models are specially employed as aids in teaching and study, and the method of *moslage* or chromoplastic yields excellent impressions of living organisms, and enables anatomical and medical preparations to be copied both in form and colour. A special method is also in use for making plastic models of microscopic and minute microscopic objects. That their internal nature and structure may be more readily studied, these are divided by numerous parallel transverse cuts, by means of a microtome, into exceedingly thin sections. Each of these shavings is then modelled on an enlarged scale in wax or pulp plates, which are fixed together to form a reproduction of the object.

Models in the mathematical, physical and mechanical sciences are of the greatest importance. Long ago philosophy perceived **Represents**—the essence of our process of thought to lie in the **tion in Thought**.—fact that we attach to the various real objects around us particular physical attributes—our concepts—and by means of these try to represent the objects to our minds. Such views were formerly regarded by mathematicians and physicists as nothing more than unfruitful speculations, but

in more recent times they have been brought by J. C. Maxwell, H. v. Helmholtz, E. Mach, H. Hertz and many others into intimate relation with the whole body of mathematical and physical theory. On this view our thoughts stand to things in the same relation as models to the objects they represent. The essence of the process is the attachment of one concept having a definite content to each thing, but without implying complete similarity between thing and thought; for naturally we can know but little of the resemblance of our thoughts to the things to which we attach them. What resemblance there is lies principally in the nature of the connexion, the correlation being analogous to that which obtains between thought and language, language and writing, the notes on the staff and musical sounds, &c. Here, of course, the symbolization of the thing is the important point, though, where feasible, the utmost possible correspondence is sought between the two—the musical scale, for example, being imitated by placing the notes higher or lower. When, therefore, we endeavour to assist our conceptions of space by figures, by the methods of descriptive geometry, and by various thread and object models; our topography by plans, charts and globes; and our mechanical and physical ideas by kinematic models—we are simply extending and continuing the principle by means of which we comprehend objects in thought and represent them in language or writing. In precisely the same way the microscope or telescope forms a continuation and multiplication of the lenses of the eye; and the notebook represents an external expansion of the same process which the memory brings about by purely internal means. There is also an obvious parallelism with representation by means of models when we express longitude, mileage, temperature, &c., by numbers, which should be looked upon as arithmetical analogies. Of a kindred character is the representation of distances by straight lines, of the course of events in time by curves, &c. Still, neither in this case nor in that of maps, charts, musical notes, figures, &c., can we legitimately speak of models, for these always involve a concrete spatial analogy in three dimensions.

So long as the volume of matter to be dealt with in science was insignificant, the need for the employment of models was naturally less imperative; indeed, there are self-evident advantages in comprehending things without resort to complicated models, which are difficult to make, and cannot be altered and adapted to extremely varied conditions so readily as can the easily adjusted symbols of thought, conception and calculation. Yet as the facts of science increased in number, the greatest economy of effort had to be observed in comprehending them and in conveying them to others; and the firm establishment of ocular demonstration was inevitable in view of its enormous superiority over purely abstract symbolism for the rapid and complete exhibition of complicated relations. At the present time it is desirable, on the one hand, that the power of deducing results from purely abstract premisses, without recourse to the aid of tangible models, should be more and more perfected, and on the other that purely abstract conceptions should be helped by objective and comprehensive models in cases where the mass of matter cannot be adequately dealt with directly.

In pure mathematics, especially geometry, models constructed of papier-mâché and plaster are chiefly employed to present to the senses the precise form of geometrical figures, surfaces and curves. Surfaces of the second order, represented by equations of the second degree between **Models in Mathematics and Physics**, the rectangular co-ordinates of a point, are very simple to classify, and accordingly all their possible forms can easily be shown by a few models, which, however, become somewhat more intricate when lines of curvature, loxodromics and geodesic lines have to appear on their surfaces. On the other hand, the multiplicity of surfaces of the third order is enormous, and to convey their fundamental types it is necessary to employ numerous models of complicated, not to say hazardous, construction. In the case of more intricate surfaces it is sufficient to present those singularities which exhibit variation from the usual type of surface with synclastic or anticlastic curvatures, such as, for example, a sharp edge or point, or

an intersection of the surface with itself; the elucidation of such singularities is of fundamental importance in modern mathematics.

In physical science, again, models that are of unchangeable form are largely employed. For example, the operation of the refraction of light in crystals can be pictured if we imagine a point in the centre of the crystal whence light is dispersed in all directions. The aggregate of the places at which the light arrives at any instant after it has started is called the wave-front. This surface consists of two cups or sheets fitting closely and exactly one inside the other. The two rays into which a single ray is broken are always determined by the points of contact of certain tangent-planes drawn to those sheets. With crystals possessing two axes these wave-surfaces display peculiar singularities in the above sense of the term, in that the inner sheet has four protuberances, while the outer has four funnel-like depressions, the lowest point of each depression meeting the highest point of each protuberance. At each of these funnels there is a tangent-plane that touches not in a single point, but in a circle bounding the depression, so that the corresponding ray of light is refracted, not into two rays, but into a whole cone of light—the so-called conical refraction theoretically predicted by Sir W. R. Hamilton and experimentally detected by Humphrey Lloyd. These conditions, which it is difficult to adequately express in language, are self-evident so soon as the wave-surface formed in plaster lies before our eyes. In thermodynamics, again, similar models serve, among other purposes, for the representation of the surfaces which exhibits the relation between the three thermodynamic variables of a body, e.g. between its temperature, pressure and volume. A glance at the model of such a thermodynamic surface enables the behaviour of a particular substance under the most varied conditions to be immediately realized. When the ordinate intersects the surface but once a single phase only of the body is conceivable, but where there is a multiple intersection various phases are possible, which may be liquid or gaseous. On the boundaries between these regions lie the critical phases, where transition occurs from one type of phase into the other. If for one of the elements a quantity which occurs in calorimetry be chosen—for example, entropy—information is also gained about the behaviour of the body when heat is taken in or abstracted.

After the stationary models hitherto considered, come the manifold forms of moving models, such as are used in geometry, to show the origin of geometrical figures from the motion of others—e.g. the origin of surfaces from the motion of lines. These include the thread models, in which threads are drawn tightly between movable bars, cords, wheels, rollers, &c. In mechanics and engineering an endless variety of working models are employed to convey to the eye the working either of machines as a whole, or of their component and subordinate parts. In theoretical mechanics models are often used to exhibit the physical laws of motion in interesting or special cases—e.g. the motion of a falling body or of a spinning-top, the movement of a pendulum on the rotating earth, the vortical motions of fluids, &c. Akin to these are the models which execute more or less exactly the hypothetical motions by which it is sought to explain various physical phenomena—as, for instance, the complicated wave-machines which present the motion of the particles in waves of sound (now ascertained with fair accuracy), or the more hypothetical motion of the atoms of the aether in waves of light.

The varying importance which in recent times has been attached to models of this kind is intimately connected with the changes which have taken place in our conceptions of nature. The first method by which an attempt was made to solve the problem of the universe was entirely under the influence of Newton's laws. In analogy to his laws of universal gravitation, all bodies were conceived of as consisting of points of matter—atoms or molecules—to which was attributed a direct action at a distance. The circumstances of this action at a distance, however, were conceived as differing from those of the Newtonian law of attrac-

tion, in that they could explain the properties not only of solid elastic bodies, but also those of fluids, both liquids and gases. The phenomena of heat were explained by the motion of minute particles absolutely invisible to the eye, while to explain those of light it was assumed that an impalpable medium, called luminiferous aether, permeated the whole universe; to this were attributed the same properties as were possessed by solid bodies, and it was also supposed to consist of atoms, although of a much finer composition. To explain electric and magnetic phenomena the assumption was made of a third species of matter—electric fluids which were conceived of as being more of the nature of fluids, but still consisting of infinitesimal particles, also acting directly upon one another at a distance. This first phase of theoretical physics may be called the direct one, in that it took as its principal object the investigation of the internal structure of matter as it actually exists. It is also known as the mechanical theory of nature, in that it seeks to trace back all natural phenomena to motions of infinitesimal particles, i.e. to purely mechanical phenomena. In explaining magnetic and electrical phenomena it inevitably fell into somewhat artificial and improbable hypotheses, and this induced J. Clerk Maxwell, adopting the ideas of Michael Faraday, to propound a theory of electric and magnetic phenomena which was not only new in substance, but also essentially different in form. If the molecules and atoms of the old theory were not to be conceived of as exact mathematical points in the abstract sense, then their true nature and form must be regarded as absolutely unknown, and their groupings and motions, required by theory, looked upon as simply a process having more or less resemblance to the workings of nature, and representing more or less exactly certain aspects incidental to them. With this in mind, Maxwell propounded certain physical theories which were purely mechanical so far as they proceeded from a conception of purely mechanical processes. But he explicitly stated that he did not believe in the existence in nature of mechanical agents so constituted, and that he regarded them merely as means by which phenomena could be reproduced, bearing a certain similarity to those actually existing, and which also served to include larger groups of phenomena in a uniform manner and to determine the relations that held in their case. The question no longer being one of ascertaining the actual internal structure of matter, many mechanical analogies or dynamical illustrations became available, possessing different advantages; and as a matter of fact Maxwell at first employed special and intricate mechanical arrangements, though later these became more general and indefinite. This theory, which is called that of mechanical analogies, leads to the construction of numerous mechanical models. Maxwell himself and his followers devised many kinematic models, designed to afford a representation of the mechanical construction of the ether as a whole as well as of the separate mechanisms at work in it: these resemble the old wave-machines, so far as they represent the movements of a purely hypothetical mechanism. But while it was formerly believed that it was allowable to assume with a great show of probability the actual existence of such mechanisms in nature, yet nowadays philosophers postulate no more than a partial resemblance between the phenomena visible in such mechanisms and those which appear in nature. Here again it is perfectly clear that these models of wood, metal and cardboard are really a continuation and integration of our process of thought; for, according to the view in question, physical theory is merely a mental construction of mechanical models, the working of which we make plain to ourselves by the analogy of mechanisms we hold in our hands, and which have so much in common with natural phenomena as to help our comprehension of the latter.

Although Maxwell gave up the idea of making a precise investigation into the final structure of matter as it actually is, yet in Germany his work, under G. R. Kirchhoff's lead, was carried still further. Kirchhoff defined his own aim as being to describe, not to explain, the world of phenomena; but as he leaves the means of description open his theory differs little from Maxwell's, so soon as recourse is had to description by

means of mechanical models and analogies. Now the resources of pure mathematics being particularly suited for the exact description of relations of quantity, Kirchoff's school laid great stress on description by mathematical expressions and formulæ, and the aim of physical theory came to be regarded as mainly the construction of formulæ by which phenomena in the various branches of physics should be determined with the greatest approximation to the reality. This view of the nature of physical theory is known as mathematical phenomenology; it is a presentation of phenomena by analogies, though only by such as may be called mathematical.

Another phenomenology in the widest sense of the term, maintained especially by E. Mach, gives less prominence to mathematics, but considers the view that the phenomena of motion are essentially more fundamental than all the others to have been too hastily taken. It rather emphasizes the prime importance of description in the most general terms of the various spheres of phenomena, and holds that in each sphere its own fundamental law and the notions derived from this must be employed. Analogies and elucidations of one sphere by another—*e.g.* heat, electricity, &c.—by mechanical conceptions, this theory regards as mere ephemeral aids to perception, which are necessitated by historical development, but which in course of time either give place to others or entirely vanish from the domain of science.

All these theories are opposed by one called energetics (in the narrower sense), which looks upon the conception of energy, not that of matter, as the fundamental notion of all scientific investigation. It is in the main based on the similarities energy displays in its various spheres of action, but at the same time it takes its stand upon an interpretation or explanation of natural phenomena by analogies which, however, are not mechanical, but deal with the behaviour of energy in its various modes of manifestation.

A distinction must be observed between the models which have been described and those experimental models which present on a small scale a machine that is subsequently to be completed on a larger, so as to afford a trial of its capabilities. Here it must be noted that a mere alteration in dimensions is often sufficient to cause a material alteration in the action, since the various capabilities depend in various ways on the linear dimensions. Thus the weight varies as the cube of the linear dimensions, the surface of any single part and the phenomena that depend on such surfaces are proportionate to the square, while other effects—such as friction, expansion and conduction of heat, &c., vary according to other laws. Hence a flying-machine, which when made on a small scale is able to support its own weight, loses its power when its dimensions are increased. The theory, initiated by Sir Isaac Newton, of the dependence of various effects on the linear dimensions, is treated in the article UNITS, DIMENSIONS OF. Under simple conditions it may often be affirmed that in comparison with a large machine a small one has the same capacity, with reference to a standard of time which must be diminished in a certain ratio.

Of course experimental models are not only those in which purely mechanical forces are employed, but also include models of thermal, electro-magnetic and other engines—*e.g.* dynamo and telegraphic machines. The largest collection of such models is to be found in the museum of the Washington Patent Office. Sometimes, again, other than purely mechanical forces are at work in models for purposes of investigation and instruction. It often happens that a series of natural processes—such as motion in liquids, internal friction of gases, and the conduction of heat and electricity in metals—may be expressed by the same differential equations; and it is frequently possible to follow by means of measurements one of the processes in question—*e.g.* the conduction of electricity just mentioned. If then there be shown in a model a particular case of electrical conduction in which the same conditions at the boundary hold as in a problem of the internal friction of gases, we are able by measuring the electrical conduction in the model to determine at once the

numerical data which obtain for the analogous case of internal friction, and which could only be ascertained otherwise by intricate calculations. Intricate calculations, moreover, can very often be dispensed with by the aid of mechanical devices, such as the ingenious calculating machines which perform additions and subtractions and very elaborate multiplications and divisions with surprising speed and accuracy, or apparatus for solving the higher equations, for determining the volume or area of geometrical figures, for carrying out integrations, and for developing a function in a Fourier's series by mechanical means. (L. Bo.)

MODELS, ARTISTS', the name given to persons who pose to artists as models for their work. The Greeks, who had the naked body constantly before them in the exercises of the gymnasium, had far less need of professional models than the moderns; but it is scarcely likely that they could have attained to the high level reached by their works without constant study from nature; and the story told of Zeuxis by Valerius Maximus, who had five of the most beautiful virgins of the city of Crotona offered him as models for his picture of Helen, proves their occasional use. The remark of Eupompus, quoted by Pliny, who advised Lysippus, "Let nature be your model, not an artist," directing his attention to the crowd instead of to his own work, also suggests a use of models which the many portrait statues of Greek and Roman times show to have been not unknown. In Egypt, too, although the priesthood had control of both sculpture and painting as used for the decoration of temples and palaces, and imposed a strict conventionalism, there are several statues of the early periods which are so lifelike in their treatment as to make it certain that they must have been worked from life. At the period of the Renaissance, painters generally made use of their relations and friends as models, of which many examples might be quoted from Venice, Florence, Rome and other places, and the stories of Titian and the duchess of Ferrara, and Botticelli and Simonetta Vespucci, go to show that ladies of exalted rank were sometimes not averse from having their charms immortalized by the painter's brush. But paid models were not unknown, as the story of the unfortunate contadino used by Sansovino as model for his statue of the little Bacchus will show. Artists' models as a special class appear when the establishment of schools for the study of the human figure created a regular demand, and since that time the remuneration offered has ensured a continual supply. The prices and the hours of work vary in different art centres. In England seven shillings is generally paid for a day of six hours, but models of exceptional beauty or talent frequently obtain more from successful artists or wealthy amateurs.

MODEL-YACHTING, the pastime of building and racing model-yachts. It has always been customary for ship-builders to make a miniature model of the vessel under construction, which is in every respect a copy of the original on a small scale, whether steam-ship or sailing-vessel (there is a fine collection in the Victoria and Albert Museum, London). Many of these models are of exquisite workmanship, every rope, pulley or portion of the engine being faithfully reproduced. In the case of sailing yachts these models were often pitted against each other on small bodies of water, and hence arose the modern pastime. It was soon seen that elaborate fittings and complicated rigging were a detriment to rapid handling, and that, on account of the comparatively stronger winds in which models were sailed, they needed a greater draught. For these reasons modern model yachts, which usually have fin-keels, are of about 15% or 20% deeper draught than full-sized vessels, while rigging and fittings have been reduced to absolute simplicity. This applies to models built for racing and not to elaborate copies of steamers and ships, made only for show or for "toy cruising."

Model-yacht clubs have existed for many years in Great Britain, Ireland and the United States, most of them holding a number of regattas during each season. The rules do not generally require the owner or skipper of a model to build his own craft, but among model-yachtsmen the designing and the construction of the boats constitute as important and interesting

a part of the sport as the actual sailing. Models are constructed of some light, seasoned wood—such as pine (preferably white), white cedar or mahogany—free from knots. The hull may either be hollowed out of a solid block of wood, or cut from layers of planks in the so-called "bread-and-butter" style, or planked over a frame of keel and cross-sections. The first two methods are used in constructing "dug-out" models. Hollowing out from the solid block entails a great deal of labour and has therefore fallen into disfavour. In the "bread-and-butter" style a number of planks, which have been shaped to the horizontal sections of the model and from which the middle has been sawn out, are glued together and then cut down to the exact lines of the design, templates being used to test the precision of the curves. In the planked, or "built-up" model, which is generally chosen by more expert builders, the planks are tacked to the frame, as in the construction of large vessels. Models now are generally exaggerated cutters, so far as their underbodies are concerned, or, more often, are fitted with fin-keels weighted with lead, after the manner of full-sized yachts. They may have any rig, but schooner and sloop rigs are most common, the latter being the favourite for racing on account of its simplicity. Two kinds of steering-gear are used, the weighted swinging rudder and the "main-sheet balance gear," the object of both being to keep the model on a true course, either before or against the wind. Models are often sailed without rudders, but though a perfectly built boat will sail readily against the wind without steering-gear, it is almost impossible to keep it on its course before the wind without some contrivance to check divergence. This is accomplished by the weighted rudder, which falls over when the vessel heels and tends to counteract the force of the breeze. There are two varieties of the weighted rudder, in the first of which the weight, usually lead, is fixed to the edge of the rudder, while in the second the weight, usually a ball of lead, is made to run on the tiller above the deck, so that it can be placed further forward or aft, according to the force needed to overcome the influence of the wind. While the weighted rudder is almost universal in the British Isles, the chief model-yachtsmen in America use the "main-sheet balance gear," in which the boom is connected with the tiller in such a manner that, when it swings out with a pressure of wind, the rudder is automatically pulled round sufficiently to keep the yacht in its course. This apparatus is particularly efficient in sailing before the wind.

Model-yacht regattas are very different from the toy-boat matches indulged in by children from one side of a pond to the other. They take place upon sufficiently large bodies of water to allow a course at least a quarter of a mile in length, which is generally sailed twice or three times over to windward and backward. Triangular courses are also sailed. Racing rules correspond generally to those controlling regattas of large boats, and there is full scope to exhibit all the proofs of good seamanship. The yachts are followed in light skiffs, and may not be touched more than a certain number of times during a race, on penalty of a handicap. Racing measurements differ in the various clubs, but all are based upon length and sail-area. In Great Britain the regular Yacht Racing Association rule has been generally adopted, and handicaps deducted from it. In America models are divided into a single schooner with a maximum load water-line of 63 in., and three classes of sloops, the first class including yachts with water-lines between 48 and 53 in., the second class those between 42 and 48 in. and the third and smallest class those between 35 and 42 in. A yacht with a shorter water-line than 35 in. must race in the third class. It has been found that yachts of smaller dimensions possess too little resistance to the wind.

See *Model Sailing Yachts*, in Marshall's Practical Manuals series, 1905; and *How to Build a Model Yacht*, by Herbert Fisher (New York, 1902).

MODENA (ancient *Mutina*), one of the principal cities of Emilia, Italy, the chief town of the province of Modena and the seat of an archbishop, 31 m. E.S.E. of Parma by rail. Pop. (1906), 26,847 (town); 66,762 (commune). It is situated in a

damp, low plain in the open country in the south side of the valley of the Po, between the Secchia to the west and the Panaro to the east. Some of its main streets (as their names indicate) follow the lines of canals, which still (though now covered) traverse the city in various directions. The observatory stands 135 ft. above the level of the sea. Dismantled since 1816, and now largely converted into promenades, the fortifications give the city an irregular pentagonal contour, modified at the north-west corner by the addition of a citadel also pentagonal. Within this circuit there are various open areas—the spacious Ippodromo in front of the citadel, the public gardens in the north-east of the city, the Piazza Grande in front of the cathedral, and the Piazza Reale to the south of the palace. The Via Aemilia passes obliquely right through the heart of the city, from the Bologna Gate in the east to that of Sant' Agostino in the west.

Begun by the Countess Matilda of Tuscany in 1099, after the designs of Lanfranc, and consecrated in 1184, the Romanesque cathedral (S. Geminiano) is a low but handsome building, with a lofty crypt, under the choir (characteristic of the Tuscan Romanesque architecture), three eastern apses, and a façade still preserving some curious sculptures of the 12th century. The interior was restored in 1897. The graceful bell-tower, erected in 1224-1319, named La Ghirlandina from the bronze garland surrounding the weathercock, is 335 ft. high; in the basement may be seen the wooden bucket captured by the Modenesi from the Bolognese in the affray at Zappolino (1325), and rendered famous by Tassoni's *Secchia Rapita*. Of the other churches in Modena, the church of S. Giovanni Decollato contains a *Pieta* in painted terra-cotta by Guido Mazzoni (1450-1518). The so-called Pantheon Estense (the church of S. Agostino, containing works of sculpture in honour of the House of Este) is a baroque building by Bibbiena; it also contains the tombs of Sigonio and Muratori. San Pietro and San Francesco have terra-cottas by Begarelli (1498-1565). The old ducal palace, begun by Duke Francis I. in 1635 from the designs of Avanzini, and finished by Francis Ferdinand V., is an extensive building with a fine courtyard, and now contains the military school and the observatory. The Albergo d'Arti, built by Duke Francis III., accommodates the civic collections, comprising the Museo Lapidario (Roman inscriptions, &c.); the valuable archives, the Biblioteca Estense, with 90,000 volumes and 3000 MSS.; the Museo Civico, with large and good palaeo-ethnological and archaeological collections; a fine collection of textile fabrics, and the picture gallery, a good representative collection presented to the city by Francis V. and since augmented by the addition of the collection of the Marchese Campori. Many of the best pictures in the ducal collection were sold in the 18th century and found their way to Dresden. The town hall is a noteworthy building, with arcades dating from 1194, but in part rebuilt in 1826. The university of Modena, originally founded in 1683 by Francis II., is mainly a medical and legal school, but has also a faculty of physical and mathematical science. The old academy of the *Dissonanti*, dating from 1684, was restored in 1814, and now forms the flourishing Royal Academy of Science and Art. In industrial enterprise silk and linen goods and iron wares are almost the only products of any note. Commerce is chiefly agricultural and is stimulated by a good position in the railway system, and by a canal which opens a water-way by the Panaro and the Po to the Adriatic. Modena is the point at which the railway to Mantua and Verona diverges from that between Milan and Bologna, and has several steam tramways to neighbouring places. It is also the starting-point of a once important road over the Apennines to Pistoia by the Abetone Pass.

Modena is the ancient *Mutina* in the territory of the Boii, which came into the possession of the Romans probably in the war of 215-212 B.C. In 183 B.C. Mutina became the seat of a Roman colony. The Roman town lay immediately to the south-east of the modern; its north-western wall is marked by the modern Corso Umberto I. (formerly Canal Grande). It appears to have been a place of importance under the empire, but none of its buildings is now to be seen. The Roman level, indeed,

is some 15 to 20 ft. below the modern town. Its vineyards and potteries are mentioned by Pliny, the latter doing a considerable export trade. Its territory was coterminous with that of Bononia and Regium, as its diocese is now, and to the south it seems to have extended to the summit of the Apennines. During the civil wars Marcus Brutus, the lieutenant of Lepidus, held out within its walls against Pompeius in 78 B.C., and in 44 B.C. the place was successfully defended by D. Brutus against Mark Antony for four months. The 4th century found Mutina in a state of decay; the ravages of Attila and the troubles of the Lombard period left it a ruined city in a wasted land. In the 7th century, perhaps owing to a terrible inundation,¹ its exiles founded, at a distance of 4 m. to the north-west, a new city, Città Geminiana (still represented by the village of Cittanova); but about the close of the 9th century Modena was restored and re fortified by its bishop, Ludovicus. When it began to build its cathedral (A.D. 1099) the city was part of the possessions of the Countess Matilda of Tuscany; but when, in 1184, the edifice was consecrated by Lucius III., it was a free community. In the wars between Frederick II. and Gregory IX. it sided with the emperor, though ultimately the papal party was strong enough to introduce confusion into its policy. In 1288 Obizzo d'Este was recognized as lord of the city; after the death of his successor, Azzo VIII. (1308), it resumed its communal independence; but by 1336 the Este family was again in power. Constituted a duchy in 1452 in favour of Borso d'Este, and enlarged and strengthened by Hercules II., it became the ducal residence on the incorporation of Ferrara with the States of the Church (1598). Francis I. (1629-1658) erected the citadel and commenced the palace, which was largely embellished by Francis II. Rinaldo (ob. 1737) was twice driven from his city by French invasion. To Francis III. (1698-1780) the city was indebted for many of its public buildings. Hercules III. (1727-1803) saw his states transformed by the French into the Cispadane Republic, and, having refused the principality of Breisgau and Ortenau, offered him in compensation by the treaty of Campo Formio, died an exile at Treviso. His only daughter, Maria Beatrice, married Ferdinand of Austria (son of Maria Theresa), and in 1814 their eldest son, Francis, received back the *Stati Estensi*. His rule was subservient to Austria, reactionary and despotic. On the outbreak of the French Revolution of 1830, Francis IV. seemed for a time disposed to encourage the corresponding movement in Modena; but no sooner had the Austrian army put an end to the insurrection in Central Italy than he returned to his previous policy. Francis Ferdinand V., who succeeded in 1846, followed in the main his father's example. Obligated to leave the city in 1848, he was restored by the Austrians in 1849; ten years later, on the 20th of August 1859, the representatives of Modena declared their territory part of the kingdom of Italy, and their decision was confirmed by the plebiscite of 1860.

See Vedriani, *Storia di Modena* (1666); Tiraboschi, *Mem. storiche modenese* (1793); Scharfberg, *Gesch. des Herzogth. Modena* (1859); Oreste Raggi, *Modena descritta* (1860); Baraldi, *Storia di Modena*; Valdrighi, *Dir. Storico, etc., delle conrade di Modena* (1798-1880); Crespellani, *Guida di Modena* (1879); Cavdoni, *Dichiarazione degli antici marmi Modenesi* (1828).

MODERATOR (from Lat. *moderare*, to impose a *modus*, limit), a judge or umpire, one who acts the part of mediator, and so a term used of the person chosen to be president of a meeting (as in America, of a town meeting). In academic use, the word was formerly applied to the public officer who presided over the exercises, &c., prescribed for candidates for degrees in the university schools; it is now used at Cambridge of one or two officers who are appointed each year to preside over the examination for the mathematical tripos, at Oxford of an examiner in the first public examination, known as "moderations," and at Dublin of a candidate for honours in the examination for degree of Bachelor of Arts. In the Presbyterian churches the name is applied to the minister elected to preside over ecclesiastical meetings or assemblies, as the synod, presbytery or general

¹ Some authorities (of whom Tiraboschi was the first) attribute its desertion entirely to a succession of inundations, denying that it was even among the cities destroyed by Attila.

assembly (see PRESBYTERIANISM). The name was historically given to a party of people who joined together to oppose the "Regulators," another party who professed to administer justice in the Carolinas (1767-1771). Technically, the word is also used of a particular form of lamp, in which the flow of oil from the reservoir to the burner is regulated by a mechanical arrangement to which the name is applied.

MODERATUS OF GADES, a Greek philosopher of the Neo-Pythagorean school, contemporary with Apollonius of Tyana. He wrote a great work on the doctrines of the Pythagoreans, and tried to show that the successors of Pythagoras had made no additions to the views of their founder, but had merely borrowed and altered the phraseology. He has been given a fictitious importance by recent commentators, who have regarded him as the forerunner of the Alexandrian School of philosophy. Zeller has shown that the authority on which this view is based is entirely unsound. Moderatus is thus left as an unimportant though interesting representative of a type of thought which had almost disappeared since the 5th century B.C.

Stobaeus, *Eclogae*, p. 3, preserves a fragment of his writings.

MODESTINUS, HERENNIVS, a celebrated Roman jurist, who flourished about 250 B.C. He appears to have been a native of one of the Greek-speaking provinces, probably Dalmatia, and was a pupil of Ulpian. In Valentinian's *Law of Citations* he is classed with Papinian, Paulus, Gaius and Ulpian. He is mentioned in a rescript of Gordian in the year 240 B.C. in connexion with a *responsum* which he gave to the party to whom the rescript was addressed. No fewer than 345 passages in the *Digest* are taken from his writings.

MODICA, a town of Sicily, in the province of Syracuse, 57 m. W.S.W. of Syracuse by rail and 33 m. direct. Pop. (1901), 48,962. It lies on a hill between two valleys; the hill, crowned by the church of S. Giorgio, reconstructed in the 17th century, was the site of the Sicel town of Motycia, while the modern part of the town extends along the river Mauro, an inundation of which did much damage in September 1902. Remains of megalithic buildings, apparently, however, houses of the Byzantine period, are described in *Notizie degli Scavi*, 1896, 242 seq. Six miles to the south-east is the valley known as the Cava d'Isipica, with hundreds of grottoes cut in its rocky sides; of these only a few are Sicel tombs, the majority being catacombs or open tombs of the early Christian and Byzantine periods, or even cave-dwellings of the latter age.

See P. Orsi in *Notizie degli Scavi* (1905), 431.

MODILLION (a French word, probably from Lat. *modulus*, a measure of proportion), a term in architecture for the enriched block or horizontal bracket generally found under the cornice and above the bedmould of the Corinthian entablature. It is probably so called because of its arrangement in regulated distances.

MODJESKA, HELENA (1844-1909), Polish actress, was born at Cracow on the 12th of October 1844. Her father, Michael Opido, was a musician, and her tastes soon declared themselves strongly in favour of a dramatic career; but it was not until after her marriage in 1861 that she first attempted to act, and then it was with a company of strolling players. Her husband (whose name, Modrzejewski, she simplified for stage purposes) died in 1865. In 1868 she married Count Bozenta Chlapowski, a Polish politician and critic, and almost immediately afterwards received an invitation to act at Warsaw. There she remained for seven or eight years, and won a high position in her art. Her chief tragic rôles were Ophelia, Juliet, Desdemona, Queen Anne in *Richard III.*, Louisa Miller, Maria Stuart, Schiller's Princess Eboli, Marion Delorme, Victor Hugo's Tisbé and Slowacki's Mazepa. In comedy her favourite rôles were Beatrice in *Much Ado About Nothing*, and Donna Diana in the Polish translation of an old Spanish play of that name. Madame Modjeska was also the Polish interpreter of the most prominent plays of Legouvé, Dumas, father and son, Augier, Alfred de Musset, Octave Feuillet and Sardou. In 1876 she went with her husband to California, where they settled on a ranch. This new career, however, proved a failure, and Madame Modjeska returned to

the stage. She appeared in San Francisco in 1877, in an English version of *Adrienne Lecouvreur*, and, in spite of her imperfect command of the language, achieved a remarkable success. She continued to act principally in America, but was also seen from time to time in London and elsewhere in the United Kingdom, her repertory including several Shakespearian rôles and a variety of emotional parts in modern drama. She died on the 9th of April 1909 at her home near Los Angeles, California.

See Mabel Collins, *The Story of Helena Modjeska* (London, 1883), and the (autobiographical) *Memoirs and Impressions* (New York, 1910).

MODLING, an old town of Austria, in Lower Austria, 10 m. S. of Vienna by rail. Pop. (1900), 15,304. It is situated at the entrance of the Brühl valley and is a popular summer resort, possessing iron and sulphur baths. It possesses a Gothic church, with a crypt dating from the 15th century, and a still older Romanesque burial chapel. It has a considerable iron and metal industry, and manufactures of shoes, varnish, &c.

MODOC (i.e. "southerners"), a tribe of North American Indians of the Lutuamian stock, who formerly lived around Lower Klamath Lake, south-western Oregon. They were always an aggressive people, and constantly at war with their neighbours. They are known mainly from their stubborn resistance to the United States government in 1872 and 1873. This is called the Modoc War, and was caused by an attempt to place them on a reservation. After some preliminary fighting the Modocs retreated to the "Lava Beds," a basaltic region, seamed and crevassed, and rich in caves. Here they made a stand for several months. During the war two members of a peace commission were treacherously massacred by them while under a flag of truce. On their final submission the leaders were hanged and part of the tribe was removed to Indian Territory (now Oklahoma), and the others were sent back to a reservation on the Klamath.

MODULE (Lat. *modulus*, a measure), in architecture, the semi-diameter of the column at its base; the term was first set forth by Vitruvius (iv. 3), and was generally employed by the architects of the Italian revival to determine the relative proportions of the various parts of a columnar ordinance. The module was divided by the revivalists into thirty parts, called minutes, allowing of much greater accuracy than was thought necessary by Vitruvius, whose subdivision was usually six parts. The tendency now is to adopt the whole diameter instead of the semi-diameter when determining the height of the column or entablature or any of their subdivisions. The term module is also applied in hydraulics (*q.v.*) to a contrivance for regulating the supply of water from an irrigation channel.

MOERIS, AELIUS, Greek grammarian, surnamed *Atticista* ("the Atticist"), probably flourished in the 2nd century A.D. He was the author of an extant (more or less alphabetic) list of Attic forms and expressions (*Ἀττικαὶ λέξεις*), accompanied by the Hellenistic parallels of his own time, the differences of gender, accent and meaning being clearly and succinctly pointed out.

Editions by J. Hudson (1711); J. Pierson (1759); A. Koch (1830); I. Bekker (1833); with Harporation.

MOERIS, LAKE OF, the lake which formerly filled the deep depression of the Fayum to the Nile level, now shrunken and sunk more than 200 ft. to the shallow Birket el Kerûn. In remote prehistoric times the Fayum depression was probably dry, but with the gradual rise of the river bed the high Nile reached a level at which it could enter through the natural or artificial channel now known as the Bahr Yusuf. The borders of the lake were occupied by a neolithic people, and the town of Crocodilopolis grew up very early on the eastern slope south of the channel, where the higher ground formed a ridge in the lake. The rise continuing (at the rate of about 4 in. to the century) the waters threatened to flood the town; consequently under the XIIth Dynasty great embankments were made to save the settled land from encroachment. The line of the embankment is still traceable in places and marked by monuments of the XIIth Dynasty kings, an obelisk of Senwosri I. at Ebgig, and colossi of Anemehê III. at Biahmu. The latter ornamented the quay

of the port of Crocodilopolis, and projected into the lake on high bases. As the Nile fell the broad expanse of the lake lowered, and the water pouring back through the channel was of value for summer irrigation; the inflow and outflow were regulated by sluices, and the capture of fish here and in the lake was enormous. The channel which was of such importance was called the "Great Channel," Mewer, in Greek Moeris. The native name of the lake was Shei, "the lake," later Piôm, "the sea" (whence Fayum); Teshei, "the land of the lake," was the early name of the region. At its capital Crocodilopolis and elsewhere the crocodile god Sobk (Suchus) was worshipped. Senwosri II. of the XIIth Dynasty built his pyramid at Illahun at the outer end of the channel, Amenemêh III. built his near the inner end at Hawara, and the vast labyrinth attached to it was probably his funerary temple. This labyrinth was afterwards worshipped in more than one locality about the lake under the name Marres (his praenomen Nemař) or Peremarres, i.e. Pharaoh Marres. The mud poured in at high Nile made rich deposits on the eastern slope; in the reign of Philadelphus large reclamations of land were made, veterans from the Syrian War were settled in the "Lake" (*Ἄμμν*), and the latter quickly became a populous and very fertile province. Strabo's account of the Lake of Moeris must be copied from earlier writers, for in his day the outflow had been stopped probably for two centuries, and the old bed of the lake was dotted with flourishing villages to a great depth below the level of the Nile. Large numbers of papyri of the Ptolemaic and Roman periods have been found in and about the Fayum, which continued to flourish through the first two centuries of the Roman rule.

See W. M. F. Petrie, *Hawara Biahmu and Arsinoe* (London, 1889); R. H. Brown, *The Fayum and Lake Moeris* (London, 1892); B. P. Grenfell, A. S. Hunt and D. G. Hogarth, *Fayum Towns and their Papyri* (London, 1900); H. J. C. Beadnell, *The Topography and Geology of the Fayum Province of Egypt* (Cairo, 1905). (F. L. G.)

MOESIA (Gr. *Μυσία* and *Μυσία ἡ ἐν Ἐβρώπῳ*, to distinguish it from Mysia in Asia), in ancient geography, a district inhabited by a Thracian people, bounded on the S. by the mountain ranges of Haemus and Scardus (Scordus, Scodrus), on the W. by the Drinus, on the N. by the Danube and on the E. by the Euxine. It thus corresponded in the main to the modern Servia and Bulgaria. In 75 B.C., C. Scribonius Curio, proconsul of Macedonia, penetrated as far as the Danube, and gained a victory over the inhabitants, who were finally subdued by M. Licinius Crassus, grandson of the triumvir and also proconsul of Macedonia, during the reign of Augustus c. 29 B.C. (see Mommsen, *Provinces of the Roman Empire*, Eng. trans., i. 12-14). The country, however, was not organized as a province until the last years of the reign; in A.D. 6 mention is made of its governor, Caecina Severus (Dio Cassius Iv. 29). The statement of Apollonius (*Illyrica*, 30) that it did not become a Roman province until the time of Tiberius, is therefore incorrect. Originally one province, under an imperial consular legate (who probably also had control of Achaea and Macedonia), it was divided by Domitian into Upper (*superior*) and Lower (*inferior*, also called *Ripa Thracia*) Moesia, the western and eastern portions respectively, divided from each other by the river Cebrus (Ciabrus; mod. Cibritza or Zibru). Some, however, place the boundary further west. Each was governed by an imperial consular legate and a procurator. As a frontier province, Moesia was strengthened by stations and fortresses erected along the southern bank of the Danube, and a wall was built from Axiopolis to Tomi as a protection against Scythian and Sarmatian inroads. After the abandonment of Dacia (*q.v.*) to the barbarians by Aurelian (272-275) and the transference of its inhabitants to the south of the Danube, the central portion of Moesia took the name of Dacia Aureliana (again divided into Dacia *ripensis* and *interior*). The district called Dardania (in Upper Moesia), inhabited by the Illyrian Dardani, was formed into a special province by Diocletian with capital Naissus (Nissa or Nish), the birthplace of Constantine the Great. The Goths, who had already invaded Moesia in 250, hard pressed by the Huns, again crossed the Danube during the reign of Valens (376), and with his permission settled in

Moesia. But quarrels soon took place, and the Goths under Fritigern defeated Valens in a great battle near Adrianople (378). These Goths are known as Moeso-Goths, for whom Ullilas made the Gothic translation of the Bible. In the 7th century Slavs and Bulgarians entered the country and founded the modern kingdoms of Servia and Bulgaria. The chief towns of Upper Moesia were: Singidunum (Belgrade), Viminacium (sometimes called municipium Aelium; Kostolatz), Bononia (Widdin), Ratiaria (Arcther): of Lower Moesia; Oescus (colonia Ulpia, Gigen), Novae (near Sistova, the chief seat of Theodorici), Nicopolis ad Istrum (Nikup), really on the Iatrus or Yantra, Odessus (Varna), Tomi (Kustendje), to which the poet Ovid was banished. The last two were Greek towns, which, with Istros, Mesambria and Apollonia, formed a pentapolis.

See Orosius v. 23, 20; Livy, *Epit.* 92, 134, 137; Dio Cassius li. 25-27; E. R. Rösler, *Römische Studien* (Leipzig, 1871); T. Mommsen, *Corpus inscriptionum latinarum*, iii. 141, 263; J. Marquardt, *Römische Staatsverwaltung* (1881), i. 301; H. Kiepert, *Lehrbuch der alten Geographie* (1878), §§ 298, 299; article in Smith's *Dictionary of Greek and Roman Geography* (1873). (J. H. F.)

MOFADDALĪYĀT, strictly **MUFADDALĪYĀT**, an anthology of ancient Arabic poems, which derives its name from al-Mufaḍḍal, son of Muḥammad, son of Ya'la, a member of the tribe of Dabba, who compiled it some time between A.D. 762 and 784 in the latter of which years he died. Al-Mufaḍḍal was a contemporary of Ḥammād ar-Rāwiyā and Khalaf al-Aḥmar, the famous collectors of ancient Arab poetry and tradition, and was somewhat the junior of Abū 'Amr ibn al-'Alā, the first scholar who systematically set himself to preserve the poetic literature of the Arabs. He died about fifty years before Abū 'Ubaida and al-Asma'ī, to whose labours posterity is largely indebted for the arrangement, elucidation and criticism of ancient Arabian verse; and his anthology was put together between fifty and sixty years before the compilation by Abū Tammām of the *Ḥamāsā* (q.v.).

Al-Mufaḍḍal was a careful and trustworthy collector both of texts and traditions, and is praised by all authorities on Arabian history and literature as in this respect greatly the superior of Ḥammād and Khalaf, who are accused (especially the latter) of unscrupulous fabrication of poems in the style of the ancients. He was a native of Kūfa, the northernmost of the two great military colonies founded in 638 by the caliph 'Omar for the control of the wide Mesopotamian plain. In Kūfa and Baṣra were gathered representatives of all the Arabian tribes who formed the fighting force of the Islamic Empire, and from these al-Mufaḍḍal was able to collect and record the compositions of the poets who had celebrated the fortunes and exploits of their forefathers. He, no doubt, like al-Asma'ī and Abū 'Ubaida, also himself visited the areas occupied by the tribes for their camping grounds in the neighbouring desert; and adjacent to Kūfa was al-Ḥira, the ancient capital of the Lakhmid kings, whose court was the most celebrated centre in pre-Islamic Arabia, where, in the century before the preaching of the Prophet, poets from the whole of the northern half of the peninsula were wont to assemble. There is indeed a tradition that a written collection (*ḍiwān*) existed in the family of an-Nu'mān, the last Lakhmid king, containing a number of poems by the *Puḥāl*, or most eminent poets of the pagan time, and especially by those who had praised the princes of the house, and that this collection passed into the possession of the Omayyad caliphs of the house of Marwān; to this, if the tradition is to be believed, al-Mufaḍḍal probably had access.

The date of al-Mufaḍḍal's birth is unknown; but he lived for many years under the caliphs of the Omayyad line until their overthrow by the 'Abbasids in 749. In 762 he took part in the rising led by Ibrahim ibn 'Abdallāh ibn al-Ḥasan, the 'Alid, called "The Pure Soul," against the caliph al-Manṣūr, and after the defeat and death of Ibrahim was cast into prison. Al-Manṣūr, however, pardoned him on the intercession of his fellow-tribesman Musayyab ibn Zuhair of Dabba, and appointed him the instructor in literature of his son, afterwards the caliph al-Mahdī. It was for this price that, at al-Manṣūr's instigation, al-Mufaḍḍal compiled the *Mufaḍḍalīyāt*.

The collection, in its present form, contains 126 pieces of

verse, long and short; that is the number included in the recension of al-Anbārī, who had the text from Abū 'Ikrima of Dabba, who read it with Ibn al-A'rābī, the stepson and inheritor of the tradition of al-Mufaḍḍal. We know from the *Fihrist* of Muḥammad an-Nadīm (A.D. 988) that in his time 128 pieces were counted in the book; and this number agrees with that contained in the Vienna MS., which gives an additional poem, besides those annotated by al-Anbārī, to al-Muraqqish the Elder, and adds at the end a poem by Ibn al-Ḥārith ibn Ḥilliza. The *Fihrist* states (p. 68) that some scholars included more and others fewer poems, while the order of the poems in the several recensions differed; but the correct text, the author says, is that handed down through Ibn al-A'rābī. It is noticeable that this traditional text, and the accompanying scholia, as represented by al-Anbārī's recension, are wholly due to the scholars of Kūfa, to which place al-Mufaḍḍal himself belonged. The rival school of Baṣra, on the other hand, has given currency to a story that the original collection made by al-Mufaḍḍal included a much smaller number of poems. The Berlin MS. of al-Marzūqī's commentary states that the number was thirty, but a better reading of the passage, found elsewhere,¹ mentions eighty; and that al-Asma'ī and his school added to this nucleus poems which increased the number to a hundred and twenty. It is curious that this tradition is ascribed by al-Marzūqī and his teacher Abū 'Alī al-Fārīsī to Abū 'Ikrima of Dabba, who is represented by al-Anbārī as the transmitter of the correct text from Ibn al-A'rābī. There is no mention of it in al-Anbārī's work, and it is in itself somewhat improbable, as in al-Asma'ī's time the schools of Kūfa and Baṣra were in sharp opposition one to the other, and Ibn al-A'rābī in particular was in the habit of censuring al-Asma'ī's interpretations of the ancient poems. It is scarcely likely that he would have accepted his rival's additions to the work of his step-father, and have handed them on to Abū 'Ikrima with his annotations.

The collection is one of the highest importance as a record of the thought and poetic art of Arabia during the time immediately preceding the appearance of the Prophet. Not more than five or six of the 126 poems appear to have been composed by poets who had been born in Islam. The great majority of the authors belonged to the days of "the Ignorance," and though a certain number (e.g. Mutammim ibn Nuwaira, Rabi'a ibn Maqrūm, 'Abda ibn at-Ṭabib and Abū Dhū'ayb), born in paganism, accepted Islam, their work bears few marks of the new faith. The ancient virtues—hospitality to the guest and the poor, profuse expenditure of wealth, valour in battle, faithfulness to the cause of the tribe—are the themes of praise; wine and the game of *maisir*, forbidden by Islam, are celebrated by poets who professed themselves converts; and if there is no mention of the old idolatry, there is also little spirituality in the outlook on life. The 126 pieces are distributed between 68 poets, and the work represents a gathering from the compositions of those who were called *al-Muqillān*, "authors of whom little has survived," in contrast to the famous poets whose works had been collected into *ḍiwāns*. At the same time many of them are extremely celebrated, and among the pieces selected by al-Mufaḍḍal several reach a very high level of excellence. Such are the two long poems of 'Alqama ibn 'Abada (Nos. 119 and 120), the three odes by Mutammim ibn Nuwaira (Nos. 9, 67, 68), the splendid poem of Salāma ibn Jandal (No. 22), the beautiful *nasīb* of ash-Shanfarā (No. 20), and the death-song of 'Abd-Yaghūth (No. 30). One of the most admirable and famous is the last of the series (No. 126), the long elegy by Abū Dhū'ayb of Hudhail on the death of his sons; almost every verse of this poem is cited in illustration of some phrase or meaning of a word in the national lexicons. Only one of the poets of the *Mufaḍḍalīyāt* (see *MO'ALLAKĀT*), al-Ḥārith, son of Ḥilliza, is represented in the collection. Of others (such as Bishr ibn Abī Khāzīm, al-Ḥādīra, 'Amir ibn at-Ṭufail, 'Alqamah ibn 'Abadah, al-Muthaqqib, Ta'abbata Sharrā and Abū Dhū'ayb) *ḍiwāns* or bodies of collected poems exist, but it is doubtful how far these had been brought together when al-Mufaḍḍal made

¹ In the *dhail* or supplement to the *Amālī* of al-Qāfī. (Edn. Cairo 1324 H., p. 131).

his compilation. An interesting feature of the work is the treatment in it of the two poets of Bakr ibn Wa'il, uncle and nephew, called al-Muraqqish, who are perhaps the most ancient in the collection. The elder Muraqqish was the great-uncle of Tarafa of Bakr, the author of the *Mu'allaqa*, and took part in the long warfare between the sister tribes of Bakr and Taghlib, called the war of Basit, which began about the end of the 5th century A.D. Al-Mufaḍḍal has included ten pieces (Nos. 45-54) by him in the collection, which are chiefly interesting from an antiquarian point of view. One, in particular (No. 54), presents a very archaic appearance. It is probable that the compiler set down all he could gather of this ancient author, and that his interest in him was chiefly due to his antiquity. Of the younger Muraqqish, uncle of Tarafa, there are five pieces (Nos. 55-59). The only other authors of whom more than three poems are cited are Bishr ibn Abi Khāzim of Asad (Nos. 96-99) and Rabi' al ibn Maqrūm of Ḍabba (Nos. 38, 39, 43 and 113).

The *Mufaḍḍaliyyāt* differs from the *Hamāsa* in being a collection of complete odes (*qaṣīdas*), while the latter is an anthology of brilliant passages specially selected for their interest or effectiveness, all that is prosaic or less striking being pruned away. It is of course not the case that all the poems of al-Mufaḍḍal's collection are complete. Many are mere fragments, and even in the longest there are often *lacunae*; but the compiler evidently set down all that he could collect of a poem from the memory of the *rāwīs*, and did not, like Abū Tammām, choose only the best portions. We are thus presented with a view of the literature of the age which is much more characteristic and comprehensive than that given by the brilliant poet to whom we owe the *Hamāsa*, and enables us to form a better judgment on the general level of poetic achievement.

The *Mufaḍḍaliyyāt* is not well represented by MSS. in the libraries of the West. There is an imperfect copy of a recension of al-Marzūqī (died 1030), with his commentary, in the Berlin collection. A very ancient fragment (dated 1080) of al-Anbārī's recension, containing five poems in whole or part, is in the Royal Library at Leipzig. In the British Museum there is a copy made about a century ago for C. J. Rich at Bagdad of a MS. with brief glosses; and at Vienna there is a modern copy of a MS. of which the original is at Constantinople, the glosses in which are taken from al-Anbārī, though the author had access also to al-Marzūqī. In the mosque libraries at Constantinople there are at least five MSS.; and at Cairo there is a modern copy of one of these, containing the whole of al-Anbārī's commentary. In America there are at Yale University a modern copy of the same recension, taken from the same original as the Cairo copy, and a MS. of Persian origin, dated 1657, presenting a text identical with the Vienna codex. Quite recently a very interesting MS., probably of the 6th century of the Hegira, but not dated, has come to light. It purports to be the second part of a combination of two anthologies, the *Mufaḍḍaliyyāt* of al-Mufaḍḍal and the *Asma'iyāt* of al-Asma'i, but contains many more poems than are in either of these collections as found elsewhere. The commentary appears to be eclectic, drawn partly (perhaps chiefly) from Ibn al-Sikkī (died 838), and partly from Abū Ja'far Ahmad ibn 'Ubaydī ibn Nāshī, one of al-Anbārī's sources and a pupil of Ibn al-'Arābi; and the compilation seems to be older in date than al-Anbārī, since its glosses are often quoted by him without any name being mentioned. This MS. (which is the property of Mr F. Krenkow of Leicester) appears to represent one of the recensions mentioned by Muḥammad an-Nadīm in the *Fihrist* (p. 68), to which reference has been made above.

In 1885 Professor Heinrich Thorbecke began an edition of the text based on the Berlin codex, but only the first fasciculus, containing forty-two poems, had appeared when his work was cut short by death. In 1897 the first volume of an edition of the text, with a short commentary taken from al-Anbārī, was printed at Constantinople. In 1906 an edition of the whole text, with short glosses taken from al-Anbārī's commentary, was published at Cairo by Abū Bakr b. 'Omar Dāghistānī al-Madānī; this follows generally the Cairo codex above mentioned, but has profited by the scholarship of Professor Thorbecke's edition of the first half of the work. A complete edition of al-Anbārī's text and commentary, with a translation of the poems, undertaken by Sir C. J. Lyall (see *J. R. A. S.*, Sept. 1904) was in the press in 1910. (C. J. L.)

MOFETTA (Ital. from Lat. *mephitis*, a pestilential exhalation), a name applied to a volcanic discharge consisting chiefly of carbon dioxide, often associated with other vapours, representing the final phase of volcanic activity. The word is used frequently in the plural as mofette, or, following the French, *mofettes*. The volcanic vents yielding the emanations are themselves called

mofette. They are not uncommon in Auvergne and in the Eifel, notably on the shore of the Laacher See; whilst other examples are furnished by the Grotta del Canc, near Puzzuoli, the Valley of Death in Java, and the Death Gulch in the Yellowstone Park.

MOFFAT, ROBERT (1795-1883), Scottish Congregationalist missionary to Africa, was born at Ormiston, Haddingtonshire, on the 21st of December 1795, of humble parentage. He began as a gardener, but in 1814, when employed at High Leigh in Cheshire, offered himself to the London Missionary Society, and in 1816 was sent out to South Africa. After spending a year in Namaqua Land, with the chief Afrikaner, whom he converted, Moffat returned to Cape Town in 1819 and married Mary Smith (1795-1870), the daughter of a former employer, a remarkable woman and most helpful wife. In 1820 Moffat and his wife left the Cape and proceeded to Griqua Town, and ultimately settled at Kuruman, among the Bechuana tribes living to the west of the Vaal river. Here he worked as a missionary till 1870, when he reluctantly returned finally to his native land. He made frequent journeys into the neighbouring regions as far north as the Matabele country. The results of these journeys he communicated to the Royal Geographical Society (*Journal* xxv-xxviii, and *Proceedings* ii.), and when in England on furlough (1839-1843) he published his well-known *Missionary Labours and Scenes in South Africa* (1842). He translated the whole of the Bible and *The Pilgrim's Progress* into Sechwana. Moffat was builder, carpenter, smith, gardener, farmer, all in one, and by precept and example he succeeded in turning a horde of bloodthirsty savages into a "people appreciating and cultivating the arts and habits of civilized life, with a written language of their own." He met with incredible discouragement and dangers at first, which he overcame by his strong faith, determination and genial humour. It was largely due to him that David Livingstone, his son-in-law, took up his subsequent work. On his return to England he received a testimonial of £5000. He died at Leigh, near Tunbridge Wells, on the 9th of August 1883.

See *Lives of Robert and Mary Moffat*, by J. S. Moffat (1885); and C. S. Horne, *The Story of the L. M. S.* (1894).

MOFFAT, a burgh of barony, and police burgh, of Upper Annandale, Dumfriesshire, Scotland. Pop. (1901), 2153. It is situated 21 m. N.N.E. of Dumfries by road and 63 m. distant by the Caledonian railway, from both Edinburgh and Glasgow. It is the terminus of a branch line from Beattock, 2 m. distant. It has been famous for its sulphur and saline waters since the middle of the 18th century, and also enjoys great vogue as a holiday resort. The hills in the locality range from the adjacent Gallow Hill (832 ft.) to Hartell (2651 ft.); about 5 m. north there is abundance of beautiful and varied scenery on the Annan, the Evan, the Birnock and the Moffat. The spa, a mile to the north of the town, was acquired by the burgh commissioners in 1898, and there are also spas at Hartell (3½ m. north) and Garpel (2 m. south-west). Dumcrieff House, 2 m. south-west, is the seat of Lord Rollo.

MOGADOR (*Es-Sueira*), the most southern seaport on the Atlantic coast of Morocco, in 31° 50' N., 9° 20' W., the capital of the province of Háhá. Pop. (1908), about 20,000, of whom nearly a half are said to be Jews, and about 100 Europeans. The town stands from 10 to 20 ft. above high water on a projecting ridge of calcareous sandstone. In certain states of wind and sea it is turned almost into an island, and a sea-wall protects the road to Saffi. On the land side stretch miles of sand-dunes studded with broom, and beyond, the argan forests, distinctive of southern Morocco. Approached from this side the city bursts on the view like a mirage between sky and sea, and this perhaps entitles it to its name—*Es-Sueira*—"the picture." It is the best planned and cleanest town in the empire, and this combined with the climate, which is very equable, makes it a health resort, especially for consumptive patients. The mean temperature of the hottest month is 71°·06, and of the coldest month 58°·69. The rainfall varies between 13 and 20 in. annually. The water supply is carried by an overground conduit from a spring near

Diabat. The prosperity of Mogador is due to its commerce. The harbour is well sheltered from all winds except the south-west, but escape is difficult with the wind from that quarter, as the channel between the town and Mogador Island is narrow and hazardous. It is the best-built port of the sultanate and is generally second in point of trade, which is carried on mainly with Marseilles, London, Gibraltar and the Canaries, the principal exports being almonds, goat-skins, gums and olive-oil, and the principal imports cotton goods, sugar and tea. The exports were valued at £407,000 in 1900 and at £364,000 in 1906. The imports were worth £246,000 in 1900 and £368,000 in 1906. Shipping, 1900, 132,000 tons; 1906, 140,000 tons.

A place called Mogador is marked in the 1351 Portulan of the Laurentian library, and the map in Hondius's *Atlas minor* shows the island of Mogador, *I. Domegador*; but the origin of the present town is much more recent. Mogador was founded by Mohammed XVII. (bin Abd Allah) in 1760, and completed in 1770. The Portuguese called it after the shrine of Sidi Megdul, which lies towards the south half-way to the village of Diabat, and forms a striking landmark for seamen. In 1844 the citadel was bombarded by the French.

See A. H. Dyb, "Les Ports du Maroc," in *Bull. Soc. Geog. Comm. Paris* (1908), xxx, 313 sqq., and British Consular reports.

MOGILA, PETER (c. 1506-1647), metropolitan of Kiev from 1632, belonged to a noble Wallachian family. He studied for some time at the university of Paris, and first became a monk in 1625. He was the author of a *Catechism* (Kiev, 1645) and other minor works, but is principally celebrated for the *Orthodox Confession*, drawn up at his instance by the Abbot Kossulowski of Kiev, approved at a provincial synod in 1640, and accepted by the patriarchs of Constantinople, Jerusalem, Alexandria and Antioch in 1642-1643, and by the synod of Jerusalem in 1672. (See **ORTHODOX EASTERN CHURCH**.)

There are numerous editions of the *Confession* in Russian; it has been edited in Greek and Latin by Panagiotis (Amsterdam, 1662), by Hofmann (Leipzig, 1695), and by Kimmel (Jena, 1843), and there is a German translation by Frisch (Frankfort, 1727).

MOGILEV, a government of western Russia, situated on the upper Dnieper, between the governments of Vitebsk and Smolensk on the north and east, and Chernigov and Minsk on the south and west. In the north it is occupied by the watershed which separates the basins of the Dvina and the Dnieper, an undulating tract 650 to 900 ft. above sea-level, and covered nearly everywhere with forests. This watershed slopes gently to the south, to the valley of the Dnieper, which enters the government from the north-east and flows due south. The southern part of the government is flat and has much in common with the Polesie of the government of Minsk; it is, however, more habitable, the marshes being less extensive. Mogilev is built up of Devonian deposits in the north, of Cretaceous in the east, and of Tertiary elsewhere, but generally is covered with a thick layer of Glacial and later alluvial deposits. Interesting finds from the Stone Age, as well as remains of the mammoth, have been made.

The soil is mostly sand, clay (brick-clay and potter's-clay are not uncommon), and peat-bogs, with a few patches of "black earth." The climate is harsh and wet, the average yearly temperature at the Gorki meteorological observatory being 40° F. (14° C. in January and 63° F. in July); cold nights in summer are often the cause of bad crops. The government had 947,625 inhabitants in 1870, and in 1897, 1,706,511, of whom 861,533 were women, and 146,752 lived in towns. The estimated population in 1906 was 2,024,300. The population is mostly White Russian. Agriculture is their chief occupation. Out of the total area of 18,546 sq. m. 40 % is held in communal ownership by the peasants, 48 % is owned by landlords possessing more than 270 acres each, and 3½ % by small owners. Most of the private owners belong to the nobility. The principal crops are rye, oats, barley, buckwheat, potatoes, though wheat, beetroot, flax, hemp and tobacco are also grown. Paper, spirits, wine and nails, leather and tiles are the chief products of the manufactures. The government is divided into eleven districts, of which the

chief towns with their populations in 1897 were: Mogilev-on-Dnieper, or Mogilev Gubernskiy (47,591 in 1900), Chausy (55,500), Cherikov (5250), Homel or Gomel (45,081 in 1900), Gorki (6730), Klimovichi (4706), Mstislavl (10,382 in 1900), Orsha (13,161), Rogachev (9103), Staryi Bykhov (6354), and Syenno (4061).

This government was inhabited in the 10th century by the Slav tribes of the Krivichi and Radimichi. In the 14th century it became part of Lithuania, and afterwards of Poland. Russia annexed it in 1772.

MOGILEV ON THE DNEIPER, a town of Russia, capital of the government of Mogilev. Pop. (1900), 47,591, two-thirds Jews. It is situated on a lilly site on both banks of the Dnieper, 120 m. by rail S.W. of Smolensk. It is the see of an archbishop of the Orthodox Greek Church. The public buildings include the cathedral of the Orthodox Greek Church (founded by Catherine II. of Russia and Joseph II. of Austria in 1780), a Roman Catholic cathedral (built in 1692), an old castle, a museum, a church dating from 1620, and an old Tatar tower. The principal industries are tanneries. The commerce is mostly in the hands of Jews. Corn, salt, sugar and fish are brought from the south, whilst skins and manufactured wares, imported from Germany, are sent to the southern governments.

Mogilev is mentioned for the first time in the 14th century as a dependency of the Vitebsk, or of the Mstislavl principality. At the beginning of the 15th century it became the personal property of the Polish kings. But it was continually plundered—either by Russians, who attacked it six times during the 16th century, or by Cossacks, who plundered it three times. In the 17th century its inhabitants, who belonged to the Orthodox Greek Church, suffered much from the persecutions of the United Greek Church. In 1654 it surrendered to Russia, but in 1661 the Russian garrison was massacred by the inhabitants. In the 18th century the town was taken several times by Russians and by Swedes, and in 1708 Peter the Great ordered it to be destroyed by fire. It was annexed to Russia in 1772. Near here the French under Davout defeated the Russians under Bagration on the 23rd of July 1812.

MOGILEV ON THE DNIESTER, a town of Russia, in the government of Podolia, on the left bank of the Dniester, 57 m. E.S.E. of Kamnets-Podolsk. Pop. (1900), 25,141, nearly one-half Jews; the remainder are Little Russians, Poles and a few Armenians. The Little-Russian inhabitants carry on agriculture, gardening, wine-growing and mulberry culture. The Jews and Armenians are engaged in a brisk trade with Odessa, to which they send corn, wine, spirits and timber, floated down from Galicia, as well as with the interior, to which they send manufactured wares imported from Austria.

Mogilev, named in honour of the Moldavian hospodar Mohila, was founded by Count Potocki about the end of the 16th century. Owing to its situation on the highway from Moldavia to the Ukraine, at the passage across the Dnieper, it developed rapidly. For more than 150 years its possession was disputed between the Cossacks, the Poles and the Turks. It remained in the hands of the Poles, and was annexed to Russia in 1795.

MOGUL, MOGHIAL, or MUGHAL, the Arabic and Persian form of the word Mongol, usually applied to the Mahomedan Empire in India, which was founded by Baber. In consequence the name is applied to all foreign Mahomedans from the countries on the west and north-west of India, except the Pathans. The Great Mogul is the name given to the Mogul emperors of Delhi by the Portuguese and subsequently by Europeans generally.

MOHÁCS, a market town of Hungary, in the county of Baranya, 115 m. S. of Budapest. Pop. (1900), 15,812. It is situated on the right bank of the Danube, and carries on a brisk trade in wine and the agricultural produce of the neighbourhood. Amongst its principal buildings are an old castle and the summer palace of the bishop of Pécs. Mohács is famous in the history of Hungary by the two fateful battles which took place in the plain situated about 3 m. south-west of the town, and marked the beginning and the close of the Turkish dominion in Hungary. In the first (Aug. 29, 1526) the Hungarian army under Louis II.

was annihilated by the Ottoman forces led by Soliman the Magnificent. In the second (Aug. 12, 1687) the Austrians under Charles of Lorraine gained a decisive victory over the Turks, whose power was afterwards still further broken by Prince Eugene of Savoy.

MOHAIR, the hair of a variety of goat originally inhabiting the regions of Asiatic Turkey of which Angora is the centre, whence the animal is known as the Angora goat. The Arabic *muhayyar*, from which the word came into English probably through the Ital. *moccacaro* or Fr. *mocayart*, meant literally, "choice" or "select," and was applied to cloth made of goats' hair. In the 17th century the word, which before appears in such forms as *mocayore* or *mohaïre*, became corrupted by connexion with "hair," cf. "cray-fish" from *écrivisse*. From the English "mohair" the French adapted *moire*, a watered silk fabric.

The typical mohair fibre is 7 to 8 in. long, very lustrous owing to its physical structure (which although akin to wool is different in that the wool scales are indicated only instead of being fully developed, while the fibre is always solid), $\frac{3}{16}$ to $\frac{3}{8}$ of an inch in diameter, of a soft elastic handle, and usually of a clear white transparent colour. The staples of which the fleece is formed should be uniform in length and clearly defined, naturally lending themselves to a good "spin"—a difficult attainment in the case of mohair (see WOOLLEN AND WORSTED MANUFACTURES). There are many varieties of mohair, from the first qualities as here defined to lower qualities of a kempy, unsatisfactory character. Thus in Constantinople, the chief centre of the Turkey mohair trade, a large variety of fleeces is recognized. For example, from the Lake Van district a distinctly inferior kind known as "Van" mohair is obtained, while other districts produce varieties ranging from Van up to the typical quality described above.

The animal from which mohair was originally obtained was a finely-bred Angora goat. Owing to the demand for raw material exceeding the supply, from 1820 onwards there has been a great deal of crossing of the well-bred Angora with the common kind of goat: in fact it has been said that by 1863 the original Angora had practically disappeared. The growing demand for mohair further resulted in attempts on a commercial scale to introduce the goat into South Africa—where it was crossed with the native goat—the United States, Australia, and later still New Zealand. Perhaps the introduction of the Angora into Australia and New Zealand may in part be due to its value as a scrub and blackberry browser; these growths being the "pests" of the two respective countries.

The manufacture of fabrics from mohair—as in the case of alpaca and cashmere—was in the first instance due to the genius of the rearers of the goat. It would, indeed, be interesting to know if the present day mohair goods—often styled "alpacas" really had their origin in the earlier products of Asia Minor. That fabrics of mohair were in use in England early in the 18th century is obvious from Pope's allusion:—

"And, when she sees her friend in deep despair,
Observes how much a chintz exceeds mohair."

Raw mohair was first exported from Turkey to England about 1820, and from that date onwards marked strides were made in its manufacture into useful yarns and fabrics. England has always had, and still maintains, supremacy in this manufacture. Practically the whole of both the Turkish and Cape clips is at least converted into yarn in Yorkshire mills. Quantities of these yarns are also woven into dress goods, dust cloakings, pile fabrics, imitation furs, &c., in Yorkshire, but even greater quantities of mohair yarn are exported to Russia, Germany, Austria, &c., to be converted into astrakans, ordinary braids, brush braids, &c. In the first decade of the 20th century the mohair braid trade received a blow from the introduction of artificial silk.

The history of the introduction of the Angora goat from Asia Minor into the other countries mentioned is as follows. In 1838 pure bred Angoras were introduced into Cape Colony—cashmeres having been previously tried and found unsatisfac-

tory. These pure-bred goats crossed with the common goat laid the basis of the Cape flocks. In 1856-1857 other importations of pure-bred goats were made. From 1868 to 1897 further importations were made, but these were not of the pure-bred goat and consequently were not so valuable. It should here be noted that the Cape flock-owner clips twice—the summer clip yielding a staple which should be of not less than 7 in., and the winter clip a staple which should be of not less than 3 in. to 4 in. Bradford from time to time has objected to the winter clip as being too short, but this clip seems to have established itself and at least once during recent years has been as saleable as the summer clip. The introduction of Angoras into the United States took place in 1849. Other importations of goats from Asia Minor were made between 1857 and 1880, and interchanges of blood also took place between the United States and Cape Colony. Between 1856 and 1875 some three hundred goats were introduced into Australia. Other importations from Cape Colony and the United States have also been made from time to time, and it seems at least possible, if not probable, that Australia may yet find the Angora goat an important asset.

From the following statistics relating to mohair it will be realized that the mohair supply practically comes from two sources, viz. Turkey in Asia and South Africa:—

Country.	No. of Goats.	Yield of Hair.
Asia Minor	3½ to 4 millions.	11 to 12,000,000 lb.
South Africa	4 millions.	12 to 14,000,000 lb.
United States	800,000	1,600,000 lb.
Australia	30,000	—

The price per lb of mohair has varied from 4s. 1d. in 1870 to 13d. or 14d. in 1903, and it is interesting to note that the shipments from Turkey to England follow these price fluctuations in a most curious manner.

Of the consumers of English mohair yarns Russia takes from 15 to 25%, and the continent of Europe as a whole a very large percentage of the total mohair yarn production of Bradford.

MOHAVE (corrupted from *hamok-habé*; "three mountains," their native name, with reference to three peaks, which form a prominent feature of their country), a tribe of North American Indians of Yuman stock. They have always lived along both banks of the lower Colorado river, in Arizona and California.

MOHAWK, a tribe of North American Indians, the chief people of the Iroquois confederacy. The name probably means "man-eaters"; they call themselves *Kanienkehaga*, "flint people." Their villages were in the valley of the Mohawk river, New York. Their territory extended northward to the St Lawrence and southward to the Delaware river and Catskill Mountains. They were thus early in touch with Dutch and English, and were the first Indians to obtain firearms. In the War of Independence they fought with the English, and finally took refuge in Canada, where most of them have remained.

See INDIANS, NORTH AMERICAN. For Mohawk cosmology see 21st Annual Report Bureau Amer. Ethnol. (1899-1900).

MOHICAN, MAHICAN and MOHEGAN, the first two the alternative names of an important tribe and confederacy of North American Indians of Algonquian stock, and the last a dialectic form of the name applied to a branch tribe. The Mohicans inhabited the Hudson valley, and their domain extended into Massachusetts. The Mohicans were called by the French *Loups* (wolf Indians), a translation of "Mohican." At first their council-fire was at Schodac, on an island near Albany, and they were grouped in forty villages. In consequence of attacks by the Mohawks, they moved their council-fire to what is now Stockbridge, Massachusetts, in 1664; in 1730 many migrated to the Susquehanna valley, Pennsylvania, and became absorbed into the Delawares. In 1736 those left in Massachusetts were placed on a reservation at Stockbridge, and called by that name. A few of these Stockbridge Indians, who may be truly called "the last of the Mohicans," are now settled, with some of the Munsees, on a reservation at Green Bay, Wisconsin. The Mohegans, originally an offshoot of the Mohican, lived on Thames river, Connecticut, their county extending into Massachusetts and including Rhode Island. In 1637, on the destruction of the Pequots, an offshoot of the Mohegans, the Mohegans claimed their country too, and thus the territorial power of the

two tribes was consolidated under one Mohegan chief. For some time the Mohegans remained the supreme Indian people of southern New England. Eventually they sold most of their lands and centred in a small reservation on Thames river. They have now practically become extinct.

MOHL, HUGO VON (1805-1872), German botanist, was born at Stuttgart on the 8th of April 1805. He was a son of the Württemberg statesman Benjamin Ferdinand von Mohl (1766-1845), the family being connected on both sides with the higher class of state officials of Württemberg. While a pupil at the gymnasium he pursued botany and mineralogy in his leisure time, till in 1823 he entered the university of Tübingen. After graduating with distinction in medicine he went to Munich, where he met a distinguished circle of botanists, and found ample material for research. This seems to have determined his career as a botanist, and he started in 1828 those anatomical investigations which continued till his death. In 1832 he was appointed professor of botany in Tübingen, a post which he never left. Unmarried, his pleasures were in his laboratory and library, and in perfecting optical apparatus and microscopic preparations, for which he showed extraordinary manual skill. He was largely a self-taught botanist from boyhood, and little influenced in his opinions even by his teachers, preserved always his independence of view on scientific questions. He received many honours during his lifetime, and was elected foreign fellow of the Royal Society in 1868. Von Mohl's writings cover a period of forty-four years; the most notable of them were republished in 1845 in a volume entitled *Vermischte Schriften*. (For lists of his works see *Botanische Zeitung*, 1872, p. 576, and *Royal Soc. Catalogue*, 1870, vol. iv.) They dealt with a variety of subjects, but chiefly with the structure of the higher forms, including both rough anatomy and minute histology. The word "protoplasm" was his suggestion; the nucleus had already been recognized by R. Brown and others, but von Mohl showed in 1844 that the protoplasm is the source of those movements which at that time excited so much attention. He recognized under the name of "primordial utricle" the protoplasmic lining of the vacuolated cell, and first described the behaviour of the protoplasm in cell-division. These and other observations led to the overthrow of J. M. Schleiden's theory of origin of cells by free-cell-formation. His contributions to knowledge of the cell-wall were no less remarkable, he held the view now generally adopted of growth of cell-wall by apposition. He first explained the true nature of pits, and showed the cellular origin of vessels and of fibrous cells; he was, in fact, the true founder of the cell theory. Clearly the author of such researches was the man to collect into one volume the theory of cell-formation, and this he did in his treatise *Die vegetabilische Zelle* (1851), a short work translated into English (Ray Society, 1852). Von Mohl's early investigations on the structure of palms, of cycads, and of tree-ferns permanently laid the foundation of all later knowledge of this subject: so also his work on *Isoetes* (1840). His later anatomical work was chiefly on the stems of dicotyledons and gymnosperms; in his observations on cork and bark he first explained the formation and origin of different types of bark, and corrected errors relating to lenticels. Following on his early demonstration of the origin of stomata (1838), he wrote a classical paper on their opening and closing (1850). In 1843 he started in conjunction with F. Schlechtendal the weekly *Botanische Zeitung*, which he jointly edited till his death. He was never a great writer of comprehensive works; no text-book exists in his name, and it would indeed appear from his withdrawal from co-operation in W. F. B. Hofmeister's *Handbuch* that he had a distaste for such efforts. In his latter years his productive activity fell off, doubtless through failing health, and he died suddenly at Tübingen on the 1st of April 1872.

See Sachs, *History of Botany*, p. 292, &c.; De Bary, *Botanische Zeitung* (1872), p. 561; *Proc. Roy. Soc.*, xxiii. 1; *Allgemeine Deutsche Biographie*, xxii. 55.

MOHL, JULIUS VON (1800-1876), German Orientalist, brother of Hugo von Mohl (*q.v.*), was born at Stuttgart on the 25th of October 1800. Having studied theology at Tübingen (1818-1823),

he abandoned the idea of entering the Lutheran ministry, and in 1823 went to Paris, at that time, under Silvestre De Sacy, the great European school of Eastern letters. From 1826 to 1833 he was nominally professor at Tübingen, but had permission to continue his studies abroad, and he passed some years in London and in Oxford. In 1826 he was charged by the French government with the preparation of an edition of the *Shah Nama* (*Livre des rois*), the first volume of which appeared in 1838, while the seventh and last was left unfinished at his death, being completed by Barbier de Meynard. Discerning this to be his life's work, he resigned his chair at Tübingen in 1834, and settled permanently in Paris. In 1844 he was nominated to the academy of inscriptions, and in 1847 he became professor of Persian at the Collège de France. But his knowledge and interest extended to all departments of Oriental learning. He served for many years as secretary, and then as president of the Société Asiatique. His annual reports on Oriental science, presented to the society from 1840 to 1867, and collected after his death in Paris on the 3rd of January 1876, under the title *Vingt-sept ans d'histoire des études orientales* (Paris, 1879), are an admirable history of the progress of Eastern learning during these years. Concerning the discoveries at Nineveh he wrote *Lettres de M. Botta sur les découvertes à Khorsabad* (1845). He also published anonymously, in conjunction with Justus Olshausen (1800-1882), *Fragments relatifs à la religion de Zoroastre* (Paris, 1829); *Confucii Chi-king sive liber carminum, ex latina P. Lacharmi interpretatione* (Stuttgart, 1830); and an edition of Y-King, *Antiquissimus Sinarum liber, ex interpretatione P. Regis* (Stuttgart, 1834-1839).

His wife Mary (1793-1883), daughter of Charles Clarke, had passed a great part of her early life in Paris, where she was very intimate with Madame Récamier, before their marriage in 1847, and for nearly forty years her house was one of the most popular intellectual centres in Paris. Madame Mohl's friends included a large number of Englishmen and Englishwomen. She died in Paris on the 14th of May 1883. Madame Mohl wrote *Madame Récamier, with a Sketch of the History of Society in France* (London, 1862).

See Kathleen O'Meara, *Madame Mohl, her Salon and Friends* (1885); and M. C. M. Simpson, *Letters and Recollections of Julius and Mary Mohl* (1887).

Mohl's elder brother, ROBERT VON MOHL (1799-1875), was a well-known jurist and statesman. From 1824 to 1845 he was professor of political sciences at the university of Tübingen, losing his position because of some frank criticisms which brought him under the displeasure of the authorities of Württemberg. In 1847 he was a member of the parliament of Württemberg, and in the same year he was appointed professor of law at Heidelberg; in 1848 he was a member of the German parliament which met at Frankfurt, and for a few months he was minister of justice. His later public life was passed in the service of the grand-duke of Baden, whom he represented as ambassador in Munich from 1867 to 1871. He died in Berlin on the 5th of November 1875. Among his numerous writings may be mentioned, *Die deutsche Polizeiwissenschaft nach den Grundsätzen des Rechtsstaats* (Tübingen, 1832-1834, and again 1866); *Geschichte und Literatur der Staatswissenschaften* (Erlangen, 1855-1858); *Encyclopädie der Staatswissenschaften* (Tübingen, 1859, again 1881); and *Staatsrecht, Völkerrecht und Politik* (Tübingen, 1860-1869).

See Mohl's own *Lebenserinnerungen* (Leipzig, 1901); and H. Schulze, *Robert von Mohl, Ein Erinnerungsbild* (Heidelberg, 1886).

Another brother, MORITZ VON MOHL (1802-1888), entered official life at an early age and was a member of the Frankfurt parliament, and later of the parliament of Württemberg and of the imperial Reichstag. He was a voluminous writer on economic and political questions.

MÖHLER, JOHANN ADAM (1796-1838), German theologian, was born at Igersheim in Württemberg on the 6th of May 1796, and after studying philosophy and theology in the lyceum at Ellwangen, entered the university of Tübingen in 1817. Ordained to the priesthood in 1819, he was appointed to a curacy at Riedlingen, but speedily returned as "repent" to Tübingen,

where he became *privatdozent* in 1822, extraordinary professor of theology in 1826 and ordinary professor in 1828. His lectures drew large audiences, including many Protestants. The controversies excited by his *Symbölik* (1832) proved so unpleasant that in 1835 he accepted a call to the university of Munich. In 1838 he was appointed to the deanery of Würzburg, but died shortly afterwards (April 12, 1838).

Möhler wrote *Die Einheit in der Kirche oder das Prinzip des Katholicismus* (Tübingen, 1825); *Athanasius der Grosse u. d. Kirche seiner Zeit* (2 vols., Mainz, 1827); *Symbölik, oder Darstellung der dogmatischen Gegensätze der Katholiken u. Protestanten nach ihren öffentlichen Bekenntnisschriften* (Mainz, 1832; 8th ed., 1871-1872; Eng. trans. by J. B. Robertson, 1843); and *Neue Untersuchungen der Lehrgesetze zwischen den Katholiken u. Protestanten* (1834). His *Gesammelte Schriften u. Aufsätze* were edited by Döllinger in 1839; his *Patrologie* by Reithmayr, also in 1839; and a *Biographie* by B. Wörner was published at Regensburg in 1866. It is with the *Symbölik* that his name is chiefly associated; the interest excited by it in Protestant circles is shown by the fact that within two years of its appearance it had elicited three replies of considerable importance, those namely of F. C. Baur, P. K. Marheineke and C. J. Nitzsch. But, although characterized by learning and acuteness, as well as by considerable breadth of spiritual sympathy, it cannot be said to have been accepted by Catholics themselves as embodying an accurate objective view of the actual doctrine of their church. The liberal school of thought of which Möhler was a prominent exponent was discouraged in official circles, while Protestants, on the other hand, complain that the author failed to grasp thoroughly the significance of the Reformation as a great movement in the spiritual history of mankind, while needlessly dwelling on the doctrinal shortcomings, inconsistencies and contradictions of its leaders.

MOHMAND, a Pathan tribe who inhabit the hilly country to the north-west of Peshawar, in the North-West Frontier Province of India. They are one of the strongest tribes on the border after the Afridis and Waziris, and have given much trouble to the government of India. The country of the Mohmands may be defined roughly as bounded on the E. by British districts from near Jamrud to Fort Abazai, and thence by the Utman Khel country; on the N. by Bajour; on the W. by Kunar; and on the S. by the territories of the Shinwari and Afridi; area, about 1200 sq. m. The Indo-Afghan boundary line now runs through the Mohmand country; but the amir of Afghanistan formerly claimed allegiance from all the Mohmands, and only handed over the greater part of this tract to the British by the Durand Agreement of 1893. The government has given assurances to the Burhan Khel, Dawezai, Halimzai, Isa Khel, Tarakzai and Utmanzai sections of the Mohmands that they will not suffer by the severance of their ancient connexion with Afghanistan; and these are known as the Assured Clans. The tribe are Afghans by descent, and are more akin to the Yusufzais than any of their neighbours. The aspect of the Mohmand hills is exceedingly dreary, and the eye is everywhere met by dry ravines between long rows of rocky hills and crags, scantily clothed with coarse grass, scrubwood and the dwarf palm. In summer great want of water is felt, and the desert tracts radiate an intolerable heat. This, coupled with the unhealthiness of the lowlands, probably accounts for the inferior physique of the Mohmands as compared with their Afridi and Shinwari neighbours, who in summer retire to the cool highlands of Tirah and the Safed Koh. The crops in the Mohmand hills are almost entirely dependent on the winter and autumn rains, and should these fail there is considerable distress; but the Mohmands supplement this source of livelihood by a through trade on rafts along the Kabul river between the British districts and the hill-country beyond them. The exports are wax, hides, ghi and rice from Kunar, and iron from Bajour; the imports are salt, cloth, paper, soap, tea, indigo, sugar, grain, tobacco, needles, scissors and other manufactures of civilization. The Mohmands are characterized by great pride and haughtiness, they bear a bad reputation for treachery and ruthless cruelty, and are not as brave as their Afridi neighbours. They number some 18,000 fighting men, giving roughly a population of 65,000; but all the clans would never act together under any circumstances. British punitive expeditions have been sent against the Mohmands in 1851-52, 1854, 1864, 1879, 1880, but the principal operations were those of 1897.

(T. H. H.)

Campaign of 1897.—The year 1897 witnessed an almost general outbreak among the tribes on the north-west frontier of India. The tribes involved were practically independent, but the new frontier arranged with the amir of Afghanistan, and demarcated by Sir Mortimer Durand's commission of 1893-1894, brought them within the British sphere of influence. The great dread of these high-spirited mountaineers was annexation, and the hostility shown during the demarcation led to the Waziri expedition of 1894. Other causes, however, contributed to bring about the outbreak of 1897. The easy victory of the Turks over the Greeks gave rise to excitement throughout the Mahomedan world, and the publication by the amir of Afghanistan, in his assumed capacity of king of Islam, of a religious work, in portions of which fanatical antipathy to Christians was thinly veiled, aroused a warlike spirit among the border Mahomedans. The growing unrest was not recognized, and all appeared quiet, when, on the 10th of June 1897, a detachment of Indian troops escorting a British frontier officer was suddenly attacked during the mid-day halt in the Tochi valley, where, since the Waziri expedition of 1894-95, certain armed posts had been retained by the government of India. On the 29th of July, with equal suddenness, the fortified posts at Chakdara and Malakand, in the Swat valley, which had been held since the Chitral expedition of 1895, were for several days fiercely assailed by the usually peaceful Swatis under the leadership of the Mad Mullah. On the 8th of August the village of Shabkadar (Shankarghar), within a few miles of Peshawar, and in British territory, was raided by the Mohmands, while the Afridis besieged the fortified posts on the Samana ridge, which had been maintained since the expeditions of 1888 and 1891. Finally, the Afridis, within a few days, captured all the British posts in the Khyber Pass. A division commanded by Major-General Sir Bindon Blood was assembled at Nowshera. The post at Malakand was reached on the 1st of August, and on the following day Chakdara was relieved. The punishment of the Afridis was deferred till the preparations for the Tirah campaign (see **TIRAH**) could be completed. The Mohmands, however, could be immediately dealt with, and against them the two brigades of Sir Bindon Blood's division advanced from Malakand simultaneously with the movement of another division under Major-General (afterwards Sir Edmund) R. Elles from Peshawar; it was intended that the two columns should effect a junction in Bajour. About the 6th of September the two forces advanced, and Major-General Blood reached Nawagai on the 14th of September, having detached a brigade to cross the Rambat Pass. This brigade being sharply attacked in camp at Markhana at the foot of the pass on the night of the 14th, was ordered to turn northwards and punish the tribesmen of the Mamund valley. On the 15th Brigadier (afterwards Major-) General Jeffreys camped at Inayat Killa, and on the following day he moved up the Mamund valley in three columns, which met with strong resistance. A retirement was ordered, the tribesmen following, and when darkness fell the general, with a battery and a small escort, was cut off, and with difficulty defended some buildings until relieved. The casualties in this action numbered 149. This partial reverse placed General Blood in a position of some difficulty. He determined, however, to remain at Nawagai, awaiting the arrival of General Miles, and sent orders to General Jeffreys to prosecute the operations in the Mamund valley. From the 18th to the 23rd these operations were carried on successfully, several villages being burned, and the Mamunds were disheartened. Meanwhile, the camp at Nawagai was heavily attacked on the night of the 20th by about 4000 men belonging to the Hadda Mullah's following. The attack was repulsed with loss, and on the 21st Generals Blood and Elles met at Lakarai. The junction having been effected, the latter, in accordance with the scheme, advanced to deal with the Upper Mohmands in the Jarobi and Koda Khel valleys, and they were soon brought to reason by his well-conducted operations. The work of the Peshawar division was now accomplished, and it returned to take part in the Tirah campaign. Its total casualties were about 30 killed and wounded. On the 22nd General Blood joined General Jeffreys, and on the 24th he

started with his staff for Panjkora. On the 27th General Jeffreys resumed punitive operations in the Mamund valley, destroying numerous villages. On the 30th he encountered strong opposition at Agrah, and had 61 casualties. On the 2nd of October General Blood arrived at Inayat Killa with reinforcements, and on the 11th the Mamunds tendered their submission. The total British loss in the Mamund valley was 282 out of a force which never exceeded 1200 men. After marching into Buner, and revisiting the scenes of the Umbeyla expedition of 1863, the Malakand field-force was broken up on the 21st of January. The objects of the expedition were completely attained, in spite of the great natural difficulties of the country. The employment of imperial service troops with the Peshawar column marked a new departure in frontier campaigns.

(C. J. B.)

MOHONK LAKE, a summer settlement at the northern end of Lake Mohonk, Ulster county, New York, U.S.A., about 14 m. N.W. of Poughkeepsie. It is served from New Paltz, about 1 m. S.E. (about 3½ m. by stage), by the Wallkill Valley railway, a branch of the West Shore. The lake is a small body of water, picturesquely situated 1245 ft. above the sea-level, on Sky Top Mountain (1542 ft.), one of the highest peaks of the Shawangunk range. The highest point of Sky Top lies just east of the south end of the lake; close by, to the west, Eagle Cliff rises to a height of 1412 ft. The development of this beautiful region into a summer resort and the holding of Indian and arbitration conferences here have been due to Albert Keith Smiley (b. 1828), a graduate of Haverford College (1849), who conducted an English and classical academy in Philadelphia in 1853-1857, was principal of the Oak Grove academy at Vassalboro, Maine, in 1858-1860, was principal and superintendent of the Friends' school at Providence, Rhode Island, in 1860-1879, and became a member of the United States Board of Indian Commissioners in 1879. In 1869 he bought, at the northern end of Lake Mohonk, a tract of land on which he built a large hotel. Here, in October 1883, the first Conference of the Friends of the American Indian met; these conferences have since been held annually, their scope being enlarged in 1904 to include consideration of the condition of "other dependent peoples"—i.e. the natives of the Philippines, Porto Rico and Hawaii. The first conference on international arbitration was held here in June 1895.

MOHR, KARL FRIEDRICH (1806-1879), German pharmacist, son of a well-to-do druggist in Coblenz, was born on the 4th of November 1806. Being a delicate child he received much of his early education at home, in great part in his father's laboratory. To this may be traced much of the skill he showed in devising instruments and methods of analysis. At the age of twenty-one he began to study chemistry under Leopold Gmelin, and, after five years spent in Heidelberg, Berlin and Bonn, returned with the degree of Ph.D. to join his father's establishment. On the death of his father in 1840 he succeeded to the business, retiring from it for scientific leisure in 1857. Serious pecuniary losses led him at the age of fifty-seven to become a *privatdozent* in Bonn, where in 1867 he was appointed, by the direct influence of the emperor, extraordinary professor of pharmacy. He died at Bonn on the 28th of September 1879. Mohr was the leading scientific pharmacist of his time in Germany, and he was the author of many improvements in analytical processes. His methods of volumetric analysis were expounded in his *Lehrbuch der chemisch-analytischen Titrimethode* (1855), which won the special commendation of Liebig and has run through many editions. His *Geschichte der Erde, eine Geologie auf neuer Grundlage* (1866), also obtained a wide circulation. In a paper "Über die Natur der Wärme," published in the *Zeitschrift für Physik* in 1837, he gave one of the earliest general statements of the doctrine of the conservation of energy in the words: "besides the 54 known chemical elements there is in the physical world one agent only, and this is called Kraft (energy). It may appear, according to circumstances, as motion, chemical affinity, cohesion, electricity, light and magnetism; and from any one of these forms it can be transformed into any of the others."

MOHS, FRIEDRICH (1773-1839), German mineralogist, was born at Gernrode in the Harz Mountains, on the 29th of January 1773. He was educated at Halle, and at the mining academy at Freiberg. He spent much time in Austria in studying mineralogy and mining, and became professor of mineralogy at Gratz in 1812. On the death of Werner in 1817, he was appointed to the chair of mineralogy in the mining academy of Freiberg, and in 1826 he became professor of mineralogy and superintendent of the Imperial Cabinet at Vienna. His great work was the *Grundriss der Mineralogie* (Eng. trans. *Treatise on Mineralogy*, by Wilhelm Haidinger, 1825). He died at Argardo, near Belluno, Italy, on the 29th of September, 1839.

MOHUN, CHARLES MOHUN, 4th BARON (c. 1675-1712), was the son of the 3rd Baron Mohun, who died in October 1677 as the result of a wound received while acting as second in a duel. The boy had no regular guardian, and before he was seventeen he had earned an unpleasant notoriety in London for rovydism and brawling, had fought a duel and had been tried on a charge of murder. His friend, Captain Richard Hill, a roystering young officer, was in love with the actress Mrs Bracegirdle, and thought William Mountfort, the actor, to be his successful rival. On the night of the 9th of December 1692 Mohun assisted Hill to attempt the actress's abduction. The attempt failed, and Mohun and Hill then escorted Mrs Bracegirdle to her house, and subsequently remained together outside drinking till the appearance of Mountfort, who lived close at hand. Greetings were exchanged between Mohun and Mountfort, and the latter made a disparaging remark about his Hill, who either without warning (according to Mountfort's deathbed statement) or in fair fight (according to other evidence) ran Mountfort through the body, and then absconded. Mohun was arrested and put on trial in Westminster Hall before his peers for murder as an accessory before the fact (1693), but by an overwhelming majority the peers found him not guilty. This verdict has been severely criticized, notably by Macaulay, who saw in it merely a gross instance of class favouritism. But a careful examination of the evidence (in the *State Trials*) justifies the decision, and establishes the presumption that the fight was a fair one. In 1699 Mohun was put on his trial for another alleged murder, but was unanimously and quite justly acquitted. His boon companion, Edward Rich, earl of Warwick (1673-1701), who was tried on a separate indictment for the same crime, was found guilty of manslaughter. On this occasion Mohun expressed regret for his past life, and he seems subsequently to have made a genuine attempt to alter his ways and to have taken a practical interest in public affairs. But in 1712 his violent temper again got the better of him, and he forced the 4th duke of Hamilton, with whom he had been at law for some years, into a desperate duel in Hyde Park in the early hours of the 15th of November, in which both combatants were killed. Thackeray has utilized this incident in *Esmond*. Lord Mohun had no issue, and on his death the barony, which was created in 1628 in favour of his great-grandfather John Mohun (c. 1592-1640), became extinct.

See *The Whole Life and History of My Lord Mohun and the Earl of Warwick* (London, 1711); J. Evelyn, *Diary and Correspondence*; Historical Manuscripts Commission, 11th report, appendix v. (Dartmouth MSS.); G. C. Boase and W. P. Courtney, *Bibliotheca cornubiensis* (1874-1882); Howell, *State Trials*; and Colley Cibber, *Apology*, edited by R. W. Lowe (1889).

MOHUN, MICHAEL (c. 1625-1684), English actor, played at the Cockpit in Drury Lane before the Civil War. He served on the king's side with credit and was promoted captain, and subsequently, in Flanders, major. At the Restoration he returned with Charles II. and took up his former profession, playing a great variety of parts, usually as second to Charles Hart.

MOHUR, the name of a Persian gold coin, used in India from the 16th century. The word is taken from the Persian *mohr*, a seal or ring. Between 1835 and 1801 a gold coin, also called a "mohur," was struck by the government of British India and was of the nominal value of 15 rupees. On the establishment of a gold standard in India in 1899, on the basis of 16d. a rupee,

the British sovereign was declared legal tender and the mohur was thus superseded.

MOIDORE, (a corruption of the Portuguese *moeda d'ouro*, literally, money of gold), the name of a gold Portuguese coin, coined from 1640 to 1732. This was of the sterling value of 13s. 5d. It is the double *moeda d'ouro*, of the value of 4800 reis in 1688, that was current in western Europe and the West Indies for a long period after it ceased to be struck. It was the principal coin current in Ireland at the beginning of the 18th century, and spread to the west of England. At the same period it was current in the West Indies, particularly in Barbados. It was rated in English money at 27s.

MOIR, DAVID MACBETH (1798-1851), Scottish physician and writer, was born at Musselburgh on the 5th of January 1798. He studied medicine at Edinburgh University, taking his degree in 1816. Entering into partnership with a Musselburgh doctor he practised there until his death on the 6th of July 1851. He was a contributor of both prose and verse to the magazines, and particularly, with the signature of "Delta," to *Blackwood's*. A collection of his poetry was edited in 1852 by Thomas Aird. Among his publications were the famous *Life of Missie Wauch, Tailor* (1828), which shows his gifts as a humorist, *Outlines of the Ancient History of Medicine* (1831), and *Sketch of the Poetical Literature of the Past Half Century* (1851).

MOISSAC, a town of south-western France, capital of an arrondissement in the department of Tarn-et-Garonne, 17 m. W.N.W. of Montauban on the Southern railway between Bordeaux and Toulouse. Pop. (1906) town, 4523; commune, 8218. Moissac stands at the foot of vine-clad hills on the right bank of the Tarn; it is divided into two parts by the lateral canal of the Garonne, which crosses the Tarn by way of an aqueduct a short distance above the town. It contains little of note except the abbey-church of St Pierre, a building of the 15th century with a porch of the 12th century which is decorated with elaborate Romanesque carving unsurpassed in France. The cloister of the early 12th century adjoining the north side of the church is also one of the finest of its kind. Romanesque in character, it has pointed arches resting alternately on single and clustered columns with sculptured capitals. Among other remains of the abbey is the abbot's palace, which contains two halls of the Romanesque period. St Martin, the oldest of the other churches of Moissac, dates from before the year 1000. The town has a sub-prefecture, a tribunal of first instance, a communal college for boys, a library and a museum. Trade is in oil, wine, eggs, wool, poultry and fruit (peaches, apricots, &c.).

The town owes its origin to an abbey probably founded in the 7th century by St Amand, the friend of Dagobert. After being devastated by the Saracens, the abbey was restored by Louis of Aquitaine, son of Charlemagne. Subsequently it was made dependent on Cluny, but in 1618 it was secularized by Pope Paul V., and replaced by a house of Augustinian monks, which was suppressed at the Revolution. The town, which was erected into a commune in the 13th century, was taken by Richard Cœur de Lion and by Simon de Montfort.

MOISSAN, HENRI (1852-1907), French chemist, was born at Paris on the 28th of September 1852. Educated at the Museum of Natural History, he was successively professor of toxicology (1886) and of inorganic chemistry (1889) at the School of Pharmacy, and of general chemistry at the Sorbonne (1900). In 1886 he succeeded in obtaining the element fluorine in the free state by the electrolysis of potassium fluoride and anhydrous hydrofluoric acid at a low temperature. Thence he was led to study the production of carbon in its three varieties and to attempt the artificial preparation of diamond, of which he was able to make some minute specimens (see GEMS, § *Artificial*). In connexion with these experiments he developed the electric furnace as a convenient means of obtaining very high temperatures in the laboratory; and by its aid he prepared many new compounds, especially carbides, silicides and borides, and melted and volatilized substances which had previously been regarded as infusible. For his preparation of fluorine he was

awarded the Lacaze prize in 1887; and in 1906 he obtained the Nobel prize for chemistry. He died in Paris on the 20th of February 1907.

His published works include *Le four électrique* (1897), and *Le fluor et ses composés* (1900), besides numerous papers in the *Comptes rendus* and other scientific periodicals. A *Traité de chimie minérale* in five volumes was published under his direction in 1904-1906.

MOJI, a town of Japan, on the Kiushiu side of the Shimono-seki Strait. The strait being only 1 m. in width, Moji and Shimonoseki would be practically the same port did not the swiftness of the current along the latter shore make it convenient for vessels to anchor off Moji. Moji is one of the places voluntarily opened by the Japanese for purposes of direct export. It is the starting-point of the Kiushiu railway, and as there is abundance of coal in its neighbourhood, it has become a town of considerable importance. In 1890 it was little more than a hamlet, but it had in 1901 a population of 25,274, and a considerable foreign trade.

MOJSISOVICS VON MOJSVAR, JOHANN AUGUST GEORG EDMUND (1839-1907), Austro-Hungarian geologist and palaeontologist, son of the surgeon Georg Mojsisovics von Mojsvar (1790-1860), was born at Vienna on the 18th of October 1839. He studied law in Vienna University, taking his doctor's degree in 1864, and in 1867 he entered the Geological Institute, becoming chief geologist in 1870 and vice-director in 1892. He retired in 1900, and died at Mallnitz on the 2nd of October 1907. He paid special attention to the cephalopoda of the Austrian Trias, and his publications include *Das Gebirge um Hallstatt* (1873-1876); *Die Dolomitrise von Südtirol und Venetien* (1878-1880); *Grundlinien der Geologie von Bosnien-Herzegowina* (1880) with E. Tietze and A. Bittner; *Die Cephalopoden der mediterranen Triasprovinz* (1882); *Die Cephalopoden der Hallstätter Kalke* (1873-1903); and *Beiträge zur Kenntniss der obertriadischen Cephalopodenfaunen des Himalaya* (1896). With Melchior Neumayr (1845-1890) he conducted the *Beiträge zur Paläontologie und Geologie Oesterreich-Ungarns*. In 1862, with Paul Grohmann and Dr Guido von Sommeruga, he founded the Austrian Alpine Club, and he also took part in establishing the German Alpine Club, which combined with the former in 1873.

MOKANNA (*al-Moqanna'*, the Veiled), the name given to Jakim, or 'Atā, a man of unknown parentage, originally a fuller in Merv, who posed as an incarnation of Deity, and headed a revolt in Khorāsān against the caliph Mahdi. For about three years he sustained himself in the field against the troops of the caliph and for two years longer in his fortress of Sanam; then, reduced to straits in 779, he and his followers took poison and set fire to the fortress. Much is related to his magical arts, especially of a moonlike light visible for an enormous distance which he made to rise from a pit near Nakhshab. He is the hero of the first part of Moore's *Lalla Rookh*.

MOKHA (Mocha, properly Makha), a town in Arabia on the Red Sea coast in 13° 10' N. and 43° 12' E. Formerly the chief port for the Yemen coffee export, it has much diminished in importance. The coffee grown in the mountain districts of Haraz, Uden, and Ta'iz is now shipped at Hodeda or Aden, though the article retains the trade name of "Mocha." The town lies in a small bay 40 m. N. of Perim at the southern entrance to the Red Sea. The anchorage is not good, and the port is only used by native vessels. Seen from the sea the town has rather an imposing appearance, but a near review shows that the houses though large and built of stone are mostly in ruins. The neighbouring country is an arid plain without fresh water, the town being supplied by an aqueduct from the village of Muza, situated 16 m. to the east. This is probably identical with the Muza of the Periplus, a great seat of the Red Sea trade in antiquity, like like Betel Fakih, Zubeid and other old Tehama towns, formerly seaports, has long since been left by the receding sea. There is a Turkish kaimakam and a small garrison at Mokha, which is part of the civil district of Taiz in the vilayet of Yemen.

MOKSHANY, a town of Russia, in the government of Penza, 24 m. N.W. of the city of Penza. Pop. (1900), 10,710. The

inhabitants are engaged in agriculture, or work in flour-mills, oilworks, tanneries and potash-works. Mokshany, which was built in 1535 as a fort to protect the country from the raids of the Tatars and the Kalmucks, is supposed to occupy the site of the Meshcheryak town of Murunza, mentioned as early as the 9th century.

MOLASSES, the syrup obtained from the drainings of raw sugar or from sugar during the process of refining. In American usage the word usually applies to both forms of the syrup, but in English usage the second form is more usually known as "treacle" (see SUGAR). The word, which in early forms appears as *melasses*, *molassos*, &c., is from the Port. *melaço*, or Fr. *mélasse*, cf. the Late Lat. *mellaceum*, syrup made from honey (mel). The geological term "molasse" must be distinguished; this word, applied to the soft greenish sandstone of the district between the Jura and the Alps, is French, meaning "soft," Lat. *molis*.

MOLAY, JACQUES DE (d. 1314), last grand master of the Knights Templars, was born of a noble but impoverished family, at a village of the same name in the old province of Franche-Comté (mod. department of Haute-Saône), about the middle of the 13th century. The family property being the inheritance of an elder brother, Jacques was thrown upon his own resources. Having been brought up in the neighbourhood of a commandery of the Temple, he entered the order in 1265 at Beaune in the diocese of Autun. It is probable that he at once set out for the East to take part in the defence of the Holy Land against the Saracens. About 1295 he was elected grand master of the order. After the Templars had been driven out of Palestine by the Saracens, De Molay took refuge with the remnant of his followers in the island of Cyprus. Here, while attempting to get together a force to retrieve the disasters to the Christian arms, he received a summons (in 1306) from Pope Clement V. to repair to Paris. The pope's pretext for the summons was his desire to put an end to the quarrels between the Templars and the Knights of St John, and to concert plans for a new crusade; in reality he had entered into a secret agreement with the king of France for the suppression of the Templars. Molay left Cyprus with a retinue of 60 followers, and made a triumphal entry into Paris. On the 13th of October 1307 every Templar in France was arrested, and a prolonged examination of the members of the order was held. De Molay, probably under torture, confessed that some of the charges brought against the order were true. He was kept in prison for several years, and in 1314 he was brought up with three other dignitaries of the Temple before a commission of cardinals and others to hear the sentence (imprisonment for life) pronounced. Then, to the surprise of the commission, De Molay withdrew his confession. Immediately the king heard of it he gave orders that De Molay and another of the four, who had also recanted, should be burnt as lapsed heretics. The sentence was carried out on the 11th (or 10th) of March 1314. De Molay's ashes were gathered up by the people, and it is said that with his last breath he summoned the king and the pope to appear with him before the throne of God.

For the charges brought against the Templars and the famous process in connexion with them, see **TEMPLARS**; J. Michelet, *Procès des Templiers* (1841-1851) and Lavocat, *Procès des frères et de l'ordre du Temple d'après des pièces inédites publiées par M. Michelet* (1888); E. Besson, "Étude sur Jacques de Molay," in *Mémoires de la soc. d'émulation du Doubs* (Besançon, 1876); H. H. Milman, *Hist. of Latin Christianity*, bk. xii., chs. 1 and 2; H. Prutz, *Entwicklung und Untergang des Tempelherrenordens* (Berlin, 1888).

MOLD (formerly *Mould*, Welsh *Y Wyddgrug*, a conspicuous barrow, Lat. *Mons altus*, the translation of the Welsh name), a market town, contributory parliamentary borough of Flintshire, N. Wales; on the London & North-Western railway (Chester and Denbigh branch), 182 m. from London and 11 m. from Chester. Pop. of urban district (1901), 4263. The locality is populous owing to the collieries and lead-smelting works in the vicinity. At the north end of the town there is a height, Bailey Hill (perhaps from *ballia*, the architectural term applied to fortified castle courts). This hill, partly natural and partly artificial, was once the site of a Roman fortification, and in old

records is known as Moaldes, Monhault, or Monthault (*de monte alto*). Mold Castle was probably built by Robert Monthault (temp. William Rufus), was taken and destroyed by Owen Gwynedd in 1144-1145, its site lost to the English and retaken by Llewelyn ap Iowerth in 1201, and by Gruffydd Llwyd in 1322. On this site, too, where there are now no remains of any fortress, were found, in 1840, some 15 skeletons, supposed to be of the 13th or 14th centuries. Maes Garmon (the battlefield of Germanus) is about a mile west of Mold. Here, as is supposed, the "Alleluia Victory" was gained over the Picts and Scots by Lupus and Germanus, bishop of Auxerre, according to some about A.D. 430, but others give A.D. 448, the date of the saint's death. A commemorative obelisk was erected on the Maes by N. Griffith of Rhual (1736). Over a mile south of Mold, on the right of the road to Nerquis, is the "Tower" (15th century, but perhaps restored in the 18th), where, in 1465 or 1475, the royal chieftain, Rheinallt ab Gruffydd ab Bledwyn, hanged Robert Byrne, mayor of Chester, and subsequently burned alive some 200 Chester folk who tried to arrest him. Many tumuli are visible round Mold.

Mold county gao, bought in 1880 by Jesuits expelled from France, was by them named St Germanus's House. St Mary's church, a Gothic building, is mentioned as early as the time of Henry VII. Its important collieries and lead mines; fire-brick, tile, earthenware, mineral oil, tinsplate and nail manufactures, tanneries, breweries and malt-houses, have made Mold the business centre of the county. About 4 m. distant is Cilcein village, of which the church has a carved oak roof, stolen from Basingwerk Abbey at the dissolution of the monasteries. Among the neighbouring Clwyd hills Moel Fammau and Moel Arthur are specially noticeable. On the summit of the former is George III's jubilee pyramid. The Ordovices and the Romans fortified Moel Arthur. The sites of seven posts established against Rome may be traced along the hills bounding Flintshire and Denbighshire.

MOLDAVIA, a former principality of south-eastern Europe, constituting, after its union with Wallachia on the 9th of November 1859, a part of Rumania (*q.v.*).

MOLDAVITE, an olive-green or dull greenish vitreous substance, named by A. Dufrenoy from Moldauthein in Bohemia, where it occurs. It is sometimes cut and polished as an ornamental stone under the name of pseudo-chrysolite. Its bottle-glass colour led to its being commonly called *Bouteillenstein*, and at one time it was regarded as an artificial product, but this view is opposed to the fact that no remains of glass-works are found in the neighbourhood of its occurrence: moreover pieces of the substance are widely distributed in Tertiary and early Pleistocene deposits in Bohemia and Moravia. For a long time it was generally believed to be a variety of obsidian, but its difficult fusibility and its chemical composition are rather against its volcanic origin. Dr F. E. Suess pointed out that the nodules or small masses of moldavite presented curious pittings and wrinkles on the surface, which could not be due to the action of water, but resembled the characteristic markings on many meteorites. Boldly attributing the material to a cosmic origin, he regarded moldavite as a special type of meteorite for which he proposed the name of tectite (Gr. *τηκρός*, melted). To this type are also referred the so-called obsidian bombs and buttons from Australia and Tasmania, known sometimes as australite, and called by R. H. Walcott obsidianites. Similar bodies have been found in Malaysia and have been termed billitonite, from the isle of Billiton where they occur in tin-bearing gravels. Usually they are flat, rounded or ellipsoidal bodies, sometimes surrounded by an equatorial girdle or rim, and often with a brilliant black superficial lustre, as though varnished. Moldavite has been reported also from Scania in Sweden.

See Franz E. Suess, *Jahrbuch der k.-k. geolog. Reichsanstalt* (Vienna), 1901, p. 193; E. Weinschenk, *Centralblatt f. Mineralogie* (Stuttgart), 1908, p. 737.

MOLDE, a small seaside town of Norway, in Romsdal amt (county), 204 m. by sea N.N.E. of Bergen, in 62° 45' N. (that

of the Faroe Islands). It has little trade, but is the principal tourist centre on this part of the coast, and the steamers from Hull and Newcastle, the Norwegian ports, Hamburg, Antwerp, &c., call here. The town fronts the broad Mole Fjord, with its long low islands, and to the east and south a splendid panorama of jagged mountains is seen, reaching 6010 ft. in Store Trollinder of the Romsdal group. Molde is the port for the tourist route through the Romsdal.

MOLÉ, LOUIS MATHIEU, COMTE (1781-1855), French statesman, was born in Paris on the 24th of January 1781. His father, a president of the parlement of Paris, who came of the family of the famous president noticed below, was guillotined during the Terror, and Count Molé's early days were spent in Switzerland and in England with his mother, a relative of Lamoignon-Malesherbes. On his return to France he studied at the école centrale des travaux publics, and his social education was accomplished in the salon of Pauline de Beaumont, the friend of Châteaubriand and Joubert. A volume of *Essais de morale et de politique* introduced him to the notice of Napoleon, who attached him to the staff of the council of state. He became master of requests in 1806, and next year prefect of the Côte d'Or, councillor of state and director-general of bridges and roads in 1809, and count of the empire in the autumn of the same year. In November 1813 he became minister of justice. Although he resumed his functions as director-general during the Hundred Days, he excused himself from taking his seat in the council of state and was apparently not seriously compromised, for Louis XVIII. confirmed his appointment as director-general and made him a peer of France. Molé supported the policy of the duc de Richelieu, who in 1817 entrusted to him the direction of the ministry of marine, which he held until December 1818. From that time he belonged to the moderate opposition, and he accepted the result of the revolution of 1830 without enthusiasm. He was minister for foreign affairs in the first cabinet of Louis Philippe's reign, and was confronted with the task of reconciling the European powers to the change of government. The real direction of foreign affairs, however, lay less in his hands than in those of Talleyrand, who had gone to London as the ambassador of the new king. After a few months of office Molé retired, and it was not until 1836 that the fall of Thiers led to his becoming prime minister of a new government, in which he held the portfolio of foreign affairs. One of his first actions was the release of the ex-ministers of Charles X., and he had to deal with the disputes with Switzerland and with the Strassburg coup of Louis Napoleon. He withdrew the French garrison from Ancona, but pursued an active policy in Mexico and in Algeria. Personal and political differences rapidly arose between Molé and his chief colleague Guizot, and led to an open rupture in March 1837 in face of the general opposition to a grant to the duc de Nemours. After some attempts to secure a new combination Molé reconstructed his ministry in April, Guizot being excluded. The general election in the autumn gave him no fresh support in the Chamber of Deputies, while he had now to face a formidable coalition between Guizot, the Left Centre under Thiers, and politicians of the Dynastic Left and the Republican Left. Molé, supported by Louis Philippe, held his ground against the general hostility until the beginning of 1839, when, after acrid discussions on the address, the chamber was dissolved. The new house showed little change in the strength of parties, but Molé resigned on the 31st of March 1839. A year later he entered the Academy, and though he continued to speak frequently he took no important share in party politics. Louis Philippe sought his help in his vain efforts to form a ministry in February 1848. After the revolution he was deputy for the Gironde to the Constituent Assembly, and in 1849 to the Legislative Assembly, where he was one of the leaders of the Right until the *coup d'état* on the 2nd of December 1851 drove him from public life. He died at Champlâtreux (Seine-et-Oise) on the 23rd of November 1855.

See P. Thureau-Dangin, *Histoire de la monarchie de juillet* (1884-1892); and Robert Cougny, *Dict. des parlementaires français* (1891).

MOLÉ, MATHIEU (1584-1656), French statesman, son of Edouard Molé (d. 1614), who was for a time *procureur-général*, was educated at the university of Orleans. Admitted *conseiller* in 1606, he was *président aux requêtes* in 1610, *procureur-général* in succession to Nicolas de Bellèvre in 1614, and he took part in the assembly of the Notables summoned at Rouen in 1617. He fought in vain against the setting up of special tribunals, or commissions, to try prisoners charged with political offences, and for his persistence in the case of the brothers Louis and Michel de Fontenille he was suspended in 1631, and ordered to appear at Montaigne in his own defence. Hitherto Molé's relations with Richelieu had been fairly good, but his inclination to the doctrines of Port Royal increased the differences between them, and it was not until after Richelieu's death that he was able to secure the release of his friend, the abbé de St Cyran. In 1641 he was appointed first president of the parlement, with the preliminary condition that he should not permit the general assembly of the chambers except by express order of the king. After Richelieu's death the pretensions of the parlement increased; the hereditary magistrature arrogated to itself the functions of the states-general, and in 1648 the parlement with the other sovereign courts (the *cour des aides*, the *grand conseil*, and the *cour des comptes*) met in one assembly and proposed for the royal sanction twenty-seven articles, which amounted in substance to a new constitution. In the long conflict between Anne of Austria and the parlement, Molé, without yielding the rights of the parlement, played a conciliatory part. In the popular tumult known as the day of the barricades (Aug. 26, 1648) he sought out Mazarin and the queen to demand the release of Pierre Broussel and his colleagues, whose seizure had been the original cause of the outbreak. Next day the parlement marched in procession to repeat Molé's demand. On their way back they were stopped by the crowd. "Turn, traitor," said one of the rebels to Molé, seizing him by the beard, "and unless you wish to be massacred, either bring back Broussel, or bring Mazarin as a hostage." Many magistrates fled; the remnant, headed by the intrepid Molé, returned to the Palais Royal, where Anne of Austria was induced to release the prisoners.

Molé's moderating counsels failed to prevent the outbreak of the first Fronde, but he negotiated the peace of Rueil in 1651, and averted a conflict between the partisans of Condé and of the Cardinal de Retz within the precincts of the Palais de Justice. He refused honours and rewards for himself or his family, but became keeper of the seals, in which capacity he was compelled to follow the court, and he therefore retired from the presidency of the parlement. He died on the 3rd of January 1656.

The *Mémoires* of Molé were edited for the Société de l'histoire de France (4 vols., 1855) by Aimé Champollion-Figeac, and his life was written by Baron A. G. P. de Barante in *Le Parlement et la Fronde* (1859). See also the memoirs of Omer Talon and of De Retz.

MOLE. (1) A small animal of the family *Talpidae* (see below). (2) A mark, or stain, and particularly a dark-coloured raised spot on the human skin. This word, O. Eng. *mól*, appears in such forms as *meil* or *mail*, in old forms of Teutonic languages, and in *mel*, a sign; cf. Ger. *Denkmal*, a monument. It is probably cognate with Lat. *maculus*, spot. Its meaning of stain is seen in the corrupted form "iron-mould," properly "iron-mole," a stain produced on linen or cloth by rust or ink. (3) A large structure of rubble, stone or other material, used as a breakwater or pier (see *BREAKWATER*), or the space of water so enclosed, forming a harbour or anchorage. This word comes through the French from Lat. *mole*, a mass, large structure. The name of the "Mole of Hadrian" (*mole*s *Hadriani*) is sometimes given to the mausoleum of that emperor, now the castle of St Angelo at Rome.

In zoology the name of *mole* (a contracted form of mould-warp, i.e. mould-caster), is properly applicable to the common mole (*Talpa europæa*), a small, soft-furred, burrowing mammal, with minute eyes, and broad fossorial fore-feet, belonging to the order Insectivora and the family *Talpidae*. In a wider sense may be included under the same term the other Old World moles, the North American star-nosed and other moles, and the

African golden moles of the family *Chrysochloridae*. In a still wider sense the name is applied to the Asiatic zokors and the African strand-moles, belonging to the order Rodentia, as well as to the Australian marsupial mole.

The common mole is an animal about six inches in length, with a tail of one inch. The body is long and cylindrical, and, owing to the forward position of the front limbs, the head appears to rest between the shoulders; the muzzle is long and obtusely pointed, terminated by the nostrils, which are close together in front; the minute eye is almost hidden by the fur; the ear is without a conch, opening on a level with the surrounding skin; the fore-limbs are rather short and very muscular, terminating in broad, naked, shovel-shaped feet, the palms normally directed outwards, each with five sub-equal digits armed with strong flattened claws; the hind-feet, on the contrary, are long and narrow; and the toes are provided with slender claws. The body is densely covered with soft, erect, velvety fur—the hairs uniform in length and thickness, except on the muzzle and short tail, the former having some straight bristles on its sides, whilst the latter is clothed with longer and coarser hairs. The fur is generally black, with a more or less greyish tinge, or brownish-black, but various paler shades up to pure white have been observed.

The food of the mole consists chiefly of earthworms, in pursuit of which it forms its well-known underground excavations. The mole is one of the most voracious of mammals, and, if deprived of food, is said to succumb in from ten to twelve hours. Almost any kind of flesh is eagerly devoured by captive moles, which have been seen, as if maddened by hunger, to attack animals nearly as large as themselves, such as birds, lizards, frogs, and even snakes; toads, however, they will not touch, and no form of vegetable food attracts their notice. If two moles be confined together without food, the weaker is invariably devoured by the stronger. Moles take readily to the water—in this respect, as well as in external form, resembling their North American representatives. Bruce, writing in 1793, remarks that he saw a mole paddling towards a small island in the Loch of Clunie, 180 yds. from land, on which he noticed molehills.

The sexes come together about the second week in March, and the young—generally from four to six in number—which are brought forth in about six weeks, quickly attain their full size.

Much misconception has prevailed with regard to the structure of the mole's "fortress," i.e. the large breeding hillock, which is generally placed in bushes, or amid the roots of a tree; but a trustworthy account, by Mr L. E. Adams, will be found in the *Memoirs of the Manchester Literary and Philosophical Society for 1903*, vol. xviii., pt. 2.

The geographical distribution of the mole exceeds that of all the other species of the genus taken together. It extends from England to Japan, and from the Dovre-Fjeld Mountains in Scandinavia and the Middle Dvina region in Russia to southern Europe and the southern slopes of the Himalaya, where it occurs at an elevation of 10,000 ft. In Great Britain it is found as far north as Caithness, but in Ireland and in the Western Isles of Scotland (except Mull) it is unknown. (See INSECTIVORA.) (G. E. D.; R. L. *)

MOLECULE (from mod. Lat. *molecula*, the diminutive of *mole*, a mass), in chemistry and physics, the minutest particle of matter capable of separate existence. The word appears to have been invented during the 17th century, and remained synonymous with "atom" (Gr. *ἄτομος*, from *α-*, privative, and *τέμνω*, to cut) until the middle of the 19th century, when a differentiation was established. "Atom" has mainly a chemical import, being defined as the smallest particle of matter which can take part in a chemical reaction; a "molecule" is composed of atoms, generally two or more. For the detailed chemical significance of these terms, see CHEMISTRY; and for the atomic theory of the chemist (as distinguished from the atomic or molecular theory of the physicist) see ATOM; reference may also be made to the article MATTER.

The doctrine that matter can be divided into, or regarded as composed of, discrete particles (termed "atoms" by early writers, and "molecules" by modern ones) has at all times played an important part in metaphysics and natural science.

The leading historical stages in the evolution of the modern conception of the molecular structure of matter are treated in the following passage from James Clerk Maxwell's article ATOM in the 9th edition of the *Ency. Brit.*

"Atom" (*ἄτομος*) is a body which cannot be cut in two. The atomic theory is a theory of the constitution of bodies which asserts that they are made up of atoms. The opposite theory is that of the homogeneity and continuity of bodies, and asserts, at least in the case of bodies having no apparent organization, such, for instance, as water, that as we can divide a drop of water into two parts which are each of them drops of water, so we have reason to believe that these smaller drops can be divided again, and the theory goes on to assert that there is nothing in the nature of things to hinder this process of division from being repeated over and over again, times without end. This is the doctrine of the infinite divisibility of bodies, and it is in direct contradiction with the theory of atoms.

"The atomists assert that after a certain number of such divisions the parts would be no longer divisible, because each of them would be an atom. The advocates of the continuity of matter assert that the smallest conceivable body has parts, and that whatever has parts may be divided.

"In ancient times Democritus was the founder of the atomic theory, while Anaxagoras propounded that of continuity, under the name of the doctrine of homoeomeria (*ὁμοιομερία*), or of the similarity of the parts of a body to the whole. The arguments of the atomists, and their replies to the objections of Anaxagoras, are to be found in Lucretius.

"In modern times the study of nature has brought to light many properties of bodies which appear to depend on the magnitude and motions of their ultimate constituents, and the question of the existence of atoms has once more become conspicuous among scientific inquiries.

"We shall begin by stating the opposing doctrines of atoms and of continuity. The most ancient philosophers whose speculations are known to us seem to have discussed the ideas of number and of continuous magnitude, of space and time, of matter and motion, with a native power of thought which has probably never been surpassed. Their actual knowledge, however, and their scientific experience were necessarily limited, because in their days the records of human thought were only beginning to accumulate. It is probable that the first exact notions of quantity were founded on the consideration of number. It is by the help of numbers that concrete quantities are practically measured and calculated. Now, number is discontinuous. We pass from one number to the next *per saltum*. The magnitudes, on the other hand, which we meet with in geometry, are essentially continuous. The attempt to apply numerical methods to the comparison of geometrical quantities led to the doctrine of incommensurables, and to that of the infinite divisibility of space. Meanwhile, the same considerations had not been applied to time, so that in the days of Zeno of Elea time was still regarded as made up of a finite number of 'moments,' while space was confessed to be divisible without limit. This was the state of opinion when the celebrated arguments against the possibility of motion, of which that of Achilles and the tortoise is a specimen, were propounded by Zeno, and such, apparently, continued to be the state of opinion till Aristotle pointed out that time is divisible without limit, in precisely the same sense that space is. And the slowness of the development of scientific ideas may be estimated from the fact that Bayle does not see any force in this statement of Aristotle, but continues to admire the paradox of Zeno (Bayle's *Dictionary*, art. 'Zeno'). Thus the direction of true scientific progress was for many ages towards the recognition of the infinite divisibility of space and time.

"It was easy to attempt to apply similar arguments to matter. If matter is extended and fills space, the same mental operation by which we recognize the divisibility of space may be applied, in imagination at least, to the matter which occupies space. From this point of view the atomic doctrine might be regarded as a relic of the old numerical way of conceiving magnitude, and the opposite doctrine of the infinite divisibility of matter might appear for a time the most scientific. The atomists, on the other hand, asserted very strongly the distinction between matter and space. The atoms, they said, do not fill up the universe; there are void spaces between them. If it were not so, Lucretius tells us, there could be no motion, for the atom which gives way first must have some empty place to move into.

'Quapropter locus est intactus, inane, vacansque
Quod si non esset, nulla ratione moveri
Res possent; namque, officium quod corporis exstat,
Officere atque obstare, id in omni tempore adesset
Omnibus: haud igitur quicquam procedere posset,
Principium quoniam cedendi nulla daret res.'

De rerum natura, i. 335.

"The opposite school maintained then, as they have always done,

"It will be noted that Clerk Maxwell's "atom" and "atomic theory" have the significance which we now attach to "molecule" and "molecular theory."

that there is no vacuum—that every part of space is full of matter, that there is a universal plenum, and that all motion is like that of a fish in the water, which yields in front of the fish because the fish leaves room for it behind.

'Cedere squamigeris latices nitentibus aiunt
Et liquidas aperire vias, quia post loca pisces
Linqunt, quo possint cedentes confluere undae.'

Ibid. i. 373.

"In modern times Descartes held that, as it is of the essence of matter to be extended in length, breadth and thickness, so it is of the essence of extension to be occupied by matter, for extension cannot be an extension of nothing.

"Ac proinde si quaeratur quid fiet, si Deus auferat omne corpus quod in aliquo vase continetur, et nullum alium in ablati locum venire permittat? respondendum est, vasis latera sibi invicem hoc ipso fore contigua. Cum enim inter duos corpora nihil interjacet, necesse est ut se mutuo tangant, ac manifeste repugnat ut distent, sive ut inter ipsa sit distantia, et tamen ut ista distantia sibi nihil; quia omnis distantia est motus extensionis, et ideo sine substantia extensa esse non potest.—*Principia*, ii. 18.

"This identification of extension with substance runs through the whole of Descartes's works, and it forms one of the ultimate foundations of the system of Spinoza. Descartes, consistently with this doctrine, denies the existence of atoms as parts of matter, which by their own nature are indivisible. He seems to admit, however, that the Deity might make certain particles of matter indivisible in this sense, that no creature should be able to divide them. These particles, however, would be still divisible by their own nature, because the Deity cannot diminish his own power, and therefore must retain his power of dividing them. Leibniz, on the other hand, regarded his monad as the ultimate element of everything.

"There are thus two modes of thinking about the constitution of bodies, which have had their adherents both in ancient and in modern times. They correspond to the two methods of regarding quantity—the arithmetical and the geometrical. To the atomist the true method of estimating the quantity of matter in a body is to count the atoms of it. The void spaces between the atoms count for nothing. To those who identify matter with extension, the volume of space occupied by a body is the only measure of the quantity of matter in it.

"Of the different forms of the atomic theory that of R. J. Bosovich may be taken as an example of the purest monadism. According to Bosovich matter is made up of atoms. Each atom is an indivisible point, having position in space, capable of motion in a continuous path, and possessing a certain mass, whereby a certain amount of force is required to produce a given change of motion. Besides this the atom is endowed with potential force, that is to say, that any two atoms attract or repel each other with a force depending on their distance apart. The law of this force, for all distances greater than say the thousandth of an inch, is an attraction varying as the inverse square of the distance. For smaller distances the force is an attraction for one distance and a repulsion for another, according to some law not yet discovered. Bosovich himself, in order to obviate the possibility of two atoms ever being in the same place, asserts that the ultimate force is a repulsion which increases without limit as the distance diminishes without limit, so that two atoms can never coincide. But this seems an unwarrantable concession to the vulgar opinion that two bodies cannot co-exist in the same place. This opinion is deduced from our experience of the behaviour of bodies of sensible size, but we have no experimental evidence that two atoms may not sometimes coincide. For instance, if oxygen and hydrogen combine to form water, we have no experimental evidence that the molecule of oxygen is not in the very same place with the two molecules of hydrogen. Many persons cannot get rid of the opinion that all matter is extended in length, breadth and depth. This is a prejudice of the same kind which arises from our experience of bodies consisting of immense multitudes of atoms. The system of atoms, according to Bosovich, occupies a certain region of space in virtue of the forces acting between the component atoms of the system and any other atoms when brought near them. No other system of atoms can occupy the same region of space at the same time, because before it could do so the mutual action of the atoms would have caused a repulsion between the two systems insuperable by any force which we can command. Thus, a number of soldiers with firearms may occupy an extensive region to the exclusion of the enemy's armies, though the space filled by their bodies is but small. In this way Bosovich explained the apparent extension of bodies consisting of atoms, each of which is devoid of extension. According to Bosovich's theory, all action between bodies is action at a distance. There is no such thing in nature as actual contact between two bodies. When two bodies are said in ordinary language to be in contact, all that is meant is that they are so near together that the repulsion between the nearest parts of atoms belonging to the two bodies is very great.

"Thus, in Bosovich's theory, the atom has continuity of existence in time and space. At any instant of time it is at some point of space, and it is never in more than one place at a time. It passes from one place to another along a continuous path. It has a definite

mass which cannot be increased or diminished. Atoms are endowed with the power of acting on one another by attraction or repulsion, the amount of the force depending on the distance between them. On the other hand, the atom itself has no parts or dimensions. In its geometrical aspect it is a mere geometrical point. It has no extension in space. It has not the so-called property, of Impenetrability, for two atoms may exist in the same place. This we may regard as one extreme of the various opinions about the constitution of bodies.

"The opposite extreme, that of Anaxagoras—the theory that bodies apparently heterogeneous and continuous are so in reality—is, in its extreme form, a theory incapable of development. To explain the properties of any substance by this theory is impossible. We can only admit the observed properties of such substance as ultimate facts. There is a certain stage, however, of scientific progress in which a method corresponding to this theory is of service. In hydrostatics, for instance, we define a fluid by means of one of its known properties, and from this definition we make the system of deductions which constitutes the science of hydrostatics. In this way the science of hydrostatics may be built upon an experimental basis, without any consideration of the constitution of a fluid as to whether it is molecular or continuous. In like manner, after the French mathematicians had attempted, with more or less ingenuity, to construct a theory of solids from the hypothesis that they consist of atoms in equilibrium under the action of their mutual forces, Stokes and others showed that all the results of this hypothesis, so far at least as they agreed with facts, might be deduced from the postulate that elastic bodies exist, and from the hypothesis that the smallest portions into which we can divide them are sensibly homogeneous. In this way the principle of continuity, which is the basis of the method of Fluxions and the whole of modern mathematics, may be applied to the analysis of problems connected with material bodies by assuming them, for the purpose of this analysis, to be homogeneous. All that is required to make the results applicable to the real case is that the smallest portions of the substance of which we take any notice shall be sensibly of the same kind. Thus, if a railway contractor had to make a tunnel through a hill of gravel, and if one cubic yard of the gravel is so like another cubic yard that for the purposes of the contract they may be taken as equivalent, then, in estimating the work required to remove the gravel from the tunnel, he may, without fear of error, make his calculations as if the gravel were a continuous substance. But if a worm has to make his way through the gravel, it makes the greatest possible difference to him whether he tries to push right against a piece of gravel, or directs his course through one of the intervals between the pieces; to him, therefore, the gravel is by no means a homogeneous and continuous substance.

In the same way, a theory that some particular substance, say water, is homogeneous and continuous may be a good working theory up to a certain point, but may fail when we come to deal with quantities so minute or so attenuated that their heterogeneity of structure comes into prominence. Whether this heterogeneity of structure is or is not consistent with homogeneity and continuity of substance is another question.

"The extreme form of the doctrine of continuity is that stated by Descartes, who maintains that the whole universe is equally full of matter, and that this matter is all of one kind, having no essential property besides that of extension. All the properties which we perceive in matter he reduces to its parts being movable among one another, and so capable of all the varieties which we can perceive to follow from the motion of its parts (*Principia*, ii. 23). Descartes's own attempts to deduce the different qualities and actions of bodies in this way are not of much value. More than a century was required to invent methods of investigating the conditions of the motion of systems of bodies such as Descartes imagined. But the hydrodynamical discovery of Helmholtz that a vortex in a perfect liquid possesses certain permanent characteristics has been applied by Sir W. Thomson (Lord Kelvin) to form a theory of vortex atoms in a homogeneous, incompressible and frictionless liquid."

THE MOLECULAR STRUCTURE OF MATTER

An enormous mass of experimental evidence now shows quite conclusively that matter cannot be regarded as having a continuous structure, but that it is ultimately composed of discrete parts. The smallest unit of matter with which physical phenomena are concerned is the *molecule*. When chemical phenomena occur the molecule may be divided into *atoms*, and these atoms, in the presence of electrical phenomena, may themselves be further divided into *electrons* or *corpuscles*. It ought accordingly to be possible to explain all the non-electrical and non-chemical properties of matter by treating matter as an aggregation of molecules. In point of fact it is found that the properties which are most easily explained are those connected with the gaseous state; the explanation of these properties in terms of the molecular structure of matter is the aim of the "Kinetic Theory of Gases." The results of this theory have placed the molecular

conception of matter in an indisputable position, but even without this theory there is such an accumulation of electrical and optical evidence in favour of the molecular conception of matter that the tenability of this conception could not be regarded as open to question.

The Scale of Molecular Structure.—Apart from speculation, the first definite evidence for the molecular structure of matter occurs when it is found that certain physical phenomena change their whole nature as soon as we deal with matter of which the linear dimensions are less than a certain amount. As a single instance of this may be mentioned some experiments of Lord Rayleigh (*Proc. Roy. Soc.*, 1890, 47, p. 364), who found that a film of olive oil spread over the surface of water produced a perceptible effect on small floating pieces of camphor, at places at which the thickness of the film was 10.6×10^{-8} cms., but produced no perceptible effect at all at places where the thickness of the film was 8.1×10^{-8} cms. Thus a certain phenomenon, of the nature of capillary action, is seen to depend for its existence on the linear dimensions of the film of oil; the physical properties of a film of thickness 10.6×10^{-8} cms. are found to be in some way qualitatively different from those of a film of thickness 8.1×10^{-8} cms. Here is proof that the film of oil is not a continuous homogeneous structure, and we are led to suspect that the scale on which the structure is formed has a unit of length comparable with 8×10^{-8} cms. The probability of this conjecture is strengthened when it is discovered that in all phenomena of this type the critical length connected with the stage at which the phenomenon changes its nature is of the order of magnitude of 10^{-8} cms.

Lord Rayleigh (*Phil. Mag.* 1890 [5], 30, p. 474) has pointed out that the earliest known attempt to estimate the size of molecules, made by Thomas Young in 1805, was based upon the consideration of phenomena of the kind just mentioned. Discussing the theory of capillary attractions, Young¹ found that at a rough estimate "the extent of the cohesive force must be limited to about the 250-millionth of an inch" ($= 10^{-8}$ cms.), and then argues that "within similar limits of uncertainty we may obtain something like a conjectural estimate of the mutual distance of the particles of vapours, and even of the actual magnitude of the elementary atoms of liquids. . . . It appears tolerably safe to conclude that, whatever errors may have affected the determination, the diameter or distance of the particles of water is between the two thousand and the ten thousand millionth of an inch" ($=$ between $.125 \times 10^{-8}$ and $.025 \times 10^{-8}$ cms.).

The best estimates which we now possess of the sizes of molecules are provided by calculations based upon the kinetic theory of gases. In the following table are given the values of the diameters of the molecules of six substances with which it is easy to experiment in the gaseous state, these values being calculated in different ways from formulae supplied by the kinetic theory.

Gas.	Diameter calculated by the kinetic theory of gases.				Mean value.
	From deviations from Boyle's law.	From coefficient of viscosity.	From coefficient of conduction of heat.	From coefficient of diffusion.	
Hydrogen	2.05×10^{-8}	2.05×10^{-8}	1.99×10^{-8}	2.02×10^{-8}	2.03×10^{-8}
Carbon monoxide	—	2.90×10^{-8}	2.74×10^{-8}	2.92×10^{-8}	2.85×10^{-8}
Nitrogen	3.12×10^{-8}	2.90×10^{-8}	2.74×10^{-8}	—	2.92×10^{-8}
Air	2.90×10^{-8}	2.86×10^{-8}	2.72×10^{-8}	—	2.83×10^{-8}
Oxygen	—	2.81×10^{-8}	2.58×10^{-8}	2.70×10^{-8}	2.70×10^{-8}
Carbon dioxide	3.00×10^{-8}	3.47×10^{-8}	3.58×10^{-8}	3.28×10^{-8}	3.33×10^{-8}

The agreement of the values obtained for the same quantity by different methods provides valuable confirmation of the truth of the molecular theory and of the validity of the methods of the kinetic theory of gases. That the results do not agree even

better need not cause surprise when it is stated that the quantities are calculated on the hypothesis that the molecules are spherical in shape. This hypothesis is introduced for the sake of simplicity, but is known to be unjustifiable in fact. What is given by the formulae is accordingly the mean radius of an irregularly shaped solid (or, more probably, of the region in which the field of force surrounding such a solid is above a certain intensity), and the mean has to be taken in different ways in the different phenomena. This and the difficulty of obtaining accurate experimental results fully account for the differences *inter se* in the values of the quantities calculated.

Heat a Manifestation of Molecular Motion.—An essential feature of the modern view of the structure of matter is that the molecules are supposed to be in rapid motion relatively to one another. We are led to this conception by a number of experimental results, some of which will be mentioned later. We are compelled also to suppose that the motion assumes different forms in different substances. Roughly speaking, it is found that there are three main types of molecular motion corresponding to the three states of matter—solid, liquid and gaseous. That the distances traversed by the molecules of a solid are very small in extent is shown by innumerable facts of everyday observation, as for instance, the fact that the surface of a finely-carved metal (such as a plate used for steel engraving) will retain its exact shape for centuries, or again, the fact that when a metal body is coated with gold-leaf the molecules of the gold remain on its surface indefinitely: if they moved through any but the smallest distances they would soon become mixed with the molecules of the baser metal and diffused through its interior. Thus the molecules of a solid must make only small excursions about their mean positions. In a gas the state of things is very different; an odour is known to spread rapidly through great distances, even in the stillest air, and a gaseous poison or corrosive will attack not only those objects which are in contact with its source but also all those which can be reached by the motion of its molecules.

As a preliminary to examining further into the nature of molecular motion and the differences of character of this motion, let us try to picture the state of things which would exist in a mass of solid matter in which all the molecules are imagined to be at rest relatively to one another. The fact that a solid body in its natural state is capable both of compression and of dilatation indicates that the molecules of the body must not be supposed to be fixed rigidly in position relative to one another; the further fact that a motion of either compression or of dilatation is opposed by forces which are brought into play in the interior of the solid suggests that the position of rest is one in which the molecules are in stable equilibrium under their mutual forces. Such a mass of imaginary matter as we are now considering may be compared to a collection of heavy particles held in position relatively to one another by a system of light spiral springs, one spring being supposed to connect each pair of adjacent particles. Let two such masses of matter be suspended by strings from the same point, and then let one mass be drawn aside, pendulum-wise, and allowed to impinge on the other. After impact the two masses will rebound, and the process may be repeated any number of times, but ultimately the two masses will be found again hanging in contact side by side. At the first impact each layer of surface molecules which takes the shock of the impact will be thrust back upon the layer behind it: this layer will in this way be set into motion and so influence the layer still further behind; and so on indefinitely. The impact will accordingly result in all the molecules being set into motion, and by the time that the masses have ceased impinging on one another the molecules of which they are composed will be performing oscillations about their positions of equilibrium. The kinetic energy with which the moving mass originally impinged on that at rest is now represented by the energy, kinetic and potential, of the small motions of the

¹ "On the Cohesions of Fluids," *Phil. Trans.* (1805); Young's *Coll. Works*, l. 461.

individual molecules. It is known, however, that when two bodies impinge, the kinetic energy which appears to be lost from the mass-motion of the bodies is in reality transformed into heat-energy. Thus the molecular theory of matter, as we have now pictured it, leads us to identify heat-energy in a body with the energy of motion of the molecules of the body relatively to one another. A body in which all the molecules were at rest relatively to one another would be a body devoid of heat. This conception of the nature of heat leads at once to an absolute zero of temperature—a temperature of no heat-motion—which is identical, as will be seen later, with that reached in other ways, namely, about -273°C .

The point of view which has now been gained enables us to interpret most of the thermal properties of solids in terms of molecular theory. Suppose for instance that two bodies, both devoid of heat, are placed in contact with one another, and that the surface of the one is then rubbed over that of the other. The molecules of the two surface-layers will exert forces upon one another, so that, when the rubbing takes place, each layer will set the molecules of the other into motion, and the energy of rubbing will be used in establishing this heat-motion. In this we see the explanation of the phenomenon of the generation of heat by friction. At first the heat-motion will be confined to molecules near the rubbing surfaces of the two bodies, but, as already explained, these will in time set the interior molecules into motion, so that ultimately the heat-motion will become spread throughout the whole mass. Here we have an instance of the conduction of heat.¹ When the molecules are oscillating about their equilibrium positions, there is no reason why their mean distance apart should be the same as when they are at rest. This leads to an interpretation of the fact that a change of dimensions usually attends a change in the temperature of a substance. Suppose for instance that two molecules, when at rest in equilibrium, are at a distance a apart. It is very possible that the repulsive force they exert when at a distance $a - \epsilon$ may be greater than the attractive force they exert when at a distance $a + \epsilon$. If so, it is clear that their mean distance apart, averaged through a sufficiently long interval of their motion, will be greater than a . A body made up of molecules of this kind will expand on heating.

As the temperature of a body increases the average energy of the molecules will increase, and therefore the range of their excursions from their positions of equilibrium will increase also. At a certain temperature a stage will be reached in which it is a frequent occurrence for a molecule to wander so far from its position of equilibrium, that it does not return but falls into a new position of equilibrium and oscillates about this. When the body is in this state the relative positions of the molecules are not permanently fixed, so that the body is no longer of unalterable shape: it has assumed a plastic or molten condition. The substance attains to a perfectly liquid state as soon as the energy of motion of the molecules is such that there is a constant rearrangement of position among them.

A molecule escaping from its original position in a body will usually fall into a new position in which it will be held in equilibrium by the forces from a new set of neighbouring molecules. But if the wandering molecule was originally close to the surface of the body, and if it also happens to start off in the right direction, it may escape from the body altogether and describe a free path in space until it is checked by meeting a second wandering molecule or other obstacle. The body is continually losing mass by the loss of individual molecules in this way, and this explains the process of evaporation. Moreover, the molecules which escape are, on the whole, those with the greatest energy. The average energy of the molecules of the liquid is accordingly lowered by evaporation. In this we see the explanation of the fall of temperature which accompanies evaporation.

When a liquid undergoing evaporation is contained in a closed vessel, a molecule which has left the liquid will, after a certain

number of collisions with other free molecules and with the sides of the vessel, fall back again into the liquid. Thus the process of evaporation is necessarily accompanied by a process of recondensation. When a stage is reached such that the number of molecules lost to the liquid by evaporation is exactly equal to that regained by condensation, we have a liquid in equilibrium with its own vapour. If the whole liquid becomes vaporized before this stage is attained, a state will exist in which the vessel is occupied solely by free molecules, describing paths which are disturbed only by encounters with other free molecules or the sides of the vessel. This is the conception which the molecular theory compels us to form of the gaseous state.

At normal temperature and pressure the density of a substance in the gaseous state is of the order of one-thousandth of the density of the same substance in the solid or liquid state. It follows that the average distance apart of the molecules in the gaseous state is roughly ten times as great as in the solid or liquid state, and hence that in the gaseous state the molecules are at distances apart which are large compared with their linear dimensions. (If the molecules of air at normal temperature and pressure were arranged in cubic order, the edge of each cube would be about 2.9×10^{-7} cms.; the average diameter of a molecule in air is 2.8×10^{-8} cms.) Further and very important evidence as to the nature of the gaseous state of matter is provided by the experiments of Joule and Kelvin. These experiments showed that the change in the temperature of a gas, consequent on its being allowed to stream out into a vacuum, is in general very slight. In terms of the molecular theory this indicates that the total energy of the gas is the sum of the separate energies of its different molecules: the potential energy arising from intermolecular forces between pairs of molecules may be treated as negligible when the matter is in the gaseous state.

These two simplifying facts bring the properties of the gaseous state of matter within the range of mathematical treatment. The kinetic theory of gases attempts to give a mathematical account, in terms of the molecular structure of matter, of all the non-chemical and non-electrical properties of gases. The remainder of this article is devoted to a brief statement of the methods and results of the kinetic theory. No attempt will be made to follow the historic order of development, but the present theory will be set out in its most logical form and order.

The Kinetic Theory of Gases.

A number of molecules moving in obedience to dynamical laws will pass through a series of configurations which can be, theoretically determined as soon as the structure of each molecule and the initial position and velocity of every part of it are known. The determination of the series of configurations developing out of given initial conditions is not, however, the problem of the kinetic theory: the object of this theory is to explain the general properties of all gases in terms only of their molecular structure. We are therefore called upon, not to trace the series of configurations of any single gas, starting from definite initial conditions, but to search for features and properties common to all series of configurations, independently of the particular initial conditions from which the gas may have started.

We begin with a general dynamical theorem, whose special application, when the dynamical system is generalized with a gas, will appear later. Let q_1, q_2, \dots, q_n be the generalized co-ordinates of any dynamical system, and let p_1, p_2, \dots, p_n **Dynamical Basis.** be the corresponding momenta. If the system is supposed to obey the conservation of energy and to move solely under its own internal forces, the changes in the co-ordinates and momenta can be found from the Hamiltonian equations

$$\frac{\partial E}{\partial p_r} = \dot{q}_r, \quad \dot{p}_r = -\frac{\partial E}{\partial q_r} \quad (1)$$

where \dot{q}_r denotes dq_r/dt , &c., and E is the total energy expressed as a function of $p_1, q_1, \dots, p_n, q_n$. When the initial values of $p_1, q_1, \dots, p_n, q_n$ are given, the motion can be traced completely from these equations.

Let us suppose that an infinite number of exactly similar systems start simultaneously from all possible values of $p_1, q_1, \dots, p_n, q_n$, each moving solely under its own internal forces, and therefore in accordance with equations (1). Let us confine our attention to those

¹ Other processes also help in the conduction of heat, especially in substances which are conductors of electricity.

systems for which the initial values of $p_1, q_1, \dots, p_n, q_n$ lie within a range such that

$$p_1 \text{ is between } p_1 \text{ and } p_1 + dp_1 \\ q_1 \text{ ,, ,, } q_1 \text{ ,, } q_1 + dq_1, \text{ and so on.}$$

Let the product $dp_1 dq_1 \dots dp_n dq_n$ be spoken of as the "extension" of this range of values.

After a time dt the value of p_1 will have increased to $p_1 + \dot{p}_1 dt$, where \dot{p}_1 is given by equations (1), and there will be similar changes in $q_1, p_2, q_2, \dots, q_n$. Thus after a time dt the values of the co-ordinates and momenta of the small group of systems under consideration will lie within a range such that

$$p_1 \text{ is between } p_1 + \dot{p}_1 dt \text{ and } p_1 + \dot{p}_1 dt + \left(\dot{p}_1 + \frac{\partial \dot{p}_1}{\partial p_1} dp_1 \right) dt \\ q_1 \text{ ,, ,, } q_1 + \dot{q}_1 dt \text{ ,, } q_1 + \dot{q}_1 dt + \left(\dot{q}_1 + \frac{\partial \dot{q}_1}{\partial q_1} dq_1 \right) dt,$$

and so on. Thus the extension of the range after the interval dt is

$$dp_1 \left(1 + \frac{\partial \dot{p}_1}{\partial p_1} dt \right) dq_1 \left(1 + \frac{\partial \dot{q}_1}{\partial q_1} dt \right) \dots$$

or, expanding as far as first powers of dt ,

$$dp_1 dq_1 \dots dp_n dq_n \left\{ 1 + \sum_i \left(\frac{\partial \dot{p}_i}{\partial p_i} + \frac{\partial \dot{q}_i}{\partial q_i} \right) dt \right\}.$$

From equations (1), we find that

$$\frac{\partial \dot{p}_1}{\partial p_1} + \frac{\partial \dot{q}_1}{\partial q_1} = 0,$$

so that the extension of the new range is seen to be $dp_1 dq_1 \dots dp_n dq_n$, and therefore equal to the initial extension. Since the values of the co-ordinates and momenta at any instant during the motion may be treated as "initial" values, it is clear that the "extension" of the range must remain constant throughout the whole motion.

This result at once disposes of the possibility of all the systems acquiring any common characteristic in the course of their motion through a tendency for their co-ordinates or momenta to concentrate about any particular set, or series of sets, of values. But the result goes further than this. Let us imagine that the systems had the initial values of their co-ordinates and momenta so arranged that the number of systems for which the co-ordinates and momenta were within a given range was proportional simply to the extension of the range. Then the result proves that the values of the co-ordinates and momenta remain distributed in this way throughout the whole motion of the systems. Thus, if there is any characteristic which is common to all the systems after the motion has been in progress for any interval of time, this same characteristic must equally have been common to all the systems initially. It must, in fact, be a characteristic of all possible states of the systems.

It is accordingly clear that there can be no property common to all systems, but it can be shown that when the system contains a gas (or any other aggregation of similar molecules) as part of it there are properties which are common to all possible states, except for a number which form an insignificant fraction of the whole. These properties are found to account for the physical properties of gases.

Let the whole energy E of the system be supposed equal to $E_1 + E_n$, where E_2 is of the form

$$E_2 = \frac{1}{2} \sum (mu^2 + mv^2 + mw^2 + a_1 \theta_1^2 + a_2 \theta_2^2 + \dots + a_n \phi_n^2) \\ + \frac{1}{2} \sum (m'u'^2 + m'v'^2 + m'w'^2 + \beta_1 \phi_1^2 + \beta_2 \phi_2^2 + \dots + \beta_n \phi_n^2) \quad (2)$$

where $\theta_1, \theta_2, \dots, \theta_n$ and similarly $\phi_1, \phi_2, \dots, \phi_n$ are any momenta or functions of the co-ordinates and momenta or co-ordinates alone which are subject only to the condition that they do not enter into the coefficients $a_1, a_2, \dots, \&c.$

In this expression the first line may be supposed to represent the energy (or part of the energy) of a similar molecule of a kind which we shall call the first kind, the terms $\frac{1}{2}(mu^2 + mv^2 + mw^2)$ being the kinetic energy of translation, and the remaining terms arising from energy of rotation or of internal motion, or from the energy, kinetic and potential, of small vibrations. The second line in E_2 will represent the energy (or part of the energy) of s' similar molecules of the second kind, and so on. It is not at present necessary to suppose that the molecules are those of substances in the gaseous state. Considering only those states of the system which have a given value of E_2 , it can be proved, as a theorem in pure mathematics,¹ that when s, s', \dots are very large, then, for all states except an infinitesimal fraction of the whole number, the values of u, v, w lie within ranges such that

(i) the values of u (and similarly of v, w) are distributed among the s molecules of the first kind according to the law of trial and error; and similarly of course for the molecules of other kinds:

$$(ii) \quad \frac{\sum \frac{1}{2} mu^2}{s} = \frac{\sum \frac{1}{2} m'v'^2}{s'} = \frac{\sum \frac{1}{2} m''w''^2}{s''} = \frac{\sum \frac{1}{2} a_1 \theta_1^2}{s} = \dots \\ = \frac{\sum \frac{1}{2} a_n \phi_n^2}{s} = \frac{\sum \frac{1}{2} \beta_1 \phi_1^2}{s'} = \dots \quad (3)$$

A state of the system in which these two properties are true will be called a "normal state"; other states will be spoken of as "abnormal." Let all possible states of the system be divided into small ranges of equal extension, and of *The Normal State*, these let a number P correspond to normal, and a number p to abnormal, states. What is proved is that, as s, s', \dots become very great, the ratio P/p becomes infinite. Considering only systems starting in the p abnormal ranges, it is clear, from the fact that the extensions of the ranges do not change with the motion, that after a sufficient time most of these systems must have passed into the P normal ranges. Speaking loosely, we may say that there is a probability $P/(P+p)$, amounting to certainty in the limit, that one of these systems, selected at random, will be in the normal state after a sufficient time has elapsed. Again, considering the systems which start from the P normal ranges, we see that there is a probability $p/(P+p)$ which vanishes in the limit, that a system selected at random from these will be in an abnormal state after a sufficient time. Thus, subject to a probability of error which is infinitesimal in the limit, we may state as general laws that—

A system starting from an abnormal state tends to assume the normal state; while

A system starting from the normal state will remain in the normal state.

It will now be found that the various properties of gases follow from the probability that the gas is in the normal state.

If each of the fractions (3) is put equal to $1/nh$, it is readily found, from the first property of the normal state, that, of the *Law of Distribution of* s molecules of the first kind, a number $\int \sqrt{h^2 m^2 / \pi^3} e^{-h^2 m^2 / 2} du dv dw$ *(4) Velocities.*

have velocities of which the components lie between u and $u+du$, v and $v+dv$, w and $w+dw$, while the corresponding number of molecules of the second kind is, similarly,

$$s' \int \sqrt{h^2 m'^2 / \pi^3} e^{-h^2 m'^2 / 2} du' dv' dw' \quad (5)$$

If c is the resultant velocity of a molecule, so that $c^2 = u^2 + v^2 + w^2$, it is readily found from formula (4) that the number of molecules of the first kind of which the resultant velocity lies between c and $c+dc$ is

$$4\pi s h^3 \sqrt{h^2 m^2 / \pi^3} e^{-h^2 m^2 c^2 / 2} dc \quad (6)$$

These formulae express the "law of distribution of velocities" in the normal state: the law is often called *Maxwell's Law of Distribution*.

If \bar{u}^2 denote the mean value of $\frac{1}{2} mu^2$ averaged over the s molecules of the first kind, equations (3) may be written in the form

$$\bar{u}^2 = \bar{u}'^2 = \bar{u}''^2 = \bar{u}^2 = \frac{1}{2} a_1 \theta_1^2 = \dots = \frac{1}{2} a_n \phi_n^2 \quad (7) \text{ Equipartition}$$

showing that the mean energy represented by each term in E_2 (formula 2) is the same. These equations *Equipartition of Energy* express the "law of equipartition of energy," commonly spoken of as the *Maxwell-Boltzmann Law*.

The law of equipartition shows that the various mean energies of different kinds are all equal, each being measured by the quantity $1/4h$. We have already seen that the mean energy increases with the temperature: it will now be supposed that the mean energy is exactly proportional to the temperature. The complete justification for this supposition will appear later: a partial justification is obtained as soon as it is seen how many physical laws can be explained by it. We accordingly put $2/5h = RT$, where T denotes the temperature on the absolute scale, and then have equations (7) in the form

$$\bar{u}^2 = \bar{u}'^2 = \dots = RT \quad (8)$$

When a system is composed of a mixture of different kinds of molecules, the fact that h is the same for each constituent [cf. formulae (5) and (6)] shows that in the normal state the different substances are all at the same temperature. For instance, if the system is composed of a gas and a boundary, some of the terms in expression (2) may be supposed to represent the kinetic energy of the molecules of the boundary, so that equations (7) show that in the normal state the gas has the same temperature as the boundary. The process of equalization of temperature is now seen to be a special form of the process of motion towards the normal state: the general laws which have been stated above in connexion with the normal state are seen to include as special cases the following laws:—

Matter originally at non-uniform temperature tends to assume a uniform temperature; while

Matter at uniform temperature will remain at uniform temperature.

It will at once be apparent that the kinetic theory of matter enables us to place the second law of thermodynamics upon a purely dynamical basis, for, but for the second law, it is not necessary to suppose the matter to be in the gaseous state. We now pass to the consideration of laws and properties which are peculiar to the gaseous state.

A simple approximate calculation of the pressure exerted by a gas on its containing vessel can be made by supposing that the molecules are so small in comparison with their distances apart that they may be treated as of infinitesimal size, *Pressure of a Gas*. Let a mixture of gases contain per unit volume ν molecules of the first kind, ν' of the second kind, and so on. Let us fix our attention on a small area dS of the boundary of the

¹ See Jeans, *Dynamical Theory of Gases* (1904), ch. v.

vessel, and let co-ordinate axes be taken such that the origin is in dS , and the axis of x is the normal at the origin into the gas. The number of molecules of the first kind of gas, whose components of velocity lie within the ranges between u and $u+du$, v and $v+dv$, and w and $w+dw$, will, by formula (5), be

$$\nu \sqrt{(h^3 m^3 / \pi^3)} e^{-h m (u^2 + v^2 + w^2)} du dv dw \quad (9)$$

per unit volume. Construct a small cylinder inside the gas, having dS as base and edges such that the projections of each on the co-ordinate axes are udt , vdt , wdt . Each of the molecules enumerated in expression (9) will move parallel to the edge of this cylinder, and each will describe a length equal to its edge in time dt . Thus each of these molecules which is initially inside the cylinder, will impinge on the area dS within an interval dt . The cylinder is of volume $u dt dS$, so that the product of this and expression (9) must give the number of impacts between the area dS and molecules of the kind under consideration within the interval dt . Each impinging molecule exerts an impulsive pressure equal to mu on the boundary before the component of velocity of its centre of gravity normal to the boundary is reduced to zero. Thus the contribution to the total impulsive pressure exerted on the area dS in time dt from this cause is

$$m u \times u dt dS \times \nu \sqrt{(h^3 m^3 / \pi^3)} e^{-h m (u^2 + v^2 + w^2)} du dv dw \quad (10)$$

The total pressure exerted in bringing the centres of gravity of all the colliding molecules to rest normally to the boundary is obtained by first integrating this expression with respect to u , v , w , the limits being all values for which collisions are possible (namely from $-\infty$ to 0 for u , and from $-\infty$ to $+\infty$ for v and w), and then summing for all kinds of molecules in the gas. Further impulsive pressures are required to restart in motion all the molecules which have undergone collision. The aggregate amount of these pressures is clearly the sum of the momenta, normal to the boundary, of all molecules which have left dS within a time dt , and this will be given by expression (10), integrated with respect to u from 0 to ∞ , and with respect to v and w from $-\infty$ to $+\infty$, and then summed for all kinds of molecules in the gas. On combining the two parts of the pressure which have been calculated, the aggregate impulsive pressure on dS in time dt is found to be

$$\Sigma dt dS \int \int \int \nu \sqrt{(h^3 m^3 / \pi^3)} e^{-h m (u^2 + v^2 + w^2)} m u^2 du dv dw,$$

where Σ denotes summation over all kinds of molecules. This is equivalent to a steady pressure p_1 per unit area where

$$p_1 = \Sigma \int \int \int \nu \sqrt{(h^3 m^3 / \pi^3)} e^{-h m (u^2 + v^2 + w^2)} m u^2 du dv dw.$$

Clearly the integral is the sum of the values of mu^2 for all the molecules of the first kind in unit volume, thus

$$p = \nu m \bar{u}^2 + \nu' m'^2 + \dots \quad (11)$$

On substituting from equations (7) and (8), this expression assumes the forms

$$p = (\nu + \nu' + \dots) 2h \quad (12)$$

$$= (\nu + \nu' + \dots) RT \quad (13)$$

The number of molecules per unit volume in a gas at normal temperature and pressure is known to be about 2.75×10^{19} . If in formula

(13) we put $p = 1.013 \times 10^6$, $(\nu + \nu' + \dots) = 2.75 \times 10^{19}$

Molecular Velocities. $T = 273$, we obtain $R = 1.35 \times 10^{-16}$ and this enables us to determine the mean velocities produced by heat motion in molecules of any given mass. For molecules of known gases the calculation is still easier. If ρ is the density corresponding to pressure p , we find that formula (11) assumes the form

$$p = \frac{1}{3} \rho C^2,$$

where C is a velocity such that the gas would have its actual translational energy if each molecule moved with the same velocity C . By substituting experimentally determined pairs of values of p and ρ we can calculate C for different gases, and so obtain a knowledge of the magnitudes of the molecular velocities. For instance, it is found that

for hydrogen at	0° Cent.	$C = 183,900$ cms. per sec.
" air "	15° "	" $C = 49,800$ " " "
" mercury vapour at	0° "	" $C = 18,500$ " " "

and other velocities can readily be calculated.

From the value $R = 1.35 \times 10^{-16}$ it is readily calculated that a molecule, or aggregation of molecules, of mass 10^{-21} grammes, ought to

have a mean velocity of about 2 millimetres a second at "Brownian Movements," 0° C. Such a velocity ought accordingly to be set up in a particle of 10^{-21} grammes mass immersed in air or liquid at 0° C., by the continual jostling of the surrounding molecules or particles. A particle of this mass is easily visible microscopically, and a velocity of 2 mm. per second would of course be visible if continued for a sufficient length of time. Each bombardment will, however, change the motion of the particle, so that changes are too frequent for the separate motions to be individually visible. But it can be shown that from the aggregation of these separate short motions the particle ought to have a resultant motion, described

with an average velocity which, although much smaller than 2 mm. a second, ought still to be microscopically visible. It has been shown by R. von S. Smoluchowski (*Ann. d. Phys.*, 1906, 21, p. 756) that this theoretically predicted motion is simply that seen in the "Brownian movements," first observed by the botanist Robert Brown in 1827. Thus the "Brownian movements" provide visual demonstration of the reality of the heat-motion postulated by the kinetic theory.

Dalton's Law.—The pressure as given by formula (12) can be written as the sum of a number of separate terms, one for each gas in the mixture. Hence we have Dalton's Law: **Pressure, Volume and Temperature Relations.** The pressure of a mixture of gases is the sum of the pressures which would be exerted separately by the several constituents if each alone were present.

Avogadro's Law.—From formula (13) it appears that $\nu + \nu' + \dots$, the total number of molecules per unit volume, is determined when p , T and the constant R are given. Hence we have Avogadro's law: **Different gases, at the same temperature and pressure, contain equal numbers of molecules per unit volume.**

Boyle's and Charles' Law.—If ν is the volume of a homogeneous mass of gas, and N the total number of its molecules, $N = \nu(\nu + \nu' + \dots)$, so that

$$p\nu = RT. \quad (14)$$

In this equation we have the combined laws of Boyle and Charles: **When the temperature of a gas is kept constant the pressure varies inversely as the volume, and when the volume is kept constant the pressure varies as the temperature.**

Since the volume at constant pressure is exactly proportional to the absolute temperature, it follows that the coefficients of expansion of all gases ought, to within the limits of error introduced by the assumptions on which we are working, to have the same value 1/273.

Van der Waals' Equation.—The laws which have just been stated are obeyed very approximately, but not with perfect accuracy, by all gases of which the density is not too great or the temperature too low. Van der Waals, in a famous monograph, *On the Continuity of the Liquid and Gaseous States* (Leiden, 1873), has shown that the imperfections of equation (14) may be traced to two causes:—

(i.) The calculation has not allowed for the finite size of the molecules, and their consequent interference with one another's motion, and

(ii.) The calculation has not allowed for the field of inter-molecular force between the molecules, which, although small, is known to have a real existence. The presence of this field of force results in the molecules, when they reach the boundary, being acted on by forces in addition to those originating in their impact with the boundary.

To allow for the first of these two factors, Van der Waals finds that ν in equation (14) must be replaced by $\nu - b$, where b is four times the aggregate space occupied by all the molecules, while to allow for the second factor, p must be replaced by $p + a/\nu^2$. Thus the pressure is given by the equation

$$(p + a/\nu^2)(\nu - b) = RT,$$

which is known as Van der Waals' equation. This equation is found experimentally to be capable of representing the relation between p , ν , and T over large ranges of values. (See CONDENSATION OF GASES.)

Let us consider a single gas, consisting of N similar molecules in a volume ν , and let the energy of each molecule, which is in *Calorimetry*, formula (2) be given by

$$E = \frac{1}{2} \Sigma (m_1^2 u^2 + m_1^2 v^2 + m_1^2 w^2 + \theta_1^2 + \dots + \theta_{n_1}^2) \quad (15)$$

$$= \frac{N}{2} (n+3) \frac{1}{2} h \nu \text{ by equation (7) } \quad (16)$$

Let a quantity dQ of energy, measured in work units, be absorbed by the gas from some external source, so that its pressure, volume and temperature change. The equation of energy is

$$dQ = dE + p d\nu, \quad (17)$$

expressing that the total energy dQ is used partly in increasing the internal energy of the gas, and partly in expanding the gas against the pressure p . If we take $p = RNT/\nu$ from equation (14) and substitute for E from equation (16), this last equation becomes

$$dQ = \frac{1}{2} (n+3) RN dT + RNT d\nu/\nu, \quad (18)$$

which may be taken as the general equation of calorimetry, for a gas which accurately obeys equation (14).

Second Law of Thermodynamics.—If we divide throughout by T , we obtain

$$\frac{dQ}{T} = \frac{1}{2} (n+3) RN \frac{dT}{T} + RN \frac{d\nu}{\nu},$$

showing that dQ/T is a perfect differential. This not only verifies that the second law of thermodynamics is obeyed, but enables us to identify T with the absolute thermodynamic temperature.

If the volume of the gas is kept constant, we put $d\nu = 0$ in equation (18) and $dQ = J C_n m dt$, where C_n is the specific heat of the gas at constant volume and J is the mechanical equivalent of heat. We obtain

$$C_n = \frac{1}{2} (n+3) R/Jm. \quad (19)$$

On the other hand, if the pressure of the gas is kept constant

throughout the motion, T/v is constant and $dQ = C_p N m dT$, whence

$$C_p = \frac{1}{2}(n+5)R/Jm. \quad (20)$$

By division of the values of C_p and C_v we find for γ , the ratio of the specific heats.

$$\gamma = 1 + 2/(n+3). \quad (21)$$

The comparison of this formula with experiment provides a striking confirmation of the truth of the kinetic theory but at the same time discloses the most formidable difficulty which the theory has so far had to encounter.

On giving different values to n in formula (21), we obtain the values for γ :

$$\begin{array}{cccccc} n = & 0, & 1, & 2, & 3, & 4, & 5, \\ \gamma = & 1.66, & 1.5, & 1.4, & 1.33, & 1.28, & 1.25, & \&c. \end{array}$$

Thus, to within the degree of approximation to which our theory is accurate, the value of γ for every gas ought to be one of this series. The following are the values of γ for gases for which γ can be observed with some accuracy:—

Mercury	1.66	Nitrogen	1.40
Krypton	1.66	Carbon monoxide	1.41
Helium	1.65	Hydrogen	1.40
Argon	1.62	Oxygen	1.40
Air	1.40	Hydrochloric acid	1.39

It is clear that for the first four gases $n=0$, while for the remainder $n=2$. To examine what is meant by a zero value of n we refer to formula (15). The value of n is the number of terms in the energy of the molecule beyond that due to translation. Thus when $n=0$, the whole energy must be translational; there can be no energy of rotation or of internal motion. The molecules of gases for which $n=0$ must accordingly be spherical in shape and in internal structure, or at least must behave at collisions as though they were spherical, for they would otherwise be set into rotation by the forces experienced at collisions. In the light of these results it is of extreme significance that the four gases for which $n=0$ are all believed to be monatomic: the molecules of these gases consist of single atoms. Moreover, these four are the only monatomic gases for which the value of γ is known, so that the only atoms of which the shape can be determined are found to be spherical. It is at least a plausible conjecture, until the contrary is proved, that the atoms of all elements are spherical.¹

The next value which occurs is $n=2$. The kinetic energy of the molecules of these gases must contain two terms in addition to those representing translational energy. For a rigid body the kinetic energy will, in general, consist of three terms ($\frac{1}{2}Mv^2 + \frac{1}{2}C\omega^2 + C\omega'^2$) in addition to the translational energy. The value $n=2$ is appropriate to bodies of which the shape is that of a solid of revolution, so that there is no rotation about the axis of symmetry. We must accordingly suppose that the molecules of gases for which $n=2$ are of this shape. Now this is exactly the shape which we should expect to find in molecules composed of two spherical atoms distorting one another by their mutual forces, and all gases for which $n=2$ are diatomic.

No molecule could possibly be imagined for which n had a negative value or the value $n=1$. The theory therefore passes a crucial test when it is discovered that no gases exist for which n is either negative or unity. On the other hand, the theory encounters a very serious difficulty in the fact that all molecules possess a great number of possibilities of internal motion, as is shown by the number of distinct lines in their spectra both of emission and of absorption. So far as is known, each line in the spectrum of, say, mercury, represents a possibility of a distinct vibration of the mercury atom, and accordingly provides two terms ($\text{say } \phi\omega^2 + \beta\phi^2$), where ϕ is the normal co-ordinate of the vibration) in the expression for the energy of the molecule. There are many thousands of lines in the mercury spectrum, so that from this evidence it would appear that for mercury vapour n ought to be very great, and γ almost equal to unity. Instead of this we have $n=0$ and $\gamma=1\frac{1}{3}$. As a step towards removing this difficulty we notice that the energy of a vibration such as is represented by a spectral line has the peculiarity of being unable to exist (so far as we know) without suffering dissipation into the ether. This energy, therefore, comes under a different category from the energy for which the law of equipartition was proved, for in proving this law conservation of

¹Very significant confirmation of this conjecture is obtained from a study of the specific heats of the elements in the solid state. If a solid body is regarded as an aggregation of similar atoms each of mass m , its specific heat C is given, as in formula (19) by $C = \frac{1}{2}(n+3)R/Jm$. From Dulong and Petit's law that Cm is the same for all elements, it follows that $n+3$ must be the same for all atoms. Moreover, the value of Cm shows that $n+3$ must be equal to six. Now if the atoms are regarded as points or spherical bodies oscillating about positions of equilibrium, the value of $n+3$ is precisely six, for we can express the energy of the atom in the form

$$E = \frac{1}{2}(m\dot{x}^2 + m\dot{y}^2 + m\dot{z}^2 + x^2 \frac{\partial^2 V}{\partial x^2} + y^2 \frac{\partial^2 V}{\partial y^2} + z^2 \frac{\partial^2 V}{\partial z^2}),$$

where V is the potential and x, y, z are the displacements of the atom referred to a certain set of orthogonal axes.

energy was assumed. The difficulty is further diminished when it is proved, as it can be proved,² that the modes of energy represented in the atomic spectrum acquire energy so slowly that the atom might undergo collisions with other atoms for centuries before being set into oscillations which would possess an appreciable amount of energy. In fact the proved tendency for the gas to pass into the "normal state" in which there is equipartition of energy, represents in this case nothing but, the tendency for the translational energy to become dissipated into the energy of innumerable small vibrations. We find that this dissipation, although undoubtedly going on, proceeds with extreme slowness, so that the vibrations pass their energy on to the ether as rapidly as they acquire it, and the "normal state" is never established. These considerations suggest that the difficulty which has been pointed out may be apparent rather than real. At the same time this difficulty is only one aspect of a wider difficulty which cannot be lightly passed over; Maxwell himself regarded it as the principal obstacle in the way of the full acceptance of the theory of which he was so largely the author.

(J. H. JE.)

MOLE-RAT, the name of a group of blind burrowing rodents, typified by the large grey *Spalax typhlus* of eastern Europe and Egypt, which represents the Old World family *Spalacidae*. All the mole-rats of the genus *Spalax* are characterized by the want of distinct necks, small or rudimentary ears and eyes, and short limbs provided with powerful digging claws. There are three pairs of cheek-teeth which are rooted, and show folds of enamel on the crown. Mole-rats are easily recognized by the peculiarly flattened head, in which the minute eyes are covered with skin, the wart-like ears, and rudimentary tail; they make burrows in sandy soil, and feed on bulbs and roots. Bamboo-rats, of which one genus (*Rhizomya*) is Indian and Burmese, and the other (*Tachyoryctes*) East African, differ by the absence of skin over the eyes, the presence of short ears, and a short, sparsely-haired tail. They burrow either among tall grass, or at the roots of trees (see **RODENTIA**).

MOLE-SHREW, any individual of the genera *Urotrichus* and *Uropsilus* (see **INSECTIVORA**). These animals, which are sometimes called shrew-moles, are not moles with shrew-like habits, but shrews with the burrowing habits of moles and resembling them in appearance.

MOLESKIN, a term employed not only for the skin of a mole but also, from a real or fancied resemblance, for a stout heavy cotton fabric of leathery consistence woven as a satin twill on a strong warp. It is shorn before being dyed or bleached. Being of an exceedingly durable and economical texture, it has been much worn by working-men, especially outdoor labourers. It is also used for gun-cases, carriage-covers, and several purposes in which a fabric capable of resisting rough usage is desirable.

MOLESWORTH, MARY LOUISA (1839—), Scottish writer, daughter of Major-General Stewart, of Strath, N.B., was born in Rotterdam on the 29th of May 1839, and was educated in Great Britain and abroad. In 1861 Miss Stewart married Major R. Molesworth. Her first novels, *Lover and Husband* (1866) to *Cicely* (1874), appeared under the pseudonym of "Ennis Graham." Mrs Molesworth is best known as a writer of books for the young, such as *Tell Me a Story* (1875), *Carrots* (1876), and *The Cuckoo Clock* (1877).

MOLESWORTH, ROBERT MOLESWORTH, 1ST VISCOUNT (1656–1725), came of an old Northamptonshire family. His father Robert (d. 1656) was a Cromwellian who made a fortune in Dublin, and he himself supported William of Orange and in 1695 became a prominent member of the Irish privy council. In 1716 he was created a viscount. He was succeeded by his two sons, John, 2nd viscount (1679–1726), and Richard 3rd viscount (1680–1758), the latter of whom saved Marlborough's life at the battle of Ramillies and rose to be a field-marshal. The 3rd viscount's son Richard Nassau (1748–1793) succeeded to the title, which has descended accordingly.

A great-grandson of the 1st viscount, JOHN EDWARD NASSAU MOLESWORTH (1790–1877), vicar of Rochdale, was a well-known High Churchman and controversialist; and two of his sons became prominent men—WILLIAM NASSAU MOLESWORTH (1816–1800), author of *History of England 1830–1871* (1871–1873), *History of the Reform Bill* (1865), and *History of the Church of*

²J. H. Jeans, *Dynamical Theory of Gases*, ch. ix.

England (1882); and SIR GUILFORD MOLESWORTH (b. 1828), an eminent engineer and economist.

MOLESWORTH, SIR WILLIAM, BART. (1810-1855), English politician, son of the 7th baronet, was born in London on the 23rd of May 1810, and in 1823 succeeded to the baronetcy. At Cambridge he fought a duel with his tutor, and for some time studied abroad. On the passing of the Reform Act of 1832 he was returned to parliament for the eastern division of Cornwall, to support the ministry of Lord Grey. Through Charles Buller he made the acquaintance of Grote and James Mill, and in April 1835 he founded, in conjunction with Roebuck, the *London Review*, as an organ of the "Philosophic Radicals." After the publication of two volumes he purchased the *Westminster Review*, and for some time the united magazines were edited by him and J. S. Mill. From 1837 to 1841 Sir William Molesworth sat for Leeds, and acquired considerable influence in the House of Commons by his speeches and by his tact in presiding over the select committee on transportation. But his Radicalism made little impression either on the house or on his constituency. From 1841 to 1845 he had no seat in parliament, occupying his leisure time in editing the works in Latin and English of Thomas Hobbes of Malmesbury, a recreation which cost him no less than £6000. In 1845 he was returned for Southwark, and retained that seat until his death. On his return to parliament he devoted special attention to the condition of the colonies, and was the ardent champion of their self-government. In January 1853 Lord Aberdeen included him in the cabinet as first commissioner of works, the chief work by which his name was brought into prominence at this time being the construction of the new Westminster Bridge; he also was the first to open Kew Gardens on Sundays. In July 1855 he was made colonial secretary, but he died on the 22nd of October. Molesworth was for many years a great friend of Mr and Mrs Grote, and Mrs Grote's privately printed work on *The Philosophical Radicals* (1866) contains an account of his life. He married in 1844, but had no children, and the baronetcy passed to a cousin. His sister (d. 1910) married Richard Ford, famous for his *Handbook of Spain*.

A *Life* by Mrs Fawcett was published in 1903. A full pedigree of the Molesworth family is printed in Sir John Maclean's *Trigg Minor*, vol. 1; the titles of his speeches and works may be found in the *Bibl. Cornubiensis*, vol. i. and iii.

MOLFETTA, a seaport and episcopal see of Apulia, Italy, in the province of Bari, from which it is 16 m. N.N.W. by rail. Pop. (1901), 42,363. The old cathedral of S. Conrad is a Romanesque structure. The old town is surrounded by walls, and has mediæval houses; the new town is more spacious, and is an active seaport. The origin of Molfetta is uncertain, though there was a neolithic settlement here. The town was given by Charles V. to the duke of Termoli in 1522, and during his lordship it was sacked by the French under Lautrec. In 1631 Cesare Gonzaga took the title of duke of Guastalla and prince of Molfetta; but in 1640 the fief was sold to the Spinola family, and in 1798 incorporated with the royal domain. The bishopric is directly subject to the papal see.

MOLIÈRE (1622-1673), the *nom de théâtre* chosen, for some undiscovered reason, by the great French dramatist Jean Baptiste Poquelin, and ever since substituted for his family name. He was born in Paris, probably in January 1622. The baptismal certificate which is usually, and almost with absolute certainty, accepted as his is dated 15th January 1622, but it is not possible to infer that he was born on the day of his christening. The exact place of his birth is also disputed, but it seems tolerably certain that he saw the light in a house of the Rue St Honoré. His father was Jean Poquelin, an upholsterer, who, in 1637, succeeded his own uncle as "valet tapissier de chambre du roi." The family of Poquelin came from Beauvais, where for some centuries they had been prosperous tradesmen. The legend of their Scotch descent seems to have been finally disproved by the researches of M. E. Révérend du Messil. The mother of Molière was Marie Cressé; and on his father's side he was connected with the family of Mazuel, musicians attached to

the court of France. In 1632 Molière lost his mother; his father married again in 1633. The father possessed certain shops in the covered Halle de la Foire, Saint Germain des Prés, and the biographers have imagined that Molière might have received his first bent towards the stage from the spectacles offered to the holiday people at the fair. Of his early education little is known; but it is certain that his mother possessed a Bible and Plutarch's *Lives*, books which an intelligent child would not fail to study. In spite of a persistent tradition, there is no reason to believe that the later education of Molière was neglected. "Il fit ses humanités au collège de Clermont," says the brief life of the comedian published by his friend and fellow-actor, La Grange, in the edition of his works printed in 1682. La Grange adds that Molière "eut l'avantage de suivre M. le Prince de Conti dans toutes ses classes." As Conti was seven years younger than Molière, it is not easy to understand how Molière came to be the school contemporary of the prince. Among more serious studies the Jesuit fathers encouraged their pupils to take part in *ballets*, and in later life Molière was a distinguished master of this sort of entertainment. According to Grimarest, the first writer who published a life of Molière in any detail (1705), he not only acquired "his humanities," but finished his "philosophy" in five years. He left the Collège de Clermont in 1641, the year when Gassendi, a great contemner of Aristotle, arrived in Paris. The *Logic* and *Ethics* of Aristotle, with his *Physics* and *Metaphysics*, were the chief philosophical textbooks at the Collège de Clermont. But when he became the pupil of Gassendi (in company with Cyrano de Bergerac, Chapelain, and Hesnaut), Molière was taught to appreciate the atomic philosophy of Lucretius. There seems no doubt that Molière began, and almost or quite finished, a translation of the *De natura rerum*. According to a manuscript note of Trallage, published by M. Paul Lacroix, the manuscript was sold by Molière's widow to a bookseller. His philosophic studies left a deep mark on the genius of Molière. In the *Jugement de Pluton sur les deux parties des nouveaux dialogues des morts* (1684), the verdict is "que Molière ne parleroit point de philosophie." To "talk philosophy" was a favourite exercise of his during his life, and his ideas are indicated with sufficient clearness in several of his plays. There seems no connexion between them and the opinions of "Molière le Critique" in a dialogue of that name, published in Holland in 1709. From his study of philosophy, too, he gained his knowledge of the ways of contemporary pedants: of Pancrace the Aristotelian, of Marphorius the Cartesian, of Trissotin, "qui s'attache pour l'ordre au Péripatétisme," of Philaminte, who loves Platonism, of Belise, who relishes "les petites corps," and Armande, who loves "les tourbillons." Grimarest has an amusing anecdote of a controversy in which Molière, defending Descartes, chose a lay-brother of a begging order for umpire, while Chapelain appealed to the same expert in favour of Gassendi. His college education over, Molière studied law, and there is even evidence—that of tradition in Grimarest, and of Le Boulanger de Chalussay, the libellous author of a play called *Élomire hypochondre*—to prove that he was actually called to the bar. More trustworthy is the passing remark in La Grange's short biography (1682), "au sortir des écoles de droit, il choisit la profession de comédien." Before joining a troop of half-amateur comedians, however, Molière had some experience in his father's business. In 1637 his father had obtained for him the right to succeed to his own office as "valet tapissier de chambre du roi." The document is mentioned in the inventory of Molière's effects, taken after his death. When the king travelled the *valet tapissier* accompanied him to arrange the furniture of the royal quarters. There is very good reason to believe (Loiseleur, *Points obscurs*, p. 94) that Molière accompanied Louis XIII. as his *valet tapissier* to Provence in 1642. It is even not impossible that Molière was the young *valet de chambre* who concealed Cinq Mars just before his arrest at Narbonne, on the 13th of June 1642. But this is part of the romance rather than of the history of Molière. Our next glimpse of the comedian we get in a document of 6th January 1643. Molière acknowledges the receipt of money

due to him from his deceased mother's estate, and gives up his claim to succeed his father as "valet de chambre du roi." On the 28th of December of the same year we learn, again from documentary evidence, that Jean Baptiste Poquelin, with Joseph Béjard, Madeleine Béjard, Geneviève Béjard, and others, have hired a tennis-court and fitted it up as a stage for dramatic performances. The company called themselves L'illustre Théâtre, *illustre* being then almost a slang word, freely employed by the writers of the period.

We now reach a very important point in the private history of Molière, which it is necessary to discuss at some length in defence of the much maligned character of a great writer and a good man. Molière's connexion with the family of Béjard brought him much unhappiness. The father of this family, Joseph Béjard the elder, was a needy man, with eleven children at least. His wife's name was Marie Hervé. The most noted of his children, companions of Molière, were Joseph, Madeleine, Geneviève, and Armande. Of these, Madeleine was a woman of great talent as an actress, and Molière's friend, or perhaps mistress, through all the years of his wanderings. Now, on the 14th of February 1662 (for we must here leave the chronological order of events), Molière married Armande Claire Élisabeth Grésinde Béjard. His enemies at that time, and a number of his biographers in our own day, have attempted to prove that Armande Béjard was not the sister, but the daughter of Madeleine, and even that Molière's wife may have been his own daughter by Madeleine Béjard. The arguments of M. Arsène Houssaye in support of this abominable theory are based on reckless and ignorant confusions, and do not deserve criticism. But the system of M. Loiseleur is more serious, and he goes no further than the idea that Madeleine was the mother of Armande. This, certainly, was the opinion of tradition, an opinion based on the slanders of Montfleury, a rival of Molière's, on the authority of the spiteful and anonymous author of *La Fausse comédienne* (1688), and on the no less libellous play, *Élomire hypochondre*. In 1821 tradition received a shock, for Beffara then discovered Molière's "acte de mariage," in which Armande, the bride, is spoken of as the sister of Madeleine Béjard, by the same father and mother. The old scandal, or part of it, was revived by M. Fournier and M. Bazin, but received another blow in 1863. M. Soulié then discovered a legal document of the 10th of March 1643, in which the widow of Joseph Béjard renounced, in the name of herself and her children, his inheritance, chiefly a collection of unpaid bills. Now in this document all the children are described as minors, and among them is "une petite non encore baptisée." This little girl, still not christened in March 1643, is universally recognized as the Armande Béjard afterwards married by Molière. We reach this point, then, that when Armande was an infant she was acknowledged as the sister, not as the daughter, of Madeleine Béjard. M. Loiseleur refuses, however, to accept this evidence. Madeleine, says he, had already become the mother, in 1638, of a daughter by Esprit Raymond de Moirmon, comte de Modène, and chamberlain of Gaston duc d'Orléans, brother of Louis XIII. In 1642 Modène, who had been exiled for political reasons, "was certain to return, for Richelieu had just died, and Louis XIII. was likely to follow him." Now Madeleine was again—this is M. Loiseleur's hypothesis—about to become a mother, and if Modène returned, and learned this fact, he would not continue the liaison, still less would he marry her—which, by the way, he could not do, as his wife was still alive. Madeleine, therefore, induced her mother to acknowledge the little girl as her own child. In the first place, all this is pure unsupported hypothesis. In the second place, it has always been denied that Béjard's wife could have been a mother in 1643, owing to her advanced age, probably fifty-three. But M. Loiseleur himself says that Marie Hervé was young enough to make the story "sufficiently probable." If it was probable, much more was it possible. M. Loiseleur supports his contention by pointing out that two of the other children, described as legally minors, were over twenty-five, and that their age was understated to make the account of Armande's birth more probable. Nothing is less likely than

that Modène would have consulted this document to ascertain the truth about the parentage of Armande, yet M. Loiseleur's whole theory rests on that extreme improbability. It must also be observed that the date of the birth of Joseph Béjard is unknown, and he may have been, and according to M. Jal (*Dictionnaire critique*, p. 178) must have been, a minor when he was so described in the document of the 10th of March 1643, while Madeleine had only passed her twenty-fifth birthday, her legal majority, by two months. This view of Joseph's age is supported by Bouquet (*Molière à Rouen*, p. 77). M. Loiseleur's only other proof is that Marie Hervé gave Armande a respectable dowry, and that, as we do not know whence the money came, it must have come from Madeleine. The tradition in Grimarest, which makes Madeleine behave *en femme furieuse*, when she heard of the marriage, is based on a juster appreciation of the character of women. It will be admitted, probably, that the reasons for supposing that Molière espoused the daughter of a woman who had been his mistress (if she had been his mistress) are flimsy and inadequate. The affair of the dowry is insisted on by M. Livet (*La Fausse comédienne*, reprint of 1877, p. 143). But M. Livet explains the dowry by the hypothesis that Armande was the daughter of Madeleine and the comte de Modène, which exactly contradicts the theory of M. Loiseleur, and is itself contradicted by dates, at least as understood by M. Loiseleur. Such are the conjectures by which the foul calumnies of Molière's enemies are supported in the essays of modern French critics.

Michelet accepted the scandal apparently as a buttress to his charges against Louis XIV. and Madame (*Histoire de France*, 1879, xv. 63, 64, 332).

To return to the order of events, Molière passed the year 1643 in playing with and helping to manage the Théâtre Illustre. The company acted in various tennis-courts, with very little success. Molière was actually arrested by the tradesman who supplied candles, and the company had to borrow money from one Aubrey to release their leader from the Grand Châtelet (Aug. 13, 1645). The process of turning a tennis-court into a theatre was somewhat expensive, even though no seats were provided in the pit. The troupe was for a short time under the protection of the duc d'Orléans, but his favours were not lucrative. The duc de Guise, according to some verses printed in 1646, made Molière a present of his cast-off wardrobe. But costume was not enough to draw the public to the tennis-court theatre of the Croix Noire, and empty houses at last obliged the Théâtre Illustre to leave Paris at the end of 1646.

"Nul animal vivant n'en tra dans nôtre salle," says the author of the scurrilous play on Molière, *Élomire hypochondre*. But at that time some dozen travelling companies found means to exist in the provinces, and Molière determined to play among the rural towns. The career of a strolling player is much the same at all times and in all countries. The *Roman comique* of Scarron gives a vivid picture of the adventures and misadventures, the difficulty of transport, the queer cavalcade of horses, mules, and lumbering carts that drag the wardrobe and properties, the sudden metamorphosis of the tennis-court, where the balls have just been rattling, into a stage, the quarrels with local squires, the disturbed nights in crowded country inns, all the loves and wars of a troupe on the march. Perrault tells us what the arrangements to the theatre were in Molière's early time. Tapestries were hung round the stage, and entrances and exits were made by struggling through the heavy curtains, which often knocked off the hat of the comedian, or gave a strange cock to the helmet of a warrior or a god. The lights were candles stuck in tin sconces at the back and sides, but luxury sometimes went so far that a chandelier of four candles was suspended from the roof. At intervals the candles were let down by a rope and pulley, and any one within easy reach snuffed them with his fingers. A flute and tambour, or two fiddlers, supplied the music. The highest prices were paid for seats in the *sedans* (cost of admission fivepence); for the privilege of standing up

in the pit twopence-halfpenny was the charge. The doors were opened at one o'clock, the curtain rose at two.

The nominal director of the Théâtre Illustre in the provinces was Du Fresnois; the most noted actors were Molière, the Bèjars, and Du Parc, called Gros René. It is extremely difficult to follow exactly the line of march of the company. They played at Bordeaux, for example, but the date of this performance, when Molière (according to Montesquieu) failed in tragedy and was pelted, is variously given as 1644-1645 (Trallage), 1647 (Loiseleur), 1648-1648 (Lacroix). Perhaps the theatre prospered better elsewhere than in Paris, where the streets were barricaded in these early days of the war of the Fronde. We find Molière at Nantes in 1648, at Fontenay-la-Compte, and in the spring of 1649 at Agen, Toulouse, and probably at Angoulême and Limoges. In January 1650 they played at Narbonne, and between 1650 and 1653 Lyons was the headquarters of the troupe. In January 1653, or perhaps 1655, Molière gave *L'Étourdi* at Lyons, the first of his finished pieces, as contrasted with the slight farces with which he generally diverted a country audience. It would be interesting to have the precise date of this piece, but La Grange (1682) says that "in 1653 Molière went to Lyons, where he gave his first comedy, *L'Étourdi*," while in his *Registre* La Grange enters the year as 1655. At Lyons de Brie and his wife, the famous Mlle de Brie, entered the troupe, and du Parc married the "marquise" de Gorla, better known as Mlle du Parc. The libellous author of *La Fameuse comédienne* reports that Molière's heart was the shuttlecock of the beautiful du Parc and de Brie, and the tradition has a persistent life. Molière's own opinion of the ladies and men of his company may be read between the lines of his *Impromptu de Versailles*. In 1653 Prince de Conti, after many political adventures, was residing at La Grange, near Pézénas, in Languedoc, and chance brought him into relations with his old schoolfellow Molière. Conti had for first gentleman of his bed-chamber the abbé Daniel de Cosnac, whose memoirs now throw light for a moment on the fortunes of the wandering troupe. Cosnac engaged the company "of Molière and of La Béjart"; but another company, that of Cormier, nearly intercepted the favour of the prince. Thanks to the resolution of Cosnac, Molière was given one chance of appearing on the private theatre of La Grange. The excellence of his acting, the splendour of the costumes, and the insistence of Cosnac, and of Sarrasin, Conti's secretary, gained the day for Molière, and a pension was assigned to his company (Cosnac, *Mémoires*, i. 128; Paris, 1852). As Cosnac proposed to pay Molière a thousand crowns of his own money to recompense him in case he was supplanted by Cormier, it is obvious that his profession had become sufficiently lucrative. In 1654, during the session of the estates of Languedoc, Molière and his company played at Montpellier. Here Molière danced in a ballet (*Le Ballet des incompatibles*) in which a number of men of rank took part, according to the fashion of the time. Molière's own rôles were those of the Poet and the Fishwife. The sport of the little piece is to introduce opposite characters, dancing and singing together. Silence dances with six women, Truth with four courtiers, Money with a poet, and so forth. Whether the ballet, or any parts of it, are by Molière, is still disputed (*La Jeunesse de Molière, suivie du ballet des incompatibles*, P. L. Jacob, Paris, 1858). In April 1655 it is certain that the troupe was at Lyons, where they met and hospitably entertained a profligate buffoon, Charles d'Assoucy, who informs the ages that Molière kept open house, and "une table bien garnie." November 1655 found Molière at Pézénas, where the estates of Languedoc were convened, and where local tradition points out the barber's chair in which the poet used to sit and study character. The longest of Molière's extant autographs is a receipt, dated at Pézénas, on the 4th of February 1656, for 6000 livres, granted by the estates of Languedoc. This year was notable for the earliest representation, at Béziers, of Molière's second finished comedy, the *Dépit amoureux*. Conti now (1656) began to "make his soul." Almost his first act of penitence was to discard Molière's troupe (1657), which consequently found that the liberality of the estates of Languedoc was dried

up for ever. Conti's relations with Molière must have definitely closed long before 1666, when the now pious prince wrote a treatise against the stage, and especially charged his old schoolfellow with keeping a new school, a school of atheism (*Traité de la comédie*, p. 24; Paris, 1666). Molière was now (1657) independent of princes and their favour. He went on a new circuit to Nismes, Orange and Avignon, where he met another old class-mate, Chapelain, and also encountered the friend of his later life, the painter Mignard. After a later stay at Lyons, ending with a piece given for the benefit of the poor on the 27th of February 1658, Molière passed to Grenoble, returned to Lyons, and is next found in Rouen, where, we should have said, the Théâtre Illustre had played in 1643 (F. Bouquet, *La Troupe de Molière à Rouen*, p. 90; Paris, 1880). At Rouen Molière must have made or renewed the acquaintance of Pierre and Thomas Corneille. His company had played pieces by Corneille at Lyons and elsewhere. The real business of the comedian in Rouen was to prepare his return to Paris. "After several secret journeys thither he was fortunate enough to secure the patronage of Monsieur, the king's only brother, who granted him his protection, and permitted the company to take his name, presenting them as his servants to the king and the queen mother" (Preface to La Grange's edition of 1682). The troupe appeared for the first time before Louis XIV. in a theatre arranged in the old Louvre (Oct. 24, 1658).

Molière was now thirty-six years of age. He had gained all the experience that fifteen years of practice could give. He had seen men and cities, and noted all the humours of rural and civic France. He was at the head of a company which, as La Grange, his friend and comrade, says, "sincerely loved him." He had the unlucrative patronage of a great prince to back him, and the jealousy of all playwrights, and of the old theatres of the Hôtel de Bourgogne and the Marais, to contend against. In this struggle we can follow him by aid of the *Registre* of La Grange (a brief diary of receipts and payments), and by the help of notices in the rhymed chronicles of Loreet.

The first appearance of Molière before the king was all but a failure. *Nicomède*, by the elder Corneille, was the piece, and we may believe that the actors of the Hôtel de Bourgogne, who were present, found much to criticize. When the play was over, Molière came forward and asked the king's permission to act "one of the little pieces with which he had been used to regale the provinces." The *Docteur amoureux*, one of several slight comedies admitting of much "gag," was then performed, and "diverted as much as it surprised the audience." The king commanded that the troupe should establish itself in Paris (Preface, ed. 1682). The theatre assigned to the company was a *salle* in the Petit Bourbon, in a line with the present Rue du Louvre. Some Italian players already occupied the house on Tuesdays, Fridays, and Sundays; the company of Molière played on the other days. The first piece played in the new house (Nov. 3, 1658) was *L'Étourdi*. La Grange says the comedy had a great success, producing seventy pistoles for each actor. The success is admitted even by the spiteful author of *Éloïre hypochondre* (Paris, 1670):—

"Je jouai l'Étourdi, qui fut une merveille."

The success, however, is attributed to the farcical element in the play and the acting—the cuckoo-cry of Molière's detractors. The original of *L'Étourdi* is the Italian comedy (1629) *L'Inverito*, by Nicolò Barbieri detto Beltrame; Molière pushed rather far his right to "take his own wherever he found it." Had he written nothing more original, the contemporary critic of the *Festin de Pierre* might have said, not untruly, that he only excelled in stealing pieces from the Italians. The piece is conventional: the stock characters of the prodigal son, the impudent valet, the old father occupy the stage. But the dialogue has amazing rapidity, and the vivacity of M. Coquelin, who Mascarielle made *L'Étourdi* a favourite on the modern stage, though it cannot be read with very much pleasure. The next piece, new in Paris, though not in the provinces, was the *Dépit amoureux* (first acted at Béziers, 1656). The play was not

less successful than *L'Étourdi*. It has two parts, one an Italian *imbroglia*; the other, which alone keeps the stage, is the original work of Molière, though, of course, the idea of *amantium irae* is as old as literature. "Nothing so good," says Mr Saintsbury, "had yet been seen on the French stage, as the quarrels and reconciliations of the quartette of master, mistress, valet and soubrette." Even the hostile Le Boulanger de Chalussay (*Éloïre hypochondre*) admits that the audience was much of this opinion:—

'Et de tous les côtés chacun cria tout haut :
'C'est la faire et jouer les pièces comme il faut.'

The same praise was given, perhaps even more deservedly, to *Les Précieuses ridicules* (Nov. 18, 1659). Doubts have been raised as to whether this famous piece, the first true comic satire of contemporary foibles on the French stage, was a new play. La Grange calls it *pièce nouvelle* in his *Registre*; but, as he enters it as the third *pièce nouvelle*, he may only mean that, like *L'Étourdi*, it was new to Paris. The short life of 1682, produced under La Grange's care, and probably written by Marcel the actor, says the *Précieuses* was "made" in 1659. There is another controversy as to whether the ladies of the Hôtel Rambouillet, or merely their *bourgeoises* and rustic imitators, were laughed at. Ménage, in later years at least, professed to recognize an attack on the over-refinement and affectation of the original and, in most ways, honourable *précieuses* of the Hôtel Rambouillet. But Chapelle and Bachaumont had discovered provincial *précieuses*, hyper-aesthetic literary ladies, at Montpellier before Molière's return to Paris; and Furetière, in the *Roman bourgeois* (1666), found Paris full of middle-class *précieuses*, who had survived, or, like their modern counterparts, had thriven on ridicule. Another question is: Did Molière copy from the earlier *Précieuses* of the abbé de Pure? This charge of plagiarism is brought by Somaize, in the preface to his *Véritables précieuses*. De Pure's work was a novel (1656), from which the Italian actors had put together an acting-piece in their manner—that is, a thing of "gag," and improvised speeches. The reproach is interesting only because it proves how early Molière found enemies who, like Thomas Corneille in 1659, accused him of being skilled only in farce, or, like Somaize, charged him with literary larceny. These were the stock criticisms of Molière's opponents as long as he lived. The success of the *Précieuses ridicules* was immense; on one famous occasion the king was a spectator, leaning against the great chair of the dying Cardinal Mazarin. The play can never cease to please while literary affectation exists, and it has a comic force of deathless energy. Yet a modern reader may spare some sympathy for the poor heroines, who do not wish, in courtship, to "begin with marriage," but prefer first to have some less formidable acquaintance with their wooers. Molière's next piece was less important, and more purely farcical, *Sganarelle; ou le cocu imaginaire* (May 28, 1660). The public taste preferred a work of this light nature, and *Sganarelle* was played every year as long as Molière lived. The play was pirated by a man who pretended to have retained all the words in his memory. The counterfeit copy was published by Ribou, a double injury to Molière, as, once printed, any company might act the play. With his habitual good-nature, Molière not only allowed Ribou to publish later works of his, but actually lent money to that knave (Soulié, *Recherches*, p. 287).

On the 11th of October 1660 the Théâtre du Petit Bourbon was demolished by the superintendent of works, without notice given to the company. The king gave Molière the Salle du Palais Royal, but the machinery of the old theatre was maliciously destroyed. Meanwhile the older companies of the Marais and the Hôtel de Bourgogne attempted to lure away Molière's troupe, but, as La Grange declares (*Registre*, p. 26), "all the actors loved their chief, who united to extraordinary genius an honourable character and charming manner, which compelled them all to protest that they would never leave him, but always share his fortunes." While the new theatre was being put in order, the company played in the houses of the great, and before the king at the Louvre. In their new house (originally built by

Richelieu) Molière began to play on the 20th of January 1661. Molière now gratified his rivals by a failure. *Don Garcie de Navarre*, a heavy tragi-comedy, which had long lain among his papers, was first presented on the 4th of February 1661. Either Molière was a poor actor outside comedy, or his manner was not sufficiently "stacy," and, as he says, "demonic," for the taste of the day. His opponents were determined that he could not act in tragi-comedy, and he, in turn, burlesqued their pretentious and exaggerated manner in a later piece. In the *Précieuses* (sc. ix.) Molière had already rallied "les grands comédiens" of the Hôtel Bourgogne. "Les autres," he makes Mascarille say about his own troupe, "sont des ignorants qui récitent comme l'on parle, ils ne savent pas faire ronfler les vers." All this was likely to irritate the *grands comédiens*, and their friends, who avenged themselves on that unfortunate jealous prince, Don Garcie de Navarre. The subject of this unsuccessful drama is one of many examples which show how Molière's mind was engaged with the serious or comic aspects of jealousy, a passion which he had soon cause to know most intimately. Meantime the everyday life of the stage went on, and the doorkeeper of the Théâtre St Germain was wounded by some revellers who tried to force their way into the house (La Grange, *Registre*). A year later, an Italian actor was stabbed in front of Molière's house, where he had sought to take shelter (Campardon, *Nouvelles pièces*, p. 20). To these dangers actors were peculiarly subject: Molière himself was frequently threatened by the marquises and others whose class he ridiculed on the stage, and there seems even reason to believe that there is some truth in the story of the angry marquis who rubbed the poet's head against his buttons, thereby cutting his face severely. The story comes late (1725) in his biography, but is supported by a passage in the contemporary play, *Zélinde* (Paris, 1663, scene viii.). Before Easter, Molière asked for two shares in the profits of his company, one for himself, and one for his wife, if he married. That fatal step was already contemplated (La Grange). On the 24th of June he brought out for the first time *L'École des maris*. The general idea of the piece is as old as Menander, and Molière was promptly accused of pilfering from the *Adelphi* of Terence. One of the *ficelles* of the comedy is borrowed from a story as old, at least, as Boccaccio, and still amusing in a novel by Charles de Bernard. It is significant of Molière's talent that the grotesque and baffled paternal wooer, Sganarelle, like several other butts in Molière's comedy, does to a certain extent win our sympathy and pity as well as our laughter. The next new piece was *Les Fâcheux*, a *comédie-ballet*, the Comedy of Bored, played before the king at Fouquet's house at Vaux le Vicomte (Aug. 15-20, 1661). The comedians, without knowing it, were perhaps the real "fâcheux" on this occasion, for Fouquet was absorbed in the schemes of his insatiable ambition (*Quo non ascendam?* says his motto), and the king was organizing the arrest and fall of Fouquet, his rival in the affections of La Vallière. The author of the prologue to *Les Fâcheux*, Pellisson, a friend of Fouquet's, was arrested with the superintendent of finance. Pellisson's prologue and name were retained in the later editions. In the dedication to the king Molière says that Louis suggested one scene (that of the Sportsman), and in another place he mentions that the piece was written, rehearsed, and played in a fortnight. The fundamental idea of the play, the interruptions by bores, is suggested by a satire of Régnier's, and that by a satire of Horace. Perhaps it may have been the acknowledged suggestions of the king which made gossips declare that Molière habitually worked up hints and *mémoires* given him by persons of quality (*Nouvelles nouvelles*, 1663).

In February 1662 Molière married Armande Béjard. The date is given thus in the *Registre* of La Grange: "Mardy 14, Les Visionnaires, L'Écol des M."

"Part. Visite chez M^e d'Equeully."

And on the margin he has painted a blue circle—his way of recording a happy event—with the words, "mariage de M. de Molière au sortir de la Visite." M. Loiseau gives the date in one passage as the 29th of February; in another as the 20th of

February. But La Grange elsewhere mentions the date as "Shrove Tuesday," which was, it seems, the 14th of February. Elsewhere M. Loiseau makes the date of the marriage a vague day "in January." The truth is that the marriage contract is dated the 23rd of January 1662 (Soulié, *Documents*, p. 203). Where it is so difficult to establish the date of the marriage, a simple fact, it must be infinitely harder to discover the truth as to the conduct of Mme Molière. The abominable assertions of the anonymous libel, *Les Intrigues de Molière et celles de sa femme; ou la fameuse comédienne* (1688), have found their way into tradition, and are accepted by many biographers. But M. Livet and M. Bazin have proved that the alleged lovers of Mme Molière were actually absent from France, or from the court, at the time when they are reported, in the libel, to have conquered her heart. A conversation between Chapelle and Molière, in which the comedian is made to tell the story of his wrongs, is plainly a mere fiction, and is answered in Grimarest by another dialogue between Molière and Rohault, in which Molière only complains of a jealousy which he knows to be unfounded. It is noticed, too, that the contemporary assailants of Molière counted him among jealous, but not among deceived, husbands. The hideous accusation brought by the actor Montfleury, that Molière had married his own daughter, Louis XIV. answered by becoming the godfather of Molière's child. The king, indeed, was a firm friend of the actor, and, when Molière was accused of impiety on the production of *Don Juan* (1665) Louis gave him a pension. We need not try to make Mme Molière a *vertu*, as French ladies of the theatre say, but it is certain that the charges against her are unsubstantiated. It is generally thought that Molière drew her portrait in *Le Bourgeois gentilhomme* (acte III. sc. ix.), "elle est capricieuse, mais on souffre tout des belles."

From 1662 onwards Molière suffered the increasing hatred of his rival actors. La Grange mentions the visit of Floridor and Montfleury to the queen mother, and their attempt to obtain equal favour, "la troupe de Molière leur donnant beaucoup de jalousie" (Aug. 12, 1662). On the 26th of December was played for the first time the admirable *École des femmes*, which provoked a literary war, and caused a shower of "paper bullets of the brain." The innocence of Agnes was called indecency; the sermon of Arnolphe was a deliberate attack on Christian mysteries. We have not the space to discuss the religious ideas of Molière; but both in *L'École des femmes* and in *Don Juan* he does display a bold contempt for the creed of "boiling chaldrons" and of physical hell. A brief list of the plays and pamphlets provoked by *L'École des femmes* is all we can offer in this place.

December 26, 1662.—*École des femmes*.

February 9, 1663.—*Nouvelles nouvelles*, by De Visé. Molière is accused of pilfering from Straparola.

June 1, 1663.—Molière's own piece, *Critique de l'école des femmes*. In this play Molière retorts on the critics, and especially on his favourite butt, the critical marquis.

August 1663.—*Zélide*, a play by De Visé, is printed. The scene is in the shop of a seller of lace, where persons of quality meet, and attack the reputation of "Élomire"—that is, Molière. He steals from the Italian, the Spanish, from Furetière's *Francion*, "il lit tous les vieux bouquins," he insults the noblesse, he insults Christianity, and so forth.

November 17, 1663.—*Portrait du peintre* is printed—an attack on Molière by Boursault. This piece is a detailed criticism, by several persons, of *L'École des femmes*. It is pronounced dull, vulgar, farcical, obscene and (what chiefly vexed Molière, who knew the danger of the accusation) impious. Perhaps the only biographical matter we gain from Boursault's play is the interesting fact that Molière was a tennis-player. On the 4th November 1663, Molière replied with *L'Impromptu de Versailles*, a witty and merciless attack on his critics, in which Boursault was mentioned by name. The actors of the Hôtel de Bourgogne were parodied on the stage, and their art was ridiculed.

The next scenes in this comedy of comedians were:—

November 30.—*Le Panegyrique de l'école des femmes*, by Robinet.

December 7.—*Réponse à l'impromptu; ou la vengeance des marquis*, by De Visé.

January 19, 1664.—*L'Impromptu de l'hôtel de Condé*. It is a reply by a son of Montfleury.

March 17, 1664.—*La Guerre comique; ou défense de l'école des femmes*.

1664.—*Lettre sur les affaires du théâtre*, published in *Diversités galantes*, by the author of *Zélide*.

In all those quarrels the influence of Corneille was opposed to Molière, while his cause was espoused by Boileau, a useful ally, when "les comédiens et les auteurs, depuis le cèdre [Corneille?] jusqu'à l'hysope, sont diablement animés contre lui" (*Impromptu de Versailles*, sc. v.).

Molière's next piece was *Le Mariage forcé* (Feb. 15, 1664), a farce with a ballet. The comic character of the reluctant bridegroom excites contemptuous pity, as well as laughter. From the end of April till the 22nd of May the troupe was at Versailles, acting among the picturesque pleasures of that great festival of the king's. The *Princesse d'Élide* was acted for the first time, and the three first acts of *Tartuffe* were given. Molière's natural hatred of hypocrisy had not been diminished by the charges of blasphemy which were showered on him after the *École des femmes*. *Tartuffe* made enemies everywhere. Jansenists and Jesuits, like the two marquesses in *L'Impromptu de Versailles*, each thought the others were aimed at. Five years passed before Molière got permission to play the whole piece in public. In the interval it was acted before Madame, Condé, the legate, and was frequently read by Molière in private houses. The *Gazette* of the 17th of May 1664 (a paper hostile to Molière) says that the king thought the piece inimical to religion. Louis was not at that time on good terms with the *dévots*, whom his amours scandalized; but, not impossibly, the queen mother (then suffering from her fatal malady) disliked the play. A most violent attack on Molière, "that demon clad in human flesh," was written by one Pierre Roullé (*Le Roy glorieux au monde*, Paris, 1664). This fierce pamphlet was suppressed, but the king's own copy, in red morocco with the royal arms, remains to testify to the bigotry of the author, who was curé of Saint Barthélemy. According to Roullé, Molière deserved to be sent through earthly to eternal fires. The play was prohibited, as we have seen, but in August 1665 the king adopted Molière's troupe as his servants, and gave them the title of "troupe du roy." This, however, did not cause Molière to relax his efforts to obtain permission for *Tartuffe* (or *Tartufe*, or *Tartuffe*, as it was variously spelled), and his perseverance was at length successful. That his thoughts were busy with contemporary hypocrisy is proved by certain scenes in one of his greatest pieces, the *Festin de Pierre*, or *Don Juan* (Feb. 15, 1665). The legend of *Don Juan* was familiar already on the Spanish, Italian and French stages. Molière made it a new thing; terrible and romantic in its portrait of *un grand seigneur mauvais homme*, modern in its suggested substitution of *la humanité* for religion, comic, even among his comedies, by the mirthful character of Sganarelle. The piece filled the theatre, but was stopped, probably by authority, after Easter. It was not printed by Molière, and even in 1682 the publication of the full text was not permitted. Happily the copy of De la Regnie, the chief of the police, escaped obliterations, and gave us the full scene of Don Juan and the Beggar. The piece provoked a virulent criticism (*Observations sur le festin de Pierre*, 1665). It is allowed that Molière has some farcical talent, and is not unskilled as a plagiarist, but he "attacks the interests of Heaven," "keeps a school of infidelity," "insults the king," "corrupts virtue," "offends the queen-mother" and so, forth. Two replies were published, one of which is by some critics believed to show traces of the hand of Molière. The king's reply, as has been shown, was to adopt Molière's company as his servants, and to pension them. *L'Amour médecin*, a light comedy, appeared on the 22nd of September 1665. In this piece Molière, for the second time, attacked physicians. In December there was a quarrel with Racine about his play of *Alexandre*, which he treacherously transferred to the Hôtel de Bourgogne. The 4th of June 1666 saw the first representation of that famous play, *Le Misanthrope* (ou *L'Atrabilaire amoureux*, as the original second title ran). This piece, perhaps the masterpiece of Molière, was more successful with the critics, with the court, and with posterity than with the public. The rival comedians called it "a new style of comedy," and so it was. The eternal

passions and sentiments of human nature, modified by the influence of the utmost refinement of civilization, were the matter of the piece. The school for scandal kept by Célième, with its hasty judgments on all characters, gave the artist a wide canvas. The perpetual strife between the sensible optimism of a kindly man of the world (Philinte) and the *sæva indignatio* of a noble nature soured (Alceste) supplies the intellectual action. The humours of the joyously severe Célième and of her court, especially of that deathless minor poet Oronte, supply the lighter comedy. Boileau, Lessing, Goethe have combined to give this piece the highest rank even among the comedies of Molière. As to the "keys" to the characters, and the guesses about the original from whom Alceste was drawn, they are as valueless as other contemporary tattle.

A briefer summary must be given of the remaining years of the life of Molière. The attractions of *Le Misanthrope* were reinforced (Aug. 6) by those of the *Médecin malgré lui*, an amusing farce founded on an old *fabliau*. In December the court and the comedians went to St Germain, where, among other diversions, the pieces called *Mélicerte*, *La Pastorale comique* (of which Molière is said to have destroyed the MS.) and the charming little piece *Le Sicilien* were performed. A cold and fatigue seem to have injured the health of Molière, and we now hear of the consumptive tendency which was cruelly ridiculed in *Élomire hypochondre*. Molière was doubtless obliged to see too much of the distracted or pedantic physicians of an age when medicine was the battlefield of tradition, superstition, and nascent chemical science. On the 17th of April 1667 Robinet, the rhyming gazetteer, says that the life of Molière was thought to be in danger. On the 10th of June, however, he played *Le Sicilien* before the town. In the earlier months of 1667 Louis XIV. was with the army in Flanders. There were embassies sent from the comedy to the camp, and on the 5th of August it was apparent that Molière had overcome the royal scruples. *Tartuffe* was played, but Lamoignon stopped it after the first night. La Grange and La Torillière hastened to the camp, and got the king's promise that he would reconsider the matter on his return. Molière's next piece (Jan. 13, 1668) was *Amphitryon*, a free—a very free—adaptation from Plautus, who then seems to have engaged his attention; for not long afterwards he again borrowed from the ancient writer in *L'Avare*. There is a controversy as to whether *Amphitryon* was meant to ridicule M. de Montespan, the husband of the new mistress of Louis XIV. Mischelet has a kind of romance based on this probably groundless hypothesis. The king still saw the piece occasionally, after he had purged himself and forsworn sack under Mme de Maintenon, and probably neither he nor that devout lady detected any personal references in the coarse and witty comedy. As usual, Molière was accused of plagiarizing, this time from Rotrou, who had also imitated Plautus. The next play was the immortal *George Dandin* (July 10), first played at a festival at Versailles. Probably the piece was a rapid palimpsest on the ground of one of his old farces, but the addition of these typical members of a county family, the De Sotenville, raises the work from farce to satiric comedy. The story is borrowed from Boccaccio, but is of unknown age, and always new—Adolphus Crosbie in *The Small House at Allington* being a kind of modern *George Dandin*. Though the sad fortunes of this peasant with social ambition do not fail to make us pity him somewhat, it is being too refined to regard *George Dandin* as a comedy with a concealed tragic intention. Molière must have been at work on *L'Avare* before *George Dandin* appeared, for the new comedy after Plautus was first acted on the 9th of September. There is a tradition that the piece almost failed; but, if unpopular in the first year of its production, it certainly gained favour before the death of its author. *M. de Pourceaugnac* (Sept. 17, 1666) was first acted at Chambord, for the amusement of the king. It is a rattling farce. The physicians, as usual, bore the brunt of Molière's railing, some of which is still applicable. Earlier in 1669 (Feb. 5) *Tartuffe* was played at last, with extraordinary success. *Les Amants magnifiques*, a comedy-ballet, was acted first at St Germain

(Feb. 10, 1670). The king might have been expected to dance in the ballet, but from Racine's *Britannicus* (Dec. 13, 1666) the majestic monarch learned that Nero was blamed for exhibitions of this kind, and he did not wish to out-Nero Nero. Astrology this time took the place of medicine as a butt, but the satire has become obsolete, except, perhaps, in Turkey, where astrology is still a power. The *Bourgeois gentilhomme*, too familiar to require analysis, was first played on the 23rd of October 1770. The lively *Fourberies de Scapin* "saw the footlights" (if footlights there were) on the 24th of May 1671, and on the 7th of May we read in La Grange, "les Repetitions de Spysche ont commencé." La Grange says the theatre was newly decorated and fitted with machines. A "concert of twelve violins" was also provided, the company being resolute to have everything handsome about them. New singers were introduced, who did not refuse to sing unmasked on the stage. Quinault composed the words for the music, which was by Lulli; Molière and Pierre Corneille collaborated in the dialogue of this magnificent opera, the name of which (*Psyche*) La Grange eventually learned how to spell. The *Comtesse d'Escarbauges* (Feb. 2, 1672) was another piece for the amusement of the court, and made part of an entertainment called *Le Ballet des ballets*. In this play, a study of provincial manners, Molière attacked the financiers of the time in the person of M. Harpin. The comedy has little importance compared with *Les Femmes savantes* (Feb. 11), a severer *Précieuses*, in which are satirized the vanity and affectation of sciolists, pedants and the women who admire them. The satire is never out of date, and finds its modern form in *Le Monde où l'on s'ennuie*, by M. Pailleron. On the 17th of February Madeleine Béjard died, and was buried at St Paul. She did not go long before her old friend or lover Molière. *His Marriage forced*, founded, perhaps, on a famous anecdote of Gramont, was played on the 18th of July. On the 7th of August La Grange notes that Molière was indisposed, and there was no comedy. Molière's son died on the 11th of October. On the 22nd of November the preparations for the *Malade imaginaire* were begun. On the 10th of February 1673 the piece was acted for the first time. What occurred on the 17th of February we translate from the *Registre de La Grange*:—

"This same day, about ten o'clock at night, after the comedy, Monsieur de Molière died in his house, Rue de Richelieu. He had played the part of the said *Malade*, suffering much from cold and inflammation, which caused a violent cough. In the violence of the cough he burst a vessel in his body, and did not live more than half an hour or three-quarters after the bursting of the vessel. His body is buried at St Joseph's, parish of St Eustache. There is a gravestone raised about a foot above the ground."

Molière's funeral is thus described in a letter, said to be by an eyewitness, discovered by M. Benjamin Fillon:—

"Tuesday, 21st February, about nine in the evening, was buried Jean Baptiste Poquelin Molière, *l'apissier valet de chambre*, and a famous actor. There was no procession, except three ecclesiastics; four priests bore the body in a wooden bier covered with a pall; six children in blue carried candles in silver holders, and there were lackeys with burning torches of wax. The body . . . was taken to St Joseph's churchyard, and buried at the foot of the cross. There was a great crowd, and some twelve hundred livres were distributed among the poor. The archbishop had given orders that Molière should be interred without any ceremony, and had even forbidden the clergy of the diocese to do any service for him. Nevertheless a number of masses were commanded to be said for the deceased."

When an attempt was made to exhume the body of Molière in 1702, the wrong tomb appears to have been opened. Unknown is the grave of Molière.

Molière, according to Mlle Poisson, who had seen him in her extreme youth, was "neither too stout nor too thin, tall rather than short; he had a noble carriage, a good leg, walked slowly, and had a very serious expression. His nose was thick, his mouth large with thick lips, his complexion brown, his eyebrows black and strongly marked, and it was his way of moving these that gave him his comic expression on the stage." "His eyes seemed to search the depths of men's hearts," says the author of *Zéinde*. The inventories printed by M. Soulié prove that Molière was fond of rich dress, splendid furniture,

and old books. The charm of his conversation is attested by the names of his friends, who were all the wits of the age, and the greater their genius the greater their love of Molière. As an actor, friends and enemies agreed in recognizing him as most successful in comedy. His ideas of tragic declamation were in advance of his time, for he set his face against the prevalent habit of ranting. His private character was remarkable for gentleness, probity, generosity and delicacy, qualities attested not only by anecdotes but by the evidence of documents. He is probably the greatest of all comic writers within the limits of social and refined, as distinguished from romantic, comedy like that of Shakespeare, and political comedy like that of Aristophanes. He has the humour which is but a sense of the true value of life, and now takes the form of the most vivacious wit and the keenest observation, now of melancholy and pity and wonder at the fortunes of mortal men. In the literature of France his is the greatest name, and in the literature of the modern drama the greatest after that of Shakespeare. Besides his contemplative genius he possessed an unerring knowledge of the theatre, the knowledge of a great actor and a great manager, and hence his plays can never cease to hold the stage, and to charm, if possible, even more in the performance than in the reading.

The best biography of Molière on a level with the latest researches into his life is that in vol. x. of his works in *Grands écrivains de la France* (Eugène Despois and Paul Mesnard). The next best is probably that of M. Taschereau, prefixed to an edition of his works (*Œuvres complètes*, Paris, 1863). To this may be added Jules Loiseleur's *Les Points obscurs de la vie de Molière* (Paris, 1877). We have seen that M. Loiseleur is not always accurate, but he is laborious. For other books it is enough to recommend the excellent *Bibliographie moliéresque* of M. Paul Lacroix (1875), which is an all but faultless guide. The best edition of Molière's works for the purposes of the student is that published in *Les Grands écrivains de la France* (Hachette, Paris, 1874-1882). It contains reprints of many contemporary tracts, and, with the *Registre* of La Grange, and the *Collection moliéresque* of M. Lacroix, is the chief source of the facts stated in this notice, in cases where the rarity of documents has prevented the writer from studying them in the original texts. Another valuable authority is the *Recherches sur Molière et sur sa famille* of Ed. Soulié (1863). Lotheisen's *Molière, sein Leben und seine Werke* (Frankfurt, 1880), is a respectable German compilation. *Le Moliériste* (Tresse, Paris, ed. by M. Georges Monval) was a monthly serial, containing notes on Molière and his plays, by a number of contributors. The essays, biographies, plays and poems on Molière are extremely numerous. The best guide to these is the indispensable *Bibliographie* of M. Lacroix. (A. L.)

MOLINA, LUIS (1535-1600), Spanish Jesuit, was born at Cuenca in 1535. Having at the age of eighteen become a member of the Society of Jesus, he studied theology at Coimbra, and afterwards became professor in the university of Evora, Portugal. From this post he was called, at the end of twenty years, to the chair of moral theology in Madrid, where he died on the 12th of October 1600. Besides other works he wrote *Liberi arbitrii cum gratiae donis, divina praescientia, providentia, praedestinatione et reprobatione, concordia* (4to, Lisbon, 1588); a commentary on the first part of the *Summa* of Thomas Aquinas (2 vols., fol., Cuenca, 1593); and a treatise *De justitia et jure* (6 vols., 1593-1600). It is to the first of these that his fame is principally due. It was an attempt to reconcile, in words at least, the Augustinian doctrines of predestination and grace with the Semipelagianism which, as shown by the recent condemnation of Baius (*q.v.*), had become prevalent in the Roman Catholic Church. Assuming that man is free to perform or not to perform any act whatever, Molina maintains that this circumstance renders the grace of God neither unnecessary nor impossible: not impossible, for God never fails to bestow grace upon those who ask it with sincerity; and not unnecessary, for grace, although not an efficient, is still a sufficient cause of salvation. Nor, in Molina's view, does his doctrine of free-will exclude predestination. The omniscient God, by means of His "scientia media" (the phrase is Molina's invention, though the idea is also to be found in his older contemporary Fonseca), or power of knowing future contingent events, foresees how we shall employ our own free-will and treat His proffered grace, and

upon this foreknowledge He can found His predestinating decrees. These doctrines, although in harmony with the prevailing feeling of the Roman Catholic Church of the period, and further recommended by their marked opposition to the teachings of Luther and Calvin, excited violent controversy in some quarters, especially on the part of the Dominicans, and at last rendered it necessary for the pope (Clement VIII.) to interfere. At first (1594) he simply enjoined silence on both parties so far as Spain was concerned; but ultimately, in 1598, he appointed the "Congregatio de auxiliis Gratiae" for the settlement of the dispute, which became more and more a party one. After holding very numerous sessions, the "congregation" was able to decide nothing, and in 1607 its meetings were suspended by Paul V., who in 1611 prohibited all further discussion of the question "de auxiliis," and studious efforts were made to control the publication even of commentaries on Aquinas. The Molinist subsequently passed into the Jansenist controversy (see JANSENISM).

A full account of Molina's theology will be found in Schneeman's "Entscheidung der thomistisch-molinistischen Controverse," published in the *Appendices* (Nos. 9, 13, 14) to the *Jesuit periodical, Stimmen aus Maria-Laach*. To the lay reader may be recommended Ernest Renan's article, "Les congrégations de *auxiliis*" in his *Nouvelles études d'histoire religieuse*.

MOLINE, a city of Rock Island county, Illinois, U.S.A., in the north-west part of the state, on the Mississippi river, adjoining the city of Rock Island and opposite the upper end of Rock Island. Pop. (1900), 17,248, of whom 5609 were foreign-born, principally Swedes and Belgians; (1910 census), 24,199. It is served by the Chicago, Burlington & Quincy, the Chicago, Milwaukee & St Paul, the Chicago, Rock Island & Pacific, and the Davenport, Rock Island & North-Western railways. A channel in the Mississippi river here, 250 ft. wide and 4 ft. deep at low water, projected in 1905, was completed in 1908; and in 1907 a lock was finished which affords a draught of 6 ft. and is a part of the 6 ft. channel improvement of Rock Island Rapids. The city has large and varied manufacturing industries; water-power is derived from a dam maintained by the Moline Water-Power Company; and there is a large electric-power plant. The most important industry is the manufacture of agricultural implements (particularly steel ploughs, which seem to have been made here first in the United States, and corn-planters). Among the other manufactures are boilers and gasolene engines, wagons and carriages, automobiles, and pianos and organs. The Chicago, Rock Island & Pacific railway has a 900-acre yard and machine shop east of the city limits, and there is a large U.S. arsenal on Rock Island. Moline was settled in 1832, laid out as a town in 1842, and was chartered as a city in 1855 and rechartered in 1872.

MOLINET, JEAN (1433-1507), French poet and chronicler, was born at Desvres (Pas de Calais). In 1475 he succeeded Georges Castellain as historiographer of the house of Burgundy, and Margaret of Austria, governor of the Low Countries, made him her librarian. His continuation of Castellain's chronicle, which covers the years from 1474 to 1504, remained unpublished until 1828 when it was edited (Paris, 5 vols.) by J. A. Buchon. It is far from possessing the historical value of his predecessor's work. A selection from his voluminous poetical works was published at Paris in 1531, *Les Faicts et Dicts de J. . . Jehan Molinet*. . . He also translated the *Roman de la rose* into prose (pr. Lyons, 1503). He became, in 1501, canon of the church of Notre-Dame at Valenciennes, where he died on the 23rd of August 1507. He is noteworthy as the head of the vicious Burgundian school of poetry known as the *rhetoriqueurs*, characterized by the excessive use of puns and of puerile metrical devices. His chief disciple was his nephew, Guillaume Crétin (d. 1525), ridiculed by Rabelais as Raminagrobis, and Jean Lemaire des Belges was his friend.

See A. Wauters in the *Biographie nationale de Belgique* (vol. xv., 1890).

MOLINIER, AUGUSTE (1831-1904), French historian, was born at Toulouse on the 30th of September 1831. He was a pupil at the *École des Chartes*, which he left in 1873, and also

at the École des Hautes Études; and he obtained appointments in the public libraries at the Mazarine (1878), at Fontainebleau (1884), and at St Geneviève, of which he was nominated librarian in 1885. He was a good palaeographer and had a thorough knowledge of archives and manuscripts; and he soon won a first place among scholars of the history of mediæval France. His thesis on leaving the École des Chartes was his *Catalogue des actes de Simon et d'Amour de Montfort* (inserted in vol. xxiv. of the *Bibliothèque de l'École*, an important contribution to the history of the Albigenses. This marked him out as a capable editor for the new edition of *L'histoire générale de Languedoc* by Dom Vaissète: he superintended the reprinting of the text, adding notes on the feudal administration of this province from 900 to 1250, on the government of Alphonso of Poitiers, brother of St Louis from 1226 to 1271, and on the historical geography of the province of Languedoc in the middle ages. He also wrote a *Bibliographie du Languedoc*, which was awarded a prize by the *Académie des inscriptions et belles-lettres*, but remained in manuscript. He also published several documents for the Société de l'Orient Latin (*Itinera hierosolymitana*, in collaboration with Ch. Kohler, 1885); for the Société de l'Histoire de France (*Chronique normande du XIV^e siècle*, assisted by his brother Émile, 1883); for the *Collection de textes relatifs à l'enseignement de l'histoire (Vie de Louis le Gros*, by Suger, 1887); for the *Collection des documents inédits (Correspondance administrative d'Alfonse de Poitiers, 1894-1900)*; for the *Recueil des historiens de la France (Obituaires de la province de Sens 1904, 1906)*, &c., and several volumes in the *Recueil des catalogues des bibliothèques publiques de France*. Applying to the French classics the rigorous method used with regard to the texts of the middle ages, he published the *Pensées* of Pascal, revised with the original manuscript (1887-1889), and the *Provinciales* (1891), edited with notes. In 1893 he was nominated professor at the École des Chartes, and gave a successful series of lectures which he published (*Manuel des sources de l'histoire de France au moyen âge, 1902-1906*). He also taught at the École des Hautes Études. He died on the 19th of May 1904, after a short illness, leaving in manuscript a criticism on the sources of the *Speculum historiale* of Vincent de Beauvais.

His elder brother, CHARLES (b. 1843), is also of some importance as an historian, particularly on the history of art and on the heresies of the middle ages. He was appointed professor of history at the university of Toulouse in 1886.

A younger brother, ÉMILE (1857-1906), became an assistant in the print-room at the Bibliothèque Nationale, and afterwards joined the staff at the Musée du Louvre, of which he eventually became keeper, retiring in 1902. He was a well-known connoisseur of art. He organized the famous Exposition Retrospective held at the Petit Palais in 1900, and published a number of expert volumes on enamels, ceramics and furniture.

MOLINOS, MIGUEL DE (c. 1640-1697), Spanish divine, the chief apostle of the religious revival known as Quietism, was born about 1640 near Saragossa. He entered the priesthood and settled in Rome about 1670. There he became well known as a director of consciences, being on specially friendly terms with Cardinal Odescalchi, who in 1676 became Pope Innocent XI. In the previous year Molinos had published a volume, *Guida spirituale, che disinvolve l'anima e la conduce per l'interior cammino all'acquisto della perfetta contemplazione e del ricco tesoro della pace interiore*. This was shortly followed by a brief *Trattato della quotidiana comunione*. No breath of suspicion arose against Molinos until 1681, when the Jesuit preacher, Segneri, attacked his views, though without mentioning his name, in his *Concordia tra la fatica e la quiete nell'orazione*. The matter was referred to the Inquisition. It pronounced that the *Guida spirituale* was perfectly orthodox, and censured the intemperate zeal of Segneri. But the Jesuits set Father La Chaise to work on his royal penitent, Louis XIV., who prided himself on being a pillar of orthodoxy; but he was on very bad terms with Innocent XI., and soon yielded to the pleasure of discovering heresy in an intimate friend of the pope. Following on official representations by the French ambassador in Rome,

who happened to be a cardinal, Molinos was arrested in May 1685. At first his friends were confident of an acquittal, but in the beginning of 1687 a number of his penitents of both sexes were examined by the Inquisition, and several were arrested. A report got abroad that Molinos had been convicted of moral enormities, as well as of heretical doctrines; and it was seen that he was doomed. On the 3rd of September 1687 he made public profession of his errors, and was sentenced to imprisonment for life. In the following November, Innocent signed a bull condemning sixty-eight propositions from the *Guida spirituale* and other unpublished writings of its author. At some date unknown in 1696 or 1697 Molinos died in prison.

Contemporary Protestants saw in the fate of Molinos nothing more than a persecution by the Jesuits of a wise and enlightened man, who had dared to withstand the petty ceremonialism of the Italian piety of the day. But Molinos was much more than the enlightened semi-Protestant that his English admirers took him to be; and his Quietism, had it been suffered to run its course would have swept aside beliefs and practices more important than the rosaries of nuns, though it is most unlikely that he realized the consequence of his own theories. Segneri and La Chaise were not so easily deceived. They were Jesuits; and Jesuitism is built up on the double assumption that God reveals Himself wholly and only through Jesus, and that Jesus reveals Himself wholly and only through the Church of Rome. Luther had already broken through one link in this chain, when he taught the Protestant world to come directly to Jesus, without troubling about the Church; but Luther still assumed that God could only be reached through the intermediacy of Jesus. Molinos wished to find a royal road to God without any intermediaries at all. The Reformation maintained that the Church, so far from being a help, was a hindrance, to union with Jesus; whereas Molinos welcomed both Church and Jesus as helps to union with God, always provided that the believer treated both as means to an end beyond themselves. In other words, he held that there was a triple stage in piety. Beginners gave themselves wholly to the Church. At the second step came devotion to Jesus. At the third and highest stage both Church and Jesus were left behind as *deiformes, sed non Deus*, and God remained alone.

But how could a finite being bring himself into direct relation with Infinity? Following very ancient precedents, Molinos fell back on those phenomena of our consciousness which seem least within our own power. The less sense of proprietorship we had in a thought or action—the less it was the fruit of our deliberate will—the more certain might we be that it was divinely inspired. But what state of mind is most likely to be visited by these spontaneous illuminations? Plainly the state that Molinos calls the "soft and savoury sleep of nothingness," where the soul is content to fold its hands, and wait in dreamy musing till the message comes; meanwhile it will think, do, will as little as it can. For this reason disinterested love became the great hall-mark of Quietist sanctity. Why it is unfitted to be a test of sanctity in general has been explained at length by Bossuet in a remarkable *Instruction sur les états d'oraison*, published while the Quietist controversy was at its height. But, although Molinos's system did not long survive him, he had at least the double merit of courage and tenacity. Few writers have struggled so long and so hard to disengage the essence of religion from its transitory embodiment in an historical creed.

The *Guida spirituale* was published in Italian in 1675, and has been reprinted. An English translation appeared in 1688; it has been re-edited by Mrs Arthur Lyttelton. French, Spanish and Latin translations have also appeared. For the history of its author see C. E. Scharling, *Michael de Molinos* (Ger. trans. from Danish; Gotha, 1855). H. Heppé, *Geschichte der Quietistischen Mystik* (Berlin, 1875). On the whole subject of Quietism see H. Delacroix, *Études d'histoire et de psychologie du mysticisme* (Paris, 1908). There is a brilliant, but very fanciful, account of Molinos and his doctrines in J. H. Shorthouse's romance, *John Inglesant*. (St. C.)

MOLIQUE, WILHELM BERNHARDT (1802-1869), German violinist and composer, was born at Nuremberg on the 7th of October, 1802, and learnt the violin at Munich under Pietro

Rovelli. In 1826 he became music-director at Stuttgart. As a composer for the violin Molique was commonly compared with Spohr. He also wrote some charming songs. He died at Cannstadt in 1869.

MOLKO (1500-1532), a Marano kabbalist, who proclaimed the advent of the Messiah. He was associated with David Reubeni, who also made Messianic claims. Molko, after a chequered career, was condemned to death by the ecclesiastical court at Mantua. He was offered his life by the emperor Charles V. if he would return to Christianity, in which he had been educated. He refused, and died at the stake. (I. A.)

MÖLLENDORF, RICHARD JOACHIM HEINRICH VON (1724-1816), Prussian soldier, began his career as a page of Frederick the Great in 1740. The outbreak of the Silesian wars gave him his first opportunity of seeing active service, and the end of the second war saw him a captain. In the Seven Years' War his brilliant conduct at the churchyard of Leuthen (1757) and at Hochkirch won him his majority. In 1760 his exertions retrieved the almost lost battle of Torgau, and the last success of the great king was won by the brigades of Prince Wied and Möllendorf (now major-general) at the Burkersdorf heights. Seventeen years later, as lieutenant-general, he won at Brix one of the few successes of the Bavarian Succession (or "Potato") War. In the years of peace he occupied considerable posts, being made governor of Berlin in 1783. Promoted general of infantry in 1787, and general field marshal in 1793, he commanded the Prussian army on the Rhine in 1794. In the disastrous campaign of Jena (1806) Möllendorf played a considerable part, though he did not actually command a corps. He was present with the king at Auerstädt, falling into the hands of the French in the débâcle which followed. After his release he passed the remainder of his life in retirement. He died in 1816.

MOLLIEU, NICOLAS FRANÇOIS, COUNT (1758-1850), French financier, was born at Paris on the 28th of February 1758. The son of a merchant, he early showed ability, and entered the ministry of finance, where he rose rapidly; in 1784, at the time of the renewal of the arrangements with the farmers-general of the taxes, he was practically chief in that department and made terms advantageous to the national exchequer. Under Calonne he improved the returns from the farmers-general; and he was largely instrumental in bringing about the erection of the *octroi* walls of Paris in place of the insufficient wooden barriers. He, however, advocated an abolition of some of the restrictions on imports, as came about in the famous Anglo-French commercial treaty of 1786, to the conclusion of which he contributed in no small measure. The events of the French Revolution threatened at times to overwhelm Mollieu. In 1794 he was brought before the revolutionary tribunal of Evreux as a suspect, and narrowly escaped the fate that befell many of the former farmers-general. He retired to England, where he observed the financial measures adopted at the crisis of 1796-1797. After the *coup d'état* of Brumaire (November 1799) he re-entered the ministry of finance, then under Gaudin, who entrusted to him important duties as director of the new *caisse d'amortissement*. Napoleon, hearing of his abilities, frequently consulted him on financial matters, and after the Proclamation of the Empire (May 1804) made him a councillor of state. The severe financial crisis of December 1805 to January 1806 served to reveal once more his sound sense. Napoleon, returning in haste not long after Austerlitz, dismissed Barge-Marbois from the ministry of the treasury and confided to Mollieu those important duties. He soon succeeded in freeing the treasury from the interference of great banking houses. In other respects, however, he did something towards curbing Napoleon's desire for a precise regulation of the money market. The conversations between them on this subject, as reported in Mollieu's *Mémoires*, are of high interest, and show that the ministry had a far truer judgment on financial matters than the emperor, who often twitted him with being an *idéologue*. In 1808 Mollieu was awarded the title of count. He soon came to see the impossibility of the measures termed collectively "the continental

system"; but his warnings on that subject were of no avail. After the first abdication of the emperor (April 11, 1814), Mollieu retired into private life, but took up his ministerial duties at the appeal of Napoleon during the Hundred Days (1815), after which he again retired. Louis XVIII. wished to bring him back to office, but he resisted these appeals. Nominated a peer in 1819, he took some part in connexion with the annual budgets. He lived to see the election of Louis Napoleon as president of the Second Republic, and died in April 1850, with the exception of Pasquier, the last surviving minister of Napoleon I.

See Mollieu's *Mémoires d'un ministre du trésor public 1780-1815*, 4 vols. (Paris 1845; new ed., Paris, 3 vols., 1898); A. G. P. Barante, *Études historiques et biographiques*; Salvandy, *Notice sur Mollieu*; also M. M. C. Gaudin (duc de Gaëte), *Notice historique sur les finances de la France 1800-1814* (Paris, 1818). (J. H. L. R.)

MOLLUSCA, one of the great "phyla," or sub-kingdoms, of the animal pedigree or kingdom. The shell-bearing forms belonging to this group which were known to Linnaeus were placed by him (in 1748) in the third order of his class Vermes under the name "Testacea," whilst the Echinoderms, Hydroids and Annelids, with the naked Mollusca, formed his second order termed "Zoophyta." Ten years later he replaced the name "Zoophyta" by "Mollusca," which was thus in the first instance applied, not to the Mollusca at present so termed, but to a group consisting chiefly of other organisms. Gradually, however, the term Mollusca became used to include those Mollusca formerly placed among the "Testacea," as well as the naked Mollusca.

It is important to observe that the term *μαλακία*, of which Mollusca is merely a latinized form, was used by Aristotle to indicate a group consisting of the cuttle-fishes only.

As now classified, the Mollusca consist of the following subdivisions:—

Grade A.—Isopleura.

Class I.—Amphineura (see *CHITONS*).

Grade B.—Prophidieglossomorpha.

Class II.—Gastropoda (*g.v.*).

Class III.—Scaphopoda (*g.v.*).

Class IV.—Lamellibranchia (*g.v.*).

Grade C.—Siphonopoda.

Class V.—Cephalopoda (*g.v.*).

History of Classification.—The definite erection of the Mollusca into the position of one of the great primary groups of the animal kingdom is due to George Cuvier (1788-1800), who largely occupied himself with the dissection of representatives of this type.¹ An independent anatomical investigation of the Mollusca had been carried on by the remarkable Neapolitan naturalist Poli (1791), whose researches² were not published until after his death (1817), and were followed by the beautiful works of another Neapolitan zoologist, the illustrious Delle Chiaje.³

The *embranchement* or sub-kingdom Mollusca, as defined by Cuvier, included the following classes of shellfish: (1) the cuttles or pulps, under the name *CEPHALOPODA*; (2) the snails, whelks and slugs, both terrestrial and marine, under the name *GASTROPODA*; (3) the sea-butterflies or winged-snails, under the name *PTEROPODA*; (4) the clams, mussels and oysters, under the name *ACEPHALA*; (5) the lamp-shells, under the name *BRACHIOPODA*; (6) the squirts or ascidians, under the name *NUDA*; and (7) the barnacles and sea-acorns, under the name *CIRRHOPODA*.

The main limitations of the sub-kingdom or phylum Mollusca, as laid down by Cuvier, and the chief divisions thus recognized within its limits by him, hold good to the present day. At the same time, three of the classes considered by him as Mollusca have been one by one removed from that association in consequence of improved knowledge, and one additional class, incorporated since his day with the Mollusca with general approval, has, after more than forty years, been again detached and assigned an independent position owing to newly acquired knowledge.

The first of Cuvier's classes to be removed from the Mollusca was that of the Cirrhopoda. Their affinities with the lower Crustacea were recognized by Cuvier and his contemporaries, but it was one of the brilliant discoveries of that remarkable and too-little-honoured naturalist, J. Vaughan Thompson, of Cork, which decided their position as Crustacea. The metamorphoses of the Cirrhopoda were described and figured by him in 1830 in a very complete manner, and the legitimate conclusion as to their affinities was formulated by him.⁴ Thus it is to Thompson (1830), and not to Burmeister (1834), as erroneously stated by Kieferstein, that the merit of this discovery belongs. The next class to be removed from Cuvier's

* These figures refer to the Bibliography at the end of the article.

Mollusca was that of the Nuda, better known as Tunicata. In 1866 the Russian embryologist Kowalewsky started the zoological world with a minute account of the developmental changes of *Ascidia*, one of the Tunicata,⁷ and it became evident that the affinities of that class were with the Vertebrata, whilst their structural agreements with Mollusca were only superficial. The last class which has been removed from the Cuvierian Mollusca is that of the Lamp-shells or Brachiopoda. The history of its dissociation is connected with that of the class, viz. the Polyzoa or Bryozoa, which has been both added to and again removed from the Mollusca between Cuvier's date and the present day. The name of J. Vaughan Thompson is again that which is primarily connected with the history of a Molluscan class. In 1830 he pointed out that among the numerous kinds of "polyps" at that time associated by naturalists with the Hydroids, there were many which had a peculiar and more elaborate type of organization, and for these he proposed the name Polyzoa. Subsequently⁸ they were termed Bryozoa by Ehrenberg (1831).

Henri Milne-Edwards in 1844 demonstrated the affinities of the Polyzoa with the Molluscan class Brachiopoda, and proposed to associate the three classes Brachiopoda, Polyzoa and Tunicata in a large group "Molluscoïdes," co-ordinate with the remaining classes of Cuvier's Mollusca, which formed a group retaining the name Mollusca. By subsequent writers the Polyzoa have in some cases been kept apart from the Mollusca and classed with the "Vermes"; whilst by others they have, together with the Brachiopoda, been regarded as true Mollusca. Increase of knowledge has now, however, established the conclusion that the agreement of structure supposed to obtain between Polyzoa and true Mollusca is delusive; and accordingly they, together with the Brachiopoda, were removed from the Molluscan phylum by Lankester in 1883. In the 9th edition of this work (on the which present article is based). Further details in regard to this, the last revision in Molluscan classification, will be found in the article POLYZOIA.

As thus purified by successive advances of embryological research, the Mollusca were reduced to the Cuvierian classes of Cephalopoda, Pteropoda, Gastropoda and Acephala. Certain modifications in the disposition of these classes are naturally enough rendered necessary by the vast accumulation of knowledge as to the anatomy and embryology of the forms comprised in them. Foremost among those who between 1840 and 1880 laboured in this field are the French zoologists Henri Milne-Edwards,⁹ and Lacaze Duthiers,¹⁰ to the latter of whom we owe the most accurate dissections and beautiful illustrations of a number of different types. To Kölliker,¹¹ Gegenbaur,¹² and more recently Spenger,¹³ amongst German anatomists, we are indebted for epoch-making researches of the same kind. In England, Owen's anatomy of the pearly nautilus,¹⁴ Huxley's discussion of the general morphology of the Mollusca,¹⁵ and Lankester's embryological investigations,¹⁶ have aided in advancing our knowledge of the group. Two remarkable works of a systematic character dealing with the Mollusca deserve mention here—by Dr S. P. Woodward,¹⁷ and the Dr. S. P. Woodward's model of clear systematic exposition, and the exhaustive treatise on the Malacozoa or Weichthiere by Professor Kerferstein of Göttingen, published as part of Bronn's *Klassen und Ordnungen des Thier-Reichs*.

The arrangement adopted by Ray Lankester in the 9th edition of the *Ency. Brit.* (art. "Mollusca"; 1883) was as follows: Of the four Cuvierian classes mentioned above, the Pteropoda were united with the Cephalopoda, on account of the apparent similarity of the cephalic tentacles in some of the former to the arms of the latter. An additional class was instituted for the reception of *Dentatium* and its few allies, and for this class Broom's name Scaphopoda was used. The Chitons and their allies were placed under the Gastropoda, as a distinct branch called Isopleura, and for the Acephala de Blainville's name Lamellibranchia was substituted. The latter were regarded as forming a distinct branch, equivalent in rank to the other three classes together, the latter all possessing the radula which is wanting in Lamellibranchs.

Since the 9th edition of the *Ency. Brit.* was published important advances have been made in our knowledge of the Mollusca, as the result of researches largely due to the interest excited in the subject by Lankester's article. Attention has been especially directed to the investigation of the most primitive forms in each group, and accordingly we can now form much more definite conceptions of the phylogeny and evolution of the various classes. The most important and extensive contributions to this progress have been made by the Belgian zoologist, Dr Paul Pelseener, who has made the Mollusca his special study.

The *Chitonidae* and the *Apalacophora* are now separated from the Gastropoda and raised to the rank of a distinct class, under the name of Amphineura. On the other hand, Boas and Pelseener have shown that the Pteropoda have nothing to do with the Cephalopoda, but are Gastropoda modified for a pelagic life; they are therefore now united with the Gastropoda. The Lamellibranchia are no longer regarded as a distinct branch in contrast to the remaining Mollusca; according to Pelseener they are allied to the Gastropoda and Scaphopoda, all three classes being derived from a common hypothetical ancestor, called *Prohrispidoglossum*. These three classes have therefore been united by Grobben into one branch or grade, the *Prohrispidoglossomorphia*.

General Characters of the Mollusca.—The forms comprised in the various groups, whilst exhibiting an extreme range of variety in shape, as may be seen on comparing an oyster, a cuttle-fish, and a sea-slug such as *Doris*; whilst adapted, some to life on dry land, others to the depths of the sea, others to rushing streams; whilst capable, some of swimming, others of burrowing, crawling or jumping, some, on the other hand, fixed and immobile; some amongst the most formidable of carnivores, others feeding on vegetable mud, or on the minutest of microscopic organisms—yet all agree in possessing in common a very considerable number of structural details which are not possessed in common by any other animals.

The structural features which the Mollusca do possess in common with other animals belonging to other great phyla of the animal kingdom are those characteristic of the Coelomata, one of the two great grades (the other and lower being that of the Coelentera) into which the higher animals, or Metazoa as distinguished from the Protozoa, are divided. The Metazoa all commence their individual existence as a single cell or plastid, which multiplies itself by transverse division. Unlike the cells of Protozoa, these embryonic cells of the Metazoa do not remain each like its neighbour and capable of independent life, but proceed to arrange themselves into two layers, taking the form of a sac. The cavity of the two-cell-layered sac or diblastula thus formed is the primitive gut or arch-enteron. In the Coelentera, whatever subsequent changes of shape the little sac may undergo as it grows up to be polyp or jelly-fish, the original arch-enteron remains as the one cavity pervading all regions of the body. In the Coelomata, on the other hand, there is another cavity, dividing the body-wall into two layers: an internal layer surrounding the gut, and an external layer. This cavity is excavated in a third mass of cells distinct from the cells lining the gut, forming the endoderm, and the cells covering the surface of the body, the ectoderm. This third mass of cells is the mesoderm. The Mollusca agree in being coelomate with the phyla Vertebrata, Platyhelminthia (flat-worms), Echinodermata, Appendiculata (insects, ringed-worms, &c.), and others—in fact, with all the Metazoa except the sponges, corals, polyps, and medusae.

In common with all other Coelomata, the Mollusca are at one period of life possessed of a prostomium or region in front of the mouth, which is the essential portion of the "head," and is connected with the property of forward locomotion in a definite direction and the steady carriage of the body (as opposed to rotation of the body on its long axis). As a result, the Coelomata, and with them the Mollusca, present (in the first instance) the general condition of body known as bilateral symmetry; the dorsal is differentiated from the ventral surface, whilst a right and a left side similar, to, or rather the complements of, one another are permanently established. In common with all other Coelomata, the Mollusca have the mouth and first part of the alimentary canal which leads into the met-enteron formed by a special invagination of the outer layer of the primitive body-wall, not to be confounded with that which often, but not always, accompanies the antecedent formation of the arch-enteron; this invagination is termed the stomodaeum. Similarly an anal aperture is formed in connexion with a special invagination which meets the hinder part of the met-enteron, and is termed the proctodaeum.

The coelom is primarily and essentially the generative cavity: the reproductive cells arise from its walls, i.e. from the coelomic epithelium. True nephridia do not primarily open into the coelom, as was formerly taught, but are intra-cellular ducts in the mesoderm. Such organs are absent in Mollusca in the adult state, but a pair of nephridia usually occurs in the larva. The coelom opens to the exterior by ducts which are primarily genital ducts by which the ova or sperms are discharged. These ducts, however, as well as the coelomic epithelium, may assume excretory functions. In Mollusca the coelom is reduced and consists of two parts, the pericardial cavity which surrounds the heart, and the cavity of the gonads or generative organs. There is usually one pair of coelomic ducts leading from the

pericardium to the exterior, and these are the excretory organs or kidneys, formerly known as the organs of Bojanus. The walls of the pericardium are also excretory in parts, these parts forming the pericardial glands. In the majority of Mollusca the gonads are provided with a pair of ducts of their own. There are thus two pairs of coelomic ducts. This fact gives rise to the question whether the Mollusca are to be regarded as primitively segmented animals or not. In animals which exhibit typical segmentation or metamerism, such as segmented worms (Chaetopoda), each segment or metamere possesses its own coelomic cavity, a pair of coelomic ducts, and a pair of nephridia. The structure of the Mollusca in the greater number of cases agrees with the hypothesis that the primitive form was unsegmented, and therefore had but one pair of coelomic ducts and one pair of nephridia. In existing forms the latter disappear in the adult. In the most primitive forms of several classes there are no distinct genital ducts, the gonads when mature discharging into or through the kidneys. Among the Gastropoda, in the Aspidobranchia, there is no genital duct, and the gonad opens into the right kidney; in the more modified forms the left kidney alone is functional, the right has been converted into the genital duct. Among the Lamellibranchia again the kidneys serve as genital ducts in the Protobranchia and some Filibranchia. In the higher forms the opening of the gonad is shifted more and more towards the external aperture of each kidney until finally it is situated on the external surface, and thus the gonad secondarily acquires an independent aperture. In the Scaphopoda there is no distinct genital duct, the relations are as in Aspidobranchia. Among the Amphineura we find one pair of coelomic ducts in the Aplacophora, two pairs in the Chitons. In the former the genital coelom and the pericardial coelom are continuous and the reproductive cells escape by the renal ducts. In the Chitons or Polyplacophora, on the other hand, the two cavities are separate, and there are independent genital ducts. It is possible therefore to regard the latter condition as secondary, and to conclude that the separate genital ducts have been derived from the original single pair of coelomic ducts, as in Lamellibranchia.

The Cephalopoda, however, do not harmonize so well with this view. The earliest forms of this class geologically are the Nautiloidea. Assuming that these ancestral forms resembled the existing *Nautilus* in their internal anatomy, they had two pairs of renal ducts and one pair of genital ducts, which would apparently indicate, not a single metamere or unsegmented body, but three metameres. There are however only two pairs of branchiae. The Dibranchia, with only one pair of branchiae, one pair of renal organs, and one pair of genital ducts, are much more recent, not appearing till the end of the Secondary epoch, and therefore must be regarded as descended from the Tetrabranchia. The latter are represented in the Upper Cambrian formations, together with Lamellibranchia and Gastropoda, and there are no earlier Molluscan fossils than these. Palaeontology therefore throws no light on the question whether the metameric or the unsegmented Mollusca were the earlier. The development of the Cephalopoda affords at present no better evidence that the metamerism is secondary. That of *Nautilus*, which would be most important in this inquiry, is unfortunately still unknown. In the Dibranchia true nephridia have not been detected in the embryo, nor has it been shown that the genital ducts are derived from the renal tubes. On the other hand, there is no evidence that the forms which show no metamerism, such as the Gastropoda, are descended from metameric ancestors. On the whole, then, the most probable conclusion is that the original ancestral form of the Mollusca was unsegmented, possessed one pair of true nephridia, and one pair of coelomic ducts whose function was to conduct the generative products to the exterior. The chief types of Mollusca were already differentiated at the beginning of the geological record, and the metamerism which occurs in the Cephalopoda has been evolved within the limits of that class.

External Characters.—The characteristic organs of Mollusca are the mantle and shell, the foot, the tentacles and the radula,

of which all but the last are external. The original form was bilaterally symmetrical, and this symmetry is retained in all the classes except the Gastropoda. At the anterior end the head is differentiated; it bears the sense-organs, and contains the muscular pharynx within which is the radular apparatus. The rest of the body consists of the foot ventrally and the visceral mass dorsally. The foot is a muscular mass without cuticle or skeleton, excepting certain cuticular structures such as the byssus of Lamellibranchs and the operculum of Gastropods, which do not aid in locomotion. The foot is usually the only organ of locomotion. It corresponds to the ventral part of the body-wall in other animals. The muscular tissue of the dorsal body-wall is much reduced and the integument here is thin and

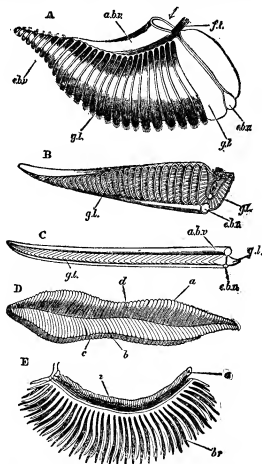

FIG. 1.—Ctenidia of various Mollusca (original).

- A, Of *Chiton*: *f.t.*, fibrous tissue; *a.b.v.*, afferent blood-vessel; *e.b.v.*, efferent blood-vessel; *g.l.*, laterally paired lamellae.
 B, Of *Sepia*: letters as in A.
 C, Of *Fissurella*: letters as in A.
 D, Of *Nucula*: *d*, position of axis with blood-vessels; *a*, inner; *b* and *c*, outer row of lamellae.
 E, Of *Paludina*: *i*, intestine running parallel with the axis of the ctenidium and ending in the anus *a*; *br.*, rows of elongate processes corresponding to the two series of lamellae of the upper figures.

soft. The external epithelium of the dorsal region secretes the shell. Between the edge of the shell and the foot there is a groove or cavity, chiefly developed laterally and posteriorly. The dorsal border of this groove is extended outwards and downwards as a fold of the integument. There is some confusion of terms here: some writers call the free fold the mantle or pallium, and this is the proper use of the term; but others apply the term to the whole of the dorsal integument, including both the projecting fold and the part covering the viscera. The shell extends to the edge of the mantle-fold, and the cavity between the mantle and the side of the body is the pallial chamber. This chamber serves two purposes: it is primarily

the respiratory cavity containing the gills, but it also serves to enclose the body so that the latter is surrounded by the shell, from which the head and foot can be protruded at the will of the animal.

The shell consists of an organic basis the substance of which is called conchiolin, impregnated with carbonate of lime, with a small proportion, 1-2 %, of phosphate of lime. On the outside of the shell is a non-calcified layer of conchiolin called the periostracum, secreted by the thickened edge of the mantle. The zone of the external surface of the mantle within the edge secretes a layer formed of prisms of calcite; the rest of the epithelium from this zone to the apex secretes the inner layer of the shell, composed of successive laminae; this is the nacreous layer, and in certain species has a commercial value as nacre or mother-of-pearl. Thus the growth of the shell in extent is due to additions to the prismatic layer at the edge, its growth in thickness to new layers of nacre deposited on its inner surface. In many cases in various classes the mantle is reflected over the edges of the shell, so as to cover more or less completely its outer surface. When this covering is complete the shell is contained in a closed sac and is said to be "internal," but the sac is lined by ectoderm and the shell is always morphologically external. In one or two cases the epithelium of the foot secretes a calcified shell, which is either free as in *Argonauta* or adherent as in *Hippocyx*.

The ctenidia (fig. 1) are the branchial organs of the Mollusca. In the primitive condition there is one on each side in the mantle cavity, towards the posterior end of the body. Each is an outgrowth of the body-wall at the side of the body, and consists of an axis containing two main vessels, an afferent and efferent, and bearing on either side a series of transverse plates whose blood-sinuses communicate with the vessels of the axis. The afferent vessel of the ctenidium receives blood from the vena cava or principal blood-sinus of the body, the efferent vessel opens into the auricle of its own side. Near the base of the ctenidium is a patch of sensory epithelium innervated from the branchial nerve, forming a sense-organ called the osphradium, whose function is to test the water entering the branchial cavity. The branchial current is maintained by the cilia which cover the surface of the ctenidia, except in Cephalopoda, in which cilia are absent and the current is due to muscular action. Thus in the primitive mollusc the mantle-cavity contains a symmetrical group of structures at the posterior end of the body, and this group of structures is called the pallial complex. It consists of the anus in the middle, a renal organ and renal aperture on each side of this, and a ctenidium outside or anterior to the renal organ, an osphradium being situated at the base of the ctenidium.

Internal Anatomy: Digestive Tube.—In primitive Mollusca the mouth and anus are the two extremities of the body, but the anus may be brought to an anterior position by a ventral flexure, complicated in Gastropoda by a lateral torsion. The alimentary tube consists of three regions: firstly, the anterior buccal mass with the oesophagus, of ectodermic origin, and therefore bearing cuticular structures, namely the jaws and radula; secondly, the mid-gut, of endodermic origin and including the stomach and liver; and, thirdly, the hind-gut or intestine. The radula consists of a chitinous band bearing teeth, secreted by a ventral caecum of the pharynx and moved by an apparatus of cartilage and muscles. It was present in the ancestral mollusc, occurs in nearly all archaic types, and is only absent in the most specialized forms, in which it has evidently been lost; these forms are certain Neomeniomorpha, all the Lamellibranchia, various degenerate Gastropoda, and the *Cirrhoteuthidae* among Cephalopoda. The teeth are secreted by a small number of cells at the closed end of the caecum, the basal membrane by a transverse row of cells in front of these. The teeth are disposed in transverse rows, and in each row they are arranged symmetrically on either side of a central tooth. In Polyplacophora there are eight on each side (8.1.8); in Scaphopoda two on each side (2.1.2); in almost all Cephalopoda three on each side (3.1.3); in Gastropoda the number varies very much in different subdivisions. Beneath the anterior parts of the radula where it emerges from the caecum are a pair of cartilages, and attached to these a number of special muscles by which the radula is moved backwards and forwards to act as a rasp. The secretion of the radula at the closed end of the caecum is continuous, so that it is constantly growing forward as fast as its exposed anterior portion is worn away by use, just as a fingernail is pushed forward by constant growth at its posterior end,

and is worn away or has to be cut short from time to time at its outer end.

Circulation.—The system of blood-vessels is entirely separate from the coelomic cavities. It consists of arteries, veins and sinuses, but ramified capillaries are usually absent except in the integuments of Cephalopods. The arteries and veins have proper endothelial walls; they pass abruptly into the sinuses and in some cases communication is effected by orifices in the walls of the vessels, as for example in the vena cava of *Nautilus*. The heart is situated in the pericardium on the dorsal side of the intestine and at the posterior end of the animal. The pericardium never contains blood, as is well shown in those forms which have red corpuscles in their blood; these corpuscles are never found in the pericardium.

The heart receives blood from the gills and mantle, and pumps it through arteries to the body. It consists of a median ventricle with muscular walls and a cavity traversed by muscular strands. On either side of the ventricle, in the primitive condition, is a thin-walled auricle, opening into the ventricle by a valved opening. Each auricle forms the terminal enlargement of the efferent vein of the ctenidium of its own side. In *Nautilus* two pairs of auricles are present, corresponding with the two pairs of ctenidia. In the primitive form a single anterior aorta is given off from the ventricle, the two together representing the dorsal blood-vessel of Chaetopods. In more specialized forms a posterior aorta passes backwards from the ventricle, as in Gastropods and the majority of Lamellibranchs. The ramifications of the arteries convey the blood to all parts of the body, and fit into the venous sinuses, the chief of which are the pedal, the pallial and the cerebral central arteries. The last is between the pericardium and the foot; from the blood passes through the renal organs to the ctenidia. Some blood, however, enters the auricles directly from the mantle, without passing through the ctenidia. In the majority of Gastropoda one gill and one auricle are lost.

The blood is usually a colourless liquid containing amoeboid cells and sometimes other corpuscles called haematids. It may be coloured blue by haemocyanin, a respiratory compound containing copper. In a few forms the blood contains haemoglobin, either in solution or in haematids (red blood-corpuscles). In the Gastropoda the muscular tissue of the buccal mass is coloured red by haemoglobin.

Nervous System.—The central nervous system may be described as consisting of a collar surrounding the oesophagus, and two pairs of cords arising from the collar and passing backwards. The two pairs of cords arise from the same point of the collar. The ventral cords are the pedal, the dorso-lateral, the pleural, the former innervating the foot, the latter the mantle. The dorsal half of the collar is the cerebral, and the ventral the labial commissure. The pedal cords are connected by commissures, and the pedal and pleural of each side are similarly connected. The pallial cords are connected to one another posteriorly, dorsal to the rectum. This is the condition of the nervous system found in *Chiton* and the other Amphineura, but may not be in all respects the ancestral condition. Generally the system is differentiated into ganglia connected by nerve-cords consisting of nerve-fibres only. At the point of the collar where the nerve-cords arise are the cerebral ganglia; from these one pair of connectives passes to a pair of pedal ganglia, and another pair of connectives to a pair of pleural ganglia. Pedal and pleural on each side are connected by a pleuro-pedal connective. Each pleural ganglion gives off a long nerve which supplies the viscera, and the two unite posteriorly below the intestine. There are usually three small ganglia on the course of this visceral commissure, namely, the right and left visceral ganglia and the abdominal. The perioesophageal nerve-ring of Chaetopoda and Arthropoda is represented, not by the collar first mentioned in the above description, but by the connectives connecting the cerebral and pedal ganglia. The labial commissure supplies only the buccal mass and the oesophagus and stomach.

The special sense-organs are a pair of eyes on the head, a pair of otcysts or statocysts, and a pair of osphradia which have already been mentioned. In certain cases accessory eyes are also present, e.g. the pallial eyes of *Pecten* and other Lamellibranchs, and of *Chiton*. The otcysts are invaginations of the epithelium of the foot, but arc innervated from the cerebral ganglia, and the same innervation has been proved in some cases for the osphradia.

Sexual Development.—Molluscs are usually of separate sexes, but sexual dimorphism is seldom found. Hermaphroditism is secondary, and occurs in one sub-class of Gastropoda, in some Lamellibranchs, and in one sub-order of Amphineura. In Cephalopods and the majority of Gastropods copulation occurs. As a rule no parental care is exhibited, but incubation of the developing ova within some part of the parental body, or receptacles attached to the parent, occurs in some Lamellibranchs, some Gastropods, and in *Argonauta* among the Cephalopods. True viviparity, that is the development of the ova within the oviduct, is very rare, occurring only in one case among the Amphineura and in some aquatic and pulmonate Gastropods.

The egg-cell of Mollusca is either free from food-material—a simple protoplasmic corpuscle—or charged with food-material to a greater or less extent. Those cases which appear to be most typical—i.e. which adhere to a procedure which was probably common at one time to all then existing Mollusca and has been departed from only

in later and special lines of descent—show approximately the following history. By division of the egg-cell a mulberry-mass of embryonic-cells is formed (morula), which dilates, forming a one-cell-layered sac (blastula). By invagination one portion of this sphere becomes tucked into the other—as in the preparation of a woven night-cap for the head. The orifice of invagination (blastopore) narrows, and we now have a two-cell-layered sac—the gastrula. The invaginated layer is the enteric cell-layer or endoderm; the outer cell-layer is the dermic cell-layer or ectoderm. The cavity communicating with the blastopore and lined by the endoderm is the archenteron. The blastopore, together with the whole embryo, now elongates. The blastopore then closes along the middle portion of its extent, which corresponds with the later developed foot. At the same time the stomodaeum, or oral invagination, forms around the anterior remnant of the blastopore, and the proctodaeum, or anal invagination, forms around the posterior remnant of the blastopore. There are, however, variations in regard to the relation of the blastopore to the mouth and to the anus which are probably modifications of the original process described above.

In eggs which contain a larger quantity of food-yolk, the process by which the endoderm is enveloped by the ectoderm is somewhat different. Segmentation in these is very unequal, and results in the formation of small cells called micromeres and large cells called megameres, as in fig. 4. As the micromeres become more numerous they gradually envelop the megameres until the latter are completely enclosed. The gastrula is in these cases said to be formed by epibole. Between ectoderm and endoderm a third intermediate cell-layer

coelom is formed as a single cavity, and renal and generative organs are formed from its walls. This is the primitive method, but in other cases the organs mentioned may be formed separately in the mesoderm. The renal organs are tubular outgrowths of the pericardial parts of the coelom; the reproductive cells are derived from cells lining the generative portion.

The external form of the embryo meanwhile passes through highly characteristic changes, which are on the whole fairly constant

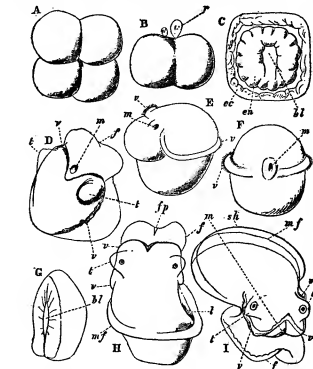

(After Lankester, 15.)

FIG. 2.—Development of the Pond-Snail, *Limnaea stagnalis*.

- r.*, Directive corpuscle.
bl., Blastopore.
en., Endoderm or enteric cell layer.
ec., Ectoderm or deric cell-layer.
v., Velum.
m., Mouth.
f., Foot.
t., Tentacles.
fp., Pore in the foot (belonging to the pedal gland?).
mf., The mantle-flap or limbus pallialis.
sh., The shell.
l., The sub-pallial space, here destined to become the lung.

- A, First four cells resulting from the cleavage of the original egg-cell.
 B, Side-view of the same.
 C, Diblastula stage showing the two cell-layers and the blastopore.
 D, E, F, Trochosphere stage, D older than E or F.
 G, Three-quarter view of a Diblastula, to show the orifice of invagination of the endoderm or blastopore, (*bl.*)
 H, I, Veliger stage later than D.

is formed, which is called the mesoderm, and gives rise to the muscular and connective tissues to the vascular system, and to the excretory and generative organs. The mesoderm arises for the most part from the endoderm. When the segmentation is unequal one of the megameres gives rise by successive divisions to two primary mesoderm cells called mesomeres; these divide to form two masses of cells called mesoblastic bands. The coelom is formed as a cavity or caved in the interior of these cell-masses. In some cases the

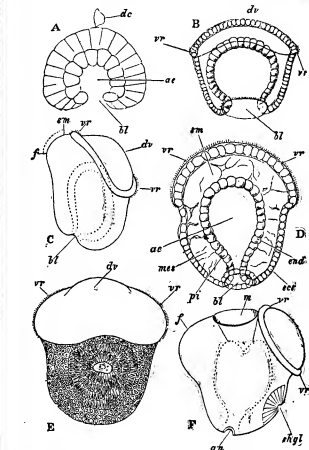

(After Lankester, 17.)

FIG. 3.—Development of the River-Snail, *Paludina vivipara*.

- dc.*, Directive corpuscle (outcast cell).
ae., Arch-enteron or cavity lined by the enteric cell-layer or endoderm.
bl., Blastopore.
v., Velum or cirlet of ciliated cells.
dv., Velar area or cephalic dome.
sm., Site of the as yet unformed mouth.
f., Foot.
mes., Rudiments of the skeletotropic tissues.
pt., The pedicle of invagination, the future rectum.
shgl., The primitive shell-sac or shell-gland.
m., Mouth. *an.*, anus.
- A, Gastrula phase (optical section).
 B, The Gastrula has become a Trochosphere by the development of the ciliated ring *vr* (optical section).
 C, Side view of the Trochosphere with commencing formation of the foot.
 D, Further advanced Trochosphere (optical section).
 E, The Trochosphere passing to the Veliger stage, dorsal view showing the formation of the primitive shell-sac.
 F, Side view of the same, showing foot, shell-sac (*shgl.*), velum (*vr*), mouth and anus.

N.B.—In this development the blastopore is not elongated; it persists as the anus. The mouth and stomodaeum form independently of the blastopore.

throughout the Mollusca. A cirlet of cilia forms when the embryo is still nearly spherical in an equatorial position. As growth proceeds, one hemisphere remains relatively small, the other elongates and enlarges. Both mouth and anus are placed in the larger area; the smaller area is the prostomium simply; the ciliated band is therefore in front of the mouth. The larval form thus produced is known as the trochosphere. It exactly agrees with the larval form of many Chaetopod worms and other Coelomata. Most remarkable is its resemblance to the adult form of the Wheel animalcules, or Rotifera, which retain the pre-oral ciliated band as their chief organ of locomotion and prehension throughout life. So far the young mollusc has not reached a definitely molluscan stage of

development, being only in a condition common to it and other Coelomata. It now passes to the veliger phase, a definitely molluscan form, in which the disproportion between the area in front of the ciliated circlet and that behind it is very greatly increased, so that the former is now simply an emarginated region of the head fringed with cilia. It is termed the "velum," and is frequently drawn out

to Mollusca generally, but acquires characters peculiar to the particular class to which its parents belong. For the later development therefore the articles on the several classes must be consulted.

Relations between the Classes.—From the preceding discussion an idea may be formed of the primitive characters of the Phylum

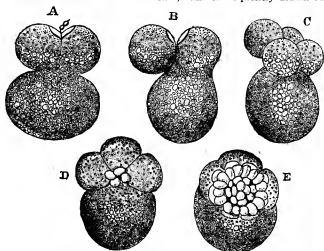

(From Balfour, after Bobretzky.)

FIG. 4.—Early Stages of division of the Fertilized Egg-cell in *Nassus mutabilis*.

- A, The egg-cell has divided into two spheres, of which the lower contains more food-material, whilst the upper is again incompletely divided into two smaller spheres. Resting on the dividing upper sphere are the eight-shaped "directive corpuscles," better called "presegmental outcast cells or aplasts," since they are the result of a cell-division which affects the egg-cell before it is impregnated, and are mere refuse, destined to disappear.
- B, One of the two smaller spheres is reunited to the larger sphere.
- C, The single small sphere has divided into two, and the reunited mass has divided into two, of which one is oblong and practically double, as in B.
- D, Each of the four segment-cells gives rise by division to a small pellucid cell.
- E, The cap of small cells has increased in number by repeated formation of pellucid cells in the same way, and by division of those first formed. The cap will spread over and enclose the four segment-cells.

into lobes and processes. As in the Rotifera, it serves the veliger larva as an organ of locomotion. The body of the veliger is characterized by the development of the visceral hump on one surface, and by that of the foot on the other. Growth is greater in the vertical dorso-ventral axis than in the longitudinal oro-anal axis; consequently the foot is relatively small and projects as a blunt process between mouth and anus, which are not widely distant from one another, whilst the antipodal area projects in the form of a great hump or dome. In the centre of this antipodal area there has appeared (often at a very early period) a gland-like depression or follicle of the integument. This is the primitive shell-sac discovered by Lankester in 1871, and shown by him to precede the development of the permanent shell in a variety of molluscan types. The shell-gland is bounded by a ridge of ectodermic cells. This ridge forms the edge of the shell-secreting epithelium, and therefore of the mantle, since the shell extends to the edge of the mantle. The shell-gland, as development proceeds, extends from its point of origin as an ectodermic thickening, which may be only slightly concave or may be deeply invaginated and then evaginated.

In the larvae of several Gastropoda and Lamellibranchia occur excretory organs which have the characters of true nephridia. There is a single pair of these organs situated immediately behind the velum. They agree with primitive nephridia in being of ectodermic origin, in consisting of perforated cells in linear series, and in having no communication with the coelom. The inner end of each of these organs consists of a flame-cell, i.e. a cell with an internal cavity containing a vibrating filament or flagellum. They are best developed in the Pulmonata; in some cases they are very rudimentary and may be destitute of an external opening. They invariably disappear before the adult stage is reached, but their presence in the larva is evidence that the ancestral mollusc possessed a pair of true nephridia quite distinct from the coelomic excretory organs, which are so characteristic of existing forms in the adult condition.

The ctenidia, it will be observed, have not yet been mentioned, and they are indeed the last of the characteristic Molluscan organs to make their appearance. They arise as outgrowths of the sides of the body within the cavity formed by the development of the mantle. The veliger, as soon as its shell has attained some extent and begins to assume definite shape, is no longer of a form common

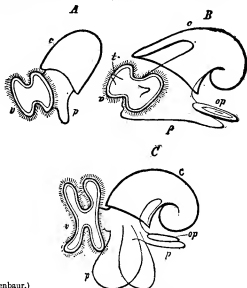

(From Gegenbaur.)

FIG. 5.—"Veliger" embryonic form of Mollusca.

- v, Velum. A, Earlier, and (B), later, Veliger of a Gastropod.
- c, Visceral dome with dependent mantle-skirt. C, Veliger of a Pteropod showing lobe-like processes of the velum and the great paired outgrowths of the foot.
- f, Foot.
- t, Cephalic tentacles.
- op, Operculum.

Mollusca, and it is possible to construct a diagrammatic mollusc, as was first done by Lankester, which will possess these primitive features. The figure here given represents such a hypothetical form according to present views. We cannot assert that this was in all respects the condition of the common ancestor, as will be seen when we attempt to derive the various sub-types from it. In the Amphineura the nervous system, having no

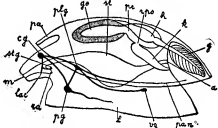

(From Lankester's *Treatise on Zoology*. A. and C. Black.)

FIG. 6.—Diagram of a primitive Mollusc, viewed from the left side.

- | | |
|---------------------------------|-------------------------------------|
| a, Anus. | pa.n, Pallial nerve. |
| cg, Cerebral ganglion. | pc, Pericardium. |
| f, Foot. | pg, Pedal ganglion. |
| g, Gill, in the pallial cavity. | pl.g, Pleural ganglion. |
| go, Gonad. | ra, Radula. |
| h, Heart. | r.p.o, Stomato-pericardial orifice. |
| k, Kidney. | s, Stomach. |
| la.c, Labial commissure. | st.g, Stomato-gastric ganglion. |
| m, Mouth. | v.g, Visceral ganglion. |
| pa, Mantle. | |

separate ganglia and no ventral visceral commissure, may be still more primitive. The metameric repetition of the shell-plates and of the ctenidia are probably special modifications, but it is difficult to explain the spicules of the dorsal integument except as a condition more primitive than the shell itself. The Prorhipidoglossomorpha are distinguished by the separation of the genital coelom from the pericardium, and by the long visceral commissure passing ventral to the intestine. The Lamellibranchia have markedly diverged from the original type by the adoption of filtration as a method of feeding. This has

led to the loss of the radula, and is accompanied by the division of the shell into two valves. The peculiarities of the Gastropoda are all due to the torsion of the shell and body. The Cephalopoda can be derived without much difficulty from the schematic Mollusc, if we assume that some metameric repetition of organs has occurred, as explained above in reference to the coelom. The foot has been developed into long processes which have extended in a circle round the mouth; all the ganglia, including the visceral, have been concentrated around the oesophagus.

Habits and Distribution.—More than 28,000 species of living Molluscs have been distinguished, of which more than half are Gastropods. They are essentially aquatic animals, and the

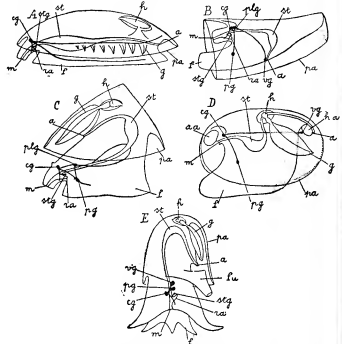

(From Lankester's *Treatise on Zoology*. A. and C. Black.)

FIG. 7.—Diagrams of the five classes of Mollusca, from the left side.

- | | |
|--------------------------|----------------------------------|
| A, Amphineura. | h, Heart, in the pericardium. |
| B, Scaphopoda. | h.a., Posterior adductor. |
| C, Gastropoda. | m, Mouth. |
| D, Lamellibranchia. | pd, Pallium or mantle. |
| E, Cephalopoda. | p.g., Pedal ganglion. |
| a, Anus. | pl.g., Pleural ganglion. |
| a.a., Anterior adductor. | ra, Radula. |
| c.g., Cerebral ganglion. | st, Stomach. |
| f, Foot. | st.g., Stomato-gastric ganglion. |
| fu, Funnel. | v.g., Visceral ganglion. |
| g, Ctenidium. | |

majority live in the sea. Some, like many Cephalopods and the Pteropods, are pelagic or free-swimming; others creep or lie on the sea bottom. Some are littoral, living between tide-marks; others are found at very various depths, up to 2800 fathoms. A few species have invaded the fresh waters, while the pulmonate and terrestrial Gastropods are distributed over the whole surface of the land in all latitudes and to a height of 15,000 ft. As a rule Molluscs are free and more or less active, but many Lamellibranchs are sedentary, and a few of these and of Gastropods are permanently fixed to their habitat. Commensalism occurs in a few instances, but parasitism either external or internal is rare. The latter is confined to certain Gastropods which live in Echinoderms and are extremely degenerate in structure. Protective resemblance is exhibited by some Nudibranch Gastropods which have assumed the colour and appearance of their habitat.

LITERATURE.—I. Morphology. (1) G. Cuvier, *Mémoires pour servir à l'histoire et à l'anatomie des mollusques* (Paris, 1816). (2) J. Poli, *Testacea utriusque Siciliae, eorumque historia et anatomie, tabulis aeneis 40 illustrata*, vols. i.—iii., fol. (Parma, 1791-1795 and 1826-1827). (3) St delle Chiaje, *Memorie sulla storia e anatomia degli animali senza vertebre del regno di Napoli* (Naples, 1823-1829), new edition

with 172 plates, fol., 1843. (4) J. Vaughan Thompson, *Zoological Researches* (Cork, 1830); memoir iv., "On the Cirripedes or Barnacles, demonstrating their deceptive character." (5) A. Kowalewsky, "Entwickelungsgeschichte der einfachen Ascidien," in *Mém. de l'acad. des sciences de St Petersburg* (1866), and "Entwickelungsgeschichte des Amphioxus lanceolatus," *ibid.* (1867). (6) J. Vaughan Thompson, *Zoological Researches* (Cork, 1830); memoir v., "Polyzoa, a new animal discovered as an inhabitant of some Zoophytes." (7) C. G. Ehrenberg, "Die Korallenhiere des Rothen Meeres" (Berlin, 1834); *Abhandl. d. k. Acad. d. Wissenschaften in Berlin* (1832). (8) H. Milne-Edwards, *Recherches sur les polypiers de France* (Paris, 1847, 1841). (9) H. Milne-Edwards, papers in the *Annales des sciences naturelles*: (1841-1860). (10) H. de Lacaze-Duthiers, papers in the *Annales des sciences naturelles*, e.g., "Anomia" (1854), "Mytilus" (1856), "Dentalium" (1856-1857), "Purpura" (1859), "Haliothis 1859", "Vermetus" (1860). (11) A. Kölliker, *Entwickelungsgeschichte der Cephalopoden* (Zürich, 1844). (12) C. G. Gegenbauer, *Untersuchungen über Pteropoden und Heteropoden*, (Leipzig, 1855). (13) J. W. Spengel, "Die Geruchsortane und das Nervensystem der Mollusken," *Zeitschr. f. wiss. Zool.* (1881). (14) Richard Owen, *Memoir on the Pearly Nautilus* (London, 1832). (15) L. Cuenot, "Excrétion chez les mollusques," *Arch. d. biol.* xvi. (1899). (16) P. Geddes, "On the Mechanism of the Odontophore in certain Mollusca." (17) T. H. Huxley, "On the Morphology of the Cephalous Mollusca," *Phil. Trans.* (1853). (18) Von Jhering, *Vergleichende Anatomie des Nervensystems und Phylogenie der Mollusken* (Leipzig, 1877). (19) E. R. Lankester, "Contributions to the Developmental History of the Mollusca," *Phil. Trans.* (1875); "Note on the Coelom and Vascular System of Mollusca and Arthropoda," *Quart. Journ. Micr. Sci.* xxxiv. (1893). (20) P. Pelsener, *Introduction à l'étude des Mollusques* (Brussels, 1894); "Recherches sur les Mollusques archaïques," *Mém. cour. Acad. belg.* lvi. (1899); "Mollusca," Lankester's *Treatise on Zoology*, pt. v. (1906).

II. Conchology.—(21) Cooke, *Molluscs*, *Cambridge Natural History*, vol. iii. (1895). (22) Fischer, *Manuel de conchyliologie* (1857). (23) Jeffreys, *British Conchology* (1862-1869). (24) Sinaroth, "Mollusca, Bronn's *Klassen und Ordnungen des Thierreichs*, Bd. iii. (1895), in prog. (25) Tryon, *Manual of Conchology* (1878), in prog. (26) Woodward, *A Manual of the Mollusca* (1880). (E. R. L.; J. T. C.)

MOLLUSCOIDA, a name long employed to denote a division of the animal kingdom which contained *Brachiopods* (*q.v.*), *Polyzoa* (*q.v.*), and *Tunicata* (*q.v.*), the members of the three groups having been supposed to resemble the *Mollusca*. As it is now known that these groups have no relation to molluscs, and very little to one another, the name Molluscoidea has been abandoned.

MOLLY MAGUIRES, an Irish American secret society which maintained numerous branches in the anthracite coal regions of Pennsylvania, U.S.A., from 1854 to 1877, and perhaps later. The name was imported from Ireland, where it had been used to designate one of the Ribbon societies that devoted its energies to intimidating and maltreating process servers and the agents of landlords, and whose greatest activity was between 1835 and 1855. The Irish society of Molly Maguires seems to have been organized in 1843 in the barony of Farnley, Co. Monaghan, to co-operate with the ribbonmen, and its membership seems to have been confined to the very lowest classes. The Molly Maguires of Pennsylvania consisted of similar classes of Irishmen, but there seems to have been no connexion between the two societies. Every member of the American organization was also a member of the Ancient Order of Hibernians, an association organized for benevolent purposes, and having branches throughout the United States and Great Britain. To the Ancient Order of Hibernians none might be admitted but persons of Irish birth or descent, who were Roman Catholics, and whose parents were Roman Catholics; but notwithstanding this requirement, the organization—being a secret society—was under the ban of the Catholic Church. At the head of each division or lodge there was a "body master," who communicated directly with a county delegate; the county delegates reported to the state delegate, and the state delegates to a national delegate. The supervision of the whole order was vested in a "Board of Erin," meeting quarterly in England, Ireland or Scotland, and at each meeting arranging a new code of signals and passwords, which were communicated to the national delegate in the United States by the steward of a transatlantic steamship, and thence were transmitted to the various subdivisions. In the mining districts of Pennsylvania the organization fell under the control of a lawless element,

which created the inner order of "Molly Maguires," with the object, it appears, of intimidating the Welsh, English, and German miners, and of ridding the region of mine superintendents, bosses and police who should make themselves in any way objectionable to members of the order. Any member having a grievance might lay a formal complaint before his "body master," who thereupon conferred with the officers of the neighbouring divisions and secured members from a distance to make away with the offending person. Under this system the crimes in a given district were always committed by strangers rendering identification of the criminal difficult and escape easy. The society grew in strength during the Civil War, when the increased demand for coal caused an influx of miners, many of them lawless characters, into the coal-fields, and in 1862-1863 it opposed enlistments in the Federal Army and roughly treated some of the enlisting officers. After the war its activity was shown by an increasing number of assassinations, burnings and other outrages, until by 1875 it completely dominated the mining classes and forced a general strike in the coal regions. After repeated efforts to bring the criminals to justice had failed, Franklin B. Gowen (1836-1889), president of the Philadelphia and Reading Coal and Iron Company, sent James McParlan, an Irish Catholic and a Pinkerton detective (who some thirty years later attracted attention in the investigation of the assassination of Governor Steunenberg of Idaho), to the mining region in 1873; he joined the order, lived among the "Molly Maguires" for more than two years, and even became secretary of the Shenandoah division, one of the most notoriously criminal folds of the order. The evidence he secured led to the arrest, conviction, and execution or imprisonment of a large number of members during the years 1876-1877, and subsequently the outrages ceased and the society was disbanded.

See F. P. Dewees, *The Molly Maguires* (Philadelphia, 1877); Allan Pinkerton, *The Molly Maguires and the Detectives* (New York, 1877); E. W. Lucy, *The Molly Maguires of Pennsylvania*; (London, n.d.); *The Commonwealth versus John Kehoe et al.* (Pottsville, Pa., 1878); and an article by J. F. Rhodes in *Amer. Hist. Review*, April, 1910.

MOLOCH, or **MOLECH** (in Hebrew, with the doubtful exception of 1 Kings xi. 7, always "the Molech"), the name or title of the divinity which the men of Judah in the last ages of the kingdom were wont to propitiate by the sacrifice of their own children. According to the Hebrew consonants it might simply be read "the king" (*mōlek*), an appellation for the supreme deity of a Semitic state or tribe. The traditional pronunciation (*Mo'ōk*), which goes back as far as the Septuagint version of Kings, probably means that the old form was perverted by giving it the vowels of *bōsheth* "shame," the contemptuous name for Baal (*q.v.*). In 1 Kings xi. 7 (see above) it is the name of the god of the Ammonites, elsewhere called Milcom or Malmcam; but it appears from 2 Kings xxiii. 10, 13 that the worship of Milcom at the shrine set up by Solomon was distinct from Molech worship, and the text should probably therefore be emended to the longer form (so the Septuagint).

The phrase employed in speaking of these sacrifices is that of dedication—"to make one's son or daughter pass through (or by means of) fire to (the) Molech" (2 Kings xxiii. 10; but elsewhere without the words "through fire" Lev. xviii. 21); and it appears from Jer. vii. 31, xix. 5; Ezek. xvi. 20 seq., that this phrase denotes a human holocaust,¹ and not, as sometimes has been thought, a mere consecration to Molech by passing through or between fires, as in the Roman *Palilia* and similar rites elsewhere (on which see Frazer, *Golden Bough*, 2nd ed., ii. 40 sqq., iii. 237 sqq.). Human sacrifice was common in Semitic heathenism, and at least the idea of such sacrifices was

¹ In 2 Chron. xxviii. 3 (parallel to 2 Kings vi. 3) a single letter is transposed in the phrase, changing the sense from "caused to pass through the fire" to "caused to burn with fire." Geiger (*Urschrift und Uebersetzung*, p. 305) very unnecessarily supposed that this was everywhere the original reading, and that it had been changed to soften the enormity ascribed to the ancient Hebrews. The phrase "to give one's seed to Molech" (Lev. xxi. 2 seq.), and the fact that the victims were (like other sacrifices) regarded as food for the deity (Ezek. xvi. 20) explain and justify the common reading.

not unknown to Israel from early times (see ISAAC; JEPHTHAH).² We learn from 2 Kings iii. 27 that the piacul sacrifice of his son and heir was the last offering which the king of Moab made to deliver his country. Even the Hebrew historian ascribes to this act the effect of rousing divine indignation against the invading host of Israel; it would not, therefore, be surprising if under the miseries brought on Palestine by the westward march of the Assyrian power, the idea of the sacrifice of one's own son, as the most powerful of atoning rites, should have taken hold of those kings of Judah (Ahaz and Manasseh, 2 Kings xvi. 3, xxi. 6) who were otherwise prone, in their hopelessness of help from the old religion (Isa. vii. 12), to seek to strange peoples and their rites. Ahaz's sacrifice of his son (which indeed rests on a somewhat late authority) was apparently an isolated act of despair, since human sacrifices are not among the corruptions of the popular religion spoken of by Isaiah and Micah. In the 7th century, however, when the old worship had sustained rude shocks, and all religion was transformed into servile fear (Mic. vi. 1 seq.), the example of Manasseh did not stand alone, and Jeremiah and Ezekiel made frequent and indignant reference to the "high places" for the sacrifice of children by their parents which rose beneath the very walls of the temple from the gloomy ravine of Hinnom or Tophet.³ (Jer. vii. 31, xix., xxxii. 35; Ezek. xvi. 18 sqq., xxiii. 37). The children apparently were not burned alive; they were slain and burned like any other holocaust (Ezek. *loc. cit.*; Isa. lvii. 5), their blood was shed at the sanctuary (Jer. xix. 4; Ps. cvi. 38). Thus the late Rabbinical picture of the calf-headed brazen image of Molech within which children were burned alive is pure fable, and with it falls the favourite comparison between Molech and the Carthaginian idol from whose brazen arms children were rolled into an abyss of fire, and whom Diodorus (xix. 14) naturally identifies with the child-eater Kronos, thus leading many moderns to make Molech the planet Saturn.

It is with these sacrifices that the name of "the Molech" is always connected; sometimes "the Baal" (lord) appears as a synonym. At the same time, the horrid ritual was so closely associated with Yahweh worship (Ezek. xxiii. 39) that Jeremiah more than once finds it necessary to protest that it is not of Yahweh's institution (vii. 31, xix. 5). So too it is the idea of sacrificing the firstborn to Yahweh that is discussed and rejected in Micah vi. It is indeed plain that such a sacrifice—for we have here to do, not with human victims in general, but with the sacrifice of the dearest earthly thing—could only be paid to the supreme deity; and Manasseh and his people never ceased to acknowledge Yahweh as the God of Israel. Thus the way in which Jeremiah (Jer. xix. 5) and the legislation of Leviticus (xviii. 21, xx. 2-5) and the author of Kings, seem to mark out the Molech or Baal as a false god, distinct from Yahweh, is precisely parallel to the way in which Hosea speaks of the golden calves or Baalim. In each case the people thought themselves to be worshipping Yahweh under the title of Molech or Baal; but the prophet refuses to admit that this is so, because the worship itself is an apostasy to heathenism. Note, also, the attitude of Ezekiel in xx. 25 seq., 31, references which cannot be explained away.

Although the motive came from within, the *form* taken by the cult has appeared to many to be of non-Israelite origin. Babylonia and Assyria, however, seem to be out of the question: *malik*, "arbiter, decider," is there an epithet of various gods, and as an appellative means "prince" and not king; further, little

² In Hos. xiii. 2, the interpretation "they that sacrifice men" is improbable, and 2 Kings xvii. 17 and Lev. xviii. 20 are of too late date by themselves to prove the immolation of children to Molech in old Israel. The "ban" (עִו), which was a religious execution of criminals or enemies, was common to Israel with its heathen neighbours (cf. the inscription of Meshah), but lacked the distinctive character of a sacrifice in which the victim is the food of the deity, conveyed to him through fire.

³ The etymology of the word Tophet is obscure; it is possibly of Aramaic origin and means "fire-place," cf. *topheth*, "pyre," (Isa. xxxv. 33). The vocalization is artificial, the Masoretes having given it the vowel-points of *bōsheth*. See W. R. Smith, *Religion of the Semites*, 2nd ed., 377.

evidence for the prevalence of human sacrifice has as yet been found in those lands (A. Jeremias, *Das Alte Test. im Lichte d. alten Orients*, 2nd ed., p. 454). Among the Canaanite branch, the king-god is more prominent, and apart from the Ammonite variant Milcom, numerous names compounded with Milk- are found on Phœnician inscriptions and among western Semites mentioned in cuneiform literature (H. Zimmern, *Keilinschr. u. das Alte Test.*, 3rd ed. pp. 470 sqq.). It is true that child-sacrifice in connexion with fire prevailed among the Phœnicians, and, according to the Greeks, the deity honoured with these grisly rites was Kronos (identified with the Phœnician El, "God"). On the other hand, the seat of the cult appears to have been at Jerusalem, and the period during which it flourished does not favour any strong Phœnician influence. Again, the form of the word Tophet and Ahaz's association with Damascus might point to an Aramaean origin for the cult; but it would not be safe to support this view by the statements and names in 2 Kings xvii. 31. On the whole, the biblical tradition that the Molech-cult was Canaanite and indigenous (Deut. xii. 29 sqq., xviii. 9 sq.) holds the ground. There was a tendency in time of misfortune to revert to earlier rites (illustrated in some ancient mourning customs), and it may have been some old disused practice revived under the pressure of national distress.

See, generally, G. F. Moore, *Ency. Bib., s.v.*; Lagrange, *Études sur les religions sémitiques* 2nd ed. pp. 99-109; B. Stade, *Bib. Theol. d. Alt. Test.* i. 232 seq., 244 seq.; J. G. Frazer, *Adonis*, &c., 2nd ed. pp. 144 seq. 401 sqq.; and J. A. Montgomery, *Journ. Bib. Lit.*, 1908, i. 49 sqq. On archaeological evidence for human sacrifice from Palestinian soil, see H. Vincent, *Canaan d'après l'exploration récente*, pp. 50, 116, 189 sqq. (W. R. S.; S. A. C.)

MOLSHEIM, a town of Germany, in the imperial province of Alsace-Lorraine at the foot of the Vosges, on the Breusch and at the junction of railways to Zabern and Strassburg. Pop. (1905), 3164. It contains a beautiful Roman Catholic and a Protestant church, a handsome new town-hall and an agricultural school. Its industries embrace the manufacture of iron and steel goods, tanning and organ-building. There is also some trade in wine. Molsheim was known in the 9th century as Mollesheim, and formerly was the seat of a famous Jesuit college, which in 1702 was removed to Strassburg and united with the university of that city.

MOLTKE, ADAM GOTTLÖB, COUNT (1710-1792), Danish courtier, was born on the 10th of November 1710, at Riesenhof in Mecklenburg. Though of German origin, many of the Moltkes were at this time in the Danish service, which was considered a more important and promising opening for the young north German noblemen than the service of any of the native principalities; and through one of his uncles, young Moltke became a page at the Danish court, in which capacity he formed a life-long friendship with the crown prince Frederick, afterwards Frederick V. He never had any opportunity of enriching his mind by travel or study, but he was remarkable for a strongly religious temperament and seems for some time to have been connected with the Moravians. Immediately after his accession, Frederick V. made him Hofmarskal (court marshal), and overwhelmed him with marks of favour, making him a privy councillor and a count and bestowing upon him Bregentved and other estates. As the inseparable companion of the king, Moltke's influence soon became so boundless that the foreign diplomatists declared he could make and unmake ministers at will. Fortunately he was no ordinary favourite. Naturally tactful and considerate, he never put difficulties in the way of the responsible ministers. Especially interesting is Moltke's attitude towards the two distinguished statesmen who played the leading parts during the reign of Frederick V., Johan Sigismund Schulin and the elder Bernstorff. For Schulin he had a sort of veneration. Bernstorff irritated him by his grand airs of conscious superiority. But though a Prussian intrigue was set up for the supersession of Bernstorff by Moltke, the latter, convinced that Bernstorff was the right man in the right place, supported him with unwavering loyalty. Moltke was far less liberal in his views than many of his contemporaries. He looked askance at all projects for the emancipation of the

serfs, but, as one of the largest landowners of Denmark, he did much service to agriculture by lightening the burdens of the countrymen and introducing technical and scientific improvements which greatly increased production. His greatest merit, however, was the guardianship he exercised over the king, whose sensual temperament and weak character exposed him to many temptations which might have been very injurious to the state. Frederick had the good sense to appreciate the honesty of his friend and there was never any serious breach between them. On the death of Queen Louisa the king would even have married one of Moltke's daughters had he not peremptorily declined the dangerous honour. On the decease of Frederick V., who died in his arms (Jan. 14, 1766), Moltke's dominion was at an end. The new king, Christian VII., could not endure him, and exclaimed, with reference to his lanky figure: "He's stork below and fox above." He was also extremely unpopular, because he was wrongly suspected of enriching himself at the public expense.¹ In July 1766 he was dismissed from all his offices and retired to his estate at Bregentved. Subsequently, through the interest of Russia, to whom he had always been favourable, he regained his seat in the council (Feb. 8, 1768), but his influence was slight and of brief endurance. He was again dismissed without a pension, on the 10th of December 1770, for refusing to have anything to do with Struensee. He lived in retirement till his death on the 25th of September 1792.

His memoirs, written in German and published in 1870, have considerable historical importance. See H. H. Langhorn, *Historische Nachrichten über die dänischen Moltkes* (Kiel, 1871). (R. N. B.)

MOLTKE, ADAM WILHELM, COUNT (1785-1864), Danish statesman, son of the minister Joachim Godske Moltke (1746-1818), and grandson of Adam Gottlob Moltke, was born at Einsiedelsborg in Funen, on the 25th of August 1785. Under the influence of the agricultural reformer Christian Colbjørnsen he abandoned the legal career he had adopted and entered the administrative service of the state, to which he devoted the remainder of his life. In 1831 he succeeded Johan Sigismund Møsting (1789-1843), as minister of finance. On the death of Christian VIII. he was one of the most prominent members of the Council of State, and when the constitutional crisis came in 1848 he seemed marked out as the man who could bridge over the gap between the old era and the new. The services which Count Moltke rendered to Denmark cannot be too highly appreciated. The mere fact that a distinguished statesman who had served the last two absolute kings of Denmark now voluntarily placed himself at the head of a ministry which included the most advanced of the popular agitators, gave the new government the hall-mark of stability and trustworthiness, whilst the fact that he still retained the ministry of finance was of itself a guarantee of security during the earlier years of a troublesome and costly war. It was this, his first administration, which introduced the constitution of the 5th of June 1849, and he also presided over the third constitutional ministry which was formed in July 1851; but he resigned on the 27th of January 1852, because he could not approve of the decree which aimed at transforming Denmark into a composite, indivisible, monarchy. Moltke continued to take part in public life as a member of the Landsting, or Upper House, but henceforth kept in the background. On the 2nd of October 1855 he was elected a member of the consultative Rigsraad, a position he continued to hold till 1863. He died on the 15th of February 1864.

See Swalin, *Det danske Staatsraad* (Stockholm, 1881); *Madvig, Livserindringer* (Copenhagen, 1887). (R. N. B.)

MOLTKE, HELMUTH CARL BERNHARD, COUNT VON (1800-1891), Prussian field marshal, for thirty years chief of the staff of the Prussian army, the greatest strategist of the latter half of the 19th century, and the creator of the modern method of directing armies in the field, was born on the 26th of October 1800, at Parchim in Mecklenburg, of a German family of ancient nobility. His father in 1805 settled in Holstein and

¹ He was said to be worth 10 million rix-dollars, but proved that he had less than one million.

became a Danish subject, but about the same time was impoverished by the burning of his country house and the plunder by the French of his town house in Lübeck, where his wife and children were. Young Moltke therefore grew up in straitened circumstances. At the age of nine he was sent as a boarder to Hohenfelde in Holstein, and at the age of eleven to the cadet school at Copenhagen, being destined for the Danish army and court. In 1818 he became a page to the king of Denmark and second lieutenant in a Danish infantry regiment. But at twenty-one he resolved to enter the Prussian service, in spite of the loss of seniority. He passed the necessary examination with credit, and became second lieutenant in the 8th Infantry Regiment stationed at Frankfort-on-Oder. At twenty-three, after much less than the regulation term of service, he was allowed to enter the general war school, now the war academy, where he studied the full three years and passed in 1826 a brilliant final examination. He then for a year had charge of a cadet school at Frankfort-on-Oder, after which he was for three years employed on the military survey in Silesia and Posen. In 1832 he was seconded for service on the general staff at Berlin, to which in 1833 on promotion to first lieutenant he was transferred. He was at this time regarded as a brilliant officer by his superiors, and among them by Prince William, then a lieutenant-general, afterwards king and emperor. He was well received at court and in the best society of Berlin. His tastes inclined him to literature, to historical study and to travel. In 1827 he had published a short romance, *The Two Friends*. In 1831 it was followed by an essay entitled *Holland and Belgium in their Mutual Relations, from their Separation under Philip II. to their Reunion under William I.*, in which were displayed the author's interest in the political issues of the day, and his extensive historical reading. In 1832 appeared *An Account of the Internal Circumstances and Social Conditions of Poland*, a second study of a burning question based both on reading and on personal observation of Polish life and character. In 1832 he contracted to translate Gibbon's *Decline and Fall* into German, for which he was to receive £75, his object being to earn the money to buy a horse. In eighteen months he had finished nine volumes out of twelve, but the publisher failed to produce the book and Moltke never received more than £25, so that the chief reward of his labour was the historical knowledge which he acquired. He had already found opportunities to travel in south Germany and northern Italy, and in 1835 on his promotion as captain he obtained six months' leave to travel in south-eastern Europe. After a short stay in Constantinople he was requested by the sultan to enter the Turkish service, and being duly authorized from Berlin he accepted the offer. He remained two years at Constantinople, learned Turkish and surveyed for the sultan the city of Constantinople, the Bosphorus and the Dardanelles. He travelled in the sultan's retinue through Bulgaria and Rumelia, and made many other journeys on both sides of the Strait. In 1838 he was sent as adviser to the Turkish general commanding the troops in Armenia, who was to carry on a campaign against Mehemet Ali of Egypt. During the summer he made extensive reconnaissances and surveys, riding several thousand miles in the course of his journeys, navigating the dangerous rapids of the Euphrates, and visiting and mapping many districts where no European traveller had preceded him since Xenophon. In 1839 the army moved south to meet the Egyptians, but upon the approach of the enemy the general became more attentive to the prophecies of the mollahs than to the advice of the Prussian captain. Moltke resigned his post of staff officer and took charge of the artillery, which therefore, in the ensuing battle of Nezib or Nisib, was the last portion of the Turkish army to run away. The Turks were well beaten and their army dispersed to the four winds. Moltke with infinite hardship made his way back to the Black Sea, and thence to Constantinople. His patron Sultan Mahmoud was dead, so he returned to Berlin where he arrived, broken in health, in December 1839. When he left Berlin in 1834 he had already "the courtier's, soldier's, scholar's eye, tongue, sword." When he returned it was

with a mind expanded by a rare experience, and with a character doubly tempered and annealed. While away, he had been a constant letter-writer to his mother and sisters, and he now revised and published his letters as *Letters on Conditions and Events in Turkey in the Years 1835 to 1839*. No other book gives so deep an insight into the character of the Turkish Empire, and no other book of travels better deserves to be regarded as a German classic. One of his sisters had married an English widower named Burt, who had settled in Holstein. Her step-daughter, Mary Burt, had read the traveller's letters, and when he came home as a wooer was quickly won. The marriage took place in 1841, when Mary was just turned sixteen. It was a very happy union, though there were no children, and Moltke's love-letters and letters to his wife are among the most valuable materials for his biography. On his return in 1840 Moltke had been appointed to the staff of the 4th army corps, stationed at Berlin; he was promoted major on his wedding day. The fruits of his Eastern travels were by no means exhausted. He published his maps of Constantinople, of the Bosphorus and of the Dardanelles, and, jointly with other German travellers, a new map of Asia Minor and a memoir on the geography of that country, as well as a number of periodical essays on various factors in the Eastern Question. In 1845 appeared *The Russo-Turkish Campaign in Europe, 1828-29, described in 1845 by Baron von Moltke, Major in the Prussian Staff*, a volume which was recognized by competent judges as a masterpiece of military history and criticism. Moltke at this period was much occupied with the development of railways. He was one of the first directors of the Hamburg-Berlin railway, and in 1843 published a review article entitled *What Considerations should determine the Choice of the Course of Railways?* which reveals a mastery of the technical questions involved in the construction and working of railway lines.

In 1845 Moltke was appointed personal adjutant to Prince Henry of Prussia, a Roman Catholic who lived at Rome. He thus had the opportunity of a long stay in the Eternal City, with no more than nominal duties to perform. It was a life which he and his wife much enjoyed, and he spent much of his leisure in a survey, of which the result was a splendid map of Rome, published at Berlin in 1852. In 1846 Prince Henry died, and Moltke was then appointed to the staff of the 8th army corps at Coblenz. In 1848, after a brief return to the great general staff at Berlin, he became chief of the staff of the 4th army corps, of which the headquarters were then at Magdeburg, where he remained seven years, during which he rose to lieutenant-colonel (1850), and colonel (1851). In 1855 he was appointed first adjutant to Prince Frederick William (afterwards crown prince and emperor), whom he accompanied to England on his betrothal and marriage, as well as to Paris and to St Petersburg to the coronation of Alexander II. of Russia. Prince Frederick William was in command of a regiment stationed at Breslau, and there as his adjutant Moltke remained for a year, becoming major-general in 1856. On the 23rd of October 1857, owing to the serious illness of King Frederick William IV., Prince William became prince regent. Six days later the regent selected Moltke for the then vacant post of chief of the general staff of the army. The appointment was made definitive in January 1858. Moltke's posthumously published military works disclose a remarkable activity, beginning in 1857, devoted to the adaptation of strategical and tactical methods to changes in armament and in means of communication, to the training of staff officers in accordance with the methods thus worked out, to the perfection of the arrangements for the mobilization of the army, and to the study of European politics in connexion with the plans for campaigns which might become necessary. In 1859 came the war in Italy, which occasioned the mobilization of the Prussian army, and as a consequence the reorganization of that army, by which its numerical strength was nearly doubled. The reorganization was the work not of Moltke but of the king, and of Roon, minister of war; but Moltke watched the Italian campaign closely, and wrote a history of it, published in 1862, and attributed on the title-page to the historical division of the Prussian

staff, which is the clearest account of the campaign and contains the best criticism upon it. In December 1862 Moltke was asked for an opinion upon the military aspect of the quarrel with Denmark then becoming acute. He thought the difficulty would be to bring the war to an end, as the Danish army would if possible retire to the islands, where, as the Danes had the command of the sea, it could not be attacked. He sketched a plan for turning the flank of the Danish army before the attack upon its position in front of Schleswig, and hoped that by this means its retreat might be intercepted. When the war began in February 1864, Moltke was not sent with the Prussian forces, but kept at Berlin. The plan was mismanaged in the execution, and the Danish army escaped to the fortresses of Düppel and Fredericia, each of which commanded a retreat across a strait on to an island. The allies were now checked; Düppel and Fredericia were besieged by them, Düppel taken by storm, and Fredericia abandoned by the Danes without assault; but the war showed no signs of ending, as the Danish army was safe in the islands of Alsens and Fünen. On the 30th of April Moltke was sent to be chief of the staff to the commander-in-chief of the allied forces, and, so soon as the armistice of May and June was over, persuaded Prince Frederick Charles to attempt to force the passage of the Sundewitt and attack the Danes in the island of Alsens. The landing was effected on the 29th of June, and the Danes then evacuated Alsens. Moltke next proposed a landing in Fünen, but it was unnecessary. The Danes no longer felt safe in their islands, and agreed to the German terms. Moltke's appearance on the scene had quickly transformed the aspect of the war, and his influence with the king had thus acquired a firm basis. Accordingly, when in 1866 the quarrel with Austria came to a head, Moltke's plans were adopted and he was almost invariably supported in their execution. A disciple rather of Clausewitz, whose theory of war was an effort to grasp its conditions, than of Jomini, who expounded a system of rules, Moltke regarded strategy as a practical art of adapting means to ends, and had developed the methods of Napoleon in accordance with the altered conditions. He had been the first to realize the great defensive power of modern firearms, and had inferred from it that an enveloping attack had become more formidable than the attempt to pierce an enemy's front. He had pondered the tactics of Napoleon at Bautzen, when the emperor preferred to bring up Ney's corps, coming from a distance, against the flank of the allies, rather than to unite it with his own force before the battle; he had also drawn a moral from the combined action of the allies at Waterloo. At the same time he had worked out the conditions of the march and supply of an army. Only one army corps could be moved along one road in the same day; to put two or three corps on the same road meant that the rear corps could not be made use of in a battle at the front. Several corps stationed close together in a small area could not be fed for more than a day or two. Accordingly he inferred that the essence of strategy lay in arrangements for the separation of the corps for marching and their concentration in time for battle. In order to make a large army manageable, it must be broken up into separate armies or groups of corps, each group under a commander authorized to regulate its movements and action subject to the instructions of the commander-in-chief as regards the direction and purpose of its operations. In the strategy of 1866 the conspicuous points are: (1) The concentration of effort. There were two groups of enemies, the Austro-Saxon armies, 270,000; and the north and south German armies, 120,000. The Prussian forces were 64,000 short of the adverse total, but Moltke determined to be superior at the decisive point against the Austro-Saxons; he therefore told off 278,000 men for that portion of the struggle, and employed only 48,000 men in Germany proper. His brilliant direction enabled the 48,000 to capture the Hanoverian army in less than a fortnight, and then to attack and drive across the south German forces. (2) In dealing with Austro-Saxony the difficulty was to have the Prussian army first ready—no easy matter, as the king would not mobilize until after the Austrians. Moltke's railway knowledge helped him to save

time. Five lines of railway led from the various Prussian provinces to a series of points on the southern frontier on the curved line Zeitz-Halle-Görlitz-Schweidnitz. By employing all these railways at once, Moltke had the several army corps moved simultaneously from their peace quarters to points on this curved line. When this first move was finished the corps then marched along the curve to collect into three groups, one near Torgau (Elbe army), another at the west end of Silesia (first army, Prince Frederick Charles), the third between Landsbut and Waldenburg (second army, crown prince). The first army when formed marched eastwards towards Görlitz. The small Saxon army at Dresden now had the Elbe army in its front and the first army on its right flank, and as it was outnumbered by either of them, its position was untenable, and so soon as hostilities began fell back into Bohemia, where it was joined by an Austrian corps, with which it formed an advance guard far in front of the Austrian main army concentrated near Olmütz. The Elbe army advanced to Dresden, left a garrison there, and moved to the right of Prince Frederick Charles, under whose command it now came. (3) Moltke now had two armies about 100 miles apart. The problem was how to bring them together so as to catch the Austrian army between them like the French at Waterloo between Wellington and Blücher. If, as was thought likely, the Austrians moved upon Breslau, the first and Elbe armies could continue their eastward march to co-operate with the second. But on the 15th of June Moltke learned that on the 11th of June the Austrian army had been spread out over the country between Wildenschwerdt, Olmütz and Brünn. He inferred that it could not be concentrated at Josefstadt in less than thirteen days. Accordingly he determined to bring his own two armies together by directing each of them to advance towards Gitschin. He foresaw that the march of the crown prince would probably bring him into collision with a portion of the Austrian army; but the crown prince had 100,000 men, and it was not likely that the Austrians could have a stronger force than that within reach of him. The order to advance upon Gitschin was issued on the 22nd of June, and led to one of the greatest victories on record. The Austrians marched faster than Moltke expected, and might have opposed the crown prince with four or five corps; but Benedek's attention was centred on Prince Frederick Charles, and he interposed against the crown prince's advance four corps not under a common command, so that they were beaten in detail, as were also the Saxons and the Austrian corps with them, by Prince Frederick Charles. On the 1st of July Benedek collected his already shaken forces in a defensive position in front of Königgrätz. Moltke's two armies were now within a march of one another and of the enemy. On the 3rd of July they were brought into action, the first against the Austrian front and the second against the Austrian right flank. The Austrian army was completely defeated and the campaign decided, though an advance towards Vienna was needed to bring about the peace upon Prussia's terms. Moltke was not quite satisfied with the battle of Königgrätz. He had tried to have the Elbe army brought up to the Elbe above Königgrätz so as to prevent the Austrian retreat, but its general failed to accomplish this. He also tried to prevent the first army from pushing its attack, hoping in that way to keep the Austrians in their position until retreat should be cut off by the crown prince, but he could not restrain the impetuosity of Prince Frederick Charles and of the king. During the negotiations Bismarck, who dared not risk the active intervention of France, opposed the king's wish to annex Saxony and perhaps other territory beyond what was actually taken. Moltke would not have hesitated; he was confident of beating both French and Austrians if the French should intervene, and he submitted to Bismarck his plans in case of need for the opening moves against both French and Austrians.

After the peace, the Prussian Diet voted Moltke the sum of £30,000, with which he bought the estate of Creisau, near Schweidnitz, in Silesia. In 1867 was published *The Campaign of 1866 in Germany*, a history produced under Moltke's personal

supervision, and remarkable for its combination of accuracy with reticence. On the 24th of December 1868 Moltke's wife died at Berlin. Her remains were buried in a small chapel erected by Moltke as a mausoleum in the park at Creisau.

In 1870 suddenly came the war with France. The probability of such a war had occupied Moltke's attention almost continuously since 1857, and a series of memoirs is preserved in which from time to time he worked out and recorded his ideas as to the best arrangement of the Prussian or German forces for the opening of the campaign. The arrangements for the transport of the army by railway were annually revised in order to suit the changes in his plans brought about by political conditions and by the growth of the army, as well as by the improvement of the Prussian system of railways. The great successes of 1866 had strengthened Moltke's position, so that when on the 15th of July 1870 the order for the mobilization of the Prussian and south German forces was issued, his plans were adopted without dispute and five days later he was appointed "Chief of the general staff of the army at the headquarters of his Majesty the King" for the duration of the war. This gave Moltke the right to issue in the king's name, though of course not without his approval, orders which were equivalent to royal commands. Moltke's plan was to assemble the whole army to the south of Mainz, this being the one district in which an army could best secure the defence of the whole frontier. If the French should disregard the neutrality of Belgium and Luxemburg, and advance on the line from Paris to Cologne or any other point on the Lower Rhine, the German army would be able to strike at their flank, while the Rhine itself, with the fortresses of Coblenz, Cologne and Wesel, would be a serious obstacle in their front. If the French should attempt to invade south Germany, an advance of the Germans up either bank of the Rhine would threaten their communications. Moltke expected that the French would be compelled by the direction of their railways to collect the greater part of their army near Metz, and a smaller portion near Strassburg. The German forces were grouped into three armies: the first of 60,000 men, under Steinmetz, on the Moselle below Trèves; the second of 131,000 men, under Prince Frederick Charles, round Homburg, with a reserve of 60,000 men behind it; the third under the crown prince of 130,000 men, at Landau. Three army corps amounting to 100,000 men were not reckoned upon in the first instance, as it was desirable to keep a considerable force in north-eastern Germany, in case Austria should make common cause with France. If, as seemed probable, the French should take the initiative before the German armies were ready, and for that purpose should advance from Metz in the direction of Mainz, Moltke would merely put back a few miles nearer to Mainz the points of debarkation from the railway of the troops of the second army. This measure was actually adopted, though the anticipated French invasion did not take place. Moltke's plan of operations was that the three armies while advancing should make a right wheel, so that the first army on the right would reach the bank of the Moselle opposite Metz, while the second and third armies should push forward, the third army to defeat the French force near Strassburg, and the second to strike the Moselle near Pont-à-Mousson. If the French army should be found during this advance in front of the second army, it would be attacked in front by the second army and in flank by the first or the third or both. If it should be found on or north of the line from Saarburg to Lunéville, it could still be attacked from two sides by the second and third armies in co-operation. The intention of the great right wheel was to attack the principal French army in such a direction as to drive it north and cut its communications with Paris. The fortress of Metz was to be observed, and the main German forces, after defeating the chief French army, to march upon Paris. This plan was carried out in its broad outlines. The battle of Wörth was brought on prematurely, and therefore led, not to the capture of MacMahon's army, which was intended, but only to its total defeat and hasty retreat as far as Châlons. The battle of Spicheren was not intended by Moltke, who wished

to keep Bazaine's army on the Saar till he could attack it with the second army in front and the first army on its left flank, while the third army was closing towards its rear. But these unintended or unexpected victories did not disconcert Moltke, who carried out his intended advance to Pont-à-Mousson, then crossed the Moselle with the first and second armies, then faced north and wheeled round, so that the effect of the battle of Gravelotte was to drive Bazaine into the fortress of Metz and cut him off from Paris. Nothing shows Moltke's insight and strength of purpose in a clearer light than his determination to attack on the 18th of August, when many strategists would have thought that, the strategical victory having been gained, a tactical victory was unnecessary. He has been blamed for the last local attack at Gravelotte, in which there was a fruitless heavy loss; but it is now known that this attack was ordered by the king, and Moltke blamed himself for not having used his influence to prevent it. During the night following the battle Moltke made his next decision. He left one army to invest Bazaine and Metz, and set out with the two others to march towards Paris, the more southerly one leading, so that when MacMahon's army should be found the main blow might be delivered from the south and MacMahon driven to the north. On the 25th of August it was found that MacMahon was moving north-east for the relief of Bazaine. The moment Moltke was satisfied of the accuracy of his information, he ordered the German columns to turn their faces north instead of west. MacMahon's right wing was attacked at Beaumont while attempting to cross the Meuse, his advance necessarily abandoned, and his army with difficulty collected at Sedan. Here the two German armies were so brought up as completely to surround the French army, which on the 1st of September was attacked and compelled to raise the white flag. After the capitulation of Sedan, Moltke resumed the advance on Paris, which was surrounded and invested. From this time his strategy is remarkable for its judicious economy of force, for he was wise enough never to attempt more than was practicable with the means at his disposal. The surrender of Metz and of Paris was a question of time, and the problem was, while maintaining the investment, to be able to ward off the attacks of the new French armies levied for the purpose of raising the siege of Paris. Metz surrendered on the 27th of October, and on the 28th of January 1871 an armistice was concluded at Paris by which the garrison became virtually prisoners and the war was ended.

On the 29th of October 1870 Moltke was created graf (count or earl), and on the 16th of June 1871, field marshal. After the war he superintended the preparation of its history, which was published between 1874 and 1881 by the great general staff. In 1888 he resigned his post as chief of the staff. In 1867 Moltke was elected to the North German Diet, and in 1871 to the Reichstag. His speeches, dealing mostly with military questions, were regarded as models of conciseness and relevancy. He died suddenly on the 24th of April 1891, and after a magnificent funeral ceremony at Berlin his remains were laid beside those of his wife in the chapel which he had erected as her tomb at Creisau.

As a strategist Moltke cannot be estimated by comparison with Frederick or Napoleon, because he had not the authority either of a king or of a commander-in-chief. While it is doubtful whether he can be convicted of any strategical errors, it seems beyond doubt that he never had to face a situation which placed any strain on his powers, for in the campaigns of 1866 and 1870 his decisions seemed to be made without the slightest effort, and he was never at a loss.

He had a tall spare figure; and in his latter years his tanned features had received a set expression which was at once hard and grand. He was habitually taciturn and reserved, though a most accomplished linguist, so that it was said of him that he was "silent in seven languages." The stern school of his early life had given him a rare self-control, so that no indiscreet or unkind expression is known to have ever fallen from him. Long before his name was on the lips of the public he was known

in the army and in the staff as the "man of gold," the ideal character whom every one admired and who had no enemies.

AUTHORITIES—*Gesammelte Schriften und Denkwürdigkeiten des General-Feldmarschalls Grafen Helmuth von Moltke* (8 vols., Berlin, 1822–1893); *Moltke's militärische Werke* (Berlin, 2 vols., 1892–1900); *Feldmarschall Moltke*, by Max Jahns (3 vols., Berlin, 1894–1900); *Feldmarschall Graf Moltke: Ein militärisches Lebensbild*, by W. Bigge, Oberst, &c. (2 vols., Munich, 1901). (H. S. W.)

MOLUCCAS, or **SPICE ISLANDS**, a name which in its wider sense includes all the islands of the Malay Archipelago between Celebes on the W., New Guinea on the E., Timor on the S., and the open Pacific Ocean on the N. They are thus distributed over an area between 2° 43' N. and 8° 23' S. and 124° 22' and 135° E., and include: (1) the Moluccas proper or Ternate group, of which Halmahera is the largest and Ternate the capital; (2) the Bachjan, Obi, Xulla groups; (3) the Amboyna group, of which Ceram (Serang) and Buru are the largest; (4) the Banda Islands (the spice or nutmeg islands *par excellence*); (5) the south-eastern islands, comprising Timor-Laut or Tenimber, Larat, &c.; (6) the Kei Islands and the Aru Islands, of which the former are sometimes attached to the south-eastern group; and (7) the south-western islands or the Babar, Sermata, Leti, Damar, Roma and Wetar groups. At the close of the 16th century this part of the archipelago was divided among four rulers settled at Ternate, Tidore, Halmahera and Bachjan. The northern portion belongs to the Dutch residency of Ternate, the southern portion to that of Amboyna.

The name Moluccas is said to be derived from the Arabic for "king." Argensola (1609) uses the forms *istas Malucas*, *Maluco*, and *el Maluco*; Coronel (1623), *islas del Maluco*; and Camoens, *Maluco*. Since 1867, when the political unity, under a governor, was dissolved, the Moluccas are often named by the Dutch the "Great East" (*Groote Oost*). Most of the islands are mountainous, with still active volcanoes. As they lie near or under the equator, the monsoons blowing over them are less regular, and the rainfall, of large volume throughout the year, is dependent on the height and direction of the chains. The vegetation of the small and narrow islands, all encompassed by the sea, is very luxuriant, and the products, principally nutmegs, mace, and other spices, include also rice and sago. The inhabitants are of mixed descent. In some islands are people of obvious Papuan blood, while in others are Polynesian or Malayan tribes. With these three main races have crossed traders and colonists, Macassars, Buginese, Javanese and Europeans.

The geology of the Moluccas is very imperfectly known. The great chain of volcanoes which runs through Sumatra and Java is continued eastwards into the Moluccas, and terminates in a hook-like curve which passes through the Damar Islands to the Banda group. Outside this hook lies a concentric arc of non-volcanic islands, including Tenimber, the Lesser Kei Islands, Ceram and Buru; and beyond is still a third concentric arc extending from Taliabu to the Greater Kei Islands. The islands of these outer arcs consist chiefly of crystalline schists and limestones, overlaid by Jurassic, Cretaceous and Tertiary deposits. On the whole it appears that the older rocks are found more particularly towards the interior of the curve, and the newer rocks towards the exterior. Eruptive rocks of supposed Cretaceous age are met with in these outer islands, but Tertiary and recent volcanic lavas are confined to the innermost arc. Halmahera lies outside these arcs. It appears to consist chiefly of gabbro, peridotite, serpentine and other very basic eruptive rocks, which are believed to be of Cretaceous age. Nummulitic limestone occurs in the south-east. Upon the floor of older rock rise a number of volcanoes, some of which are now extinct while others are still active. Most of them lie near the west coast or on the islands off this coast; and they are arranged in lines which run approximately from north to south, with, generally, a slight convexity towards the west.

See further **MALAY ARCHIPELAGO**, and separate articles on the principal islands and groups.

MOLY (Gr. μολύβη), a mysterious plant with magical powers described in Homer, *Odyssey*, x. 302–306. Hermes pulls it up and gives it to Odysseus as a protection against the arts of Circe. It is further described as "having a black root and a flower like milk, and hard for mortals to pull up." There has been much controversy as to the identification. Philippe Champault—*Phéniciens et Grecs en Italie d'après l'Odyssee* (1906),

pp. 504 seq.—decides in favour of the *Peganum harmala* (of the order Rutaceae), the Syrian or African rue (Gr. ἡράων), from the husks of which the vegetable alkaloid harmaline (C₁₀H₁₁N₂O) is extracted. The flowers are white with green stripes. Victor Bérard—*Les Phéniciens et l'Odyssee*, ii. 288 seq.—relying partly on a Semitic root, prefers the *Atriplex halimus* (*atriplex*, a Lat. form of Gr. ἀράφαξ, and ἄλμος, marine), order Chenopodiaceae, a herb or low shrub common on the south European coasts. These identifications are noticed by R. M. Henry in *Class. Rev.* (Dec. 1906), p. 434, who illustrates the Homeric account by passages in the Paris and Leiden magical papyri, and argues that *moly* is probably a magical name, derived perhaps from Phœnician or Egyptian sources, for a plant which cannot be certainly identified. He shows that the "difficulty of pulling up" the plant is not a merely physical one, but rather connected with the peculiar powers claimed by magicians. In Tennyson's *Lotus Eaters* the *moly* is coupled with the amaranth ("propt on beds of amaranth and *moly*").

MOLYBDENITE, a mineral consisting of molybdenum disulphide, MoS₂. It closely resembles graphite in appearance, but may readily be distinguished from this by its greater density (4.7) and by its behaviour before the blowpipe. Crystals have the form of six-sided plates or scales, but they are never sharply defined, and their reference to the hexagonal system is doubtful. They have a perfect cleavage parallel to the large surface of the plates, and the flakes are readily bent, but are not elastic. The mineral is very soft (H=1 to 1½) and unctuous, and makes a bluish-grey mark on paper: it is opaque and has a bright metallic lustre. The colour is lead-grey differing slightly from that of graphite in having a bluish tinge. The name molybdenite is from the Greek μολύβδος, meaning lead or lead ore, with which graphite (black-lead) and molybdenite were confused; the latter was distinguished by P. J. Hjeltn, who in 1782 discovered the element molybdenum in this mineral.

Molybdenite occurs as disseminated scales in crystalline rocks—such as granite, gneiss, schist and marble—and also in quartz-veins. It has been found in small amounts at many localities, but only those which have yielded large crystals need be specially mentioned here, viz. in a pyroxene-rock at Aldfield in Pontiac county, Quebec; with native bismuth at Kingsgate in Gough county, New South Wales; with wolframite and scheelite in quartz-veins at Caldbeck Fells in Cumberland; and recently, as crystals 6 in. across, at Slangsvold near Raade in Norway.

Molybdenite has been used mainly for the preparation of molybdates for use as chemical reagents. Recently, however, it has been used in the manufacture of molybdenum steel (ferro-molybdenum), which by reason of its hardness and toughness is specially suitable for tools. (L. J. S.)

MOLYBDENUM [symbol, Mo; atomic weight, 96 (O=16)] a metallic chemical element. The name is derived from Gr. μολύβδος, lead, and was originally employed to denote many substances containing or resembling lead; ultimately the term was applied to graphite and to molybdenum sulphide. The difference between these two latter substances was first pointed out by Cronstedt, and in 1778 C. Scheele prepared molybdic acid from the sulphide. Molybdenum occurs in nature chiefly as the minerals molybdenite (MoS₂) and wulfenite (PbMoO₄), and more rarely as molybdic ochre (MoO₃) and ilsemanite; it also occurs in many iron ores. The metal may be obtained by heating the trioxide with carbon in the electric furnace (H. Moissan, *Comptes rendus*, 1893, 116, p. 1225), or by the Goldschmidt method (Rosenheim and Braun, *Zeit. anorg. Chem.*, 1905, p. 311) or by dissociating the tetra- and penta-chloride in a graphite crucible with an electric current below 1330° (J. N. Pring and W. Fielding, *Jour. Chem. Soc.*, 1909, 95, p. 1497). It forms a grey coloured powder of specific gravity 9.01; it is malleable, and not as hard as glass. It is rapidly oxidized on heating to a temperature of 500°–600° C., and also when fused with nitre or potassium chlorate. It is soluble in dilute nitric acid, and in concentrated sulphuric acid; in the

latter case with the formation of a blue solution which on heating becomes colourless, molybdenum trioxide being formed with the liberation of sulphur dioxide.

Molybdenum combines with oxygen to form many oxides, the most important of which are: the monoxide, MoO_n (H_2O), the sesquioxide, Mo_2O_3 , the dioxide, MoO_2 , and the trioxide, MoO_3 . *Molybdenum monoxide*, MoO_n , $\text{MoO}_n(\text{H}_2\text{O})$, is a black powder obtained when the dichloride is boiled with concentrated potash solution. According to W. Muthmann and W. Nagel (*Ber.*, 1898, 31, p. 2009), this oxide does not exist, the reaction leading to the formation of an hydroxide according to the equation: $\text{Mo}_2\text{Cl}_2(\text{OH})_2 + 4\text{KHO} + 3\text{H}_2\text{O} = 3\text{Mo}(\text{OH})_3 + 4\text{KBr} + 3\text{H}_2$. *Molybdenum sesquioxide*, Mo_2O_3 , a black mass insoluble in acids, is formed by heating the corresponding hydroxide *in vacuo*, or by digesting the trioxide with zinc and hydrochloric acid. *Molybdenum dioxide*, MoO_2 , is formed by heating sodium trimolybdate, $\text{Na}_2\text{Mo}_3\text{O}_{10}$, to redness in a current of hydrogen (L. Svanberg and H. Struve, *Jour. prak. Chem.*, 1848, 44, p. 301), or by long fusion of a mixture of ammonium molybdate, potassium carbonate, and boron trioxide (W. Muthmann, *Ann.*, 1887, 238, p. 114). It forms quadratic prisms, having a violet reflex and insoluble in boiling hydrochloric acid. *Molybdenum trioxide*, MoO_3 , is prepared by oxidizing the metal or the sulphide by heating them in air, or with nitric acid. It is a white powder, which turns pale yellow on heating, and melts at a red heat. It sublimes in small rhombic tables or needles, and is slightly soluble in cold water, the solution possessing an acid reaction. Several hydrated forms of the oxide are known, and a colloidal variety may be obtained by the dialysis of a strong hydrochloric acid solution of sodium molybdate. Molybdenum trioxide, like chromium trioxide, is an acidic oxide, and forms salts known as molybdates. The normal molybdates show a tendency to pass into polymolybdates; the molybdates are also capable of combining with other oxides (such as phosphorus and arsenic pentoxides) yielding very complex salts. The ordinary ammonium molybdate, used as a test reagent for phosphates, is a salt of composition $(\text{NH}_4)_{10}\text{Mo}_2\text{O}_{24}$; it has been examined physicochemically by J. Sand and F. Eisenlohr (*Abst. J.C.S.*, 1907, ii, pp. 178, 179). The molybdates may be recognized by the fact that they give a white precipitate on the addition of hydrochloric or nitric acids to their solutions, and that with reducing agents (zinc and sulphuric acid) they give generally a blue coloration which turns to a purple and finally a brown colour.

Molybdenum combines with the halogen elements in varying proportions, forming with chlorine a di-, tri-, tetra- and penta-chloride, and similar compounds with bromine and iodine. *Molybdenum dichloride* (MoCl_2) or $\text{Cl}_2\text{Mo}_2\text{Cl}_6$ (chloromolybdenum chloride), is prepared (together with some tetrachloride) by heating the tri-chloride in a stream of carbon dioxide (C. W. Blomstrand, *Jour. f. prak. Chem.*, 1857, 71, p. 449; 1861, 82, p. 433). It is a yellow amorphous powder which is soluble in dilute alkalis, the solution on acidification giving an hydroxide, $\text{Cl}_2\text{Mo}_2(\text{OH})_2$, which is soluble in nitric acid, and does not give a reaction with silver nitrate. The molecular weight determinations of W. Muthmann and W. Nagel (*Ber.*, 1898, 31, p. 2002) show the salt to possess the composition Mo_2Cl_6 . *Molybdenum trichloride*, MoCl_3 , is obtained when the pentachloride is heated to a temperature of about 250° C. in a current of hydrogen. It forms red crusts, is insoluble in cold water, but is decomposed by boiling water. It is easily soluble in hot nitric acid. *Molybdenum pentachloride*, MoCl_5 , is obtained when molybdenum is gently heated in dry chlorine (L. P. Liechti and B. Kempe, *Ann.*, 1873, 169, p. 345). It is a dark-coloured crystalline solid which melts at 104° C. and boils at 268° C. It fumes in moist air and deliquesces gradually. It is occasionally used as a chlorine carrier. It is soluble in absolute alcohol and in ether. *Molybdenum disulphide*, MoS_2 , is found as the mineral molybdenite, and may be obtained by heating the trioxide with sulphur or sulphuretted hydrogen. It is a black crystalline powder, resembling graphite in appearance. It is readily oxidized by nitric acid, and when strongly heated in a current of hydrogen is reduced to the metallic condition. *Molybdenum trisulphide*, MoS_3 , is obtained by saturating a solution of an alkaline molybdate with sulphuretted hydrogen and adding a mineral acid. It is a brown powder which on heating in air loses sulphur and leaves a residue of the disulphide. *It tetrasulphide*, MoS_4 , has also been described.

Many varying values have been given for the atomic weight of molybdenum. J. J. Berzelius (*Zogg. Ann.*, 1826, 8, p. 23), by converting the lead molybdenite, and may be obtained the value 95.2; while J. B. A. Dumas (*Ann.*, 1860, 113, p. 32), by converting the trioxide into the metal, obtained the value 95.65. K. Seubert and W. Pollard (*Zeit. anorg. Chem.*, 1895, 8, p. 434) using this second method obtained the value 96.28; while E. F. Smith and P. Maas (*Zeit. anorg. Chem.*, 1894, 5, p. 280), by heating pure sodium molybdate in hydrochloric acid and estimating the amount of sodium chloride formed, obtained the value 96.087.

MOLYNEUX. This historic English name came into the country from France at the time of the Norman Conquest through William de Molines (Moleyns, Molyneux), who obtained a grant of Sefton, in Lancashire, whence came the earls of Sefton to-day. His descendant Adam de Molyneux (Moleyns or

Molins), who died in 1450, was bishop of Chichester and keeper of the privy seal; he was a son of Sir Richard Molyneux of Sefton, and uncle of the Sir Richard Molyneux (d. 1459), the Lancastrian and favourite of Henry VI., whose descendant Richard Molyneux (1593-1636) was created in 1628 1st Viscount Molyneux of Maryborough, a title now merged in that of Sefton (created 1771). Another Molyneux family of some importance is the Irish one, descended from Sir Thomas Molyneux (1531-1597), Irish chancellor of the exchequer, who, born at Calais, settled in Ireland in 1576. He was the great-grandfather of Sir Thomas Molyneux, Bart. (1661-1733), a well-known physician and zoologist, and of William Molyneux (1656-1698), the philosopher, astronomer and politician, the friend of Locke, and author of *Dioptrica nova* (1692), whose famous work on the legislative independence of Ireland (*The Case of Ireland*, &c. 1698) created much stir at the time. The latter's son Samuel Molyneux (1689-1728), was also a well-known astronomer.

MOMBASA, the principal seaport of British East Africa, in 4° 4' S., 39° 43' E., 150 m. N. of Zanzibar. Pop. about 30,000. Mombasa is built on a coraline island which nearly fills the mouth of a deep arm of the sea. The channel on either side of the island—Mombasa to the N.E., Kilindini to the S.W.—affords safe harbourage, and each leads to a deeper ramification of the sea, Mombasa Harbour to Port Tudor, Kilindini Harbour to Port Reitz. Mombasa town is on the N.E. side of the island, 2 m. from Kilindini, with which it is connected by rail and tramways. Viewed from the sea Mombasa has a picturesque appearance, the most conspicuous object being the fort, built on a coral hill 40 ft. high. Except for the main street and Government Square (close to the harbour and containing the customs-house and other official buildings), Mombasa proper presents the usual aspect of an Oriental city—a maze of narrow, irregular streets and lanes. To the south, overlooking the sea, is the European suburb. There are Anglican and Roman Catholic churches (the Roman Catholic church and mission house is one of the finest buildings in Mombasa), mission schools, Hindu, Parsee, and Mahomedan temples, and hospitals and law courts, the last named completed in 1902. Built into the façade of the courts is a stone with an inscription recording the building of a fort, dedicated to St Joseph, by the Portuguese at Kilindini in 1666. This stone was found in the ruins of Fort St Joseph. Mombasa Fort, or citadel, quadrangular in form, was built by the Portuguese in 1593-1595 (as an inscription in the interior testifies), was dedicated to the Saviour, and known as the Jesus Fort. It bears the symbol I.H.S. The fort was repaired by Seixas de Cabreira in 1635, the restoration being recorded in an inscription over the gateway. By the British authorities the fort is used as a military store and central gaol. In the public garden on the point of the town facing the sea a bronze statue of Sir William Mackinnon—to whom Mombasa owes its renaissance—has been placed. The population of the city is cosmopolitan, with three well-marked racial distinctions: the Arab (Swahili), the Indian and the European. The climate is fairly healthy, and Europeans live there with comfort.

The harbour at Mombasa is more than a mile in length, but only 1200 ft. in width. It is consequently not so suitable for large ships as Kilindini ("the place of deep water"), which possesses the finest land-locked harbour on the East Coast of Africa. The entrance is about the same width as that of Mombasa, but Kilindini Harbour widens to $\frac{1}{2}$ m. and is 3 m. long, the depth of water varying from 25 to 30 fathoms. Kilindini is a depot of the British navy. Port Reitz, which opens out of Kilindini Harbour westward, is 4 m. long and 1 m. broad, with excellent anchorage. At Kilindini is a pier alongside which ships 450 ft. in length and drawing 27 ft. can load and unload cargo. Here is the virtual terminus of the Uganda railway, and the offices, workshops and hospital connected therewith, also a branch customs-house. The Uganda railway crosses to the mainland on a bridge, $\frac{1}{2}$ m. long, built over the shallow channel which on the north-west separates the island from the continent. Mombasa is the outlet for the produce of a large tract of territory, including the European

settlements in the highlands of the protectorate, and by means of the railway to Victoria Nyanza taps the rich regions of the Nile sources. German, British, French and Austrian mail-boats call regularly at the port, which is connected by submarine cable with Zanzibar. Trade statistics are included in those of British East Africa (*q.v.*).

Mombasa Island (named after the town) is 3 m. long by 2½ m. broad, with an area of 9 sq. m. Except at the western end, the coast of the island consists of cliffs from 40 ft. to 60 ft. high. The island contains many fertile plantations, chiefly of coco-nut palms, except on the side facing the ocean, where there is little vegetation, the coral reefs being but thinly covered with earth. There are no springs and the island is dependent for water on rain collected in tanks or drawn from wells—the latter brackish. Ruins of Arab, Portuguese and Turkish buildings are found in various parts of the island. At Ras Serani are the ruins of a chapel "Nossa Senhora das Mercês," built by the Portuguese in the 17th century on the site of a Turkish fort, and afterwards turned into a fort again by the Arabs.

Mombasa takes its name from Mombasa in Oman. A Perso-Arabic settlement was made here about the 11th century. It is mentioned by Ibn Batuta in 1331 as a large place, and at the time of Vasco da Gama's visit (1498) it was the seat of considerable commerce, its inhabitants including a number of Calicut Banyans and Oriental Christians. The ruler of the city tried to entrap da Gama (or so the Portuguese navigator imagined), and with this began a series of campaigns which gave full force to its Swahili name *Mvita* (war). The principal incidents are the capture and burning of the place by Almeida (1505), Nuno da Cunha (1520), and Duarte de Menezes (1587)—this last as a revenge for its submission to the sultan of Constantinople—the revolt and flight (1631) of Yusuf ibn Ahmed (who murdered all the Portuguese in the town—over 100), and the three-years' siege by the imam of Omam 1696–98 (the garrison being reduced to eleven men and two women), ending in the expulsion of the Portuguese. From the 12th of March 1728 to the 20th of November 1729 a Portuguese force from Goa again held Mombasa, when they were finally driven out by the Muscat Arabs. In December 1823 the Mazrui family, who had ruled in Mombasa from the early part of the 18th century, first as representatives of Oman, afterwards as practically independent princes, placed the city under British protection; and in February 1824 Lieut. J. J. Reitz was appointed commandant or resident at the city by Captain (afterwards Vice-Admiral) W. F. W. Owen. Reitz, after whom Port Reitz is named, died at Mombasa either in 1824 or 1825. The protectorate was repudiated by the British government, which left the place to be bombarded and captured by Seyyid Said of Oman, who made repeated attacks between 1820 and 1833, and only got possession in 1837 by treachery. Said thereafter made Zanzibar his capital, Mombasa becoming of secondary importance. A revolt against Zanzibar in 1875 was put down with British assistance. The British government in the following year vetoed a proposal by the khedive Ismail to annex Mombasa and its hinterland up to the equatorial lakes to Egypt—a project which originated with General C. G. Gordon, when that officer administered the Upper Nile provinces. In 1887 the city was handed over by the sultan of Zanzibar to the British for administration. It became the capital of the province of Seyyidie and of the East Africa protectorate. In 1907, however, the seat of the central government was removed to Nairobi (*q.v.*). Mombasa still forms, nominally, part of the sultanate of Zanzibar. The city, together with Malindi, is mentioned in *Paradise Lost*.

MOMEIN, the Burmese name of the Chinese city Têng-yueh-chow, in the S.W. of the province of Yunnan, China. It was opened to foreign trade by the Burmese Convention of 1807, but so far no advantage has been taken of the permission. It lies close to the Burmese frontier and on the old trade route from Bhamo to Yunnan, but its importance as an outpost of the British Empire is political rather than commercial. The distance from Têng-yueh to Bhamo by the usual trade route is 160 m., and is generally traversed by pack-animals in seven

or eight days. In a straight line the two towns are only 80 m. apart. Near Momein and within its jurisdiction is the frontier town of Manwyne, where A. R. Margary was assassinated in January 1875.

MOMMSEN, THEODOR (1817–1903), German historian and archaeologist, was born on the 30th of November 1817 at Garding, in Schleswig. After being educated at the university of Kiel he devoted himself to the study of Roman law and antiquities. In 1843 a grant from the Danish government enabled him to undertake a journey to Italy, which was to be decisive for his future career. There he began the study of Roman inscriptions, in association with other Italian and German scholars, especially Borghesi, de Rossi and Henzen. His first work was directed to the restoration of the old Italian dialects, and the French government, which at one time proposed to undertake the task of compiling a complete collection of all extant Roman inscriptions, asked for his co-operation. When they gave up the project it was taken up by the Berlin Academy, which had recently completed the collection of Greek inscriptions edited by Boeckh. They had already made a grant to Mommsen and in 1844 Savigny proposed that he should be appointed to carry out the great work. Many years, however, passed before the plan was finally approved. Meanwhile Mommsen continued his work in Italy: he drew up a full memorandum explaining the principles on which a *Corpus inscriptionum* should be compiled, and on which alone he could undertake the editorship. As a specimen he collected the inscriptions of Samnium, and in 1852 published those of the kingdom of Naples. These works caused him to be recognized as the first authority in this field of learning. In 1847, however, he was obliged to return to Germany: he first went to Schleswig, where during the Revolution he edited a paper in which he supported the claims of the Elbe Duchies; at the end of 1848 he was appointed professor of civil law at Leipzig. His work there was interrupted by his political opinions. During 1848, when the extreme party was in the ascendant, Mommsen supported the monarchy against the Republicans. With characteristic courage and independence, next year, when the Revolution had spent its force and Beust executed his *coup d'état*, he protested, with many of his colleagues, against this act. In consequence he was summoned before a disciplinary court, and, together with Haupt and Jahn, dismissed from his professorship.

Mommsen found an asylum in Switzerland, and became professor at Zurich: he repaid the hospitality of the Republic by writing exhaustive monographs on Roman Switzerland. His spare time was occupied with the *Roman History*, the three volumes of which appeared between 1854 and 1856. His name at once became known throughout Europe. In this work, with a true insight into the relative importance of things, he passed over with a few strong broad touches the antiquarian discussions on the origins of the city, on which previous historians had laboured so long; but in place of this he painted with astonishing vigour the great political struggle that accompanied the fall of the republic. It was, above all, his new reading of old characters which demanded attention, if not always approval: Cicero, the favourite of men of letters, was for him "a journalist in the worst sense of the word"; Pompey, the hero of Plutarch and the Moralists, was brushed aside as a mere drill-sergeant; and the book culminated in the picture of Caesar, who established absolute rule in the name of democracy, "the complete and perfect man."

The three volumes ended with the dictatorship of Caesar. The book has never been continued, for the volume on the *Roman Provinces under the Empire*, which appeared in 1884, is in reality a separate work. Mommsen was henceforward fully occupied with work of a more technical nature. In 1854 the definite offer was made to him by the Academy that he should be chief editor of a *Corpus inscriptionum*, with full control, and in order that he might carry on the work he was appointed in 1858 to a professorship at Berlin. The first volume appeared in 1861; five of the succeeding volumes he edited himself, and the

whole was executed under his immediate supervision and with the co-operation of scholars whom he had himself trained.

Enormous as was the labour, this task occupied only a small part of his extraordinary intellectual energy. He found time to write two larger works, the *History of the Roman Coinage* and the *Römisches Staatsrecht*, a profound analysis of Roman constitutional law, and *Römisches Strafrecht*, on Roman criminal jurisdiction. His *Roman Provinces* already mentioned gives a singularly interesting picture of certain aspects of social life under the empire. His smaller papers amount to many hundreds in number, and there is no department of Roman life and learning, from the earliest records of the Roman law to the time of Jordanes, which he has not illuminated. As secretary to the Berlin Academy for over twenty years he took a leading part in their deliberations, and was their spokesman on great occasions. His interest in political problems of the present was as keen as in those of the past. He was one of the founders of the *Preussische Jahrbücher*, the most influential of German political periodicals. For many years he was a member of the Prussian Parliament. His political opinions were strong but ill-regulated. Intensely nationalist, he acquiesced in the annexation of his native land to Prussia, and in a public letter to the Italian nation in 1870 defended the German cause before the nation which had become to him a second fatherland; but he was of too independent a character ever to be quite at ease under Prussian government. Loving liberty, he hated its consequences; a democrat, he had and always expressed a profound contempt for the mob. Like many idealists, he was a severe critic of the faults of his own and other countries, and he added something to the increasing Chauvinism in Germany.

It was, however, above all, German scholarship which remained his first interest. There is probably no other instance in the history of scholarship in which one man has established so complete an ascendancy in a great department of learning. Equally great as antiquary, jurist, political and social historian, he lived to see the time when among students of Roman history he had pupils, followers, critics, but no rivals. He combined the power of patient and minute investigation with a singular faculty for bold generalization and the capacity for tracing out the effects of thoughts and ideas on political and social life. Partly, perhaps, owing to a philosophical and legal training, he had not the gift of clear and simple narrative, and he is more successful in discussing the connexion between events than in describing the events themselves. Though his *History* ends with the fall of the republic, his most enduring work has been that on the empire; and if he has not written the history of the empire, he has made it possible for others to do so.

Mommsen died at Charlottenburg on the 1st of November 1903. His brothers, Carl Johann Tycho (1819-1900), a great authority on Pindar and Shakespeare, and August (b. 1821), who wrote chiefly on ancient chronology and Greek festivals, were also prominent among German scholars in their day.

The *History of Rome* (including the volumes of the provinces) has been translated into English by W. P. Dickson (the *Provinces*, revised by F. Haverfield, 1909); there is a French edition of his work on *Roman Coinage*. Many of his pamphlets and articles have been collected under the title *Römische Forschungen*. Of his other works, the more important are the *Roman Chronology to the Time of Caesar* (1858), a work written in conjunction with his brother August; his editions of the *Momentum Anagninum* and of the *Diogenes in the Corpus juris civilis*, and of the *Chronica* of Cassiodorus in *Monumenta Germaniae historica*, the *Actores antiquissimi* section of which was under his supervision. A great part of his work is to be found in the German learned publications such as *Hermes*, *Rheinisches Museum*, &c. His *Reden und Aufsätze* and *Gesammelte Schriften*, i. ii., were published after his death. A full list of his works is given by Zangemeister, *Mommsen als Schriftsteller* (1887; continued by Jacobs, 1905). See also monographs by C. Bardt (1903) and Gradenwitz (1904), in the *Zeitschrift der Savigny-Stiftung für Rechtsgeschichte*, and O. Hirschfeld, *Gedächtnisrede auf Theodor Mommsen* (1904).

MOMORDICA, in botany, a genus of annual or perennial climbing herbs belonging to the natural order Cucurbitaceae, natives of the tropics, especially Africa, and known in cultivation chiefly as hothouse plants. They are grown for their ornamental

fleshy fruits, which are oblong to cylindrical in shape, orange to red in colour, prickly or warted externally, and burst when ripe, generally with elastic force, into irregular valves. *M. Balsamina*, known as balsam apple, is a very pretty annual, well adapted for trellises, &c., in warm outside situations.

MOMUS, in Greek mythology, the son of Nŏt (Night), the personification of censoriousness. He is frequently mentioned in Lucian as the lamponer of the gods. It is said that Pallas, Hephaestus, and Poseidon entered into a competition as to which of them could create the most useful thing. Hephaestus made a man, Poseidon an ox, Pallas a house. Momus, being called upon to pronounce an opinion as to the merits of these productions, expressed dissatisfaction with all: with the man, because a window ought to have been made in his breast, through which his heart could be seen; with the ox, because its horns were in the wrong place; with the house, because it ought to have been portable, so as to be easily moved to avoid unpleasant neighbours. Momus is reported to have burst with chagrin at being unable to find any but the most trifling defects in Aphrodite. He is represented sometimes as a young, sometimes as an old man, wearing a mask, and carrying a fool's bauble.

Hesiod, *Theogony*, 214; Lucian, *Hermotimus*, 20, and especially *Deorum Concilium*; Philostratus, *Epistolae*, 37.

MONA, the name used by classical writers, and in particular by Tacitus, to denote Anglesey (*g.v.*). This island was raided by the Roman general Suetonius about A.D. 60 and conquered by Agricola about A.D. 79. The Romans probably mined copper there, but no trace has yet been found of any Roman military post, and the villages of the inhabitants which have been recently excavated show only mediocre traces of Roman civilization. The name Mona seems also to have been occasionally used, perhaps from ignorance, for the other large island lying between England and Ireland, Man. The ancient name of this latter was probably not unlike that of Mona, but is not accurately known to us (? Monapia, Manavia). (F. J. H.)

MONACO, a territory of south-eastern France, the smallest of the sovereign principalities of Europe. Area about 8 sq. m., the length being 2½ m. and the width varying from 165 to 1100 yds. Pop. (1900), 15,180. Monaco is situated on the coast of the Mediterranean, 9 m. east of Nice, and is bounded on all sides by the French department of Alpes-Maritimes. It includes the towns of Monaco (3292), Condamine (6218) and Monte Carlo (3794). The principality at one time included Mentone and Rocca-bruna, now known as Roquebrune, which towns, however, were ceded to France in 1861 for a sum of four million francs. The town of Monaco occupies the level summit of a rocky headland, rising about 200 ft. from the shore, and still defended by ramparts. Though largely modernized, the palace is an interesting specimen of Renaissance architecture; the "cathedral" (Romanesque-Byzantine style), and the oceanographical museum may also be mentioned. For this museum a fine building, appropriately decorated, was opened in March 1910 by the prince of Monaco. It stands on the edge of the cliff rising from the sea at the gardens of St Martin, and was designed to house the collections made by the prince during twenty-five years of oceanographical research, and others. Behind the rock, between Mont Tête de Chien and Mont de la Justice, the high grounds rise towards La Turbie, the village on the hill which takes its name from the *tropea* with which Augustus marked the boundary between Gaul and Italy. On the north lies the bay of Monaco; along the lower ground on the west of the bay stretches the health and bathing resort of Condamine; with orange-gardens, manufactures of perfumes and liqueurs, and the chapel of Ste Dévote, the patron saint of Monaco; to the north of the bay on the rocky slopes of the Spélugues (speluncae) are grouped the various buildings of the Casino of Monte Carlo with the elaborate gardens and the numerous villas and hotels which it has called into existence. Adjoining the Casino terrace and overlooking the sea is the pigeon-shooting ground, the competitions on which are celebrated.

There appear to have been gambling-tables at Monte Carlo

in the year 1856, but it was in 1861 that François Blanc, seeing his tenancy at Homburg coming to an end, with no hope of renewal, obtained a concession for fifty years from Charles III. This concession passed into the hands of a joint-stock company, which in 1808 obtained an extension to 1947, in return for a payment to the prince of £400,000 in 1809 and of £600,000 in 1913, together with an increase of the annual tribute of £150,000 to £170,000 in 1907, £80,000 in 1917, £90,000 in 1927, and £100,000 in 1937. None of the inhabitants of Monaco have access to the tables; and their interest in the maintenance of the *status quo* is secured by their complete exemption from taxation and the large prices paid for their lands. The ruler of the principality, Prince Albert, born 1848, succeeded his father, Prince Charles III., in 1889. He married in 1869 Lady Mary Douglas Hamilton, by whom in 1870 he had a son, Prince Louis; that marriage was, however, annulled in 1880, and subsequently Prince Albert married Alice, dowager-duchess of Richelieu, from whom he was divorced in 1902. The prince is absolute ruler, as there is no parliament in the principality. He is advised by a small council of state, the members of which are appointed by himself. The maire and other municipal authorities are also appointed by the prince. A governor-general presides over the administration. The judicial system is the same as that of France, there being a court of first instance and a *juge de paix*. By arrangement, two Paris judges form a court of appeal. Monaco is the seat of a Roman Catholic bishop.

A temple of Heracles seems to have been built on the Monaco headland by the Phoenicians at a very early date, and the same god was afterwards worshipped there by the Greeks under the surname of *Μόνακος*, whence the name Monaco. Monecoi Portus or Portus Herculis is frequently mentioned by the later Latin writers. From the 10th century the place was associated with the Grimaldi, a powerful Genoese family who held high offices under the republic and the emperors; but not till a much later date did it become their permanent possession and residence. In the beginning of the 14th century it was notorious for its piracies. Charles I. (a man of considerable mark, who, after doing great service by sea and land to Philip of Valois in his English wars, was severely wounded at Crecy) purchased Mentone and Rocca-bruna, and bought up the claims of the Spinola to Monaco. The princes of Monaco continued true to France till 1524, when Augustin Grimaldi threw in his lot with Charles V. Honoré I., Augustin's successor, was made marquis of Campagna and count of Canosa, and people as well as rulers were accorded various important privileges. The right to exact toll from vessels passing the port continued to be exercised till the close of the 18th century. Honoré II. in 1641 threw off the supremacy of Spain and placed himself under the protectorate of France; he was compensated for the loss of Canosa, &c., with the duchy and peerage of Valentinois and various lesser lordships; and "duke of Valentinois" long continued to be the title of the heir-apparent of the principality. In 1731 Antoine, his great-grandson, was succeeded by his daughter Louise Hippolyte; she had married Jacques Goyon, count of Matignon and Thorigny, who took the name of Grimaldi and succeeded his wife. The National Convention annexed the principality to France in 1793; restored to the Goyon Grimaldis by the Treaty of Paris in 1814, it was placed by that of Vienna under the protection of Sardinia. The Sardinian government took the opportunity of disturbances that occurred in 1848 to annex Mentone and Rocca-bruna, which were occupied by a Sardinian garrison till 1859. With the transference of Nice to France in 1860 the principality passed again under French protection.

See H. Métivier, *Monaco et ses princes*, La Flèche (1862).

MONAD (Gr. *μόνος*, unit, from *μῶνος*, alone), a philosophic term which now has currency solely in its connexion with the philosophy of Leibnitz. In the earlier Greek philosophy the term meant unity as opposed to duality or plurality; at a later time it meant an individual, or, with the Atomists, an atom. It was first used in a sense approximate to that of Leibnitz by Bruno, who meant by it a primary spiritual element as opposed to the material atom. Leibnitz, however, seems to have

borrowed the term not directly from Bruno, but from a contemporary, Van Helmont the younger. Leibnitz's view of things is that the world consists of monads which are immaterial centres of force, each possessing a certain grade of mentality, self-contained and representing the whole universe in miniature, and all combined together by a pre-established harmony. Material things, according to Leibnitz, are in their ultimate nature composed of monads, each soul is a monad, and God is the *monas monadum*. Thus monadism, or monadology, is a kind of spiritual atomism. The theory has been revived in recent years by C. B. Renouvier.

MONADNOCK, a term derived from Mount Monadnock in New Hampshire, U.S.A., to denote the "isolated remnants of hard rock which remain distinctly above their surroundings in the late stages of an erosion cycle" (T. C. Chamberlin, R. D. Salisbury). Examples are frequently found where a hard pipe of igneous rock surrounded by softer rock is gradually exposed by the washing away of the softer rock and becomes a conspicuous feature of the landscape, forming a volcanic "neck," and finally, in the later stages of erosion, a stump. The Peak Downs, Queensland, furnish many examples, and Mato Tepe, Wyoming, is a remarkably conspicuous instance of this type of formation.

MONAGHAN, a county of Ireland in the province of Ulster, bounded E. by Fermanagh, S.E. by Louth, S. by Meath, S.W. by Cavan, W. by Armagh, and N. by Tyrone. The area is 319,741 acres, or about 496 sq. m. The north-western part of the county is included in the great central plain of Ireland; but to the south and east the surface is irregular, although none of the hills is of great elevation. The principal range is that of Slievebeagh, a rugged and barren tract extending into the county Fermanagh, its highest summit being 1254 ft. above sea-level. The principal rivers are the Finn, which rises near the centre of the county and passes into Fermanagh, and the Blackwater, which forms the boundary with Tyrone. The Ulster Canal passes the towns of Monaghan and Clones, affording communication between Lough Neagh and Lough Erne. In geological structure the county drops from the Upper Carboniferous outlier of Slievebeagh in the north-west to a Carboniferous Limestone area towards Monaghan town; but south of this a tumbled Silurian area stretches across the Cavan and Armagh borders. At Carrickmacross, an outlier of Carboniferous Limestone, Coal Measures (with poor seams of coal) and Trias is encountered. Gypsum has been quarried in the Trias, and lead ore was formerly mined in many places in the Silurian area. The Triassic clay furnishes excellent bricks. Eskers or glacial ridges occur at several places. The limestone is not only abundant and good, but from the position of the rocks it can be obtained at small expense in working. Freestone and slates are quarried in considerable quantities. The soil in the more level portions of the county is fertile where it rests on limestone, and there is also a mixed soil of deep clay, which is capable of high cultivation; but in the hilly regions a strong retentive clay prevails, which could be made productive only by careful draining and culture. Spade husbandry generally prevails. The proportion of tillage to pasturage is roughly as 1 to 1½. Oats, potatoes and turnips are the principal crops, but the quantity grown decreases. The number of cattle, sheep, pigs, goats and poultry, on the other hand, increases or is well maintained. Linen is the only manufacture of consequence, but the cultivation of flax has almost died out. The Belfast and Clones line of the Great Northern railway crosses the county from north-east to west, passing the town of Monaghan, and the Dundalk and Clones line of the same company runs from south-east to west, with branches to Carrickmacross and to Coochell (county Cavan).

The population (86,206 in 1801; 74,611 in 1901) decreases as rapidly as any county population in Ireland, and emigration is very heavy. The total includes about 73% of Roman Catholics, and about 12% each of Protestant Episcopalians and of Presbyterians. The principal towns are Monaghan (the county town, pop. 2032), Clones (2068), Carrickmacross (1874),

Castleblayney (1576) and Ballybay (1208). The county includes five baronies. Assizes are held at Monaghan, and quarter sessions at Carrickmacross, Castleblayney, Clones and Monaghan. The two county members sit for the north and south divisions respectively. The county is in the Protestant and Roman Catholic dioceses of Clogher.

The district now called the county Monaghan was included in the district of Uriel or Orgial, and long known as Macmahon's country. It was made shire ground under its present name by Sir John Perrot in the reign of Elizabeth. At Clones there is a round tower in good preservation, but very rude in its masonry, another at Inishkeen is in ruins. Near Clones there are two large raths. Although there are several Danish forts there are no mediæval castles of importance. The only monastic structure of which any vestiges remain is the abbey of Clones, which was also the seat of a bishopric. The abbey dates from the 6th century, but was rebuilt in the 14th century after destruction by fire.

MONAGHAN, a market town and the county town of county Monaghan, Ireland, on the Ulster Canal and the Belfast and Clones line of the Great Northern railway, by which it is 52 m. S.W. by W. of Dublin. Pop (1001), 2032. There is a modern Roman Catholic cathedral (1862-1802) for the diocese of Clogher, a convent of the Sisters of St. Louis, and a Protestant church (1836), and the public and county buildings include court-house, gaol, workhouse, asylum, hospital and barracks. Educational establishments include a national model school and the college of St. Macartan, preparatory for the Roman Catholic priesthood. The town takes its name (Muinechan, the town of monks) from an early monastery. It was incorporated by James I., but was little more than a hamlet until the close of the 18th century. Rossmore Park, the fine demesne of Lord Rossmore, is the most noteworthy of several neighbouring residences. The town is governed by an urban district council.

MONA MONKEY, a West African representative of the group of monkeys generally known as guenons, and scientifically as *Cercopithecus*. The mona (*C. mona*) typifies a sub-genus of the same name (*Mona*) characterized, among other features, by the presence of a black band running from the angle of each eye to the ear. In the mona itself the general colour of the upper parts is black, with a pair of oval white spots near the root of the tail, while a band across the forehead and the whole under surface are likewise white. (See PRIMATES)

MONARCHIANISM, a theological term designating the view taken by those Christians who, within the Church, towards the end of the 2nd century and during the 3rd, opposed the doctrine of an independent personal subsistence of the Logos. During the middle of the 2nd century a number of varying christological views began to germinate, growing for a time side by side. They fall into two great classes: (a) Christ was a man in whom the Spirit of God had dwelt; (b) Christ was the Divine Spirit who had assumed flesh. Each class based its position on Scripture, but the latter (which prevailed) had the advantage of being able easily to combine with cosmological and theological propositions current in the religious philosophy of the time. The opposition to it arose out of a fear that it threatened monotheism. The representatives of the extreme monotheistic view, which while regarding Christ as Redeemer, clung tenaciously to the numerical unity of the Deity, were called Monarchians, a term brought into general use by Tertullian. It has to be remembered (1) that the movement originated within the pale of the Church, and had a great deal in common with that which it opposed; (2) that it was ante-Catholic rather than anti-Catholic, e.g. the Canon of the New Testament had not yet been established. It is usual to speak of two kinds of monarchianism—the dynamic and the modalistic, though the distinction cannot be carried through without some straining of the texts. By monarchians of the former class Christ was held to be a mere man, miraculously conceived indeed, but constituted the Son of God simply by the infinitely high degree in which he had been filled with Divine wisdom and power. This view was represented in Asia Minor about the year 170 by the anti-Montanistic Alogi, so called by

Epiphanius on account of their rejection of the Fourth Gospel; it was also taught at Rome about the end of the 2nd century by Theodotus of Byzantium, a courier, who was excommunicated by Bishop Victor, and at a later date by Artemon, excommunicated by Zephyrinus. About the year 260 it was again propounded within the Church by Paul of Samosata (*q.v.*), who held that, by his unique excellency, the man Jesus gradually rose to the Divine dignity, so as to be worthy of the name of God. Modalistic monarchianism, conceiving that the whole fullness of the Godhead dwelt in Christ, took exception to the "subordinationism" of some Church writers, and maintained that the names Father and Son were only two different designations of the same subject, the one God, who "with reference to the relations in which He had previously stood to the world is called the Father, but in reference to His appearance in humanity is called the Son." It was first taught, in the interests of the "monarchia" of God, by Praxeas, a confessor from Asia Minor, in Rome about 190, and was opposed by Tertullian in his well-known controversial tract. The same view—the "patripassianism" as it was also called, because it implied that God the Father had suffered on the cross—obtained fresh support in Rome about 215 from certain disciples of Noetus of Smyrna, who received a modified support from Bishop Callistus. It was on this account that Hippolytus, the champion of hypostasian subordinationism, along with his adherents, withdrew from the obedience of Callistus, and formed a separate community. In Carthage, Praxeas for a time had some success, but was forced by Tertullian not only to desist but to retract. A new and conciliatory phase of patripassianism was expounded at a somewhat later date by Beryllus of Bostra, who, while holding the divinity of Christ not to be *ὁμοῦ*, or proper to Himself, but *παράκει* (belonging to the Father), yet recognized in His personality a new *πρόσωπον* or form of manifestation on the part of God. Beryllus, however, was convinced of the wrongness of this view by Origen (*q.v.*), and recanted at the synod which had been called together in 244 to discuss it. (For the subsequent history of modalistic monarchianism see SABELLIUS.)

See the Histories of Dogma by A. Harnack, F. Loofs, R. Seeberg; also R. L. Outley, *The Doctrine of the Incarnation*.

MONARCHY (Fr. *monarchie*, from Lat. *monarchia*, Gr. *μοναρχία*, rule of one, *μῦνος*, alone, *ἀρχή*, rule), strictly, the undivided sovereignty or rule of a single person. Hence the term is applied to states in which the supreme authority is vested in a single person, the monarch, who in his own right is the permanent head of the state. The character of true monarchy is well defined in the well-known lines of Cowper (*Verses supposed to be written by Alexander Selkirk*):

"I am monarch of all I survey,
My right there is none to dispute."

The word "monarchy" has, however, outlived this original meaning, and is now used, at all, somewhat loosely of states ruled over by hereditary sovereigns, as distinct from republics with elected presidents; or for the "monarchical principle," as opposed to the republican, involved in this distinction.

The old idea of monarchy, viz. that of the prince as representing within the limits of his dominions the monarchy of God over all things, culminated in the 17th century in the doctrine of the divine right of kings, and was defined in the famous dictum of Louis XIV.: *L'état c'est moi!* The conception of monarchy was derived through Christianity from the theocracies of the East; it was the underlying principle of the mediæval empire and also of the mediæval papacy, the rule of the popes during the period of its greatest development being sometimes called "the papal monarchy." The monarchial principle was shaken to its foundations by the English revolution of 1688; it was shattered by the French revolution of 1789; and though it survives as a political force, more or less strongly, in most European countries, "monarchists," in the strict sense of the word, are everywhere a small and dwindling minority. To express the change phrases were invented which have come into general use, though involving a certain contradiction in terms, viz. "limited" or

"constitutional monarchy," as opposed to "absolute" or "autocratic monarchy."

Finally, a distinction is drawn between "elective" and "hereditary" monarchies. Of the former class the most conspicuous was the Holy Roman Empire; but in Europe all monarchies were, within certain limits, originally elective; and, after the introduction of Christianity, the essential condition of the assumption of sovereign power was not so much kinship with the reigning family as the "sacring" by the divine authority of the Church. The purely hereditary principle was of comparatively late growth, the outcome of obvious convenience, exalted under the influence of various forces into a religious or quasi-religious dogma. (See also GOVERNMENT AND SOVEREIGNTY.)

MONASSIR (MONASSIR), an African tribe of Semitic stock, living in the Nile valley (Berber mudiria) between Birti (their headquarters) and Dar Robatba. They are a prosperous, sedentary tribe, claim kinship with the Ababda, and speak Arabic, but are of very mixed blood. Next to Birti their chief settlement is at Salamat. Both places are on the left bank of the Nile. It was by Monassir tribesmen that Colonel J. D. H. Stewart, Gordon's comrade at Khartum, was murdered in 1884.

MONASTICISM (Gr. *μοναστικός*, living alone, *μόνος*), a system of living which owes its origin to those tendencies of the human soul which are summed up in the terms "asceticism" and "mysticism." Mysticism may broadly be described as the effort to give effect to the craving for a union of the soul with the Deity already in this life; and asceticism as the effort to give effect to the hankering after an ever-progressive purification of the soul and an atoning for sin by renunciation and self-denial in things lawful. These two tendencies may well be said to be general instincts of humanity; because, though not always called into activity, they are always liable to be evoked, and in all ages and among all races they frequently have asserted themselves. (See ASCETICISM and MYSTICISM.) Indeed the history of religion shows that they are among the most deep-rooted and widespread instincts of the human soul; and monasticism is the attempt to develop and regulate their exercise. Thus monasticism is not a creation of Christianity; it is much older, and before the Christian era a highly organized monasticism existed in India. (See the articles on BRAHMANISM; BUDDHISM; and LHASA.)

1. *Pre-Christian Monasticism*.—Greek asceticism and mysticism seem never to have produced a monastic system; but among the Jews, both in Judaea and in Alexandria, this development took place. In Judaea the Essenes before the time of Christ lived a fully organized monastic life (see Schürer, *Jewish People*, ii. § 30); and the same is true in regard to the Therapeutae in the neighbourhood of Alexandria (the authenticity of Philo's *De Vita contemplativa*, which describes their manner of life, is again recognized by scholars).

A general sketch of pre-Christian asceticism and monasticism, with indication of the chief authorities, is given in O. Zöckler's *Askese und Mönchtum* (1897), pp. 32-135. This account is epitomized by J. O. Hannay, *Spirit and Origin of Christian Monasticism* (1903), app. i: the view now common among scholars is there maintained, that these pre-Christian realizations of the monastic idea had little, and indeed no, influence on the rise and development of Christian monasticism.

2. *Beginnings of Christian Monasticism*.—The practice of asceticism asserted itself at an early date in Christian life: men and women abstained from marriage, from flesh meat, from the use of intoxicating drink, and devoted themselves to prayer, religious exercises and works of charity (S. Schwietz, *Das morgenländische Mönchtum*, 1904, pt. i.; J. O. Hannay, *op. cit.* chs. 2, 3). They did this in their homes, without withdrawing from their families or vocations. In time, however, the tendency to withdraw from society and give oneself up wholly to the practice of religious and ascetical exercises set in; and at any rate in Egypt, at the middle of the 3rd century, it was the custom for such ascetics to live in solitary retirement in the neighbourhood of the towns and villages. This was the manner of life

which St Anthony (q.v.) began to lead, c. 270; but after fifteen years he withdrew to a deserted fort on the east bank of the Nile, opposite the Fayum. Here he enclosed himself and led a life cut off from all intercourse with man. There are reasons for doubting that Anthony was the first Christian hermit: probably there is some historical foundation for the tradition that one of those who fled to the desert in the Decian persecution continued to dwell in a cave by the shore of the Red Sea, unknown to men, till visited by St Anthony long years afterwards (see E. C. Butler, *Lausiac History of Palladius*, 1898, pt. i. p. 230). But this was a single case which does not affect the fixed tradition of monastic Egypt in the 4th century that Anthony was the father of Christian monasticism.

During twenty years Anthony lived a life of seclusion, never coming forth from his fort, never seeing the face of man. But his fame went abroad and a number of would-be disciples came and took up their abode in the caves and among the rocks that surrounded his retreat, and called on him to guide them in the path of life they had chosen. In response to these appeals Anthony came forth and set himself to organize the life of the multitude of ascetics that had grown up around him. This act, which took place in the first years of the 4th century, must be regarded as the inauguration of Christian monasticism.

3. *St Anthony's Monachism*.—The form of monastic life directly derived from St Anthony was the type that prevailed in middle and northern Egypt up to the middle of the 5th century. The chief authorities for the study of this type of monastic life are the *Vita Antonii* (probably by Athanasius), the *Historia monachorum* (ed. E. Preuschen), the *Historia lausiacae* of Palladius (ed. E. C. Butler)—these works are to be found in Latin in Rosweyde's *Vitae Patrum* (*Migne, Patrol. Lat.* LXXXIII., LXXXIV.)—and the writings of Cassian (English translation by Gibson in "Nicene and Post-Nicene Library"). A generation ago all this literature was in disrepute; but it has been revindicated, and its substantially historical character is now recognized on all hands (see E. C. Butler, *op. cit.* pt. ii. § 1).

Antonian monachism grew out of the purely eremitical life, and it retained many of the characteristic features inherited from its origin. The party of travellers whose journey in 394 is narrated in the *Historia monachorum* found at the chief towns along the Nile from Lycopolis (Assiut or Siut) to Alexandria, and in the deserts that fringed the river, monastic habitations, sometimes of hermits, sometimes of several monks living together but rather the life of hermits than of cenobites. It is at the great monastic settlements of Nitria and Scete that we are best able to study this kind of Egyptian monasticism. Here in one portion of the desert, named Cellia, the monks lived a purely eremitical life; but in Nitria (the Wadi Natron) they lived either alone, or two or three together, or in communities, as they preferred. The system was largely voluntary; there was no organized community life, no living according to rule, as it is now understood. In short the life continued to be semi-eremitical. (See Butler, *op. cit.* pt. i. p. 233; Hannay, *op. cit.* chs. 4, 5; Schwietz, *op. cit.* pt. ii. §§ 1-11.)

4. *St Pachomius's Monachism*.—Very different was the type of monastic life that prevailed in the more southerly parts of Egypt. Here, at Tabennis near Dendera, about 315-320, St Pachomius (q.v.) established the first Christian cenobium, or monastery properly so called. (On St Pachomius and his monastic institute see P. Ladeuze, *Cénobisme Pachomien* (1898); Schwietz, *op. cit.* pt. ii. §§ 12-16; E. C. Butler, *op. cit.* pt. i. p. 234, pt. ii. notes 48, 49, 54, 59). Before his death in 346 Pachomius had established nine monasteries of men and one of women, and after his death other foundations continued to be made in all parts of Egypt, but especially in the south, and in Abyssinia. Palladius tells us that c. 410 the Pachomian or Tabennesis monks numbered some seven thousand. The life was fully cenobitical, regulated in all details by minute rules, and with prayer and meals in common. As contrasted with the Antonian ideal, the special feature was the highly organized system of work, whereby the monastery was a sort of agricultural and industrial colony. The work was an integral part

of the life, and was undertaken for its own sake and not merely for an occupation, as among the Antonian monks. This marks a distinctly new departure in the monastic ideal.

In another respect too St Pachomius broke new ground: not only did he inaugurate Christian cenobitical life, but he also created the first "Religious Order." The abbot of the head monastery was the superior-general of the whole institute; he nominated the superiors of the other monasteries; he was visitor and held periodical visitations at all of them; he exercised universal supervision, control and authority; and every year a general chapter was held at the head house. This is a curious anticipation of the highly organized and centralized forms of government in religious orders, not met with again till Cluny, Cîteaux, and the Mendicant orders in the later middle ages.

A passing reference should be made to the Coptic abbot Shenout, who governed on similar lines the great "White Monastery," whereof the ruins still survive near Akhmim; the main interest of Shenout's institute lies in the fact that it continued purely Coptic, without any infiltration of Greek ideas or influence. (See J. Leipoldt, *Schenute von Atripe*, 1903.)

Egyptian monachism began to wane towards the end of the 5th century, and since the Mahomedan occupation it has ever been declining. Accounts of its present condition may be found in R. Curzon's *Monasteries of the Levant* (1837), or in A. J. Butler's *Ancient Coptic Churches* (1884). Hardly half a dozen monasteries survive, inhabited by small and ever dwindling communities.

5. *Oriental Monachism*.—The monastic institute was imported early in the 4th century from Egypt into Syria and the Oriental lands. Here it had a great vogue, and under the influence of the innate Asiatic love of asceticism it tended to assume the form of strange austerities, of a kind not found in Egyptian monachism in its best period. The most celebrated was the life of the Stylites or pillar hermits (see SIMONE STYLITES). Monastic life here tended to revert to the eremitical form, and to this day Syrian and Armenian monks are to be found dwelling in caverns and desert places, and given up wholly to the practice of austerity and contemplation (see E. C. Butler, *Lousiac History of Palladius*, pt. 1. p. 239, where the chief authorities are indicated). Before the close of the 4th century monachism spread into Persia, Babylonia and Arabia.

6. *Basilian and Greek Monachism*.—Though Eustathius of Sebaste was the first to introduce the monastic life within the confines of what may be called Greek Christianity in Asia Minor (c. 340), it was St Basil who adapted it to Greek and European ideas and needs. His monastic legislation is explained and the history of his institute sketched in the article BASILIAN MONKS. Here it will suffice to say that he followed the Pachomian rather than the Antonian model, setting himself definitely against the practice of the eremitical life and of excessive asceticism, and inculcating the necessity and superiority of labour. The lines laid down by St Basil have continued ever since to be the lines in which Greek and Slavonic monasticism has rested, the new multitudinous modifications of the monastic ideal, developed in such abundance in the Latin Church, having no counterpart in the Greek. But the element of work has decreased, and Greek and Slavonic monks give themselves up for the most part to devotional contemplation.

7. *Early Western Monachism*.—The knowledge of the monastic life was carried to western Europe by St Athanasius, who in 340 went to Rome accompanied by two monks. The *Vita Antonii* was at an early date translated into Latin and propagated in the West, and the practice of monastic asceticism after the Egyptian model became common in Rome and throughout Italy, and before long spread to Gaul and to northern Africa. A résumé of the chief facts will be found in E. C. Butler, *op. cit.* pt. i. p. 245; see also Hannay, *op. cit.* ch. 7. The monastic ideals prevalent were those of the Antonian monachism, with its hankering after the eremitical life and the practice of extreme bodily austerities. But climatic conditions and racial temperament rendered the Oriental manner of monasticism unattainable, as a rule, in the West. Hence it came to pass that by the end of

the 5th century the monastic institute in western Europe, and especially in Italy, was in a disorganized condition, sinking under the weight of traditions inherited from the East. It was St Benedict who effected a permanently working adaptation of the monastic ideal and life to the requirements and conditions of the western races.

8. *St Benedict's Monachism*.—St Benedict (c. 500) effected his purpose by a twofold break with the past: he eliminated from the idea of the monastic life the element of Oriental asceticism and extreme bodily austerity; and he put down the tendency, so marked in Egypt and the East, for the monks to vie with one another in ascetical practices, commanding all to live according to the rule. The life was to be self-denying and hard, but not one of any great austerity (for details see BENEDICT OF NURSIA; and E. C. Butler, *op. cit.* pt. i. pp. 237 and 251). The individual monk was sunk in the community, whose corporate life he had to live. St Benedict's rule was a new creation in monastic history; and as it rapidly supplanted all other monastic rules in western Europe, and was for several centuries the only form of monasticism in Latin Christianity (outside of Ireland), it is necessary to speak in some little detail of its spirit and inner character.¹ It has to be emphasized at the outset that the monasteries in which the Benedictine rule was the basis of the life did not form a body or group apart within the great "monastic order," which embraced all monasteries of whatever rule; nor had Benedictine monks any special work or office beyond that common to all monks—viz. the sanctifying of their souls by living a community life in accordance with the Gospel counsels. St Benedict defines his monastery as "a school of the service of the lord" (*Reg., Prolog.*). The great act of service is the public common celebration of the canonical office, the "work of God" he calls it, to which "nothing is to be preferred" (*Reg.* c. 43). The rest of the day is filled up with a round of work and reading. Work, and in St Benedict's time it was predominantly field work, took an even more recognized and integral place in the life than was the case under St Pachomius or St Basil, occupying notably more time than the church services. St Benedict introduced too into the monastic life the idea of law and order, of rule binding on the abbot no less than on the monks; thus he reduced almost to a vanishing point the element of arbitrariness, or mere dependence on the abbot's will and whim, found in the earlier rules. Lastly, he introduced the idea of stability, whereby monk and community were bound to each other for life, the normal thing for the Benedictine being to live and die in the monastery of his profession: thus the power hitherto enjoyed by monks, of wandering from monastery to monastery, was cut away, and the Benedictine community was made into a family whose members were bound to one another by bonds that could not be severed at will.

9. *Western Monachism in the Early Middle Ages*.—It is easy to understand that a form of monastic life thus emptied of distinctively Oriental features and adapted to the needs of the West by a great religious genius like St Benedict, should soon have distanced all competitors and have become the only monastic rule in western Europe. The steps in the propagation of the Benedictine rule are traced in the article BENEDICTINES. The only serious rival was the Irish rule of Columban; and here it will be in place to say a word on Irish monachism, which, in its birthplace, stood aloof to the end from the general movement. The beginnings of Celtic monachism are obscure, but it seems to have been closely connected with the tribal system.² When, however, Irish monachism emerges into the full light of history, it was in its manifestations closely akin to the Egyptian, or even to the Syrian type: there was the same love of the eremitical life, the same craving after bodily austerities of an extraordinary kind, the same individualistic piety. The Irish monks were great missionaries in the north of England and the northern and

¹ This topic is dealt with by F. A. Gasquet, *Sketch of Monastic Constitutional History* (pp. viii.—xiii.), the Introduction to 2nd edition of the translation of Montalembert's *Monks of the West* (1895).

² See Willis Bund, *Celtic Church in Wales* (1897); H. Zimmer, art. "Keltische Kirche" in Herzog-Hauck, *Realencyklopädie* (3rd ed.), translated into English by Kuno Meyer (1902).

central parts of Europe, and in the course of the 7th century the Irish rule of St Columban and the Roman rule of St Benedict met in the monasteries in central Europe that had been founded by Columban and his Irish monks. The Benedictine rule supplanted the Irish so inevitably that the personnel ceased to be Irish, that even in St Columban's own monastery of Luxeuil his rule was no longer observed, and by Charlemagne's time all remembrance of any other monastic rule than the Benedictine had died out.

During the 7th and 8th centuries the Benedictine houses were the chief instrument in the christianizing, civilizing and educating of the Teutonic races. In spite of the frequent pillage and destruction of monasteries by Northmen, Saracens, Arabs and other invaders; in spite of the existence of even widespread local abuses, St Benedict's institute went on progressing and consolidating; and on the whole it may be said that throughout the early middle ages the general run of Benedictine houses continued to perform with substantial fidelity the religious and social functions for which they were created.

10. *Offshoots and Modifications of Benedictine Monachism: the Rise of "Orders."*—Up to the beginning of the 10th century we do not meet in the West such a thing as an "order"—an organized corporate body composed of several houses, diffused through various lands, with centralized government and objects and methods of its own. As stated above, St Pachomius's monasteries formed an order—a curious anticipation of what six centuries later was to become the vogue in Western monasticism. The Benedictine houses never coalesced in this manner; even when, later on, a system of national congregations was introduced, they were but loose federations of autonomous abbeys; so that to this day, though the convenient expression "Benedictine order" is frequently used, the Benedictines do not form an order in the proper sense of the word. But with the 10th century we reach the period of orders, and it is on this line that all subsequent developments in Western monasticism have run.

The first order was that of Cluny, founded in 910; in rule and manner of life it continued purely Benedictine, and it wielded extraordinary power and religious influence up to the middle of the 12th century. (See CLUNY.)

The chief offshoot from the Benedictine institute were the Cistercians (c. 100); their ground idea was a return to the letter of St Benedict's rule, and a reproduction, as close as could be, of the exterior conditions of life as they existed in St Benedict's own monastery; consequently field work held a prominent place in the Cistercian ideal. This ideal it has not been possible permanently to maintain in the great body of the order, but only in limited circles, as Trappists (q.v.). But for a century (1125–1225) Cîteaux supplanted Cluny as the spiritual centre of western Europe. The Cistercians were an organized, centralized order in the full sense of the word. (See CISTERCIANS.)

Towards the end of the 10th century and during the 11th a strong tendency set in to revert to the eremitical life, probably owing to the example of the Greek monks, who at this time entered Sicily and south Italy in great numbers. This tendency produced the orders of the Camaldulians or Camaldolese (c. 975) in Italy, and in France the Grandmontines (1076) and Carthusians (1084), all leading practically eremitical lives, and assembling ordinarily only for the church services. The Vallombrosians (1038) near Florence maintained a cenobitical life, but eliminated every element of Benedictine life that was not devoted to pure contemplation. At Fontevault (founded in 1095) the special feature was the system of "double monasteries" i.e. neighbouring, but rigorously separated, monasteries of men and of women—the government being in the hands of the abbesses.

In all these lesser orders may be discerned the tendency of a return to the elements of Eastern monasticism discarded by St Benedict—to the eremitical life; to the purely contemplative life with little or no factor of work; to the undertaking of rigorous bodily austerities and penances—it was at this time that the practice of self-inflicted scourgings as a penitential exercise was

introduced. All this was a reaction from St Benedict's reconstruction of the monastic life—a reaction which in the matter of austerities and individualistic piety has made itself increasingly felt in the later manifestations of the monastic ideal in the West.

11. *New Kinds of Religious Orders.*—Up to this point we have met only with monasticism proper; and if the term were taken strictly, the remainder of this article would be concerned only with the later history of the institutes already spoken of; for neither canons regular, friars, nor regular clerks, are in the strict sense monks. But it is usual, and it will be convenient here, to use the term monasticism in a broader sense, as equivalent to the technical "religious life," and as embracing the various forms that have come into being so prolifically in the Latin Church at all periods since the middle of the 11th century.

The first of these new forms was that of the canons regular or Augustinian canons (q.v.) who about the year 1060 arose out of the older semi-monastic canonical institute, and lived according to the so-called "Rule of St Augustine." The essential difference between monks and regular canons may be explained as follows: monks, whether hermits or cenobites, are men who live a certain kind of life for its own sake, for the purpose of leading a Christian life according to the Gospel's counsel and thus serving God and saving their own souls; external works, either temporal or spiritual, are accidental; clericalism or ordination is an addition, an accession, and no part of their object, and, as a matter of fact, till well on in the middle ages it was not usual for monks to be priests; in a word, the life they lead is their object, and they do not adopt it in order the better to compass some other end. But canons regular were in virtue of their origin essentially clerics, and their common life, monastery, rule, and the rest, were something additional grafted on to their proper clerical state. The difference manifested itself in one external point: Augustinian canons frequently and freely themselves served the parish churches in the patronage of their houses; Benedictine monks did so, speaking broadly, hardly at all, and their doing so was forbidden by law, both ecclesiastical and civil. In other respects the life of canons regular in their monasteries, and the external policy and organization among their houses, differed little from what prevailed among the Black Benedictines; their superiors were usually provosts or priors, but sometimes abbots. As contrasted with the friars they are counted among the monastic orders. Alongside of the local federations or congregations of houses of Augustinian canons were formed the Premonstratensian order (1120) (q.v.), and the English "double order" of St Gilbert of Sempringham (1148) (q.v.), both orders, in the full sense of the word, composed of Augustinian canons.

Two special kinds of orders arose out of the religious wars waged by Christendom against the Mahomedans in the Holy Land and in Spain: (1) the Military orders: the Knights Hospitallers of St John and the Knights Templars, both at the beginning of the 12th century, and the Teutonic Knights at its close; (2) the orders of Ransom, whose object was to free Christian prisoners and slaves from captivity under the Mahomedans, the members being bound by vow even to offer themselves in exchange; such orders were the Trinitarians (q.v.) founded in 1198, and the order of Our Lady of Ransom (de Mercede), founded by St Peter Nolasco in 1223; both were under the Augustinian rule.

At the beginning of the 13th century arose the series of great Mendicant orders. Their nature and work and the needs that called them into being are explained in the article MENDICANT MOVEMENT, and in the separate articles on ST FRANCIS OF ASSISI and FRANCISCANS (1210), ST DOMINIC and DOMINICANS (1215), CARMELITES (1245), AUGUSTINIAN HERMITS (1256)—these were the four great orders of Mendicant friars—to them were added, in 1487, the Servites (q.v.) founded in 1233.

It will be in place here to explain the difference between friars, monks, and canons regular. The distinction between the two last has already been brought out; but they agree in this that the individual monk and canon alike belongs to his house of profession and not to any greater or wider corporation. They

are bound by place and the unit is the individual community. Thus among monks and canons regular each monastery has its own fixed community, which is in a real sense a family; and the monk or canon, no matter where he may be, looks on his monastery as his "home," like the ancestral home of a great family. With the friars this is all changed: the friar does not belong to any particular house, but to the province or order, so that there is no reason, beyond the command of his superiors, why he should be living in one house rather than another. In the monk attachment to his own one monastery is a virtue; in the friar detachment is the ideal. The monk, or the canon, normally exercises his influence on the world in and through his community, not as an individual but as a member of a corporate body. The friar's sphere of work is normally outside his convent, and he works and influences directly and as an individual. Lastly, in regard to the object aimed at there was an important difference, for the professed object of the friars was to be clerical helpers of the parochial clergy in meeting the specifically religious needs of the time. Already, in St Francis's lifetime, his friars had grown into an order dedicated to spiritual ministrations among the poor, the sick, the ignorant, the outcasts of the great cities; while by the very conception of their institute the Dominicans were dedicated to the special work of preaching, especially to heretics and heathens. Here, too, should be mentioned St Francis's other great creation, the Tertiaries (*q.v.*), or devout men and women living in the world, who while continuing their family life and their ordinary avocations, followed a certain rule of life, giving themselves up to more than ordinary prayer and the pursuit of good works, and abstaining from amusements of a worldly kind.

12. *The Religious Orders in the Later Middle Ages.*—The 13th century was the heyday of monasticism in the West; the Mendicant orders were in their first fervour and enthusiasm; the great abbots of Benedictines, Cistercians and Augustinian canons reflected the results of the religious reform and revival associated with Hildebrand's name, and maintained themselves at a high and dignified level in things religious and secular; and under the Benedictine rule were formed the new congregations or orders of Silvestrines (1231), Celestines (*c.* 1260) and Olivetans (1310), which are described under their several headings. But towards the end of the century a period of decline set in, which ran its course in increasing volume throughout the 14th century. A great wave of secularity rolled over the Church, engulfing the religious orders with the rest; love waxed cold, fervour languished, learning declined, discipline was relaxed, bitter rivalries broke out, especially between Franciscans and Dominicans. The great schism was reflected in the Mendicant orders which were divided into two obediences, to the destruction of discipline. The great wealth of the old monastic orders exposed them, especially in France and Italy, to the vicious system of commendation, whereby a bishop, an ecclesiastic, or even a layman was appointed "commendatory abbot" of a monastery, merely for the purpose of drawing the revenues (see *ABBOT*); the monasteries were often deprived even of necessary maintenance, the communities dwindled, and regular observance became impossible. There is reason to believe that in England a relatively good level was maintained throughout, thanks in great measure to the fact that the kings resolutely refused to allow the introduction of commendation—Wolsey was the first and last commendatory abbot in England. In the German lands, the lowest level was touched, and the writings of the Augustinian canon Johann Busch, and of the Benedictine abbot Trithemius reveal a state of things in the first half of the 15th century that urgently called for reform. The first move in this direction was made in the Netherlands and north Germany under the influence of Gerhard Groot (*q.v.*), and issued in the formation of the Windesheim congregation of Augustinian canons and the secular congregation of Brothers of Common Life (*q.v.*) founded *c.* 1384, both of which became centres of religious revival. During the first half of the 15th century numerous and effective efforts at reform were initiated in all the orders without exception, and in every part of Europe. These

movements, promoted by the councils of Constance and Basel, partook of the spirit of the time and were characterized by an extreme austerity of life and a certain hardness of spirit, and a sort of police regulation easily understandable at a time of reaction from grave abuses. At this time arose the Hieronymites (*q.v.*) founded in 1375, under the Augustinian rule, the Observants (1415) among the Franciscans (*q.v.*), and the Minims (founded *c.* 1460 by St Francis of Paola, *q.v.*), whose programme was to outdo the Minors or Franciscans. These various reform movements among the orders were widely but not universally successful; and so the Reformation found religious houses in an unsatisfactory state in sufficient numbers to afford the reformers one of their chief handles against the old religion. The Reformation and the religious wars that followed in its wake destroyed the monasteries and religious orders of all kinds in northern Europe and crippled them in central Europe.

13. *The Modern Orders.*—During the Reformation period there sprang up, to meet the needs of the time, a new kind of religious order, called Regular Clerks. These are religious orders in the full sense of the word, as the members take the solemn religious vows. Regular clerks are by their institute clerics and priests, and they are devoted to some particular work or works as their own special object—as education, the preaching of missions and retreats, or the going on missions to the heathen. They carry still further the tendencies that differentiate the friars from the monks; and in particular, in order to be more free in devoting themselves to their special works, the orders of regular clerks have commonly given up the choral celebration of the canonical office, which had been maintained by the friars.

Of regular clerks by far the most important are the Jesuits (*q.v.*), founded in 1540; there are also the Theatines (founded 1524 by St Cajetan and Caraffa, afterwards Paul IV.); the Barnabites (founded 1530, by St Antonio Zaccaria) and others (see Max Heimbucher, *Orden u. Kongregationen* (1897), II., §§ 108-114). Strictly speaking the "religious congregations" should be distinguished from the orders of regular clerks, the difference being that in the former the vows, though taken for life, are only "simple vows" and more easily dispensable by authority; but the character and work of the two institutes is very similar. The chief of these congregations are the Passionists (founded by St John of the Cross, 1725) and the Redemptorists (founded by St Alphonsus Liguori, 1749), both dedicated to giving missions and retreats. The Christian Brothers, devoted to primary education, founded by St Jean Baptiste de la Salle in 1679, are not in orders (Heimbucher, *op. cit.* §§ 115-118).

Besides the religious congregations there are a number of "secular congregations," composed of secular priests living together under temporary vows and free to leave at will; the following deserve mention: Oblates of St Charles (founded by St Charles Borromeo, 1578); Oratorians (founded by St Philip Neri, *c.* 1570); the French Oratory (founded by Cardinal Berulle, 1613), a similar but distinct institution, which produced a number of scholars of the highest distinction—Thomassin, Morin, Marlebranche, Richard Simon, Juéna, Lebrun, Masillon, and others; Lazarists (founded by St Vincent de Paul, 1624); Sulpicians (founded by M. Olier, 1642), and a vast number of others, including several for the mission to the heathen (see Heimbucher *op. cit.* §§ 124-140).

During the period under review, from the Reformation to the French Revolution, the old orders went on alongside of the new, and many notable revivals and congregations arose among them: the most noteworthy were the Capuchins (*q.v.*) among the Franciscans (1528); the Discalced Carmelites (*q.v.*) of St Teresa and St John of the Cross (1562); the Trappists (*q.v.*) among the Cistercians (1663); and, most famous of all, the Maurists (*q.v.*) among the Benedictines of France (1621).

14. *The Religious Orders in Recent Times.*—At the end of the 18th century and the opening of the 19th the religious orders received a succession of blows in those countries in which they had survived the Reformation from which they have only

in the present generation recovered. The Jesuits were suppressed by Pope Clement XIV. in 1773, and restored by Pius VII. in 1814. As the result of the ecclesiastical policy of the emperor Joseph II. nearly all religious houses of all kinds were suppressed throughout the Austrian dominions (1780). The French Revolution swept them out of France and caused the secularization of the great majority in central Europe and Italy. In Portugal and Spain they were dissolved in 1834-1835; in Italy in 1866; in the Prussian dominions in 1871. The last half of the 19th century, and more especially the last quarter, witnessed a remarkable revival of vitality and growth in most of the older orders in nearly every country of western Europe, and besides, an extraordinary number of new congregations, devoted to works of every sort, were founded in the 19th century: Heimbucher (*op. cit.*, §§ 118, 134-140) numbers no fewer than seventy of these new congregations of men. In the new countries, especially in the United States and Australia, but also in South Africa, orders and congregations of all kinds are most thriving. The chief set-back has come again in France, where, by the Association Laws of 1903, the religious orders have nearly all been suppressed and expelled and their property confiscated.

15. *The Nuns.*—In the foregoing sketch nothing has been said concerning the nuns; and yet in all ages women, hardly less than men, have played their part in monasticism. In the earliest Christian times the veiled virgins formed a grade or order apart, more formally separated from the community than were the male ascetics. There is reason for believing that there were organized convents for women before there were any for men; for when St Anthony left the world in 270 to embrace the ascetic life, the *Vita* says he placed his sister in a nunnery (*αββαίον*). We learn from Palladius that by the end of the 4th century nunneries were numerous all over Egypt, and they existed also in Palestine, in Italy and in Africa—in fact throughout the Christian world. It is a curious coincidence that the sister of each of the three great cenobitical founders, Pachomius, Basil and Benedict, was a nun and ruled a community of nuns according to an adaptation of her brother's rule for monks. In the West the Benedictine nuns played a great part in the Christian settlement of north-western Europe. As the various monastic and mendicant orders arose, a female branch was in most cases formed alongside of the order; and so we find canons, and hermits, and Dominicans, and Franciscan nuns [or Clares (*q.v.*)—requisite information will be found in the respective articles. Then there were the "double orders" of Sempringham (see ST GILBERT) and Fontevrault, in which the nuns were the predominant, or even the dominant, element. Of the modern orders of men only a few include nuns. But on the other there are a vast number of purely female orders and congregations. The great majority of these modern congregations of women follow the Augustinian rule, supplemented by special constitutions or by-laws; such are the Brigittines, the Ursulines and the Visitation nuns: others follow the rule of the third order of the Franciscans or other Mendicants (see TERTIARIES). In early times nuns could go out of their enclosure on occasion; but in the later middle ages, up to the council of Trent, the tendency was to keep them more and more strictly confined within their convent precincts. In 1609 an English lady, Mary Ward, founded at Munich the "Institute of Mary," the nuns of which were not bound to enclosure. This new departure, or rather, return to old ideas, encountered vehement opposition and difficulties that nearly wrecked it; but it has survived, and has been the pioneer in the extraordinary development of institutes of women devoted to external good works of every kind. St Vincent of Paul soon followed; in 1633 he established the Sisters of Charity, bound only by yearly vows, and wholly given up to works of charity—chiefly nursing in hospitals and in the homes of the poor, and primary education in poor schools.

As women are debarred from exercising the spiritual functions of the ministry, it follows that nuns have to devote themselves either to a more purely contemplative life, or else to a more wholly active one, than is usual among the orders of men, who commonly, in virtue of their priesthood, have been able to find a mixed form

of life between the two extremes. The nuns belonging to the older orders tend to the contemplative idea, and they still find recruits in sufficient numbers, in spite of the modern rush to the active congregations. These latter exist in wondrous number and variety, exercising every imaginable form of good work—education, both primary and secondary; the care of hospitals, orphanages, penitentiaries, prisons; of asylums for the blind, the deaf and dumb, the insane; of refuges for the aged poor and the destitute.

See the works of Helyot and Heimbucher, referred to below under "Literature"; also Lina Eckenstein, *Woman under Monasticism* (1896); and for information on the various orders of women, J. N. Murphy, *Terra incognita* (1873); and F. M. Steele, *Convents of Great Britain and Ireland* (1902).

16. *Conclusion.*—Few phenomena are more striking than the change that has come over educated Protestant opinion in its estimate of monasticism. The older Protestantism uncompromisingly judged the monastic ideal and life to be both unchristian and unnatural, an absolute perversion deserving nothing but condemnation. But now the view of the critico-historical school of Protestant thought, of which Dr Adolf Harnack is so representative a spokesman, is that the preservation of spiritual religion in Catholic Christianity, both Eastern and Western, has been mainly, if not wholly, due to monasticism (see Harnack's early tractate *Das Mönchtum*, translated under the title *Monasticism*, by E. E. Kellett, 1901; also the lectures on Greek and Roman Catholicism in *Das Wesen des Christentums*, translated by Bailey Saunders, 1902; the first-named work is the most suggestive general *aperçu* of the whole subject—though written from a frankly hostile standpoint, it is in large measure a panegyric).

The views of the new Protestantism concerning monasticism are probably no less excessive than those of the old. The truth probably lies somewhere between them. It may perhaps be agreed that not the least of the services rendered to the Christian people at large by monasticism is this: Into every life the spirit of renunciation must enter; in most lives there are crises in which the path of mere duty can be followed only in virtue of a great renunciation; if we are able to make these ordinary and necessary renunciations, it is in some measure owing to the fact that the path has been made easier for us by those who (like the author of the *Imitation of Christ*) have shown the example, and thereby been able to formulate the theory, of renunciation in a supreme degree.

LITERATURE.—The literature on monasticism is immense. The chief repository for information on the historical side is Helyot's *Histoire des ordres religieux* (8 vols., 1714; 2nd ed. 1792; digested in dictionary form by Migne, 1860). This information has been condensed and brought up to date by Max Heimbucher, *Orden und Kongregationen* (2 vols., 1896-1897; a 2nd ed. in 3 vols., 1907)—this most useful handbook is equipped throughout with an excellent and well chosen bibliography. Otto Zöckler's *Aeshse und Mönchtum* (1897), also covers the whole ground, and is written more from the point of view of theory. The inner spirit and working of the older monasticism is well portrayed in F. A. Gasquet's *English Monastic Life* (1904); more popular accounts are given in H. J. Feasby's *Monasticism* (1898), and F. M. Steele's *Monasteries and Religious Houses of Great Britain and Ireland* (1903). The rules of the various orders are collected in Brockie's edition of Holsten's *Codex regularum* (6 vols., 1759). The article *Mönchtum* in Herzog-Hauck *Realencyclopädie* (3rd ed.), and in Wetzer and Welte *Kirchenlexikon* (2nd ed.) go over the same general ground as the present article, in the earlier portion entering into greater detail as to facts, but in the later dealing much more summarily. The relevant separate articles in these two great dictionaries, Protestant and Catholic respectively, will supply adequate information and ample references on most points. The *Catholic Dictionary* contains useful articles on most of the subjects here touched on; and an extensive *Catholic Encyclopedia* is in course of preparation at the Catholic University of Washington. The habits and dress of the various orders may be seen in Helyot's *Histoire*, which abounds in plates, coloured, in the ed. of 1792. There are plates representing members of the chief orders in Dugdale's *Monasticism*, and in the books of Gasquet and Steele mentioned above; also (coloured) in Tucker and Malleson, *Handbook to Christian Rome*, pt. iii. (1900). (E. C. B.)

MONASTIR, or BITOLIA, the second city of Macedonia, and the capital of the vilayet of Monastir in European Turkey, on the Salonica-Monastir railway, 400 m. W. of Constantinople. Pop. (1905), about 60,000. Monastir is situated at an altitude

of 2010 ft. on the eastern versant of the richly wooded mountains which culminate in the Peristeri (8300 ft.) and sever Lake Prespa from the valley of the Kara-Su or Tzerna. A tributary of this river, the Dragor or Drahor, traverses Monastir through a rocky channel which is rarely filled except after a thaw or heavy rain. The city possesses many mosques, churches and schools, baths and a military hospital. It is the seat of numerous consulates, an American Protestant mission, and a Lazarist mission. The annual value of its trade is about £400,000. Grain, flour, cloth, hides and bones are exported, and a large amount of gold and silver ornaments is manufactured, though this industry tends to decline.

The military advantages of its position at the meeting-place of roads from Salonica, Durazzo, Uskub, and Adrianople led the Turks, about 1820, to make Monastir the headquarters of an army corps. Since then the general and commercial importance of the city has greatly increased, and in 1898 it was made the see of a Bulgarian bishop. The ancient diocese of its Greek archbishop is known as Pelagonia, from the old name of the Kara-Su Plain. Monastir itself has been identified with the ancient Heraclia Lyncestis on the Via Egnatia; its modern name is derived from the monastery of Bukova ("the beeches") near the southern outskirts of the city.

MONAZITE, a mineral consisting of anhydrous phosphate of the cerium metals (Ce, La, Di)PO₄, together with small and variable amounts of thorium (ThO₂, 1-10%) and yttrium. It is of considerable commercial importance as a source of thorium for the manufacture of the Welsbach and other mantles for incandescent gas-lighting: the cerium is used to a limited extent in pharmacy.

The following analyses are of monazite from: (I.) Burke county, North Carolina; (II.) Arendal, Norway; (III.) Emmaville, Gough county, New South Wales.

	I.	II.	III.
Phosphorus pentoxide (P ₂ O ₅)	29.28	27.55	25.09
Cerium oxide (Ce ₂ O ₃)	31.38	29.20	36.64
Lanthanum oxide (La ₂ O ₃)	} 30.88	} 26.26	} 30.21
Didymium oxide (Di ₂ O ₃)			
Yttrium oxide (Yt ₂ O ₃)	—	3.82	—
Thorium oxide (Th ₂ O ₃)	6.49	9.57	1.23
Silica (SiO ₂)	1.40	1.86	3.21
Alumina (Al ₂ O ₃)	—	—	3.11
Iron oxide (Fe ₂ O ₃)	—	1.13	—
Lime (CaO)	—	0.69	—
Water (H ₂ O)	0.20	0.52	—
	99.63	100.60	99.49
Specific gravity	5.10	5.15	5.001

Thorium and silica being often present in the molecular ratio 1 : 1, it has been suggested that they exist as thorite (ThSiO₄) as a mechanical impurity in the monazite.

Crystals of monazite belong to the monoclinic system, and are usually flattened parallel to the ortho-pinacoid (*a* in the figure).

The large (up to 5 in. in length) reddish-brown, dull and opaque crystals from Norway and the Urals are simple in form, whilst the small, translucent, honey-yellow crystals from the Alps are bounded by numerous bright faces. Crystals of the latter habit were described in 1823 from Dauphiné under the name *turnerite*, and owing to their rarity were not until many years afterwards analysed chemically and proved to be identical with monazite. Monazite from the Urals was described by A. Breithaupt in 1820, and named by him from Gr. *μονάζειν*, to be solitary, because of the rarity of the singly occurring crystals. The hardness is 5½, and the specific gravity 5.1-5.2. Light which has traversed a crystal or grain of monazite exhibits a characteristic absorption spectrum, and this affords a ready means of detecting the mineral.

As minute idiomorphic crystals monazite is of wide distribution in granites and gneisses, being present in very small amounts as an accessory constituent of these rocks. By powdering the rock and washing away the lighter minerals in a stream of water the heavy minerals (zircon, anatase, rutile, magnetite, garnet,

monazite, xenotime, &c.) may be collected. This separation has been effected naturally by the weathering and disintegration of the rocks and the accumulation of the heavier minerals in the beds of streams. Under these conditions monazite has been found as rounded water-worn grains in the alluvial gold-washings of the Urals, Finland, Siberia, the United States, Brazil, Colombia, New South Wales, &c., and in tin-gravels in Swaziland, South Africa. Larger crystals of monazite are found embedded in pegmatite veins in the Ilmen Mountains (southern Urals); at Arendal and other places in southern Norway, where it is collected in the feldspar quarries to the extent of about one ton per annum; and in the mica mines at Villeneuve in Quebec, where masses of monazite weighing 20 lb have been found. The small crystals of the "turnerite" habit could appear implanted, often with anatase and rutile, on the crystallized quartz and albite, which line crevices in the crystalline schists of the French, Swiss and Tirolese Alps; similar crystals with the same associations occur very exceptionally in the clay-slate at Tintagel in Cornwall. Microscopic crystals of monazite (cryptolite, from *κρυπτός*, concealed) have been observed embedded in the crystallized apatite of Arendal in Norway.

The deposits worked commercially are the monazite-bearing sands of North Carolina and Brazil, and to a smaller extent those of South Carolina. In North Carolina it occurs over a wide area in the streams rising in the South Mountains, an eastern outlier of the Blue Ridge. The rocks of the district are granitic biotite-gneiss and hornblende-gneiss, and are intersected by veins of auriferous quartz. The percentage of monazite in the river-gravels varies from very small amounts up to 1 or 2%. The heavy minerals contained in the gravels are collected in the same manner as in washing for gold (which is often also present); magnetite is separated with a magnet; but other minerals, such as zircon, rutile, garnet, corundum, &c., cannot be separated by mechanical means. The product is a fine-grained yellowish sand containing 65-85% of monazite and 3-9% of thorium. In Brazil it occurs in river-gravels and also in the sand on the sea-beaches; an extensive accumulation of very rich monazite sand occurs on the seashore near Alcobaca in Bahia, and this has been shipped as ballast in the natural state. See H. B. C. Nitze, "Monazite" (*10th Annual Report of the United States Geological Survey*, pt. iv. (1895), pp. 667-693). (L. J. S.)

MONBODDO, JAMES BURNETT, LORD (1714-1799), Scottish judge and anthropologist, was born in 1714 at Monboddo in Kincardineshire. He studied at Aberdeen, and, after passing his law examinations in Edinburgh, he quickly took a leading position at the Scottish bar, being made a Lord of Session in 1767 with the title of Lord Monboddo. Many of his eccentricities, both of conduct and opinion, appear less remarkable to us than they did to his contemporaries; moreover, he seems to have heightened the impression of them by his humorous sallies in their defence. He may have had other reasons than the practice of the ancients for dining late and performing his journeys on horseback instead of in a carriage. He is remembered more particularly for his writings on human origins. In his *Antient Metaphysics* (1779-1799), Monboddo conceived man as gradually elevating himself from an animal condition, in which his mind is immersed in matter, to a state in which mind acts independently of body. In his equally voluminous work, *The Origin and Progress of Language* (1773), he brought man under the same species as the orang-outang. He traced the gradual elevation of man to the social state, which he conceived as a natural process determined by "the necessities of human life." He looked on language (which is not "natural" to man in the sense of being necessary to his self-preservation) as a consequence of his social state. His views about the origin of society and language and the faculties by which man is distinguished from the brutes have many curious points of contact with Darwinism and neo-Kantianism. His idea of studying man as one of the animals, and of collecting facts about savage tribes to throw light on the problems of civilization, bring him into contact with the one, and his intimate knowledge of Greek philosophy with the other. In both respects Monboddo was far in advance of his neighbours. His studied abstinence from fine writing—from "the rhetorical and poetical style fashionable among writers of the present day"—on such subjects as he handled conferred the idea of his contemporaries that he was only an eccentric

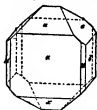

concocter of supremely absurd paradoxes. He died on the 26th of May 1799.

Boswell's *Life of Johnson* gives an account of the lexicographer's visit to Burnett at Monbodo, and is full of references to the natural contemporary view of a man who thought that the human race could be descended from monkeys.

MONCEY, BON ADRIEN JEANNOT DE, DUKE OF CONEGLIANO (1754-1842), marshal of France, was the son of a lawyer of Besançon, where he was born on the 31st of July 1754. In his boyhood he twice enlisted in the French army, but his father procured his discharge on both occasions. His desire was at last gratified in 1778, when he received a commission. He was a captain when, in 1791, he embraced the principles of the French Revolution. Moncey won great distinction in the campaigns of 1793 and 1794 on the Spanish frontier (see FRENCH REVOLUTIONARY WARS), rising from the command of a battalion to the command in chief of the Army of the Western Pyrénées in a few months, and his successful operations were largely instrumental in compelling the Spanish government to make peace. After this he was employed in the highest commands until 1799, when the government, suspecting him of Royalist views, dismissed him. But the *coup d'état* of 18. Brumaire brought him back to the active list, and in Napoleon's Italian campaign of 1800 he led a corps from Switzerland into Italy, surmounting all the difficulties of bringing horses and guns over the then formidable pass of St Gothard. In 1801 Napoleon made him inspector-general of gendarmerie, and on the assumption of the imperial title created him a marshal of France. In 1805 Moncey received the grand cordon of the legion of honour, and in 1808 the title of duke of Conegliano. In the latter year, the first of the Peninsular War, Moncey was sent to Spain in command of an army corps. He signaled himself by his victorious advance on Valencia, the effect of which was, however, destroyed by the disaster to Dupont at Baylen, and took a leading part in the emperor's campaign on the Ebro and in the second siege of Saragossa in 1809. He refused to serve in the invasion of Russia, and therefore had no share in the campaign of the *grande armée* in 1812 and 1813. When, however, France was invaded (1814) Marshal Moncey reappeared in the field and fought the last battle for Paris on the heights of Montmartre and at the barrier of Clichy. He remained neutral during the Hundred Days, feeling himself bound to Louis XVIII. by his engagements as a peer of France, but after Waterloo he was punished for refusing to take part in the court-martial on Ney by imprisonment and the loss of his marshalate. He was reinstated in 1816, and re-entered the chamber of peers three years later. His last active service was as commander of an army corps in the short war with Spain, 1823. In 1833 he became governor of the Invalides. He died on the 20th of April 1842.

MONCHIQUE, a town of southern Portugal, in the district of Faro (formerly the province of Algarve); 13 m. S. of Saboia station on the Lisbon-Faro railway, and 12 m. N. of Villa Nova on the Atlantic. Pop. (1900), 7345. Monchique is one of the principal Portuguese health-resorts, finely situated among the wooded heights of the Serra de Monchique, which rise on the west to 2965 ft. There are hot sulphur springs, with baths and a sanatorium 4 m. south. Wheat, millet, rye, beans, oranges, wine, olive oil and chestnuts are the chief products, and there is a woollen factory.

MONCTON, a city and port of entry in Westmoreland county, New Brunswick, Canada, 89 m. by rail N.E. of St John, at the head of navigation on the Petitcodiac river, the seat of the workshops and general offices of the Inter-Colonial railway and the eastern terminus of the new Grand Trunk Pacific railway. Pop. (1901), 9026. It has large stove factories, engine and boiler works, and is a flourishing manufacturing town. The workshops of the railway and great part of the town were swept away by fire in February 1906, but have been rebuilt on a larger and more modern scale.

MOND, LUDWIG (1839-1909), British chemist, was born at Cassel in Germany on the 7th of March 1839. After studying

at Marburg under Hermann Kolbe and at Heidelberg under Robert Bunsen, he came to England in 1862 and obtained a position in a chemical works at Widnes, where he elaborated the practical application of a method he had devised for recovering the sulphur lost as calcium sulphide in the black ash waste of the Leblanc alkali process. He became a naturalized British subject in 1867. In 1873 he entered into partnership with Sir John Tomlinson Brunner (b. 1842-), whom he had met when he was at Widnes, and thus founded the great chemical manufacturing firm of Brunner, Mond & Co. They began to make alkali by the ammonia-soda process, under licence from the Belgian chemist, Ernest Solvay, but at first the venture threatened to prove a failure. Gradually, however, the technical difficulties were overcome and success assured, largely as a result of improved methods worked out by Mond for the recovery of the ammonia. About 1879 he began experiments in the economical utilization of fuel, and his efforts led him to the system of making producer-gas, known by his name (see GAS: II. *For Fuel and Power*). Later, while attempting to utilize the gas for the production of electricity by means of a Grove gas battery, he noticed that the carbon monoxide contained in it combined with nickel. The resulting compound, nickel carbonyl, which was described to the Chemical Society in 1890, is both formed and decomposed within a very moderate range of temperature, and on this fact he based a successful process for the extraction of nickel from its ores. A liberal contributor to the purposes of scientific research, Mond founded in 1896 the Davy-Faraday Research Laboratory in connexion with the Royal Institution. On his death, which occurred in London on the 11th of December 1909, he bequeathed a large part of his collection of pictures to the nation.

MONDAY (in O.E. *Monandæg*, the moon's day, a translation of the Late Lat. *Lunae dies*, from which the French *lundi* is taken), the second day of the week (see CALENDAR). The day has been humorously canonized as St Monday, the festival of cobblers, who seldom work on Mondays, and were supposed not to know exactly on which day St Crispin's (their patron saint) festival fell, save that it should be a Monday, and thus celebrated each Monday in the year as a holiday so as to be certain to honour the day. In some parts of Yorkshire any holiday is called Cobblers' Monday. Collop Monday, in the north of England, is the Monday before Shrove Tuesday, so called in allusion to the dish of fried eggs and bacon, and slices of salted, dried meat, called collops, taken on that day preparatory to the Lenten fast. Plough Monday in England is the Monday after Twelfth Day, the first Monday after Epiphany, in allusion to the fact that in medieval times the ploughmen had their fête-day and went around the villages begging plough-money. The lord mayor of London holds a Grand Court of Wardmote at the Guildhall on Plough Monday of each year, to receive returns from the wards of the election of common councilmen and to hear petitions against such returns.

MONDOFÈDO, a city of northern Spain, in the province of Lugo, 27 m. N.N.E. of the city of Lugo, on the river Masma. Pop. (1900), 10,590. Mondofoedo occupies a sheltered valley among the northern outliers of the Cantabrian Mountains. The principal buildings are the cathedral, a Corinthian structure of the 17th century, an ex-convent of Franciscan friars of Alcantara, which is used for a theatre and a public school, and the civil hospital. The industries include lace-making, linen-weaving, and leather manufacture.

According to local tradition, the bishopric of Dumium, near Braga, was transferred to San Martin de Mondofoedo (10 m. from Mondofoedo) in the 8th century; it was brought to Mondofoedo itself in the beginning of the 12th century. After having been for nearly a century and a half in the hands of the Moors, Mondofoedo was recaptured by Ordoño I. in 858; and the Christian possession was made permanent by Alphonso III. in 870. It was taken by surprise by the French in 1809.

MONDOVI, a town and episcopal see of the province of Cuneo, Piedmont, Italy, 17 m. by rail E. of Cuneo. Pop. (1901), 5379 (town); 18,982 (commune). The lower town is 1283 ft.

above sea-level, the upper 1834 ft. There is a school of the industrial arts and handicrafts, and majolica, paper, and silk cocoons are produced. The upper town contains the hexagonal piazza, a citadel, erected in 1573 by Emanuel Philibert, the cathedral of S. Donatus, a spacious episcopal palace, and higher up is a tower, the Belvedere, with a fine view. At the foot of the hill along the banks of the Ellero (a tributary of the Po) lie the industrial and commercial suburbs of Breo, Borgatto, Pian della Valle and Carassone, with their potteries, tanneries, paper-mills, marble-works, &c. The mansion of Count San Quintino in Pian della Valle was the seat of the printing-press which from 1472 issued books with the imprint Mons Regalis.

Mondovì—Mons Vici, Mons Regalis, Montregale—did not take its rise till about A.D. 1000. The bishopric dates from 1388. About 2 m. to the east is the sanctuary of Vico, a church designed by Ascanio Vittozzi in 1596 and crowned by a famous dome (1730-1748), which has been declared a national monument. In the square before it is a monument (1891) to Charles Emmanuel I. of Savoy.

See L. Melano Rossi, *The Sanctuario of the Madonna di Vico* (London, 1907).

MONET, CLAUDE (1840-), French painter, was born in Paris on the 14th of November 1840. His youth was passed at Hâvre, where his father had settled in 1845. Until he was fifteen years old he led a somewhat irregular life, learning little at school, and spending all his time in decorating his books with drawings and caricatures which gave him notoriety in Hâvre. At the same time he became acquainted with Boudin, a clever sea-painter, under whose guidance he learned to love and to understand nature. At the age of twenty he became a soldier, and spent two years of his military time with the regiment of the Chasseurs d'Afrique in the desert. Falling ill with fever, he was sent home, and entered the studio of Gleyre. This classical painter tried in vain to keep him to conventional art and away from truth and nature, and Monet left his studio, where he had become acquainted with two other "impressionistic" painters—Sisley and Renoir. At that time he also knew Manet (*q.v.*), and in 1866 he joined the group of Cézanne, Degas, Duranty, Sisley, and became a *plein air* painter. During the war of 1870 he withdrew to England, and on his return was introduced by Daubigny to a dealer, M. Durand-Ruel, in whose galleries almost all his works have been exhibited. In 1872 he exhibited views of Argenteuil, near Paris; in 1874 a series entitled "Cathedrals," showing the cathedral of Rouen under different lights. He afterwards painted views of Vétheuil (1875, see Plate), Pourville and cliffs of Etretat (1881), of Bordighera (1886), of the Creuse (1886), Le Meules (1891), and some further views of cathedrals (1894). In December 1900 he exhibited some pictures called "Le Bassin des Nymphéas," and was engaged at the beginning of 1901 in painting views of London. Several of Monet's paintings, bequeathed by M. Caillebotte, are in the Luxembourg Museum, Paris. (See IMPRESSIONISM.)

MONETARY CONFERENCES (INTERNATIONAL). These assemblies were one of the features of the latter half of the 19th century, due to the decided tendency towards securing reforms by concerted international action. The disorganized state of the European currencies, which became more serious in consequence of the great expansion in trade and industry, came into notice through the great gold discoveries and their effect on the relations between the two precious metals. Both by its situation and its currency system, France was the country that was first led to aim at the establishment of a currency union, in which French ideas and influences would be predominant. A preliminary step was the formation of the Latin union, whereby the currencies of France, Italy, Belgium and Switzerland were—in respect to their gold and silver coins—assimilated. In 1867 the Paris Exhibition furnished the occasion for summoning a monetary conference, to which the principal countries of the world sent representatives. The guiding spirit of this assembly was the eminent economist, De Parieu, who had originated the Latin Union. By his advice a scheme was approved recommending the adoption of the single gold standard, the use of the decimal

system, and the co-ordination of the various currencies with the French system. Difficulties as to the mode of bringing these principles into practical operation were discussed, and full liberty had to be given to the several nations to carry out the proposals in the way that seemed best. The result proved that the obstacles were insurmountable, e.g. the British government could not obtain the assent of a Royal Commission to the assimilation of the sovereign to the 25-franc piece; and the course of political events soon completely altered the relative position of the leading countries, even in their monetary relations. Germany and the United States reformed their currencies, without reference to any international considerations.

The meeting of the next international conference took place under very different conditions. A great fall in the value of silver as measured in gold, in progress from 1873, had affected the relations of silver-using countries, and disturbed the level of prices. Indian interests as well as those of American producers of silver suffered, while the management of all double-standard currencies became a task of increasing difficulty. The government of the United States invited the representatives of the leading powers to meet in Paris for the purpose of considering (1) the desirability of retaining the unrestricted use of silver for coinage, (2) the adoption of international bimetalism (*q.v.*), by the acceptance of a ratio to be fixed by agreement. Eleven nations sent delegates, Germany being the only great power unrepresented. After somewhat protracted discussion and the presentation of a large number of documents the European states accepted the American proposition "that it is necessary to maintain in the world the monetary functions of silver"; but declined to bind the discretion of particular states as to the methods to be employed. They further declared it impossible to enter into an agreement for a common ratio. The conference, therefore, separated without any result being obtained.

In consequence of the continuing fall in the value of silver, which stimulated the bimetallic agitation, a third conference was convened by the joint action of France and the United States; it also met in Paris, and was more influential than its predecessor, since Germany sent representatives, as did Spain, Portugal, Denmark and India. The characteristic of this conference was the greater strength of the support given to the bimetallic proposal by France and the United States, together with the opposition of the delegates of the smaller European countries, and the refusal of Germany to promise any co-operation. The inevitable consequence of this situation was the adjournment of the conference to obtain fresh instructions, which, however, were never furnished.

After several abortive attempts the fourth (and last) of the conferences of this class was brought together at Brussels in November 1892 on the initiative of the United States. A full representation of the powers attended, but delay arose from the absence of definite proposals by the American government. These, when they were presented, proved to be only a reaffirmation of the bimetallic policy, and showed no advance. The conference, therefore, proceeded to consider the plans of Levy, Baron de Rothschild and Sotbeer for the more extended use of silver. Such devices, being merely alleviations, failed to gain any effective support. Appeals to England and Germany to grant some concessions likewise failed. Thus, like its Paris forerunners, the Brussels conference adjourned, but never resumed its sittings.

After 1892 the currency problem passed into a new stage, in which action was national rather than international. The method of procedure by conference was for the time abandoned.

The proceedings of the several conferences have been issued by the governments taking part in them. Those of the United States are the most convenient for English and American readers. See also H. B. Russell, *International Monetary Conferences* (New York, 1898). (C. F. B.)

MONEY. 1. *Definition and Functions.*—The difficult question as to the best definition of money has been complicated by the efforts of writers so to define the term as to give support to their particular theories. It is hard to frame a precise account which

will hold good of the many objects that have served for monetary use. From denoting coined metal, money has come to include anything that performs the money work: though there has been considerable hesitation in extending the term to those forms of credit that are in modern societies the chief instrument of exchange. It is therefore best to avoid a formal definition; and, instead, to bring out the character of money by describing the functions that it performs in the social system. The most important is, clearly, that of facilitating exchange. It is not necessary to dwell on the great importance of this office. The slightest consideration of industrial organization shows that it is based on the division of employments; but the earliest economic writers saw plainly that division of employments was only possible through the agency of a medium of exchange. They recognized that the result of increasing specialization of labour was to establish a state of things in which each individual produced little or nothing for the direct satisfaction of his own wants, and had therefore to live by exchanging his product for the products of others. They saw, further, that this only became feasible by the existence of an article that all would be willing to accept for their special products; as otherwise the difficulty of bringing together persons with reciprocal wants would prove an insurmountable obstacle to that development of exchange, which alone made division of labour possible. A second function hardly inferior in importance to the one just mentioned is that of affording a ready means for estimating the comparative values of different commodities. Without some common object as a standard of comparison this would be practically impossible. "If a tailor had only coats and wanted to buy bread or a horse, it would be very troublesome to ascertain how much bread he ought to obtain for a coat or how many coats he should give for a horse"; and as the number of commodities concerned increased the problem would become harder, "for each commodity would have to be quoted in terms of every other commodity." There is, indeed, a good deal to be said for the view that the conception of general exchange value could never have been formed without the previous existence of money; it has certainly support from the evidence of competent observers respecting the methods of exchange followed by savage communities. The selection of some particular article as the criterion makes the comparison of values easy. "The chosen commodity becomes a *common denominator*, or *common measure of value* in terms of which we estimate the value of all other goods," and in this way money, which in its primary function renders exchange possible by acting as an intermediate term in each transfer, also makes exchanges easier by making them definite. Still another function of money comes into being with the progress of society. One of the most distinctive features of advancing civilization is the increasing tendency of people to trust each other. There is thus a continuous increase in relations arising from contract, as can be seen by examining the development of any legal system. Now, a contract implies something to be done in the future, and for estimating the value of that future act a standard is required; and here money which has already acted as a *medium of exchange* and as a *measure of value* at a given time, performs a *third* function, by affording an approximate means of estimating the present value of the future act; in this respect it may be regarded as a *standard of value*, or as some prefer to say, *of deferred payments*. Nor does this exhaust the list of services that money renders. In the earlier stages of economic life it acts as a *store of value*; for in no other way could a large body of wealth be concentrated. Though this is no longer needed by individuals, even at the present day the great banks find that their reserves must take the form of a monetary store. Again, money in its various forms has been the great agency for transmitting values from place to place. Its international function in this respect still continues. The balance of debt between countries is ultimately settled by the passage of bullion from the debtor to the creditor nation. But, though money has these powers, it is nevertheless correct to say that its essential functions are three in number, *i.e.* it supplies: (1) the common medium by which exchanges are made possible; (2) the common measure by which the comparative

values of those exchanges are estimated; (3) the standard by which future obligations are determined.

2. *The Value of Money, its Determining Causes. The Quantity of Money required by a Country.*—The value of money is in principle only a special case of the general problem of value; but owing to its peculiar position the medium of exchange has in this respect become surrounded by difficulties that need to be removed. The very phrase "value of money" is employed in two senses, which on the surface seem to have no connexion with each other, and are the cause of much confusion to those who have not looked into the matter. In mercantile phraseology the value of money means the interest charged for the use of loanable capital. When the market rate of interest is high, money is said to be dear; when it is low, money is regarded as cheap. Without entering into the reasons for this use of the term, it is sufficient to state the other and for our present purpose more correct meaning of the phrase. As the value of a thing is what it will exchange for; so "the value of money is what money will exchange for, or its purchasing power. If prices are low, money will buy much of other things, and is of high value; if prices are high, it will buy little of other things, and is of low value. The value of money is inversely as general prices, falling as they rise and rising as they fall." Now the *proximate* condition under which value is determined is admittedly the establishment of an equation between demand and supply. In the case of money, however, some explanation as to the nature of both these elements in the problem becomes necessary. In what forms is the supply of, and the demand for, money exhibited? The supply of a commodity is the quantity of it which is offered for sale. But in what shape does the sale of money take place? Plainly, by being offered for goods. The supply of money is the quantity of it which people are wanting to lay out, *i.e.* all the money in circulation at the time. Demand, in like manner, means the quantity of a commodity desired, or, according to another mode of expression, the amount of purchasing power offered for it. Taking the latter as the more convenient for the case of money, we can say that the demand for it consists in all goods offered for sale. The position of money as the medium of exchange introduces a further novel feature; for the market in its case is world-wide and the demand is unceasing; money is consequently in a constant state of supply and demand. It thus appears that the factors determining the value of money at a given time are: (1) the amount of money in circulation, and (2) the amount of goods on sale. Closer examination reveals other influencing conditions. The mere quantity of money is not the only element on the supply side. The varying circulation of the monetary units must be taken into account. Some coins do not make a single purchase in a year, while others change hands in transactions hundreds of times. By averaging, we may estimate the effect of the rapidity with which money does its work, or, to employ a technical term, the "efficiency of money." Similarly, the amount of sales rather than the quantity of commodities is the determining element on the demand side. Thus, if the influence of credit be omitted, it is true to say that the value of money varies inversely as its quantity multiplied by its efficiency, the amount of transactions being assumed to be constant. Some additional explanation is required before this formula can be accepted as an expression of the whole truth on the subject. It must be noticed that it is not commodities only that are exchanged for money. Services of all kinds constitute a large portion of the demand for the circulating medium, while the payment of interest on the many kinds of obligations makes a further call on it. The potent influence of credit must also be recognized. The latter force is indeed the chief agency to be considered in dealing with the variations of prices; though so far as it is based on deposits of metallic money it may be regarded as a form of increased monetary efficiency, and therefore as coming within the formula given above. In its wider aspect, credit acts as a substitute for ordinary money, and may be interpreted as equivalent to a system of perfected barter, or, better, as a new currency development. An interesting but paradoxical conclusion should be noticed: it is that increased

trade and expanding business are causes which operate not to raise, but to lower prices; for by enlarging the work that money has to do they raise its value, i.e. provided that other things remain the same. Another more obvious deduction is that a large addition to the stock of money does not necessarily raise prices, since money is only effective when brought into circulation.

The chief topic of dispute in respect to the theory of money-value has been concerned with the question as to the ultimate regulating influence. The value of freely produced commodities is—according to economic theory—determined by “cost of production,” or, where the article is produced at different costs, by the cost of production under the most unfavourable circumstances. As demand varies with price, it follows that an adjustment of value takes place through the interaction of cost and demand, the latter indicating the influence of the utility of the commodity on the quantity required. In applying the theory to the special case of money, the first consideration is the fact that gold and silver, the principal money materials, are the products of mines, and are produced at different costs, so that their values depend on the portions raised at greatest cost. We thus obtain the proposition that has figured in so many textbooks; viz. that “the value of money depends on its cost of production.” The theory of normal value, however, involves certain assumptions, which are significant in this connexion. Competition is conceived as absolutely free; it is assumed that there are accurate data for computing costs, and that the determination of value by cost is effective only “in the long run.” It is recognized, also, that cost operates on value through its power in regulating supply. “The latent influence,” says Mill, “by which the value of things are made to conform in the long run to the cost of production is the variation that would otherwise take place in the supply of the commodity.” From such considerations it follows that the influence of cost on the value of money is not so predominant as a rigid interpretation of the theory of value seems to suggest.

In earlier times it has been a common proceeding on the part of governments to restrict or stimulate both mining for the precious metals and the business of coining. At all times the working of gold and silver mines has been rather a hazardous speculation than a legitimate business. “When any person undertakes to work a new mine in Peru,” says Adam Smith, “he is universally looked upon as a man destined to bankruptcy and ruin, and is upon that account shunned and avoided by everybody. Mining, it seems, is considered there in the same light as here, as a lottery in which the prizes do not compensate the blanks.” The modern capitalistic organization of gold mining has not done much to alter this condition. As regards the adjustment of supply to meet an altered cost of production the difficulties are, if possible, greater. The actual supply of money is so large, when compared with the annual production of the precious metals, that a change in output can operate but slowly on its value. The total stoppage of fresh supplies from the mines would not be sensibly felt for some years; and though increased production is more rapid in its operation, it takes some time to produce a decided effect. Hence the conclusion is reached that “the effects of all changes in the conditions of production of the precious metals are at first, and continue to be for many years, questions of quantity only, with little reference to cost of production.” This is the position which is usually known as that of the “quantity” theory; though very different degrees of doctrine are comprised under the general title. With due qualification and comment it may be taken as the prevalent theory. At all events it is beyond dispute that the cost of production is not for short periods the controlling force which governs the value of money; while even for long periods its influence is very hard to ascertain, in consequence of the speculative nature of the industries of gold and silver mining. Another peculiar feature of the problem of money value arises from the fact that it is only through an actual change in the supply of money that its value can be altered. With other commodities the knowledge that they can be produced at lower cost will bring about a reduction in their value. In the case of money, this does not hold. There must be an adjustment of the amount, or of the efficiency, of the money stock, since, as explained above, it is in a constant state of supply and demand. Its value is established in the very process of carrying on exchanges, and that process is influenced by the available supply. In regard to another form of money the effect of the amount in existence is still more decisive. This is paper money, not immediately redeemable in coin. In this case the idea of cost is manifestly inapplicable; the quantity in circulation is evidently, as proved by abundant experience, the ruling influence on value. In fact, the “quantity”

theory receives its simplest illustration in the case of inconvertible paper. The truth that the theory is but an instance of the action of supply and demand is equally shown by this prominent class of instances. Where metallic coinage is artificially limited the same principle holds good. The value of such currencies plainly depends on the conditions of supply and demand.

The immense growth of credit and its embodiment in instruments that can be used as substitutes for money has led to the promulgation of a view respecting the value of money which may be called the “credit” theory. According to the upholders of this doctrine, the actual amount of metallic money has but a trifling effect on the range of prices, and therefore on the value of money. What is really important is the volume of credit instruments in circulation. It is on their amount that price movements depend. Gold has become only the small change of the wholesale markets, and its quantity is comparatively unimportant as a determinant of prices. The theory has some connexion with the view of “money” as consisting in the loanable capital of the market, taking shape in the cheques that transfer liabilities. Thus the rate of interest comes to form a factor in the creation of “money,” and the mercantile use of the phrase “value of money” receives a justification. Like the pure “cost” theory of money value, the “credit” theory gives too one-sided a view of the facts. In particular, it fails to recognize the ultimate dependence of all kinds of credit on the stock of money in the full sense, i.e. on metallic legal-tender money. The truths adumbrated in the theory are better expressed in the statement of the quantity theory in its developed form, as set forth above. It is necessary to take into account the varying quantities of the precious metals, the modes of use in respect to them; the influence of cost of production, and the way in which credit expedients replace standard money. A complete theory must include all these elements, while not unduly emphasizing any one of them.

At the beginning of statistical inquiry much attention was given to the question: What quantity of money does a country require for the proper working of its industrial system? Petty and Locke were ready to give definite answers; but modern inquirers decline making any quantitative statement, and content themselves with indicating the conditions to be considered. Amongst these are: Population, amount of transactions, the efficiency of money, the development of credit, and the height to which banking organization has attained. Other elements in the problem are the disposition towards hoarding, and the employment of some form of barter in transactions. The contrast between India and the United States in monetary and industrial habits supplies an effective series of illustrations on this matter. The conclusion is obvious that economic progress is accompanied by a more sparing use of money. The most important aspect of the question in modern times is in relation to the division of money between countries. Regarded from this point of view, the quantity of money that a country needs is that which will keep its prices in due level with those of the countries with which it has commercial relations. For, this is the condition of equilibrium; there would otherwise be an excess of either exports or imports, involving a transfer of money to adjust the balance. It may be added that the organization works automatically, since fluctuations in the stock of money are corrected by the action of trade. The best estimates place the gold circulation of the United Kingdom at somewhat under £100,000,000, the token currency at about £15,000,000, and the note circulation as nearly £43,000,000. The French use of metallic money is much larger; probably over £200,000,000, and the note circulation is also over £200,000,000.

3. *Early Forms of Currency.*—Up to the present we have considered money as being fully established and properly adapted to fulfil its various functions. We have now to trace the steps by which a suitable system of currency was evolved from a state of barter. It is important for a right understanding of the question to grasp the fact that exchanges took place originally between groups, and not between individuals. The slow growth of exchanges is thus explained, as each group produced most of the articles necessary for itself, and such acts of barter as took

place were rather reciprocal presents than mercantile exchanges. Such is actually the case among modern savages. "It is instructive to see trade in its lowest form among such tribes as the Australians. The tough greenstone valuable for making hatchets is carried hundreds of miles by natives, who receive from other tribes in return the prized products of their districts, such as red ochre to paint their bodies with; they have even got so far as to let peaceful traders pass unharmed through tribes at war, so that trains of youths might be met, each lad with a slab of sandstone on his head to be carried to his distant home and shaped into a seed-crusher. When strangers visit a tribe they are received at a friendly gathering or corroboree, and presents are given on both sides. No doubt there is a general sense that the gifts are to be fair exchanges, and if either side is not satisfied there will be grumbling and quarrelling; but in this roughest kind of barter we do not yet find that clear notion of a unit of value which is the great step in trading." This vivid description of E. B. Tylor's enables us to realize the way in which money came into existence. When any commodity becomes an object of desire, not merely from its use to the persons desiring it, but from their wanting it as being readily exchangeable for other things, then that article may be regarded as rudimentary money. Thus the greenstone and ochre are on their way to being promoted to the position of currency, and the idea of a "unit of value" is all that is needed to complete the invention. "This higher stage is found among the Indians of British Columbia, whose strings of haiqua-shells worn as ornamental borders to their dresses serve them also as currency to trade with—a string of ordinary quality being reckoned as worth one beaver's skin." Such shells are in reality money, inasmuch as they discharge its functions.

On a review of existing savage tribes and ancient races of more or less civilization we are surprised at the great variety of objects which have been used to supply the need of a circulating medium. Skins, for instance, seem to be one of the earliest forms of money. They have been found among the Indians of Alaska performing this service, while accounts of leather money seem to show that their use was formerly more general. As the hunting stage gives place to the pastoral, and animals become domesticated, the animal itself, instead of its skin, becomes the principal form of currency. There is a great mass of evidence to show that, in the most distant regions and at very different times, cattle formed a currency for pastoral and early agricultural nations. Alike among existing barbarous tribes, and in the survivals discovered among classical nations, sheep and oxen both appear as units of value. Thus we find that at Rome, and through the Italian tribes generally, "oxen and sheep formed the oldest medium of exchange, ten sheep being reckoned equivalent to one ox. The recognition of these objects as universal legal representatives of value, or, in other words, as money, may be traced back to the epoch of a purely pastoral economy. The Icelandic law bears witness to a similar state of things; while the various fines in the different Teutonic codes are estimated in cattle. The Latin word *pecunia* (*pecus*) is an evidence of the earliest Roman money being composed of cattle. The English *fee* and the famous term *feudal*, according to its most probable etymology, are derived from the same root. In a well-known passage of the *Iliad* (vi. 235-6) the value of two different sets of armour is estimated in terms of oxen. The Irish law tracts bear evidence as to the use of cattle as one of the measures of value in early Irish civilization. Similarly, oxen from the principal wealth and the circulating medium among the Zulus and Kaffirs. On the testimony of an eye-witness we are assured that, "as cattle constitute the sole wealth of the people, so they are their only medium of such transactions as involve exchange, payment or reward." So also we find that cattle-rents are paid by the pastoral Indian tribes to the United States government. From the prominence of slavery in early societies it is reasonable to suppose that slaves would be adopted as a medium of exchange, and one of the measures of value in the Irish law tracts, *cumhal*, is said to have originally meant a female slave. They are at present applied to this purpose in Central Africa, and also in New Guinea. On passing to the agricultural stage a greater number of objects are found capable of being applied to currency purposes. Among these are corn—used even at present in Norway—maize, olive oil, coco-nuts and tea. The most remarkable instance of an agricultural product being used as currency is to be found in the case of tobacco, which was adopted as legal tender by the English colonists in North America. Another class of articles used for money consists of ornaments, which among all uncivilized tribes serve this purpose. The haiqua-shells mentioned before are an instance, cowries in India, whales' teeth among the Fijians, red feathers among some South Sea Island tribes, and finally, any attractive kinds of stone which can be easily worked. Mineral products, so far as

they do not come under the preceding head, furnish another class. Thus salt was used in Abyssinia and Mexico; while the metals—a phenomenon which will require a more careful examination—have succeeded in finally driving all their inferior competitors out of the field, and have become the sole substances for money.

4. *The Metals as Money. Reasons for their Adoption. Superiority of Silver and Gold.*—The employment of metals as money material can be traced far back in the history of civilization; but as it is impossible to determine the exact order of their appearance in this capacity, it will be convenient to take them in the order of their value, beginning with the lowest. Iron—to judge from the statement of Aristotle—was widely used as currency. One remarkable instance is the Spartan money, which was clearly a survival of a form that had died out among the other Greek states; though it has often been attributed to ascetic policy. In conjunction with copper, iron formed one of the constituents of early Chinese currency, and at a later time was used as a subsidiary coinage in Japan. Iron spikes are used as money in Central Africa, while Adam Smith notes the employment of nails for the same purpose in Scotland. Lead has served as money, e.g. in Burma. The use of copper as money has been more extensive than is the case in respect to the metals just mentioned. It, as stated, was used in China along with iron—an early instance of bimetallicism—and it figured in the first Hebrew coins. It was the sole Roman coinage down to 269 B.C. and it has lingered on to a comparatively recent date in the backward European currencies. It even survives as a part of the token coinage of the present. Tin has not been a favourite material for money: the richness of the Cornish mines accounts for its use by some British kings. Silver holds a more prominent place than any of the preceding metals. Down to the close of the 18th century it was the chief form of money, and often looked on as forming the necessary standard substance. It was the principal Greek money material, and was introduced at Rome in 269 B.C. The currencies of medieval Europe had silver as their leading constituent; while down almost to the present day Eastern countries seemed to prefer silver to gold.

The pre-eminence of gold as money is now beyond dispute; there is, however, some difficulty in discovering its earliest employment. It is, perhaps, to be found in "the pictures of the ancient Egyptians weighing in scales heaps of rings of gold and silver." According to W. Ridgeway's ingenious theory gold comes into use as a currency in due equa­tion to the older cattle-unit, the ox. It was certainly employed by the great Eastern monarchs; its further development will be considered later on. Metals of modern discovery—such as nickel and platinum—are only used by the fancy of a few governments, though the former makes a good token coinage.

The preceding examination of the varied materials of currency, metallic and non-metallic, suggests some conclusions respecting the course of monetary evolution, viz.: (1) that the metals tend to supersede all other forms of money among progressive communities; and (2) that the more valuable metals displace the less valuable ones. The explanation of these movements is found in the qualities that are specially desirable in the articles used for money. There has been a long process of selection and elimination in the course of monetary history.

First, it is plain that nothing can serve as money which has not the attributes of wealth; i.e. unless it is useful, transferable and limited in supply. As these conditions are essential to the existence of value, the instrument for measuring and transferring values must possess them. A second requisite of great effect is the amount of value in proportion to weight or mass. High value in small bulk gives the quality of portability, want of which has been a fatal obstacle to the continued use of many early forms of money. Skins, corn and tobacco were defective in this quality, and so were iron and copper. Sheep and oxen, though technically described as "self-moving," are expensive to transport from place to place. That the material of money shall be the same throughout, so that one unit shall be equal in value to another, is a further desideratum, which is as decidedly lacking in cattle-currency as it is prominent in the metals. It is, further, desirable that the substance used as money shall be

capable of being divided without loss of value, and, if needed, of being reunited. Most of the articles used in primitive societies—such as eggs, skins and cattle—fall in this quality. Money should also be durable, a requirement which leads to the exclusion of all animal and most vegetable substances from the class of suitable currency materials. To be easily recognized is another very desirable quality in money, and moreover to be recognized as of a given value. Articles otherwise well fitted for money-use, e.g. precious stones, suffer through the difficulty of estimating their value. Finally, it results from the function of money as a standard of value that it should alter in its own value as little as possible. Complete fixity of value is from the nature of things unattainable; but the nearest approximation that can be secured is desirable. In early societies this quality is not of great importance; for future obligations are few and inconsiderable. With the growth of industry and commerce and the expansion of the system of contracts, covering a distant future, the evil effects of a shifting standard of value attract attention, and lead to the suggestion of ingenious devices to correct fluctuations. These belong to the later history of money and currency movements. It is enough for the ordinary purposes of money that it shall not alter within short periods, which is a characteristic of the more valuable metals, and particularly of silver and gold, while in contrast such an article as corn changes considerably in value from year to year.

From the foregoing examination of the requisites desirable in the material of money it is easy to deduce the empirical laws which the history of money discloses, since metals, as compared with non-metallic substances, evidently possess those requisites in a great degree. They are all durable, homogeneous, divisible and recognizable, and in virtue of these superior advantages they are the only substances now used for money by advanced nations. Nor is the case different when the decision has to be made between the different metals. Iron has been rejected because of its low value and its liability to rust, lead from its extreme softness, and tin from its tendency to break. All these metals, as well as copper, are unsuitable from their low value, which hinders their speedy transmission so as to adjust inequalities of local prices.

The elimination of the cheaper metals leaves silver and gold as the only suitable materials for forming the principal currency. Of late years there has been a very decided movement towards the adoption of the latter as the sole monetary standard, silver being regarded as suitable only for a subsidiary coinage. The special features of gold and silver which render them the most suitable materials for currency may here be noted. "The value of these metals changes only by slow degrees; they are readily divisible into any number of parts which may be reunited by means of fusion without loss; they do not deteriorate by being kept; their firm and compact texture makes them difficult to wear; their cost of production, especially of gold, is so considerable that they possess great value in small bulk, and can of course be transported with comparative facility; and their identity is perfect." The possession by both these metals of all the qualities needed in money is more briefly but forcibly put by Cantillon when he says that "gold and silver alone are of small volume, of equal goodness, easy of transport, divisible without loss, easily guarded, beautiful and brilliant and durable almost to eternity." This view has even been pushed to an extreme form in the proposition of Turgot, that they became universal money by the nature and force of things, independently of all convention and law, from which the deduction has been drawn that to proscribe silver by law from being used as money is a violation of the nature of things.

5. *The Introduction and Development of Coinage. The State and Money.*—The earliest metallic currencies passed by weight; they were, in fact, commodities, though used in a special way. The Hebrew records, as well as the Greek writers, bear witness to the prevalence of this primitive system. Thus, Aristotle, after explaining the circumstances that led to the invention of money, points out how it was at first defined simply by size and weight, although finally men went further and set a stamp on every coin to relieve them from the trouble of weighing it." (*Pol.* i. 9, 8.)

Coinage systems have had a long period of growth, in which two distinct stages can be noted. In the first only the quality or fineness of the metal is denoted by the stamp, no attempt being made to fix the weight. The stamp, so to speak, acts as a kind of *hall-mark*. The cubes of gold employed by the Chinese may have been the earliest coins. Modern authorities accept the view of Herodotus that gold and silver coins were first used by the Lydians; the same author mentions that the first Greek coinage was at Aegina by Phidon of Argos. In order to complete the intimation, it became necessary to certify the weight of metal in the coin as well as its fineness. A further result was the establishment of a regular shape for the purpose of preventing any tampering with the coin after its manufacture. Though various experiments in form were made, by the production of hexagonal and octagonal coins, the universally accepted shape came to be that of a flat circle, each side of which is stamped, as also in many cases the edge. The great number of the Greek city states afforded ample opportunities for experiment and competition, and rapid progress in the direction of securing good currencies was made. The improvement in the Greek coinages may be regarded as the consequence, and in some degree a cause, of their growing commerce. From Greece the art of coining was introduced into Italy by the Hellenic settlers and traders, and became one of the essential features of a civilized society. Progress, however, did not stop with the establishment of the institution of coined money. A number of practical questions had to be decided respecting the best way of overcoming the difficulties that certain technical problems presented. In spite of early experience, it has at times been suggested that the circular form might be replaced by some other, e.g. the square or oblong. Practical considerations controlled the selection of the old-established shape. Another question was in respect to the limits of size that were most suitable for coins. Here the lower limit is prescribed by the convenience of the users. Coins that are easily lost, or picked up with trouble, such as the British threepenny piece and the American gold dollar, ought not to be issued. The determination of the upper limit presents greater difficulties. Very large pieces are hard to coin, and they give facilities for improper treatment by drilling holes and filling them up with cheaper metal, or even for the entire removal of the interior, the faces being preserved. The attractive appearance of large gold coins is no compensation for this danger. The smallest size, however, and in silver, the smallest seem to come near the upper limit of safe issue. The comparative wear of coins of different sizes must be considered. A long series of experiments, supported by ordinary experience, goes to show that the smaller coins wear more rapidly. The English mint in 1833 estimated the loss per cent. per annum at 2s. 6d. on half-crowns, 4s. on shillings, and 7s. 6d. on sixpences. There are accordingly reasons for adopting a medium size in preference to large or small coins. The actual coins issued have, of course, to be adapted to the requirements of the particular community. Even prejudices must be taken into account. The silver coinage, for example, in connexion with coinage have proved a fruitful field for the student of Numismatics (*q.v.*). From the monetary standpoint the aim of the design is to prevent either counterfeiting or the abstraction of any portion of the metal. For the former purpose careful execution in designing and the use of powerful machinery are the really effective safeguards. The latter is best obviated by protecting the edges by the process of milling, to which a raised inscription has sometimes been added. Great advances have been made in the organization of the modern Mint (*q.v.*) by the use of new appliances and scientific methods. The question of the proper alloy in coins has received a great deal of attention. As gold and silver are both by nature soft, some other metal, such as copper or tin, has to be added, in order to secure the necessary hardness. The English gold coins have an alloy of one-twelfth; the silver coins one of three-fortieths. Far more general is the alloy of one-tenth, which is probably due to the sentiment in favour of a decimal system; but at any rate is simple for calculations. There does not appear to be any strong technical reason for preferring either of these alloys to the other. The French mint authorities are in favour of their one-tenth; while the English ones adhere to the alloy of one-twelfth. There is agreement only on the point that a very small amount of alloy, e.g. that of one in seventy-two, as used in the Austrian ducat, does not give the requisite hardness.

A question of far more importance, both politically and economically, is that of the issue of money, and the power of the state in regard to it. In the ruder societies, where money was not sharply distinguished from commodities, no difficulty presented itself. Skins, shells or cattle were money—so to speak—by the force of things; and the same condition persisted as long as crude metals were employed. But with the introduction of coinage the idea of a regulating authority came into being. The necessity of enforcing contracts and the parallel system of penalties made it incumbent on the ruler and judges to provide due standards of payment. The combined effect of these influences was reinforced by the establishment of the rudimentary forms of state revenue, which made it a matter of interest to the ruler to provide a good medium of payment. Accordingly, with the origin of the organized state, we find the coinage as a special prerogative of the king, though

private persons often exercised the privilege of coining. The very large number of the autonomous cities of Greece, which possessed the right of issuing money, was the cause of the competition between different currencies, each having legal tender power only within its own city. In its practical outcome this "free coinage" system proved beneficial, for it compelled the maintenance of the true standard in order to gain wider circulation. With the establishment of larger states the control over the issue of money grew more stringent. In the later Roman Empire the right of coining was reserved to the emperor exclusively. After the fall of the empire the traditions of prerogative passed on to the medieval kings, a right carefully guarded by the English sovereigns. In France and Germany the principal nobles claimed this seigniorial right, but in the modern state the regulation money has been definitely vested in the supreme authority, *i.e.* the sovereign.

One reason for the close connexion of money with the state is the fact that there is one attribute of currency which comes within the area of work specially allotted to the public authority. Money ought to have the power finally to close a transaction, *i.e.* to say it should be "legal tender." This "liberating power," as the French call it, might be regarded as one of the money functions. Those who look on money as a purely legal institution naturally take this view; it seems, however, better to take the economic conditions as the really fundamental ones. It is only on account of their economic effects that legal regulations require consideration. These effects are, indeed, very far-reaching. By prescribing the standard and amount of penalties, by their power of selecting the substances to be used as money, and by their frequent interferences with existing currencies, the governments of the world have guided—as well as very often disturbed—the normal course of development. What Aristotle regarded as the "unnatural" character of money is mainly attributable to state intervention. But it is important to remember that the sphere of governmental action in respect to money is limited. A currency system is never an arbitrary creation; it must grow slowly out of the habits and customs of the community, and must subserve its economic needs. No sudden change at the caprice of the state is likely to continue. Further, it is clear that no government can determine the results of its interference; these will depend on the existing conditions and will conform to economic law. Monetary history is rich in examples of the failure of legal enactment to direct the course of events, and of the disasters that have followed on the ill-advised measures of public authority.

One result of the close connexion of the state with the business of coining has been the establishment of regulations in reference to the expense of the process. As coins are manufactured articles it seems evident that a charge sufficient to cover the cost may rightly be imposed. Such a charge is described by the term *Seigniorage* (*g.r.*). It has in many cases been so fixed as to bring in a large profit to the government; but then it amounts to a depreciation of the currency; for the levy of a charge on coining is the same as the subtraction of so much metal from the coins issued. English policy is peculiar in its adoption of gratuitous coinage of gold, an anomaly due in its origin to the prejudices of the mercantile doctrines, but defended on the ground of the convenience to trade from the equivalence of gold bullion and coin. The heavy seigniorage on the silver coins—at present over 60%—is a source of considerable profit; in some years exceeding £800,000. All other countries levy moderate charges on their gold coinages, and make profit on their silver issues, though in different ways. As it has become the duty of the state to maintain the currency in a sound condition, it has to deal with the question of its expense. This is composed of several elements, *viz.* (1) the cost of manufacture, just mentioned; (2) the loss through the wear which money undergoes in the work of circulating; and (3) the interest on the capital sunk in the monetary stock. A country with a metallic circulation of £100,000,000 incurs a loss of the interest which that amount of capital would produce by investment, *i.e.* at 4% £4,000,000. The expense is amply justified by the services that a good currency renders; but, at the same time, it proves the desirability of any economies that do not detract from efficiency. The great economizing agency is the use of representative money and the various forms of credit, in which so much of the latest advances consist.

6. Representative Money; its Introduction and Development. The Mode in which Credit is used as Money.—Economy in the employment of the precious metals is naturally suggested by ordinary experience; but the way in which states have profited by the expedient of depreciation affords a special inducement to follow what is practically the same course, and issue paper documents in place of the more costly metallic medium. In theory, as Ricardo explained, a paper currency is one in which the whole value has been appropriated as seigniorage. The cost of keeping a stock of valuable money is obviated, and the new instrument of exchange is supported by state authority. Here the action of economic conditions is instructively illustrated; for though a government can set up a paper currency, it is not within its power to prescribe its value. The quantity theory

(§ 2) is confirmed by the inevitable decline in value when issue passes a definite point. The only effective mode of preventing depreciation is by limiting the amount of paper money to that of the metallic money previously in circulation. The easiest way to accomplish this is to leave the use of the paper currency optional by making it convertible into coin at the will of the holder. The amount of the circulation is thus automatically fixed by the action of the community. An evident disadvantage is the necessity of keeping an adequate reserve of coin to meet actual and prospective demands. For ideal security the whole amount of paper issue should be covered by an equal value of metal. In practice the reserve may be much smaller; but so far as it is required, it means a deduction from the gain of issue. The temptation to reduce the reserve to an inadequate amount and then to escape the difficulty by resorting to the expedient of refusing to pay coin for notes, *i.e.* making the notes inconvertible, has proved too strong for nearly all governments at times of pressure. The history of state dealings with paper money may broadly be described as a history of inconvertibility. Hard-bought experience has only now forced on the notice of governments the loss that follows from a disturbance of the standard used in ordinary payments. They are evident to all careful observers, and may be concisely summarized as consisting in: (1) the injustice to creditors through being paid in a much lower standard than that in which they lent; (2) the disturbance to trade, both domestic and foreign, by the fluctuations in the value of money; (3) the pressure on the working classes from the slower rise of money wages, in contrast with the quicker movement of the prices of commodities, resulting in a fall of real wages; and (4) the check to dealings in relation with the international money market, due to the risk of exchange fluctuations. The only gains are the temporary stimulus to certain branches of trade, and the advantage to the state by contracting a forced loan without paying interest.

The origination of paper money by state direction is the easiest to consider and explain. It does not follow that it is the most important or the earliest kind of representative currency. As W. Bagehot has pointed out, the real origin of economic institutions is often very different from the apparent one. In truth, representative money seems to have grown up out of the elementary contrivances of early credit. A claim could be expressed and transferred by a document, which might be used for facilitating exchanges. The rigid formalism of early law hindered the extensive use of this convenient machinery. It was not till the institution of *banking* that the coining of credit was made easy. Thus the bank-note comes into use, resting, not on the fiat of the state, but on the repute of the issuer. At this stage the history of the two distinct forms of representative money becomes mixed, owing to the control exercised over banks by government and to the fact that banking companies were in many cases the agents by which what was virtually state money was issued. There is, however, the fundamental difference that bank money finds its way into use through the ordinary system of granting credit; while government money is used in the purchase of commodities and the hire of services. The former, therefore, returns in a short time; the latter remains in circulation and displaces metallic currency. In the long controversy over the Bank Charter Act 1844 this distinction was brought into prominence. Since that date the extraordinary development of deposit banking in both Great Britain and the United States has furnished these countries with by far the most flexible form of currency yet known in the cheques that transfer claims on the capital held by the banking institutions. The confusion so often shown regarding the relation of credit to money is connected with this latest progress. When it is remembered that in its origin money is only an instrument to facilitate exchange—we might even say to render it possible—it follows that from its earliest to its latest form the ruling influence is the need of society for the best mechanism of exchange.

7. Production and Consumption of the Precious Metals in their Economic Aspects.—In considering various monetary questions it is essential to have some acquaintance with the economic

aspects of the production of gold and silver. The first point to which attention may be directed is the field over which production extends. At one time or other these two metals have been found in every continent. Asia Minor in early times possessed its goldfields, or rather auriferous sands. Ceylon also undoubtedly contained gold-mines. China and India both produced silver to a considerable extent. Egyptian remains show that gold was commonly known in that country, probably procured from Nubia and Abyssinia. On the opposite side of Africa, too, the name of Gold Coast shows that that metal was thence exported. The mines of Laurium in Attica were a source of supply to the Athenians, and were worked as a state monopoly. At an earlier date the Babylonian and Assyrian empires had each accumulated large stores of gold. The Phœnician importations of gold from the Red Sea coasts (Ophir) are known from Scripture. The Persian kings from the time of Darius levied tribute on all their provinces—in gold from India, in silver from the remaining districts, the larger part of which was stored up in the royal treasuries. This tendency of despotic rulers to accumulate treasure had all through ancient history important effects on the economic structure of society. At present it is quite natural to assume that the materials of money are distributed by means of international trade, and tend to keep at an equal level all the world over—an assumption which is in general well grounded, though an important exception exists. Ancient history presents a widely different set of forces in operation. Gold and silver were produced by slaves under the pressure of fear, and were drawn towards the ruling parts of the great empires; in a word, war, not commerce, was the distributing agency. From this condition of affairs it is easy to see that, whatever may be the reasons for assigning to cost of production a potent influence over the value of money in modern times (and grounds have been already advanced for the belief that its influence has been exaggerated), no such reasons then existed. The production of the precious metals was carried on in similar manner to the great buildings and other works of those periods, on non-economic grounds, and therefore produced quite different effects. The whole history of the Persian monarchy to its overthrow by Alexander (330 B.C.) shows that the hoarded mass of the precious metals continued constantly to increase. On the capture of Persepolis by the Grecian army an enormous treasure was found there, some estimates placing it as high as 120,000 talents of gold and silver (£27,600,000). All the temples, too, were receptacles for the precious metals, so that the stock accumulated at about 300 B.C. must have been very great. The only causes which tended to diminish the store were the losses arising from wars, when the various treasuries were liable to be plundered and their contents dispersed. There was therefore a more unequal distribution of the material of money than at present. The growth of the Roman dominion led to important results, since under their rule the Spanish mines were developed and became a leading source of supply. The great masses of treasure set towards Rome, so that it became the monetary centre of the world. The overthrow of the republican government and the peace which followed also affected the conditions of production. The inefficiency of the Roman administration made it advantageous to let out the mines to farmers, who worked them in a wasteful and improvident manner, while the supply of slaves was reduced, thus depriving the lessees of their principal agency for carrying on production. The result was a continuous decline in the store of money. W. Jacob has made an attempt to estimate the amount at the death of Augustus (A.D. 14), and arrives at the conclusion that it was £38,500,000. (*Precious Metals*, i. 225.) Without placing much value on this necessarily conjectural estimate, it is safe to assume that this period marked the highest point of accumulation.

The succeeding centuries exhibit a steady decline, though it is of course impossible to attach any value to even the most carefully guarded numerical estimates. The phenomenon which has since so often attracted notice—the drain of the precious metals to the East—began at this time, and was a subject of

complaint by the Roman writers, while the stock of gold and silver being thrown into general circulation suffered from abrasion, and was more likely to be lost than when stored up in the royal treasure-houses and temples. These causes tended to depress the scale of prices, while the barbarian invasions produced a strong effect on the supply by drawing off the mining population and damaging the various erections used for working the mines. The conjectural estimate is that about A.D. 800 the total supply had been reduced to £33,000,000 (or about one-eleventh of what it had been at the death of Augustus). A new period in the history of gold and silver production may be fixed at this date. The Moors, now firmly established in Spain, began to reopen the mines in that country which had been allowed to fall into disuse. Other European mines also were opened, notably those of Saxony and the Harz Mountains, as well as the Austrian mines—the chief medieval sources of supply. The international system of currency, based on the pound of silver as a unit, which was introduced by Charlemagne, must have tended to economize the wear of the metals. We may therefore conclude that from this date (A.D. 800) the supply was sufficient to counteract the loss by wear and exportation, and accordingly regard the metallic supply as fixed in amount until the next change in the conditions of production, which was the result of the discovery of America. Though 1492 is the date of the first landing, yet for some time no important additions were made to the supply of money. The conquest of Mexico (1519) gave opportunities of working the silver-mines of that country, while the first mines of Chile and Peru were almost simultaneously discovered, and in 1545 those of Potosi were laid open. From this latter date we may regard the American supply as an influential factor in causing a continuous increase in the stock of money. The annual addition to the store of money has been estimated as £2,100,000 for the period from 1545 to 1600. At this date the Brazilian supply began. The course of distribution of these fresh masses of the precious metals deserves some notice. The flow of the new supplies was first towards Spain and Portugal, whence they passed to the larger commercial centres of the other European countries, the effect being that prices were raised in and about the chief towns, while the value of money in the country districts remained unaltered. The additions to the supply of both gold and silver during the two centuries 1600–1800 continued to be very considerable; but, if Adam Smith's view be correct, the full effect on prices was produced by 1640, and the increased amount of money was from that time counterbalanced by the wider extension of trade. At the commencement of the 19th century the annual production of gold had been estimated as being from £2,500,000 to £3,000,000. The year 1809 seems to mark an epoch in the production of these metals, since the outbreak of the revolts of the various Spanish dependencies in South America tended to check the usual supply from those countries, and a marked increase in the value of money was the consequence. During the period 1809–1849 the value of gold and silver rose to about two and a half times its former level, notwithstanding fresh discoveries in Asiatic Russia, which became considerable from 1823. The annual yield in 1849 was estimated at £8,000,000. The next important date for our present purpose is the year 1848, when the Californian mines were opened, while in 1851 the Australian discoveries took place. By these events an enormous mass of gold was added to the world's supply. The most careful estimates fix the addition during the years 1851–1871 at £500,000,000, or an amount nearly equal to the former stock in existence. The problems raised by this phenomenon have received careful study. The main features of interest may be briefly summed up. (1) The additional supply was almost entirely of gold, thus tending to produce a distinction between the two principal monetary metals and an alteration in the currency of bimetallic countries. Under this influence France, from being a silver-using, became a gold-using country. (2) The contemporaneous development of the continental railway systems, and the partial adoption of free trade, with the consequent facilities for freer circulation of commodities, led to the course of distribution

being different from that of the 16th century. The more backward districts were the principal gainers, and a more general equalization of prices combined with a slight elevation in value was the outcome. (3) The increased supply of gold rendered a general currency reform possible, and made the use of a gold monometallic standard appear feasible. The movements for currency reform, as will be seen, all arose after these discoveries. (4) The change in the value of money, which may for the period 1849-1869 be fixed at 20%, enabled a general increase of wages to be carried out, thus improving the condition of the classes living on manual labour. It may be added that the difficulty of tracing the effects of this great addition to the money stock is a most striking proof of the complexity of modern economic development. (5) The last point to be noticed is the very small influence exercised on the value of silver by the new gold. The gold price of silver in London rose only from 59½d. per oz. to 62½d. per oz.—i.e. between 4 and 5%. Hardly had the gold discoveries of 1848-1851 ceased to produce a decided effect when new silver mines of unusual fertility came into working. During the period immediately succeeding the gold discoveries the production of silver remained at an annual amount of from £8,000,000 to £9,000,000. This amount suddenly, about 1870, increased to £15,000,000, and remained at that amount for the next five years. More than half of the supply came from new mines opened in Nevada. This increased supply was accompanied by a marked depreciation in the gold price of silver, though the prices of commodities in countries having a silver standard did not rise. The disturbances resulting from the combined effect of the new silver and the diminution in the annual output of gold which began about 1870 and continued for nearly twenty years were the cause of much controversy and led to the propounding of novel monetary theories. *Bimetallism* came into prominence; and the modes of relieving trade depression caused by the fall in prices were keenly discussed. Before any monetary adjustment took place the situation again changed in consequence of a renewal of the Australian gold production, soon followed by the great gold discoveries in South Africa. The annual output of gold, which had fallen below £20,000,000, in 1884 rose rapidly to £60,000,000, and in 1908 reached the prodigious figure of over £80,000,000, and with the prospect of still larger yields in the near future. By this change the difficulties that had led to the agitations for "free silver" in the United States, and for "international bimetalism" in Europe and in India were removed, showing the close connexion between the production of the precious metals and the economic, especially the monetary, policy of all periods.

The modes of consumption of the precious metals—under which their use is included—are of equal importance with those of their production. Classed roughly, they come under three heads, viz. (1) their use as merchandise, (2) their use as money, (3) the "drain" to the East. With regard to the first, though precise data are not available, it may be said with some confidence that the demand for personal use tends, after society has made some progress, to decline in strength. The desire for adornment is not a keen one with most civilized persons; and so far as it exists, is gratified in other ways than by using silver or gold. For purposes of manufacture their use is large and increasing. The second head is that with which we are principally concerned. It is evidently connected with the need for metallic currency; and this again depends on the level of prices and the monetary organization, including in the latter the banking system. Currency requirements still form the largest part of the demand for the precious metals. Under the third head a remarkable exception to the tendency towards the equal diffusion of the precious metals is presented. For nearly two thousand years the movement of silver from west to east has been noticed. Humboldt has made the ingenious remark that the course of these metals is in the opposite direction to that of civilization, and history supports his view. During the middle ages the chief Eastern products used in Europe were luxuries, such as silk and spices, and silver was sent from Europe to pay for them. Eastern trade increased, owing to the discovery of the passage round the Cape of Good Hope, and the flow of silver became greater. Special circumstances have from time to time influenced the movement. Thus, the new supplies of gold in the middle of the last century caused by their action on the bi-metallic currencies of Europe an acceleration in the flow, the amount exported between 1851-1862 reaching £110,000,000. To this drain of silver a more recent one of gold has been added. India takes year by year a

considerable amount of gold bars, which may in the future have a monetary use, but up to the present appear to be hoarded or used for ornament. With the complete reconstruction of Eastern currencies that now seems probable there may come a decided change in the character of the demand. Another influencing condition is also undergoing change; the tendency to fix prices on a customary basis is bound to yield to the pressure of competition. The inevitable result will be to make the price level after with each influx of money, and thus to limit the demand for bullion through the action of the exchanges.

One of the technical features of the production of the precious metals should be noted, in consequence of its economic effect. Gold has more frequently been found near the surface; silver is usually obtained by deep mining. It follows that the amount of the former metal produced depends more on accidental circumstances, in contrast to that of silver, which is affected by the standard of mining skill. The mines of Nevada were exceptional in their possessing both metals and in nearly equal value. The gold-mines of South Africa have come to be worked at deep levels and therefore are technically in the same class as silver ones. In fact, there is a pronounced tendency all the world over towards the system of capitalistic working.

8. *Review of the History of Some Important Currencies.*—Monetary theory requires to be elucidated by the constant reference to history; just as in turn the history of currency has to be interpreted by the aid of general principles. Each country has its peculiar problems, which call for special treatment; though at the same time there is no way of avoiding the operation of those economic conditions and forces that are to be found in all countries. The first decisive fact that emerges from the vast material presented by the history of money is the tendency at most periods towards deterioration. In the time of purely metallic currency debasement is the most serious danger; when representative money has come into being extravagant issues of paper are chosen as the readiest way of evading the limits of a sound currency. It is perhaps too extreme to say that monetary history is altogether made up of accounts of debasements and over-issues. The truth is better expressed in the proposition that there has been a constant struggle between the influences that make for deterioration and those that give support to the maintenance of a good currency condition. There is also the cheering circumstance that in spite of much popular ignorance there has on the whole been a steady improvement in the treatment of monetary systems. Expert knowledge has more effect in the later than in the earlier periods. The crude expedients of the Tudors would not be tolerated in modern England. There is much fuller recognition of the danger of over-issue in paper money; and this is accompanied by greater care in the treatment of credit institutions in their relation to the modern *media* of circulation. It is also noteworthy that mere popular agitation has lost a great deal of its power, as shown in the failure of both the "soft money" and the "free silver" movements in the United States. On the other hand the tendency to accept scientific methods is illustrated in the treatment of the Indian currency question.

Greek Currencies.—As already noticed the political conditions of Greek life supplied a varied field for monetary experiments. Unfortunately the details are very incompletely known, and the subject of Hellenic money has not been sufficiently studied from an economic side. Certain broad facts are prominent. The Athenian use of silver as the standard substance, coupled with the later employment of gold to serve for an extra or commercial currency, is a characteristic feature. The exception of the standard by Solon appears in the light of an alterational revolutionary expedient. It amounted to the creation of a new standard unit—the Attic—which was imitated by other states, e.g. Corinth. Only one doubtful instance of debasement can be found in the subsequent history of Athens. This honesty in respect to the monetary standard seems on the whole to have prevailed in the Greek states. Some despots as Dionysius, issued adulterated coins, but these were isolated cases. The use of gold and silver in an amalgam, known as electrum, was an admissible device; it, however, had the evil effect of suggesting the use of poorer alloys.

Roman Money.—The history of money in Rome is rather different. Beginning with copper, the currency was changed into a double standard one by the introduction of silver (269 B.C.). Gold came in for commercial use with the extension of the Roman dominions, and copper was reduced to a token coinage. In the stress of the Punic Wars debasement was one of the financial devices of the magistrates. The conquest of the Greek territories brought about the regulation

of their currencies. Silver was prescribed as the money substance. The establishment of the empire led to the definite concentration of the right of coining in the sovereign; though concessions were made in various localities, where the smaller coinages were allowed to continue. But the principal interest of the money of the Roman Empire is due to the remarkable way in which it illustrates the tendency of despotic and bureaucratic rule to lower the condition of good administration. A long course of debasement is the characteristic aspect of the currency system. "Under the empire," we are told, "the history of the silver coinage is one of melancholy debasement. The most extensive frauds in connexion with money were perpetrated by the Romans." The gold *aureus*, which in the time of Augustus was one forty-fifth of a pound, was under Constantine only one seventy-second of a pound. The alloy in the silver coins gradually rose to three-fourths of the weight. Plated coins came into extensive use. The practice of debasement was in accordance with the theories of the jurists, who seem to have regarded money as simply the creature of the state, *i.e.* the personal ruler.

Medieval Money.—After the overthrow of the Western Empire, though the invaders were in the condition of what has been called "natural economy," the state in which money has not come into being, they soon were disposed to carry on the Roman tradition, and their rulers adopted some form of silver currency. With the temporary revival of the empire under Charlemagne there comes the effort to found a general standard money on the basis of the silver pound. From this new starting-point it is possible to trace the course of some of the leading currency systems of Europe. For purposes of illustration it will be sufficient to sketch the movements in England and France, which are typical of the general course of monetary development. The systems of these countries are moreover remarkable (1) in the contrasts that they present to each other, and (2) in the widespread influence that they have exercised on the monetary arrangements of other nations.

English Monetary History.—The English currency begins with the pound of silver (trov containing) as the standard unit, subdivided into 20 shillings, each containing 12 pennies. The only coin at first in use was the silver penny. This system, in force before the Conquest, is the direct descendant of the Carolingian system, and it continued without change until about 1276, when a slight depreciation was introduced by coining the pound into 243 pennies, instead of the original 240. This was the first of a series of changes, generally in the direction of lowering the weight of the coin. Two periods are remarkable for the operation of this tendency, viz. (1) the reign of Edward I., when the silver was debased by 20% in the period 1344-1351; and (2) the close of the reign of Henry VIII. and that of Edward VI., 1543-1552. In this short space of ten years the experiment of reducing the quality of the coinage by bringing the alloy up to three-fourths of the mass was practised for the only time in English history. The substitution of the pound Troy for the Tower pound in 1527 was accompanied by a lowering in weight which far exceeded the gain from the higher weight of the new pound (5760 instead of 5400 grains). The reformation of the silver coinage under Elizabeth (1560), and its definite settlement in 1601 on the basis of coining 62 shillings from the pound Troy also deserve mention. Turning to the gold currency, we find some gold pennies issued in 1257, probably in imitation of the issue of the Italian cities, which were due to the opening of eastern trade and the example of the Greek Empire, which had always retained its gold currency. The regular series of English gold coins begins in 1343, when Edward III. ordered the coinage of florins—the title is significant—at 50 to the Tower pound. The "noble" soon followed. In the sixteenth century the gold coinage in 1489. But gold was treated as a commercial money, to be used as subsidiary to the standard silver. Its value was therefore varied from time to time to meet the difficulty that local bimetallicism is certain to cause, in consequence of the undervaluing of one or other metal. During the 17th century the most noticeable monetary events are: the proposals for depreciation, of which the most remarkable was that of W. Lowndes (1652-1724), for lowering the standard by some 25%; the introduction of the guinea as the leading gold coin, and the frequent readjustment of the values of the two metals by proclamation. The great recoinage of 1696, carried out on the principles advocated by Locke, reformed the silver currency. In the 18th century the establishment of the guinea at 21s. by Newton's advice made the adoption of gold as the standard inevitable, since it was overvalued in an appreciable degree. The position of gold as the practical standard is clearly recognized by Adam Smith (1776) and is regarded as settled by Ricardo (1809). The full legal establishment of the present metallic currency took place in 1816, when the guinea made way for the present pound or "sovereign" and silver was formally reduced to the level of a token coinage, being slightly lowered by the coinage of the pound of silver into 66 shillings. Thus, by a course of development extending over 700 years, the English currency has been transformed from a crude silver standard system into one resting on gold, but employing both silver and representative money for the greater part of the actual work.

French Money: its Development.—Though the monetary system of Charlemagne soon disappeared in Germany and Italy, it con-

tinued in the part of his empire that became France. The extreme confusion of the time of his successors enabled the feudal lords to claim the right of coining. No less than 150 seigneurs are said to have exercised this power at the accession of the first Capet. With the growth of the royal authority the freedom of private coining was restricted, in order to reserve to the Crown the profitable right of seigniorage. Unfortunately the legitimate profit from this source was not sufficient to satisfy the wants of the royal treasury. Therefore French monetary history is marked by a long series of debasements, extending from the time of Philip I. to that of Louis XV. (1060-1774). In sharp contrast to English policy the tampering with the currency was persistent, so that Louis IX. was looked on as quite exceptional. "In later days his management of the royal mint was always appealed to as the equitable standard for the observance of his successors." Yet in his time the livre had been debased to less than one-fourth of its primitive level. The Hundred Years' War presented the occasion for still further degradation. At the accession of Louis XI. (1461) the livre had been brought down to one-fifth of its original value. The 16th century is equally an age of depreciation, no less than nineteen occurring between 1497 and 1602. Again, in contrast to the English system, the absolute monarchy continued the process of debasing the standard under Louis XIV., and the livre was only one-half what it had been under Henri IV. At the Revolution the decline had proceeded so far that the livre had been reduced to one seventy-eighth of its primitive value. The new spirit of reform produced an entire change. The franc was substituted for the livre at the equation: 80 francs, 81 livres. In fact, until the establishment of constitutional government the French people had to depend on popular violence to procure any temporary reform in their currency. Since the Revolution the course of development has been essentially orderly and regular. All through the time of the *ancien régime* silver was the principal money and the standard, as the use of the word "argent" as a synonym for money shows. Just as England got a gold currency by overvaluing gold, so did France get a silver one by overvaluing silver. Indeed, it may be said that the different ratios chosen by the two countries necessarily caused a reciprocal drain, affording a good example of the action of local bimetallic systems with different ratios between the two metals. A further result from the comparison of the systems of England and France is the greater maturity of the former. England gained an honest currency before France; she led the way in the adoption of the gold standard, while in her treatment of representative money she has held as decided a priority. The difference in economic conditions in the nations in part explains the contrast. There is no doubt that in both cases a high degree of development has been reached. Finally, it should be remarked, that as England has worked out in practice the system of composite legal tender, so has France, and with its monetary allies, been the first to show effectively the operation of the "limping standard" (*étalon boiteux*). Each nation has thus supplied a type, which recent monetary changes give evidence of having been used as the pattern for other less advanced countries.

9. *Some General Questions respecting the Constitution of Money.*—The consideration of the history of currency systems naturally suggests the general problems that the more advanced countries have had to encounter. Of these, some may be described as *formal*, *i.e.* they relate to the arrangement and the definition of coinage and standards. Others are in essence issues of principle involving the most complicated theoretical doctrines, on which there is even yet sharp differences of opinion between competent students of economics. In some instances an intermediate class may be found, *e.g.* the question of subdivision of the coins does raise some difficult matters of application; though it clearly belongs of right to the group of formal questions. But the distinction is a valid one. Whether a country should adopt the "gold standard" or prefer a "bimetallic" standard is obviously very different from the elementary points about units and the different classes of coins. We will therefore begin by noticing some of the characteristics that are found in all modern currencies and some of which are implied in the idea of money. Thus it is true that every currency system must be based on a *standard unit of value* which consists of a "fixed quantity of some concrete substance defined by reference to the units of weight or space." The English unit, for example, is the *pound*, which consists of a definite quantity of gold (123.27447 grs. standard fineness) while the French unit is the *franc* (composed of 5 grammes of silver nine-tenths fine). It is not necessary, though it is usually the case, that there shall be a coin corresponding to the standard unit, all that is needed is that the current coins shall be multiples or submultiples of the unit, or at the least easily reducible to it. The Portuguese *rei* is too small to be coined, and the pound of silver that formed the unit of the

early English and French currencies was too large. Quite distinct from both the actual coins and the unit of value is the *money of account*, though in practice it is usually identical with one of them. In Russia in early times the *rouble* was an imaginary money of account not coined, while the copper *copeck* was the unit of value. Connected with the distinction between the coins and the unit is the highly important one between *standard* and *token* money, the former being of full power for discharging debts, and in the case of most systems only of equal value to the metal out of which it is made, while the latter is rated at a nominal value higher than that of its material. The silver and copper coinage in England and the smaller coins in the Latin union are only tokens; in the case of English silver coins, the cost value is less than 40% of the nominal one. The French tokens are made of inferior fineness (835 per 1000) to the full tender silver. Two restrictions are applied to token issues: (1) they are only legally available to discharge small debts—in England silver is limited to the payment of 40s.; (2) they can be coined only by the permission of the state. Thus in England the Bank of England is the state agent for the silver coinage. The limitations are evidently required to prevent the expulsion of standard money, and to avoid the flooding of the circulation with coinage that is not needed for the purpose of the limited exchanges to which it is confined. Intermediate between standard and token currency are those forms of coinage that are free from the first limitation, but restricted by the second. They have this further point of resemblance to tokens in that their nominal value is higher than that of their material—the French 5-franc pieces and the Indian *rupees* are prominent examples. Similarly, the analogy between representative money and token money is deserving of attention, and suggests the desirability of the latter being regarded as in some respects a fiduciary issue, for which the issuing authority incurs responsibility.

A class of considerations already referred to (§ 5) requires explicit notice here, viz. the influence of popular sentiment on the character and forms of a country's currency. The fact that money has to circulate amongst all classes of society makes it indispensable that it should be suited to the wants and tastes and prejudices of the users. Many curious instances of preferences for particular coins or special forms of paper money can be given. The Austrian Maria Theresa dollar of 1780 is a favourite on the African coasts and has been frequently reused for use there. Reasons of convenience and of security combine with sentiment; as in the determined rejection of the U.S. "greenbacks" by the inhabitants of California during the inconvertibility of that currency. Recognition of the desires and tastes of the community is almost essential in carrying out any monetary reform. It is only by building on the habits and customs that have become established that improvements in the monetary system can be effectively completed. Not only is this the case with the disposition of the mass of society expedient; there is still greater need for taking account of the methods and interests of those sections of the business world that deal specially with money. A currency change that was bitterly opposed by the banking interest would certainly be difficult to introduce in either England or the United States; traders have great influence as to the forms of money that they will accept and facilitate the use of. In another aspect the study of the interest of dealers in the arrangement of the monetary system presents itself. One of the features that caused much surprise in the infancy of economic study was the disappearance of good coins from the circulation, while inferior coins remained in use indefinitely. To the first observers there seemed to be something perverse in the preference apparently shown towards debased or worn coins. In business transactions inferior articles are taken only at a lower price. The explanation is easily understood, when furnished; it consists in stating the difference between a commodity which is sought for its use, and money which is taken as merely a medium of exchange. Provided that coin is not too bad for further circulation it will be accepted without difficulty. Still less will there be any trouble if the difference is only in the relative value of two metals, such as silver and gold. The great majority of any population will give and take money without particularly observing it. It is enough if the coin conforms to the usual type. There exists, however, in all mercantile communities a class of dealers in money, who make a profit by selecting the best coins for exportation, or if two metals are in concurrent use, the coins of that metal which is undervalued in the proportion fixed. In the case of inconvertible paper issues the withdrawal is also for the purpose of hoarding to secure the profit expected when there is a high premium on bullion. The action of self-interest under these conditions produces an effect

which has been briefly formulated in the statement "that bad money tends to drive out good money." The proposition has been styled "Gresham's Law" (*g.v.*). Abundant illustrations of its working are available. The establishment of the English gold currency and the French *silver* one in the 18th century, already mentioned (§ 8), is an effective one. Quite as good is the transition of France from the silver to the gold currency form after the great gold discoveries of the middle of the 19th century. In truth it may be said that most of the monetary transitions have been due to the operation of the force indicated in Gresham's Law. The importance of the law lies in the warning that it gives against the attempt to reform a degraded currency by the issue of better money. Such "operations of the mint are," in Adam Smith's judgment, "somewhat like the web of Penelope." The caution holds equally in respect to the reform of a depreciated paper currency or to an effort to force an undervalued metal into circulation. The success of so many monetary reforms in the last forty years has been in great measure due to the better appreciation of the working of the principle. Its aid can also be obtained by setting up the suitable conditions; while it can be counteracted through the use of the principle of limitation, so clearly expounded by Ricardo. Some of the constituent parts of the French and American currencies rest altogether on the maintenance of an overvalued coinage, along with one of higher value by the limitation of the quantity of the former to the amount that can be employed without expelling the remaining part of the circulating medium from monetary use.

Another part of the structure of any currency is the scale on which its accounts, and by consequence the degree of its coins, are arranged. The pound, the shilling, and the penny in the older English system represented so many grades in the subdivision of value. All other currencies have the same need for divisions. The simplest scale would be what is called the "binary"; in which each coin is the half of the next higher, and double the one immediately below it. Most actual systems have series of coins on the binary scale. The penny, the halfpenny, the farthing; the 4s. piece, the florin, the shilling, the sixpence, the threepenny; at a higher level the sovereign, the half-sovereign, the crown, the half-crown, are English examples. The Latin and Scandinavian systems, as also Germany and the United States, have a purely binary coinage, save that the latter country adopts a purely binary scale. England in part retains the old "duodecimal" division in the relation of the shilling and the penny. Nearly all civilized nations have come to accept the system of *Decimal Coinage* (*g.v.*), though in their actual currencies they admit certain divergences from the strict decimal system. The convenience of having the monetary scale of accounts in accordance with the arithmetical scale will probably secure the ultimate victory of the decimal system everywhere, in spite of the objections to it on the ground of its having only two factors, 2 and 5—as against the larger number of factors in the decimal scale (2, 3, 4 and 6). The immense trouble involved in altering accounts and the difficulty of overcoming the hostility to change felt by the ordinary members of the community are the obstacles that prevent the adoption of the decimal system in England.

Connected with the composition of a currency and the scale on which it is based is the question of its relation to other currencies. From a very early time the conception of a money that should not be confined by a political limit appears to have existed. In fact until the state took over the control of money its more important forms had a wide diffusion. The talent, equated to the ox, is a prominent instance. Even when the city-states provided its particular coinage we can still perceive the circulation of the better coins outside their legal area. The effect on the Greek currencies has been noted above (§ 8). Under the Roman hegemony and the empire that arose out of it there was the equivalent of an international currency in the wide circulation of the coinages adopted from the conquered states. Such coins as the drachma and the denarius were of general use in the then civilized world. In later times the Carolingian silver currency for a short period supplied an international medium, which vanished in the confusion of the middle ages. Owing to the rise of national governments money became a national product confined to each state. It is only in the last sixty years that the idea of international money has been revived in a practical form. Unfortunately the revival was speedily checked by the reaction in favour of nationalism that followed the Franco-German War (1870-71) and by the controversies as to the proper standard. (See BIMETALLISM and MONETARY CONFERENCES for further discussion of this topic.)

10. *Typical Currency Systems: their Evolution and Governing Principles.*—At first sight it appears that the systems of currency are almost infinite in their variety. They have grown up in different nations under the influence of local conditions and reflect the customs of the particular society. But, underlying these superficial differences, there are certain general principles that permit of a grouping into a small number of clearly marked types. The classification, though resting on logical grounds, is very largely in conformity with the course of historical development.

Better forms have come into being as social progress has become more pronounced; and further improvement may be expected in the future. The condition of things when money is coming into being is characterized by the weighing or measuring of the substances used for aiding the course of exchanges. It has therefore been called the system of "currency by weight." In strictness, it is better regarded as the stage before the introduction of real money; and thus outside the field of currency systems proper. The simplest system of currency seems to be that in which the state coins ingots of different metals and allows them to circulate without assigning any ratio for their respective values. Such an inconvenient form is not likely to be of long continuance; but it has sometimes arisen at a later time through the introduction of foreign coinages. Holland at the end of the 16th century, Turkey down to the present day may be given as countries approaching this state. The title of "currency by tale" is Jevons's apt denomination for such a currency system. The next form in logical order is that in which a single metal is definitely appointed as the sole standard money. In early ages this is the most natural arrangement, and it has, therefore, been widely adopted. Silver has been the metal generally used in this way; as the instances previously given (§ 8) prove. The title of "single legal tender" system is the obvious one for this form. With the growth of transactions a difficulty soon presents itself. If the chosen metal is not of high value it is cumbersome for making large payments; if on the other hand its value is high, it is unsuitable for use in small transactions. Hence there almost inevitably follows the use of other metals, which are better suited for certain particular uses. Thus silver is at once too heavy and too light. To pay £1000 in silver at its present value would take 800 lb troy, while a silver penny would be under the convenient limit of size. Partly for these reasons, but also to a large extent through the persistence of currency by tale, we find that along with the standard money other kinds are brought into or retained in use. Copper long survives beside silver; and gold is employed for the more important commercial transactions. Public convenience leads to the valuation of these subsidiary forms of money, and in this easy manner another currency system—that of "multiple legal tender"—comes into being. Though, theoretically, several substances might be valued for use as money, in practice some kind of bimetalism is used, and generally gold and silver are the constituents of the system. Thus for over three centuries England had a currency in which the values of gold and silver were fixed from time to time by royal proclamation. France and the United States, as well as many other countries, have had long experience of national bimetalism. The great problem in such a form of currency has always been that of keeping the two metals in effective circulation. As the values of the precious metals fluctuate, the principle of Gresham's Law is exemplified by the expulsion of the undervalued one. Each change in the conditions of production or in the ratios fixed by other countries tends to disturb the balance and is harassing to trade. Local or national bimetalism comes to be unsustainable, and is replaced by other currency types. The most remarkable is that known as the "composite legal tender" system. Its object is to combine any advantages of multiple legal tender with the maintenance of the single standard principle. One metal is selected as the standard and is legal tender to any amount; other metals are utilized for the purpose of token currency. Thus in the system of the United Kingdom gold is the only standard coinage; but silver and copper are employed for the lower coins and for smaller payments. The establishment of this ingenious arrangement is rather the outcome of the circumstances that governed the English monetary situation in the 18th century than any refined considerations of theory; but its justification on grounds of principle is furnished in Lord Liverpool's *Coins of the Realm* (1805). The extent to which the system has been copied by other nations and the stability of the English currency are strong confirmations of its merits as a solution of currency difficulties. Though the composite legal tender system has been a decided success, it does not follow that it supplies the only

mode of dealing with the troubles that attend on the use of the local double standard. Other methods have been evolved from the monetary experiences of France and India, which take distinct forms according to the special features of the case. There is the currency system known as the "limping standard," the essence of which is the concurrent use of two metals, one being overvalued and coined only by state authority. The quantity of this favoured metal is necessarily limited in amount, to avoid depreciation or the ejection of the other metal from the circulation. It, however, has the position of money in the fullest sense, in that it is legal tender for any amount. The 5-franc pieces issued by the Latin union are the best known specimen of such coinage. In this case also the origin of the system was not theoretical, it was the result of the fall in the value of silver and the fear entertained by the French government that gold would be displaced by the cheaper metal. The temporary expedient of limiting the coinage of standard silver has developed into the maintenance during more than thirty-five years of the limping standard, which derives its name from the shortness of one limb of the currency's body. Equally suggestive for monetary theory is another phase or system, usually described as the "gold-exchange standard" system, in which the ordinary currency is of a metal coined only by the state, and so limited as to keep it in a prescribed value ratio to another metal (gold) which does not circulate, but acts as the standard of value. This variation on the limping standard has been produced by the effort of the Indian government to meet the embarrassment caused by the continuous fall in the gold value of silver. Under the pressure of falling revenue and of persons suffering from the rupee depreciation in gold, the limitation on silver coinage was first enacted (1803); to be followed some years later (1899) by the establishment of gold as the standard, with a definite parity assigned for the state silver issues. The success of the Indian experiment—for such it avowedly was—has led to its imitation by the American administration in the Philippine Islands and by Mexico. It may be looked on as the natural product of the condition in which the single legal tender system is proving unfit, while the material for the composite legal tender system is wanting. The employment and theoretic explanation of these methods of currency adjustment mark the greatest advance made in monetary science and practice in recent years. Whether the limping, or the gold-exchange standards will be permanent forms is difficult to determine; but they are beyond doubt of much importance in meeting the risks of a period of transition. In any case they are entitled to recognition as distinct forms of currency organization, resting on a scientific basis.

The types presented by purely metallic currencies can be considered by themselves for the purpose of theoretical exposition. In actual working they are now affected by the existence of representative money. The state issues paper money which may be either convertible or inconvertible, or if it refrains from so doing, the banks take up the task and supply a medium of exchange in the form of notes, or by a later development through providing for the use of cheques by their customers. An inconvertible paper currency has some pronounced affinities with overvalued metal; a duly regulated issue of this kind is quite on the lines of the gold-exchange system, and the difficulties of the two forms are very similar. But, just as the cruder systems of metallic money have gradually given way to the higher ones, so it may be said that the grosser forms of mismanagement in representative money are being removed, notwithstanding the recurrence of such monetary crises as that of 1907 in the United States. The great instance of government paper money is the United States notes, known, as "greenbacks," which are fixed at the amount of \$346,681,016. The most prominent case of bank issue of notes is that of the Bank of France, with somewhat over £200,000,000 in circulation. Examples of the cheque currency are more difficult to state in quantitative shape; as the constituent parts are continually being created and cancelled, but the clearing-house returns give some idea of its extent in England. The figure for 1909 was

£13,525,446,000. It seems highly probable that the next stage in improvement will be the extension of currency based on credit, after the Anglo-American pattern, to the other commercial countries of the world. But this movement can only be slow, it will not affect Eastern countries. For a long time they will remain in the metallic currency stage, with the moderate use of a guaranteed note circulation.

There are several plans which have been advocated as superior to any of the systems actually in use. Most of these schemes are undeserving of notice; a few, however, claim attention on the ground of theoretical or practical importance. The most conspicuous is that known as "international bimetalism," which was designed to obviate the evils said to result from the demonetization of silver and the overflow of the established ratio between the precious metals. Its central idea was the creation of a monetary league, composed, if not of all, at least of the leading states (the larger the number the better), the members being bound to coin any amount of gold and silver at an agreed ratio. By such an agreement an adequate field for the use of both metals would be provided, and fluctuations in the relative value of silver and gold would be completely prevented. The expulsion of the cheaper metal would be impossible, owing to the absence of any place to which it could be driven. Variations in the production of the precious metals would act on both metals, not on one. Another plan for meeting the same set of difficulties is the composition of the monetary standard by taking assigned amounts of both metals in combination as the unit—say 1 oz. of gold with 10 oz. of silver. The title "symmetallism" has been given to this ingenious mode of trying to obtain a more stable standard than that afforded by the employment of a single metal. Amongst the many devices that the use of paper money has suggested the most noticeable

are those that aim at the replacement of metallic money by some other basis. The socialist conception of a "labour note" may be paralleled by the idea of "commodity notes," resting on a development of the clearing system. Viewed from the practical standpoint it may be said that the double standard in any form is condemned by the course of events; it has been defeated by the gold standard. In respect to the other proposed methods there is the almost insurmountable difficulty of making them in any way sufficiently popular to overcome the resistance that they must necessarily encounter. This criticism holds good, quite apart from the objections of principle to which they are all open, in very different degree it is true. The influence of custom in relation to money can never be set aside. For this reason it is certain that very gradual change is the only possible kind of monetary reform that can hope for success. It is essential to preserve as far as possible the old surroundings and avoid the intrusion of novel devices. The adoption of what Sir R. Giffen has styled "fancy monetary standards" is reserved for a distant future.

In the course of the development of monetary systems important theoretical problems have presented themselves. For the middle ages the great question was the best mode of securing an honest metallic currency. At the beginning of the modern national states the problem of keeping a parity between silver and gold was the most serious issue which each state attempted to solve independently. With the rise of credit there followed debate on the proper management of paper money in its various forms, which has not yet been completely closed. But the tendency in the last fifty years has been to concentrate attention on the meaning and due constitution of the monetary standard. In particular, the difficulties that result from an alteration in general prices, and the inconvenience to foreign trade from different currency standards have been exhaustively considered. It is therefore desirable to present in a concise form what

appears to be the outcome of these discussions. The first established conclusion is the impossibility of obtaining an absolute and invariable standard. The best that can be hoped is a near approximation by balancing the elements of fluctuation. The construction of the most suitable monetary system is a work of practical adjustment. The influence of the actual conditions, which has been already emphasized, helps to indicate the limits of profitable inquiry. In respect to the metallic basis the choice is between the single standard—gold or silver, and some combination of these. The single standard of silver can be set aside, though it has had influential supporters. On the other hand the only combinations that need be considered are those indicated above by the titles "bimetalism" and "symmetallism."

The theory of the gold standard rests on the principle that one metal is a better criterion for measuring values than two, since the fluctuations that occur by the substitution of one metal for the other are certain to be disturbing. There is the further difficulty that no ratio can be permanently fixed between two metals, as their values must vary with the alterations in production. The inherent simplicity, and, so to speak, "naturalness," of the single standard is best realized by embodying it in gold, which is universally desired, of high cost and yet found in sufficient amount to discharge the money work of the standard. The verdict of history is appealed to as confirming the theoretic presumption, for gold has been gaining ground from century to century. The struggles to reverse this process have only made it more pronounced (see MONETARY CONFERENCES). Most of the objections to the gold standard rest on ideas which are the support of other economic fallacies. The attempts to supersede it involve the rejection of the rule of economic law. The foundation of the doctrine of "bimetalism" is the theory that the value of money is determined, not simply by cost of production, nor by unregulated supply and demand, but by the action of regulated demand, in conjunction with the actual conditions of production. States are the demanders of metal for monetary use, and by adjusting that demand they can powerfully influence the course of production, especially as the cost at which either

TABLE I.—Estimated Production of Gold and Silver, 1493-1900.

Period.	No. of Years.	Amount in Kilos.		Value in Millions of Francs.		Ratio of Value of Gold to Silver.
		Gold.	Silver.	Gold.	Silver.	
1493-1520	28	162,400	1,316,000	560	292	11.3
1521-1544	24	171,800	2,165,000	592	481	11.2
1545-1580	36	273,000	10,976,000	940	2,439	11.5
1581-1600	20	147,600	8,378,000	508	1,862	11.9
1601-1620	20	170,400	8,458,000	587	1,880	13.0
1621-1640	20	166,600	7,872,000	572	1,749	13.4
1641-1660	20	177,400	7,326,000	608	1,628	13.8
1661-1680	20	183,200	6,740,000	638	1,498	14.7
1681-1700	20	213,300	6,838,000	742	1,320	15.0
1701-1720	20	256,400	7,112,000	883	1,380	15.2
1721-1740	20	381,600	8,624,000	1,314	1,916	15.1
1741-1760	20	492,200	10,663,000	1,695	2,370	14.8
1761-1780	20	414,100	13,055,000	1,426	2,900	14.8
1781-1800	20	353,800	17,581,000	1,222	3,906	15.1
1801-1810	10	177,800	8,942,000	616	1,987	15.6
1811-1820	10	114,400	5,408,000	394	1,202	15.5
1821-1830	10	142,200	4,606,000	490	1,023	15.8
1831-1840	10	202,900	5,964,000	699	1,325	15.7
1841-1850	10	247,600	7,804,000	886	1,734	15.8
1851-1855	5	987,900	4,431,000	3,402	985	15.4
1856-1860	5	1,030,000	4,325,000	3,549	1,066	15.4
1861-1865	5	925,600	5,506,000	3,188	1,223	15.3
1866-1870	5	959,500	6,695,000	3,305	1,488	15.6
1871-1875	5	869,500	9,847,000	2,985	2,188	16.0
1876-1880	5	862,100	12,251,000	2,960	2,522	17.8
1881-1885	5	745,700	14,308,000	2,579	2,640	18.6
1886-1890	5	796,800	17,362,000	2,743	2,832	21.1
1891	1	196,600	4,266,000	677	669	20.9
1892	1	220,900	4,893,000	761	659	23.7
1893	1	236,700	5,165,000	815	640	26.5
1894	1	272,200	5,121,000	941	512	32.6
1895	1	301,500	5,234,000	1,045	544	31.6
1896	1	307,700	4,908,000	1,049	549	30.7
1897	1	356,900	5,013,000	1,215	499	34.0
1898	1	433,200	5,413,000	1,486	530	35.2
1899	1	463,500	5,225,000	1,590	520	33.9
1900	1	384,600	5,377,000	1,325	556	33.4
1493-1850	358	4,752,100	149,828,000	16,368	33,292	14.05
1851-1885	35	6,380,000	57,563,000	21,968	12,052	16.3
1886-1900	15	3,069,600	53,671,000	13,647	8,510	27.2
1493-1900	408	15,101,700	260,461,000	51,983	53,854	14.72

gold or silver is obtained varies with the productiveness of the poorest mine in working. Thus by directing consumption, states are controlling production, and therefore—within limits—fixing the relative value of the two metals. This power has been shown in the stability of the ratio during the continuance of the French double-standard (1803-1873). The possibility of maintaining a given ratio being thus established, the argument proceeds to show the advantages of the system. (i.) It secures the concurrent use of the precious metals and avoids throwing all the money work on gold. (ii.) Greater stability in value must be expected, since the fluctuations of either metal will be compensated by those of the other. At the worst the variation can only be as great. (iii.) The larger stock of money tends to keep up prices to the benefit of trade; for falling prices hamper production. (iv.) The fixed ratio provides a stable par of exchange between silver-using and gold-using countries; though universal bimetallism would remove this dis-

tinction. (v.) The establishment of a world-currency would be facilitated by allowing both metals a well-defined relation. This enumeration of the heads of the "bimetallic" case shows that its working depends on the area of its operation. It must be "international" and the states composing the union must be "great powers" in the monetary sense. Otherwise, their action would be comparatively ineffective. The crucial difficulty has been the determination of the common ratio. The risk of failure in carrying out the policy has proved a deterrent to such great powers as England and Germany, who are in possession of the gold standard. On the theoretic side the chief weakness of bimetallism has been its failure to supply any clear account of the limits within which states can regulate the ratio of gold to silver. If the ratio 15:5:1 can be set up why should not the ratio 100:1, or that of equality? Its practical failure has resulted partly from political conditions, partly from the removal of most of the difficulties which it was

TABLE II.—The Coinage Systems of Continental Europe, exhibiting the gold and silver coins, their weight, fineness, remedy and approximate value in English and United States money.

Coins.	Material.	Weight in Grammes.	Milli-metrical Fineness.	Rem. p. 1000.		Approximate Money Value.	
				In Fineness.	In Weight.	Englsh.	United States.
AUSTRIA HUNGARY —							
100 Kreuzer	20 Kronen piece	Gold	6'775067	000'0	2'0	2'3	£ s. d. 4 0 5
1 Gulden	"	"	6'875134	000'0	2'0	2'3	8 4 4
5 Gulden	"	"	6'45101	000'0	2'0	2'3	0 15 10 3 86
4 " "	"	"	3'22580	000'0	2'0	2'3	0 7 11 1 93
4 Ducat	"	"	13'0610	086'1	—	—	1 17 7 0 53
1 " "	"	"	3'4990	086'1	—	—	0 9 5 2 20
1 Krone	"	Silver	5'0	—	—	—	0 10 0 2 20
1 Dollar	"	"	28'0668	833'3	—	—	—
(Maria Theresa)	"	"	34'5914	900'0	2'0	2'3	0 3 11 0 06
2 Gulden	"	"	12 1157	900'0	2'0	2'3	0 1 14 0 48
20 Kreuzer	"	"	2'666	900'0	2'0	2'3	0 0 5 5 20
10 " "	"	"	1'666	400'0	2'0	2'5	0 0 2 0 5
BELGIUM. See FRANCE.							
DENMARK —							
20 Kroner piece	Gold	8'606572	000'0	1'5	1'5	1 1 1 1 36	
10 " "	"	4'303286	000'0	1'5	1'5	0 11 0 1 20	
2 " "	Silver	15 000	800'0	3'0	3'0	0 2 2 0 5 27	
1 Krone	"	7 500	800'0	3'0	3'0	0 1 14 0 3 3	
20 Ore piece	"	5 000	600'0	3'0	3'0	0 0 6 0 1 3	
10 " "	"	4 000	600'0	3'0	3'0	0 0 5 0 1 2	
25 " "	"	2 420	600'0	3'0	3'0	0 0 3 0 6 13	
10 " "	"	1 450	400'0	3'0	3'0	0 0 1 0 2 21	
FRANCE —							
100 Centimes	Franc piece	Gold	32'59886	000'0	2'0	2'0	3 19 3 10 10
100 " "	"	"	16'29943	000'0	2'0	2'0	1 10 7 0 3 1
10 " "	"	"	6'45191	000'0	2'0	2'0	15 10 2 0 81
10 " "	"	"	3'22580	000'0	2'0	2'0	7 11 1 9 3
5 " "	"	"	1'61290	000'0	2'0	2'0	3 11 4 0 9 6
5 " "	Silver	25'0	000'0	2'0	2'0	0 3 11 4 0 9 6	
1 " "	"	5'0	835'0	3'0	3'0	0 0 9 0 0 10	
50 Centimes	"	"	2'5	835'0	—	—	0 0 4 10 0 10
20 " "	"	"	1'0	835'0	—	—	0 0 2 0 4 0
GERMANY —							
100 Pfennig	20 Mark piece	Gold	7'061954	000'0	—	—	0 10 7 4 2 78
10 " "	"	"	3'084777	000'0	—	—	0 0 9 4 1 10
5 " "	"	"	1'091259	000'0	—	—	0 0 4 10 1 19
5 " "	Silver	27 777	000'0	—	—	0 4 10 1 1 10	
10 " "	"	11 111	000'0	—	—	0 1 11 4 0 4 8	
20 " "	"	5 555	000'0	—	—	0 0 5 11 2 24	
50 Pfennig	"	2 777	000'0	—	—	0 0 0 1 2 12	
20 " "	"	1 111	000'0	—	—	0 0 2 1 0 6	
GREECE * See FRANCE.							
ITALY. See FRANCE.							
NETHERLANDS —							
100 Guilder	100 Guilder piece	Gold	6'720	000'0	1'5	2'0	£ s. d. 0 16 0
1 Guilder.	"	"	3 350	000'0	1'5	2'0	0 8 2 4 2
2 " "	"	"	25 000	045'0	2'5	2'5	0 4 3 1 0
5 " "	"	"	10 000	045'0	2'5	2'5	0 1 8 5 40
10 " "	"	"	5 000	045'0	2'5	2'5	0 10 0 20
25 Cents	"	"	3 375	040'0	2'5	2'5	0 0 10 0 10
10 " "	"	"	1 400	040'0	2'5	2'5	0 0 5 0 4
5 " "	"	"	0 685	040'0	2'5	2'5	0 0 1 0 2
NORWAY. See DENMARK.							
PORTUGAL *—							
1000 Reis	Crown or \$100	Gold	17 735	016 666	2'0	2'0	4 4 5 10 80
Milrei.	Half-Crown or \$5	"	8 867	016 666	2'0	2'0	1 2 2 1 5
One-fifth Crown or \$2	"	"	3 547	016 666	2'0	2'0	0 8 10 2 10
One-tenth Crown or \$1	"	"	1 773	016 666	2'0	2'0	0 4 5 1 8
500 Reis	"	Silver	12 500	016 666	2'0	3'0	0 2 2 1 0 54
100 " "	"	"	5 000	016 666	2'0	3'0	0 0 10 0 21
100 " "	"	"	2 500	016 666	2'0	3'0	0 0 5 11 0 20
50 " "	"	"	1 250	016 666	2'0	3'0	0 0 2 11 0 5
RUMANIA. See FRANCE.							
RUSSIA *—							
100 Copcks	15 Rouble piece	Gold	12 902	000'0	nil	2'0	1 11 8 7 7 2
100 Copcks	(Imperial)	"	10 " "	8 601	000'0	—	2 0 1 1 3 1 54
10 " "	(i-Imperial)	"	5 300	000'0	—	2 0	0 15 10 3 86
5 " "	"	"	4 301	000'0	—	2 0	0 10 8 3 5 7
1 " "	"	Silver	10 005	000'0	—	2'0	0 2 1 1 0 25
1 " "	"	"	9 997	000'0	—	2'0	0 1 0 1 0 15
20 Copcks	"	"	4 008	000'0	—	2'0	0 1 6 1 0 23
15 " "	"	"	3 500	000'0	—	—	0 0 5 0 1 11
10 " "	"	"	2 600	000'0	—	—	0 0 3 0 7
5 " "	"	"	1 700	500'0	—	—	0 0 2 1 0 5
SERBIA. See FRANCE.							
SPAIN. * See FRANCE.							
SWEDEN. See DENMARK.							
SWITZERLAND. See FRANCE.							
TURKEY *—							
100 Piastres	Medjidie or Lira	Gold	7 216	016 666	2'0	2'0	0 18 0 0 4 40
100 " "	"	"	3 608	016 666	2'0	2'0	0 0 0 0 20
100 " "	"	"	1 804	016 666	2'0	2'0	0 0 4 0 1 10
20 Piastres	"	Silver	24 055	830'0	3'0	3'0	0 3 7 0 88
10 " "	"	"	12 027	830'0	3'0	3'0	0 1 0 4 0 44
5 " "	"	"	6 013	830'0	3'0	3'0	0 0 10 0 2 2
1 " "	"	"	3 005	830'0	3'0	3'0	0 0 5 0 1 0 4
1 " "	"	"	1 502	830'0	3'0	3'0	0 0 2 0 2 4

* Inconvertible paper currency.

¹ Present system introduced in 1894, in place of the system adopted in 1870. The Maria Theresa dollar is only used as a commercial money in Levantine trade.

² The system of the Scandinavian union came into force on the 1st of January 1875. It is based on gold monometallism.

³ The coinage system of France came into force on the 6th of May 1799. It was extended to the countries forming the Latin union in 1865; it has been adopted by Greece, Rumania, Servia and Spain. It is the most widely extended system in Europe. The Austrian 8 and 4 gulden pieces were equivalent to the 20 and 10 franc pieces. In 1879 it was estimated that the system was used by populations amounting to 148,000,000. In its origin a double standard (with ratio of 15:5:1) it has become a limping standard by the limitation of the silver coinage. The unit is the same value all through the union, but receives different names in different countries. The titles are: in France, Belgium and Switzerland, *franc* and *centime*; in Italy, *lira* and *centesimo*; in Greece, *drachme* and *lepta*; in Rumania, *lew* and *ban*; in Servia, *dinar* and *para*; in Spain, *peseta* and *centesimo*.

⁴ The German coinage law came into force on the 1st of January

1875. It was modelled on the English system, but it is only in the last few years that the old silver has been completely withdrawn.

⁵ The Dutch standard has been changed more than once. In 1847 a silver standard was introduced, and retained till 1872, the unit being the silver guilder. In 1875 the free coinage of gold was decreed; silver coinage having been restricted since 1872. Thus the limping standard is in force.

⁶ The nominal standard of Portugal is gold. The English sovereign is legal tender at 4500 reis.

⁷ The Russian currency until 1897 was nominally a silver standard one; but really was inconvertible. The currency was improved in 1885; and in 1897 the gold standard was adopted, provision being made for the withdrawal of the paper money. Finland, which had a currency on the French model, is now being compelled to accept the Russian currency.

⁸ The Spanish coinage was assimilated to that of the Latin union in 1871. Spain, differing from the other countries of the group, coins a 25 peseta piece.

⁹ The Medjidie coinage was introduced in 1844. English sovereigns circulate at 125 piastres; 20 franc pieces at 100 piastres.

intended to meet by the subsequent economic development. The proposal for a joint standard formed by using a unit in which the two metals are combined has the advantage of escaping the risk of failure to maintain the ratio, for it makes the employment of both silver and gold essential. Its influence in causing stability is also likely to be greater; but it is open to the danger that a shortage of one metal would not be compensated by the abundance of the other. The further advantage that it does not need international agreement (for each country could settle its own combination) is counterbalanced by the strangeness of the plan and by its necessitating the use of representative money. The suggestion of

"gold" coins on the model of the Greek electrum would hardly be acceptable.

11. *The Present Money Systems of the World: Changes of the last Half Century.*—The facts as to the money of the leading countries of the world are given in Tables II. and III. It is, however, necessary to explain the way in which this position has been reached by the reforms of the last fifty years. Since 1860 the alterations in standards and in coin denominations have been of a very extensive nature. England is one of the

TABLE III.—Currencies of the more important non-European States.

Coins.	Material.	Weight in Grammes.	Milligram. Fineness.	Rem. p. 1000.		Approximate Money Value.	
				In Fineness.	In Weight.	English.	United States.
A.—NORTH AMERICA.							
BRITISH DOMINIONS — 100 Centms = 1 Dollar.							
MEXICO — 100 Centavos = 1 Dollar (Piastre).							
10 Dollar piece.	Gold	8,333	900/0	15	30	£ 2 d.	8 c.
5 "	"	4,166	900/0	15	50	10	3 2 49
1 "	Silver	27/073	902/7	3/0	36	0 0 4	0 49
50 Cent piece.	"	12/5	800/0	4/0	0	1 0 4	0 25
20 "	"	5/0	800/0	4/0	0	0 5	0 10
10 "	"	2/5	800/0	4/0	0	0 2 1/2	0 5
UNITED STATES — 100 Cents = 1 Dollar.							
20 Dollar piece (Double Eagle)	Gold	35/436	900/0	2/0	1 4	2 6	—
10 Dollar piece (Eagle)	"	16/718	900/0	2/0	2	1 3	—
5 Dollar piece.	"	8/359	900/0	2/0	1	0 7 1/2	—
3 "	"	5/015	900/0	2/0	2	0 12 1/4	—
2 1/2 "	"	4/179	900/0	2/0	1	0 10 4	—
1 "	"	1/671	900/0	2/0	3/0	0 4 1 1/2	—
1 "	Silver	26/729	900/0	3/0	5	0 4 1 1/2	—
50 Cent piece.	"	12/500	900/0	3/0	5	0 2 0 1/2	—
25 "	"	6/250	900/0	3/0	0	0 0 4	—
10 "	"	2/500	900/0	3/0	0	0 5	—
5 "	"	1/250	900/0	3/0	0	0 2 1/2	—
3 "	"	0/802	750/0	3/0	0	0 11	—
B.—SOUTH AMERICA.							
ARGENTINE REPUBLIC — 100 Centavos = 1 Dollar (Piastre).							
20 Peso piece.	Gold	33/333	900/0	—	4	1 8	19 04
10 "	"	16/666	900/0	—	2	0 10	9 07
5 "	"	8/333	900/0	—	1	0 5	4 98
1 "	Silver	25/000	900/0	—	0	3 1 1/2	0 00
BRAZIL — 1000 Reis = 1 Milrei.							
20 Milreis piece.	Gold	17/929	916/6	—	2	2 10 1/2	10 21
10 "	"	8/964	916/6	—	1	1 5	5 45
2 "	Silver	25/000	916/6	—	0	4 5	1 0
1 "	"	12/250	916/6	—	0	2 2 1/2	0 55
1/2 "	"	6/375	916/6	—	0	1 1	0 27

* Inconvertible paper currency.

¹ Until 1906 there was no mint in Canada. English and American coins circulate. The standard is gold (£1 = 4.866 dollars). There were formerly different methods of counting, viz. English sterling, Halifax currency and Canadian sterling; the respective ratios being 100:120:108.

² The Mexican currency has been entirely altered in its standard by the legislation of 1905. The gold-exchange system has been brought into force. The old-established dollar, which is called *piastre*, is reduced so as to represent a ratio of about 33:1.

³ The dollar was introduced in 1787 as the unit. In 1792 the ratio of gold to silver was fixed at 1 to 15. This valuation undervalued gold, consequently silver became the standard. In 1834 the ratio was altered to 1 to 16, and it was again changed in 1837. Owing to the critical situation created by these efforts to aid silver, the repeal of the Sherman Act was carried in 1893. Since then the chief problem has been to maintain an effective gold reserve.

⁴ The Argentine currency is, in practice, one of inconvertible paper. The gold coins were altered in 1881. The old South American *onza* weighed 27 grammes, was 875 fine and worth £3, 4s. 6d.

Coins.	Material.	Weight in Grammes.	Milligram. Fineness.	Rem. p. 1000.		Approximate Money Value.	
				In Fineness.	In Weight.	English.	United States.
CHILE — 20 Peso piece (Condor) = 1 Peso.							
10 "	Gold	17/082	916/6	—	—	£ s. d.	8 c.
5 "	"	8/591	916/6	—	—	0 15	0 7 20
1 "	"	2/995	916/6	—	—	0 7	6 1 80
50 Cent piece	Silver	20/0	815/0	—	—	1 6	0 36
20 "	"	10/0	815/0	—	—	0 9	0 18
10 "	"	5/0	815/0	—	—	0 4	0 7
5 "	"	2/5	815/0	—	—	0 2	0 4
COLOMBIA — 100 Centavos = 1 Peso.							
50 Cent piece (Condor)	Gold	32/258	900/0	—	—	3 19	31 19 30
50 Cent piece	"	16/129	900/0	—	—	1 19	8 9 05
20 "	"	8/065	900/0	—	—	0 19	10 4 52
10 "	"	4/032	900/0	—	—	0 9	11 9 05
5 "	Silver	25/0	920/0	—	—	0 3	1 1 06
20 Centavos	"	5/0	815/0	—	—	0 0	0 19
10 "	"	2/5	815/0	—	—	0 0	5 10
5 "	"	1/25	815/0	—	—	0 0	2 1 0
PERU — 10 Soles = 1 Libra.							
10 Soles (4 Libras)	Gold	7/688	916/6	2/0	1	0	4 86
5 "	"	3/904	916/6	2/0	1	0	2 43
1 Sol piece	Silver	25/0	900/0	3/0	2	0	0 48
50 Centavos	"	12/5	900/0	3/0	1	0	2 24
25 "	"	6/25	900/0	3/0	0	2 1/2	0 5
ECUADOR. See PERU.							
C.—ASIA.							
INDIA (BRITISH) — 4 Pie = 1 Pice. 1 Rupee piece.							
4 Pice = 1 Anna.	Silver	11/665	916/6	—	—	0 1	4 0 32
16 Annas = 1 Rupee.	"	5/832	916/6	—	—	0 0	8 10
(15 Rupees = 1 Found).	"	2/910	916/6	—	—	0 0	4 0 8
	"	1/458	916/6	—	—	0 0	2 0 4
JAPAN — 100 Sen = 1 Yen.							
20 Yen piece.	Gold	16/666	900/0	1/0	2	1 0	0 9 07
10 "	"	8/333	900/0	1/0	1	0	0 9 8
5 "	"	4/166	900/0	1/0	4	0 10	3 2 40
50 Sen	Silver	13/478	800/0	3/0	35	0	1 0 1 25
20 "	"	6/391	800/0	3/0	5	0	5 10
10 "	"	2/695	800/0	3/0	6	0	2 1 0 5

⁵ The Brazilian currency is greatly depreciated. It is derived from the Portuguese.

⁶ The Chilean coinage was reformed in 1895, when the gold standard was adopted, and the system brought into relation to the English one. Two Chilean *Condors* (20 peso pieces) being equal to £3.

⁷ In 1904 Colombia adopted the gold standard by taking the equivalent of the U.S. dollar as the unit; but the inconvertible paper is the main currency; and the old coins pass as commercial money.

⁸ After attempting a parity with the Latin union, and passing through a period of inconvertible paper, Peru has adopted the English gold standard and coinage, but keeps her own silver denominations. ⁹ The silver standard was reformed in India in 1835, with the use of the gold mohurs. The latter was demonetized in 1853. In consequence of the fall in the gold value of silver, the Indian mints were closed to the coinage of silver, otherwise than by the government, in 1893. The amount of currency was so limited as to bring the rupee to the value of 1s. 4d. On the realization of this position, English sovereigns were made legal tender at the ratio of 15 rupees = 1 sovereign. India has, by these measures joined the class, now becoming numerous, of gold-exchange standard countries.

¹⁰ The old Japanese currency consisted of gold cobangs and silver itzibus, with a ratio of 4 to 1. This antique system was replaced in 1871 by a double-standard one on the French plan, the ratio being 16:17:11. The system passed first into one of silver monometallism; and then became one of inconvertible paper. The great reform of 1897, aided by the Chinese War indemnity, placed the currency on the gold basis.

few countries that has not found change desirable. France has reorganized her token coins (1864), entered into the Latin union (1865) and adopted the limping standard in 1874. Germany has completely transformed the monetary system hitherto existing in the German States (1873). The Scandinavian union has been set up (1875). Holland has changed her system more than once. Still later, Austria-Hungary (1892) and Russia (1897) have come over from the silver standard with the practical use of inconvertible paper to new currencies on the gold basis. In America the United States, after a series of monetary experiences, has made the gold dollar its standard unit, though the silver complication still exists. Mexico has succeeded in establishing a gold-exchange standard at such a ratio as to induce the import of gold. British India has had its rupee currency put into relation to the English gold unit, and has been followed by the Straits Settlements. Japan first abandoned its ancient currency (1871). It then adopted a double standard system which became in practice a silver one and later passed into inconvertible paper. Finally, it has (1897) established a composite legal tender system on the gold basis. The Dutch Indies have the gold-exchange standard on the same plan as British India.

Remarks.—In addition to the tabular statements, the following points respecting the currencies of less advanced countries may be indicated. Though there is a tendency to establish the money of the mother-country in colonies, some of the British possessions, acquired by conquest, have kept their former currency. There has been a widespread movement in the backward countries of the world towards reforming their money; chiefly by setting up some line of connexion with the gold standard. In South and Central America the dollar has been retained as the unit; but the movement for co-ordination with the French system has ceased. The English standard has been preferred as a model by Chile and Peru. In Asia the currency of the Philippines has been reorganized under American control. China is considering monetary reform, and Siam has made progress in the direction of the gold-exchange standard. Probably the most defective currencies are now those of Turkey and her tributary states.

BIBLIOGRAPHY.—The literature on the subject of money has been well described as "almost measureless." The list of writers who have contributed to it begins with Aristotle, and includes such famous names as Copernicus, Locke and Newton. A full enumeration would fill a volume of no slight size. All that can be done here is to give a short classified list of the most serviceable books.

I. Economic text-books: English and American—J. S. Mill, *Principles of Political Economy* (London, 1848; new ed. by Ashley, 1909); Sidgwick, *Principles of Political Economy* (London, 1883; 3rd ed., 1901); J. S. Nicholson, *Principles of Political Economy* (3 vols., London, 1893-1901); F. A. Walker, *Political Economy* (New York, 1883; 2nd ed., 1887, often reprinted); A. T. Hadley, *Economics* (New York, 1896); E. R. A. Seligman, *Principles of Economics* (New York, 1905); H. R. Scudder, *Introduction to Economics* (New York, 1904; 3rd ed., 1908). French: M. Chevalier, *Cours d'économie politique* (vol. iii. "La Monnaie," Paris, 1850); P. Leroy-Beaulieu, *Traité d'économie politique* (4 vols., Paris, 1896); C. Gide, *Cours d'économie politique* (Paris, 1909). German: H. Mangoldt, *Grundriss der Volkswirtschaftslehre* (2nd ed., Stuttgart, 1871); G. Schönbeger, *Handbuch der politischen Oeonomie* (Tübingen, 1882; 4th ed., 1904); G. Schmoller, *Grundriss der allgemeinen Volkswirtschaftslehre* (Leipzig, 1900-1904). The Dutch work by N. G. Pierson has been translated into English with the title *Principles of Economics* (London, 1902).

II. Special treatises on "Money": W. S. Jevons, *Money and the Mechanism of Exchange* (London, 1875); F. A. Walker, *Money* (New York, 1878); J. S. Nicholson, *Money and its Problems* (London, 1888; 6th ed., 1902); G. S. Conant, *The Principles of Money and Banking* (2 vols., New York, 1905); A. Arnaune, *La Monnaie, le crédit et le change* (Paris, 1894; 2nd ed., 1902); A. de Foville, *La Monnaie* (Paris, 1907); C. Knies, *Geld und Kredit* (Berlin, 1873-1879); G. F. Knapp, *Staatliche Theorie des Geldes* (Leipzig, 1905).

III. Works on special questions: See BIMETALLISM; BANKING; and MONETARY CONFERENCES for writings on the problems of the standard and depreciation. For the history of money—F. Lenormant, *La Monnaie dans l'antiquité* (Paris, 1876); W. A. Shaw, *History of Currency, 1252-1804* (London, 1895). For the history of the English currency, besides the works on the numismatic side—Lord Liverpool, *Coins of the Realm* (1805; reprinted 1880). For America—W. G. Sumner, *History of American Currency* (New York, 1874). On the production and consumption of money, masters, &c. See Jacob, *Production and Consumption of the Precious Metals* (2 vols., London, 1831); and A. Del Mar, *History of the Precious Metals* (London, 1880). Technical details in Tate's *Cambist* (many editions). (C. F. B.)

MONEY-LENDING, the lending of money on usury (*q.v.*). The business of the professional money-lender is one which, as

tyranny and abuse are likely to appear, all countries have at different times endeavoured to regulate. In England the lessons of experience have shown that the abuses of this business are best regulated by a system of registration coupled with relief to debtors against harsh and unconscionable bargains. Other countries however still appear to cling to the belief that it is wisest to fix a maximum rate of legal interest. Thus in Germany the commercial code fixes the legal rate of interest on commercial transactions at 5%. Moreover in that country traders can demand interest on commercial debts from the day on which the debts fall due. In France, again, the Code fixes the rate of interest on ordinary loans at 5%, and on commercial transactions at 6%. In the United States of America the law relating to the lending of money on usury varies in the different states. All the states have what is called a "legal rate" of interest; and when no rate of interest is specified in the contract between the parties, there is a presumption that the borrower has agreed to pay the legal rate. This legal rate varies from 5% in Louisiana to 8% in Wyoming; in the Eastern states it is generally 6%. Some of the states have usury laws giving relief to borrowers in cases where circumstances have compelled them to agree to extortionate rates; but other states have no such laws, except that a contract in writing is invariably required in all cases where the "legal rate" is exceeded.

Practically every form of investment in which a man is capable of indulging involves the lending and borrowing of money, the interest exacted being the profit which the lender receives for the use of his capital. The existence of the professional lender, as apart from the ordinary facilities for borrowing money on good security, is obviously due to the fact that it is not every borrower who is in a position to give good security for a loan. Where the security is bad the market is narrowed; the individuals who are prepared to lend the money on merely personal security require a high rate of interest.

The first people to practise the profession of money-lending in England regularly were the Jews, and the business has remained largely in their hands, though they are in the habit of trading under assumed names. The Norman and Angevin kings were fully alive to the advantages which accrued to the people through borrowing at usury from the Jews, but they were also alive to the advantages which they themselves were able to reap by extorting from the Jews the wealth which the latter had acquired from the people. The Jews were regarded as the king's serfs, and squeezing them was but a popular form of taxing the people. Indeed in the reign of Henry II. the Scaccarium Judaeorum was established as a separate branch of the exchequer and used for the purpose of filling the royal coffers. The English people on the other hand were not so prone to foster the money-lending business. Sections 10 and 11 of Magna Carta provided that when a person died owing money to a Jew no interest should accrue during the minority of the heir, and further that the widow should be entitled to her dower, and any children who were minors should be provided with necessaries before the repayment of the loan. Then followed a large number of statutes known generally as the Usury Laws (see also USURY). The first of these was passed in 1235 (20 Hen. III. c. 5). The acts were directed to restrain the lending of money at usurious rates. The earlier ones in some cases prohibited the lending of money on usury at all, as in a statute of Jewry of the reign of Edward I.; but the later statutes were chiefly confined to limiting the rate of interest. Thus 21 Jac. I. c. 17 declared void all contracts where the interest was more than 8%. In 1818 a select committee of the House of Commons was appointed to consider the Usury Laws and in 1841 a similar committee of the House of Lords was appointed. As a result an act was passed in 1854 (17 & 18 Vict. c. 90) whereby all the existing laws against usury were repealed.

The question whether any interest is payable or not, and also the amount of such interest, depends on whether the parties to the transaction have expressly or impliedly agreed to the payment of interest by the borrower; for apart from such agreement no interest can lawfully be demanded on a loan.

Although in general there is no limit on the amount of interest which a borrower may agree to pay, equity has always been ready to grant relief from unconscionable bargains. This equitable relief is still available, though it is not so wide as the relief now given to borrowers under the Money-lenders Act 1900. This act provides that where proceedings are taken in any court by a money-lender for the recovery of money lent, and there is evidence which satisfies the court that the interest charged on the loan, or the amounts charged for expenses, inquiries, fines, bonus, premium, renewals, &c., are excessive, and that in either case the transaction is harsh and unconscionable, or is otherwise such that a court of equity would grant relief, the court may reopen the transaction and take an account between the money-lender and the person sued, and may, notwithstanding any statement or settlement of account or any agreement purporting to close previous dealings and create a new obligation, reopen any account already taken between them and relieve the person sued from payment of any sum in excess of the sum adjudged by the court to be fairly due in respect of such principal, interest and charges as the court, having regard to the risk and all the circumstances, may adjudge to be reasonable.

The Money-lenders Act of 1900 was passed in consequence of grave abuses which had arisen. It had been the practice of a certain class of lender to trade under a variety of names; so that under one name the same individual would lend money to a person who borrowed from him under another name; the second loan would be spent in liquidating the first, and the borrower finding it always easy to obtain more money would continue borrowing until he became hopelessly involved. The act struck at the root of this pernicious system by providing that every money-lender, as defined by the act, must register himself as such, under his own or usual trade name, and in no other name, and with the address, or all the addresses if more than one, at which he carries on his business of a money-lender. If a money-lender fails to register himself, or if he carries on a money-lending business otherwise than in his registered name, or in more names than one, or elsewhere than at his registered address, he is liable on summary conviction to a fine, not exceeding one hundred pounds. For the purposes of the act "money-lender" is defined as including every person whose business is that of money-lending, but it does not include pawnbrokers, in respect of business carried on by them under the Pawnbrokers Act, Registered Friendly, Loan or Building Societies, corporate bodies incorporated or empowered by special act of parliament to lend money, persons *bona fide* carrying on the business of banking or insurance, or *bona fide* carrying on any business not having for its primary object the lending of money, or bodies corporate for the time being exempted from registration by order of the Board of Trade.

The act is not confined to providing for the registration of money-lenders and for the reopening of harsh and unconscionable bargains. A check is placed on false representations and promises made with the intention of inducing a borrower to enter into a loan transaction. If any money-lender, or any manager, agent or clerk of a money-lender, or any person being a director, manager or other officer of a corporation carrying on the business of a money-lender, by any false, misleading or deceptive statement, representation or promise, or by any dishonest concealment of material facts, fraudulently induces, or attempts to induce, any person to borrow money or to agree to the terms on which money is to be borrowed, he is declared by the act to be guilty of a misdemeanour and is liable on indictment to imprisonment with or without hard labour for a term not exceeding two years, or to a fine not exceeding five hundred pounds, or to both.

The act further provides that if any one for the purpose of earning interest, commission, reward or other profit sends or causes to be sent to a person whom he knows to be an infant any circular or other document which invites the person receiving it to borrow money or to apply to any person or at any place with a view to obtaining information or advice as to borrowing money, he shall be liable, if convicted on indictment, to imprisonment with or without hard labour, or to a fine, or to both imprisonment and fine. If any such circular or document sent to an infant purports to issue from any address named therein or indicates any address as the place at which application is to be made with reference to the subject matter of the document, and at that place there is carried on any business connected with loans, every person who attends such place for the purpose of taking part in or assisting in the

carrying on of such business will be deemed to have sent or caused to be sent such circular or document, unless he proves that he was not in any way a party to and was wholly ignorant of the sending of such document. Moreover, by section 5 of the Money-lenders Act 1900, where any proceedings are taken against the senders of these circulars to infants, if it is proved that the person to whom the document was sent is an infant, the person charged will be deemed to have been cognisant of the fact unless he proves that he had reasonable grounds for believing the infant to be of full age. Under the act of 1892 this shifting of the burden of proof only occurred if the circular had been sent to any person at any university, college, school or other place of education.

As for the recovery of money lent; if the loan is not tainted with illegality or immorality, or made for a purpose contrary to public policy, the amount may be recovered by a common law action. Where an intending borrower breaks his agreement to borrow, specific performance will not be granted, and the damages recoverable must be measured by the loss sustained through the breach and not by the sum agreed to be lent (*The South African Territories, Limited v. Wallington* (1897), 1 Q.B. 692).

AUTHORITIES.—On equitable relief to borrowers reference should be made to Bellot and Willis's *Bargains with Money-lenders*. On the law under the act of 1900 see Hastings's *Law relating to Money-lenders and Unconscionable Bargains*; and Edmondson's *Money-lenders Act 1900*. For the taxation of the Jews in the middle ages, see Bridges, *The Jews of Europe in the Middle Ages*, and *Customs of the English Constitution*. For American law relating to Usury see Stimson's *American Statute Law*, and the statutes of the various states. For France and Germany, see the codes of those countries. (C. G. ALA.)

MONFORTE, or **MONFORTE DE LEMOS**, a town of north-western Spain, in the province of Lugo, on the Cabe, a small right-hand tributary of the Sil, and at the junction of the railways from Tuy and Astorga to Corunna. Pop. (1900), 12,912. Monforte is built on a hill surmounted by a ruined medieval citadel; it contains an ancient Benedictine monastery converted into a hospital, a Jesuit college, and a fine Renaissance parish church, besides several convents and palaces of the Leonese nobility. Monforte has manufactures of soap and linen, and some trade in timber and livestock.

MONGE, GASPARD (1746-1818), French mathematician, the inventor of descriptive geometry, was born at Beaune on the 10th of May 1746. He was educated first at the college of the Oratorians at Beaune, and then in their college at Lyons—where, at sixteen, the year after he had been learning physics, he was made a teacher of it. Returning to Beaune for a vacation, he made, on a large scale, a plan of the town, inventing the methods of observation and constructing the necessary instruments; the plan was presented to the town, and preserved in their library. An officer of engineers seeing it wrote to recommend Monge to the commandant of the military school at Mézières, and he was received as a draftsman and pupil in the practical school attached to that institution; the school itself was of too aristocratic a character to allow of his admission to it. His manual skill was duly appreciated: "I was a thousand times tempted," he said long afterwards, "to tear up my drawings in disgust at the esteem in which they were held, as if I had been good for nothing better." An opportunity, however, presented itself: being required to work out from data supplied to him the "défilément" of a proposed fortress (an operation then only performed by a long arithmetical process), Monge, substituting for this a geometrical method, obtained the result so quickly that the commandant at first refused to receive it—the time necessary for the work had not been taken; but upon examination the value of the discovery was recognized, and the method was adopted. And Monge, continuing his researches, arrived at that general method of the application of geometry to the arts of construction which is now called descriptive geometry (see **GEOMETRY, DESCRIPTIVE**). But such was the system in France before the Revolution that the officers instructed in the method were strictly forbidden to communicate it even to those engaged in other branches of the public service; and it was not until many years afterwards that an account of it was published.

In 1768 Monge became professor of mathematics, and in 1771 professor of physics, at Mézières; in 1778 he married Mme Horbon, a young widow whom he had previously defended in a very spirited manner from an unfounded charge; in 1780 he was appointed to a chair of hydraulics at the Lycium in Paris

(held by him together with his appointments at Mézières), and was received as a member of the *Académie*; his intimate friendship with C. L. Berthollet began at this time. In 1783, quitting Mézières, he was, on the death of É. Bézout, appointed examiner of naval candidates. Although pressed by the minister to prepare for them a complete course of mathematics, he declined to do so, on the ground that it would deprive Mme Bézout of her only income, from the sale of the works of her late husband; he wrote, however (1786), his *Traité élémentaire de la statique*.

Monge contributed (1770-1790) to the *Mémoires* of the Academy of Turin, the *Mémoires des savants étrangers* of the Academy of Paris, the *Mémoires* of the same Academy, and the *Annales de chimie*, various mathematical and physical papers. Among these may be noticed the memoir "Sur la théorie des déblais et des remblais" (*Mém. de l'acad. de Paris*, 1781), which, while giving a remarkably elegant investigation in regard to the problem of earth-work referred to in the title, establishes in connection with it his capital discovery of the curves of curvature of a surface. Léonhard Euler, in his paper on curvature in the Berlin *Mémoires* for 1760, had considered, not the normals of the surface, but the normals of the plane sections through a particular normal, so that the question of the intersection of successive normals of the surface had never presented itself to him. Monge's memoir just referred to gives the ordinary differential equation of the curves of curvature, and establishes the general theory in a very satisfactory manner; but the application to the interesting particular case of the ellipsoid was first made by him in a later paper in 1795. A memoir in the volume for 1783 relates to the production of water by the combustion of hydrogen; but Monge's results had been anticipated by Henry Cavendish.

In 1792, on the creation by the Legislative Assembly of an executive council, Monge accepted the office of minister of the marine, but retained it only until April 1793. When the Committee of Public Safety made an appeal to the savants to assist in producing the *matériel* required for the defence of the republic, he applied himself wholly to these operations, and distinguished himself by his indefatigable activity therein; he wrote at this time his *Description de l'art de fabriquer les canons*, and his *Avis aux ouvriers en fer sur la fabrication de l'acier*. He took a very active part in the measures for the establishment of the normal school (which existed only during the first four months of the year 1795), and of the school for public works, afterwards the polytechnic school, and was at each of them professor for descriptive geometry; his methods in that science were first published in the form in which the shorthand writers took down his lessons given at the normal school in 1795, and again in 1798-1799. In 1796 Monge was sent into Italy with C. L. Berthollet and some artists to receive the pictures and statues levied from several Italian towns, and made there the acquaintance of General Bonaparte. Two years afterwards he was sent to Rome on a political mission, which terminated in the establishment, under A. Masséna, of the short-lived Roman republic; and he thence joined the expedition to Egypt, taking part with his friend Berthollet as well in various operations of the war as in the scientific labours of the Egyptian Institute of Sciences and Arts; they accompanied Bonaparte to Syria, and returned with him in 1798 to France. Monge was appointed president of the Egyptian commission, and he resumed his connexion with the polytechnic school. His later mathematical papers are published (1794-1816) in the *Journal* and the *Correspondance* of the polytechnic school. On the formation of the Senate he was appointed a member of that body, with an ample provision and the title of count of Pelusium; but on the fall of Napoleon he was deprived of all his honours, and even excluded from the list of members of the reconstituted Institute. He died at Paris on the 28th of July 1818.

For further information see B. Brissou, *Notice historique sur Gaspard Monge*; Dupin, *Essai historique sur les services et les travaux scientifiques de Gaspard Monge* (Paris, 1819), which contains (pp. 162-166) a list of Monge's memoirs and works; and the biography by F. Arago (*Œuvres*, t. ii., 1854).

Monge's various mathematical papers are to a considerable extent reproduced in the *Application de l'analyse à la géométrie* (4th

ed., last revised by the author, Paris, 1819); the pure text of this is reproduced in the 5th ed. (revue, corrigée et annotée par M. Liouville) (Paris, 1850), which contains also Causs's Memoir, "Disquisitiones generales circa superficies curvas," and some valuable notes by the editor. The other principal separate works are *Traité élémentaire de la statique*, 8^e édition, conforme à la précédente, par M. Hachette, et suivie d'une note &c., par M. Cauchy (Paris, 1846); and the *Géométrie descriptive* (originating, as mentioned above, in the lessons given at the normal school). The 4th edition, published shortly after the author's death, seems to have been substantially the same as the 7th (*Géométrie descriptive* par G. Monge, suivie d'une théorie des ombres et de la perspective, extraite des papiers de l'auteur, par M. Brissou (Paris, 1847). (A. C.)

MONGHYR, a town and district of British India, in the Bhalgaur division of Bengal. The town is on the right bank of the Ganges, and has a railway station, with steam ferry to the railway on the opposite bank of the river. Pop. (1901), 35,880. In 1195 Monghyr, a fortress of great natural strength, appears to have been taken by Mahommed Bakhiyar Khilji, the first Moslem conqueror of Bengal. Henceforth it is often mentioned by the Mahommedan chroniclers as a place of military importance, and was frequently chosen as the seat of the local government. After 1590, when Akbar established his supremacy over the Afghan chiefs of Bengal, Monghyr was long the headquarters of his general, Todar Mal; and it also figures prominently during the rebellion of Sultan Shuja against his brother, Aurangzeb. In more recent times Nawab Mir Kasim, in his war with the English, selected it as his residence and the centre of his military preparations. Monghyr is famous for its manufactures of iron: firearms, swords, and iron articles of every kind are produced in abundance but are noted for cheapness rather than quality. The art of inlaying sword-hilts and other articles with gold and silver affords employment to a few families.

The DISTRICT OF MONGHYR has an area of 3922 sq. m. The Ganges divides it into two portions. The northern, intersected by the Burhi Gandak and Tiljuga, two important tributaries of the Ganges, is always liable to inundation during the rainy season, and is a rich, flat, wheat and rice country, supporting a large population. A considerable area, immediately bordering the banks of the great rivers, is devoted to permanent pasture. Immense herds of buffaloes are sent every hot season to graze on these marshy prairies; and the *ghi*, or clarified butter, made from their milk forms an important article of export to Calcutta. To the south of the Ganges the country is dry, much less fertile, and broken up by fragmentary ridges. Irrigation is necessary throughout the section lying on the south of the Ganges. The population in 1901 was 2,068,804, showing an increase of 1.6% in the decade. The principal exports sent to Calcutta, both by rail and by river, are oil-seeds, wheat, rice, indigo, grain and pulse, hides and tobacco; and the chief imports consist of European piece-goods, salt and sugar. The southern portion of the district is well provided with railways. At Lakhisarai junction the arc and chord lines of the East Indian railway divide, and here also starts the branch to Gaya. At Jamalpur, which is the junction for Monghyr, are the engineering workshops of the company. In the early years of British rule Monghyr formed a part of Bhalgaur, and was not created a separate district till 1832.

See *Monghyr District Gazetteer* (Calcutta, 1909).

MŌNG NAI (called by the Burmese and on most old maps *Mone*), one of the largest and most important of the states in the eastern subdivision of the southern Shan States of Burma. The state of Kéng Tawng (Burmese Kyaing Taung) is a dependency of Mōng Nai. It lies approximately between 20° 10' and 21° N. and between 97° 30' and 98° 45' E., and occupies an area of 2717 sq. m.; pop. (1901), 44,252, of whom more than five-sixths are Shans. The Salween river bounds it on the east. The main state and the sub-state of Kéng Tawng consist of two plains with a ridge between them. There is much flat rice bottom, but a considerable portion consists of gently undulating plainland. In the central plain rice is the only crop. Outside this considerable quantities of sugar are produced. Tobacco of a quality highly esteemed by the Shans is grown in the Nawng Wamp circle at an altitude of 3100 ft. above sea-level; and

ghanatpet (a leaf used for cigar-wrappers), and garden crops are the chief produce otherwise. In the outlying tracts quantities of coarse native paper are manufactured from the bark of a species of mulberry, and much is exported to other parts of the Shan States.

MONGOLIA, a vast territory belonging to the Chinese empire, the administrative limits of which cannot be determined with precision. On the N. it is bounded by the frontier of Russia, beginning at Mount Kalas or Kanas (40° 5' N., 87° 40' E.) in the Altai, and running to the S.E. corner of Transbaikalia in the vicinity of Dalai-nor, thus having on the N. the Siberian provinces of Tomsk, Yeniseisk, Irkutsk and Transbaikalia. In the E. the boundary line which separates Mongolia from Manchuria runs past Dalai-nor and Lake Buir, crossing the Great Khingan in 47° 30' N., towards Tsihsihar in Manchuria; then, crossing the Nonni river, it strikes the Sungari at Khulan-chen, where it turns westwards up this river, reaching the Shara-muren river in 123° 30' E. From China proper on the S. Mongolia is separated by a line running in a south-westward direction up the Shara-muren and across the Mongolian plateau to the bending of the Hwang-ho or Yellow river in about 40° N. and 110° 30' E. Thence the boundary describes a sinuous line, following the Great Wall, and thus includes the Ordos (Ho-tau) and Alashañ (Si-tao), and reaches its most southern point in 36° 40' N., 104° 20' E. Thence it turns north-west, following the Great Wall for over 300 m.; it then crosses the plateau so as to separate Mongolia from the Chinese province of Sin-Kiang (*Han-su-sin-tsiang*, which includes the Nan-shan highlands and eastern Turkestan), and from Dzungaria, reaching the Chinese or Ektagh Altai in 46° 30' N., 92° 50' E. From that point the boundary coincides with the main water-parting of the Altai Mountains till it reaches Mount Kalas.

Geographically, Mongolia may thus be said to occupy both terraces of the great plateau of east Asia, which stretches in the south of Siberia, between the Saïlughem range of the Great Altai and the Great Khingan—with the exception of the Dzungarian depression. From Manchuria and China it is separated by the border ridge of the plateau—the Great Khingan, while in the south-west it runs up to the foot of the high northern border ridges of the Tibetan plateau—an artificial frontier separating it from east Turkestan and Dzungaria. Broadly speaking, Mongolia may be divided naturally into three parts: (1) north-western Mongolia, which occupies the high terrace of the plateau; (2) the Gobi, in its wide sense, covering the lower terrace of the plateau, together with a slightly more elevated and better-watered zone along the western slope of the Great Khingan and its south-western continuation; and (3) south-eastern Mongolia, on the eastern slope of the Khingan. Of these parts, the second is considered in detail under the heading Gobi.

North-western Mongolia was formerly represented as a region intersected by lofty mountain chains. It appears, however, from

Russian explorations during the last third of the 19th century, that it has all the characteristics of an elevated plateau of north-west Mongolia, which covers an area of nearly 370,000 sq. m., the altitude nowhere falls below 2370 ft. (Ubsa-nor); and the area round this lake which has less than 3000 ft. of altitude covers only 6600 sq. m. The remainder of this extensive territory ranges at altitudes of 3000 to 4500 ft., even in the bottoms of the river valleys and in the lower plains; while the ridges which constitute the water-partings rise about 2000 ft. above the general level of the plateau. Along the south-western border of this division of Mongolia a gigantic border-ridge, the Ektagh (or Mongolian) Altai, runs in an E.S.E. direction from the Russian Altai to 99° E., and probably continued even farther by the Arta-bogdo, the Saikhat and other ranges as far as the northern loop of the Yellow river. The passes across the Ektagh Altai lie at altitudes of 10,000 ft. in the north-west and

9250 ft. in 93° 20' E.; farther east they become much lower. But while its southern foot stands in the Dzungarian trench, i.e. at altitudes of 1550 ft. only near Lake Ulungur, and at 3000 ft. in 94° E., its north-eastern foot rests on the high plateau, i.e. at 4260 ft. at Kobdo, 5410 at Oshku, 4070 at Orok-nor on the route from Kiahtsa to Su-chow, and so on. Thus the Ektagh Altai is a true border-range—that is, a lofty and steep escarpment facing the Dzungarian depression, and a gentle and relatively short slope towards the plateau.

In the same way the Kentei (or Gentei) Mountains, as they are called, to the north of Urga, and the Yablonoï Mountains of Transbaikalia, separate the higher terrace of north-west Mongolia (drained by the tributaries of the Selenga) from the lower terrace of the Gobi, which is drained by the upper tributaries of the Onon and the Kerulen, both belonging to the basin of the Amur. It is also very probable that the Tannu-ola Mountains north-east of Ubsa-nor, and the Khangai Mountains between Ulyssatay and the upper Orkhon, both running W.N.W. to E.S.E., form another slightly higher terrace of the same great plateau of north-west Mongolia, upon which Lake Kosogol lies, at an altitude of 5320 ft. On this vast upper terrace even the bottoms of the river valleys are at altitudes of 4200 to 5500 ft., with one single exception—the narrow gorge of the Khua (Khi)-khem, or upper Yenisei; while the highest pass across the Tannu-ola Mountains is 7090 ft.; though the others are much lower. The conception of north-west Mongolia as a region filled with mountain ranges radiating from the Altai must thus be abandoned. It is a massive swelling of the earth's crust, representing the northern counterpart of the plateau of Tibet. This massive swelling is cut into basins by the Ektagh Altai and the eastern T'ien-shan, by the relative depression of Tarbagatai and Dzungaria, 1500 to 3000 ft. in altitude; while to the south of the eastern T'ien-shan comes the Tarim depression, from 2200 to 3000 ft. high, and occupying an area of about 88,000 sq. m. Neither of these "depressions," however, penetrates beyond 94° E., and on the route from Kiahtsa to Su-chow, in 100° E., there is only one single place (42° N.) in which the altitude drops as low as 3300 ft.; everywhere else it varies between 4000 and 5000 ft.

Lakes and Rivers.—North-west Mongolia is well watered, and has in its western part a group of lakes which possess no outlet to the sea, being in reality the rapidly desiccated remains of what were formerly much larger basins. The chief of them is Ubsa-nor (2370 ft.), which receives the large river Tes. It lies in the middle of a large plain, and has to the west of it a smaller but much higher lake, Urga-nor, besides several smaller ones. Farther south on the same wide plain lie the sister lakes Kirghiz-nor and Airyk-nor, which receive another large river, the Dzarp'hyn, and the Kungui. Many small lakes are scattered over the plain to the east of them. A third group of lakes occur in the neighbourhood of Kobdo. The Kobdo river, which rises in the Dain-nor (7060 ft.) in the Ektagh Altai, winds in great curves across the plateau, and enters Lake Kara-usu (3840 ft.), which also receives the Buyantu, an outflow from Lake Kobdo, and is connected by a small river with another large lake, Durga-nor, situated a score of miles to the east. There are also many smaller lakes fed by the glaciers of the Saïlughem (Acht-nor, 4650 ft., and Uryu-nor), and others scattered through the Ektagh Altai. The largest lake of this region is, however, Kosogol (Khubtsu-gul), which lies at an altitude of 5320 ft., close to the Russian frontier, at the foot of the snow-clad Munku-sardyk. Besides the rivers mentioned there are also rivers belonging to the basin of the Yenisei (Khua-ur Khi-khem, Bei-khem and Bontkemchik); while yet others belong to the Selenga, a river formed by the junction of the Eder with the Telghir. The Selenga receives the Orkhon, at the head of which remarkable inscriptions were discovered in the end of the 19th century, and cleverly deciphered by Professor V. Thomsen of Copenhagen.¹ The rivers which flow down the outer slopes of the border-ridges become lost in the Gobi shortly after entering it.

A very large portion of north-west Mongolia constitutes a high plain, 3000 to 4200 ft. in altitude, which penetrates from the south-east in a north-western direction between the Ektagh Altai and the Khangai Mountains. It has a true Mongolian character, i.e. it is covered with gravel, and presents the appearance of a dry prairie devoid of forests. This same character is also exhibited by the bottoms of the broad valleys, while the more elevated and hilly portions of the territory, especially on their northern slopes, are covered with larch, cedar, pine and deciduous trees belonging to the Siberian flora; where the forests fall they are marshy or assume the character of Alpine meadows, e.g. in the Khangai, the Tannu-ola, and on the slopes of the border-ridges. The greater part of the region is covered with excellent pasture. The forests decrease as one travels southwards. For instance, while both slopes of the Sayans are covered with forests, the Tannu-ola and the Khangai Mountains have woods on their northern faces only, and the Ektagh Altai is quite devoid of woods, even on its northern slope.

Climate.—Owing to its high altitude, north-western Mongolia is very cold, and the severity of the winter is intensified by the prevalence of cold but dry north-western winds. The north-east wind brings more moisture. In summer the warm winds come from the south and south-east, but having first to cross the Gobi,

¹ See V. Thomsen, *Inscriptions de l'Orkhon* (Helsingfors, 1900)

they are dried before they reach north-western Mongolia. The yearly amount of rain at Urga (altitude 4350 ft., at the northern foot of the Kentei Mountains) is only 9¼ in., and the average temperatures are: year 27° F., January -18°, July 64°; a minimum of -35° F. has been observed. The climate of Ulyasutai (4500 ft.) may be taken as typical, its average temperatures being: year 31.6°, January -12°, July 66°.

The geology is still very imperfectly known. The plateau is built up of granites, gneisses and crystalline schists of Archean and probably Primary age. Coal is known to exist to the south-east of Kobdo, in the Tannu-ola, and in the basin of the Yenisei, but its age is unknown (fresh-water Jurassic?). Graphite and some silver ores have also been found.

The fauna is a mixture of the Siberian and the Daurian—the latter penetrating up the valleys of the Selenga basin. The chief towns of north-west Mongolia are Urga, Ulyasutai, Kobdo and Ulanokom.

South-eastern Mongolia is the part of Mongolia which lies on the eastern slope of the Great Khingan Mountains, entering like a wedge between the lower course of the Nonni river and the middle Sungari. Chiefly owing to the dryness of climate, its physical characteristics are similar to those of

South-eastern Mongolia. Mongolia proper, except that the altitude of the plains is much lower. This portion of Mongolia is also much better watered, namely, by the Khatsyr, the Lao-ho and the Shara-muren, all flowing from the Khingan Mountains eastwards, and the last making the frontier between Mongolia and the Chinese province of Chihli.

Population.—The population of the whole of Mongolia is estimated at about 5,000,000. It consists of Mongols—Eastern Mongols and Kalmucks in the west—various Turkish tribes, Chinese and Tunguses. The Mongols proper, with the exception of those who inhabit north-west Mongolia, may be divided into northern and southern (more properly north-western and south-eastern) Mongols. The former, belonging to the Khalkas, occupy the Gobi and the regions of the Kentei Mountains and Khingan Mountains, while the latter, divided into numerous minor branches, roam over south-eastern and southern Mongolia. The principal occupation of the Mongols is cattle-breeding, and Russian writers estimate that on an average each *uyrta*, or family, has about 50 sheep, 25 horses, 15 horned cattle and 10 camels. The transport of goods is their next most important occupation. It is calculated that 100,000 camels are used for the transport of tea only from Kalgan to Siberia, and that no less than 1,200,000 camels and 300,000 ox-carts are employed in the internal caravan trade. Agriculture is only carried on sporadically, chiefly in the south, where the Mongols have been taught by the Chinese. Various domestic industries are also carried on. The trade is chiefly concentrated at Urga, Ulyasutai and Kobdo in north-west Mongolia; Kalgan, Kuku-khoto, Kuku-erghi, Dolon-nur and Biru-khoto in southern and south-eastern Mongolia; and at Kerulen in the north-east.

Administration.—Before the Manchurian conquest the Mongols were governed by their own feudal princes, who regarded themselves as being descended from seven different ancestors, all, however of the same kin. Each group of principalities constituted a separate *aimak*, and each principality a separate *hoshun*. Under Manchu rule the *aimaks* became converted into the same number of military corps, each composed of so many *hoshuns* as military units. Each of these again was divided into *sumuns* or squadrons, each containing 150 families. In case a *hoshun* contained more than 6 *sumuns*, every 6 of the latter were organized into a regiment—*tsalan*. Four Manchu *tsian-tsuns*, or governor-generals, acted as chiefs of the troops, and the prince of each *aimak*, nominated from Peking, was considered as the lieutenant or assistant of his respective Manchu chief. The *hoshuns* were subject to their own princes, each of whom had a military adviser, generally a Manchu. Their internal or tribal affairs were in the hands of the princes, those which concerned a whole *aimak* being settled at gatherings of the princes under the eldest of them, named khan. This organization was maintained by the Manchu rulers, the khan being elected from among the princes, and the latter having each an adviser, *tsalackchi*, nominated from Peking.

Mongolia is now administered by a *Lifan Yuen* or superintendency with headquarters at Peking. Excluding the territory to which the name of Mongolia is geographically applied, but which is included in the provinces of Shansi and Chihli, Mongolia is divided into inner and outer divisions. Inner Mongolia,

lying between the desert of Gobi, China proper and Manchuria, is divided into 24 *aimaks*. There are two military governors-general and two commissaries of the viceroy of Chihli, having control of civil matters. One of each pair of officials is stationed at Kalgan, and the other at Jehol. Outer Mongolia, the remainder of the territory, has 4 *aimaks*, three of which are under hereditary *khans*. There is a Chinese imperial agent at Urga.

AUTHORITIES.—The following works in Russian are the most important: Prievalsky, *Mongolia and the Land of the Tanguts* (1875), and his *Third and Fourth Journey* (1883 and 1888); G. N. Potanin, *Sketches of North-West Mongolia* (1881-1883); *The Tangut-Tibet Border of China and Central Mongolia* (1893 sec.); V. Pevetsoff, *Sketch of a Journey to Mongolia, &c.* (Omsk, 1883); D. Izpoldáev, *Towns of North Mongolia* (1880); *Mongolia and the Mongols* (1896 and 1899); and the article "Mongolia" in *Russian Encycl. Dictionary*, vol. six (1896); G. and M. Grum Grzimalo, *Description of a Journey to Western China* (1898-1899); V. Pevetsoff and K. Bogdanovitch, V. I. Roberovsky and P. K. Kozloff, *The Tibet Expeditions* (1886-1902); V. Obrucheff, *Central Asia, Northern China and the Nan-shan* (1900-1901); Z. Matusovsky, *Geogr. Descr. of Chinese Empire* (1888); Batorsky, *Essay of a Military and Statistic Sketch* (1890); A. Woyeikoff, *Climates of the Earth* (1884); *Mongolia and Kham* (Imperial Russian Geographical Society's Expedition, 1899-1901). See also R. Pumpelly, *Geol. Researches* (Washington, 1886); Ney Elias, in *Journal R.G.S.* (1875); Baron Richthofen, *China* (1877); J. Gilmour, *Among the Mongols* (1883); W. W. Rockhill, *Journey through Mongolia and Tibet* (1894); F. E. Younghusband, *The Heart of a Continent* (1896). (P. A. K.)

MONGOLS, the name of one of the chief ethnographical divisions of the Asiatic peoples (see also TURKS). The early history of the Mongols, like that of all central-Asian tribes, is extremely obscure. Even the meaning of the name "Mongol" is a disputed point, though a general consent is now given to Schott's etymology of the word from *mong*, meaning brave. From the earliest and very scanty notice we have of the Mongols in the history of the T'ang dynasty of China (A.D. 619-690) and in works of later times, it appears that their original camping-grounds were along the courses of the Kerulen, Upper Nonni and Argun rivers. But in the absence of all historical particulars of their origin, legend, as is usual, has been busy with their early years. The Mongol historian Sanang Setzen gives currency to the myth that they sprang from a blue wolf; and the soberest story on record is that their ancestor Budantsar was miraculously conceived of a Mongol widow. By craft and violence Budantsar gained the chieftainship over a tribe living in the neighbourhood of his mother's tent, and thus left a heritage to his son. Varying fortunes attended the descendants of Budantsar, but on the whole their power gradually increased, until Yesukai, the father of Jenghiz Khan, who was eighth in descent from Budantsar, made his authority felt over a considerable area. How this dominion was extended under the rule of Jenghiz Khan is shown in the article JENGHIZ KHAN, and when that great conqueror was laid to rest in the valley of Kilien in 1227 he left to his sons an empire which stretched from the China Sea to the banks of the Dnieper.

Over the whole of this vast region Jenghiz Khan set his second surviving son Ogotai or Ogdaï as khakan, or chief khan, while to the family of his deceased eldest son Juji he assigned the country from Kayalik and Khwarizm to the borders of Bulgar and Sakastan "where'er the hoofs of Mongol horse had tramped"; to Jagatai, his eldest surviving son, the territory from the borders of the Uighur country to Bokhara; while Tulé, the youngest, received charge of the home country of the Mongols, the care of the imperial encampment and family, and of the archives of the state. The appointment of Ogdaï as his successor being contrary to the usual Mongol custom of primogeniture, gave rise to some bitterness of feeling among the followers of Jagatai. But the commands of Jenghiz Khan subdued these murmurs, and Ogdaï was finally led to the throne by his dispossessed brother amid the plaudits of the assembled Mongols. In accordance with Mongol customs, Ogdaï signified his accession to the throne by distributing among his grandees presents from his father's treasures, and to his father's spirit he sacrificed forty maidens and numerous horses. Once fairly on the throne, he set himself vigorously to

follow up the conquests won by his father. At the head of a large army he marched southwards into China to complete the ruin of the Kin dynasty, which had already been so rudely shaken, while at the same time Tulé advanced into the province of Honan from the side of Shensi. Against this combined attack the Kin troops made a vigorous stand, but the skill and courage of the Mongols bore down every opposition, and over a hecatomb of slaughtered foes they captured Kai-féng Fu, the capital of their enemies. From Kai-féng Fu the emperor fled to Ju-ning Fu, whither the Mongols quickly followed. After sustaining a siege for some weeks, and enduring all the horrors of starvation, the garrison submitted to the Mongols, and at the same time the emperor committed suicide by hanging. Thus fell in 1234 the Kin or "Golden" dynasty, which had ruled over the northern portion of China for more than a century.

But though Ogdai's first care was to extend his empire in the rich and fertile provinces of China, he was not forgetful of the obligation under which Jenghiz Khan's conquests in western Asia had laid him to maintain his supremacy over the kingdom of Khwarizm. This was the more incumbent on him since Jelal ed-din, who had been driven by Jenghiz into India, had returned, reinforced by the support of the sultan of Delhi, whose daughter he had married, and, having reconquered his hereditary domains, had advanced westward as far as Tiflis and Kelat. Once more to dispossess the young sultan, Ogdai sent a force of 300,000 men into Khwarizm. With such amazing rapidity did this army march in pursuit of its foe that the advanced Mongol guards reached Amid (Diarbekr), whither Jelal ed-din had retreated, before that unfortunate sovereign had any idea of their approach. Accompanied by a few followers, Jelal ed-din fled to the Kurdish Mountains, where he was basely murdered by a peasant. The primary object of the Mongol invasion was thus accomplished; but, with the instinct of their race, they made this conquest but a stepping-stone to another, and without a moment's delay pushed on still farther westward. Unchecked and almost unopposed, they overran the districts of Diarbekr, Mesopotamia, Erbil and Kelat, and then advanced upon Azerbâijân. In the following year (1236) they invaded Georgia and Great Armenia, committing frightful atrocities. Tiflis was among the cities captured by assault, and Kars was surrendered at their approach in the vain hope that submission would gain clemency from the victors. Meanwhile, in 1235, Ogdai despatched three armies in as many directions. One was directed against Korea, one against the Sung dynasty, which ruled over the provinces of China south of the Yangtze Kiang, and the third was sent westward into eastern Europe. This last force was commanded by Batu, the son of Juji, Ogdai's deceased eldest brother, who took with him the celebrated Sabutai Bahâdur as his chief adviser. Bolgari, the capital city of the Bulgars, fell before the force under Sabutai, while Batu pushed on over the Volga. With irresistible vigour and astonishing speed the Mongols made their way through the forests of Penza and Tambov, and appeared before the "beautiful city" of Ryazan. For five days they discharged a ceaseless storm of shot from their ballistas, and, having made a breach in the defences, carried the city by assault on the 21st of December 1237. "The prince, with his mother, wife, sons, the boyars and the inhabitants, without regard to age or sex, were slaughtered with the savage cruelty of Mongol revenge; some were impaled, some shot at with arrows for sport, others were flayed or had nails or splinters of wood driven under their nails. Priests were roasted alive, and nuns and maidens ravished in the churches before their relatives. 'No eye remained open to weep for the dead.'" Moscow, at this time a place of little importance, next fell into the hands of the invaders, who then advanced against Vladimir. After having held out for several days against the Mongol attacks, the city at length succumbed, and the horrors of Ryazan were repeated. If possible, a more dire fate overtook the inhabitants of Kozelsk, near Kaluga, where, in revenge for a partial defeat inflicted on a Mongol force, the followers of Batu held so terrible a "carnival of death" that the city was renamed by its captors Mobeigal, "the city of woe." With the tide of victory thus strong in

their favour the Mongols advanced against Kiev, "the mother of cities," and carried it by assault. The inevitable massacre followed, and the city was razed to the ground.

Victorious and always advancing, the Mongols, having desolated this portion of Russia, moved on in two divisions, one under Batu into Hungary, and the other under Baidar and Kaidu into Poland. Without a check, Batu marched to the neighbourhood of Pest, where the whole force of the kingdom was arrayed to resist him. The Hungarian army was posted on the wide heath of Mohl, which is bounded by "the vine-clad hills of Tokay," the mountains of Lomnitz, and the woods of Diogyor. To an army thus hemmed in on all sides defeat meant ruin, and Batu instantly recognized the dangerous position in which his enemies had placed themselves. To add to his chances of success he determined to deliver his attack by night, and while the careless Hungarians were sleeping he launched his battalions into their midst. Panic-stricken and helpless, they fled in all directions, followed by their merciless foes. Two archbishops, three bishops, and many of the nobility were among the slain, and the roads for two days' journey from the field of battle were strewn with corpses. The king, Béla IV., was saved by the fleetness of his horse, though closely pursued by a body of Mongols, who followed at his heels as far as the coast of the Adriatic, burning and destroying everything in their way. Meanwhile Batu captured Pest, and on Christmas Day 1241, having crossed the Danube on the ice, took Esztergom by assault. While Batu had been thus triumphing, the force under Baidar and Kaidu had carried fire and sword into Poland. While laying waste the country they received the announcement of the death of Ogdai, and at the same time a summons for Batu to return eastwards into Mongolia.

While his lieutenants had been thus carrying his arms in all directions, Ogdai had been giving himself up to ignoble ease and licentiousness. Like many Mongols, he was much given to drink, and it was to a disease produced by this cause that he finally succumbed on the 11th of December 1241. He was succeeded by his son Kuyuk, who reigned only seven years. Little of his character is known, but it is noticeable that his two ministers to whom he left the entire conduct of affairs were Christians, as also were his doctors, and that a Christian chapel stood before his tent. This leaning towards Christianity, however, brought no peaceful tendencies with it. On the death of Kuyuk dissensions which had been for a long time smouldering between the houses of Ogdai and Jagatai broke out into open war, and after the short and disputed reigns of Kaidu and Chapai, grandsons of Ogdai, the lordship passed away for ever from the house of Ogdai. It did not go, however, to the house of Jagatai, but to that of Tulé.

On the 1st of July 1251 Mangu, the eldest son of Tulé, and nephew to Ogdai, was elected khakan. With perfect impartiality, Mangu allowed the light of his countenance to fall upon the Christians, Mohammedans and **Mangu** Buddhists among his subjects although Shamanism **Khaa.** was recognized as the state religion. Two years after his accession his court was visited by Rubruquis (*q.v.*) and other Christian monks, who were hospitably received. The description given by Rubruquis of the khakan's palace at Karakorum shows how wide was the interval which separated him from the nomad, tent-living life of his forefathers. It was "surrounded by brick walls. . . Its southern side had three doors. Its central hall was like a church, and consisted of a nave and two aisles, separated by columns. Here the court sat on great occasions. In front of the throne was placed a silver tree, having at its base four lions, from whose mouths there spouted into four silver basins wine, kumiss, hydromel and terasine. At the top of the tree a silver angel sounded a trumpet when the reservoirs that supplied the four fountains wanted replenishing." On his accession complaints reached Mangu that dissensions had broken out in the province of Persia, and he therefore sent a force under the command of his brother Hulagu to punish the Ismailites or Assassins **Hulagu.** (*q.v.*), who were held to be the cause of the disorder. Marching

by Samarkand and Karshi, Hulagu crossed the Oxus and advanced by way of Balkh into the province of Kuhistan or Kohistan. The terror of the Mongol name induced Ruknaddin Gurshah II. (Rokn al-din), the chief of the Assassins, to deprecate the wrath of Hulagu by offers of submission, and he was so far successful that he was able to purchase a temporary immunity from massacre by dismantling fifty of the principal fortresses in Kohistan. But when once the country had thus been left at the mercy of the invaders, their belief in the old saying "Stone dead hath no fellow" sharpened their battle-axes, and, sparing neither man, woman, nor child, they exterminated the unhappy people. Ruknaddin having been killed, 1256 (see ASSASSINS), Hulagu marched across the snowy mountains in the direction of Bagdad to attack the last Abbasid caliph and his Seljuk protectors. On arriving before the town he demanded its surrender. This being refused, he laid siege to the walls in the usual destructive Mongol fashion, and at length, finding resistance hopeless, the caliph was induced to give himself up and to open the gates to his enemies. On the 15th of February 1258 the Mongols entered the walls and sacked the city (see CALIPHATE *ad fin.*). While at Bagdad Hulagu gave his astronomer, Nāsir al-din permission to build an observatory. The town of Maragha was the site chosen, and, under the superintendence of Nāsir al-din and four western Asiatic astronomers who were associated with him, a handsome observatory was built, and furnished with "armillary spheres and astrolabes, and with a beautifully-executed terrestrial globe showing the five climates." The fall of Bagdad was almost contemporaneous with the end of the Seljuks of Konia as an independent power, though their actual destruction did not take place until 1308 (see SELJUKS). One terrible result of the Mongol invasion was a fearful famine, which desolated the provinces of Irak-Arabi, Mesopotamia, Syria and Rīm. But, though the inhabitants starved, the Mongols had strength and energy left to continue their onward march into Syria. Aleppo was stormed and sacked, Damascus surrendered (1260) and Hulagu was meditating the capture of Jerusalem with the object of restoring it to the Christians when he received the news of Mangu's death, and, as in duty bound, at once set out on his return to Mongolia, leaving Kitboga (Kitubuka) in command of the Mongol forces in Syria.

Hitherto a vassal of Mangu, as is shown by his striking coins bearing the name of Mangu as well as his own, Hulagu was now recognized as ruler of the conquered provinces. He assumed the title of ilkhan, and, although acknowledging the khakan as supreme lord, was practically independent. The title of ilkhan was that borne by his successors, who ruled over Persia for about a century (see *infra*, "The Ilkhans of Persia").

While Hulagu was prosecuting these conquests in western Asia, Mangu and his next brother Kublai were pursuing a like course in southern China. Southward they even advanced into Tong-king, and westward they carried their arms over the frontier into Tibet. But in one respect there was a vast difference between the two campaigns. Under the wise command of Kublai all indiscriminate massacres were forbidden, and probably for the first time in Mongol history the inhabitants and garrisons of captured cities were treated with humanity. While carrying on the war in the province of Szech'uen Mangu was seized with an attack of dysentery, which proved fatal after a few days' illness. His body was carried into Mongolia on the backs of two asses, and, in pursuance of the custom of slaughtering every one encountered on the way, 20,000 persons were, according to Marco Polo, put to the sword.

At the Kuriltai, or assembly of notables, which was held at Shang-tu after the death of Mangu, his brother Kublai (see KUBLAI KHAN) was elected khakan. For thirty-five years he sat on the Mongol throne, and at his death in 1294, in his seventy-ninth year, he was succeeded by his son Timur Khan, or, as he was otherwise called, Oldjeitu or Uldsheitu Khan (Chinese Yuen-chêng). The reign of this sovereign was chiefly remarkable for the healing of the division which had for thirty years separated the families of Ogdoi and Jagatai from that of the ruling khakan. Uldsheitu was succeeded by his nephew Khaissan, who was

gathered to his fathers in February 1311, after a short reign, and at the early age of thirty-one. His nephew and successor, Buyantu (Chinese Yen-tsung), was a man of considerable culture, and substantially patronized Chinese literature. Among other benefits which he conferred on letters, he rescued the celebrated inscription-bearing "stone drums," which are commonly said to be of the Chow period (1122-255 B.C.), from the decay and ruin to which they were left by the last emperor of the Kin dynasty, and placed them in the gateway of the temple of Confucius at Peking, where they now stand. After a reign of nine years, Buyantu was succeeded by his son Gegen (Chinese Ying-tsung), who perished in 132 by the knife of an assassin. Yissun Timur (Chinese Tai-ting-ti), who was the next sovereign, devoted himself mainly to the administration of his empire. He divided China, which until that time had been apportioned into twelve provinces, into eighteen provinces, and rearranged the system of state granaries, which had fallen into disorder. His court was visited by Friar Odoric, who gives a minute description of the palace and its inhabitants. Speaking of the palace this writer says:—

"Its basement was raised about two paces from the ground, and within there were twenty-four columns of gold, and all the walls were hung with skins of red leather, said to be the finest in the world. In the midst of the palace was a great jar more than two paces in height, made of a certain precious stone called merdacas (jade); its price exceeded the value of four large towers. . . . Into this vessel drink was conducted by certain conduits from the court of the palace, and beside it were many golden goblets, from which those drank who listed. . . . When the khakan sat on his throne the queen was on his left hand, and a step lower two others of his women, while at the bottom of the steps stood the other ladies of his family. All those who were married wore upon their heads the foot of a man as it were a cubit and a half in length, and at the top of the foot there were certain cranes' feathers, the whole foot being set with great pearls, so that if there were in the whole world any line and large pearls they were to be found in the decoration of those ladies."

The following years were years of great natural and political convulsions. Devastating floods swept over China, carrying death and ruin to thousands of homes; earthquakes made desolate whole districts; and in more than one part of the empire the banners of revolt were unfurled. Under various leaders the rebels captured a number of cities in the provinces of Kiang-nan and Honan, and took possession of Hang-chow, the capital of the Sung emperors. At the same time pirates ravaged the coasts and swept the imperial vessels off the sea.

In 1355 a Buddhist priest named Chu Yuen-chang became so impressed with the misery of his countrymen that he threw off his vestments and enrolled himself in the rebel army. His military genius soon raised him to the position of a leader, and with extraordinary success he overcame with his rude levies the trained legions of the Mongol emperor. While unable to defeat or check the rebels in the central provinces, Toghton Timur Khan was also called upon to face a rebellion in Korea. Nor were his arms more fortunate in the north than in the south. An army which was sent to suppress the revolt was cut to pieces almost to a man. These events made a dream which the emperor dreamt about this time of easy interpretation. He saw in his sleep "a wild boar with iron tusks rush into the city and wound the people, who were driven hither and thither without finding shelter. Meanwhile the sun and the moon rushed together and perished." "This dream," said the diviner, "is a prophecy that the khakan will lose his empire." The fulfilment followed closely on the prophecy. By a subterfuge the rebels, after having gained possession of most of the central provinces of the empire, captured Peking. But Toghton Timur by a hasty flight escaped from his enemies, and sought safety on the shores of the Dolon-nor in Mongolia. For a time the western provinces of China continued to hold out against the rebels, but with the flight of Toghton Timur the Mongol troops lost heart, and in 1368 the ex-Buddhist priest ascended the throne as the first sovereign of the Ming or "Bright" dynasty, under the title of Hung-wu.

Thus ended the sovereignty of the house of Jenghiz Khan in China, nor need we look far to find the cause of its fall. Brave

and hardy the Mongols have always shown themselves to be; but *The Mongols expelled from China.* the capacity for consolidating the fruits of victory, for establishing a settled form of government, and for gaining the allegiance of the conquered peoples, have invariably been wanting in them.

Not content with having recovered China, the emperor Hungwu sent an army of 400,000 men into Mongolia in pursuit of the forces which yet remained to the khakan. Even on their own ground the disheartened Mongols failed in their resistance to the Chinese, and at all points suffered disaster. Meanwhile Toghon Timur, who did not long survive his defeat, was succeeded in the khakanate by Biliktu Khan, who again in 1379 was followed by Ussakhal Khan. During the reign of this last prince the Chinese again invaded Mongolia, and inflicted a crushing defeat on the khan's forces in the neighbourhood of Lake Buyur. Besides the slain, 2094 officers and 77,000 soldiers are said to have been taken prisoners, and an immense booty to have been secured. This defeat was the final ruin of the eastern branch of the Mongols, who from this time surrendered the supremacy to the western division of the tribe. At first the Keraits or Torgod, as in the early days before Jenghiz Khan rose to power, exercised lordship over the eastern Mongols, but from these before long the supremacy passed to the Oirad, who for fifty years treated them as vassals. Notwithstanding their subjection, however, the Keraits still preserved the imperial line, and khakan after khakan assumed the nominal sovereignty of the tribe, while the real power rested with the descendants of Toghon, the Oirad chief, who had originally attached them to his sceptre. Gradually, however, the Mongol tribes broke away from all governing centres, and established scattered communities with as many chiefs over the whole of eastern Mongolia. The discredit of having finally disintegrated the tribe is generally attached to Lingdan Khan (1604-1634), of whom, in reference to his arrogant and brutal character, has been quoted the Mongolian proverb: "A raging khakan disturbs the state, and a raging saghan (elephant) overthrows his keepers."

At this time the Mongols, though scattered and in isolated bodies, had recovered somewhat from the shock of the disaster which they had suffered at the hand of the first Ming sovereign of China. When first driven northwards, they betook themselves to the banks of the Kerulen, from whence they had originally started on their victorious career; but gradually, as the Chinese power became weaker among the frontier tribes, they again pushed southwards, and at this time had established colonies in the Ordu country, within the northern bend of the Yellow River. The Mongol royal family and their immediate surroundings occupied the Chakhar country to the north-west of the Ordu territory, where they became eventually subjugated by the Manchus on the overthrow of the Ming dynasty in 1644 by the present rulers of China. At times the old vigour and strength which had nerved the arm of Jenghiz Khan seemed to return to the tribe, and we read of successful expeditions being made by the Ordu Mongols into Tibet, and even of invasions into China. The relations with Tibet thus inaugurated brought about a rapid spread of Buddhism among the Mongolians, and in the beginning of the 17th century the honour of having a Dalai Lama born among them was vouchsafed to them. In 1625 Toba, one of the sons of Bushuktu Jingung Khan, went on a pilgrimage to the Dalai Lama, and brought back with him a copy of the Tanjur to be translated into Mongolian, as the Kanjur had already been. But though the prowess of the Ordu Mongols was still unsubdued, their mode of living was as barren and rugged as the steppes and rocky hills which make up their territory. Their flocks and herds, on which they are entirely dependent for food and clothing, are not numerous, and, like their masters, are neither well fed nor well favoured. But though living in this miserable condition their princes yet keep up a certain amount of barbaric state, and the people have at least the reputation of being honest.

Several of the tribes who had originally migrated with those who finally settled in the Ordu territory, finding the country to

be so inhospitable, moved farther eastward into richer pastures. Among these were the Tumeds, one of whose chiefs, Altan Khaa (Chinese Yen-ta), is famous in later Mongol history for the power he acquired. For many years during the 16th century he carried on a not altogether unsuccessful war with China, and finally, when peace was made (1571), the Chinese were fain to create him a prince of the empire and to confer a golden seal of authority upon him. In Tibet his arms were as successful as in China; but, as has often happened in history, the physical conquerors became the mental subjects of the conquered. Lamaism has always had a great attraction in the eyes of the Mongols, and, through the instrumentality of some Lamaist prisoners whom Altan brought back in his train, the religion spread at this time rapidly among the Tumeds. Altan himself embraced the faith, and received at his court the Bogda Sodnam Gyamtsu Khutuktu, on whom he lavished every token of honour. One immediate effect of the introduction of Buddhism among the Tumeds was to put an end to the sacrifices which were commonly made at the grave of their chieftains. In 1584 Altan died, and was succeeded by his son Senge Dugureng Timur. The rich territory occupied by the Tumeds, together with the increased intercourse with China which sprang up after the wars of Altan, began to effect a change in the manner of life of the people. By degrees the pastoral habits of the inhabitants became more agricultural, and at the present day, as in Manchuria, Chinese immigrants have so stamped their mark on the fields and markets, on the towns and villages, that the country has become to all intents and purposes part of China proper.

Passing now from the inner division of the Mongols who live in the southern and eastern portions of the desert we come to the outer division, which occupies the territory to the north of the desert. Of these the chief are the *The Kalkas.* Kalkas, who are divided into the Western and Eastern Kalkas. These people form the link of communication between Europe and eastern Asia. Early in the 17th century the Russians sent an embassy to the court of the Golden Khan with the object of persuading the Mongol khan to acknowledge allegiance to the tsar. This he did without much hesitation or inquiry, and he further despatched envoys to Moscow on the return of the Russian embassy. But the allegiance thus lightly acknowledged was lightly thrown off, and in a quarrel which broke out between the Khirghiz and the Russians the Kalkas took the side of the former. The breach, however, was soon healed over, and we find the Golden Khan sending an envoy again to Moscow, asking on behalf of his master for presents of jewels, arms, a telescope, a clock, and "a monk who had been to Jerusalem that he might teach the Kalkas how the Christians prayed." Their submission to Russia on the north did not save them, however, from the Chinese attacks on the south. At that time the present Manchu dynasty ruled in China, and to the then reigning sovereign the Kalkas gave in their submission. For some time the Chinese yoke sat lightly on their consciences, but difficulties having arisen with the Kalmucks, they were ready enough to claim the protection of China. To cement the alliance the emperor K'ang-hi invited all the Kalka chiefs to meet him at the plain of Dolon-nor. This ceremony brought the separate history of the Kalkas to a close, since from that time they have been engulfed in the Chinese Empire.

During the Kin dynasty of China the Keraits, as has been pointed out, were for a time supreme in Mongolia, and it was during that period that one of the earliest recognized sovereigns, Merghus Buuyruk Khan, sat on the throne. In an engagement with a neighbouring Tatar tribe their khan was captured and sent as a propitiatory present to the Kin emperor, who put him to death by nailing him on a wooden ass. On the treacherous Tatar chief the widow determined to avenge herself, and chose the occasion of a feast as a fitting opportunity. With well-disguised friendship she sent him a present of ten oxen, a hundred sheep and a hundred sacks of koumiss. These, last, however, instead of being filled with skins of the liquor which Mongolians love so well, contained armed men, who, when the Tatar was feasted, rushed from their concealment and killed him.

A grandson of Merghus was the celebrated Wang Khan, who was sometimes the ally and sometimes the enemy of Jenghiz Khan, and has also been identified as the Prester John of early western writers. In war he was almost invariably unfortunate, and it was with no great difficulty, therefore, that his brother Ki Wang detached the greater part of the Kerait tribes from his banner, and founded the Torgod chieftainship, *The Torgod*, named probably from the country where they settled themselves. The unrest peculiar to the dwellers in the Mongolian desert disturbed the Torgod as much as their neighbours. Their history for several centuries consists of nothing but a succession of wars with the tribes on either side of them, and it was not until 1672, when Ayuka Khan opened relations with the Russians, that the country obtained an even temporarily settled existence. Its position, indeed, at this time made it necessary that Ayuka should ally himself either with the Russians or with his southern neighbours the Turks, though at the same time it was obvious that his alliance with the one would bring him into collision with the other. His northern neighbours, the Cossacks of the Yaik and the Bashkirs, both subject to Russia, had the not uncommon propensity for invading his borders and harassing his subjects. This gave rise to complaints of the tsar's government and a disposition to open friendly relations with the Krim khan. A rupture with Russia followed, and Ayuka carried his arms as far as Kazan, burning and laying waste the villages and towns on his route and carrying off prisoners and spoils. Satisfied with this vengeance, he advanced no farther, but made a peace with the Russians, which was confirmed in 1722 at an audience which Peter the Great gave him at Astrakhan. On Ayuka's death shortly after this event, he was succeeded by his son Cheren Donduk, who received from the Dalai Lama a patent to the throne. But this spiritual support availed him little against the plots of his nephew Donduk Ombo, who so completely gained the suffrages of the people that Cheren Donduk fled before him to St Petersburg, where he died, leaving his nephew in possession. With consummate impartiality the Russians, when they found that Donduk Ombo had not only seized the throne but was governing the country with vigour and wisdom, formally invested him with the khanate. At his death he was succeeded by Donduk Taishi, who, we are told, went to Moscow to attend the coronation of the empress Elizabeth, and to swear fealty to the Russians. After a short reign he died, and his throne was occupied by his son Ubasha. The position of the Torgod at this time, hemmed in as they were between the Russians and Turks, was rapidly becoming unbearable, and the question of migrating "bag and baggage" was very generally mooted. In the war between his two powerful neighbours in 1760 and 1770, Ubasha gave valuable assistance to the Russians. His troops took part in the siege of Ochakov, and gained a decided victory on the river Kalaus. Flushed with these successes, he was in no mood to listen patiently to the taunts of the governor of Astrakhan, who likened him to a "bear fastened to a chain," and he made up his mind to break away once and for all from a tutelage which was as galling as it was oppressive. He determined, therefore, to migrate eastward with his people, and on the 5th of January 1771 he began his march with 70,000 families. In vain the Russians attempted to recall the fugitives, who, in spite of infinite hardships, after a journey of eight months reached the province of Ili, where they were welcomed by the Chinese authorities. Food for a year's consumption was supplied to each family; and land, money and cattle were freely distributed. It is believed that 300,000 persons survived to receive the hospitality of the Chinese. By this desperate venture the Torgod escaped, it is true, the oppression of the Russians, but they fell into the hands of other masters, who, if not so exacting, were equally determined to be supreme. The Chinese, flattered by the compliment implied by the transference of allegiance, settled them on lands in the province of Ili, in the neighbourhood of the Altai mountains, and to the west of the desert of Gobi. But the price they were made to pay for this liberality was absorption in the Chinese empire.

Among the Mongol chiefs who rose to fame during the rule of the Ming dynasty of China was Toghon, the Kalmuck khan, who, taking advantage of the state of confusion which reigned among the tribes of Mongolia, established *The Kalmuck* for himself an empire in north-western Asia. Death carried him off in 1444, and his throne devolved upon his son Ye-seen, who was no degenerate offspring. Being without individual foes in Mongolia he turned his arms against China, which through all history has been the happy hunting-ground of the northern tribes, and had the unexampled good fortune to take prisoner the Chinese emperor Ch'eng-t'ung. But victory did not always decide in his favour, and after having suffered reverses at the hands of the Chinese, he deemed it wise to open negotiations for the restoration of his imperial prisoner. Thus, after a captivity of seven years Ch'eng-t'ung re-entered his capital in 1457, not altogether to the general satisfaction of his subjects. On the death of Yi-sien, shortly after this event, the Kalmucks lost much of their power in eastern Asia, but retained enough in other portions of their territory to annoy the Russians by raids within the Russian frontier, and by constant acts of pillage. In the 17th century their authority was partly restored by Galdan, a Lama, who succeeded by the usual combination of wile and violence to the throne of his brother Senghē. Having been partly educated at Lhasa, he was well versed in Asiatic politics, and, taking advantage of a quarrel between the Black and White Mountaineers of Kashgar he overran Little Bokhara, and left a viceroy to rule over the province with his capital at Yarkand. At the same time he opened relations with China, and exchanged presents with the emperor. Having thus secured his powerful southern neighbour, as he thought, he turned his arms against the Kalkas, whose chief ground of offence was their attachment to the cause of his brothers. But his restless ambition created alarm at Peking, and the emperor K'ang-hi determined to protect the Kalkas against their enemy. The emperor, in person commanding one of the two forces, marched into Mongolia. After enduring incredible hardships during the march through the desert of Gobi the imperial army encountered the Kalmucks at Chao-modo. The engagement was fiercely contested, but ended in the complete victory of the Chinese, who pursued the Kalmucks for ten miles, and completely dispersed their forces. Galdan, with his son, daughter and a few followers, fled westward and escaped; and thus collapsed a power which had threatened at one time to overshadow the whole of Central Asia. For a time Galdan still maintained resistance to his powerful enemy, but death overtook him while yet in the field against the Chinese.

But though Galdan was dead the Chinese did not enjoy that complete immunity from war at the hand of his successor that they had looked for. Tsi-wang Arabtan was, however, but the shadow of his brother and predecessor, and a dispute which arose with the Russians during his reign weakened his power in other directions. Little Bokhara was said to be rich in gold mines, and therefore became a coveted region in the eyes of the Russians. Under the vigorous administration of Peter the Great an expedition was despatched to force a passage into the desired province. To oppose this invasion the Kalmucks assembled in force, and after a protracted and undecided engagement the Russians were glad to agree to retire down the Irtysh and to give up all further advance.

To Tsi-wang Arabtan succeeded Amursama, owing to the support he received from the Chinese emperor K'ien-lung, who nominated him khan of the Kalmucks and chief of Dzungaria. But, though to the ear these titles were as high-sounding as those of his predecessors, in reality the power they represented was curtailed by the presence of Chinese commissioners, in whose hands rested the real authority. The galling weight of this state of dependence drove Amursama before long into revolt. He dispersed the Chinese garrisons stationed in Ili (Kulja), killed the generals, and advanced his own forces as far as Palikun on the river Ili. To punish this revolt, K'ien-lung sent a large force into the rebellious province. As on the previous occasion, the

Chinese were everywhere victorious, and Amursama fled into Siberia, where he died of small-pox after a short illness.

While China was thus absorbing the Mongols within her reach, Russia was gathering within her borders those with whom she came into contact. Among these were the Buriats, who occupied a large territory on both sides of Lake Baikal. As usual in such cases, disputes arose out of disturbances on the frontier, and were ended by the Buriats and the neighbouring Mongol tribes becoming one and all tributary to Russia.

The dominions given by Jenghiz Khan to his son Jagatai were involved in the quarrels between Kaidu and Kublai for the khakanate, but at the beginning of the 14th century Dua, a great-great-grandson of Jagatai, made himself undisputed lord of the whole region. Shortly after Dua's death the Mongols of Eastern Turkestan, descendants of those who had favoured the pretensions of Kaidu to be khakan, separated from their western brethren and chose a son of Dua as their khan. Henceforth the Jagataids were divided into two dynasties, the western reigning at Samarkand, the eastern first at Kashgar and later at Yarkand and Aksu. Kazan (1343-1346) was the last independent khan of the western Jagataids; thereafter power fell into the hands of amirs, who, however, continued to place a titular khan on the throne. In 1360 Toghluq-Timur, a grandson of Dua and khan of the eastern Jagataids (the kingdom called by the Persian historians Mогоlistan), invaded the territories of the western Jagataids. About this time Timur (*q.v.*), otherwise Timur-i-leng (Tamerlane), a young amir at the court of the western Jagataids, allied himself with the leaders who had dethroned Kazan, and after the death of Toghluq-Timur became by right of conquest khan of both sections of the Jagataids. After Timur's death the two sections again divided, while a third kingdom, Ferghana, was held by the Timurids (descendants of Timur). At the beginning of the 16th century all three dynasties were swept away by Mahommed Shaibani, head of the Uzbek Mongols (see *infra*, *Uzbeks*).

The empire of the Ilkhans established by Hulagu lasted nominally until 1353, but after the death of the Ilkhan Abu Said in 1355 the real power was divided between five petty dynasties which had been formed out of the provinces conquered by Hulagu. Meantime Islam had made great progress among the Mongols, the third Ilkhan, Nikudar Ahmed (reigned 1281-1284) having embraced that faith. The western frontiers of their empire bordering on the Syrian possessions of Egypt there was frequent intercourse, sometimes friendly, sometimes warlike, between the Ilkhans and the sultans of Egypt (*q.v.*). Of the petty dynasties which supplanted that of Hulagu, one known as the Jelairids held Bagdad until about 1400. Another dynasty which reigned in Azerbaijan was overthrown in 1355 by the western Kipchaks (see *infra*, *Golden Horde*). Between 1369 and 1400 Timur had made himself master of the greater part of Persia and established there a second Mongol dynasty, which in turn gave place to that of the Ak Kuyunli (see *PERSIA*).

Of the Mongol tribes who became entirely subject to Russia the principal are those of the Crimea, of Kazan, and Astrakhan; of these the Tatars of Kazan are the truest representatives of the Golden Horde or western Kipchaks, who originally formed the subjects of Batu and Orda. Batu, whose victorious campaign in Russia has already been sketched, was finally awarded as his fief the vast steppes which stretch from the Carpathian Mountains to Lake Balkash. He fixed his headquarters on the Volga, and there set up his Golden Tent from which the horde acquired the name of the Golden Horde. In 1255 Batu died and was succeeded by his brother Bereke Khan. During the reign of this sovereign the exactions which were demanded from the Russian Christians by the Mongols aroused the Christian world against the barbarian conquerors, and at the command of Pope Alexander IV. a general crusade was preached against them. But though the rage of the Christians was great, they lacked that united energy which might have availed them against their enemies; and, while they were yet breathing out denunciations,

a Tatar host, led by Nogai and Tulabagha, appeared in Poland. After a rapid and triumphant march the invaders took and destroyed Cracow, and from thence advanced as far as Bythom (Beuthen) in Oppeln, from which point they eventually retired, carrying with them a crowd of Christian slaves. From this time the Mongols became for a season an important factor in European politics. They corresponded and treated with the European sovereigns, and intermarried with royal families. Hulagu married a daughter of Michael Palaeologus; Toktu Khan took as his wife Maria, the daughter of Andronicus II.; and to Nogai Michael betrothed his daughter Irene. Toktu, the second khan in succession to Bereke, is the first Mongol ruler whom we hear of as having struck coins. Those issued during his reign bear the mint marks of Sarai, New Sarai, Bulgar, Ukek, Khwarizm, Krim, Jullat and Madjarui, and vary in date from 1291 to 1312.

The adoption of Islam by the rulers of the Golden Horde had as one result the drawing closer of the relations of the Mongols with Constantinople and Egypt. Embassies passed between the three courts, and so important was the alliance with the Mongols deemed by the sultan Nāsir, ruler of Egypt, that he sent to demand in marriage a princess of the house of Jenghiz Khan. At first his request was refused by the proud Mongols, but the present of a million gold dinars, besides a number of horses and suits of armour, changed the refusal into an acquiescence, and in October 1319 the princess landed at Alexandria in regal state. Her reception at Cairo was accompanied with feasting and rejoicing, and the members of her escort were sent back laden with presents. With that religious toleration common to his race, Uzbek Khan, having married one princess to Nāsir, gave another in marriage to George the prince of Moscow, whose cause he espoused in a quarrel existing between that prince and his uncle, the grand-prince Michael. Assuming the attitude of a judge in the dispute, Uzbek Khan summoned Michael to appear before him, and, having given his decision against him, ordered his execution. The sentence was carried out with aggravated cruelty in sight of his nephew and accuser. From this time Uzbek's sympathies turned towards Christianity. He protected the Russian churches within his frontiers, and put his seal to his new religious views by marrying a daughter of the Greek emperor, Andronicus III. He died in 1340, after a reign of twenty-eight years. His coins were struck at Sarai, Khwarizm, Mokshi, Bulgar, Azak and Krim, and are dated from 1313 to 1340. His son and successor, Tinibeg Khan, after a reign of only a few months, was murdered by his brother Janibeg Khan, who usurped his throne, and, according to the historian Ibn Haidar, proved himself to be "just, God-fearing, and the patron of the meritorious." These excellent qualities did not, however, prevent his making a raid into Poland, which was conducted in the usual Mongol manner, nor did they save his countrymen from being decimated by the black plague. The throne Janibeg had seized by violence was, in 1357, snatched from him by violence. As he lay ill on his return from a successful expedition against Persia he was murdered by his son Berdibeg, who in his turn was, after a short reign, murdered by his son Kulpa. With the death of Berdibeg the fortunes of the Golden Horde began rapidly to decline. As the Uzbek proverb says, "The hump of the camel was cut off in the person of Berdibeg."

But while the power of the Golden Horde was dwindling away, the White Horde or Eastern Kipchak, which was the inheritance of the elder branch of the family of Juji, remained prosperous and full of vitality. The descendants of Orda, Batu's elder brother, being far removed from the dangerous influences of European courts, maintained much of the simplicity and vigour of their nomad ancestors, and the throne descended from father to son with undiminished authority until the reign of Urus Khan (1360), when complications arose which changed the fortunes of the tribe. Like many other opponents of the Mongol rulers, Khan Tuli Khoja paid with his life for his temerity in opposing the political schemes of his connexion Urus Khan. Toktamish, the son of the murdered man, fled at the news of his

The House of Jagatai.

The Ilkhans of Persia.

The Golden Horde.

The White Horde, or Eastern Kipchak.

father's death and sought refuge at the court of Timur, who received him with honour and at once agreed to espouse his cause. With this intention he despatched a force against Urus Khan, and gained some advantage over him, but, while fitting out another army to make a fresh attack, news reached him of the death of Urus. Only at Signhak are coins known to have been struck during the reign of Urus, and these bear date from 1372 to 1375.

He was followed on the throne by his two sons, Tuktakia and Timur Malik, each in turn; the first reigned but for a few weeks, and the second was killed in a battle against Toktamish, the son of his father's enemy. Toktamish

The Reign of Toktamish.

now (1378) seized the throne, not only of Eastern Kipchak but also of the Golden Horde, over which his arms had at the same time proved victorious. He reigned as Nâsir ed-din Jetal ed Mahmud Ghujas Toktamish. His demands for tribute from the Russian princes met with evasions from men who had grown accustomed to the diminished power of the later rulers of the Golden Horde, and Toktamish therefore at once marched an army into Russia. Having captured Serpukhov, he advanced on Moscow. On the 23rd of August 1382 his troops appeared before the doomed city. For some days the inhabitants bravely withstood the constant attacks on the walls, but failed in their resistance to the stratagems which were so common a phase in Mongolian warfare. With astonishing credulity they opened

Moscow Sacked.

the gates to the Mongols, who declared themselves the enemies of the grand-prince alone, and not of the people. The usual result followed. The Russian general, who was invited to Toktamish's tent, was there slain and at the same time the signal was given for a general slaughter. Without discriminating age or sex, the Mongol troops butchered the wretched inhabitants without mercy, and, having made the streets desolate and the houses tenantless, they first plundered the city and then gave it over to the flames. The same pitiless fate overtook Vladimir, Zvenigorod, Yuriev, Mozhaisk and Dimitrov. With better fortune, the inhabitants of Pereslavl and Kolomna escaped with their lives from the troops of Toktamish, but at the expense of their cities, which were burned to the ground. Satisfied with his conquests, the khan returned homewards, traversing and plundering the principality of Ryazan on his way. Flushed with success, Toktamish demanded from his patron Timur the restoration of Khwarizm, which had fallen into the hands of the latter at a period when disorder reigned in the Golden Horde. Such a request was not likely to be well received by Timur, and, in answer to his positive refusal to yield the city, Toktamish marched an army of 90,000 men against Tabriz. After a siege of eight days the city was taken by assault and ruthlessly ravaged. In the meantime Timur was collecting forces to punish his rebellious protégé. When his plans were fully matured, he advanced upon Old Urgenj and captured it. More merciful than Toktamish, he transported the inhabitants to Samarkand,

Wars with Timur.

but in order to mark his anger against the rebellious city he levelled it with the ground and sowed barley on the site where it had stood. On the banks of the Oxus he encountered his enemy, and after a bloody battle completely routed the Kipchaks, who fled in confusion. A lull followed this victory, but in 1390 Timur again took the field. To each man was given "a bow, with thirty arrows, a quiver, and a buckler. The army was mounted, and a spare horse was supplied to every two men, while a tent was furnished for every ten, and with this were two spades, a pickaxe, a sickle, a saw, an axe, anawl, a hundred needles, 8½ lb of cord, an ox's hide, and a strong pan." Thus equipped the army set forth on its march. After a considerable delay owing to an illness which overtook Timur his troops arrived at Kara Saman. Here envoys arrived from Toktamish bearing presents and a message asking pardon for his past conduct; but Timur was inexorable, and, though he treated the messengers with consideration, he paid no attention to their prayer. In face of innumerable difficulties, as well as of cold, hunger, and weariness, Timur marched forward month after month through the Kipchak country in pursuit

of Toktamish. At last, on the 18th of June, he overtook him at Kandurcha, in the country of the Bulgars, and at once forced him to an engagement. For three days the battle lasted, and, after inclining now to this side and now to that, victory finally decided in favour of Timur. The Kipchaks were completely routed and fled in all directions, while it is said as many as 100,000 corpses testified to the severity of the fighting.

Toktamish, though defeated, was not subdued, and in 1395 Timur found it necessary again to undertake a campaign against him. This time the armies met upon the Terek, and after a fiercely-contested battle the Kipchaks again fled in confusion. Timur, threatened by the advancing autumn, gave up further pursuit, and retired with a vast booty of gold ingots, silver bars, pieces of Antioch linen and of the embroidered cloth of Russia, &c. On his homeward march southwards he arrived before Azak, which was then the entrepôt where the merchants of the east and west exchanged their wares. In vain the natives, with the Egyptian, Venetian, Genoese, Catalan and Basque inhabitants, besought him to spare the city. His answer was a command to the Moslems to separate themselves from the rest of the people, whom he put to the sword, and then gave the city over to the flames. Circassia and Georgia next felt his iron heel, and the fastnesses of the central Caucasus were one and all destroyed. After these successes Timur gave himself up for a time to feasting and rejoicing, accompanied by every manifestation of Oriental luxury. "His tent of audience was hung with silk, its poles were golden, or probably covered with golden plates, the nails being silver; his throne was of gold, enriched with precious stones; the floor was sprinkled with rose water." But his vengeance was not satisfied, and, having refreshed his troops by this halt, he marched northwards against Astrakhan, which he utterly destroyed. The inhabitants were driven out into the country to perish with the cold, while the commander of the city was killed by being forced beneath the ice of the Volga. Sarai next shared the same fate, and, Timur, having thus crushed for the second time the empire of Toktamish, set out on his return home by way of Derbent and Azerbâijân.

The power in the hands of the successors of Toktamish never revived after the last campaign of Timur. They were constantly engaged in wars with the Russians and the Krim Tatars, with whom the Russians had allied themselves, and by degrees their empire decayed, until, on the seizure and death of Ahmed Khan at the beginning of the 16th century, the domination of the Golden Horde came to an end.

The fate which thus overtook the Golden Horde was destined to be shared by all the western branches of the great Mongol family. The khans of Kazan and Kasimov had already in 1552 succumbed to the growing power of Russia, and the Krim Tatars were next to fall under the same yoke. In the 15th century, when the Krim Tatars first appear as an independent power, they attempted to strengthen their position by allying themselves with the Russians, to whom they looked for help against the attacks of the Golden Horde. But while they were in this state of dependence another power arose in eastern Asia which modified the political events of that region. In 1453 Constantinople was taken by the Osmanli Turks, who, having quarrelled with the Genoese merchants who monopolized the trade on the Black Sea, sent an expedition into the Crimea to punish the presumptuous traders. The power which had captured Constantinople was not likely to be held in check by any forces at the disposal of the Genoese, and without any serious opposition Kaffa, Sudak, Balaklava and Inkerman fell before the troops of the sultan Mahommed. It was plain that, situated as the Crimea was between the two great powers of Russia and Turkey, it must of necessity fall under the direction of one of them. Which it should be was decided by the invasion of the Turks, who restored Mengli Girai, the deposed khan, to the throne, and virtually converted the khanate into a dependency of Constantinople. But though under the tutelage of Turkey, Mengli Girai, whose leading policy seems to have been

The Krim Tatars.

the desire to strengthen himself against the khāns of the Golden Horde, formed a close alliance with the grand-prince Ivan of Russia. One result of this friendship was that the Mongols were enabled, and encouraged, to indulge their predatory habits at the expense of the enemies of Russia, and in this way both Lithuania and Poland suffered terribly from their incursions. It was destined, however, that in their turn the Russians should not escape from the marauding tendencies of their allies, for, on pretext of a quarrel with reference to the succession to the Kazan throne, Mahomed Girai Khan in 1521 marched an army northwards until, after having devastated the country, massacred the people, and desecrated the churches on his route, he arrived at the heights of Vorobiev overlooking Moscow. The terror of the unfortunate inhabitants at the sight once again of the dreaded Mongols was extreme; but the horrors which had accompanied similar past visitations were happily averted by a treaty, by which the grand-prince Basil undertook to pay a perpetual tribute to the Krim khāns. This, however, proved but a truce. It was impossible that an aggressive state like Russia should live in friendship with a marauding power like that of the Krim Tatars. The primary cause of contention was the khanate of Kazan, which was recovered by the Mongols, and lost again to Russia with that of Astrakhan in 1555. The sultan, however, declined to accept this condition of things as final, and instigated Devlet Girai, the Krim khan, to attempt their recovery. With this object the latter marched an army northwards, where, finding the road to Moscow unprotected, he pushed on in the direction of that ill-starred city. On arriving before its walls he found a large Russian force occupying the suburbs. With these, however, he was saved from an encounter, for just as his foremost men approached the town a fire broke out, which, in consequence of the high wind blowing at the time, spread with frightful rapidity, and in the space of six hours destroyed all the churches, palaces and houses, with the exception of the Kremlin, within a compass of 30 miles. Thousands of the inhabitants perished in the flames. "The river and ditches about Moscow," says Horsey, "were stopped and filled with the multitudes of people, laden with gold, silver, jewels, chains, ear-rings and treasures. So many thousands were there burned and drowned that the river could not be cleaned for twelve months afterwards." Satisfied with the destruction he had indirectly caused, and unwilling to attack the Kremlin, the khan withdrew to the Crimea, ravaging the country as he went. Another invasion of Russia, a few years later (1572), was not so fortunate for the Mongols, who suffered a severe defeat near Molodi, 50 versts from Moscow. A campaign against Persia made a diversion in the wars which were constantly waged between the Krim khan and the Russians, Cossacks and Poles. So hardly were these last pressed by their pertinacious enemies in 1649 that they bound themselves by treaty to pay an annual subsidy to the khan. But the fortunes of war were not always on the side of the Tatars, and with the advent of Peter the Great to the Russian throne the power of the Krim Mongols began to decline. In 1696 the tsar, supported by a large Cossack force under Mazeppa, took the field against Selim Girai Khan, and gained such successes that the latter was compelled to cede Azov to him. By a turn of the wheel of fortune the khan had the satisfaction in 1711 of having it restored to him by treaty; but this was the last real success that attended the Tatar arms. In 1735 the Russians in their turn invaded the Crimea, captured the celebrated lines of Perekop, and ravaged Bakhchi-sarai, the capital. The inevitable fate which was hanging over the Krim Tatars was now being rapidly accomplished. In 1783 the Krim, together with the eastern portion of the land of the Nogais, became absorbed into the Russian province of Taurida.

It will now only be necessary to refer briefly to the Uzbeks, who, on the destruction of the Golden Horde, assumed an important position on the east of the Caspian Sea. The founder of their greatness was the khan Abul-khair, who reigned in the 15th century, and who, like another Jenghiz Khan, consolidated a power out of a number

of small clans, and added lustre to it by his successful wars. Shaibani Khan, his grandson, proved himself a worthy successor, and by him Baber (q.v.), the Timurid khan of Ferghana, who afterwards founded the Mogul Empire in India, was driven from his ancestral dominions. In 1500 he inflicted a severe defeat on Baber's forces, and captured Samarkand, Herat and Kandahar. By these and other conquests he became possessed of all the country between the Oxus and the Jaxartes, of Ferghana, Khwarizm and Hissar, as well as of the territory of Tashkent from Kashgar to the frontiers of China. In the following year, by a dashing exploit, Baber recovered Samarkand, but only to lose it again a few months later. During several succeeding years Shaibani's arms proved victorious in many fields of battle, and but for an indiscreet outrage on the territories of the shah of Persia he might have left behind him a powerful empire. The anger, however, of Shah Ismail roused against him a force before which he was destined to fall. The two armies met in the neighbourhood of Merv, where, after a desperate encounter, the Uzbeks were completely defeated. Shaibani, with a few followers, sought refuge in a cattle-pound. But finding no exit on the farther side, the refugees tried to leap their horses over the wall. In this attempt Shaibani was killed (1510). When his body was recognized by his exultant enemies they cut off the head and presented it to the shah, who caused the skull to be mounted in gold and to be converted into a drinking-cup. After this defeat the Uzbeks withdrew across the Oxus and abandoned Khorasān. Farther east the news aroused Baber to renewed activity, and before long he reoccupied Samarkand and the province "Beyond the River," which had been dominated by the Uzbeks for nine years. But though the Uzbeks were defeated they were by no means crushed, and ere long we find their khāns reigning, now at Samarkand, and now at Bokhara. As time advanced and European powers began to encroach more and more into Asia, the history of the khanates ceases to be confined to the internecine struggles of rival khāns. Even Bokhara was not beyond the reach of Russian ambition and English diplomacy. Several European envoys found their way thither during the first half of the 19th century, and the murder of Stoddart and Conolly in 1842 forms a melancholy episode in British relations with that fanatical capital. With the absorption of the khanate of Bokhara and the capture of Khiva by the Russians the individual history of the Mongol tribes in Central Asia comes to an end, and their name has left its imprint only on the dreary stretch of Chinese-occupied country from Manchuria to the Altai Mountains, and to the equally unattractive country in the neighbourhood of the Koko-nōr.

BIBLIOGRAPHY.—Sir H. Howarth, *History of the Mongols* (1876, 1878); D'Ohsson, *Histoire des Mongols* (1834); Cahun, *Introduction à l'histoire d'Asie*; Köhler, *Die Entwicklung des Kriegswesens; Strakosch-Grossmann, Der Einfall der Mongolen in Mittel-Europa*; (for the general reader) Jeremiah Curtin, *The Mongols, a history* (1908). (R. K. D.)

Language.—The Mongol tongue is one of the members of the great stock which recent scholars designate as Ural-Altai, which also includes the Finno-Ugric, Turkish, Manchu and Samo-yede. The members of this group are not so closely related to one another as those of the Indo-European stock; but they are all bound together by the common principle of agglutinative formation, especially the so-called harmony of vowels, by their grammatical structure, and also by certain common elements in the stock of roots which run through them all, or through particular more closely-connected families within the group.¹ The fatherland proper of the Mongols is Mongolia (q.v.). The sum total of the Mongol population under Chinese government is calculated at between two and three millions.

Generally the whole Mongol tribe may be divided into three branches: East Mongols, West Mongols and Burjats.

1. The East Mongols are divided into the Kalkais in the borders just mentioned, the Shara Mongols south of the Gobi along the Great Wall north-eastward to Manchuria, and lastly the Shirairol or Sharaigol in Tangut and in northern Tibet.

¹ Compare W. Schott, *Versuch über die tatarischen Sprachen* (Berlin, 1836); *Ueber das alai'sche oder finnisch-tatarische Sprachen-geschichte* (Berlin, 1840); *Alai'sche Studien*, parts i.-v. (Berlin, 1860-1870); and A. Castrén, *Ethnologische Vorlesungen über die Alai'schen Völker*, ed. by A. Schiefner (St Petersburg, 1857).

2. On the signification and employment of the different names of the West Mongols (Kalmucks, Oelöd, Oirad or Dörbön Oirad = the four Oirad, Mongol Oirad), and also as regards the subdivision of the tribes, there is much uncertainty. The name Kalnuick, so generally employed among us, is in fact only used by the Volga Kalmucks (Khalimack), but even with them the name is not common, and almost a byname. It is of foreign origin, and most likely a Tataric word which has yet to be explained. *Oirad* means the "near ones," "the related." The usual explanation given is that the single tribes considered themselves as being related to each other—hence *Mongol-Oirad* = "the Mongol related tribe." This is the favorite name among Kalmucks. Dörbön Oirad, or the four related tribes, comprise (1) Dzungars, (2) Torgod, (3) Koshod, (4) Derbet. The signification of the name *Oelöd*, in the East Mongolian *Ogeled*, now the most widely-spread among the tribes living in China, is likewise very doubtful. Some assert that "Oelöd" is nothing but the Chinese transcription of Oirad, as the ordinary Chinese language does not possess the sound *r*. We have, however, to bear in mind that we have a Mongolian root *ögelekü*, with the sense of "to be inimical," "to bear hatred, ill-will," &c. The main population of the Kalmucks live, or rather drag out, their existence after the usual fashion of nomad tribes in Dzungaria, in the eastern part of the Tian-shan, on the south border of the Gobi, on Kök-nör, and in the province of Kan-suh. All these are under the Chinese government. In consequence, however, of the extension of the Russian empire in Tian-shan and Alatau, many herds have come under the Russian sway. According to an approximate account we may reckon in the territory Semiryetshensk (Kulja) and Semipalatinsk 34,000 Kalmucks, while in the southern part of the government Tomsk, on the Altai, the Kalmuck population amounted formerly to 19,000. Besides these we find a section of Kalmuck population far in the west, on the banks of the Volga (near Astrakhan). From their original seats in Dzungaria they turned in their migrations to the north, crossed the steppe of the Kirghiz, and thus gradually reached the Emba and the Or. Between these two rivers and the Ural the Torgod settled in 1616; hence they crossed the Volga in 1650, and took possession of the now so-called steppe of the Kalmucks, being followed in 1673 by the Derbet and in 1675 by the Koshod. In 1771 a considerable number returned to the Chinese empire. There is still a not unimportant population in the so-called steppe of the Kalmucks, which extends between the Caspian and the Volga in the east and the Don in the west, and from the town of Saratov in the north to the Kuma and the Marych in the south. According to the latest statistical accounts, this population amounts to 76,000. To these we have to add 25,000 more on the borders of the Cossacks of the Don, and lastly 8000 in the bordering provinces of Orenburg and Saratov.

3. In the southern part of the Russian province of Irkutsk, in a wide circle round Lake Baikal, lies the herdsmen proper of the Buriats, which they also call the "Holy Sea"; the country east of the lake is commonly called Transbaikalia. Their country practically extends from the Chinese frontier on the south almost parallel lines to the north, to the town Kironsk on the Lena, and from the Onon in the east to the Ola, a tributary of the Angara, in the west, and still farther west towards Nizhni-Udinsk. They are most numerous beyond the Baikal Lake, in the valleys along the Uda, the Onon and the Selenga, and in Nerchinsk. These Transbaikalian Buriats came to these parts only towards the end of the 17th century from the Kalkas. While Mongols and Kalmucks generally continue to live after the usual fashion of nomads, we find here agricultural pursuits, most likely, however, due mainly to Russian influence. Christianity is also making its way. The sum total of the Buriats amounts to about 250,000.

Another tribe separated from the rest of the Mongols is the so-called Hazära (the thousand), or the four Aimaks (i.e. tribes), who wander about as herdsmen, in Afghanistan, between Herat and Kabul. In external characteristics they are Mongols, and in all probability they are the remains of a tribe from the time of the Mongol dynasty. Their language, which shows, of course, Persian influence, is strictly Mongolian, more particularly West Mongolian or Kalmuck, as has been proved by H. C. von der Gabelentz.¹ Agreeably with this threefold division of the Mongols we have also a threefold division of their respective languages: (1) East Mongolian or Mongolian proper, (2) West Mongolian or Kalmuck, (3) Buriatic.

These dialects just mentioned are found to be in close relation to each other when we examine their roots, inflections and grammatical structure. The difference between them is indeed so slight that whoever understands one of them understands all. Phonetically a characteristic of them all is the "harmony of vowels," which are divided into two chief classes: the hard *a, ö, u* and the soft *e, ö, ü*, between which *i* is in the middle. All vowels of the same word must necessarily belong to the same class, so that the nature of the first or root-vowel determines the nature of the other or inflection-vowels; now and then a sort of retrogressive harmony takes place, so that a later vowel determines the nature of the former.

The consonants preceding the vowels are equally under their influence.

The Mongolian characters, which in a slightly altered form are also in use among the Manchus, are written perpendicularly from above downward, and the lines follow from left to right, the alphabet having signs for seven vowels—*a, e, i, o, u, ö, ü*, and diphthongs derived from them—*ao, ai, ei, öi, öi, öi, ai, öi, ai, öi*, and for seventeen consonants—*m, b, kh, gh, k, g, m, l, r* (never initial), *t, d, y, s, (ds), ts, ss, sh, shw*. All these are modified in shape according to their position, in the beginning, middle, or end of a word, and also by certain orthographic rules. In Mongolian and Manchu writing the syllable (i.e. the consonant together with the vowel) is considered as a unit, in other words a syllabarium rather than an alphabet. The existing characters are lineal descendants of the original Uighurian forms, which were themselves derived from the Syriac, having been brought to the Uighurs by Nestorian missionaries. An Indian and Tibetan influence may also be noticed, while the arrangement of the characters in perpendicular lines is common to the Chinese. The writing was brought into its present shape by the learned Lamas Saska Pandita, Phags-pa Lama, and Tshoitshi Ölser in the 13th century,² but is exceedingly imperfect. To express the frequently-occurring letters borrowed from Sanskrit and Tibetan, which are wanting in the Mongol alphabet, a special alphabet, called Galik, is employed. Every one who has tried to read Mongolian knows how many difficulties have to be overcome, arising from the ambiguity of certain letters, or from the fact that the same sign is to be pronounced differently, according to its position in the word. Thus, there are no means for distinguishing the *o* and *u*, *ö* and *ü*, the consonants *g* and *kh*, *t* and *d*, *y* and *s* (*ds*). *A* and *e* (*u*) and *ö* (*ü*), *a* (*e*) and *ö* (*kh*), *t* (*d*) and *on*, are liable to be mistaken for each other. Other changes have not been noticed and advanced students. They can't defect that such common words as *aldan* (a furry) and *ende* (here), *ende* (here) and *nada* (me), *aldan* (fathom) and *aldan* (gold), *ordu* (court-residence) and *urtu* (long), *onukhu* (to seize) and *sunukhu* (to ride), *tere* (this) and *dere* (pillow), *gebe* (said) and *kebe* (made), *gem* (evil) and *kem* (measure), *ger* (house) and *ker* (how), *naran* (sun) and *nere* (name), *yagon* (what) and *dsagon* (hundred), should be written exactly alike. This list might be largely increased. These defects apply equally to the Mongolian and Buriatic alphabets.

In 1648 the Sava Pandita composed a new alphabet for the Kalmuck, in which these ambiguities are avoided, though the graphic differences between the two alphabets are only slight. The Kalmuck alphabet avoids the angular and clumsy shapes of the Mongolian, and has, on the contrary, a rounded and pleasing shape. The Kalmuck alphabet has also this great advantage—that every sound has its distinct graphic character; a mistake between two characters can scarcely occur. The Kalmuck words once mastered, they can be easily recognized in their Mongolian shape. The dialectical differences are also very slight.

The Kalmuck, therefore, is the key of the Mongolian, and should form the groundwork of Mongolian studies. The Kalmuck and East Mongolian dialects do not differ much, at least in the spoken language; but the Kalmucks write according to their pronunciation, while the Mongols do not. For example, *dsön* ("hundred") is pronounced alike by the Kalmucks and the East Mongolians; but according to Mongolian orthography the word appears in the form *dsagon*. The dialectic difference between the two dialects very frequently lies only in a different pronunciation of some letters. Thus East Mongolian *ds* is in Kalmuck soft *s*, &c. The chief difference between the two dialects lies in the fact that in Kalmuck the soft guttural *g* between two vowels is omitted, while, through the joining of the two vowels, a long vowel is produced. In the pronunciation of common East Mongolian the *g* is likewise omitted, but it is written, while in Kalmuck, as just now mentioned, the natural *g* only is placed through the lengthening of the syllable. Thus we find: Mongol *khan*, "prince." Kalmuck *khan*: *M. dagon*, "voice, sound," *K. dön, dön, m. dologan*, "seven," *K. dölon*; *M. agola*, "mountain," *K. öla, öla, M. nagor*, "lake," *K. nör, nür*; *M. ulagan*, "red," *K. ulän*; *M. yagon*, "what," *K. yön (yün)*; *M. dabagan*, "mountain ridge," *K. dabän*; *M. ssanagan*, "thought," *K. ssanän*; *M. baragan*, "on the right," *K. barön, barün*; *M. shibagan*, "bird," *K. shovön*; *M. chilagan*, "stone," *K. chilon (chulan)*; *M. jiragan*, "six," *K. surän*; *M. degers*, "high, above," *K. däre*; *M. ugukhu*, "to drink," *K. akhu*; *M. togodsh*, "history," *K. dösh*; *M. agöshin*, *M. agöshin*, "dome," *K. öshin*; *M. gagedä*, "K. sön"; *M. ögedä*, "in the height," *K. ödö*; *M. ögedä*, "the Kalmucks," *K. öld*; *M. ülgedä*, "if one has done," *K. ülädä*; *M. häbegan*, "son," *K. künön*; *M. gegün*, "marc," *K. күн*; *M. kegir*, "corpse," *K. här*; *M. khariagd*, "returned," *K. khäräd*, &c.

The Buriatic, in these peculiarities, is almost always found with East Mongolian, with which it is in every respect closely allied. In the pronunciation of some letters the transition of East Mongolian *tsa*, *ts* into Buriatic *s* is noticeable; for instance: *Mong. tsetsek*, "flower," Buriatic *ssessek*; *M. tsak*, "time," *B. ssak*; *M. tsagan*, "white," *B. ssagan*; *M. tseshen*, "prudent," *B. sseshen*. "Sis" sometimes pronounced like (the German) *ch*: East *M. ssan*, "good," *B.*

¹ See his essay, "Ueber die Sprache der Hazäras und Aimaks," in the *Zeitschrift der deutschen morgenländischen Gesellschaft*, x. 326-335.

² Cf. H. C. von der Gabelentz, in the *Zeitschrift f. ö. Kunde d. Morgenlandes* (Göttingen, 1838), ii. 1-21, "Versuch über eine alte mongolische Inschrift."

chain; *M. ssedkii*, "heart," *B. chedkii*. *K* in the beginning or middle of a word is always aspirated.

The noun is declined by the help of appended particles, some of which are independent post-positions, viz. *Gen. yin*, *u*, *ur*; *Dat. dur*, *ai*; *Acc. yi*, *i*; *Ablat. etse*; *Instrum. ber*, *yer*; *Associative, luga*, *luge*. The dative and accusative have also special forms which have at the same time a possessive sense, viz. *Dat. dagan*, *degen*; *Acc. ben*, *yen*. The plural is expressed by affixes (*nar*, *ner*, *od*, *ssu*, *d*), or frequently by words of plurality, all, "many," e.g. *manai*, *nogai* (many men). The oblique cases have the same endings in singular and plural. Gender is not indicated. The adjective is uninflected both as attribute and as predicate; there is no comparative form, this idea being expressed by the construction or by the use of certain particles. The personal pronouns are *bi*, *i*; *ichi*, thou; *bida*, we; *ta*, ye; their genitives serve as possessives. The demonstratives are *ene*, *tere* (this, that), plural *ede*, *tede*; interrogative *ken*, who? The relative is lacking, and its place is supplied by circumlocutions. The numerals are: 1, *nigen*; 2, *khozar*; 3, *gurban*; 4, *döben*; 5, *labun*; 6, *jirgagan*; 7, *dölogan*; 8, *naiman*; 9, *yisun*; 10, *arban*; 100, *dasan*; 1000, *minggan*. The ordinals are formed by appending *lugar*, *lüger*. The theme of the verb is seen in the imperative, as *bart*, grasp. The conjugation is rich in forms for tense and mood, but the person and number are with few exceptions unexpressed. The present is formed from the theme by adding *mui* (*barimus*), the preterite by *bat* or *luga* (*baribai*, *bariluga*), the future by *ssugai* or *ssu* (*barissugai*, *barissu*). The preterite has also in the third person the terminations *dsugui* and *run*; the future has in the third person *yu*, and in the first *ya*. The conditional ends in *bassu* (*baribassu*), the precative in *luga*, *lüge*, the potential in *sa* (*barissau*), the imperative plural in *manai*. The gerund in the present is *ni ssu* (*barin*, *barissu*, or *talai*, "white, till" (*barialta*, "inter capiendum"), in the preterite it is formed in *gad* (*barigad*); the present part. has *kichi* (*barikichi*), the past part. *ksan* (*barikksan*); the supine ends in *ra*, the infinitive in *khü* (*barikhü*, or when used substantively *barikhü*). There is but one perfectly regular conjugation, and derivative forms, derived from the theme by infixes, are conjugated on the same scheme. Thus the passive has infixed *ta* or *hda* (*barihdakhü*, to be grasped), the causative *gü* (*barigükhü*, to cause to grasp), the co-operative or sociative *issa* or *ida* (*barihssakhü*, to grasp together).

Verbs are either preterite or present, and adverbs are either simple particles (affirmative, negative, interrogative, modal, &c.) or are formed by suffixes from other parts of speech. There are very few conjunctions; the relations of clauses and sentences are mainly indicated by the verbal forms (part., sup., conditional, but mainly by the gerund).

The order of words and sentences in construction is pretty much the opposite of that which we follow. In a simple sentence the indication of time and place, whether given by an adverb or a substantive with a post-position, always comes first; then comes the sentence always preceded by its active or negative, then the object and other cases depending on the verb, last of all the verb itself preceded by any adverbs that belong to it. So in the structure of a period all causal, hypothetical, concessive clauses, which can be conceived as preceding the main predication in point of time, or even as contemporary with it, or as in any way modifying it, must come first; the finite verb appears only at the end of the main predication or apodosis. The periods are longer than in other languages; a single one may fill several pages.

AUTHORITIES. Grammars and dictionaries may be divided according to the three dialects, East Mongolian, Kalmuck, and I. J. Schmidt gave the first grammar (St Petersburg, 1831), and the first German-Russian dictionary (St Petersburg, 1831). Next Jos. Kovalyevskii published in Russian a Mongolian grammar (Kasan, 1835), a chrestomathy (2 vols., Kasan, 1836, 1837), and his great *Dictionnaire mongol-russe-français* (3 vols., Kasan, 1844, 1846, 1849). We may mention R. Yuille, *Short Mongolian Grammar* (in Mongolian), xylographed at the mission press near Selenginsk beyond Lake Baikal (1838). A. Bobrovnikov's Russian Grammar of the Mongolian-Kalmuck Language (Kasan, 1849) is also very good. An abridgment of Schmidt's work is C. Funi, *Elementi della grammatica mongolica* (Florence, 1875). A. Popov's *Mongolisch-Russisches Wörterbuch* appeared in 2 vols. at Kasan (1846). For the Kalmuck we have grammars by Popov (Kasan, 1847), Bobrovnikov, as above, and H. A. Zwick (*s. l. e. a.*), autographed at Donaueschingen (1851). Zwick's autographed Kalmuck and German dictionary with a printed German index appeared (*s. l. e. a.*) in 1852; B. Jülg's edition of the tales of Siddhi-kür (Leipzig, 1866) gives a complete glossary to these stories. There are small Russian and Kalmuck vocabularies by P. Smirnov (Kasan, 1857) and C. Golstunsky (St Petersburg, 1860). For the Buriatic we have Castryén, *Versuch einer buriatischen Sprachlehre*, etc. (Leipzig, 1857), and A. Popov's Russian grammar of the Mongol-Buriatic colloquial language (Kasan, 1878).

Literature.—A clear distinction must be drawn between the higher and nobler written or book-language and the common or conversational language of every-day life. The difference between the two is very considerable, and may be fairly compared to that between the modern High German book-language and the different dialects. All grammars and dictionaries as yet published treat only of the book-language; and so also, with a few exceptions, the published

literary documents are written in this higher style. The exceptions are the *Gesser-Khan*, and the *Siddhi-kür* and *Djanganai* (the last two published by Golstunsky). The popular or conversational language has been fixed in writing by A. Pozdnev in his Russian work, *Specimens of the Popular Literature of the Mongolian Tribes*, pt. i., "Popular Songs" (St Petersburg, 1860), which contains rich material for the study of the popular literature.

The literature consists mostly of translations from the Tibetan, the holy language of Buddhism, which is still the language of the learned. The Tibetan Buddhist literature is itself translated from the Sanskrit; hence, now and then, through Mongols and Kalmucks we get acquainted with Indian works the originals of which are not known in Sanskrit. Such is the case, for instance, with the tales of Siddhi-kür. Many books have also been translated from the Chinese. Most of the writings are of a religious, historical, philosophical, medical, astronomical or astrological character. Favourite subjects are folk-lore and fairy tales. Among the religious books, perhaps the most important is that containing the legends entitled *lüger ni dalai*, "ocean of comparisons" (ed. by I. Jacob Schmidt under a title, *Der Weise und der Thor*, in Tibetan and German (St Petersburg, 1843). To this may be added the *boddhi mer*, "the holy path," the *altan grel*, "gleaming of gold," the *mani gambo* and *yerlünchü yin tolt*, "mirror of the world." What was known of poetical literature before Pozdnev is scarcely worth mentioning. In some parts of the historical and narrative literature we find, wherever the narrative takes a higher flight, an admixture of poetical diction. The poetry appears in a certain parallelism of the phrases, with a return either of the same endings (rhyme) or of the same words (refrain). Frequently we find, besides the rhyme or refrain, alliteration. The essay of H. C. von der Gabelenz in *Z. f. Kunde des Morgenlandes*, i. 200, in the yet unfinished mongolische Poesie, "has been superseded by the work of Pozdnev.

Among historical works a high place is due to that composed by the tribal prince, Sanaag Setzen, in the middle of the 17th century (*Geschichte der Ost-Mongolen und ihres Fürstenhauses*, Mongolian and German, by I. J. Schmidt, St Petersburg, 1829), and to the *Allian iobichi*, i. e. "golden knob" or "precious contents" (text and Russian trans. by the Lama Galsang Gomboyev, St Petersburg, 1858). Of folk-lore and fairy tales, we have the legend of the hero *Gesser-Khan* (text ed. by I. J. Schmidt, St Petersburg, 1836, and German version, 1866), *Der Weise und der Sage* (*Gesser-Khan*, Berlin, 1851), and B. Jülg in the *Transactions of the Burgher Phil. Versam.* of 1868, pp. 58 sqq., Leipzig, 1869); and the tales about *Ardschi Bordschi* (Russian version by Galsang Gomboyev, St Petersburg, 1858; text and German trans. by B. Jülg, Innsbruck, 1867, 1868). A favourite book is the tales of Siddhi-kür, based on the Sanskrit *Vedla panchavintai* (Russian trans. by Galsang Gomboyev, St Petersburg, 1865, nine of the tales in Mongolian and German, by B. Jülg, Innsbruck, 1868). The fuller collection of these tales in Kalmuck first became known by the German trans. of B. Bergmann in vol. i. of his *Nomadische Kreenfeyen unter d. Kalmücken* (4 vols., Riga, 1804, 1805); an autographed edition in the yugai dialect, was published by C. Golstunsky (St Petersburg, 1864); text and German trans. with glossary by B. Jülg (Leipzig, 1866). A poetic heroic story is the *Djanganai*, extracts from which were given by Bergmann (*op. cit.*, iv. 181 sqq.); a complete Russian version by A. Bobrovnikov (St Petersburg, 1854); a German version by F. v. Erdmann in *Z.D.M.G.*, 1857 (Kalmuck text by Golstunsky, St Petersburg, 1864). A similar poem is the history of Ubasha Khuntaidshi and his war with the Orad, Kalmuck text and Russian trans. by G. Gomboyev in his *Altan tobtschi* as above, and text alone autographed by Golstunsky (St Petersburg, 1866). Some relics of religion for the Christian Buriats (transcribed in Russian characters) represent the Burgher Phil. The Russian and English Bible Societies have given us a translation of the whole Bible. I. J. Schmidt translated the Gospels and the Acts into Mongolian and Kalmuck for the Russian Bible Society (8 vols., St Petersburg, 1819-1821)—a masterly work. The English missionaries, E. Stallybrass and W. Swan, and afterwards R. Yuille, translated the whole Old Testament into Mongolian (1836-1840). This work was printed at a mission press erected at Siberia for the purpose near Selenginsk, beyond Lake Baikal in great cost. In 1840 the Testament by the same hands appeared at London.

AUTHORITIES.—The richest collections of Mongolian and Kalmuck printed books and MSS. are in the Asiatic museum of the St. Petersburg Academy, and in the libraries of Kasan and Irkutsk; there is also a good collection in the royal library at Dresden. Consult in general, besides the already-cited works of Bergmann and Pozdnev, P. S. Pallas, *Sammlungen historischer Nachrichten ü. d. mongolischen Völkerschaften* (2 vols., St Petersburg, 1776-1801); I. J. Schmidt, *Forschungen im Gebiete der älteren . . . Bildungsgeschichte der Völker Mittelasiens, vorz. d. Mongolen und Tibeter* (St Petersburg and Leipzig, 1824); B. Jülg, "On the Present State of Mongolian Researches," *Journ. R. As. Soc.*, xiv. (1882), pp. 42-65. (B. J.)

MONG PAI (called *Mohyè* by the Burmese), the most south-westerly of the British Shan States of Burma. It has an approximate area of 1000 sq. m., and a population (1901) of 19,351. The general character of the country is hilly, rising westwards in a gentle slope from the chief stream, the Nam Hpilu or Balu.

This is navigable for native boats throughout the year to the point where it sinks underground in Karen-ni. The chief cultivation is rice, with about two acres of dry or hill rice to one of wet bottom. The hill fields are left fallow for ten years after two years' cultivation. The chief, the Sawbwa Hkun Yon, held charge through the reigns of four Burmese kings, and submitted early in 1887 on the first arrival of British troops. He abdicated in favour of his son in 1890, and died a few years later.

MÔNG PAN (the Burmese *Maingpan*), a state in the eastern division of the southern Shan States, lying approximately between 19° 45' and 20° 25' N. and between 98° and 99° E., with an area of 2299 sq. m., and a population (1901) of 16,629. The main state lies, except for a few insignificant circles, entirely west of the Salween, but beyond that river are the four sub-feudatory states of Mông Tun, Mông Hang, Mông Kyaw and Mông Hta. The only considerable area of flat land is round the capital, which lies in a large and fertile plain, marking roughly the centre of the state. From this plain rise on all sides low hills covered with scrub jungle, sloping up to ranges of about 5000 ft. on nearly every side. Rice is the only crop, irrigated where possible; elsewhere dry cultivation prevails. The state has valuable teak forests on both sides of the Salween, which cover a considerable but undetermined area. The general altitude of the valleys is about 2000 ft. The capital is small, and has only about 200 houses. The chief is of Sawbwa rank.

MONGREL (earliest form *mengrel*, probably from the root *meng-*, or *mong-*, to mix, cf. mingle, among), a dog that is the progeny of two different breeds, or one whose breed it is impossible to tell on account of the various crossings. In the case of other animals or plants it is the result of a fertile cross between two varieties of the same species, and so to be distinguished from a "hybrid." the result of a fertile cross between two distinct species (see **HYBRIDISM**).

MONIER-WILLIAMS, SIR MONIER (1819-1899), British orientalist, son of Colonel Monier-Williams, surveyor-general in the Bombay presidency, was born at Bombay on the 12th of November 1819. He matriculated at Oxford from Balliol College in 1837, but left the university on receiving in 1839 a nomination for the East India Company's civil service, and was completing his course of training at Haileybury when the entreaties of his mother, who had lost a son in India, prevailed upon him to relinquish his nomination and return to Oxford. As Balliol was full, he entered University College and, devoting himself to the study of Sanskrit, he gained the Boden scholarship in 1843. After taking his degree he was appointed professor of Sanskrit, Persian and Hindustani at Haileybury, where he remained until the abolition of the college upon the transfer of the government of India from the Company to the Crown. He taught oriental languages at Cheltenham for ten years, and in 1860 was elected Boden professor of Sanskrit at Oxford after a contest with Professor Max Müller (*q.v.*), which attracted great public interest and severe criticism, the motive of the non-resident voters, whose suffrages turned the scale, being notoriously not so much to put Monier-Williams in as to keep Max Müller out. Although, however, far inferior to his rival in versatility and literary talent, Monier-Williams was in no way inferior in the special field of Sanskrit, and did himself and his professorship much honour by a succession of excellent works, among which may especially be named his Sanskrit-English and English-Sanskrit dictionaries, his *Indian Wisdom* (1875), an anthology from Sanskrit literature; and his translation of *Sakuntala* (1853). In his later years he was especially attracted by the subject of the native religions of India, and wrote popular works on Brahmanism, Buddhism and Hinduism. His principal undertaking, however, was the foundation of the Indian Institute at Oxford, which owes its existence entirely to him. He brought the project before the university in May 1875, and in that year and the following, and again in 1883, visited India to solicit the moral and financial support of the native princes and other leading men. Lord Brassey came to his aid with a donation of £9000, and in November 1880 the institute was adopted by the university, but the purchase of a site and the erection of a building were left

to the professor. Upwards of £30,000 was eventually collected; the prince of Wales, in memory of his visit to India, laid the foundation stone in May 1883; and the edifice, erected in three instalments, was finally completed in 1896. Ere this, failing health had compelled Monier-Williams to withdraw from the active duties of his professorship, which were discharged by the deputy-professor, Dr A. Macdonell, who afterwards succeeded him. He continued, nevertheless, to work upon Sanskrit philology until his death at Cannes on the 11th of April 1899. He had been knighted in 1886, and was made K.C.I.E. in 1889, when he adopted his Christian name of Monier as an additional surname.

MONISM (from Gr. *μόνος*, alone), the philosophic view of the world which holds that there is but one form of reality, whether that be material or spiritual. The aim of knowledge is explanation, and the dualism or pluralism which acquiesces in recognizing two or more wholly disparate forms of reality has in so far renounced explanation (see **DUALISM**). To this extent monism is justified; but it becomes mischievous if it prompts us to ignore important differences in facts as they present themselves to our intelligence. All forms of monism from Plotinus downwards tend to ignore personal individuality and volition, and merge all finite existence in the featureless unity of the Absolute; this, indeed, is what inspires the passion of the protest against monism. Turning to the historical forms of the theory we may class Plotinus as a mystical monist: he attains to the One which is the All by an act of mystic union raising him above the phenomenal sphere. Spinoza is a materialist monist with an inconsistent touch of mysticism and a certain concession, more apparent than real, to the spiritual side of experience. Hegel's is an intellectualist monism, explaining matter, sensation, personal individuality and will as forms of thought. The doctrine of Schopenhauer and von Hartmann is a monism of cosmic will which submerges the individual no less completely than Hegelianism, though in a different manner. Haeckel's monism is mere materialism dignified by a higher title. Those who maintain that all these forms of synthesis are hasty and superficial stand by the conviction that the right philosophic attitude is to accept provisionally the main distinctions of common sense, above all the distinction of personal and impersonal; but to press forward to the underlying unity so far as experience and reflection justify.

See **ABSOLUTE; DUALISM; METAPHYSICS; MATERIALISM; IDEALISM.**

MONITION, or **ADMONITION** (Lat. *monere*, to admonish), in English ecclesiastical law, an order requiring or admonishing the person complained of to do something specified in the monition, or appear and show cause to the contrary, "under pain of the law and penalty thereof." It is the lightest form of ecclesiastical censure, whether to clergymen or laymen, but disobedience to it, after it has been duly and regularly served, entails the penalties of contempt of court. Monitions of a disciplinary character are either for the purpose of enforcing residence on a benefice, or in connexion with suits to restrain ritual alleged to be unlawful.

MONITOR (from Lat. *monere*, to warn, advise), an advisor or counsellor, one who warns another person as to his course of action, also used of things that are more or less personified, as conscience. The word is chiefly applied to senior pupils (also known as "prefects") in some of the great secondary schools in England; in America to senior students in certain colleges to whom special duties are assigned, particularly that of keeping order; and also to pupil teachers in English elementary schools. It is used in a general way of anything that gives warning, and in this sense is applied to a lizard of the family *Monitoridae*, or *Varanidae*, found in Africa and Australia, which is supposed to give warning of the approach of crocodiles. The name of monitor was also given to a particular kind of ironclad invented for the American navy by Captain John Ericsson (*q.v.*) in 1862, which had a very low freeboard and revolving gun-turrets. The letter of Ericsson to the assistant secretary of the navy, of the 20th of January 1862 (quoted in the *Century Dictionary*), gives the inventor's reason for the name. "The impregnable and aggressive character of this structure will admonish the leaders of the Southern Rebellion that the batteries on the banks

of their rivers will no longer present barriers to the entrance of the Union forces. The ironclad intruder will thus prove a severe monitor to those leaders . . . 'Downing Street' will hardly view with indifference this last 'Yankee notion,' this monitor.' It is also the name of an ironclad railway truck used for carrying a big gun. In America the raised part of the roof of a railway carriage or omnibus in which the lights or ventilators are placed is known as a monitor roof or top. In mining the word is applied to a jointed nozzle which may be turned in all directions, and is used in hydraulic mining.

MONK (or **MONCK**), **GEORGE**, 1ST DUKE OF ALBEMARLE (1608-1669), second son of Sir Thomas Monk, a gentleman of good family but in embarrassed circumstances, was born at Potheridge, near Torrington, in Devonshire, on the 6th of December 1608. Having thrashed the under-sheriff of the county in revenge for a wrong done to his father, he had to leave home, and naturally took to the career of arms. He served as a volunteer in the expedition to Cadiz, and the next year did good service at the Isle of Rhé. In 1629 Monk went to the Low Countries, then the school of war, and there he gained a high reputation as a leader and disciplinarian. In 1638 he threw up his commission in consequence of a quarrel with the civil authorities of Dordrecht, and came to England. He obtained the lieutenant-colony of Newport's regiment. During the operations on the Scottish border he showed his skill and coolness in the dispositions by which he saved the English artillery at Newburn, though himself destitute of ammunition. At the outbreak of the Irish rebellion he was appointed colonel of Lord Leicester's regiment. All the qualities for which he was noted through life—his talent of making himself indispensable, his imperturbable temper and his impenetrable secrecy—were fully displayed in this employment. The governorship of Dublin was vacant, and Monk was appointed by Leicester. But Charles I. overruled the appointment in favour of Lord Lambert, and Monk with great shrewdness gave up his claims. Ormonde, however, who viewed him with suspicion as one of the two officers who refused the oath to support the Royal cause in England, sent him under guard to Bristol. But he justified himself to Charles in person, and his soldierly criticisms on the conduct of the Irish War impressed the king, who gave him a command in the corps sent over from Ireland during the English Civil War. Monk was, however, soon taken prisoner, at Nantwich (1644), and spent the next two years in the Tower, where he found it difficult to live owing to his want of means. The king himself sent him £100, a gift for which Monk himself was sincerely grateful. He beguiled his imprisonment by writing his *Observations on Military and Political Affairs*.

Monk's Irish experience, however, led to his release and an invitation to take service in the parliament's army against the Irish rebels. Making a distinction like other soldiers of the time between fighting the Irish and taking arms against the king, he accepted the offer and took the covenant. At first as adjutant-general to the Parliamentary lord-lieutenant, his old friend Lord Lisle, and afterwards as governor of Ulster, he rendered great services to his new masters. In conjunction with Colonel Michael Jones, governor of Leinster, he made head against the rebels for two years, but in the third (1649) the Parliamentarians, weakened by defections brought about by the execution of the king, were no longer able to keep the field. Losing one strong place after another, Monk concluded an armistice with the rebel Owen Roe O'Neill upon terms which he knew the parliament would not ratify. The convention was indeed a military expedient to deal with a military necessity, and although most of his army went over to the Royalist cause, he himself remained faithful to his employers and returned to England. As he expected, parliament "utterly disapproved" of the armistice but exonerated their general. His next service was in Cromwell's army in Scotland. He commanded a brigade at the great victory of Dunbar, and afterwards captured a number of small places. When in 1651 Cromwell with the field army hurried southward into England to bring the invading Scots to battle, Monk was left behind to complete the

subjugation of the country. In February 1652 he left Scotland to recruit his broken health at Bath, and in November of the same year he became an admiral, or rather a "general at sea," instead of a soldier. Ten days after hoisting his flag for the first time he was engaged with his colleagues, Blake and Deane, in the battle of Portland (Feb. 18, 1653). In the action of June 2-3 Monk exercised the general command after Deane's death. A third battle followed on the 29th and 30th of July, which was a decisive victory for the Commonwealth's fleet (see DUTCH WARS). On his return he married Anne Clarges, a woman of low extraction, often supposed to have been his mistress, "ever a plain homely dowdy," says Pepys, who, like other writers who mention her, is usually less complimentary. Next year he was back in Scotland, methodically beating down a Royalist insurrection in the Highlands, and when this service was over settled down to a steady government of the country for the next five years. The timely discovery of a plot fomented by Overton, his second in command, in 1654, gave him an excuse for thoroughly purging his army of all Anabaptists, Fifth Monarchy men, and other dangerous enthusiasts. It is improbable that at this time Monk had proposed to himself the restoration of the king, though so astute a diplomatist must have weighed the chances of such an event. His very reticence, however, caused alarm on one side and hope on the other. In 1655 he received a letter from Charles II., a copy of which he at once sent to Cromwell, who is said to have written to him in 1657 in the following terms: "There be that tell me that there is a certain cunning fellow in Scotland called George Monk, who is said to lye in wait there to introduce Charles Stuart; I pray you, use your diligence to apprehend him, and send him up to me." Monk's personal relations with Cromwell were those of sincere friendship on both sides.

During the confusion which followed Cromwell's death Monk remained silent and watchful at Edinburgh, careful only to secure his hold on his troops. At first he contemplated armed support of Richard Cromwell, but gave up this idea on realizing the young man's incapacity for government, and renewed his waiting policy. In July 1659 direct and tempting proposals were again made to him by the king. His brother Nicholas, a clergyman, was employed by Sir J. Grenville to bring to him the substance of Charles's letter. No bribe, however, could induce him to act one moment before the right time. He bade his brother go back to his books, and refused to entertain any proposal. But when Booth rose in Cheshire for the king, so tempting did the opportunity seem that he was on the point of joining forces with him, and a manifesto was prepared. His habitual caution, however, induced him to wait until the next post from England, and the next post brought news of Booth's defeat.

For a moment he thought of retiring into private life, but soon Fleetwood and Lambert declared against the parliament, and to their surprise Monk not only refused to join them, but (Oct. 20, 1659) at once took measures of active opposition. Securing his hold on Scotland by a small but trusty corps of occupation, he crossed the border with the rest of his army. Holding Lambert in play without fighting until his army began to melt away for want of pay, Monk received the commission of commander-in-chief of the parliament's forces (Nov. 24). The navy, some of the English garrisons and the army in Ireland declared for the parliament, and the army from Scotland crossed the Tweed on the 2nd of January 1660. It was inferior in number, but in all other respects superior to Lambert's, and Monk slowly marched on to London, disbanding or taking over on his way the detachments of Lambert's army which he met, and entered the capital on the 3rd of February. In all this his ultimate purpose remained mysterious. At one moment he secretly encouraged the demands of the Royalist City of London, at another he urged submission to the existing parliament, then again he refused to swear an oath abjuring the house of Stuart, and further he hinted to the attenuated Long Parliament the urgent necessity of a dissolution. Lastly, acting as the stern military agent of the infuriated parliament, he took away the gates and portcullises of the city. This angered not only the

citizens but his own army, and gave him the lever that he desired to enforce the dissolution of parliament, while at the same time enabling him to break up as a matter affecting discipline, the political camarillas that had formed in his own regiments. He was now master of the situation, and though he protested his adherence to republican principles, it was a matter of common knowledge that the new parliament, which Monk was imposing on the remnant of the old, would have a strong Royalist colour. Monk himself was now in communication with Charles II., whose Declaration of Breda was based on Monk's recommendations. The new parliament met on the 25th of April, and on the 1st of May voted the restoration of the monarchy.

With the Restoration the historic interest of Monk's career ceases. Soldier as he was, he had played the difficult game of diplomacy with incomparable skill, and had won it without firing a shot. That he was *victor sine sanguine*, as the preamble of his patent of nobility stated, was felt by every one to be the greatest service of all. He was made gentleman of the bedchamber, knight of the Garter, master of the horse and commander-in-chief, raised to the peerage with the titles of Baron Monk, earl of Torrington and duke of Albemarle, and had a pension of £7000 a year allotted to him. As long as the army existed of which he was the idol, and of which the last service was to suppress Venner's revolt, he was a person not to be displeased. But he entirely concurred in its disbandment, and only the regiment of which he was colonel, the Coldstream (Guards), survives to represent the army of the Civil Wars. In 1664 he had charge of the admiralty when James, duke of York, was in command of the fleet, and when in 1665 London was deserted on account of the plague, Monk, with all the readiness of a man accustomed to obey without thinking of risk, remained in charge of the government of the city. Once more, at the end of this year, he was called upon to fight, having a joint commission with Prince Rupert against the Dutch. The whole burden of the preparations fell upon him. On the 23rd of April 1666 the admirals joined the fleet, and on the 1st of June began the great four days' battle, in which Monk showed not only all his old coolness and skill, but also a reckless daring which had seemed hitherto foreign to his character. Later in the same year he maintained order in the city of London during the Great Fire. His last service was in 1667, when the Dutch fleet sailed up the Thames, and Monk, though ill, hastened to Chatham to oppose their farther progress. From that time he lived much in privacy, and died of dropsy on the 3rd of January 1670, "like a Roman general with all his officers about him." The dukedom came extinct on the death of his son Christopher, 2nd duke of Albemarle (1653-1688).

See the *Life* of Monk, by Dr Gumble, his chaplain (London, 1671), and the memoir and bibliography by C. H. Firth in the *Dict. Nat. Biogr.*

MONK, JAMES HENRY (1784-1856), English divine and classical scholar, was born at Buntingford, Herts. He was educated at Charterhouse School and Trinity College, Cambridge, and in 1809 was elected professor of Greek in succession to Porson. The establishment of the classical tripos was in great measure due to his efforts. In 1822 he was appointed dean of Peterborough; in 1830, bishop of Gloucester (with which the see of Bristol was amalgamated in 1836). He is best known as the author of a *Life of Bentley* (1830) and as the editor (with C. J. Blomfield) of Porson's *Adversaria* (1812).

MONK, MARIA (c. 1817-1850), an adventuress and impostor, who, coming to New York in 1835, claimed to have escaped from the Montreal nunnery of the Hôtel Dieu, concerning which, and the practices prevalent there, she circulated sensational charges in *Awful Disclosures by Maria Monk* (1836). Over 200,000 copies of this book and a sequel were sold, and a violent anti-Catholic agitation resulted. She was finally exposed as a woman of bad character, and her story proved to be absolutely false, but not until she had deceived many people of good standing.

MONK (O.Eng. *munc*; with this the Teutonic forms, e.g. Du. *monnik*, Ger. *Mönch*, and the Romanic, e.g. Fr. *moine*, Ital. *monacho* and Span. *monje*, are from the Lat. *monachus*, adapted

from Gr. *μοναχός*, one living alone, a solitary; *μύνος*, alone), a member of a community of men living a life under vows of religious observance; the term is properly confined to a member of a Christian community, but is sometimes applied to members of Buddhist and Mahomedan religious brotherhoods. The Greek and Latin name was first used of the hermits, but was early widened to embrace the cenobites. The term "monk" should not be used either of "friars" or of "canons regular." (See MONASTICISM.)

MONKEY, a term apparently applicable to all members of the order PRIMATES (q.v.) except man and perhaps the larger apes. In zoology it may be used in this wider sense, as inclusive of all the Primates except man and lemurs; but it may also be employed in a more restricted application, so as to denote all ordinary "monkeys" as distinct from baboons on the one hand and the tail-less man-like apes on the other. The word appears in English first in the 16th century. The Low-German version of *Reynard the Fox* (*Reinke de Vos*, 1479) calls the son of Martin, the ape, *Moncke*; and the French version has *Monnekin*, *Monnequin*; these are apparently Teutonic diminutives of a word for ape which occurs in several Romanic languages, e.g. Fr. *monne*, It. *monna*, &c.

MONKHOUSE, WILLIAM COSMO (1840-1901), English poet and critic, was born in London on the 18th of March 1840. His father, Cyril John Monkhouse, was a solicitor; his mother's maiden name was Delafosse. He was educated at St Paul's School, quitting it at seventeen to enter the board of trade as a junior supplementary clerk, from which grade he rose eventually to be the assistant-secretary to the finance department of the office. In 1870-1871 he visited South America in connexion with the hospital accommodation for seamen at Valparaiso and other ports; and he served on different departmental committees, notably that of 1894-1896 on the Mercantile Marine Fund. He was twice married: first, to Laura, daughter of James Keymer of Dartford; and, secondly, to Leonora Eliza, daughter of Commander Blount, R.N. He died in London on the 20th of July 1901. Cosmo Monkhouse was one of those who have not only a vocation, but an avocation. His first bias was to poetry, and in 1865 he issued *A Dream of Idleness and Other Poems*, a collection strongly coloured by his admiration for Wordsworth and Tennyson. It was marked by exceptional maturity, and scarcely received the recognition it deserved. Owing perhaps to this circumstance, it was not till 1890 that he put forth *Corn and Poppies*, a collection which contains at least one memorable effort in the well-known "Dead March." Five years later appeared a limited edition of the striking ballad of *The Christ upon the Hill*, illustrated with etchings by Mr William Strang. After his death his poetical output was completed by *Pastiles the Elder and other Poems* (including *The Christ upon the Hill*). In 1868 Monkhouse essayed a novel, *A Question of Honour*. Then, after prelude with a *Life of Turner* in the "Great Artists Series" (1879), he devoted himself almost exclusively to art criticism. Besides many contributions to the *Academy*, the *Saturday Review*, the *Magazine of Art* and other periodicals, he published volumes on *The Italian Pre-Raphaelites* (1887), *The Earlier English Water-Colour Painters* (1890 and 1897), *In the National Gallery* (1895) and *British Contemporary Artists* (1899). He was a contributor to the *Dict. Nat. Biog.* from the beginning. Monkhouse also wrote an excellent *Memoir of Leigh Hunt* in the "Great Writers Series" (1887). As an art critic Monkhouse's judgments were highly valued; and he had the rare gift of differing without offending, while he invariably secured respect for his honesty and ability. As a poet, his ambition was so wide and his devotion to the art so thorough, that it is difficult not to regret the slender bulk of his legacy to posterity.

MONKSWELL, ROBERT PORRETT COLLIER, 1st BARON (1817-1886), English judge, was born at Plymouth, on the 21st of June 1817, and was the son of a prominent merchant of Quaker extraction. He was educated at Oxford, was called to the bar in 1843, and went the western circuit. He obtained a high reputation by his successful defence of Brazilian pirates in 1845;

they were, indeed, convicted at the assizes, but Collier ultimately procured their escape upon a point of law which the judge had refused to reserve. He was elected member of parliament for Plymouth in the Liberal interest in 1852, and in 1859 was appointed counsel to the admiralty and judge-advocate to the fleet. In this capacity he gave in 1862 an opinion in favour of detaining the Confederate rams building in the Mersey, which would have saved his country much money and much credit if it had been acted upon. In 1863 he became solicitor-general, and in 1868 attorney-general, and in 1869 successfully passed a bankruptcy bill. In 1871 he was appointed by Mr Gladstone one of four new judges upon the judicial committee of the privy council, although it was expressly provided by the act creating these offices that none of them should be filled by a law-officer of the Crown. This prohibition was evaded by making Collier a judge of common pleas, and transferring him after a few days to the privy council. This arrangement was unanimously condemned by public opinion, and gave the Gladstone cabinet a serious blow. He officiated, nevertheless, with distinction until his death on the 3rd of November 1886, and was raised to the peerage as Baron Monkswell in 1885. He was a man of many accomplishments, and especially distinguished as an amateur painter, frequently exhibiting landscapes at the Royal Academy and elsewhere. In his younger days he had been noted as a clever caricaturist. He was succeeded in the peerage by his elder son, Robert (b. 1845), who, after taking a first class in law at Cambridge, went to the bar, and became (1871) conveyancing counsel to the treasury, and (1885-1886) an official examiner of the High Court, and, taking to politics as a Liberal, under-secretary for war (1895). The younger son, John Collier (b. 1850), inherited his father's artistic tastes, and became a well-known painter.

MONLUC, or MONTLUC, the name of a French family. The house of Lassérans-Mansencomme, which possessed the estate of Monluc in Agenais, and took its name in the 16th century, is held to be a branch of the family of Montesquiou. Marshal Blaise de Monluc (d. 1577), author of the *Commentaires*, had a son, Pierre Bertrand, called the Capitaine Peyrot, who perished in an expedition to Madeira in 1566, and another son, Fabien de Monluc, whose granddaughter, Jeanne de Monluc (d. 1657), countess of Carmaing, princess of Chabanais, brought the estates of her house to the family of Escoubleau by her marriage with Charles d'Escoubleau, marquess of Sourdis and Alluyes. Jean de Monluc, brother of the marshal, was bishop of Valence and Die, and distinguished himself in several embassies. He died in 1579, leaving a natural son, Jean de Monluc (d. 1603), seigneur de Balagny, who was at first a zealous member of the League, but made his submission to Henry IV., and received from him the principality of Cambrai and the bâton of a marshal of France.

MONMOUTH, JAMES SCOTT, DUKE OF (1649-1685), leader of his abortive insurrection against James II. in 1685, was the son of Lucy Walters, "a brown, beautiful, bold but insipid creature," who became the mistress of Charles II. during his exile at the Hague. He was born at Rotterdam on the 9th of April 1649. That Charles was his father is more than doubtful, for Lucy Walters had previously lived with Robert Sidney (son of the earl of Leicester), brother of Algernon, and the boy resembled him very closely. Charles, however, always recognized him as his son, and lavished on him an almost dotting affection. Until the Restoration he was placed under the care, first of Lord Crofts, by whose name he was known, and then of the queen-dowager, receiving his education to the age of nine from Roman Catholics, but thenceforward from Protestant tutors. In July 1662 he was sent for by Charles, and at thirteen was placed under the protection of Lady Castlemaine and in the full tide of the worst influences of the court. No formal acknowledgment of his relation to the king was made until his betrothal to Anne Scott, countess of Buccleuch, the wealthiest heiress of Scotland, whom he married in 1665. During 1663 he was made duke of Orkney, duke of Monmouth and knight of the Garter, and received honorary degrees at both universities; and on his marriage he and his wife were created duke and duchess

of Buccleuch, and he took the surname of Scott. At court he was treated as a prince of the blood. In 1665 he served with credit under the duke of York in the sanguinary naval battle off Lowestoft. A captaincy in the Life Guards was given him, and in 1670, on the death of Monk, he was made captain-general of the king's forces. In 1670 Monmouth was with the court at Dover, and it is affirmed by Reresby that the mysterious death of Charles's sister, Henrietta, duchess of Orleans, was due to her husband's revenge on the discovery of her intrigue with the duke. It is certain, from an entry by Pepys, that as early as 1666 he had established a character for vice and profligacy. He was the direct author of the attack in December 1670 on Sir John Coventry, and only a few months later received the royal pardon for his share in the wanton murder of a street watchman.

Hitherto Monmouth had been but the spoiled child of a wicked court. Now, however, by no act or will of his own, he began to be a person politically important. As early as 1662 the king's excessive fondness for him had caused anxiety. Even then the fear of a "difference" between Monmouth and James, duke of York, exercised men's minds, and every caress or promotion kept the fear alive. Who could tell but that, in default of legitimate issue from his queen, Charles might declare Monmouth himself his lawful son? A civil war would be the certain consequence. Soon after 1670 the matter took a more serious aspect. The anti-papery spirit was rapidly becoming a frenzy, and the succession of James a probability and a terror. Charles was urged to legitimize Monmouth by a declaration of his marriage with Lucy Walters. He returned answer that, much as he loved the duke, he would rather see him hanged at Tyburn than own him for his legitimate son. Every attempt, however, was henceforth made, especially by Shaftesbury, to accustom people to this idea, and his position was emphasized by James's second marriage, with the Roman Catholic princess Mary of Modena. From this time his popular title was "the Protestant duke." In 1674 he was made "commander-in-chief"; and in connexion with this another unsuccessful attempt, graphically described in Clarke's *Life of James*, was made to gain from Charles a tacit admission of his legitimacy. At Shaftesbury's instance he was placed in command of the army employed in 1675 against the Scottish Covenanters, and was present at Bothwell Bridge (June 22, 1679). In 1678, when Charles was driven into war with Louis, Monmouth took the command of the English contingent, and again gained credit for personal courage at the battle of St Denis. On his return to London England was in the throes of the popish terror. The idea of securing the Protestant succession by legitimizing Monmouth again took shape and was eagerly pressed on by Shaftesbury; at the time it seemed possible that success would wait on the audacity.

The pensionary parliament was dissolved in January 1678-1679, and was succeeded by one still more determined in its anti-papery spirit. To avoid the storm, and to save, if possible, his brother's interests, Charles instructed him to leave the country. James retired to Brussels, the king having previously signed a declaration that he "never was married, nor gave contract to any woman whatsoever but to my wife Queen Catherine." In the summer of 1679 the king suddenly fell ill, and the dangers of a disputed succession became terribly apparent. The party opposed to Monmouth, or rather to Shaftesbury, easily prevailed upon Charles to consent to his brother's temporary return. When, after the king's recovery, James went back to Brussels, he received a promise that Monmouth too should be removed from favour and ordered to leave the country. Accordingly, in September 1679, the latter repaired to Utrecht, while shortly afterwards James's friends so far gained ground as to obtain for him permission to reside at Edinburgh instead of at Brussels. Within two months of his arrival at Utrecht Monmouth secretly returned to England, arriving in London on the 27th of November. Shaftesbury had assiduously kept alive the anti-papery agitation, and Monmouth, as the champion of Protestantism, was received with every sign of popular delight. The king appeared to be greatly incensed, deprived him of all his offices, and ordered him to leave the kingdom at once. This he refused

to do, and the only notice taken of the disobedience was that Charles forbade him to appear at court.

It was at this time that the *Appeal from the Country to the City*, written by Ferguson, was published, in which the legitimacy was tacitly given up, and in which it was urged that "he that hath the worst title will make the best king." Now it was, too, that the exclusionists, who in the absence of parliament were deprived of their best basis for agitation, developed the system of petitioning. So promptly and successfully was this answered by the "abhorers" that Charles, feeling the ground safer under him, recalled James to London—a step immediately followed by the resignation of the chief Whigs in the council.

Once more, however, a desperate attempt was made, by the fable of the "black box," to establish Monmouth's claims; and once more these claims were met by Charles's public declarations in the *Gazette* that he had never been married but to the queen. Still acting under Shaftesbury's advice, Monmouth now went upon the first of his progresses in the west of England, visiting the chief members of the country party, and gaining by his open and engaging manner much popularity among the people. In August 1680 James returned to Edinburgh, his right to the succession being again formally acknowledged by Charles. Monmouth at once threw himself more vehemently than ever into the plans of the exclusionists. He spoke and voted for exclusion in the House of Lords, and used language not likely to be forgotten by James when an opportunity should come for resenting it. He was ostentatiously feasted by the city, the stronghold of Shaftesbury's influence; and it was observed as he drove to dinner that the mark of illegitimacy had been removed from the arms on his coach.

The year 1681 seemed likely to witness another civil war. The parliament finished a session of hysterical passion by passing a series of resolutions of extreme violence, of which one was that Monmouth should be restored to all his offices and commands; and when Charles summoned a fresh parliament to meet at Oxford the leaders of the exclusionists went thither with troops of armed men. Not until the dissolution of this last parliament, on the 27th of March 1681, did the weakness of Monmouth's cause appear. The deep-seated respect for legitimate descent asserted itself, and a great reaction took place. In November Dryden published *Absalom and Achitophel*. Shaftesbury was attacked, but was saved for the time by a favouring jury. Monmouth himself did not escape insult in the street and from the pulpit. He was forbidden to hold communication with the court; and when he went, in September 1682, on a second progress through the western and north-western counties his proceedings were narrowly watched, and he was at length arrested at Stafford. Severity and extreme lenity were strangely mingled in the treatment he received. He was released on bail, and in February 1683, after the flight and death of Shaftesbury, he openly broke the implied conditions of his bail by paying a third visit to Chichester with Lord Grey and others on pretence of a hunting expedition.

It is probable that Monmouth never went so far as to think of armed rebellion; but there is little doubt that he had talked over schemes likely to lead to this, and that Shaftesbury had gone farther still. The Rye House plot gave an excuse for arresting the Whig leaders; Russell and Sidney were judicially murdered; Monmouth retired to Toddington, in Bedfordshire, and was left untouched. Court intrigue favouring him, he succeeded, by the betrayal of his comrades and by two submissive letters, in reconciling himself with the help of Halifax both to the king and to James, though he had the humiliation of seeing his confessions and declarations of penitence published at length in the *Gazette*. His character for pettishness and folly was thus amply illustrated. Charles heartily despised him, and yet appears to have retained affection for him. His partial return to favour raised the hopes of his partisans; to check these, Algernon Sidney was executed. Monmouth was now subpoenaed to give evidence at the trial of young Hampden. To escape from the difficulties thus opened before him he fled to Holland, probably with Charles's connivance, and though he once more,

in November 1684, visited England, it is doubtful whether he ever again saw the king.

The quiet accession of James II. soon brought Monmouth to the crisis of his fate. Within two months of Charles's death he had yielded to the impetuosity of Argyll and others of the exiles and to vague invitations from England. It is curious, as showing the light in which his claims were viewed by his fellow-conspirators, that one of the terms of the compact between them was that, though Monmouth should lead the expedition, he should not assume the title of king without their consent, and should, if the rebellion were successful, resign it and accept whatever rank the nation might offer. Now, as always, he was but a puppet in other men's hands.

On the 2nd of May Argyll sailed with three ships to raise the west of Scotland; and three weeks later, with a following of only eighty-two persons—of whom Lord Grey, Fletcher of Saltoun, Wade, and Ferguson, the author of the *Appeal from the Country to the City*, were the chief—Monmouth himself set out for the west of England, where, as the stronghold of Protestant dissent and as the scene of his former progresses, he could alone hope for immediate support. Even here, however, there was no movement; and when on the 11th of June Monmouth's three ships, having eluded the royal fleet, arrived off Lyme Regis, he landed amid the curiosity rather than the sympathy of the inhabitants. In the market-place his "declaration," drawn up by Ferguson, was read aloud. In this document James was painted in the blackest colours. Not only was he declared to be the murderer of Essex, but he was directly charged with having poisoned Charles to obtain his crown. Monmouth soon collected an undisciplined body of some 1500 men, with whom he seized Axminster, and entered Taunton. Meanwhile the parliament had declared it treason to assert Monmouth's legitimacy, or his title to the crown; a reward of £5000 was offered for him dead or alive, and an act of attainder was passed in unusual haste. Troops had been hurriedly sent to meet him, and when he reached Bridgwater Albemarle was already in his rear. From Bridgwater the army marched through Glastonbury to attack Bristol, into which Lord Feversham had hastily thrown a regiment of foot-guards. The attempt, however, miscarried; and, after summoning Bathin vain, Monmouth, with a disordered force, began his retrograde march through Philips Norton and Frome, continually harassed by Feversham's soldiers. At the latter place he heard of Argyll's total rout in the western Highlands. He was now anxious to give up the enterprise, but was overruled by Grey, Wade and others. On the 3rd of July he reached Bridgwater again, with an army little better than a rabble, living at free quarters and behaving with reckless violence. On Sunday, the 5th, Feversham entered Sedgemoor in pursuit; Monmouth the same night attempted a surprise, but his troops were hopelessly routed. He himself, with Grey and a few others, fled over the Mendip Hills to the New Forest, hoping to reach the coast and escape by sea. The whole country, however, was on the alert, and at midnight on the 8th, within a month of their landing, James heard that the revolt, desperate from the first, was over and that his rival had been captured close to Ringwood in Hampshire.

On the day of his capture Monmouth wrote to James in terms of the most unmanly contrition, ascribing his wrong-doings to the action of others, and imploring an interview. On the 13th the prisoners reached the Tower, and on the next day Monmouth was allowed to see James. No mercy was shown him, nor did he in the least deserve mercy; he had wantonly attacked the peace of the country, and had cruelly libelled James. The king had not, even in his own mind, any family tie to restrain him from exercising just severity, for he had never believed Monmouth to be the son of any one but Robert Sidney. Two painful interviews followed with the wife for whom he bore no love, and who for him could feel no respect; another imploring letter was sent to the king, and abject protestations and beseechings were made to all whom he saw. He offered, as the last hope, to become a Roman Catholic, and this might possibly have proved successful, but the priests sent by James to ascertain

the sincerity of his "conversion" declared that he cared only for his life and not for his soul.

He met his death on the scaffold with calmness and dignity. In the paper which he left signed, and to which he referred in answer to the questions wherewith the busy bishops plied him, he expressed his sorrow for having assumed the royal style, and at the last moment confessed that Charles had denied to him privately, as he had publicly, that he was ever married to Lucy Walters. He died at the age of thirty-six, on the 15th of July 1685.

Monmouth had four sons and two daughters by his wife, who in 1688 married the 3rd Lord Cornwallis and died in 1732. The elder of the two surviving sons, James, earl of Dalkeith (1674-1705) had a son Francis (1695-1751), who through his grandmother inherited the title of duke of Buccleuch in 1732, and was the ancestor of the later dukes. The younger son, Henry (1676-1730), was created earl of Deloraine in 1706, and rose to be a major-general in the army.

The best accounts of Monmouth's career, apart from the modern histories, are G. Roberts's detailed *Life* (1844), the articles in the *Dict. Nat. Biog.* (by A. W. Ward) and in Collins's *Peerage*, and the *Correspondence of Lord Clarendon with James, earl of Abingdon*, 1683-1685 (Clarendon Press, 1896). For the rebellion, Lord Grey's *Secret History* (1754) should be consulted. See also Evelyn's and Pepys's *Diaries*, &c.

MONMOUTH, ROBERT CAREY, 1ST EARL OF (c. 1560-1639), youngest son of Henry Carey, 1st Baron Hunsdon, chamberlain and first cousin of Queen Elizabeth, by Anne, daughter of Sir Thomas Morgan, of Arkestone in Herefordshire, was born about the year 1560. As a young man he accompanied several diplomatic missions abroad and took part in military expeditions. In 1587 he joined in the attempt to relieve Sluys, in 1588 served as a volunteer against the Spanish expedition, and commanded a regiment in Essex's expedition to Normandy in 1591, taking part in the siege of Rouen. He was knighted by Essex the same year for having by his intercession with the queen procured his recall. In the parliaments of 1586 and 1588 he represented Morpeth; in that of 1593, Callington; and in those of 1596 and 1601, Northumberland. From 1593 till the end of Elizabeth's reign he occupied various posts in the government of the Scottish borders, succeeding to his father's appointment of lord warden of the marches in 1596, which he held till February 1598. In March 1603 he visited the court, and witnessed the queen's last illness, which he described in his *Memoirs*. Anxious to recommend himself to her successor, and disobeying the orders of the council, he started on horseback immediately after the queen's death on the morning of the 24th of March, in order to be the first to communicate the tidings to James, arrived at Holyrood late on the 26th, and was appointed by the king a gentleman of the bedchamber. But his conduct met with general and merited censure as "contrary to all decency, good manners and respect," and on James's arrival in England he was dismissed from his new post. On the 23rd of February 1605, however, he was made governor of Prince Charles, in 1611 his master of the robes, in 1617 his chamberlain, and on the 6th of February 1622, he was created Baron Carey of Leppington. In 1623 he followed Charles to Spain, and after the latter's succession to the throne he was created earl of Monmouth in 1626. He died on the 12th of April 1639. His eldest son HENRY (1596-1661), succeeded him as 2nd earl of Monmouth, and on his death without surviving male issue the peerage became extinct.

His *Memoirs* were published first by the earl of Cork and Orrery in 1759, a new edition, annotated by Sir Walter Scott, being printed in 1808.

MONMOUTH (Welsh *Mynyw*), a municipal and contributory parliamentary borough, and the county town of Monmouthshire, England, 18 m. S. of Hereford, on the Great Western railway. Pop. (1901), 5095. It is picturesquely situated at the confluence of the Wye and the Monnow, between the two rivers, and is almost surrounded by hills. Portions of the town walls remain, and there is a picturesque old gateway on the Monnow bridge; but there are only insignificant ruins of the castle, which was originally a Saxon fortress, and was twice taken by the Parlia-

mentary forces during the Civil War. Besides the churches—that of St. Mary, completed in 1882 on an ancient site, and the chapel of St. Thomas, a late Norman structure—the principal buildings are the town-hall, the Rolls Hall and the free grammar-school, which was founded in 1614, and educates about 150 boys on the usual lines of a public school. A statue of Henry V., who was born in its castle, stands in the market-place. With Newport and Usk, Monmouth forms the Monmouth parliamentary district of boroughs, returning one member.

Monmouth (*Monemuta*) from the coincidence of position is supposed to be the *Blastium* of Antoninus. Situated between the Severn and the Wye its strategic importance was early recognized by the Saxons, who fortified it against the Britons, while in later years it played a leading part in Welsh border warfare. At the time of the Domesday Survey the castle was in the custody of William Fitz Baderon. Henry III. granted it, together with the lordship of the borough, to his son Edmund Crouchback, through whose descendants both borough and castle passed into the duchy of Lancaster. Since the 18th century the dukes of Beaufort have been lords of the borough. Monmouth was a borough by prescription as early as 1256, and was governed by a mayor in 1461, but was not incorporated until 1550 under the title of "Mayor, Bailiffs and Commonalty." This charter was confirmed in 1558, 1606 and 1666, a recorder and town clerk being added to the constitution. In accordance with the act of 1555-1556 Monmouth as county town obtained the right of representation in parliament; the earliest returns existing are for 1553, since which date one member has been returned regularly. Wednesday and Saturday markets were confirmed to Monmouth in 1550, with the further proviso that no others were to be held within five miles of the borough. Friday is now the weekly market-day. At the same time an annual three-days' fair, which still exists, was granted on Whit-Tuesday and successive days. During the 16th and 17th centuries the manufacture of Monmouth caps was an important industry, fostered by legislation and mentioned by Fuller in his *Worthies of England*.

See Charles Heath, *The Town of Monmouth* (Monmouth, 1804).

MONMOUTH, a city and the county-seat of Warren county, Illinois, in the W. part of the state, about 40 m. S. of Rock Island. Pop. (1890), 5936; (1900), 7460, (504 foreign-born); (1910), 9128. It is served by the Chicago, Burlington & Quincy and the Iowa Central railways, and by electric railways to Galesburg and to Rock Island. The city is the seat of Monmouth College (1856; United Presbyterian), which in 1908 had 28 instructors and 454 students. Among the public buildings and institutions are the county court-house, the federal building, a hospital and the Warren county library (1836). Monmouth is situated in a good farming region, and cattle, swine and ponies are raised in the vicinity. The city has various manufactures. Monmouth was settled about 1824, first incorporated as a village in 1836, chartered as a city in 1852 and in 1882 reorganized under a general state law.

MONMOUTH, BATTLE OF (1778), a battle in the American War of Independence. The prospect of an alliance between France and America in 1778 induced the British to concentrate their forces. Sir Henry Clinton, who had succeeded Sir W. Howe in command, determined to abandon Philadelphia, captured in the previous year, and move his troops direct to New York through New Jersey. Washington, who had spent the winter at Valley Forge, Pennsylvania, and had materially recruited his army, immediately marched to intercept the British, and overtook them near Monmouth Court House (now Freehold), New Jersey, on the 28th of June 1778. A strong detachment of Americans under General Charles Lee was sent forward to harass the enemy's rear and if possible cut off a portion of their long baggage train. Clinton strengthened his rearguard, which turned upon the Americans and compelled them to retreat. When Washington, who was well up with his main body, heard of Lee's retreat, he spurred forward and exerted himself in forming a strong line of battle in case the British continued their determined attack. Warm words passed between Washington

and Lee, which subsequently led to the latter's court-martial and suspension for a year. The readjusted American line was composed of the divisions of Lafayette, Greene, Alexander and Patterson, while Wayne's brigade, which had been in Lee's advance from the first, was posted in a favourable position. The British attacked this line and a warm, though brief, engagement ensued. Both sides encamped at night on the ground occupied. The British, having accomplished their object in delaying Washington's pursuit, continued their march the next day towards New York. Washington turned to the left, crossed the Hudson above, and encamped for the remainder of the season at White Plains, New York, within striking distance of the city. Each side suffered about the same loss in the battle, that of the British being 400 (60 due to sunstroke), the American somewhat less. In this engagement Lieut.-Colonel Henry Monckton (1740-1778) of the British Grenadiers was killed in leading a charge.

MONMOUTHSHIRE, a western border county of England, bounded E. by Gloucestershire, N. E. by Herefordshire, N.W. by Brecknock, W. and S.W. by Glamorganshire (Wales), and S. by the estuary of the river Severn. The area is 534 sq. m. The surface is varied, and in many districts picturesque, especially along the valley of the Wye, and between that river and the Usk. In the west and north the hills rise to a considerable height, and this mountain region encircles a finely undulating country. The highest summits are Sugar Loaf (1055 ft.), Blorenge (1838), and Skirrid Fawr (1601), summits of the hills which almost encircle the town of Abergavenny. On the other hand, along the shore of the Severn estuary on either side of the Usk, are two extensive tracts of marshland, called the Caddicot and Wentloog levels, stretching from Cardiff to Portskewet, and protected from inundations by strong embankments. The principal rivers are the Wye, which forms the greater part of the eastern boundary of the county with Gloucestershire, and falls into the Severn; the Monnow, which forms a portion of its boundary with Herefordshire, and falls into the Wye at the town of Monmouth; the Usk, which rises in Brecknock, and flows southward through the centre of the county; the Ebbw, which rises in the north-west, and enters the estuary of the Usk below Newport; and the Rhydney, which rises in Brecknock, and, after forming the boundary between Monmouth and Glamorgan, enters the Bristol Channel a little east of Cardiff. Salmon abound especially in the Wye and the Usk, and trout are plentiful in many of the streams.

Geology.—The oldest rocks in the county are the Silurian strata (Wenlock Shale and Limestone, and Ludlow Beds) which form an extensive anticline at Usk; a smaller inlier appears at Rumney on the south-west border of the county, near Cardiff. These beds dip under the Old Red Sandstone, a great series of red marls, sandstones and concretionary limestones (conrstones) which occupies the north-eastern part of the county; the highest beds contain grits and conglomerates which give rise to bold escarpments and lofty plateaux (e.g. the Sugar Loaf and Skirrid Fawr) alongside the outcrop of the Carboniferous Limestone. The western part of the county, between Pontypool and the river Rhydney, is occupied by the eastern end of the great South Wales coal-field, where the Carboniferous Limestone, Millstone Grit, and Coal Measures (Lower Coal Series, Penant Sandstone and Upper Coal Series) dip westward and succeed each other from east to west. The Coal Measures abound in coal-seams and ironstone, and their densely populated valleys offer a marked contrast to the agricultural and pastoral districts of the rest of the county. The Carboniferous Limestone comes in again in the south-east near Chepstow, and has imparted its characteristic scenery to the lower reaches of the Wye. After a prolonged interval, during which these older formations were folded, faulted, upheaved and finally carved by erosion into hills and valleys, the southern portion of the region was submerged beneath the waters of the Triassic lake in which the Keuper Marls were deposited. These consist of red conglomerates and marls which wrap round the heights and fill up the hollows among the older rocks to the south-west of Chepstow, and the subsidence continuing, admitted the waters of the Jurassic sea which deposited the fossiliferous Rhaetic and Lias limestones and shales of Llanwern and Goldcliff near Newport. Glacial gravel and boulder-clay are found in the valleys and a broad tract of alluvium borders the shores of the Bristol Channel.

Agriculture.—Along the Severn shore the soil is deep and loamy, and admirably suited for the growth of trees. The most fertile land is that resting on the Old Sandstone, especially along the banks of the Usk, where wheat of fine quality is raised. In the

mountainous regions more attention is paid to grazing than to the raising of crops. There are a considerable number of dairy farms, but sheep-farming is much more largely followed. Only about seven-tenths of the total area of the county is under cultivation. There is a large extent of hill pasture, and a considerable acreage under orchards.

Mining.—The coal-mines and iron-works which Monmouthshire shares with South Wales are very important. They occur in the wild and mountainous western part of the county, where a series of upland valleys, running parallel from N.N.W. to S., has each its populous mining townships and railways, which have in many cases necessitated remarkable engineering works—such as the great Crumlin viaduct. These valleys, in order from east to west, with the principal townships in each, are as follows: Afon Lwyd (Panteg, Pontypool, Abersychan and Blaenavon); Ebbw Fach (Abertillery, Nantyglo and Blaia), joining the Ebbw (Risca, Ebbw Vale); Sirhowy (Bedwelty and Tredegar); Rhydney (New Tredegar and Rhydney). Besides coal, a considerable quantity of fireclay and some iron are raised.

Communications.—The principal railway serving the county is the Great Western, but in the mining districts there are also various branches of the London and North-Western, Rhydney and Brecon and Merthyr systems. The Crumlin Canal from the Ebbw Valley, and the Monmouthshire Canal from Pontypool converge upon Newport, which is the principal port in the county. The Brecon Canal runs north from Pontypool into the valley of the Usk.

Population and Administration.—The area of the ancient county is 341,688 acres, with a population in 1801 of 252,416, and in 1901 of 292,317. The area of the administrative county is 349,712 acres. The county comprises 6 hundreds. The municipal boroughs are Abergavenny (pop. 7795), Monmouth (5095), and Newport, a county borough (67,270). The following are urban districts: Abercarn (12,607), Abersychan (17,768), Abertillery (21,945), Bedwelty (9988), Blaenavon (10,869), Caerleon (13,67), Chepstow (3,067), Ebbw Vale (20,994), Llanfrechfa, Upper (2979), Llantarnam (5287), Mynyddislwyn (3337), Nantyglo and Blaia (13,489), Panteg (7484), Pontypool (6126), Rhydney (7915), Risca (9661), Tredegar (18,497), and Usk (1476). Monmouthshire is in the Oxford circuit, and assizes are held at Monmouth. It has one court of quarter sessions, and is divided into 11 petty sessional divisions. The boroughs of Monmouth and Newport have commissions of the peace, but no separate court of quarter sessions. The parliamentary divisions are the northern, western and southern, each returning one member; and the Monmouth district of parliamentary boroughs, consisting of the towns of Monmouth, Newport and Usk, returns one member.

History.—The district which is now Monmouthshire formed the Welsh kingdom of Gwent at the time of the Heptarchy, and, owing to the extraordinary courage of the Gwentians in resisting the repeated inroads of the Saxons, no permanent English settlement was effected in the district until close upon the middle of the 11th century. The incursions of the West Saxons began in the 7th century, and, during the reign of Alfred, Brochmael and Ferael, kings of Gwent, acknowledged Alfred as their lord, and sought his protection against their enemies. In the 9th and 10th centuries the district was frequently harried by the Danes, who in 915, under Ohter and Hwald, sailed round Wessex and Cornwall to the mouth of the Severn and plundered all along the banks of the Wye, finally taking prisoner the bishop of Llandaff, whom they only released on a ransom of £40. In 926 Æthelstan obliged the kings of the north Britons to meet him at Hereford and fixed the Wye as the limit of their territory. In 976 the Danes destroyed Caerleon, at this time the chief town of the district. The early 11th century was taken up with a series of interminable contests between the Welsh princes for the succession in South Wales, as a result of which the Welsh Chronicle relates that in 1047 the whole of South Wales lay waste, and in 1049, when a fleet of Irish pirates entered the Severn estuary, Griffith, the king of South Wales, assisted them in plundering the neighbourhood. In 1065 Harold conquered the whole district between the lower reaches of the Wye and the Usk, and gave orders for the construction of a hunting-box at Portskewet for Edward the Confessor, but very shortly after Caradoc ap Griffith, with a large body of followers, killed all the workmen engaged in

the building and carried away the provisions prepared for the king's reception.

After the Conquest the district conquered by Harold was bestowed on William Fitz Osborne, earl of Hereford, who built Monmouth Castle, and continued the line of defence against the Welsh frontier along the Wye, while a second line of fortifications along the Usk Valley marked the continued advance of the Normans, who by 1085 had subjugated almost the whole of Gwent. The lordship of Overwent fell to Hamelin de Baladun, who founded the castle and priory of Abergavenny, and from him passed to Brian Fitz Count and later to Walter Fitz Miles, earl of Hereford. The lordship of Netherwent remained for many centuries with the Clare family. Penhow Castle was a stronghold of the family of St Maur or Seymour, from whom are descended the present dukes of Somerset, and Gromsont and Skenfrith Castles of the family of Braose. Gwent still ranked as Welsh territory at the time of the Domesday Survey, but the town of Monmouth, the castle of Caerleon, and the district of Archenfeld, are assessed under Herefordshire, and the three hardwicks of Llanwern, Portskewet and Dinam under Gloucestershire. The Norman lords of the present county held their lands "per baroniam," so that the king's writ did not run in them, and the lives and property of the poorer inhabitants were entirely at the mercy of these lords marchers as they were termed. The county still exhibits remains of no less than twenty-five Norman castles. The province of Gwent was formerly divided into four cantrefs, each comprising several commotes. Cantref Uwchocoed, or Upper Gwent, comprised the commotes of Erging and Ewyas, now principally in Herefordshire, and the greater part of the present hundreds of Skenfrith, Abergavenny and Usk; Cantref Iscoed, or Lower or Nether Gwent, comprised the present hundred of Raglan and parts of Caldecote and Usk; Cantref Gwentlwg comprised the present hundred of Wentlwg; while the fourth cantref, Cantref Coch, now forms the Forest of Dean in Gloucestershire. Leland, writing in the 16th century, describes Gwent as comprising the three divisions of low, middle and high "Venteland," and at this period it included no less than 24 lordship marches, each governed by its own ancient laws and customs and ruled by its own lord. Under the act of 1536 for the abolition of the marches, these 24 lordships were united to form a shire; Monmouth was constituted the shire town, and the sheriff's court was ordered to be held alternately at Monmouth and Newport. A commission was also appointed to divide the shire into hundreds, which were made 6 in number: Abergavenny, Caldecote, Raglan, Skenfrith, Usk and Wentlwg, the bounds being subsequently ratified by act of parliament of 1542-1543. No sheriffs were actually appointed for Monmouthshire until 1541, and the legal authority of the lords marchers was not finally abolished until 1689. The act of 1536 did not expressly separate the county from Wales, and it was only gradually that Monmouthshire came to be regarded as an English county, being included in the Oxford circuit for the first time in the reign of Charles II.

Ecclesiastically Monmouthshire has been almost entirely included in the diocese of Llandaff since the foundation of that diocese in the 6th century. Monmouth, however, was in the diocese of Hereford, and a few parishes formed part of the diocese of St David's, until under the statute of 1836 the whole county was placed under the jurisdiction of the bishop of Llandaff. It contains, wholly or in part, 134 ecclesiastical parishes.

The river fisheries of Monmouthshire have been famed from very early times, Caerleon with seven fisheries in the Wye and the Usk yielding a return of £7, 10s. at the time of the Domesday Survey. Coal is said to have been worked in the reign of Edward I., but the industry lapsed altogether until it received new life from the construction of the canal between Blaenavon and Newport, begun in 1792 and completed in 1795. The first iron-workers at Pontypool were a family of the name of Grant, who were succeeded in 1565 by Mr Richard Hanbury. In 1740, however, Monmouthshire contained only two furnaces, making 900 tons annually. Fifty years later three new furnaces were constructed at Blaenavon, and from that date the industry steadily improved.

By the act of 1536 two knights were to be returned for the shire and one Burgess for the borough of Monmouth, but the first returns for the county were made in 1547 and for the borough in 1553.

From 1698 the boroughs of Newport and Usk returned one member each. Under the Redistribution of Seats Act of 1885 the county now returns three members in three divisions.

Antiquities.—Of Norman fortresses in Monmouthshire, either built or taken possession of by the lords of the marches, there are remains of no less than twenty-five. The more interesting and important are: Caldicot, the seat of the De Bohuns, with a round keep of the 13th century, gateway, gatehouse and cliffs, still partly inhabited; Chesepstow, one of the finest examples of the Norman fortress extant, in an imposing situation on a cliff above the Wye; Newport, Abergavenny, the gateway and hall of Gromsont, once the residence of the dukes of Lancaster; and Usk Castle, rebuilt by the Clares in the time of Edward IV. Raglan Castle, begun in the reign of Henry V., is a very extensive ruin, still in good preservation, and of special interest as a very late example of the feudal stronghold. Charles I. resided in it after the battle of Naseby, and in 1646 it was delivered up to the parliamentary forces after a stubborn resistance of ten weeks against Colonel Morgan and General Fairfax.

At the Reformation there were in Monmouth two hospitals and fifteen other religious houses; but of these there are now important remains of only two—Llanthony Abbey and Tintern Abbey, both Cistercian. Llanthony Abbey in the Black Mountains was founded by William de Lacy in 1103, and the church, dating from about 1200, is one of the earliest examples in England of the Pointed style. The ruins consist of portions of the nave, transept, central tower and choir. Tintern Abbey (q.v.), founded by Walter de Clare in 1131, occupies a position of great beauty on the Wye, and is among the finest monastic ruins in England. Of the churches, those chiefly worthy of mention are at Abergavenny, belonging to a Benedictine priory, and containing a number of old tombs; Chesepstow, partly Norman, and possessing a richly moulded doorway; St Woolos' Church, Newport, also Norman; the Norman chapel of St Thomas, Monmouth; Christchurch, principally Norman; Matheron, Early English, with a tablet to Tewdrig, king of Gwent in the 6th century; and Usk, formerly attached to a Benedictine priory.

See *Victoria County History, Monmouthshire*; William Cox, *An Historical Tour in Monmouthshire*, 2 pts. (London, 1801); N. Rogers, *Memoirs on Monmouthshire* (London, 1708); David Williams, *History of Monmouthshire* (1796); George Ormerod, *Strictures on Archaeological Memoirs relating to the District adjacent to the Confluence of the Severn and the Wye*, M. E. Bagnall-Ormerod, *Account of the Rude Monuments in Monmouthshire* (Newport, 1880); J. A. Bradney, *A History of Monmouthshire* (1904, &c.); also the publications of the Caerleon Antiquarian Association.

MONNIER, MARC (1827-1885), French writer, was born at Florence on the 7th of December 1827. His father was French, and his mother a Genevese; he received his early education in Naples, he then studied in Paris and Geneva, and he completed his education at Heidelberg and Berlin. He became professor of comparative literature at Geneva, and eventually vice-rector of the university. He died at Geneva on the 18th of April 1885. He wrote a series of short, satirical, dramatic sketches collected as *Théâtre de marionnettes* (1871), and stories, notably *Nouvelles napolitaines* (1879), numerous works on Italian history, a translation of Goethe's *Faust, Genève et ses poètes* (1873), &c. The first volume of his *Histoire de la littérature moderne, La Renaissance, de Dante à Luther* (1884), was crowned by the French Academy.

See E. Rambert, *Écrivains nationaux suisses*, vol. i. (Geneva, 1874).

MONNIKENDAM, a fishing village of Holland, in the province of North Holland, on an inlet of the Zuider Zee which is of the Gouth Zee. 12 m. N.N.E. of Amsterdam, with which it is connected by steam tramway. It was once a flourishing town, but its quietness now is only disturbed by the advent of the numerous tourists who visit it in the summer, crossing hence to the island of Marken. Among the notable buildings are the weigh-house (17th century), the bell-tower (1591), formerly attached to the town-hall before this was destroyed in the 18th century, and the church of St. Nicholas, with its beautiful massive tower. Mention is made of this church in a document of 1356, but it was not completed until the beginning of the 15th century. It contains some fine carvings, many interesting old tombs, and a monument of Jan Nieuwenhuizen, the founder of the Society for Public Welfare (*Tot Nut van het Algemeen*) in 1785.

MONOCHORD (Gr. *μόνοχορδον*, *κανών μουσικός*): med. Lat. *monochordam*), an instrument having a single string, used

by the ancient Greeks for tuning purposes and for measuring the scale arithmetically. The monochord, as it travelled westwards during the middle ages, consisted of a long board, or narrow rectangular box, over which was stretched the single string; along the edge of the sound-board was drawn a line divided according to simple mathematical ratios to show all the intervals of the scale. A movable bridge was so contrived as to slide along over the string and stop it at will at any of the points marked. The vibrating length of string, being thus determined as on the guitar, lute, violin, &c., yielded a note of absolutely correct pitch on being twanged by fingers or plectrum. In order the better to seize the relation of various intervals, a second string tuned to the same note, but out of reach of the bridge, was sometimes added to give the fundamental.

(K. S.)

MONOD, ADOLPHE (1802-1856), French Protestant divine, was born on the 21st of January 1802, in Copenhagen, where his father was pastor of the French church. He was educated at Paris and Geneva, and began his life-work in 1825 as founder and pastor of a Protestant church in Naples, whence he removed in 1827 to Lyons. Here his evangelical preaching, and especially a sermon on the duties of communicants ("Qui doit communier?"), led to his deposition by the Catholic Minister of education and religion. Instead of leaving Lyons he began to preach in a hall and then in a chapel. In 1836 he took a professorship in the theological college of Montauban, removing in 1847 to Paris as preacher at the Oratoire. He died on the 6th of April, 1856. Monod was undoubtedly the foremost Protestant preacher of 19th-century France. He published three volumes of sermons in 1830, another, *La Crédulité de l'incrédulé* in 1844, and two more in 1855. Two further volumes appeared after his death. His elder brother Frédéric (1794-1863), who was influenced by Robert Haldane, was also a distinguished French pastor, who with Count Gasparin founded the Union of the Evangelical Churches of France; and Frédéric's son Théodore (b. 1836) followed in his footsteps.

MONOD, GABRIEL (1844-), French historian, was born at Havre on the 7th of March, 1844. Adolphe Monod (q.v.) was his uncle. Having studied at Havre, he went to Paris to complete his education, and whilst there lived with the family of De Pressensé. The influence of Edmond de Pressensé, a pastor and large-minded theologian, and of Madame de Pressensé, a woman of superior intellect and refined feeling, who devoted her life to educational works and charity, made a great impression on him. In 1865 he left the *école normale supérieure*, and went to Germany, where he studied at Göttingen and Berlin. The teaching of George Waitz definitely directed his studies towards the history of the middle ages. Returning to France in 1868 he was nominated by V. Duruy to give lectures on history, following the method used in German seminaries, at the *école des hautes études*. When the Franco-Prussian War broke out, Gabriel Monod, with his cousins, Alfred and Sarah Monod, organized an ambulance with which he followed the whole campaign, from Sedan to Mans. He wrote a small book of memoirs of this campaign, *Allemands et français* (1871), in which he spoke of the conquerors without bitterness; this attitude was all the more praiseworthy as his mother was an Alsatian, and he was unable to resign himself to the loss of Alsace and Lorraine. The war being over he returned to teaching. At this period of his life he wrote *Grégoire de Tours et Marius d'Avenche* (1872); *Frédégaire*, whose history, taken from original MSS., he published in 1885; a translation of a book of W. Junghans, *Histoire critique des règnes de Childeric et de Chlodovech*, with introduction and notes (1879); *Études critiques sur les sources de l'histoire carolingienne* (1898, 1st part only published); and *Bibliographie de l'histoire de France* (1888). He himself said that his pupils were his best books; he intended to teach them not so much new facts as the way to study, endeavouring to develop in them an idea of criticism and truth. They showed their gratitude by dedicating a book to him in 1896, *Études d'histoire du moyen âge*, and after his retirement in 1905 by having his features engraved on a slab (see *À Gabriel*

Monod, en souvenir de son enseignement: école pratique des hautes études, 1868-1905, école normale supérieure, 1880-1904. May 26, 1907). In 1875 he founded the *Revue Historique*, which rapidly became a great authority on scientific education. Some of his articles in this and other periodicals have been put together in book form, *Les Maîtres de l'histoire: Renan, Taine, Michelet* (1894); *Portraits et souvenirs* (1897: on Hugo, Fustel de Coulanges, V. Duruy, &c.).

MONDELPHIA (i.e. "single uterus,"—in allusion to the fusion of at least the basal portions of this organ, and in contradistinction to their duality in the Didelphia, or Marsupialia), Cuvier's name for the group which includes all the orders of mammals (See MAMMALIA) except the Marsupialia and Monotremata; other titles for this group being Placentalia and Eutheria. With the Monotremata (q.v.) this group has no near affinity; and while more nearly related to the Marsupialia (q.v.), in which an imperfect allantoic placenta is sometimes developed, it is broadly distinguished therefrom by the invariable presence of a functional placenta by the aid of which the foetus is nourished throughout the greater portion of intra-uterine life. Other distinctive features by which marsupials are separated from monodelphians or placentals will be found in the article last mentioned.

(R. L. *)

MONOGENISTS, the term applied to those anthropologists who claim that all mankind is descended from one original stock (*ἄνωσος* single, and *γένος*, race), and generally from a single pair; while polygenists (*πολλοί*, many) contend that man has had many original ancestors. Of the older school of scientific monogenists J. F. Blumenbach and J. C. Prichard are eminent representatives, as is A. de Quatrefages of the more modern. The great problem of the monogenist theory is to explain by what course of variation races of man so different have sprung from a single stock. In ancient times little difficulty was felt in this, authorities such as Aristotle and Vitruvius seeing in climate and circumstance the natural cause of racial differences, the Ethiopian having been blackened by the tropical sun, &c. Later and closer observations, however, have shown such influences to be, at any rate, far slighter in amount and slower in operation than was supposed. M. de Quatrefages brings forward (*Unité de l'espèce humaine*, Paris, 1861, ch. 13) his strongest arguments for the variability of races under change of climate, &c. (*action du milieu*), instancing the asserted alteration in complexion, constitution, and character of negroes in America, and Englishmen in America and Australia. But although the reality of some such modification is not disputed, especially as to stature and constitution, its amount is not enough to countervail the remarkable permanence of type displayed by races ages after they have been transported to climates extremely different from that of their former homes. Moreover, physically different races, such as the Bushmen and the pure negroid types in Africa, show no signs of approximation under the influence of the same climate; on the other hand, the coast tribes of Tierra del Fuego and forest tribes of tropical Brazil continue to resemble each other, in spite of extreme differences of climate and food. Darwin, than whom no naturalist could be more competent to appraise the variation of a species, is moderate in his estimation of the changes produced on races of man by climate and mode of life within the range of history (*Descent of Man*, pt. i. chs. 4 and 7). The slowness and slowness of variation in human races having been acknowledged, a great difficulty of the monogenist theory was seen to lie in the shortness of the chronology with which it was formerly associated. Inasmuch as several well-marked races of mankind, such as the Egyptian, Phœnician and Ethiopian, were much the same three or four thousand years ago as now, their variation from a single stock in the course of any like period could hardly be accounted for except by a miracle. This difficulty was escaped by the polygenist theory (see Georges Pouchet, *Plurality of the Human Race*, 1858, 2nd ed., 1864, *Introd.*). Two modern views have, however, intervened which have tended to restore, though under a new aspect, the doctrine of a single human stock. One has been the recognition of the fact that man has

existed during a vast period of time, which has made it easier to assume the continuance of very slow natural variation of races. The other view is that of the evolution or development of species. It does not follow necessarily from a theory of evolution of species that mankind must have descended from a single stock, for the hypothesis of development admits of the argument that several simian species may have culminated in several races of man (Vogt, *Lectures on Man*, London, 1864, p. 463). The general tendency of the development theory, however, is against constituting separate species where the differences are moderate enough to be accounted for as due to variation from a single type. Darwin's summing up of the evidence as to unity of type throughout the races of mankind is as distinctly a monogenist argument as those of Blumenbach, Prichard or Quatrefages:—

"Although the existing races of man differ in many respects, as in colour, hair, shape of skull, proportions of the body, &c., yet if their whole organization be taken into consideration they are found to resemble each other closely in a multitude of points. Many of these are so unimportant, or of so singular a nature, that it is extremely improbable that they should have been independently acquired by aboriginally distinct species or races. The same remark holds good with equal or greater force with respect to the numerous points of mental similarity between the most distinct races of man."

Now when naturalists observe a close agreement in numerous small details of habits, tastes and dispositions, between two or more domestic races, or between nearly allied natural forms, they use this fact as an argument that all are descended from a common progenitor who was thus endowed, and, consequently, that all should be classed under the same species. The same argument may be applied with much force to the races of man." (*Descent of Man*, pt. 1. ch. 7.)

A suggestion by A. R. Wallace has great importance in the application of the development theory to the origin of the various races of man; it is aimed to meet the main difficulty of the monogenist school, how races which have remained comparatively fixed in type during the long period of history, such as the white man and the negro, should have, in even a far longer period, passed by variation from a common original. Wallace's view is substantially that the remotely ancient representatives of the human race, being as yet animals too low in mind to have developed those arts of maintenance and social ordinances by which man holds his own against influences from climate and circumstance, were in their then wild state much more plastic than now to external nature; so that "natural selection" and other causes met with but feeble resistance in forming the permanent varieties or races of man, whose complexion and structure still remain fixed in their descendants (*Contributions to the Theory of Natural Selection*, p. 319).

MONOGRAM (from Late Lat. *monogramma*, in Late Gr. *μόνογραμμα*, from *μόνος*, single, *γράμμα*, letter), originally a cipher consisting of a single letter, now a design or mark consisting of two or more letters intertwined together. The letters thus interlaced may be either all the letters of a name, or the initial letters of the Christian and surnames of a person for use upon note-paper, seals, &c. Many of the early Greek and Roman coins bear the monograms of rulers for whom or the towns in which they were struck. The Late Latin and Greek words were first applied to the signatures, which took this form, of the emperors of the Eastern Empire. The signatures of the Frankish kings also took the form of a monogram. The accompanying monogram, from a coin of Charles the Bald, is a good example of a "perfect" monogram, in which all the letters of the name Karolus can be traced (see DIPLOMATIC and AUTOGRAPHY). The most famous of monograms is that known as the

"Sacred Monogram," formed by the conjunction of the two initial letters of *Χριστός*, Christ. The most usual form of this is the symbol ξ , and sometimes the α (alpha) and ω (omega) of the Apocalypse were placed on either side of it. The symbol was incorporated in the *Labarum* (q.v.) when the imperial standard was Christianized. The interlaced I.H.S. (also called "The Sacred Monogram") apparently possesses no great antiquity; it is said to have been the

creation of St Bernard of Siena in the middle of the 13th century. Monograms or ciphers were often used by the early printers as devices, and are of importance in fixing the identity of early printed books. Similar devices have been used by painters and engravers. The middle ages were, indeed, extremely prolific in the invention of ciphers alike for ecclesiastical, artistic and commercial use. Every great personage, every possessor of fine taste, every artist, had his monogram. The mason's mark also was, in effect, a cipher. As the merchant had as a rule neither right nor authority to employ heraldic emblems, he therefore fell back upon plain simple letters arranged very much in monogram form. These "merchants' marks" generally took the form of a monogram of the owner's initials together with a private device. They nearly always contain a cross, either as a protection against storms or other catastrophes, or as a Christian mark to distinguish their goods from Mahomedan traders in the East. There is a fine example of a 16th century gold ring with a merchant's mark in the British Museum. One of the most famous of secular monograms is the interlaced "H.D." of Henri II. and Diane de Poitiers. Upon every building which that king erected it was sown profusely; it was stamped upon the buildings in the royal library, together with the bow, the quiver and the interlocked crescents of Diana. It has been argued that "H.D." is a misreading of "H.C.," which would naturally point to husband and wife; but the question is set at rest by the fact that Henri II. sometimes signed his letters to Diane with this very monogram. Henri IV. invented a punning cipher for his mistress Gabrielle d'Estrees, the surname being represented by a capital S. with a *trait*, or stroke through it.

See F. Buillot, *Dictionnaire des monogrammes* (1832-1834, 3 parts); G. K. Nagler, *Die Monogrammisten* (1857-1876, 5 parts); Ris-Paquot, *Dictionnaire encyclopédique des marques et monogrammes, chiffres, &c.* (1893); also Du Cange, *Glossarium* (s.v. *Monogramma*), with plates giving examples of the monograms of early popes, the emperors of the Western Empire, and of other kings.

MONOLOGUE (from Gr. *μόνος*, alone, and *λόγος*, speech), a passage in a dramatic piece in which a personage holds the scene to himself and speaks unconsciously aloud. The theory of the monologue is that the audience overhears the thoughts of one who believes himself to be alone, and who thus informs them of what would otherwise be unknown to them. The word is also used in cases when a character on the stage speaks at great length, even though not alone, but is listened to in silence by the other characters. The old-fashioned tragedies of the 17th and 18th centuries greatly affected this convention of the monologue, which has always, however, been liable to ridicule. There is something of a lyrical character about the monologue in verse; and this has been felt by some of the classic poets of France so strongly, that many of the examples in the tragedies of Corneille are nothing more or less than odes or cantatas. The monologues of Shakespeare, and those of *Hamlet* in particular, have a far more dramatic character, and are, indeed, essential to the development of the play. Equally important are those of Racine in *Phédre* and in *Athalie*. The French critics record, as the most admirable examples of the monologue in two centuries, that of Figaro in Beaumarchais's *Le Mariage de Figaro* and that of Charles V. in Victor Hugo's *Hernani*, the latter extends to 160 lines. In the Elizabethan drama, the popularity of Kyd's *Spanish Tragedy*, in which Hieronimo spouts interminably, set a fashion for ranting monologues, which are very frequent in Shakespeare's immediate predecessors and contemporaries. After 1600 the practice was much reduced, and the tendency of solitary heroes to pour forth columns of blank verse was held in check by more complex stage arrangements. After the Restoration the classic tragedies of the English playwrights again abused the privilege of monologue to such a degree that it became absurd, and fell into desuetude.

MONOMOTAPA. In old maps of south-east Africa, derived originally from Portuguese and from Dutch sources, an extensive region on the Quama or Zambesi and to the south of it is styled *regnum monomotapae*. The precise character of the kingdom or empire to which allusion is made has been the subject of much discussion, and some modern historians have gone so far



as to relegate the monomotapa to the realm of myth. But such scepticism is unjustifiable in view of the perfect unanimity with which, in spite of variations of detail, all Portuguese writers from the beginning of the 16th century onwards reiterated the assertion that there was a powerful rule known far and wide by that title.

The word "monomotapa" is of Bantu origin and has been variously interpreted. Father J. Torrend, *Comparative Grammar of the South African Bantu Languages* (p. 101) renders it "Lord of the water-elephants," and remarks that the hippopotamus is even to the present day a sacred animal among the Karanga. The earliest recorded bearer of the name is Mokomba Menamotapam, mentioned by Diogo de Alcaçova in 1506 as father of the Kwasirimo Menamotapam who ruled at that date over Vealanga, a large kingdom that included Sofala. His capital was called Zumubany, an obvious corruption of the term "Zimbabwe," regularly used to describe the residence of any important chief. The title is still found during the 18th century, but had probably become extinct by the beginning of the 19th if not earlier. Possibly its use was not confined to a single tribal section, occurring as it does in conjunction with the distinct dynastic names of Mokomba and Mambo, but the Karanga is the only tribe to which the Portuguese chroniclers attribute it. The latter, indeed, not only refer to the territory and the people of the monomotapa as "Mocaranga" (i.e. of the Karanga tribe), but explicitly assert that the "emperor" himself was a "Mocaranga." Consequently, he must have been a negro, and the Dominican who records the baptism of Dom Filippe by a friar of the order in the middle of the 17th century actually states that this "powerful king" was a black man ("com as carnes pretas"). This alone would be sufficient to controvert the baseless assumption that there existed in southern Rhodesia a ruling caste of different racial origin from the general Bantu population. The events following on the murder of the Jesuit father Dom Gonçalo da Silveira (cf. *Lusidias* X. 93) sufficiently demonstrate that the monomotapa, though susceptible to the persuasion of foreigners, was an independent potentate in the 16th century. The state and ceremony of his court, the number of his wives, and the order and organization of his officials, are described by several of the chroniclers.

It is difficult to arrive at an estimate of the extent of territory over which this great negro chief exercised direct or indirect control. The most extravagant theory is naturally that which was expressed by the Portuguese advocates in connexion with the dispute as to the ownership of Delagoa Bay. The crown of Portugal based its case against England on the cession of territory contained in a well-known treaty with the monomotapa (1609), and stated that this monarch's dominions then extended nearly to the Cape of Good Hope. A more moderate and actual view is given by Diogo de Couto, who in 1616 speaks of "a dominion over all Kaffraria from the Cabo das Correntes to the great river Zambezi." Several 17th-century writers extend the "empire" to the north of the Zambezi, Bocarro giving it in all "a circumference of more than three hundred leagues." It was "divided among petty kings and other lords with fewer vassals who are called inkosis or fumos." According to these authors, however, including Dos Santos, the paramountcy of the monomotapa was impaired in the 17th century by a series of rebellions. His zimbabwe, wherever it may have been in earlier days, was now fixed near the Portuguese fort of Masapa, only a short distance south of the Zambezi. A Portuguese garrison was maintained in it, and the monarch himself from the year 1607 onwards was little more than a puppet who was generally baptized by the Dominicans with a Portuguese name.

The only authorities of value are the original Portuguese documents collected, translated and edited by G. McC. Theal under the title *Records of South Eastern Africa* (9 vols., London, 1898-1902). Reference may be made to A. Wilnot's *Monomotapa* (London, 1891), which is, however, to a large extent superseded by Theal's far richer collection of material. (D. R.-M.)

MONONGAHELA, a city of Washington county, Pennsylvania, U.S.A., on the Monongahela river, 31 m. by rail S. of

Pittsburg. Pop. (1890), 4096; (1900), 5173 (711 foreign-born and 345 negroes); (1910) 7598. It is served by the Pennsylvania and the Pittsburg & Lake Erie railways, and by electric railways to Pittsburg and Washington, Pa. Monongahela is in a coal region, and the mining of coal is its principal industry. It was laid out as a town in 1792 by Joseph Parkinson, and named by him Williamsport; but it was commonly known as Parkinson's Ferry until 1833, when it was incorporated as a borough. Four years later the present name was adopted, and in 1873 Monongahela was chartered as a city. It was here that the Whisky Insurrection convention met on the 14th of August 1794.

MONOPHYSITES (Gr. *μονοφύσιται*), the name given to those who hold the doctrine that Christ had but *one* (*μῦθος*) composite nature (*φύσις*), and especially to those who maintained this position in the great controversies of the 5th and 6th centuries. The synod of Chalcedon (*q.v.*) in 451, following the lines of Pope Leo I.'s famous letter, endeavoured to steer a middle course between the so-called Nestorian and Eutychian positions. But the followers of Cyril of Alexandria, and with them those of Eutyches, saw in the Chalcedon decree of two natures only another form of the "Nestorian" duality of persons in Christ, and rose everywhere in opposition. For a century they were a menace not only to the peace of the Church but to that of the empire.

The first stage of the controversy covers the seventy-five years between the council of Chalcedon and the accession of Justinian in 527. In Palestine the fanatical monks led by Theodosius captured Jerusalem and expelled the bishop, Juvenal. When he was restored, after an exile of twenty months, Theodosius fled to Sinai and continued his agitation among the monks there. In Alexandria an insurrection broke out over the supercession of the patriarch Dioscurus by the orthodox Proterius, who was killed during the struggle. Timothy Aelurus was chosen bishop, and a synod which he called was so powerful as to impress even the emperor Leo I. at Constantinople, who, however, deposed him as well as Peter Fullo, who at Antioch had usurped the see of the orthodox bishop Martyrius. The short reign of Basiliscus (474-476) favoured the Monophysites, but the restoration of the rightful emperor Zeno marked an attempt at conciliation. On the advice of Acacius, the energetic patriarch of Constantinople, Zeno issued the *Henotikon* edict (482), in which Nestorius and Eutyches were condemned, the twelve chapters of Cyril accepted, and the Chalcedon *Definition* ignored. This effort to shelve the dispute was quite in vain. Pope Felix III. saw the prestige of his see involved in this slighting of Chalcedon and his predecessor Leo's epistle. He condemned and deposed Acacius, a proceeding which the latter regarded with contempt, but which involved a breach between the two sees that lasted after Acacius's death (489), through the long and troubled reign of Anastasius, and was only healed by Justin I. in 510. The monophysite cause reached its crowning point in the East when Severus was made bishop of Antioch in 513. This man was the stormy petrel of the period. A law student who had been converted from paganism, he became a monophysite monk at Alexandria. Expelled from that city in 513, he went with his followers to stir up strife in Constantinople, and succeeded in bringing about the deposition of the orthodox bishop, Macedonius, and of Flavian, bishop of Antioch. But Severus himself was deprived in 518: he went back to Alexandria, and became leader of the Phthartolatrai (see below), a subsection of the Monophysites.

Justin I. was only a tool in the hands of his nephew Justinian, who sided with the orthodox and brought about the reconciliation between Rome and Constantinople. In Jerusalem, Tyre, and other centres also, orthodoxy was re-established. In Egypt, however, monophysitism was as strong as ever, and soon set at Constantinople the arrogance of Rome caused a reaction, led by Theodora, the wife of the new emperor Justinian (527-565). Justinian himself, with the aid of Leontius of Byzantium (*c.* 485-543), a monk with a decided turn for Aristotelian logic and metaphysics, had tried to reconcile the Cyrillian and

Chalcedonian positions, but he inclined more and more towards the monophysite view, and even went so far as to condemn by edict three teachers (Theodore of Mopsuestia, Theodoret, the opponent of Cyril, and Ibas of Edessa) who were offensive to the monophysites. The Eastern bishops subscribed these edicts, and even Pope Vigilius yielded, in spite of the protests of the Western bishops, and at the 5th General Council (Constantinople, 553) agreed to the condemnation of the "three chapters"¹ and the anathematizing of any who should defend them by an appeal to the Definitions of Chalcedon. In the last years of his life (565) the emperor adopted the extreme Aphthartodocetæ position, and only his sudden death prevented this being forced on the Church. His successor, Justin II, took no action either way for six or seven years, and then instituted a quiet but thorough system of suppression, closing monophysite churches and imprisoning their bishops and priests.

Meanwhile monophysitism had split into several factions. Of these that represented by Severus stood nearest to the Christology of Cyril. Their objection to Chalcedon was that it was an innovation, and they fully acknowledged the distinctness of the two natures in Christ, insisting only that they became indissolubly united so that there was only one energy (*μία καινή θεανρική ενέργεια*) of Christ's will. Thus, as Harnack points out, "there is no trace of a *theological* difference between Severus and Leontius," only a difference of terminology and of degree of willingness to assent to the formula of Chalcedon. Severus laid such stress on the human infirmities of Christ as proving that His body was like ours, created and corruptible (*φθαρτός*)—his opponents dubbed him and his followers Phthartolatrae—worshippers of the corruptible.² The school of Thecistius of Alexandria extended the argument to Christ's human soul, which they said was, like ours, limited in knowledge. Hence their name Agnoetæ and their excommunication.

An opposite tendency was that of the Aphthartodocetæ or Phantasiastæ, represented by Julian, bishop of Halicarnassus, and, in his closing days, by Justinian. They held that Christ's body was so inseparably united with the Logos as not to be consubstantial with humanity; its natural attributes were so heightened as to make it sinless and incorruptible. An extreme school, the Aktistetæ or Gaiianists (Gaianus was bishop of Alexandria c. 550) even held that from the moment the Logos assumed the body the latter was *uncreated*, the human being transmuted into the divine nature; and the Adiaportites went still further, denying, like Stephen Barsudaill, an Edessan abbot, all distinction of essence not even between the manhood and the Godhead in Christ, but between the divine and the human, and asserting that "all creatures are of the same essence with the Creator."

A third variety of monophysitism was that known as Theopaschitism, a name given to those who accepted the formula that in the death of Christ "God had suffered and been crucified." Peter Fullo introduced these words into the *Trisagion*, and after much controversy the council of Constantinople (553), while disallowing this, gave its sanction to the similar statement—*unum crucifixum esse ex sancta et consubstantiali Trinitate*. The development of this line of thought led in some thinkers like John Philoponus to a kind of tritheism.

There is no doubt that the disintegration caused by monophysitism largely facilitated the rapid and easy victory of Islam in Syria and Egypt. The "ethical complement"³ of monophysitism is monothelism (see MONOTHELITES).

See the Histories of Dogma by A. Harnack, F. Loofs and R. Seeberg; also R. L. Ortley, *The Doctrine of the Incarnation*.

MONOPOLI, a seaport town and episcopal see of Apulia, Italy, in the province of Bari, from which it is 25 m. S.E. by rail, 30 ft. above sea-level. Pop. (1901), 22,616. The mediæval

walls are preserved and the castle dates from 1552. The harbour is small, the principal trade being in agricultural products. Close to it are rock-hewn tombs, possibly belonging to the ancient Gnathia (q.v.).

MONOPOLY (Gr. *μονοπωλία* or *μονοπωλίον*, exclusive sale, from *μόνος*, alone, and *πωλείν*, to sell), a term which, though used generally in the sense of exclusive possession, is more accurately applied only to grants from the Crown or from parliament, the private act of an individual whereby he obtains control over the supply of any particular article, being properly defined as "engrossing." It was from the practice of the sovereign granting to a favourite, or as a reward for good service, a monopoly in the sale or manufacture of some particular class of goods that the system of protecting inventions arose, and this fact lends additional interest to the history of monopolies (see PATENTS). When the practice of making such grants first arose it does not appear easy to say. Sir Edward Coke laid it down that by the ancient common law the king could grant to an inventor, or to the importer of an invention from abroad, a temporary monopoly in his invention, but that grants in restraint of trade were illegal. Such, too, was the law laid down in the first recorded case, *Darcy v. Allen* (the case of monopolies, 1602), and this decision was never overruled, though the law was frequently evaded. The patent rolls of the Plantagenets show few instances of grants of monopolies (the earliest known is temp. Edw. III.), and we come down to the reign of Henry VIII. before we find much evidence of this exercise of the prerogative in the case of either new inventions or known articles of trade. Elizabeth, as is well known, granted patents of monopoly so freely that the practice became a grave abuse, and on several occasions gave rise to serious complaints in the House of Commons. Lists prepared at the time show that many of the commonest necessities of life were the subjects of monopolies, by which their price was grievously enhanced. That the queen did not assume the right of making these grants entirely at her pleasure is shown, not only by her own statements in answer to addresses from the house, but by the fact that the preambles to the instruments conveying the grants always set forth some public benefit to be derived from their action. Thus a grant of a monopoly to sell playing-cards is made, because "divers subjects of able bodies, which might go to plough, did employ themselves in the art of making of cards"; and one for the sale of starch is justified on the ground that it would prevent wheat being wasted for the purpose. Accounts of the angry debates in 1565 and 1601 are given in Hume and elsewhere. The former debate produced a promise from the queen that she would be careful in exercising her privileges; the latter a proclamation which, received with great joy by the house, really had but little effect in stopping the abuses complained of.

In the first parliament of James I. a "committee of grievances" was appointed, of which Sir Edward Coke was chairman. Numerous monopoly patents were brought up before them, and were cancelled. Many more, however, were granted by the king, and there grew up a race of "purveyors," who made use of the privileges granted them under the great seal for various purposes of extortion. One of the most notorious of these was Sir Giles Mompesson, who fled the country to avoid trial in 1621. After the introduction of several bills, and several attempts by James to compromise the matter by orders in council and promises, the Statute of Monopolies was passed in 1623. This made all monopolies illegal, except such as might be granted by parliament or were in respect of new manufactures or inventions. Upon this excepting clause is built up the entire English system of letters patent for inventions. The act was strictly enforced, and by its aid the evil system of monopolies was eventually abolished. Parliament has, of course, never exercised its power of granting to any individual exclusive privileges of dealing in any articles of trade, such as the privileges of the Elizabethan monopolists; but the licences required to be taken out by dealers in wine, spirits, tobacco, &c., are lineal descendants of the old monopoly grants, while the quasi-monopolies enjoyed by

¹ *I.e.* (1) The person and writings of Theodore of Mopsuestia, (2) the writings of Theodoret in defence of Nestorius, (3) the letter written by Ibas to the Persian Maris.

² *φθαρτός*, corruptible, from *φθείρω*, destroy.

railways, canals, gas and water companies, &c., under acts of parliament, are also representative of the ancient practice.

See W. H. Price, *The English Patents of Monopoly* (1906).

MONOTHELITES (μονοθελίται, *monothelítai*, from Gr. *monos*, only, *θέλειν*, to will),¹ in Church history, the name given to those who, in the 7th century, while otherwise orthodox, maintained that Christ had only one will. Their effort, as defined by Dormer, was "an attempt to effect some kind of solution of the vital unity of Christ's person, which had been so seriously proposed by monophysitism, on the basis of the now firmly-established doctrine of the two natures." The controversy had its origin in the efforts of the emperor Heraclius to win back for the church and the empire the excommunicated and persecuted Monophysites or Eutychians of Egypt and Syria. In Egypt especially the monophysite movement had assumed a nationalistic, patriotic character. It was in Armenia, while on his expedition against Persia, in 622 that, in an interview with Paul, the head of the Severians (Monophysites) there, Heraclius first broached the doctrine of the *μία ἐνέργεια* of Christ, i.e. the doctrine that the divine and human natures, while quite distinct in His one person, had but one activity and operation.² At a somewhat later date he wrote to Arcadius of Cyprus, commanding that "two energies" should not be spoken of; and in 626, while in Lazistan (Colchis), he had a meeting with the metropolitan, Cyrus of Phasis, during which this command was discussed, and Cyrus was at last bidden to seek further instruction on the subject from Sergius, patriarch of Constantinople, a strong upholder of the *μία ἐνέργεια*, and the emperor's counsellor with regard to it. So well did he profit by the teaching he received in this quarter that, in 630 or 631, Cyrus was appointed to the vacant patriarchate of Alexandria, and in 633 succeeded in reconciling the Severians of his province on the basis of *μία θεοδρική ἐνέργεια* (one divine-human energy). He was, however, opposed by Sophronius, a monk from Palestine, who, after vainly appealing to Cyrus, actually went to Constantinople to remonstrate with Sergius himself. Shortly afterwards Sergius wrote to Pope Honorius, and received a friendly reply.³ Sophronius, however, who meanwhile had been made patriarch of Jerusalem (634), refused to be silenced, and in his *Epistola synodica* strongly insisted on the "two energies." So intense did the controversy now become, that at last, towards the end of 638, Heraclius published an *Ecthesis*, or Exposition of the Faith (composed by Sergius), which prohibited the use of the phrase "one energy," because of its disquieting effects on some minds, as seeming to militate against the doctrine of the two natures; while, on the other hand, the expression "two energies" was interdicted because it seemed to imply that Christ had two wills. That Christ had but one will was declared to be the only orthodox doctrine, and all the faithful were enjoined to hold and teach it without addition or deduction. The document was not acceptable, however, to Popes Severinus and John IV., the immediate successors of Honorius; and Maximus, the confessor, succeeded in stirring up such violent opposition in North Africa and Italy that, in 648, Constans II. judged it expedient to withdraw his grandfather's edict, and to substitute for it his own *Typus* or Precept (*τύπος περὶ πλῆρωσις*), forbidding all discussion of the questions of the duality or singleness of either the energy or the will of Christ. The scheme of doctrine of the first four general councils, in all its vagueness as to these points, was to be maintained; so far as the controversy had gone, the disputants on either side were to be held free from censure, but to resume it

would involve penal consequences. The reply of the Western Church was promptly given in the unambiguously dyothelite decrees of the Lateran synod held by Pope Martin I. in 649; but the cruel persecutions to which both Martin and Maximus were exposed, and finally succumbed, secured for the imperial *Typus* the assent at least of silence. With the accession of Constantine Pogonatus in 668 the controversy once more revived, and the new emperor resolved to summon a general council. It met at Constantinople in 680, having been preceded in 679 by a brilliant synod under Pope Agatho at Rome, where it had been agreed to depart in nothing from the decrees of the Lateran synod. The will, Agatho said, is a property of the nature, so that as there are two natures there are two wills; but the human will determines itself ever conformably to the divine and almighty will.

See R. L. Ottley, *The Doctrine of the Incarnation* (pt. vii. §§ 5, 6, 7); A. Harnack, *History of Dogma*, iv. 252-267; art. "Monotheliten" in Hauck-Herzog's *Realencyklop. für prot. Theologie* (vol. 13) by W. Müller and C. Krüger.

MONOTREMATA (a name referring to the single outlet for all the excretory channels of the body), the lowest subclass of the Mammalia, represented at the present day solely by the platypus and the echidnas. It has been proposed to replace this name, when used as a subclass, by Prototheria; but it is perhaps on the whole preferable to retain it both for the subclass and for the single order by which it is now represented, distinguishing the latter as Monotremata Vera.

Existing monotremes are characterized by the following features. In the first place they differ broadly from all other mammals in being oviparous, or possibly in the case of one family ovoviviparous; and also in the absence of mammae, or teats, the milk-glands opening on the surface of the skin of the breast by means of a number of fine pores. Moreover, the milk-glands themselves are commonly believed to represent sweat-glands and not those of other mammals, although it has been suggested that this distinction may not prove to be valid. In the strict sense of the term monotremes are not, therefore, mammals at all. Another feature in which these creatures differ from all other living mammals is the presence of a pair of coracoid bones, which articulate with the sternum, or breast-bone, as well as of paired precoracoids, or epicoracoids, and an unpaired T-shaped interclavicle, the arms of which overlie the clavicles or collar-bones. In all these respects monotremes closely resemble many reptiles. The brain lacks a *corpus callosum*, or band of nerve-tissue connecting the two hemispheres. Again, the bodies of the vertebrae are for the most part without terminal caps, or epiphyses; and each rib articulates to the vertebral column solely by its head or capitulum, instead of by a capitulum and a tuberculum. More important is the circumstance that the testes, which remain throughout life within the abdominal cavity, do not discharge by means of their ureters into a urinary bladder, but into a urino-genital sinus, which is in close communication with the lower end of the alimentary canal, so that the genital and waste products of the body are discharged by means of a common tube, or cloaca—a rather reptilian feature, although met with in certain other mammals. As regards other soft parts, the heart has the valve dividing the right auricle and ventricle incomplete and to a great extent fleshy—a feature which may, in some degree, account for the lower temperature of monotremes as compared with higher mammals. The presence of an anterior abdominal vein, or at least its supporting membrane, running right through the abdominal cavity, is another distinctive feature of the group. Of less importance is the presence of a pair of epipubic, or marsupial, bones attached to the front edge of the pelvis. The females have a complete or rudimentary pouch on the abdomen.

In the presence of hair, the relatively high temperature of the blood, the absence of nuclei to the red blood-corpuscles, and the existence of only the left aortic arch, as well as in the absence of a separate quadrate-bone, and the simple structure of the lower jaw, monotremes conform to the ordinary mammalian type. On the other hand the skull of the platypus possesses a peculiar "dumb-bell bone," believed to represent the reptilian prevomer.

¹ The name seems to occur first in John of Damascus.

² Paul, speaking for the monophysite bishops, had said that what was particularly repugnant in the definition of Chalcedon (q.v.) was the implication of two wills in Christ. See Hefele, *Conciliengesch.* iii. 124 seq. (1877), who also traces the previous history of the expressions *μία ἐνέργεια*, *θεοδρική ἐνέργεια*, especially as found in the writings of the Pseudo-Dionysius Areopagita, which first appeared in Egypt in the 5th century.

³ In two letters Honorius expressed himself in accord with the monothelite view, for which he was denounced as heretical by the Sixth General Council and anathematized by Pope Leo II.

The females produce their young from eggs, which are relatively large, and develop in the same manner as those of birds and reptiles, a portion only of the yolk segmenting to form the embryo, while the remainder serves for the nutriment of the latter. In the case of *Ornithorhynchus* it has been said that two eggs are laid in the chamber at the end of the burrow,¹ but those of the *Echidnidae* are carried about in the pouch on the abdomen of the female, which becomes enlarged during the time of incubation. In the adult state neither of the living groups of Monotremata have teeth; but this is evidently only a specialized feature, the young platypus having functional teeth. In the latter, three pairs of these teeth are developed in the upper, and three in the lower jaw; but after being for some time in use, they gradually become worn away, and are finally shed. Under and around the teeth are developed the horny plates, or "cornules," which gradually grow round them and assume their function, the hollows on the surface of the cornules indicating the positions of the teeth. In form these teeth make a distant approximation to the molars of some of the extinct *Multituberculata* (*M.T.*)

A peculiarity of the males is the presence in the hind-limb of an additional, flat, curved ossicle on the hinder and tibial side of the plantar aspect of the tarsus, articulating chiefly to the tibia, supporting in the adult a sharp-pointed perforated horny spur, with which is connected the duct of a gland situated beneath the skin of the back of the thigh. (A rudimentary spur is found in the young female *Ornithorhynchus*, but this disappears when the animal becomes adult.) The stomach is sub-globular and simple; the alimentary canal has no ileo-caecal valve, or marked distinction between large and small intestine, but is furnished with a small, slender vermiform caecum with glandular walls. The liver is divided into the usual number of lobes, and is provided with a gall-bladder.

The trunk-vertebrae are nineteen in number. The transverse processes of the cervical vertebrae are independently developed, and remain naturally connected with the bodies of the vertebrae until the animal is full-grown. Though in this respect monotremes present an approximation to reptiles, they differ in that there is not a gradual transition from these transverse processes of the neck-vertebrae (or cervical ribs, as they may be considered) into the thoracic ribs, for in the seventh vertebra the costal element is much smaller than in the other, indicative of a very marked separation of neck from thorax, not seen in reptiles. The sternal ribs are well ossified, and there are distinct, partly ossified, intermediate ribs. The brachial, unlike that of the lower marsupials or reptiles, is large and hemispherical, flattened below, arched above, and about as broad as long. The cribriform plate of the ethmoid is nearly horizontal. The cranial walls are very thin, and smoothly rounded externally, and the sutures become completely obliterated in adults. The broad occipital region slopes upwards and forwards, and the face is produced into a long depressed beak. The bony palate is prolonged backwards, so that the posterior nares are nearly on a level with the glenoid fossa. The lower jaw, or mandible, is without distinct ascending ramus; the coronoid process and angle being rudimentary, and the two halves loosely connected at the symphysis. The fibula has a broad, flattened process, projecting from its upper extremity above the articulation, like an olecranon.

The first family, *Ornithorhynchidae*, is represented solely by the duck-billed platypus, or platypus (*Ornithorhynchus anatinus*), in which the hemispheres of the brain are relatively small and smooth, while the muzzle is expanded to form a spatula-like beak, covered during life with a delicate sensitive skin, which dries in museum-specimens to a horny consistency. Although, as mentioned above, functional teeth are developed in the young, in the adult their function is discharged by "cornules," or horny structures—elongated, narrow and sharp-edged, along the anterior part of the sides of the mouth, and broad, flat-topped or molariform behind. The legs are short and adapted for swimming; the feet webbed, each with five well-developed toes armed with large claws, and beyond which in the fore-feet the interdigital membrane is extended. Vertebrae: C. 7, D. 17, L. 2, S. 2, Ca. 21. Acetabulum of pelvis not perforated. Tongue not extensive. Mucous membrane of small intestine covered with delicate, close-set transverse folds or ridges. Tail rather short, broad, and depressed. Eyes very small. Fur close and soft.

The platypus, or water-mole, is common to Australia and Tasmania, and entirely aquatic in habits, diving freely, and making its burrow in the river-banks. It feeds on insects, snails, small bivalve molluscs, and worms. In the adult state bivalves form its chief food; and it is believed that the substitution of horny plates for brittle teeth is an adaptation for cracking the shells of these creatures. (See *PLATYPUS*.)

¹ There does not appear to be authentic evidence that the eggs in this genus are actually laid. (See *PLATYPUS*.)

The second family, *Echidnidae*, has a wider geographical distribution, including Australia, Tasmania and New Guinea, and is represented by two genera. The hemispheres of the brain are large and convoluted; and the muzzle is produced into a long, tapering, tubular beak, at the end of which the nostrils are situated. The two branches of the lower jaw are slender and rod-like. Opening of mouth small, and placed below the extremity of the beak. No teeth, though the palate and tongue are furnished with spines. Tongue very long, vermiform, slender and protractile. Lining membrane of small intestine villous, but without transverse folds. Feet with long strong claws for scratching and burrowing. The hind-feet with the ends of the toes turned outwards and backwards in the ordinary position of the animal when on the ground. Tail very short. Acetabulum with a large perforation. Calcaneal spur and gland of the male much smaller than in *Ornithorhynchus*. Fur intermixed with strong, sharp-pointed spines. Terrestrial and fossorial in habits, feeding exclusively on ants.

The typical genus *Echidna* is represented by the echidna, or porcupine-anteater (*E. aculeata*), which has a distribution



Bruijn's Echidna (*Proechidna bruijni*).

equivalent to that of the family, and includes several local races. It is characterized by the presence of five claws to each foot, the moderately long and straight beak, the tapering tongue, with its spines restricted to the basal portion, and the vertebrae numbering C. 7, D. 16, L. 3, S. 3, Ca. 12. In *Proechidna*, represented by the larger *P. bruijni* and *P. nigroaculeata*, both from New Guinea, on the other hand, terminal phalanges and claws are present only on the three middle toes of each foot, the tongue is somewhat spoon-shaped and carries three rows of spines along its upper surface, and there are 17 dorsal and four lumbar vertebrae. (See *ECHIDNA*.)

At present no light is shed by palaeontology on the past history of the Monotremata Vera. Species of *Echidna* and *Ornithorhynchus* have indeed been described from the superficial formations of Australia, but they apparently differ in no structural details from their existing representatives.

Possibly some of the extinct Jurassic mammals with a marsupial or insectivorous type of dentition referred to in the article *MARSUPIALIA* may be monotremes, but there is no definite evidence that this is the case. On the other hand, there is a possibility that another extinct group of mammals, dating from the Trias and continuing till the Lower Eocene, may belong to the present subclass, of which they form a second order. (See *MULTITUBERCULATA*.)

The most important recent information with regard to the Monotremata will be found in Dr R. Semon's *Reise in Australien*, in the *Denkschrift* of the Jena Natural History Society. (R. L. *)

MONOTRIGLYPH, in architecture, the interval of the intercolumniation of the Doric column, which is observed by the intervention of one triglyph only between the triglyphs which come over the axes of the columns. This is the usual arrangement, but in the Propylaea at Athens there are two triglyphs over the central intercolumniation, in order to give increased width to the roadway, up which chariots and beasts of sacrifice ascended.

MONOTYPIC (Gr. *mónos*, alone, single, and *τύπος*, a type), a term used in biology, &c., for subjects having only one exponent, for example a genus containing only one species.

MONREALE (contraction of *monte-reale*, so called from a palace built here by Roger I.), a town of Sicily, in the province of Palermo, 5 m. inland (W.S.W.) from it, on the slope of Monte Caputo, overlooking the beautiful and very fertile valley called "*La Conca d'oro*" (the Golden Shell), famed for its orange, olive and almond trees, the produce of which is exported in large quantities. Pop. (1901), 17,379 (town); 23,556 (commune). The town, which for long was a mere village, owed its origin to the founding of a large Benedictine monastery, with its church, the seat of the metropolitan archbishop of Sicily.¹ This, the greatest of all the monuments of the wealth and artistic taste of the Norman kings in northern Sicily, was begun about 1170 by William II., and in 1182 the church, dedicated to the Assumption of the Virgin Mary, was, by a bull of Pope Lucius III., elevated to the rank of a metropolitan cathedral.

The archiepiscopal palace and monastic buildings on the south side were of great size and magnificence, and were surrounded by a massive precinct wall, crowned at intervals by twelve towers. This has been mostly rebuilt, and but little now remains except ruins of some of the towers, a great part of the monks' dormitory and frater, and the splendid cloister, completed about 1200. This last is well preserved, and is one of the finest cloisters both for size and beauty of detail now extant. It is about 170 ft. square, with pointed arches decorated with diaper work, supported on pairs of columns in white marble, 216 in all, which were alternately plain and decorated by bands of patterns in gold and colours, made of glass tesserae, arranged either spirally or vertically from end to end of each shaft. The marble caps are each richly carved with figures and foliage executed with great skill and wonderful fertility of invention—no two being alike. At one angle, a square pillared projection contains the marble fountain or monks' lavatory, evidently the work of Moslem sculptors.

The church is fortunately well preserved. In plan it is a curious mixture of Eastern and Western arrangement. The nave is like a basilica, with a double row of pointed arches and the choir is like one of the early three-apsed churches, of which so many examples still exist in Syria and other eastern countries. It is, in fact, like two quite different churches put together endwise. The basilican nave is wide, with narrow aisles. Monolithic columns of grey oriental granite (except one, which is of cipollino), evidently the spoils of older buildings, on each side support eight pointed arches much stilted. The capitals of these (mainly Corinthian) are also of the classical period. There is no triforium, but a high clerestory with wide two-light windows, with simple tracery like those in the nave-aisles and throughout the church, which give sufficient light (if anything too much) light. The other half, Eastern in two senses, is both wider and higher than the nave. It also is divided into a central space with two aisles, each of the divisions ending at the east with an apse. The roofs throughout are of open woodwork very low in pitch, constructionally plain, but richly decorated with colour, now mostly restored. At the west end of the nave are two projecting towers, with a narthex-entrance between them. A large open atrium, which once existed at the west, is now completely destroyed, having been replaced by a Renaissance portico. The outside of the church is plain, except the aisle walls and three eastern apses, which are decorated with intersecting pointed arches and other ornaments inlaid in marble. The outside of the principal doorways and their pointed arches are magnificently enriched with carving and coloured inlay, a curious combination of three styles—Norman-French, Byzantine and Arab.

It is, however, the enormous extent (70,400 sq. ft.) and glittering splendour of the glass mosaics covering the interior which make this church so splendid. With the exception of a high dado, itself very beautiful, made of marble slabs with bands of mosaic between them, the whole interior surface of the walls, including soffits and jambs of all the arches, is covered with intricate mosaic-pictures in brilliant colours on a gold ground. The mosaic pictures are arranged in tiers, divided by horizontal and vertical bands. In parts of the choir there are five of these tiers of subjects or single figures one above another. The half dome of the central apse has a colossal half-length figure of Christ, with a seated Virgin and Child below; the other apses have full-length colossal figures of St Peter and St Paul. Inscriptions on each picture explain the subject or saint represented; these are in Latin, except some few which are in Greek. The subjects in the nave begin with scenes from the Book of Genesis, illustrating the Old Testament types of Christ and His scheme of redemption, with figures of those who prophesied and prepared for His coming. Towards the east are subjects from the New Testament,

¹ An earlier church appears to have existed at Monreale since the 6th century, but no traces of it now remain.

chiefly representing Christ's miracles and suffering, with apostles, evangelists and other saints. The design, execution and choice of subjects all appear to be of Byzantine origin, the subjects being selected from the *Menologium* drawn up by the emperor Basilios Porphyrogenitus in the 10th century.

In the central apse at Monreale, behind the high altar, is a fine marble throne for the archbishop. This position of the throne is a survival of the early basilican arrangement, when the apse and altar were at the west end. In that case the celebrant stood behind the altar at mass, and looked over it eastwards towards the people. On the north side, in front of the high altar, is another somewhat similar throne for the use of the king. The tomb of William I., the founder's father—a magnificent porphyry sarcophagus contemporary with the church, under a marble pillared canopy—and the founder William II.'s tomb, erected in 1575, were both shattered by a fire, which in 1811 broke out in the choir, injuring some of the mosaics, and destroying all the fine walnut choir-fittings, the organs, and most of the choir roof. The tombs were rebuilt, and the whole of the injured part of the church restored, mostly very clumsily, a few years after the fire. On the north of the choir are the tombs of Margaret, wife of William I., and her two sons Roger and Henry, together with an urn containing the viscera of St Louis of France, who died in 1270. The pavement of the triple choir, though much restored, is a very magnificent specimen of marble and porphyry mosaic in *opus alexandrinum*, with signs of Arab influence in its main lines. The pavement of the nave, on the other hand, is of the 16th century. Two baroque chapels were added in the 17th and 18th centuries, which are fortunately shut off from the rest of the church.

The bronze doors, those on the north and west of the church, are of great interest in the history of art. They are both divided into a number of square panels with subjects and single figures, chiefly from Bible history, cast in relief. That on the north is by Barisanus of Trani in southern Italy, an artist probably of Greek origin. It is inscribed *BARISANUS TRAN. ME FECIT*. The cathedrals at Trani and Ravello also have bronze doors by the same sculptor. The western door at Monreale, inferior to the northern one both in richness of design and in workmanship, is by Bonannus of Pisa, for the cathedral of which place he cast the still existing bronze door on the south, opposite the leaning tower. The one at Monreale is inscribed *BONANNUS PISANUS ME FECIT*. In that case the door at Monreale is superior in execution to the Pisa one. The door by Barisanus is probably of about the same time, as other examples of his work with inscribed dates show that he was a contemporary of Bonannus. The effect of the façade is not improved by the Renaissance portico that has been added to it. The monastic library contains some valuable MSS., especially a number of bilingual documents in Greek and Arabic, the earliest being dated 1144. The archbishop now occupies the eastern part of the monastic buildings, the original palace being destroyed.

See D. B. Gravina, *Il Duomo di Monreale* (Palermo, 1859-1865).

(J. H. M.; T. As.)

MONRO, DAVID BINNING (1836-1905), English Homeric scholar, was born in Edinburgh on the 16th of November 1836. He was a grandson of Alexander Monro, tertius (1773-1859), professor of anatomy in Edinburgh University, whose father, Alexander Monro, secundus (1733-1817), and grandfather, Alexander Monro, primus (1697-1767), both filled the same position. He was educated at Glasgow University, and Brasenose and Balliol Colleges, Oxford. In 1859 he was elected fellow, and in 1882 provost of Oriel, which office he held till his death at Heiden, Switzerland, on the 22nd of August 1905. He was a man of varied attainments, an excellent linguist, and possessed considerable knowledge of music, painting and architecture. His favourite study was Homer, and his *Grammar of the Homeric Dialect* (2nd ed., 1891) established his reputation as an authority on that author. He also edited the last twelve books of the *Odyssey*, with valuable appendices on the composition of the poem, its relation to the *Iliad* and the cyclic poets, the history of the text, the dialects, and the Homeric house; a critical text of the poems and fragments (*Homeri opera et reliquiae*, 1896); *Homeri opera* (1902, with T. W. Allen, in *Scriptorium classicorum bibliothecae oxoniensis*); and an edition of the *Iliad* with notes for schools. His article on Homer, written for the 9th edition of the *Encyclopaedia Britannica*, was revised by him for this work before he died. Mention may also be made of his *Modes of Ancient Greek Music* (1894), on which see *Classical Review* for December 1894, with author's reply in the same for February 1895.

See *Memoir* by J. Cook Wilson (Oxford, 1907).

MONROE, JAMES (1758-1831), fifth president of the United States, was born on Monroe's creek, a tributary of the Potomac

river, in Westmoreland county, Virginia, on the 28th of April 1758. His father, Spence Monroe, was of Scotch, and his mother, Elizabeth Jones, was of Welsh descent. At the age of sixteen he entered the College of William and Mary, Williamsburg, Virginia, but in 1776 he left college to take part in the War for Independence. He enlisted in the Third Virginia regiment, in which he became a lieutenant, and subsequently took part in the battles of Harlem Heights, White Plains, Trenton (where he was wounded), Brandywine, Germantown, and Monmouth. In November 1777 he was appointed volunteer aide-de-camp to William Alexander ("Lord Stirling"), with the rank of major, and thereby lost his rank in the Continental line; but in the following year, at Washington's solicitation, he received a commission as lieutenant-colonel in a new regiment to be raised in Virginia. In 1780 he began the study of law under Thomas Jefferson, then governor of Virginia, and between the two there developed an intimacy and a sympathy that had a powerful influence upon Monroe's later career.

In 1782 he was elected to the Virginia House of Delegates, and though only twenty-four years of age he was chosen a member of the governor's council. He served in the Congress of the Confederation from 1783 to 1786 and was there conspicuous for his vigorous insistence upon the right of the United States to the navigation of the Mississippi River, and for his attempt, in 1785, to secure for the weak Congress the power to regulate commerce, in order to remove one of the great defects in the existing central government. On retiring from Congress he began the practice of law at Fredericksburg, Virginia, was chosen a member of the Virginia House of Delegates in 1787, and in 1788 was a member of the state convention which ratified for Virginia the Federal constitution. In 1790 he was elected to the United States senate to fill the vacancy caused by the death of William Grayson, and although in this body he vigorously opposed Washington's administration, Washington on the 27th of May 1794 nominated him as minister to France. It was the hope of the administration that Monroe's well-known French sympathies would secure for him a favourable reception, and that his appointment would also conciliate the friends of France in the United States. His warm reception in France and his enthusiastic Republicanism, however, displeased the Federalists at home; he did nothing, moreover, to reconcile the French to the Jay treaty (see JAY, JOHN), which they regarded as a violation of the French treaty of alliance of 1778 and as a possible *casus belli*. The administration therefore decided that he was unable to represent his government properly and late in 1796 recalled him.

Monroe returned to America in the spring of 1797, and in the following December published a defence of his course in a pamphlet of 500 pages entitled *A View of the Conduct of the Executive in the Foreign Affairs of the United States*, and printed in Philadelphia by Benjamin Franklin Bache (1769-1798). Washington seems never to have forgiven Monroe for this, though Monroe's opinion of Washington and Jay underwent a change in his later years. In 1799 Monroe was chosen governor of Virginia and was twice re-elected, serving until 1802. At this time there was much uneasiness in the United States as a result of Spain's restoration of Louisiana to France by the secret treaty of San Ildefonso, in October 1800; and the subsequent withdrawal of the "right of deposit" at New Orleans by the Spanish intendant greatly increased this feeling and led to much talk of war. Resolved upon peaceful measures, President Jefferson in January 1803 appointed Monroe envoy extraordinary and minister plenipotentiary to France to aid Robert R. Livingston, the resident minister, in obtaining by purchase the territory at the mouth of the Mississippi, including the island of New Orleans, and at the same time authorized him to co-operate with Charles Pinckney, the minister at Madrid, in securing from Spain the cession of East and West Florida. On the 18th of April Monroe was further commissioned as the regular minister to Great Britain. He joined Livingston in Paris on the 12th of April, after the negotiations were well under way; and the two ministers, on finding Napoleon willing

to dispose of the entire province of Louisiana, decided to exceed their instructions and effect its purchase. Accordingly, on the 30th of April, they signed a treaty and two conventions, whereby France sold Louisiana to the United States (see LOUISIANA PURCHASE). In July 1803 Monroe left Paris and entered upon his duties in London; and in the autumn of 1804 he proceeded to Madrid to assist Pinckney in his efforts to secure the definition of the Louisiana boundaries and the acquisition of the Floridas. After negotiating with Don Pedro de Cevallos, the Spanish minister of foreign affairs, from January to May 1805, without success, Monroe returned to London and resumed his negotiations, which had been interrupted by his journey to Spain, concerning the impressment of American seamen and the seizure of American vessels. As the British ministry was reluctant to discuss these vexed questions, little progress was made, and in May 1806 Jefferson ordered William Pinkney of Maryland to assist Monroe. The British government appointed Lords Auckland and Holland as negotiators, and the result of the deliberations was the treaty of the 31st of December 1806, which contained no provision against impressments and provided no indemnity for the seizure of goods and vessels. In passing over these matters Monroe and Pinkney had disregarded their instructions, and Jefferson was so displeased with the treaty that he refused to present it to the senate for ratification, and returned it to England for revision. Just as the negotiations were re-opened, however, the questions were further complicated and their settlement delayed by the attack of the British ship "Leopard" upon the American frigate "Chesapeake." Monroe returned to the United States in December 1807, and was elected to the Virginia House of Delegates in the spring of 1810. In the following winter he was again chosen governor, serving from January to November 1811, and resigning to become secretary of state under Madison, a position which he held until the 3rd of March 1817. The direction of foreign affairs in the troubled period immediately preceding and during the second war with Great Britain thus devolved upon him. On the 27th of September 1814, after the disaster of Bladensburg and the capture of Washington by the British, he was appointed secretary of war to succeed General John Armstrong, and discharged the duties of this office, in addition to those of the state department, until March 1815.

In 1816 Monroe was chosen president of the United States; he received 183 electoral votes, and Rufus King, his Federalist opponent, 34. In 1820 he was re-elected, receiving all the electoral votes but one, which William Plumer (1759-1850) of New Hampshire cast for John Quincy Adams, in order, it is said, that no one might share with Washington the honour of a unanimous election. The chief events of his administration, which has been called the "era of good feeling," were the Seminole War (1817-18); the acquisition of the Floridas from Spain (1819-21); the "Missouri Compromise" (1820), by which the first conflict over slavery under the constitution was peacefully adjusted; the veto of the Cumberland Road Bill (1822) on constitutional grounds; and—most

¹ The Cumberland (or National) Road from Cumberland, Maryland, to Wheeling, West Virginia, was projected in 1806, by an appropriation of 1819 was extended to the Ohio River, by an act of 1825 (signed by Monroe on the last day of his term of office) was continued to Zanesville, and by an act of 1826 was extended westward from Zanesville. The appropriation of 1806 for the construction of the road had brought into national politics the question of the authority of the Federal government to make "internal improvements." The bill vetoed by Monroe would in effect have given to the Federal government jurisdiction over the road; and in his elaborate memorandum (May 4, 1822) accompanying his veto message, Monroe discussed at length the constitutional questions involved, argued that the Federal government was empowered by the Constitution to appropriate money for "internal improvements," and in concert with the states through which a road was to pass might supervise the construction of such a road, but might not exercise jurisdiction over it, and advocated the adoption of an amendment to the constitution giving larger power to the Federal government "confined to great national works only, since, if it were unlimited it would be liable to abuse, and might be productive of evil." For the history of the Cumberland Road, see Archer B. Hulbert, *The Cumberland Road* (Cleveland, Ohio, 1904).

intimately connected with Monroe's name—the enunciation in the presidential message of the 2nd of December 1823 of what has since been known as the Monroe Doctrine (*q.v.*), which has profoundly influenced the foreign policy of the United States. On the expiration of his second term he retired to his home at Oak Hill, Loudoun county, Virginia. In 1826 he became a regent of the university of Virginia, and in 1829 was a member of the convention called to amend the state constitution. Having neglected his private affairs and incurred large expenditures during his missions to Europe, he experienced considerable pecuniary embarrassment in his later years, and was compelled to ask Congress to reimburse him for his expenses in the public service. Congress finally (in 1826) authorized the payment of \$30,000 to him, and after his death appropriated a small amount for the purchase of his papers from his heirs. He died in New York City on the 4th of July 1831, while visiting his daughter, Mrs Samuel L. Gouverneur. In 1858, the centennial year of his birth, his remains were reinterred with impressive ceremonies at Richmond, Virginia. Jefferson, Madison, John Quincy Adams, Calhoun, and Benton all speak loudly in Monroe's praise; but he suffers by comparison with the greater statesmen of his time. Possessing none of their brilliance, he had, nevertheless, to use the words of John Quincy Adams, "a mind . . . sound in its ultimate judgments, and firm in its final conclusions." Schouler points out that like Washington and Lincoln he was "conspicuous . . . for patient considerateness to all sides." Monroe was about six feet tall, but, being stoop-shouldered and rather ungainly seemed less; his eyes, a greyish blue, were deep-set and kindly; his face was delicate, naturally refined, and prematurely lined. The best-known portrait, that by Vanderlyn, is in the New York City Hall. Monroe was married in 1786 to Elizabeth Kortwright (1768–1830) of New York, and at his death was survived by two daughters.

See *The Writings of James Monroe* (7 vols., New York, 1809–1903), edited by S. M. Hamilton; Daniel C. Gilman, *James Monroe* (Boston, 1883), in the "American Statesman Series"; J. R. Ireland, *History of the Life, Administration and Times of James Monroe*, being vol. v. of his *Republic* (Chicago, 1887); John Quincy Adams, *The Lives of James Madison and James Monroe* (Buffalo, 1850); B. W. Bond, jun., *Monroe's Mission to France, 1794–1796* (Baltimore, 1907); Henry Adams, *History of the United States* (9 vols., New York, 1889–1891), containing a full but unsympathetic account of Monroe's career as a diplomatist; and James Schouler, *History of the United States*, vols. ii. and iii. (New York, 1894), which estimates his public services highly.

MONROE, a city of Louisiana, U.S.A., the capital of Ouachita parish, in the northern part of the state, on the east bank of the Ouachita river, 72 m. W. of Vicksburg, Mississippi, and 96 m. E. of Shreveport, Louisiana. Pop. (1890), 3256; (1900), 5428 (2834 negroes); (1910), 10,209. It is served by the Arkansas, Louisiana & Gulf, the Little Rock & Monroe, the Vicksburg, Shreveport & Pacific (Queen & Crescent), and the St Louis, Iron Mountain & Southern railways, and by river steamers plying between New Orleans and Camden, Arkansas. Across the Ouachita is the town of West Monroe (pop. in 1910, 1127). The improvement of the river, by the removal of snags and the construction of dams and locks in order to give it a navigable depth of 10 ft. at Monroe and 6½ ft. beyond Camden, was nearly completed by the United States government in 1909. Monroe lies in a level valley, and has broad streets shaded by live oaks. Among the public buildings are a handsome city-hall, a city market-house, a charity hospital and a high school. There are also a parish high school and St Hyacinth's Academy (Roman Catholic). The leading industries are the manufacture of lumber and cotton products.

In 1785, during the Spanish occupation of Louisiana, Juan Filhiol, commandant of the district of Ouachita, founded a settlement on the site of the present Monroe, which was called Ouachita Post until 1790 and then Fort Miró, in honour of the governor-general. In 1819 the place was renamed Monroe, in honour of President James Monroe, and in the following year the town was incorporated. Monroe was chartered as a city in 1871, and received a new charter in 1902.

MONROE, a city and the county-seat of Monroe county, Michigan, U.S.A., on the Raisin river, 2 m. from Lake Erie,

near the south-eastern corner of the state. Pop. (1890), 5289; (1900), 5043; (1904), 6128; (1910), 6893. It is served by the Michigan Central, the Lake Shore & Michigan Southern, the Père Marquette, and the Detroit & Toledo Shore Line railways, and by electric lines to Detroit and Toledo. There is a statue here (dedicated in 1910) of Gen. G. W. Custer. Monroe has a German Altheim and St Mary's academy and college for girls. The city has a large trade in farming-produce and fish, and various manufactures. The place was settled in 1783 by French Canadians and called Frenchtown. In January 1813 the inhabitants, fearing destruction from the British and their Indian allies, pleaded to the Americans for protection, and about 660 men from the army of General James Winchester (1752–1826), sent from the rapids of the Maumee river, on the 17th of January drove a small British force from the village. Three days later General Winchester arrived with 300 more men; but at dawn on the 22nd Colonel Henry A. Proctor (1787–1859) with a force of British and Indians surprised the Americans, defeated their right wing, captured General Winchester and obtained from him an order for the surrender of his entire force. In 1815 Monroe received its present name in honour of James Monroe. In 1817 it was made the county-seat, and in 1827 it was incorporated as a village. It was chartered as a city in 1837 (being rechartered in 1874), and as a city of the fourth class in 1895.

MONROE DOCTRINE. That the United States should avoid entangling itself in the politics of Europe was a policy recommended by Washington. The counterpart of this, that European powers should be prevented from taking a controlling share in the politics of the American continent, grew gradually as the importance and influence of the United States increased. This American attitude towards the European powers became crystallized in what is known as the Monroe Doctrine, since it was first announced officially in a concrete form, though not originated, by President Monroe. His declaration was the result of American apprehension that the combination of European powers known as the Holy Alliance would interfere in South America to restore the Spanish colonies, which had asserted their independence, to the crown of Spain. To meet and check this movement, in his message to Congress on the 2nd of December 1823, Monroe made the following pronouncement:—

In the wars of the European powers in matters relating to themselves we have never taken any part, nor does it comport with our policy so to do. It is only when our rights are invaded or seriously menaced that we resent injuries or make preparations for our defence. With the movements in this hemisphere we are of necessity more immediately connected, and by causes which must be obvious to all enlightened and impartial observers. The political system of the allied powers is essentially different in this respect from that of America. . . . We owe it, therefore, to candour, and to the amicable relations existing between the United States and those powers, to declare that we should consider any attempt on their part to extend their system to any portion of this hemisphere as dangerous to our peace and safety. With the existing colonies or dependencies of any European power we have not interfered and shall not interfere. . . . But with the governments who have declared their independence and maintained it, and whose independence we have on great consideration and on just principles acknowledged, we could not view any interposition for the purpose of oppressing them or controlling in any other manner their destiny by any European power in any other light than as the manifestation of an unfriendly disposition towards the United States. . . . It is impossible that the allied powers should extend their political system to any portion of either continent without endangering our peace and happiness; nor can any one believe that our Southern brethren, if left to themselves, would adopt it of their own accord. It is equally impossible, therefore, that we should behold such interposition in any form with indifference.

Earlier in the same message, while discussing negotiations for the settlement of the respective claims of Russia, Great Britain, and the United States in the north-west, Monroe also said:—

In the discussion to which this interest has given rise and the arrangements by which they may terminate, the occasion has been judged proper for asserting as a principle in which the rights and interests of the United States are involved, that the American continents, by the free and independent condition which they have

assumed and maintain, are henceforth not to be considered as subjects for future colonization by any European powers.

With this message Great Britain was in hearty agreement. Indeed it was Canning's policy, summed up three years later by his famous reference to the necessity of calling the New World into existence to restore the balance of the Old.

This announcement of policy, it will be noticed, involved, firstly, a declaration aimed at foreign intervention in the political affairs of independent American states; secondly, a warning against future European colonization on the American continents. The first was avowedly based on the right of self-defence; it was a policy, not a law; it was not to constrain the minor republics, but to protect them. The second, as explained by John Quincy Adams, was intended to state the fact that the American continent was occupied by contiguous states, leaving no room for further colonization and introduction of foreign sovereignty. No legislative sanction was given to Monroe's statement of policy at the time, and in fact none was needed, for the mere announcement served to prevent foreign action in South America. It has never formed part of the body of International Law, being unilateral. Nor has the United States bound itself by compact with the other republics of the American continent to protect them from European aggression. Thus it hesitated to send delegates to the Panama Congress in 1826, and took no part in any congress with the Latin American states until 1889.

Nevertheless, on several occasions since its conception the Monroe Doctrine has been enforced. Its spirit permeated the Clayton-Bulwer Treaty, in which Great Britain and the United States, in 1850, mutually renounced the right of colonizing, fortifying or occupying any portion of Central America. It was enforced against Maximilian, who, by French intervention in Mexico, had been made emperor, and until the close of the American Civil War had performed been left undisturbed. Its applicability was urged when de Lesseps's Panama Canal was thought possible of completion. Both Cuba and the Hawaiian Islands at various periods have felt its influence, the general, though not consistent policy of the United States being, while disclaiming the desire of annexation itself, to deny the right of any European power (except Spain in Cuba's case, until 1898) to control them. And it was applied to the claims of British Guiana to Venezuelan territory by President Cleveland's message in 1895, which proposed a commission to settle the boundary and threatened war if its line were not accepted. This commission never reported, but the disputants finally agreed to arbitrate, and the British claim was in the main upheld.

Between 1823 and 1895 the development and enlargement of this policy on the part of the United States was very striking. To prevent the overthrow of an independent republic is one thing; to interfere in the settlement of a boundary dispute between two states, also on the ground of self-defence, is quite another. Yet Cleveland's doctrine met with general acceptance, and in fact it had been in a sense anticipated by President Grant, who, in urging the annexation of San Domingo upon the United States Senate in 1870, used this language:—

The Doctrine promulgated by President Monroe has been adhered to by all political parties, and I now deem it proper to assert the equally important principle that hereafter no territory on this continent shall be regarded as subject of transfer to a European power.

Never having been formulated as law or in exact language, the Monroe Doctrine has meant different things to different persons at different times. It has become deeply rooted in the American heart, and a permanent part of the foreign policy of the United States. It tends to change into the principle that every portion of the American continent must be free from European control. It is still coupled, however, with the converse principle that America takes no part in European politics, as the disclaimer of the American delegates to the first Peace Conference at the Hague proved.

See Tucker's *Monroe Doctrine*; Gilman's *Life of Monroe*; Wharton's *International Law Digest* (title, "Monroe Doctrine"); Snow's

American Diplomacy; also an article by Sir Frederick Pollock in the *Nineteenth Century and After* (1902). (T. S. W.)

MONROSE (1783-1843), French actor, whose real name was Claude Louis Séraphin Barizain, was born in Besançon on the 6th of December 1783, and was already playing children's parts at the time of the Revolution. He was called to the Comédie Française in 1815, and was received *sociétaire* in 1817. A small, active man, with mobile and expressive features and quick, nervous gestures, he was noted as the racially servant in such plays as *Le Barbier de Séville* and *Les Fourberies de Scapin*. His son, LOUIS MARTIAL BARIZAIN (1809-1883), also called Monroe, was also an actor. He succeeded Samson as professor at the Conservatoire in 1866.

MONS (Flemish *Bergen*), a town of Belgium situated on a small river called the Trouille in the province of Hainaut of which it is the capital. Pop. (1904), 27,072. Mons was the capital of the ancient countdom of Hainaut, well known in English history from the marriage of Edward III. with his Countess Philippa. The town was founded by the Countess Waudru in the 8th century, whereupon Charlemagne recognized it as the capital of Hainaut, and it has retained the position ever since. It was only in the 11th century, however, that it became the fixed residence of the counts, who had previously occupied the castle of Hornu, leaving Mons to the abbey and the church of St Waudru. Regnier V. moved to Mons at the beginning of that century, and his only child—a daughter—Richilde, married Baldwin VI. of Flanders. The junction of the two countdoms was only temporary, and they again separated in the person of Richilde's sons. In this age Hainaut was known as "the poor land of a proud people," and it was not until the beginning of the 14th century that Mons was converted into a trading town by the establishment of a cloth market. At the same time the count transferred his principal fortress from Valenciennes to Mons. When the Hainaut title became merged in the duchy of Burgundy, Mons was a place of considerable importance on account of its being a stronghold near the French frontier. Its capture, defence and surrender by Louis of Nassau in 1572 was one of the striking incidents of the religious troubles. In the long wars of the 17th and 18th centuries Mons underwent several sieges, but none of the same striking character as those of Namur. Several times dismantled and refortified, Mons was finally converted into an open town in 1862.

The most remarkable building in the city is the cathedral of St Waudru, named after the first countess, which was begun in the middle of the 15th century, but not finished for more than a century and a half later. It is a fine specimen of later Gothic, and contains some good glass as well as a few pictures by Van Thudden. The Hôtel de Ville is about the same age as the cathedral, having been commenced in 1458 and finished in 1666. The tower was added a century later. There is also a fine belfry with a peal of bells. Mons is now a flourishing town with a good trade in cloth, lace, sugar refinery, &c.; but its chief importance is derived from its proximity to the Borinage (place of boring), district containing mines of the finest coal in Belgium. The military engineering college for the Belgian army is here, and not far from Mons are the battle-fields of Malpaquet (1700) and Jemappes (1792).

MONSIEUR (Fr., formed from *mon*, my, and *sieur*, lord), the general title of address in France used vocatively in speaking formally to any male person, like the English "sir" or prefixed to the name like the English "Mr." It is, however, in France also prefixed to nobiliary, official, and other titles, e.g. *Monsieur le président*, *Monsieur le duc d'É.*, &c. It is abbreviated *M.*, not *Mons*. As a specific title "Monsieur" (*tout court*) was used from the time of Louis XIV. of the eldest brother of the king, as "Monseigneur" was of the dauphin; as a general title of address it was given to the princely members of a royal house.

MONSIGNOR (It. *monsignore*, my lord), a title of honour granted by the pope to bishops and to high dignitaries and officials of the papal household. It is abbreviated *Mgr*.

MONSON, SIR WILLIAM (c. 1569-1643), British admiral, was the third son of Sir John Monson of South Carlton in Lincolnshire, where the family was of old standing. He matriculated at Balliol College, Oxford, in 1581, but ran away to sea in 1585, being then according to his own account sixteen. His first services were in a privateer in an action with a Spanish ship in the Bay of Biscay, of which he gives a somewhat Munchausen-like account in his *Naval Tracts*. In the Armada year he served as lieutenant of the "Charles," a small ship of the queen's. There being at that time no regular naval service, Monson is next found serving with the adventurous George Clifford, 3rd earl of Cumberland (1558-1603), whom he followed in his voyages of 1589, 1591 and 1593. During the second of these ventures Monson had the ill-luck to be taken prisoner by the Spaniards in a recaptured prize, and was for a time detained at Lisbon in captivity. His cruises must have brought him some profit, for in 1595 he was able to marry, and he thought it worth while to take his M.A. degree. The earl offended him by showing favour to another follower, and Monson turned elsewhere. In the expedition to Cadiz in 1596, he commanded the "Repulse" (50). From this time till the conclusion of the war with Spain he was in constant employment. In 1602 he commanded the last squadron fitted out in the reign of Queen Elizabeth. In 1604 he was appointed admiral of the Narrow Seas, the equivalent of the Channel squadron of modern times. In 1614 he was sent to the coasts of Scotland and Ireland to repress the pirates who then swarmed on the coast. Monson claimed to have extirpated these pests, but it is certain that they were numerous a generation later. After 1614 he saw no further active service till 1635, when he went to sea as vice-admiral of the fleet fitted out by king Charles I. with the first ship-money. He spent the last years of his life in writing his *Tracts*, and died in February 1643.

His claim to be remembered is not based on his services as a naval officer, though they were undoubtedly honourable, but on his *Tracts*. These treatises consist in part of historical narratives, and in part of argumentative proposals for the reform of abuses, or the development of the naval resources of the country. They form by far the best account by a contemporary of the naval life and transactions of the reign of Queen Elizabeth and the beginning of the reign of King James. Monson takes care to do himself full justice, but he is not unfair to his contemporaries. His style is thoroughly modern, and has hardly a trace of the poetry of the Elizabethans. He was the first naval officer in the modern sense of the word, a gentleman by birth and education who was trained to the sea, and not simply a soldier put in to fight, with a sailing-master to handle the ship for him, or a tarpaulin who was a sailor only.

Monson's elder brother, Sir Thomas Monson (1564-1641), was one of James I.'s favourites, and was made a baronet in 1611. He held a position of trust at the Tower of London, a circumstance which led to his arrest as one of the participators in the murder of Sir Thomas Overbury. He was, however, soon released and he died in May 1641. His eldest son was Sir John Monson, Bart. (1600-1683), a member of parliament under Charles I., and another son was Sir William Monson (c. 1607-1678), who was created an Irish peer as Viscount Monson of Castlemaine in 1628. Having been a member of the court which tried Charles I. the viscount was deprived of his honours and was sentenced to imprisonment for life in 1661. Sir John Monson's descendant, another Sir John Monson, Bart. (1693-1748), was created Baron Monson in 1728. His youngest son was George Monson (1730-1776), who served with the English troops in India from 1758 to 1763. The baron's eldest son was John, the 2nd Baron (1727-1774), whose son William Monson (1760-1807) served in the Mahratta War under General Lake. William's only son William John (1796-1862) became 6th Baron Monson in succession to his cousin Frederick John, the 5th baron, in October 1841. His son William John, the 7th baron (1829-1898), was created Viscount Oxenbridge in 1886. When he died without sons in 1898 the viscounty became extinct, but the barony descended to his brother Debonnaire John

(1830-1900), whose son Augustus Debonnaire John (b. 1868) became 9th Baron Monson in 1900. Another of Viscount Oxenbridge's brothers was Sir Edmund John Monson, Bart. (b. 1834), who, after filling many other diplomatic appointments, was British ambassador in Paris from 1896 to 1904.

The one authority for the life of Sir William Monson is his own *Tracts*, but a very good account of him is included by Southey in his *Lives of the Admirals*, vol. v. The *Tracts* were first printed in the third volume of Churchill's *Voyages*, but they have been edited for the Navy Record Society by Mr Oppenheim.

MONSOON (Arabic *Mausim*, season), the name given to seasonal winds due to differences of pressure between areas of land and sea, which are primarily caused by seasonal differences of temperature. Monsoons may be regarded as the seasonal analogue of the diurnal land and sea breezes. The term is, however, also applied to seasonal winds which change in direction on account of the migrations of wind-belts in the planetary circulation. During the season of rising temperature the surface of the land warms more quickly, and becomes hotter than that of the sea, and during the season of falling temperature the reverse is the case. Barometric pressure tends to be higher over the colder region than over the warmer, and there is accordingly a tendency for air to flow, in the lower levels of the atmosphere, from the former towards the latter. Thus there is in general a movement from land to sea during the cold season, and from sea to land during the warm season.

Within a belt extending from 10 to 15 degrees on each side of the equator, seasonal changes of temperature are insufficient in range to permit of the occurrence of temperature differences adequate to the development of true monsoons. In the higher latitudes of the west wind-belt, and in the polar zones, the generally low temperature does not favour the occurrence of wide differences between land and sea. Thus the conditions required for the occurrence of monsoonal winds are best satisfied in intermediate latitudes in the neighbourhood of the tropics. But, as in the case of land and sea breezes, the strength and extension of the monsoon produced by the action described depends to a large extent on the configuration of the land surface. When the land area consists of a low plain, or of a plateau having a steep coastal strip of small width, the circulation upon it tends to be local, and to approximate to the typical "continental" climate of the temperate zones. Where, on the other hand, the land slopes upwards gradually to a central *massif* or ridge the effect of the differences of temperature is, as it were, cumulative, and the monsoons may extend over large areas, affecting regions distant from those in which the causes producing them are directly operative, and the monsoon winds may develop great strength. Ferrel (*Popular Treatise on the Winds*) has compared the conditions in the two cases to those of a stove with a long horizontal flue and with a vertical or inclined flue of the same length.

It is of course to be noted that the hot season monsoon is in general of greater strength than that of the cold season, because being usually a sea wind the air is fully charged with moisture, condensation takes place as ascensional movement sets in on reaching the land, and the latent heat set free strengthens the upward current.

The position, outline and relief of the continent of Asia favour the development of monsoons to a much greater extent than any other part of the world; so much so that the climate of the whole of the southern and eastern parts is entirely controlled by these winds, forming what is typically known as "the monsoon region," a region having distinctly characteristic products. Monsoons form an important element in the climate of Australia, western and southern Africa, and the southern part of the United States of America, but with a few exceptions the monsoons of those regions are local in character, modifying the prevailing winds of the planetary circulation (usually the trade winds) for a longer or shorter period every year.

MONSTER (Lat. *monstrum*, from root of *monere*, to warn; i.e. something terrible or portentous). In zoology, monsters or monstrous births are the subject of Animal Teratology, a

department of morphological science treating of deviations from the normal development of the embryo. The term "embryo" is conventionally limited, in human anatomy, to the ovum in the first three months of its intra-uterine existence, while it is still developing or acquiring the rudiments of its form, the term "foetus" being applied to it in the subsequent months during which the organism grows on the lines of development already laid down. It is mostly in the first or embryonic period that those deviations from the normal occur which present themselves as monstrosities at the time of birth; these early traces of deviation within the embryo may be slight, but they "grow with its growth and strengthen with its strength," until they amount to irreparable defects or accretions, often incompatible with extra-uterine life. The name of "teratology," introduced by Étienne Geoffroy St Hilaire (1822), is derived from *répas*, the equivalent of *monstrum*; teratology is a term new enough to have none but scientific associations, while the Latin word has a long record of superstitions identified with it. The myths of siren, satyr, Janus, cyclops and the like, with the corresponding figures in Northern mythology, find a remote anatomical basis in monstrosities which have, for the most part, no life except in the foetal state. The mythology of giants and dwarfs is, of course, better founded. The term monster was originally used in the same sense as portent. Luther¹ speaks of the birth of a monstrous calf, evidently the subject of contemporary talk, as pointing to some great impending change, and he expresses the hope that the catastrophe might be the Last Day itself. The rise of more scientific views will be sketched in the course of the article.

Although monstrosities, both in the human species and in other animals, tend to repeat certain definite types of erroneous development, they do not fall readily into classes. The most usual grouping (originally suggested by G. L. L. Buffon, 1800) is into *monstra per excessum*, *monstra per defectum*, and *monstra per fabricam alienam*. It seems useful, however, to place the more simple cases of excess and of defect side by side; and it is necessary, above all, to separate the double monsters from the single, the theory of the former being a distinct chapter in teratology.

1. Monstrosities in a Single Body.—The abnormality may extend to the body throughout, as in well-proportioned giants and dwarfs; or it may affect a certain region or member, as—to take the simplest case—when there is a finger or toe too many or too few. It is very common for one malformation to be correlated with several others, as in the extreme case of acardiac monsters, in which the non-development of the heart is associated with the non-development of the head, and with other radical defects.

Giants are conventionally limited to persons over 7 ft. in height. The normal proportions of the frame are adhered to more or less closely, except in the skull, which is relatively small; but accurate measurements, even in the best-proportioned cases, prove, when reduced to a scale, that other parts besides the skull—notably the thigh-bone and the foot—may be undersized though overgrown. In persons who are merely very tall the great stature depends often on the inordinate length of the lower limbs; but in persons over 7 ft. the lower limbs are not markedly disproportionate. In many cases the muscles and viscera are not sufficient for the overgrown frame, and the individuals are usually, but not always, of feeble intelligence and languid disposition, and short-lived. The brain-case especially is undersized—the Irish giant in the museum of Trinity College, Dublin, is the single exception to this rule—but the bones of the face, and especially the lower jaw, are on a large scale. Giants are never born of gigantic parents; in fact, sterility usually goes with this monstrosity. Their size is sometimes excessive at birth, but more often the indications of great stature do not appear till later, it may be as late as the ninth year; they attain their full height before the twenty-first year. They have been more frequently male than female.

¹ In a passage quoted by T. L. W. Bischoff from the 19th volume of Luther's works, Halle ed., p. 2416.

Dwarfs are conventionally limited to persons under 4 ft. They are more likely than giants to have the modulus of the body perfect. Where disproportion occurs in the true dwarf it takes the form of a large-sized head, broad shoulders and capacious chest, and undersized lower limbs. Dwarfs with rickets are perhaps to be distinguished from true dwarfs; these are cases in which the spine is curved, and sometimes the bones of the limbs bent and the pelvis deformed. As in the case of giants, dwarfs are seldom the progeny of dwarfs, who are, in fact, usually sterile; the unnatural smallness may be obvious at birth, but is more likely to make itself manifest in the years of growth. Dwarfs are much more easily brought up than giants, and are stronger and longer-lived; they have usually also strong passions and acute intelligence. The legends of the dwarfs and giants are on the whole well based on fact. (See DWARF and GIANT.)

Redundancy and Defect in Single Parts.—The simplest case of this redundancy is a sixth digit, well formed, and provided with muscles (or tendons), nerves, and bloodvessels like the others; it is usually a repetition of the little finger or toe, and it may be present on one or both hands, or on one or both feet, or in all four extremities, as in the giant of Gath. The want of one, two, or more digits on hand or foot, or on both, is another simple anomaly; and, like the redundancy, it is apt to repeat itself in the same family. J. F. Meckel saw a girl who had an extra digit on each extremity, while a sister wanted four of the fingers of one hand. Where the supernumerary digits are more than one on each extremity, the whole set are apt to be rudimentary or stunted; they look as if two or more of the embryonic buds had been subject to cleavage down the middle and to arrest of longitudinal growth. There are several authentic instances of a whole lower limb appearing at birth as two withered halves, as if from embryonic cleavage. Other redundancies of the skeleton are extra vertebrae (sometimes the coccygeal, giving the appearance of a rudimentary tail), or an extra rib. A double row of teeth is occasionally met with; the most interesting case of this anomaly is that in which the rudiments of a double row exist from the first, but the phenomenon is sometimes produced by the milk teeth persisting along with the second set. Among redundancies of the soft parts, by far the most frequent relate to the mammary glands and especially to the nipples. These organs are normally paired amongst mammals, and the glands of each pair are placed symmetrically on a curved line running from the axilla towards the pubes. When many pairs occur, the glands of each pair diverge less from the median line than those of the immediately anterior pair, the abdominal glands lying close together, those towards the axilla being farther apart. When only a single pair is normally present, the pair is axillary, pectoral or axillary; and whether the normal be one pair or many pairs, additional glands are not infrequent, but occupy the expected position on the mammary lines. Accessory glands or nipples in human beings, if anterior to the normal pair, lie farther from the median ventral line, and vice versa. Among the sense-organs there is a remarkable instance recorded of doubling of the appendages of the left eye, but not of the eyeball itself; the left half of the frontal bone is double, making two eye-sockets on that side, and the extra orbit has an eyebrow and eyelid. The external ear (*pinna*) has also been found double on one side and its orifice has frequently been found doubled in man and lower animals, and the additional ears lie in a definite relation to the branchial clefts of the embryo. Doubling of any of the internal organs or parts of organs may occur and innumerable cases have been recorded.

Montrosities from Defective Closure in the Middle Line.—Under this head come some of the commonest congenital malformations, including slight deficiencies such as harelip, and serious defects such as a gap in the crown of the head with absence of the brain. The embryo is originally a circular flattened disk spread out on one pole of the yolk, and it is formed into a cylindrical body (with four appendages) by the free margins of the disk, or rather its ventral laminae, folding inwards to meet in the middle line and so close in the pelvic, abdominal, thoracic,

pharyngeal and oral cavities. Meanwhile, and indeed rather earlier, two longitudinal parallel ridges on the top or along the back of the disk have grown up and united in the middle line to form the second barrel of the body—the neural canal—of small and uniform width in the lower three-fourths or spinal region, but expanding into a wide chamber for the brain. This division into neural (dorsal) and haemal (ventral) canals underlies all vertebrate development. Imperfect closure along either of those embryonic lines of junction may produce various degrees of monstrosity. The simplest and commonest form, hardly to be reckoned in the present category, is harelip with or without cleft palate, which results from defective closure of the ventral laminae at their extreme upper end. Another simple form, but of much more serious import, is a gap left in the neural canal at its lower end; usually the arches of the lumbar vertebrae are deficient, and the fluid that surrounds the spinal cord bulges out in its membranes, producing a soft tumour under the skin at the lower part of the back. This is the condition known as *hydrohachis*, depending on the osseous defect known as *spina bifida*. More rarely the gap in the arches of the vertebrae is in the region of the neck. If it extend all along the back, it will probably involve the skull also. Deficiency of the crown of the head, and in the spine as well, may be not always traceable to want of formative power to close the canal in the middle line; an over-distended condition of the central canal of the cord and brain may prevent the closure of the bones, and ultimately lead to the disruption of the nervous organs themselves; and injuries to the mother, with inflammation set up in the foetus and its appendages, may be the more remote cause. But it is by defect in the middle line that the mischief manifests itself, and it is in that anatomical category that the malformations are included. The osseous deficiency at the crown of the head is usually accompanied by want of the scalp, as well as of the brain and membranes. The bones of the face may be well developed and the features regular, except that the eyeballs bulge forward under the closed lids; but there is an abrupt horizontal line above the orbits where the bones cease, the skin of the brow joining on to a spongy kind of tissue that occupies the sides and floor of the cranium. This is the commonest form of an *anencephalus* or brainless monster. There are generally mere traces of the brain, although, in some rare and curious instances, the hemispheres are developed in an exposed position on the back of the neck. The cranial nerves are usually perfect, with the exception sometimes of the optic (and retina). Vegetative existence is not impossible, and a brainless monster has been known to survive sixty-five days. The child is usually a very large one.

Closely allied, as we have seen, to the anencephalous condition is the condition of congenital *hydrocephalus*. The nervous system at its beginning is a neural canal, not only as regards its bony covering, but in its interior; a wide space lined by ciliated epithelium and filled with fluid extends along the axis of the spinal cord, and expands into a series of chambers in the brain. As development proceeds the walls thicken at the expense of the internal spaces, the original tubular or chambered plan of the central nervous system is departed from, and those organs assume the practically solid form in which we familiarly know them. If, however, the spaces persist in their embryonic proportions notwithstanding the thickening of the nervous substance forming their walls, there results an enormous brain which is more than half occupied inside with fluid, contained in spaces that correspond on the whole to the ventricles of the brain as normally bounded. A hydrocephalic foetus may survive its birth, and will be more apt to be affected in its nutrition than in its intelligence. In many cases the hydrocephalic condition does not come on till after the child is born.

Returning to the ventral middle line, there may be defects of closure below the lips and palate, as in the breast-bone (fissure of the sternum), at the navel (the last point to close in any case), and along the middle line of the abdomen generally. The commonest point for a gap in the middle line of the belly is at its lower part, an inch or two above the pubes. At that point in

the embryo there issues the allantois, a balloon-like expansion from the ventral cavity, which carries on its outer surface blood-vessels from the embryo to interdigitate with those of the mother on the uterine surface. Having served its temporary purpose of carrying the bloodvessels across a space, the balloon-like allantois collapses, and rolls up into the rounded stem-like umbilical cord through most of its extent; but a portion of the sac within the body of the foetus is retained as the permanent urinary bladder. That economical adaptation of a portion of a vesicular organ, originally formed for purposes of communication between the embryo and the mother, appears to entail sometimes a defect in the wall of the abdomen just above the pubes, and a defect in the anterior wall of the bladder itself. This is the distressing congenital condition of fissure of the urinary bladder, in which its interior is exposed through an opening in the skin; the pubic bones are separated by an interval, and the reproductive organs are ill-formed; the urachus is wanting, and the umbilicus is always placed exactly at the upper end of the gap in the skin. A monstrosity recalling the cloacal arrangement of the bird is met with as a more extreme defect in the same parts.

Hermaphroditism.—Although this anomalous condition does not fall under defective closure in the middle line, it may be said to be due to a similar failure of purpose, or to an uncertainty in the *nisus formativus* at a corresponding stage of development. Strictly speaking, a hermaphrodite is a creature containing ovaries and testes—the essential organs of each sex. Evidence accumulates, however, that at least in all the higher vertebrates, including man, the sex is predetermined in the fertilized ovum, and it is more than doubtful if true hermaphroditism occurs. On the other hand, if there be no such double sex in the essential organs (as in the majority of so-called hermaphrodites) there is a great deal of doubling and ambiguity entailed in the secondary or external organs and parts of generation. Those parts which are rudimentary or obsolete in the male but highly developed in the female, and those parts which are rudimentary in the female but highly developed in the male tend in the hermaphrodite to be developed equally, and all of them badly. Amongst human beings the greater number of so-called hermaphrodites are really females, in which there is an abnormal development of the clitoris, but it also happens that true males may be born with a small clitoris-like penis, with hypospadias—that is to say, with imperfect urethra, open on the ventral side, and with undescended testes. Failure of the development of the testes or ovary, or their removal in the adult condition induces an ambiguous condition of the body in which the secondary sexual characters approach those of the other sex. Experimental removal of the ovaries or testes, followed by implantation of organs of the other sex, has produced an inversion of the secondary sexual characters.

Cyclops, Siren, &c.—The same feebleness of the formative energy which gives rise to some at least of the cases of defective closure in the middle line, and to the cases of ambiguous sex, leads also to imperfect separation of symmetrical parts. The most remarkable case of the kind is the cyclops monster. At a point corresponding to the root of the nose there is found a single orbital cavity, sometimes of small size and with no eyeball in it, at other times of the usual size of the orbit and containing an eyeball more or less complete. In still other cases, which indicate the nature of the anomaly, the orbital cavity extends for some distance on each side of the middle line, and contains two eyeballs lying close together. The usual nose is wanting but above the single orbital cavity there is often a nasal process on the forehead, with which nasal bones may be articulated, and cartilages joined to the latter; these form the framework of a short fleshy protuberance like a small proboscis. The lower jaw is sometimes wanting in cyclopeans; the cheek-bones are apt to be small, and the mouth a small round hole, or altogether absent; the rest of the body may be well developed. The key to the cyclopean condition is found in the state of the brain. The olfactory nerves or lobes are frequently absent; the brain is very imperfectly divided into hemispheres, and appears as a

somewhat pear-shaped sac with thick walls, the longitudinal partition of dura mater (falx cerebri) being wanting, the surface almost unconvoluted, the corpus callosum deficient, the basal ganglia rudimentary or fused. The optic chiasma and nerves are usually replaced by a single mesial nerve, but sometimes the chiasma and pair of nerves are present. The origin of this monstrosity dates back to an early period of development, to the time when the future hemispheres were being formed as protrusions from the anterior cerebral vesicle or fore-brain; it may be conceived that, instead of two distinct buds from that vesicle, there was only a single outgrowth with imperfect traces of cleavage. That initial defect would carry with it naturally the undivided state of the cerebrum, and with the latter there would be the absence of olfactory lobes and of a nose, and a single eyeball placed where the nose should have been. A cyclops has been known to live for several days. The monstrosity is not uncommon among the domestic animals, and is especially frequent in the pig.

Another curious result of defective separation of symmetrical parts is the siren form of foetus, in which the lower limbs occur as a single tapering prolongation of the trunk like the hinder part of a dolphin, at the end of which a foot (or both feet) may or may not be visible. The defects in the bones underlying this siren form are very various: in some cases there is only one limb (thigh and leg-bones) in the middle line; in others all the bones of each limb are present in more or less rudimentary condition, but adhering at prominent points of the adjacent surfaces. The pelvis and pelvic viscera share in the abnormality. A much more common and harmless case of unseparated symmetrical parts is where the hand or foot has two, three, or more digits fused together. This syndactylous anomaly runs in families.

Limbs Absent or Stunted.—Allied to these fused or unseparated states of the extremities, or of parts of them, are the class of deformities in which whole limbs are absent, or represented only by stumps. The trunk (and head) may be well formed, and the individual healthy; all four extremities may be reduced to short stumps either wanting hands and feet entirely, or with the latter fairly well developed; or the legs only may be rudimentary or wanting, or the arms only, or one extremity only. Although some of these cases doubtless depend upon aberrant or deficient formative power in the particular directions, there are others of them referable to the effects of mechanical pressure, and even to direct amputation of parts within the uterus.

Acardiac and Acranial Monsters.—It sometimes happens in a twin pregnancy that one of the embryos fails to develop a heart and a complete vascular system of its own, depending for its nourishment upon blood derived from the placenta of its well-formed twin by means of its umbilical vessels. It grows into a more or less shapeless mass, in which all traces of the human form may be lost. Other viscera besides the heart will be wanting, and no head distinguishable; the most likely parts to keep the line of development are the lumbar region (with the kidneys), the pelvis, and the lower limbs. The twin of this monster may be a healthy infant.

Reversed Position of the Viscera.—This is a developmental error associated with the retention of the right aortic arch as in birds, instead of the left as is usual in mammals. The position of all the unsymmetrical viscera is transposed, the spleen and cardiac end of the stomach going to the right side, the liver to the left, the caecum resting on the left iliac fossa, and the sigmoid flexure of the colon being attached to the right. This condition of *situs inversus viscerum* need cause no inconvenience; and it will probably remain undetected until the occasion should arise for a physical diagnosis or post-mortem inspection.

The causes of congenital anomalies are difficult to specify. There is no doubt that, in some cases, they are present in the sperm or germ of the parent; the same anomalies recur in several children of a family, and it has been found possible, through a variation of the circumstances, to trace the influence in some cases to the father alone, and in other cases to the mother alone. The remarkable thing in this

parental influence is that the malformation in the child may not have been manifested in the body of either parent, or in the grandparents. More often the malformation is acquired by the embryo and foetus in the course of development and growth, either through the mother or in itself independently. Maternal impressions during pregnancy have often been alleged as a cause, and this causation has been discussed at great length by the best authorities. The general opinion seems to be that it is impossible to set aside the influence of subjective states of the mother altogether, but that there is no direct connexion between the cause of the subjective state and the resulting anomaly. The doctrine of maternal impressions has often been resorted to when any other explanation was either difficult or inconvenient; thus, Hippocrates is said to have saved the virtue of a woman who gave birth to a black child by pointing out that there was a picture of a negro on the wall of her chamber. Injuries to the mother during pregnancy have been unquestionably the cause of certain malformations, especially of congenital hydrocephalus. The embryo itself and its membranes may become the subject of inflammations, atrophies, hypertrophies, and the like; this causation is doubtless accountable for a good many of them. But a very large residue of malformations must still be referred to variation in the embryonic cells and cell-groups. The *situs formativus* of the fertilized ovum is always subject to morphological laws, but, just as in extra-uterine life, there may be deviations from the beaten track; and even a slight deviation at an early stage will carry with it far-reaching consequences. This is particularly noticeable in double monsters.

2. *Double Monsters.*—Twins are the physiological analogy of double monsters, and some of the latter have come very near to being two separate individuals. The Siamese twins, who died in 1874 at the age of sixty, were joined only by a thick fleshy ligament from the lower end of the breast-bone (xiphoid cartilage), having the common navel on its lower border; the anatomical examination showed, however, that a process of peritoneum extended through the ligament from one abdominal cavity to the other, and that the blood-vessels of the two livers were in free communication across the same bridge. There are one or two cases on record in which such a ligament has been cut at birth, one, at least, of the twins surviving. From the most intelligible form of double monstrosity, like the Siamese twins, there are all grades of fantastic fusion of two individuals into one down to the truly marvellous condition of a small body or fragment parasitic upon a well-grown infant—the condition known as *foetus in foetu*. These monstrosities are deviations, not from the usual kind of twin gestation, but from a certain rarer physiological type of dual development. In by far the majority of cases twins have separate uterine appendages, and have probably been developed from distinct ova; but in a small proportion of (recorded) cases there is evidence, in the placental and enclosing structures, that the twins had been developed from two rudiments arising side by side on a single blastoderm. It is to the latter physiological category that double monsters almost certainly belong; and there is some direct embryological evidence for this opinion. Allen Thomson observed in the blastoderm of a hen's egg at the sixteenth or eighteenth hour of incubation two "primitive traces" or rudiments of the backbone forming side by side; and in a goose's egg incubated five days he found on one blastoderm two embryos, each with the rudiments of upper and lower extremities, crossing or cohering in the region of the future neck, and with only one heart between them. A very large number of similar observations have been published and appear to be found in all cases where a large material is available. The developing ova of fish, available in large numbers in hatcheries, and the laboratory investigation of the chick and the frog have provided cases of almost every degree of blending. The perfect physiological type appears to be two rudiments on one blastoderm, whose entirely separate development produces twins (under their rarer circumstances), whose nearly separate development produces such double monsters as the Siamese twins, and whose less separate development produces the various grotesque forms

of two individuals in one body. There can be no question of a literal fusion of two embryos; either the individuality of each was at no time complete, or, if there were two distinct primitive traces, the uni-axial type was approximately reverted to in the process of development, as in the formation of the abdominal and thoracic viscera, limbs, pelvis or head. Double monsters are divided in the first instance into those in which the doubling is symmetrical and equal on the two sides, and those in which a small or fragmentary foetus is attached to or enclosed in a foetus of average development—the latter class being the so-called cases of "parasitism."

Symmetrical Double Monsters are subdivided according to the part or region of the body where the union or fusion exists—head, thorax, umbilicus or pelvis. One of the simplest cases is a Janus head upon a single body, or there may be two pairs of arms with the two faces. Again, there may be one head with two necks and two complete trunks and pairs of extremities. Two distinct heads (with more or less of neck) may surmount a single trunk, broad at the shoulders but with only one pair of arms. The fusion, again, may be from the middle of the thorax downwards, giving two heads and two pairs of shoulders and arms, but only one trunk and one pair of legs. In another variety, the body may be double down to the waist, but the pelvis and lower limbs single. The degree of union in the region of the head, abdomen or pelvis may be so slight as to permit of two distinct organs or sets of organs in the respective cavities, or so great as to have the viscera in common; and there is hardly ever an intermediate condition between those extremes. Thus, in the Janus head there may be two brains, or only one brain. The Siamese twins are an instance of union at the umbilical region, with the viscera distinct in every respect except a slight vascular anastomosis and a common process of peritoneum; but it is more usual for union in that region to be more extensive, and to entail a single set of abdominal and thoracic viscera. The pelvis is one of the commonest regions for double monsters to be joined at, and, as in the head and abdomen, the junction may be slight or total. The Hungarian sisters Helena and Judith (1701-1723) were joined at the sacrum, but had the pelvic cavity and pelvic organs separate; the same condition obtained in the South Carolina negroes Millie and Christina, known as the "two-headed nightingale," and in the Bohemian sisters Rosalie and Josepha. More usually the union in the pelvic region is complete, and produces the most fantastic shapes of two trunks (each with head and arms) joining below at various angles, and with three or four lower limbs extending from the region of fusion, sometimes in a lateral direction, sometimes downwards. A very curious kind of double monster is produced by two otherwise distinct foetuses joining at the crown of the head and keeping the axis of their bodies in a line. It is only in rare instances that double monsters survive their birth, and the preserved specimens of them are mostly of foetal size.

Unequal Double Monsters, Foetus in Foetus.—There are some well-authenticated instances of this most curious of all anomalies. The most celebrated of these parasite-bearing monsters was a Genoese, Lazarus Johann Baptist Colloredo, born in 1716, who was figured as a child by Lictus, and again by Bartholinus at the age of twenty-eight as a young man of average stature. The parasite adhered to the lower end of his breast-bone, and was a tolerably well-formed child, wanting only one leg; it breathed, slept at intervals, and moved its body, but it had no separate nutritive functions. The parasite is more apt to be a miniature acardiac and acephalous fragment, as in the case of the one borne in front of the abdomen of a Chinaman figured by I. Geoffroy St Hilaire. Sometimes the parasite is contained in a pouch under the skin of the abdominal wall, and in another class (of which there is a specimen in the Hunterian Museum) it has actually been included, by the closure of the ventral laminae, within the abdominal cavity of the foetus—a true *foetus in foetus*. Shapeless parasitic fragments containing masses of bone, cartilage and other tissue are found also in the space behind the breast-bone (mediastinal teratoma), or growing from

the base of the skull and protruding through the mouth ("epignathous teratoma," appearing to be seated on the jaw), and, most frequently of all, attached to the sacrum. These last pass by a most interesting transition into common forms of congenital sacral tumours (which may be of enormous size), consisting mainly of one kind of tissue having its physiological type in the curious gland-like body (coccygeal gland) in which the middle sacral artery comes to an end. The congenital sacral tumours have a tendency to become cystic, and they are probably related to the more perfect congenital cysts of the neck region, where there is another minute gland-like body of the same nature as the coccygeal at the point of bifurcation of the common carotid artery. Other tumours of the body, especially certain of the sarcomatous class, may be regarded from the point of view of *monstra per excessum*; but such cases suggest not so much a question of aberrant development within the blastoderm as of the indwelling spontaneity of a single post-embryonic tissue. (See TUMOUR AND PATHOLOGY.)

Monstrosities in man and animals have attracted attention since the earliest times, and amongst primitive and uncivilized peoples have been regarded as of supernatural origin. Aristotle himself appears to have been the first to examine them as a naturalist, and to explain that although they were outside the usual course of nature they were in the strictest sense of natural origin. Pliny described many well-known forms, but did not distinguish between legendary and actual monstrosities. In the middle ages they were treated in the fullest spirit of superstition, and many relics from such a point of view still survive. The human monstrosities were regarded as having been engendered in women by the devil who had commerce with them either in his own form or in the guise of some animal. The belief still to be found amongst uneducated persons that unnatural union between women and male animals, or between men and female animals, may be fertile and produce monsters, is an attenuated form of the satanic legend. The scientific appreciation of monsters has grown with the study of embryology. William Harvey in *Exercitationes de generatione animalium* (1651) first referred monstrosities to their proper place as abnormalities in embryonic reproduction. The doctrine of pre-formation (see HEREDITY) obsessed biological science until 1750 when C. F. Wolff overthrew it, and Harvey's advance was not pursued, except that a number of anatomists published careful studies and descriptions of monsters or monstrous organs. Those who believed that the normal process of development was an unrolling and expansion of a pre-formed miniature of the adult had to apply a similar theory to monsters, and Sylvain Regis, a contemporary of Malbranche, obtained acceptance of his view that monstrous germs as well as normal germs had been created at the beginning of the world. A discussion almost as memorable as that between E. G. St Hilaire and Cuvier on specific types was pursued in the French Academy from 1724 to 1743, J. B. Winslow, who supported the current pre-formationist view, having the better of the argument with Louis Lémery, who was almost alone in a rational interpretation of monstrosities. From the time of Wolff it was accepted that normal and abnormal embryos alike developed by processes of epigenetic change. Wolff himself, however, and even J. F. Meckel at the beginning of the 19th century, did not recognize the influence of physiological causes in the production of abnormalities; they believed the latter to proceed certainly in an orderly and natural way, but from abnormal ova. E. G. St Hilaire was the first to attempt experimental teratology and to lay down that many monstrosities were the result of influences causing deviations from the normal course of embryonic development. I. G. St Hilaire, the son of E. G. St Hilaire, carried the experimental method little further, but published an elaborate descriptive treatise on anomalies (Paris, 1832-1837) which remains one of the most valuable records of the subject. A similar treatise with an incomparable atlas of illustrations was issued by W. Vrolik, the great Dutch anatomist, between 1840 and 1849, whilst A. Förster issued in 1861 a valuable textbook with a very large number of illustrations chiefly from preparations in the museum at

Würzburg. The great museums devoted much attention to the collection and display of malformations, and no account of the subject can be adequate which does not include reference to the magnificent series in the Museum of the Royal College of Surgeons of England, with the descriptive catalogues of the animal malformations written by B. T. Lowne (1893) and of the vegetable malformations by M. T. Masters (1893).

The work hitherto referred to, as well as a vast bulk of scattered contributions to teratology throughout the 19th century, was chiefly descriptive, anatomical and embryological teratology, and carried the experimental side little beyond where it had been left by the St Hilaïres. In 1891 Camille Dareste published his *Recherches sur la production artificielle des monstruosités, ou essais de tératogénie expérimentale*; his experiments, chiefly on the developing egg of the fowl, not only showed the probable cause of many of the most common abnormalities, but practically created a new branch of science, experimental embryology. Teratology has since become a side issue of the general study of the inter-relations between the inherited tendencies of the developing organism and the play of the circumambient media, and must be studied in relation to the work of O. Hertwig, W. Roux, H. Driesch, O. Bütschli, J. Loeb and their school. J. Bland Sutton's popular *Evolution and Disease* (1890) puts in a cogent way the relation between comparative anatomy and common abnormalities, whilst W. Bateson in his *Materials for the Study of Variation* (1894) describes the acquisition of new symmetries by abnormal organs, and discusses the possible relation between abnormalities and the origin of species.

E. Schwalbe's *Morphologie der Missbildungen* (1906-1909) is a very complete study of the most modern developments of teratology, and contains a careful and elaborate list of authorities from the earliest times. (C. C.; P. C. M.)

MONSTRANCE (through the French from Lat. *monstrare*, to show), a vessel used in the Roman Church for the exhibition of the Host at Benediction (*q.v.*) and also when carried in processions. Another name for the vessel is *ostenorium*, from *ostendere*, to exhibit, show; whence the usual French name *ostensoir*. The monstrance was formerly used of a reliquary, exposing the sacred object to view. The earlier monstrances followed the usual shape of these reliquaries, viz. a cylindrical crystal case mounted in metal frames, elaborately ornamented and jewelled. Such often took the form of a turret. There is a 15th-century Italian example in South Kensington Museum of a plastered turret containing an oblong crystal case, the whole resting on a stemmed base, and surmounted with a cupola. In the 16th century the present shape was adopted, viz. a crystal or glass circular disk, more suited to the shape of the sacred wafer; this is mounted in a frame of golden rays, and the whole is supported by a stem and bases. The exhibition of the Host dates from the institution of the Festival of Corpus Christi (*q.v.*) by Urban IV. in 1264.

MONSTRELET, ENGUERRAND DE (c. 1400-1453), French chronicler, belonged to a noble family of Picardy. In 1436 and later he held the office of lieutenant of the *gavener* (*i.e.* receiver of the *gave*, a kind of church rate) at Cambrai, and he seems to have made this city his usual place of residence. He was for some time bailiff of the cathedral chapter and then provost of Cambrai. He was married and left some children when he died on the 20th of July 1453. Little else is known about Monstrelet except that he was present, not at the capture of Joan of Arc, but at her subsequent interview with Philip the Good, duke of Burgundy. Continuing the work of Froissart, Monstrelet wrote a *Chronique*, which extends to two books and covers the period between 1400 and 1444, when, according to another chronicler, Matthieu d'Escouchy, he ceased to write. But following a custom which was by no means uncommon in the middle ages, a clumsy sequel, extending to 1516, was formed out of various chronicles and tacked on to his work. Monstrelet's own writings, dealing with the latter part of the Hundred Years' War, are valuable because they contain a large number of documents which are certainly, and reported speeches which

are probably, authentic. The author, however, shows little power of narration; his work, although clear, is dull, and is strongly tinged with the pedantry of its century, the most pedantic in French history. His somewhat ostentatious assertions of impartiality do not cloak a marked preference for the Burgundians in their struggle with France.

Among many editions of the *Chronique* may be mentioned the one edited for the *Société de l'histoire de France* by M. Douët d'Arcey (Paris, 1857-1862), which, however, is not very good. See A. Molinier, *Les Sources de l'histoire de France*, tomes iv. and v. (Paris, 1904).

MONTAGNAIS (Fr. "mountaineers"), the collective French name (1) for a group of North American Indian tribes of Quebec province, (2) for four tribes of the northern division of the Athabascan stock of North American Indians in the interior of British North America.

MONTAGU (*Family*). Dru of Montagu or Montagud, the ancestor of the Montagus, earls of Salisbury, came to England with Robert, count of Mortain, half-brother of William the Conqueror. He is found in Domesday among the chief tenants of the count in Somerset, where Dru held the manor of Shepton, afterwards called Shepton Montagu. Upon the hill of Lutegarsburg, in Bishopston, Robert built the castle which he called Montagu—but there is no reason for believing that Dru's surname was derived from the castle, he being probably a Norman born—from Montagu or Montagud-les-bois, both in the neighbourhood of Mortain. The Domesday holding of Dru is represented in the return of 1166 by the ten knights' fee upon which his descendant, another Dru, is assessed. William Montagu of Shepton is among the knights summoned by Henry III. to the Gascon War and to the Welsh border in 1257. His son Simon, the first of the family to make a figure in history, followed Edward I. in 1277 against Llywelyn ap Gruffydd, being then, as it would appear, a minor, and he served again in 1282, when Llywelyn's power was broken for the last time. By a charter dated in 1290 his Somersetshire manors and the manor of Aston Clinton were confirmed to him by a grant from the Crown. In 1296 a ship under his command broke the blockade of Bordeaux. In 1298 he was summoned as a baron; and in 1301, as Simon lord of Montagu, he sealed the famous letter of the barons to the pope with his seal of the arms of Montagu, the counterseal showing a griffon. One of the earliest examples of quartered arms seen in England was afforded when Simon's banner displayed at Falkirk in 1298 quartered this griffon, gold on a blue field, with the Montagu's indented fesse of three furs. He died in 1317 and was succeeded by his son William (d. 1319), a favourite of Edward II., whose household steward he became, and seneschal of Aquitaine and Gascony. His eldest son, another William, came of age in 1322, and in 1330 led the young king's partisans by the secret way into Nottingham Castle, and carried off the earl of March. The day before Mortimer had denounced Montagu as a traitor, but Montagu struck at once and his success was rewarded by grants from the forfeited lands of March. In 1337 he was created earl of Salisbury, and on the death of Thomas of Brotherton in 1338 he was made marshal of England. His king employed him in missions to France, Scotland, Germany and Castile, but war was, as with most of the men of his house, the chief business of his short life. At some time between 1340 and 1342 he led an expedition of his own against the Isle of Man, winning from the Scots the little kingdom to which he had inherited a claim. His grandfather Simon is said to have married a certain Auffray or "Aufrica," sometimes described as "daughter of Fergus and sister of Orray, king of Man," and sometimes as the grand-daughter and heir of John de Courcy, the conqueror of Ulster, whose wife "Affreca" was sister of King Olaf II. John de Courcy, however, died childless, and in 1287 Simon names his wife as Hawise. The second Auffra or Affreca claimed the island as heir of Magnus II. (d. 1265), a letter of Edward I. in 1293 citing John of Scotland to answer her appeal to king John's suzerainty. By her charter of 1306 the same Auffreca, styling herself "Auffreca of Cunnought, heir of the land of Man," granted the island to Simon, and this grant, rather than the marriage universally asserted by Simon's biographers, was probably the origin of the Montagu

claim. The first earl died in 1344 and was buried in the Whitefriars Church in London. His wife, Katherine, daughter of William de Graunson, and co-heir, in her issue, of her brothers, is connected by a legend of no value with the foundation of the Order of the Garter. Between William, his son and heir, the second earl (1328-1397) and Joan of Kent, daughter of Edmund of Woodstock, there was a contract of marriage which was made null by the pope's bull in 1349. William was one of the knights-founders of the Order of the Garter, fought at Crecy, and commanded the rearward battle at Poitiers. According to Froissart he attended the young Richard in Smithfield when the king faced the mob after the death of Wat Tyler. His only son was killed in 1383 at a tournament, and in 1393 the earl sold the lordship and crown of Man to William Scrope of Bolton. He was succeeded by his nephew John, the third earl (c. 1350-1400), son of Sir John Montagu by Margaret, the heir of the barons of Monthermer. The new earl was notorious as a Lollard, and was accused, after Henry IV.'s accession, of a share in Gloucester's death, from which he was to have cleared himself in combat with the Lord Morley. But he joined Kent, Huntingdon and Rutland in their plot against Henry, and was beheaded with the earl of Kent by the Cirencester mob. By his wife Maude, daughter of Sir Adam Francis, he had Thomas (1388-1428), who was summoned as an earl in 1400, his father's dignities being restored to him in 1421, by which time his services at Harfleur and Agincourt had earned him French lordships, the lieutenant-generalship of Normandy and the earldom of Perche. The last of a race of warriors, he ended his service at the famous siege of Orleans, a cannon-ball dashing into his face the stone and iron-work of the window from which he was gazing at the city. By his second wife, the daughter of Thomas Chaucer the Speaker, he had no issue. By his first wife, Eleanor, daughter of Thomas Holand, earl of Kent, he had an only daughter Alice, wife of Richard Neville, a younger son of the first earl of Westmorland, who claimed and was allowed the earldom of Salisbury in right of his marriage. The famous "Richard Make-a-King," earl of Warwick and Salisbury, was the grandson of the last of the Montagu earls.

Sir Edward Montagu of Boughton, a chief justice of the king's bench who died in 1557, was ancestor of three lines of peers, the dukes of Montagu, the dukes of Manchester, and the earls of Sandwich. These Montagus of Boughton claimed, by a false pedigree, descent from the third earl of Salisbury. It is possible that there may have been some kinship between the two families, but none, apparently, that could justify the persistent quartering by these later Montagus of the arms of Monthermer.

AUTHORITIES.—Collinson's *Somerset*; G. E. C.'s *Complete Peerage*; *Victoria County History of Somerset* (J. H. Round's introduction to Domesday); Rymer's *Foedera*; Palgrave's *Parliamentary Writs*; *Rolls of Parliament*; Ramsay's *Lancaster and York*; *Gesta Henrici V.* (English Hist. Soc.); *Chronicles of Walsingham*, Knighton, Capgrave Wavrin, Froussart, Monstrelet, &c. Inquests, Post mortem, Close, Patent, Charter and Fine Rolls; Dugdale's *Monasticon* Publications of Somerset Record Society; Charters in British Museum and Public Record Office. (O. BA.)

MONTAGU, ELIZABETH ROBINSON (1720-1800), English leader of society, was born at York on the 2d of October 1720. In 1742 she married Charles Montagu, cousin of Edward Wortley Montagu and son of the earl of Sandwich—a wealthy man, considerably her senior. Thanks to her, his Mayfair house became the social centre of intellectual society in London, and her breakfast parties and evening conversazioni gained for her from her admirers the title of "The Madame du Defand of the English capital." In other quarters the term "blue-stocking" was applied to her guests. From her husband, who died in 1775, she inherited a considerable fortune and large estates, in the management of which she showed much ability. In 1781 she built Sandeford Priory, near Newbury, and Montagu House, now 22 Portman Square, London, the latter from designs by James Stuart. With the colliers in the north she was extremely popular, and every May-day she entertained the London chimney-sweepers. She died on the 25th of August 1800. There is an admirable portrait of her by Reynolds.

See *Elizabeth Montagu, the Queen of the Blue Stockings: Her Correspondence from 1720 to 1761*, edited by E. J. Climenson (2 vols., 1906); and R. Huchon, *Mrs Montagu and her Friends, 1720-1800* (Eng. trans., 1907).

MONTAGU, LADY MARY WORTLEY (1689-1762), English letter-writer, eldest daughter of Evelyn Pierrepont, afterwards duke of Kingston, was baptized at Covent Garden on the 26th of May 1689. Her mother, who died while her daughter was still a child, was a daughter of William Feilding, earl of Denbigh. Her father was proud of her beauty and wit, and when she was eight years old she is said to have been the toast of the Kit-Kat Club. He took small pains with the education of his children, but Lady Mary was encouraged in her self-imposed studies by her uncle, William Feilding, and by Bishop Burnet. She formed a close friendship with Mary Astell, who was a champion of woman's rights, and with Anne Wortley Montagu, granddaughter of the first earl of Sandwich. With this lady she carried on an animated correspondence. The letters on Anne's side, however, were often copied from drafts written by her brother, Edward Wortley Montagu, and after Anne's death in 1709 the correspondence between him and Lady Mary was prosecuted without an intermediary. Lady Mary's father, now marquis of Dorchester, declined, however, to accept Montagu as a son-in-law because he refused to entail his estate on a possible heir. Negotiations were broken off, and when the marquis insisted on another marriage for his daughter the pair eloped (1712). The early years of Lady Mary Wortley Montagu's married life were spent in rigid economy and retirement in the country. Her husband was M.P. for Westminster in 1715, and shortly afterwards was made a commissioner of the treasury. When Lady Mary joined him in London her wit and beauty soon made her a prominent figure at court. Early in 1716 Montagu was appointed ambassador at Constantinople. Lady Mary accompanied him to Vienna, and thence to Adrianople and Constantinople. He was recalled in 1717, but they remained at Constantinople until 1718. The story of this voyage and of her observations of Eastern life is told in a series of lively letters full of graphic description. From Turkey she brought back the practice of inoculation for small-pox. She had her own children inoculated, and encountered a vast amount of prejudice in bringing the matter forward. Before starting for the East she had made the acquaintance of Alexander Pope, and during her absence he addressed to her a series of extravagant letters, which appear to have been chiefly exercises in the art of writing gallant epistles. Very few letters passed after Lady Mary's return, and various reasons have been suggested for the subsequent estrangement and violent quarrel. Mr Moy Thomas suggests that the cause is to be found in the last of the "Letters during the embassy to Constantinople." It is addressed to Pope and purports to be dated from Dover, the 1st of November 1718. It contains a parody on Pope's "Epitaph on the Lovers struck by Lightning." The MS. collection of these letters was passed round a considerable circle, and Pope may well have been offended at the circulation of this piece of satire. Jealousy of her friendship with Lord Hervey has also been alleged, but Lady Louisa Stuart says Pope had made Lady Mary a declaration of love, which she had received with an outburst of laughter. In any case Lady Mary always professed complete innocence of all cause of offence in public. She is alluded to in the *Dunciad* in a passage to which Pope affixed one of his insulting notes. A *Pop upon Pop* was generally supposed to be from her pen, and Pope thought she was part author of *One Epistle to Mr A. Pope* (1730). Pope attacked her again and again, but with especial virulence in a gross couplet in the "Imitation of the First Satire of the Second Book of Horace," as Sappho. She asked a third person to remonstrate, and received the obvious answer that Pope could not have foreseen that she or any one else would apply so base an insult to herself. *Verses addressed to an Imitator of Horace by a Lady* (1733), a scurrilous reply to these attacks, is generally attributed to the joint efforts of Lady Mary and her sworn ally, Lord Hervey. She had a romantic correspondence with a Frenchman named Rémond, who addressed to her a series of excessively gallant letters before

ever seeing her. She invested money for him in South Sea stock at his desire, and as was expressly stated, at his own risk. The value fell to half the price, and he tried to extort the original sum as a debt by a threat of exposing the correspondence to her husband. She seems to have been really alarmed, not at the imputation of gallantry, but lest her husband should discover the extent of her own speculations. This disposes of the second half of Pope's line " Who starves a sister, or forswears a debt " (*Epilogue to the Satires*, i. 113), and the first charge is quite devoid of foundation. She did in fact try to rescue her favourite sister, the countess of Mar, who was mentally deranged, from the custody of her brother-in-law, Lord Grange, who had treated his own wife with notorious cruelty, and the slander originated with him.

In 1730 she went abroad, and although she continued to write to her husband in terms of affection and respect they never met again. At Florence in 1740 she visited Horace Walpole, who cherished a great spite against her, and exaggerated her eccentricities into a revolting slovenliness (see *Letters*, ed. Cunningham, i. 50). She lived at Avignon, at Brescia, and at Lovere, on the Lago d'Isèo. She was disfigured by a painful skin disease, and her sufferings were so acute that she hints at the possibility of madness. She was struck with a terrible "fit of sickness" while visiting the countess Palazzo and her son, and perhaps her mental condition made restraint necessary. As Lady Mary was then in her sixty-third year, the scandalous interpretation put on the matter by Horace Walpole may safely be discarded. Her husband spent his last years in hoarding money, and at his death in 1761 is said to have been a millionaire. His extreme parsimony is satirized in Pope's *Imitations of Horace* (2nd satire of the 2nd book) in the portrait of Avidueus and his wife. Her daughter Mary, countess of Bute, whose husband was now prime minister, begged her to return to England. She came to London, and died in the year of her return, on the 21st of August 1762.

Her son, EDWARD WORTLEY MONTAGU (1713-1776), author and traveller, inherited something of his mother's gift and more than her eccentricity. He twice ran away from Winchester School, and the second time made his way as far as Oporto. He was then sent to travel with a tutor in the West Indies, and afterwards with a keeper to Holland. He made, however, a serious study of Arabic at Leiden (1741), and returned twenty years later to prosecute his studies. His father made him a meagre allowance, and he was heavily encumbered with debt. He was M.P. for Huntingdon in 1747, and was one of the secretaries at the conference of Aix-la-Chapelle. In 1751 he was involved in a disreputable gaming quarrel in Paris, and was imprisoned for eleven days in the Châtelet. He continued to sit in parliament, and wrote *Reflections on the Rise and Fall of the Antient Republics* . . . (1759). His father left him an annuity of £1000, the bulk of the property going to Lady Bute. He set out for extended travel in the East, and George Romney describes him as living in the Turkish manner at Venice. He had great gifts as a linguist, and was an excellent talker. His family thought him mad, and his mother left him a guinea, but her annuity devolved on him at her death. He died at Padua on the 20th of April 1776.

Lady Mary's "Town Eclogues" were published in a pirated edition as *Court Poems* in 1716. Of her famous *Letters* from the East she made a copy shortly after her return to England. She gave the MS. to Benjamin Sowden, a clergyman of Rotterdam, in 1761. After Lady Mary's death this was recovered by the earl of Bute, but meanwhile an unauthenticated edition, supposed to have been prepared by John Cleland, appeared (1763), and an additional volume, probably spurious, was printed in 1767. The rest of the correspondence printed by Lord Wharnccliffe in the edition of her letters is edited from originals in the Wortley collection. This edition (1837) contained "Introductory Anecdotes" by Lady Bute's daughter, Lady Louisa Stuart. A more critical edition of the text, with the "Anecdotes," and a "Memoir" by W. Moy Thomas, appeared in 1861. A selection of the letters arranged to give a continuous account of her life, by Mr A. R. Ropes, was published in 1892; and another by R. Brimley Johnson in "Everyman's Library" in 1906. See also George Paston, *Lady Mary Wortley Montagu and her Times* (1907), which contains some hitherto unpublished letters.

Lady Mary's journal was preserved by her daughter, Lady Bute, till shortly before her death, when she burnt it on the ground that it contained much scandal and satire, founded probably on insufficient evidence, about many distinguished persons. There is a full and amusing account of Edward Wortley Montagu in Nichols's *Anecdotes of Literature*, iv. 625-656.

MONTAGU, RALPH, 1ST DUKE OF (c. 1638-1709), English diplomatist, was the second son of Edward, 2nd Baron Montagu of Boughton (1616-1684), whose peerage was one of several granted in the 17th century to different members of the Montagu family (q.v.). Sir Edward Montagu, chief justice of the king's bench in the time of Henry VIII., was grandfather of the first earl of Manchester (see MANCHESTER, EARLS AND DUKES 02), and of Edward, 1st Baron Montagu of Boughton (1562-1644), who was imprisoned in the Tower by the parliament on account of his loyalty to Charles I. The eldest son of the latter, Edward, who succeeded him as 2nd baron, took the side of the parliament in the Civil War, and was one of the lords who conducted the king from Newark to Holmby House after his surrender by the Scots in January 1647. He had two sons, of whom Ralph was the younger. The eldest son, Edward, was master of the horse to Queen Catherine, wife of Charles II., a post from which he is said to have been dismissed by the king for showing attention to the queen of too ardent a nature. Catherine immediately appointed the younger brother, Ralph, to the vacant situation, and the latter soon acquired a reputation for gallantry at the court of Charles II. He took an active part in the negotiations in which Louis XIV. purchased the neutrality of England in the war between France and Holland. Having quarrelled with Danby and the duchess of Cleveland, who denounced him to the king, Montagu was elected member of parliament for Northampton in 1678, with the intention of bringing about the fall of Danby; but, having produced letters seriously compromising the minister, the dissolution of parliament placed him in such danger of arrest that he attempted to fly to France. Foiled in this design, he continued to intrigue against the government, supporting the movement for excluding the duke of York from the succession and for recognizing Monmouth as heir to the crown. His elder brother having predeceased his father, Ralph became Baron Montagu of Boughton on the death of the latter in 1684. Notwithstanding his former intrigues he gained the favour of James II. on his accession to the throne; but this did not deter him from welcoming William of Orange, who created him Viscount Monthermer and earl of Montagu in 1689. Montagu was no less avaricious than unscrupulous. In 1673 he had married the wealthy widow of the earl of Northumberland, Elizabeth Wriothlesley, daughter of the earl of Southampton, who brought him a large fortune; and after her death in 1690 he married the still more wealthy Elizabeth Cavendish, daughter of the duke of Newcastle, and widow of Christopher Monk, 2nd duke of Albemarle. Montagu's position was further strengthened in 1705 by the marriage of his son and heir to Mary, daughter of the great duke of Marlborough. In the same year he was raised to the dukedom as duke of Montagu and marquess of Monthermer. He died on the 9th of March 1709. His London residence, Montagu House, Bloomsbury, was bought by the government in 1753 to hold the national collection of antiquities, and on its site was built the British Museum.

The duke was succeeded by his son John, 2nd duke of Montagu (1689-1749), who in 1745 raised a cavalry regiment known as Montagu's Carabineers, which, however, was disbanded after Culloden. He was made a K.G. in 1719, and was a fellow of the Royal Society. As neither of his two sons survived him the title became extinct at his death in 1749, but in 1730 his daughter Mary married George Brudenell, 4th earl of Cardigan (1712-1790), who on his father-in-law's death assumed the name and arms of Montagu, and in 1766 was created duke of Montagu. On his death, in 1790, this second dukedom of Montagu also became extinct; his only son, who was created Baron Montagu of Boughton, having predeceased him. His daughter Elizabeth married Henry, 2nd duke of Buccleuch, who thus acquired all the unentailed property of the dukes of Montagu, the entailed portion passing to the earls of Cardigan.

See Abel Boyer, *History of the Reign of Queen Anne*, vol. viii. (11 vols., London, 1703-1713); Sir J. B. Burke, *Genealogical History of Dormant (Sec.) Peerages* (London, 1883).

MONTAGU (OR MOUNTAGUE), **RICHARD** (1577-1641), English divine, was born at Dorney, Buckinghamshire, and educated at Eton and Cambridge. In 1613 he was elected fellow of Eton and became rector of Stanford Rivers, Essex. He was appointed to the deanery of Hereford in 1616, but exchanged it next year for a canonry of Windsor, which he held with the rectory of Petworth, Sussex. He was also chaplain to James I. Like Laud, he disliked the extremes of Calvinism and Romanism, and this attitude constantly involved him in difficulties. About 1619 he came into collision with some Roman Catholics in his parish, and Matthew Kellison (1560?-1642) attacked him in a pamphlet entitled *The Gagg of the Reformed Gospell* (Douai, 1623). Montagu replied with *A Gagg for the New Gospell? No. A New Gagg for an Old Goose* (London, 1624). The publication of the *Immediate Adresse unto God alone* (London, 1624) incensed the Puritans, who appealed to the House of Commons, but Montagu was protected by the king. After the appearance of his famous *Appello Caesarem* (London, 1625), his case frequently came before parliament and conferences of bishops, but his influence at court and with Laud enabled him to hold his ground. He was consecrated bishop of Chichester in 1628, and became bishop of Norwich in 1638. He died on the 13th of April 1641.

MONTAIGNE, MICHEL DE (1533-1592), French essayist, was born, as he himself tells us, between eleven o'clock and noon on the 28th of February 1533. The patronymic of the Montaigne family, who derived their title from the château at which the essayist was born and which had been bought by his grandfather, was Eyquem. It was believed to be of English origin, and the long tenure of Gascony and Guienne by the English certainly provided abundant opportunity for the introduction of English colonists. But the elaborate researches of M. Malvezin (*Michel de Montaigne, son origine et sa famille*, 1875) proved the existence of a family of Eyquems or Ayquems before the marriage of Eleanor of Aquitaine to Henry II. of England, though no connexion between this family, who were sieurs de Lesparre, and the essayist's ancestors can be made out. Montaigne is not far from Bordeaux, with which the Eyquem family had for some time been connected. Pierre Eyquem, Montaigne's father, had been engaged in commerce (a herring-merchant Scaliger calls him, and his grandfather Ramon had certainly followed that trade), had filled many municipal offices in Bordeaux, and had served under Francis I. in Italy as a soldier. He married Antoinette de Louppes (Lopez), descended from a family of Spanish Jews. The essayist was the third son. By the death of his elder brothers, however, he became head of the family. He had also six younger brothers and sisters. His father appears, like many other men of the time, to have made a hobby of education. Montaigne was not only put out to nurse with a peasant woman, but had his sponsors from the same class, and was accustomed to associate with it. He was taught Latin orally by servants (a German tutor, Horstanus, is especially mentioned), who could speak no French, and many curious fancies were tried on him, as, for instance, that of waking him every morning by soft music. But he was by no means allowed to be idle. A plan of teaching him Greek by some kind of mechanical arrangement is not very intelligible, and was quite unsuccessful. These details of his education (which, like most else that is known about him, come from his own mouth) are not only interesting in themselves, but remind the reader how, not far from the same time, Rabelais, the other leading writer of French during the Renaissance, was exercising himself, though not being exercised, in plans of education almost as fantastic. At six years old Montaigne was sent to the collège de Guienne at Bordeaux, then at the height of its reputation. Among its masters were Buchanan, afterwards the teacher of James I., and Muretus, one of the first scholars of the age. At thirteen Montaigne left the collège de Guienne and began to study law; it is not known where, but probably at Toulouse. In 1548 he was at Bordeaux during one

of the frequent riots caused by the gabelle, or salt-tax. Six years afterwards, having attained his majority, he was made a councillor in the Bordeaux parlement. In 1558 he was present at the siege of Thionville, in 1559 and 1561 at Paris, and in 1562 at the siege of Rouen. He was also much about the court, and he admits very frankly that in his youth he led a life of pleasure, if not exactly of excess. In 1565 he married Françoise de la Chassaingne, whose father was, like himself, a member of the Bordeaux parlement. Three years later his father died, and he succeeded to the family possessions. Finally, in 1571, as he tells us in an inscription still extant, he retired to Montaigne to take up his abode there, having given up his magistracy the year before. His health, never strong, had been further weakened by the hard living which was usual at the time. He resolved, accordingly, to retire to a life of study and contemplation, though he indulged in no asceticism except careful diet. He neither had nor professed any enthusiastic affection for his wife, but he lived on excellent terms with her, and bestowed some pains on the education of the only child (a daughter, Léonore) who survived infancy. In his study—a tower of refuge, separate from the house, which he has minutely described—he read, wrote, dictated, meditated, inscribed moral sentences which still remain on the walls and rafters, annotated his books, some of which are still in existence, and in other ways gave himself up to a learned ease.

He was not new to literature. In his father's lifetime, and at his request, he had translated the *Theologia naturalis* of Raymund de Sabunde, a Spanish schoolman (published 1569). On first coming to live at Montaigne he edited the works of his deceased friend Étienne de la Boétie, who had been the comrade of his youth, who died early, and who, with poems of real promise, had composed a declamatory and school-boyish theme on republicanism, entitled the *Contr' un*, which is one of the most over-estimated books in literature. But the years of his studious retirement were spent on a work of infinitely greater importance. Garrulous after a fashion as Montaigne is, he gives us no clear idea of any original or definite impulse leading him to write the famous *Essays*. It is very probable that if they were at first intended to have any special form at all it was that of a table-book or journal, such as was never more commonly kept than in the 16th century. It is certainly very noticeable that the earlier essays, those of the first two books, differ from the later in one most striking point, in that of length. Speaking generally, the essays of the third book average fully four times the length of those of the other two. This of itself would suggest a difference in the system of composition. These first two books appeared in 1580, when their author was forty-seven years old.

They contain, as at present published, no fewer than ninety-three essays, besides an exceedingly long apology for the already mentioned Raymund Sabunde, in which some have seen the kernel of Montaigne's philosophy. The book begins with a short *avis* (address to the reader), opening with the well-known words, "*C'est icy un livre de bon foy, lecteur, et sketching in a few lively sentences the character of mediocrity and egotism which is kept up throughout.*" His sole object, the author says, is to leave for his friends and relations a mental portrait of himself, defects and all; he cares neither for utility nor for fame. The essays then begin, without any attempt to explain or classify their subjects. Their titles are of the most diverse character. Sometimes they are proverbial sayings or moral adages, such as "Par divers moyens on arrive à pareille fin," "Qu'il ne faut juger de notre heur qu'après la mort," "Le profit de l'on est le dommage de l'autre." Sometimes they are headed like the chapters of a treatise on ethics: "De la tristesse," "De l'oisiveté," "De la peur," "De l'amitié." Sometimes a fact of some sort which has awakened a train of associations in the mind of the writer serves as a title, such as "On est puni de s'opiniâtrer à une place sans raison," "De la bataille de Dreux," &c. Occasionally the titles seem to be deliberately fantastic, as "Des puces," "De l'usage de se vestir." Sometimes, though not very often, the sections are in no proper sense essays, but merely commonplace book entries of singular facts or quotations, with hardly any comment. These point to the haphazard or indirect origin of them, which has been already suggested. But generally the essay-character—that is to say, the discussion of a special point, it may be with wide digressions and digressions—displays itself. The digressions are indeed constant, and sometimes have the appearance of being absolutely wilful. The nominal title, even when most strictly observed, is

rarely more than a starting-point; and, though the brevity of these first essays for the most part prevents the author from journeying very far, he contrives to get to the utmost range of his tether. Quotations are very frequent.

In 1571 he had received the order of Saint-Michel; in 1574 was with the army of the duke of Montpensier; two years later was made gentleman-in-ordinary to Henry III., and next year again to Henry of Navarre. He visited Paris occasionally, and travelled for health or pleasure to Cauterets, Eaux Chaudes and elsewhere. But his health grew worse and worse, and he was tormented by stone and gravel. He accordingly resolved to journey to the baths of Lucca. Late in the 18th century a journal was found in the château of Montaigne giving an account of this journey, and it was published in 1774; part of it is written in Italian and part dictated in French, the latter being for the most part the work of a secretary or servant. Whatever may be the biographical value of this work, which has rarely been reprinted with the *Essays* themselves, and the MS. of which disappeared early, it is almost entirely destitute of literary interest. The course of the journey was first northwards to Plombières, then by Basel to Augsburg and Munich, then through Tirol to Verona and Padua in Italy. Montaigne visited most of the famous cities of the north and centre, staying five months at Rome, where he had an audience of the pope and was made a Roman citizen, and finally establishing himself at the baths of Lucca for nearly as long a time. There he received news of his election as mayor of Bordeaux with a peremptory royal endorsement enjoining residence, and after some time journeyed homewards. The tour contains much minute information about roads, food, travelling, &c., but the singular condition in which it exists and the disappearance of the MS. make it rather difficult to use it as a document. The best argument in its favour is the improbability of anybody having taken the trouble to forge so bald and awkward a heap of details. Of the fact of the journey there is no doubt whatever.

Montaigne was not altogether delighted at his election to the mayoralty, which promised him two years of responsible if not very hard work. The memory of his father, however, and the commands of the king induced him to accept it; and he seems to have discharged it neither better nor worse than an average magistrate. Indeed, he gave sufficient satisfaction to the citizens to be re-elected at the close of his term, and it may be suspected that the honour of the position, which was really one of considerable dignity and importance, was not altogether indifferent to him. Unfortunately, it cannot be said that "nothing in his office became him like the leaving of it." It was his business, if not exactly his duty, to preside at the formal election of his successor, the *maréchal de Matignon*; but there was a severe pestilence in Bordeaux, and Montaigne writes to the jurats of that town, in one of the few undoubtedly authentic letters which we possess, to the effect that he will leave them to judge whether his presence at the election is so necessary as to make it worth his while to expose himself to the danger of going into the town in its then condition, "which is specially dangerous for men coming from a good air, as he does." It may be urged in his favour that the general circumstances of the time, where they did not produce reckless and foolhardy daring, almost necessarily produced a somewhat excessive caution. However this may be, Montaigne had difficulty enough during this turbulent period, all the more so from his neighbourhood to the chief haunts and possessions of Henry of Navarre, who actually visited him at Montaigne in 1584. He was able, despite the occupations of his journey, his mayoralty, and the pressure of civil war and pestilence, which was not confined to the town, to continue his essay-writing. His second term of office terminated in 1585; and in 1588 after a visit of some length to Paris, the third book of the *Essays* was published, together with the former ones considerably revised. The new essays, as has been remarked, differ strikingly from the older ones in respect of length; and the whimsical unexpectedness of the titles reappears in but two of them: "Des Coches" and "Des Boiteux." They are, however, identical with the earlier ones in spirit, and make

with them a harmonious whole—a book which has hardly been second in influence to any of the modern world.

This influence is almost equally remarkable in point of matter and in point of form. The latter aspect may be taken first. Montaigne is one of the few great writers who have not only perfected but have also invented a literary kind. The essay as he gave it had no forerunner in modern literature and no direct ancestor in the literature of classical times. It has been suggested that the form which the essays assumed was in a way accidental, and this of itself precludes the idea of a definite model, even if such a model could be found. Beginning with the throwing together of a few stray thoughts and quotations linked by a community of subject, the author by degrees acquires more and more certainty of hand, until he produces such masterpieces of apparent desultoriness and real unity as the essay "Sur des vers de Virgile." In matters of style and language Montaigne's position is equally important, but the ways which led him to it are more clearly traceable. His favourite author was beyond all doubt Plutarch, and his own explicit confession makes it undeniable that Plutarch's translator, Jacques Amyot, was his master in point of vocabulary and (so far as he took any lessons in it) of style. Montaigne, however, followed with the perfect independence that characterized him. He was a contemporary of Ronsard, and his first essays were published when the innovations of the Pléiade had fully established themselves. He adopted them to a great extent, but with much discrimination, and he used his own judgment in latinizing where necessary, and in the same way he rejected or altered all special words with a good deal of freedom, but by no means to excess. In the arrangement, as in the selection, of his language he is equally original. He has not the excessive classicism of style which mars even the fine prose of Jean Calvin, and which makes that of some of Calvin's followers intolerably stiff. As a rule he is careless of definitely rhythmical cadence, though his sentences are always pleasant to the ear. But the principal characteristic of Montaigne's prose style is its remarkable ease and flexibility. A few years after Montaigne's death a great revolution, as is generally known, passed over France, and criticism and criticism were fostered by the establishment of the Académie, the minute grammatical surveillance of M. de Favre Vaugelas, and the severe literary censorship of Bourleau, turned French in less than three-quarters of a century from one of the freest languages in Europe to one of the most restricted. During this revolution only two writers of older date held their ground, and those two were Rabelais and Montaigne—Montaigne being of his nature more generally readable than Rabelais. All the great prose writers of France could not fail to be influenced by the racy phrase, the quaint and picturesque vocabulary, and the unconstrained constructions of Montaigne.

It is his influence, however, for the stoutest defender of the importance of form in literature to assign the chief part in Montaigne's influence to style. It is the method, or rather the manner of thinking, of which that style is the garment, which has in reality exercised influence on the world. Like all the greatest writers except Shakespeare, Montaigne thoroughly and completely exhibits the intellectual and moral complexion of his own time. When he reached manhood the French Renaissance was at high water, and the turn of the tide was beginning. Rabelais, who died when Montaigne was still in early manhood, exhibits the earlier and rising spirit, though he needs to be completed on the poetical side. With Montaigne begins the age of disenchantment, and it is not long when he began to meditate on his essays in the retirement of his country-house it was tolerably certain that no golden age was about to return. As the earlier Renaissance had specially occupied itself with the practical business and pleasures of life, so the later Renaissance specially mused on the vanity of this business and these pleasures. The predisposing circumstances which affected Montaigne were thus likely to incline him to scepticism, to ethical musings on the vanity of life and the like. But to all this there had to be added the peculiarity of his own temperament. This was a decidedly complicated one, and neglect of it has led some readers to adopt a more positive idea of Montaigne's scepticism than is fully justified by all the facts. The attitude which he assumed was no doubt ephectic and critical chiefly. In the "Apologie de Raymond Sabunde," he has apparently amused himself with gathering together, in the shape of quotations as well as of reflections, all that can be said against certainty in aesthetics as well as in dogmatics. It is even said by some who have examined the original (*vide infra*) that the text and alterations show a progressively freethinking attitude, side by side with a growing tendency to conceal it by ambiguity and innuendo. But until all the documents are accessible this must remain doubtful. The general tenor of the essays is in complete contrast with those scientific attitude, at least in its more defined form, and it is worth noticing that the motto "*Que sciat-je?*" does not appear on the title-page till after the writer's death. Montaigne is far too much occupied about all sorts of the minutest details of human life to make it for a moment admissible that he regarded that life as a whole but as smoke and vapour. And it is almost certainly wrong, though M. Brunetière may have given countenance and currency to the idea, to regard his philosophy as in the main intended as a succour against the fear of death. The reason of the misapprehension of him which is current is due very mainly to the fact that he was eminently a

humorist. Perhaps the only actual parallel to Montaigne in literature is Lamb. There are differences between them, arising naturally enough from differences of temperament and experience; but both agree in their attitude—an attitude which is sceptical without being negative and humorous without being satiric. There is hardly any writer in whom the human comedy is treated with such completeness as it is in Montaigne. There is discernible in his essays no attempt to map out a complete plan, and then to fill up its outlines. But in the desultory and haphazard fashion which distinguishes him there are few parts of life on which he does not touch, if only to show the eternal contrast and antithesis which dominate it. The exceptions are chiefly to be found in the higher and more poetical strains of feeling to which the humorist temperament lends itself with reluctance and distrust, though it by no means excludes them. The coexistence of the French disposition is already noticeable in Rabelais: it becomes more noticeable still in Montaigne. He is always charming, but he is rarely inspiring, except in a very few passages where the sense of vanity and nothingness possesses him with unusual strength. As a general rule, an agreeable grotesque of the affairs of life (a grotesque which never loses hold of good taste sufficiently to be called burlesque) occupies him. There is a kind of anticipation of the scientific spirit in the careful zeal with which he picks up odd aspects of mankind and comments upon them as he places them in his museum. Such a temperament is most pleasantly shown when it is least personal. A dozen generations of men have rejoiced in the gentle irony with which Montaigne handles the *ludicrum humani saeculi*, in the quaint felicity of his selection of examples, and in the real though sometimes fantastic wisdom of his comment on his selections.

Montaigne did not very long survive the completion of his book. On his way to Paris for the purpose of getting it printed he stayed for some time at Blois, where he met De Thou. In Paris itself he was for a short time committed to the Bastille by the Leaguers, as a kind of hostage, it is said, for a member of their party who had been arrested at Rouen by Henry of Navarre. But he was in no real danger. He was well known to and favoured by both Catherine de' Medici and the Guises, and was very soon released. In Paris, too, at this time he made a whimsical but pleasant friendship. Marie de Jars de Gournay (1565-1645), one of the most learned ladies of the 16th and 17th centuries, had conceived such a veneration for the author of the *Essays* that, though a very young girl and connected with many noble families, she travelled to the capital on purpose to make his acquaintance. He gave her the title of his "fille d'alliance" (adopted daughter), which she bore proudly for the rest of her long life. She lived far into the 17th century, and became a character and something of a laughing-stock to the new generation; but her services to Montaigne's literary memory were, as will be seen, great. Of his other friends in these last years of his life the most important were Étienne Pasquier and Pierre Charron. The latter, indeed, was more than a friend, he was a disciple; and Montaigne, just as he had constituted Mlle de Gournay his "fille d'alliance," bestowed on Charron the rather curious compliment of desiring that he should take the arms of the family of Montaigne. It has been thought from these two facts, and from an expression in one of the later essays, that the marriage of his daughter Léonore to Gaston de La Tour had not turned out to his satisfaction. But family affection, except towards his father, was by no means Montaigne's strongest point. When Henry of Navarre came to the throne of France, he wished Montaigne, whom he had again visited in 1587, to come to court, but the essayist refused. It would seem that he returned from Paris to his old life of study and meditation and working up his *Essays*. No new ones were found after his death, but many alterations and insertions. His various maladies grew worse; yet they were not the direct cause of his death. He was attacked with quinsy, which rapidly brought about paralysis of the tongue, and he died on the 13th of September 1592, in circumstances which, as Pasquier reports them, completely disprove any intention of displaying anti-Christian or anti-Catholic leanings. He was buried, though not till some months after his death, in a church in Bordeaux, which after some vicissitudes became the chapel of the collège. During the Revolution the tomb, and as it was supposed the coffin, were transferred with much pomp to the town museum; but it was discovered that the wrong coffin had been taken, and it was afterwards restored to its old position. Montaigne's widow

survived him, and his daughter left posterity which became merged in the noble houses of Ségur and Lur-Saluces. But it does not appear that any male representative of the family survived.

When Mlle de Gournay heard of the death of Montaigne she undertook with her mother a visit of ceremony and condolence to the widow, which had important results for literature. Mme de Montaigne gave her a copy of the edition of 1588 annotated copiously; at the same time, apparently, she bestowed another copy, also annotated by the author, on the convent of the Feuillants in Bordeaux, to which the church in which his remains lay was attached. Mlle de Gournay then set to work to produce a new and final edition with a zeal and energy which would have done credit to any editor of any date. She herself worked with her own copy, inserting the additions, marking the alterations and translating all the quotations. But when she had got this to press she sent the proofs to Bordeaux, where a poet of some note, Pierre de Brach, revised them with the other annotated copy. The edition thus produced in 1595 has with justice passed as the standard, even in preference to those which appeared in the author's lifetime. Unluckily, Mlle de Gournay's original does not appear to exist and her text was said, until the appearance of M. Courbet and Royer's edition, to have been somewhat wantonly corrupted, especially in the important point of spelling. The Feuillants copy is in existence, being the only manuscript, or partly manuscript, authority for the text; but access to it and reproduction of it are subjected to rather unfortunate restrictions by the authorities, and until it is completely edited students are rather at the mercy of those who have actually consulted it. It was edited in 1803 by Nageon, the disciple of Diderot; but, according to later inquiries, considerable liberties were taken with it. The first edition of 1580, with the various readings of two others which appeared during the author's lifetime, was edited by Dezeimeris and Burckhardt in 1870. That of Le Clerc (3 vols., Paris, 1826-1828) and in a more compact form that of Louandre (4 vols., Paris, 1854-1856) have been most useful; but that of MM. Courbet and Royer (1872-1900) is at present the standard. The *Journal*, long neglected and still (*vide supra*) doubtful, was re-edited by Professor A. d'Ancona (Città di Castello, 1895) and translated into English by W. G. Waters (1903). The editions of Montaigne in France and elsewhere, and the works upon him during the past three centuries, are innumerable. The most recent books of importance are P. Bonneton's *Montaigne, l'homme et l'auteur* (1893) and M. P. Sarrailh's *Montaigne* (1895) in the *Grandes figures françaises*; the latter a book of remarkable excellence. Edmé Champion's *Introduction aux essais* may also be noticed, and Professor Dowden's *Montaigne* (1905), which has an excellent bibliography. The somewhat earlier *Montaigne* of M. E. Lowndes (Cambridge, 1898) is noteworthy in especial for its attention to his life and character. In England Montaigne was early popular. It was long supposed that the autograph of Shakespeare in a copy of Florio's translation showed his study of the *Essays*. The autograph has been disputed, but divers passages, and especially one in *The Tempest*, show that at first or second hand the poet was acquainted during the essayist's lifetime with the work. Consulting on this head is J. Feis's *Shakespeare and Montaigne* (1884). Towards the latter end of the 17th century, Cotton, the friend of Isaac Walton, executed a complete translation, which, though not extraordinarily faithful, possesses a good deal of rough vigour. It has been frequently reprinted with additions and alterations. Reprints of Florio are also numerous. One in the "Tudor Translations" (1893) has an introduction by G. Sainsbury. An English biography of Montaigne by Bayle St John appeared in 1858, and Walter Pater's unfinished *Gaston de La Tour* borrows from Montaigne and his story. The most noteworthy critical handling of the subject in English is unquestionably Emerson's in *Representative Men*. (G. SA.)

MONTALBÁN, JUAN PEREZ DE (1602-1638), Spanish dramatist, poet and novelist, was born at Madrid in 1602. At the age of eighteen he became a licentiate in theology, was ordained priest in 1625 and appointed notary to the Inquisition. In 1610 he began writing for the stage under the guidance of Lope de Vega, who is said to have assisted him in composing *El Orfeo en lengua castellana* (1624), a poem obviously intended to compete with Jáuregui's *Orfeo*, published earlier in the same year. The prose tales in *Sucesos y prodigios de amor* (1624) and *Para todos* (1632) were very popular. Montalbán's father, a publisher at Madrid, issued a pirated edition of Quevedo's *Buscón*, which roused an angry controversy. The violence of these polemics, the strain of overwork, and the death of Lope de Vega so affected Montalbán that he became insane; he died at Madrid on the 25th of June 1638. His last work was a eulogistic biography of Lope de Vega in the *Fama póstuma* (1636). His plays, published in 1635-1638, are all in the manner of that great dramatist, and were represented with much success, but, with the exception of *Los Amantes de Teruel*, are little

more than clever improvisations. A libellous attack on Quevedo, entitled *El Tribunal de la justa venganza* (1635), is often ascribed to him.

MONTALEMBERT, CHARLES FORBES RENÉ DE (1810-1870), French publicist and historian, was born on the 15th of March 1810. The family was a very ancient one, belonging to Poitou, or rather to Angoumois. Direct descent is said to be traced back to the 13th century, and charters carry the history of the house two centuries further. For some generations before the historian the family had been distinguished, not merely in the army, but for scientific attainments. Montalembert's father, Marc René, emigrated, fought under Condé, and subsequently served in the English army; he married Elise Rosée Forbes, and his eldest son, Charles, was born in London. At the Restoration of 1814 Marc René returned to France, was raised to the peerage in 1810, and became ambassador to Sweden (where Charles completed his education) in 1826. He died in 1831, a year after the overthrow of the legitimate monarchy. Charles de Montalembert was too young to take his seat as a peer (twenty-five being the necessary age), but he retained other rights, and this, combined with his literary and intellectual activity, made him a person of some importance. He was a Liberal, in the English sense, and had he not resolutely separated himself from the new régime on the religious question he would have approved of the policy of the golden mean represented by Louis Philippe. He wished to see the Church free from the control of the state, and passionately attacked the monopoly of public instruction by which the monarchy fortified its position. This latter scheme first brought Montalembert into notice, as he was formally charged with unlicensed teaching. He claimed the right of trial by his peers, and made a notable defence, of course with a deliberate intention of protest (1832). On the other hand, he thought that the Church should not obstinately oppose new ideas. He had eagerly entered into the plans of his friends, Lamennais and Lacordaire, and collaborated with them in the newspaper *l'Avenir*. The Ultramontane party was roused by their boldness, and Montalembert and his two friends then left for Rome. This famous pilgrimage proved useless to mitigate the measures which the Roman curia took against the *l'Avenir*. Its doctrines were condemned in two encyclicals (*Mirari vos*, 1832, and *Singulari vobis*, 1834), and Montalembert submitted. He still clung to his early Liberalism, and in 1848 saw without regret the end of a government towards which he had always been hostile. He had a seat in the Chamber of Deputies till 1857, but to his great regret was then obliged to retire into private life. He was still, however, recognized as one of the most formidable opponents of the empire. Meanwhile his Liberal ideas had made him some irreconcilable enemies among the Ultramontanes. Louis Veullot, in his paper, *l'Univers*, fought desperately against him. Montalembert answered by reviving a review which had for some time ceased publication, the *Correspondant* (1855), in which he set himself to fight both against the fanatical party of Pius IX. and the *Syllabus*, and the more or less free-thinking Liberals of the *Revue des deux mondes*. He took great interest in the débuts of the Liberal empire, whilst trying to parry the blow which the Ultramontanes were preparing to deal to Liberal ideas by proclaiming in the Vatican council the dogma of papal infallibility. But once again he would not allow himself to be seduced from obedience to the pope; he now severed his connexion with Père Hyacinthe (Loison) as he had with Lamennais, and made the submission expected of him to the council. It was his last fall. Broken down by the trial of these continued fights against people of his own religion, he died prematurely on the 13th of March 1870.

In addition to being an eloquent orator, Montalembert wrote a style at once picturesque, fiery and polished. He was an ardent student of the middle ages, but his medieval enthusiasm was strongly tinged with religious sentiments. His first historical work, *La Vie de Ste Elisabeth de Hongrie* (1836), is not so much a history as a religious manifesto, which did much to restore the position of hagiography. It met with great success; but Montalembert was not elected a member of the Académie

Française till later, after the fall of the July monarchy (Jan. 9, 1851). From this time he gave much of his attention to a great work on monachism in the West. He was at first attracted by the figure of St Bernard, and devoted one volume to him; this was, however, afterwards withdrawn on the advice of his friend Dupanloup, and the whole edition was destroyed. He then enlarged his original plan and published the first volumes of his *Moines d'occident* (1860), an eloquent work which was received with much admiration in those circles where language was more appreciated than learning. The work, which was unfinished at the time of the author's death, was completed later from some long fragments found among his papers (vols. vi. and vii., 1877).

Montalembert married Mlle de Mérode, sister of one of Pius IX.'s ministers. His daughter married the vicomte de Meaux, a Roman Catholic statesman and distinguished writer.

BIBLIOGRAPHY.—Mrs Oliphant, *Memoir of Count de Montalembert, peer of France, deputy for the department of Doubs* (Edinburgh, 1872). Mrs Oliphant, who has also translated into English *Moines d'occident*, has given a most charming account of the youth of Montalembert, and especially the first years passed at Stanmore. See also the vicomte de Meaux, *Montalembert* (1897); see also L. R. P. Lecanuet, *Montalembert, d'après son journal et sa correspondance* (3 vols., 1895-1902) a work filled with important documents; and Léon Lefebvre, *Portraits de croyants au XIX^e siècle: Montalembert, Auguste Cochin, François Rio* (who was Montalembert's professor of philosophy); A. Guithiv (1905); and *Lettres d'Alphonse d'Herbelot à Charles de Montalembert et à Léon Cornudet* (1828-1830).

MONTALEMBERT, MARC RENÉ, MARQUIS DE (1714-1800), French military engineer and writer, was born at Angoulême on the 16th of July 1714, and entered the French Army in 1732. He fought in the War of the Polish Succession on the Rhine (1733-34), and in the War of the Austrian Succession made the campaigns of 1742 in Bohemia and Italy. In the years preceding the Seven Years' War, Montalembert (who had become an associate member of the Académie des Sciences in 1747) devoted his energies to the art of fortification, to which Vauban's *Traité de l'attaque* attracted him, and founded the arsenal at Ruelle, near his birthplace. On the outbreak of war he became French commissioner with the allied army of Sweden, with the rank of brigadier-general. He constructed the field fortifications of Anklam and Stralsund. In 1761 he was promoted *maréchal de camp*, and began the works on which his fame rests. Montalembert's fortress has been aptly described by an English author as an "immense battery." The intricacies of trace by which Vauban and Cormontaigne sought to minimize the power of the attack, are abandoned in favour of a simple tenaille plan so arranged that the defenders can bring an overwhelming fire to bear on the works of the besieger. Montalembert, who himself drew his idea from the practice of Swedish and Prussian engineers, furnished the German constructors of the early 18th century with the means of designing entrenched camps suitable to modern conditions of warfare. The "polygonal" method of fortification is the direct outcome of Montalembert's systems. In his own country the caste-spirit of the engineer corps was roused to defend Vauban, and though Montalembert was allowed to construct some successful works at Aix and Oléron, he was forbidden to publish his method, and given but little opportunity for actual building. After fifteen years of secrecy he published in Paris (1776-1778) the first edition of *La Fortification perpendiculaire*. At the time of the Revolution he surrendered a pension, which had been granted him for the loss of an eye, although he was deeply in debt, particularly on account of his Ruelle foundry, on which 6000 livres were due to him from the state, which he never received. Persuaded by his wife, he joined in the emigration of the noblesse, and for a time lived in England. All his possessions were thereupon sequestered by the republican government. He very soon returned, divorced his wife, and married again. He obtained the annulment of the sequestration. Carnot often called him into consultation on military affairs, and, in 1792, promoted him general of division. Proposed as a member of the *Institut* in 1797, he withdrew his candidature in favour of General Bonaparte. He died at Paris on the 29th of March 1800. His wife, Marie Josephine de Comarieu, was the

hostess of one of the best-known salons of Louis XVI.'s time. She wrote two novels of merit, *Elise Dumesnil* (1798) and *Horace* (1822). She died in 1832.

Besides his masterpiece, he wrote *L'Art défensive supérieure à l'offensif* (1793; in reply to attacks made upon his earliest work, *La Fortification perpendiculaire*, of which in later editions it forms part); *Mémoire historique sur le Fort des canons* (Paris, 1758), and other works on the same subject; *Correspondance pendant le guerre de 1757-1760* (London, 1777); *Rotation des boulets* (Acad., 1755); and *Rélatons du siège de S. Jean d'Acres* (Paris, 1789). He also wrote short stories and verse, as well as comedies. He also modelled a complete course of Fortification (92 models), which he offered to the Committee of Public Safety. His bust was sculptured by Bonvallet. Montalembert's position in the history of fortification may be summed up as a realization of his own wish to do for the defence what Vauban had done for the attack. It was the inability of his contemporaries to see that Vauban's strength lay in his parallels and batteries and not in his bastions that vitiated their methods, and it was Montalembert's appreciation of this fact which made him the father of modern fortification. See Tripier, *La Fortification déduite de son histoire* (Paris, 1866).

MONTALIVET, MARTHE-CAMILLE BACHASSON, COMTE DE (1801-1880), French statesman, was born at Valence on the 25th of April 1801, the second son of Jean Pierre Bachasson, comte de Montalivet (1766-1823), who had been made a peer of France in 1810. Both his father and his elder brother Simon Pierre Joseph (1799-1823) had been engineer officers, and he was educated at the École Polytechnique and the École des Ponts et Chaussées. Under Louis Philippe he occupied the ministry of the interior from, with short intervals, 1830 to 1840. After 1840 he was intendant of the civil list, occupying himself with the museums of Versailles and the Louvre, and the restoration of the palaces of Fontainebleau and Saint-Cloud. In 1847 he tried to induce Louis Philippe to adopt electoral reform, and after the catastrophe of the next year undertook the defence of the July monarchy in two works, *Le Roi Louis Philippe et la liste civile* (1851) and *Kient Dix années de gouvernement parlementaire* (1862). He had become a member of the Academy of Fine Arts in 1840 and in 1843 grand cross of the Legion of Honour. The attitude of the comte de Chambord after 1870 led him to accept the republic, and he entered the Senate a year before his death, on the 4th of January 1880.

MONTANA, a north-western state of the United States, situated between latitudes 44° 26' and 49° N., and between longitudes 27° and 39° W. from Washington. It is bounded N. by the Canadian provinces of British Columbia, Alberta and Assiniboia; E. by North Dakota and South Dakota; S. by Wyoming and Idaho; W. by Idaho. Montana has an area of 146,572 sq. m., 796 sq. m. of which are water surface. (For map, see IDAHO.)

Physical Features.—The Rocky Mountains cross the state from north-west to south-east, and with their spurs and outlying ranges occupy nearly one-third of its area in the west and south-west; the remaining portion is occupied chiefly by the Great Plains. The main range of the Rockies follows the boundary line between Montana and Idaho west and north-west from Yellowstone Park in Wyoming to Ravalli county, then turns east-north-east to Lewis and Clark county, and from there extends north-north-west into Canada. From where the main range turns east from the Idaho boundary line the crest of the Bitter Root Mountains continues on that line with a downward slope to within one degree of latitude from the Canadian border. This range of mountains, which was formed by a great fault, has a maximum elevation at its southern end of about 9000 ft. above the sea. On its slope, which rises abruptly from the Bitter Root basin, glaciers have cut cañons between high and often precipitous walls, and between these cañons are steep and rocky ridges having peaked or saw-toothed crest lines. To the east and north-east of the Bitter Root Mountains is a considerable basin or peneplain dissected by short ranges having a north-west and south-west trend. To the south-east of this basin are the greatest mountain masses of the state; lofty and rugged ranges radiate in all directions, and in many instances rise to heights of 10,000-11,000 ft., the highest peak in the state being Granite Peak (12,834 ft.) in Carbon county. Deep and narrow

cañons are common, and, at higher levels, glaciers, carved out amphitheatres, or "cirques" and "U"-shaped troughs. In the north the Rocky Mountains consist principally of two parallel ranges, the Lewis and Clark Range to the east, and the Livingston Range to the west, which were formed by a great over-thrust; between them is the Waterton-McDonald valley, 8-15 m. wide. The east slope of the Lewis and Clark range is marked by long high spurs, and the valleys between them end in radiating cañons that are crowned with bold cliffs. On the higher summits the range rises to 8500-10,400 ft. above the sea, but in the wind-gaps only to 5500-6500 ft. The Livingston range is less rugged and more massive. Like the Lewis and Clark range, its crest is broken by numerous U-shaped wind-gaps and its west slope is cut by glacial troughs containing long narrow lake basins. Extending far to the eastward, especially in the south of the state, are isolated mountain groups. Among these are the Bear Paw Mountains, in the north central part, which occupy a tract 40 m. long and 20 m. wide that on the western side rises abruptly from the plains and reaches an elevation in Bear Paw Peak of 7040 ft. above the sea. The Great Plains in Montana slope from about 4000 ft. (above the sea), at the foothills of the mountains, to 2000 ft. in the north-east of the state. The valleys of the principal streams are deeply eroded; bluffs are common along their borders, and buttes elsewhere on the plains. The main range of the Rocky Mountains separates that part which is drained west into the Columbia river and the Pacific Ocean from that which is drained east into the Missouri and Mississippi rivers and the Gulf of Mexico, and from a very small part which is drained north-east into Hudson Bay; the water-parting which in Montana separates the drainage into Hudson Bay from the drainage into the Gulf of Mexico crosses only the north-west of Teton county. The principal rivers east of the Rockies are the Missouri and three of its tributaries; the Yellowstone in the south-east, the Musselshell in the middle, and the Milk in the north. The Missouri is formed by a union of the Jefferson, the Madison and the Gallatin. It flows first east-north-east and then nearly east until it passes into North Dakota. Its channel is generally erratic and constantly shifting; its bed is sandy and its water muddy. In contrast, the Yellowstone is a stream of bright clear water running over a gravelly bed and among numerous forest-clad islands. The Missouri is navigable for small boats to Fort Benton in Chouteau county, but farther upstream near Great Falls, Cascade county, to which it is navigable at high water, it falls 512 ft. in 10 m. The Yellowstone is navigable for about 300 m. The principal rivers west of the Main Divide of the Rockies are the Clark Fork of the Columbia and its principal tributary, the Flathead, which rises in British Columbia. Montana has a few mineral springs, the best known being the Lissner Springs at Helena. Small lakes and waterfalls, the result of glacial action, are numerous in the mountains. There is, however, only one large lake in the state—Flathead (or Selish) Lake, which may be regarded as an enlargement of Flathead river; it is 27 m. long, has an average width of 12 m., and a depth of more than 1000 ft.

Geology.—In the Great Plains region the geological structure is very simple, consisting of nearly horizontal strata of Cretaceous rock in the middle and western portions, and of Tertiary rock on the eastern border, but in the mountain region the rocks have been folded and faulted until the structure is intricate and obscure. Some of the deeper cañons show rocks of nearly all ages. The higher elevations are mostly either Archean or Paleozoic formations projecting above Tertiary deposits. In the Bitter Root Valley is a large deposit of Quaternary. Fossil remains of mammals, fish and reptiles found in the Tertiary deposits of south-western Montana are preserved in the Carnegie Museum at Pittsburgh, Pennsylvania, and in the museum of the University of Montana. They include the mandible of a mastodon and a portion of a vertebra of a large fish, both found in the Lower Madison Valley; the skull and other parts of a dog (*Mesocyon drummondianus*), found near Drummond, Granite county; the skull of a *Psittacops paludicola*, found near New Chicago, Granite county; a portion of the skull of a *Mesokippus latidens*, found near the confluence of the three forks which form the Missouri river; and a portion of the skull of a *Hyrachyus priscus*, found near Lima, Beaverhead county. In the region east of the Crazy Mountains, in Sweetgrass county, are marine beds of upper Cretaceous or lower Tertiary formation containing fossils of Dinosaurs and

Mosasaurs, and in the museum of the university of Montana is the greater part of the skeleton of a Dinosaur which was found here. Interesting fossil remains have also been found in Carboniferous formations in the south-west of the state.

Fauna.—The native fauna is not sharply distinguished from that of the surrounding states. The bison, which once ranged the plains in large herds, have been exterminated; the moose and the elk are found only occasionally in the higher regions; mountain sheep, antelope, black and grizzly bears, wolves, coyotes and lynx ("wild cats") are also becoming rare. Black-tailed and mule deer are still favourite game for sportsmen. Geese, ducks and grouse are numerous about the lakes and rivers. Several kinds of fish, among which are trout, salmon, grayling and white fish, inhabit many of the lakes, rivers and mountain streams, and a government fish hatchery at Bozeman, Gallatin county, restocks waters in which the supply has been diminished.

Flora.—The Great Plains are covered for the most part only with bunch grass which grows in tufts, leaving the ground visible between, and except in May and June presents a yellow and withered appearance. Mixed with the bunch grass are occasional patches of sage brush. Most of the bluffs along the principal river valleys, especially those in the south-east, are entirely bare of vegetation, but on the bottom lands along the rivers and streams considerable patches of cottonwood and willows are common. The mountain valleys are covered with little except grasses; on the higher parts of the mountains there are barren rocks or only a scant growth of timber; but many of the lower mountain slopes, especially those along the western border, are clothed with heavy timber, yellow pine, red fir and tamarack being the principal species.

Climate.—The climate is generally dry, although less so on the mountains and in the Flathead river basin than on the Great Plains, and is subject to sudden changes and to great extremes of temperature; but the temperature varies more than the amount of precipitation. In the west the climate is generally delightful, it being there greatly affected by the warm, dry "Chinook" wind which blows from the Pacific Ocean; to some extent the wind modifies the temperature nearly to the eastern border. It is the prevailing wind of winter in the mountains and in consequence the periods of cold, though often severe, are short. In the north-west the winds are generally cold and in the summer hot and dry. The mean annual temperature ranges from 37° F. in the east-west to 47° in the sheltered valleys among the mountains. On the Great Plains a range of extremes within a year from -40° F. to 100° is not unusual, but in the mountain valleys the range is rarely greater than from -20° to 90°. The records from 1880 to 1907 show a maximum range from 117° at Glendive, near the eastern border, in July 1893, to -63° at Poplar, about 80 m. north by west of Glendive, in January 1885. The amount of precipitation is greater in the north-west and on the mountains, because in the one the mountains are a barrier to the moisture-bearing winds from the west, and in the other the mountains condense the moisture; the mountains which stand in isolated groups upon the plains are frequently in summer the focus of local thunder showers. The average annual precipitation ranges from 10 to 15 in. on the Great Plains to 20 in. or more in the north-west, and over limited areas in the higher mountain region. Nearly one-half of the rain falls during the four months from May to August inclusive. Storms endangering life and property occur only in the east, caused by a high north wind with snow or rain and a low temperature.

Soil.—In the west the soil is for the most part a black clayey loam lacking in natural drainage, but on the "bench lands" higher up there is a deep layer of sandy loam beneath which is a bed of gravel. Some of the best soil is in the mountain valleys, for these valleys were once lakes and rich deposits of alluvium were made in them. The mountain slopes are often bare or covered only with a thin layer of mould.

Agriculture.—The rainfall is sufficient for good grazing, but except in the Flathead valley cultivation was long considered to be dependent on irrigation; and consequently farming was only incidental to stock raising and mining until after 1870, and as late as 1900 the ratio of improved farm land to the total land area was less than in any other state or territory except New Mexico, Wyoming, Arizona and Hawaii. In 1906 the farm area was almost equally divided between "dry" farming and farming under irrigation, three-fourths of the wheat produced was grown without irrigation, and the dry farming was very successful with the comparatively new and valuable crops of *durum*, or macaroni wheat, and Russian barley, which is used in straw for winter feed to sheep and neat cattle. The counties where dry farming had been carried on to the largest scale were Missoula, Ravalli, Flathead, Cascade, Fergus and Gallatin, where cereal yields, though not nearly so large as from irrigated lands, were high compared with the average for the country. But even where dry farming was successful, the increase of crops made possible by cheap irrigation seemed to be inducing farmers to abandon it. Among the larger privately irrigated tracts are: 16,000 to 18,000 acres in Yellowstone county, fed by a canal built by the Billings Land & Irrigation Company; about 35,000 acres of orchard land in the Bitter Root Valley, in Ravalli county, irrigated by canals from Lake Como, a natural reservoir; and 100,000 acres in Missoula county, to be watered from a 28 ft. dam across the Clark

Fork (or Missoula River) at Bonner. Private irrigation by pumping was first successfully introduced about 1901, and in 1906 a state report estimated that 125 pumping irrigation plants were in use in the state. Boring for underground water supply to be used in irrigation was tried on a small scale. An area of 16,000 acres in Missoula county is watered by a ditch 10 m. long built in 1902-1905 by the co-operative Grass Valley-Frenchtown Irrigation Company, and the Teton Co-operative Canal Company in 1906 began work on a diversion canal from the Teton River, whose waters are to be stored by a dam 62 ft. high and 2100 ft. long. But more important than private and co-operative undertakings are the Federal irrigation projects. In 1894 Congress passed the Carey Act, under which Montana received title to 1,000,000 acres of arid land on condition that the state would reclaim it by providing an adequate supply of water; the state accepted the offer, created an irrigation commission, and provided means for securing the necessary funds. Furthermore, Congress in 1902 appropriated the receipts from the sales of public lands in the state to the construction of irrigation work. In 1890 there were 6812 m. of irrigation canals and large ditches in the state; the irrigated acreage had increased from 350,582 acres in 1889 to 951,154 acres in 1899, when about 84% of the irrigated area was in the south-west. The great Federal projects were not begun until after 1900. Among them are: the Huntley project in Yellowstone county, begun in 1904 and practically completed in 1908, covering land formerly in the Crow Indian reservation, the irrigable area being 28,921 acres; the Lower Milk river project (and the subsidiary St Mary project), in Chouteau, Valley and Teton counties, by which the water of the Milk river is stored and diverted to the headwaters of the Milk river to irrigate an area of 300,000 acres; the Sun river project (Teton, Lewis and Clark, Chouteau and Cascade counties), by which, as the ordinary flow of that river is already utilized for irrigation, the flood waters are stored and carried to the higher bench lands of the district; in Montana (Dawson county) and North Dakota (McKenzie county), the Lower Yellowstone project; and the Blackfeet project, to irrigate the Blackfeet reservation in Teton county.

In 1900, 11,844,454 acres, or 12.7% of the area, was included in farms; of this, 1,736,701 acres, or 14.7% was improved; 54.7% of the improvement was irrigated; 79.4% of the irrigated land was used for growing crops and 20.6% for pasturage; the total acreage of all crops was 1,151,674, and of this 755,865, or 65.6% was irrigated. In the same year there were 13,370 farms exclusive of those on Indian reservations; of these, 6665 contained less than 175 acres each; 1289 contained more than 1000 acres each; 8043 contained some irrigated land, the average amount being 118 acres; 11,592 were worked by owners or part owners, 624 by cash tenants, and 606 by share tenants.

Of the total acreage of all crops in 1899, 875,712 acres, or 76%, was wheat, the crop, and 254,231 acres, or 22% were cereals; of the cereal acreage 52% was oats, 32% was barley, 9% was barley, and 3% was Indian corn. In 1909 the oat crop was 15,300,000 bushels from 300,000 acres; the acreage of wheat in 1909 was 350,000 and the production 10,764,000 bushels; the acreage of barley in 1909 was 500,000 acres, and 1,900,000 bushels were raised; the acreage of Indian corn in 1909 was 5000 acres, and 175,000 bushels were grown.

Sugar beets were first grown in Montana at Evans, Cascade county, in 1893 without irrigation. In 1906 a refinery (with a daily steaming capacity of 1200 tons) was built at Evans, Yellowstone county. Russians, with experience in beet growing, are furnished by the sugar company to the growers for the bunching, thinning, hoeing and topping of the beets. In 1906 sugar refineries were projected at Hamilton, Kalispell, Chinook, Laurel, Missoula, Dillon and Great Falls; and in 1907 the crop was so large that 12,000 freight cars were needed to carry it and the railways had a car and coal "famine."

The east is devoted chiefly to stock raising; for cattle, horses and sheep thrive well on the bunch grass except when it is covered with snow. The principal sheep-raising counties are Custer, Yellowstone, and Big Horn, where many sheep are brought to be fattened. Rosebud, Beaverhead, Valley, and Meagher. In 1909 the number of sheep in Montana was 5,747,000, being exceeded only by the number in Wyoming; the number of cattle was 922,000, only 80,000 being milk cows, and the number of horses 319,000.

Lumber.—The woodland area was estimated in 1900 at 42,000 sq. m., much of which had been burned over. It is confined mainly to the mountain slopes, and in March 1909 31,858.9 sq. m., more than three-fourths of this total, had been set apart in the following "national forests": Absaroka (980,448 acres), Bearfoot (895,293 acres), Beaverhead (1,406,680 acres), Montana and a smaller area in Idaho), Bitterroot (1,180,900 acres), Blackfeet (1,956,340 acres),

and the St Mary and both forks of the Milk river flow northward into the Dominion of Canada, and as there has been much private irrigation both north and south of the international boundary, the present Federal project and other undertakings in the same region necessitate an international agreement as to the division of the waters, especially of the St Mary, and commissioners representing the Canadian government and the United States conferred in regard to it in May 1908.

Cabinet (1,020,960 acres), Custer (590,720 acres), Deerlodge (1,080,220 acres), Flathead (2,092,785 acres), Gallatin (907,160 acres), Helena (930,180 acres), Jefferson (1,255,320 acres), Kootenai (1,661,260 acres), Lewis and Clark (844,136 acres), Lolo (1,211,680 acres), Madison (1,102,860 acres), Missoula (1,237,509 acres) and Sioux (145,253 acres in Montana; 104,400 acres in South Dakota). A large part of the woodland contains no trees fit for lumber; nevertheless the value of the lumber was \$5,224,674 in 1905. More than one-half of the product is yellow pine and the remainder is principally red fir and tamarack. There is scarcely any hardwood timber in the state.

Minerals and Mining.—Mining has been the leading industry of Montana ever since the discovery of gold in 1862. It contains the largest copper producing district in the world, and in 1907 mined more copper than any other state or territory except Arizona; this metal constituted nearly three-fourths in value of the state's mining products in 1907, the total value being \$60,663,511 and that of copper \$44,852,758. The most important copper mines are in Silverbow, Broadwater, Jefferson and Beaverhead counties. Gold was discovered in Deerlodge county as early as 1852 but very little mining was done until ten years later. In 1863 the famous Alder Gulch in Madison county was discovered and in the next year, Last Chance Gulch in the south of Lewis and Clark county. In 1865 the product reached its maximum, as the value of gold and silver combined (the value of the silver being relatively small) was \$18,000,000; the production then decreased and in 1903 the value of the gold was only \$1,800,000. Then copper mining rapidly developed and considerable gold was obtained from copper ores. Until the development of copper mining, silver was produced only in small quantities along with gold, but as much more silver than gold was obtained from the copper ores the value of the silver product increased from \$2,630,000 in 1881 to \$24,615,822 in 1892. The product then fell off, but in 1907, when it amounted to 9,317,605 fine ounces, valued at \$6,149,619, more than nine-tenths of it was derived from the copper ores in Silverbow county. It was in 1882 while Marcus Daly was sinking a shaft at Anaconda in preparation for milling gold and silver ores that he discovered the first rich copper lode. Other discoveries about Butte followed, and the output of copper increased from 11,011 long tons in 1883 to 29,800 long tons in 1906, more than ten times as much. The industry has become a political life of Montana have been strongly influenced by the copper industry and by the tremendous wealth controlled by the copper interests; in the industry three men were long dominant—Marcus Daly, William A. Clark and F. Augustus Heinz; later the Amalgamated Copper Company gained control of a large part of the mines.

Coal was discovered in Montana before 1880, when 224 tons were mined. In 1907 the output was 2,016,857 tons, and in 1908 1,920,190 tons. The coal underlying the east half of the state, the "Great Plains," is lignitic and of inferior quality, but in the mountain districts is bituminous and generally suitable for coking. The principal fields are: the isolated Bull Mountain deposit, 45 m. north-east of Billings, in Yellowstone county; the large Clark Fork field in Meagher, Sweet Grass, Yellowstone and Carbon counties; the small but valuable Rocky Fork field in the south central part of Carbon county; the Red Lodge field in Carbon county; the Yellowstone field, chiefly in Gallatin and Park counties; the Trail Creek deposits, 10 m. south of Bozeman; the Cinnabar field in south Park county; the Great Falls field in Cascade county; and the West Gallatin, the Toston and the Ruby valley fields. The output steadily increased until 1895 when it was 1,504,193 short tons; but from then to 1905, when it was 1,643,832 short tons, the quantity varied little from year to year. From 1905 to 1907, when the output was valued at \$3,907,082, the increase in production was steady.

Granite, sandstone and limestone are abundant in the state, but have been little developed. Granite was quarried in 1907 to the value of \$102,050. Limestone quarried in the same year was worth \$124,690; and sandstone was valued at \$39,216. Some light grey sandstone found in Rocky Cañon, Gallatin county, looks as much like the Berea (Ohio) sandstone as a sandstone quarried at Columbus, Yellowstone county, was manufactured into grindstones equal to those made from the Berea stone. Gypsum in Carbon county and in Cascade county is worked for plaster. Sapphires are found in several gulches, especially on Yogo Creek, 16 m. from Utica, Fergus county, where blue stones are found, and on Rock and Cottonwood creeks, where green, yellow, red and blue sapphires have been found. Many of the sapphires are shipped to Switzerland for watch jewels and for bearings. In 1907 the total value of precious stones was \$229,800.

Manufactures.—With the exception of the smelting and refining of copper, manufacturing in Montana is decidedly a minor industry. In 1905 the total value of the "factory" product was \$66,415,452, and the value of the copper (by state reports) was \$48,165,277. Lumber and timber products, which ranked second, increased in value from \$2,846,268 in 1900, to \$3,024,674 in 1905. Flour and grain mill products rose during that period from \$937,462 to \$2,003,136; and malt liquors increased in value from \$1,267,331 to \$1,731,691. In 1905 the value of the products of the factories of Anaconda and Great Falls was 63.5% of that for the entire state.

Transport.—Montana is served by three transcontinental railways:

the Great Northern traversing the north, the Northern Pacific traversing the south-east, south and south-west portions, and north of the Northern Pacific, the Chicago, Milwaukee & Puget Sound, an extension of the Chicago, Milwaukee & St Paul to Seattle and Tacoma, practically completed in 1909; branch lines of the Great Northern. From the north, connect with the Northern Pacific and the Chicago, Milwaukee & Puget Sound at Butte, and with the Northern Pacific at Laurel. The Oregon Short Line from the south connects with the Northern Pacific, the Great Northern, and the Chicago, Milwaukee & Puget Sound at Butte, and the Burlington system, also from the south, connects with the Northern Pacific at Billings, Yellowstone county. The Butte, Anaconda & Pacific railway carries ore from the mines at Butte to the smelters at Anaconda. The first railway was the Oregon Short Line, which was completed by the Union Pacific Company from Ogden, Utah, to Butte in 1881. The Northern Pacific reached Helena two years later and the railway mileage in the state increased from 106 m. in 1880 to 4012-62 m. in 1909. River transport has been of relatively little importance since the advent of railways.

Population.—The population of the state increased from 39,159 in 1880 to 243,329 in 1900, and to 376,053 in 1910. In 1900, 67,067 were foreign-born, 11,343 were Indians, 2441 Japanese, 1739 Chinese and 1523 negroes; most numerous among the foreign-born were 13,826 Canadians, 9436 Irish, 8077 English, 7162 Germans and 5346 Swedes. The Indians are mostly members of the following tribes: the Piegan, the Crow, the Salish (or Flathead), the Sioux, the Assiniboin, the Arapaho Atsina (miscalled Grosventres) and the Northern Cheyenne. The Piegans, with small remnants of a few other tribes, numbering (1900) about 2060, occupy the Blackfeet reservation in the north-west of Teton county, the Crows, numbering 1857, occupy the Crow reservation in the south central part of the state; the Salish, with small remnants of the Pend Oreille, the Spokane, the Lower Kalispell and the Kutenai, numbering 1837, occupy the Flathead reservation in the north of Missoula and the south of Flathead county; Assiniboin and others of Sioux stock, numbering about 1793, occupy Fort Peck reservation in the south-east of Valley county; Atsina and Assiniboin, numbering about 1420, occupy Fort Belknap reservation in the east of Chouteau county; and the Northern Cheyennes, numbering about 1357, occupy Northern Cheyenne reservation in the south-east of Rosebud county. Many of the Indians are engaged in stock-raising; the Crows have an irrigation system and are extensively engaged in farming. Roman Catholics are more numerous in Montana than Protestants, having 72,359 communicants out of a total of 98,984 of all denominations in 1906, when there were 7022 Methodists, 4096 Presbyterians, 3290 Protestant Episcopalians and 2029 Baptists. In 1900 the urban population (i.e. population of places having 4000 inhabitants or more) was 69,980; the semi-urban (i.e. population of incorporated places having less than 4000 inhabitants) was 30,270; and the rural (i.e. population outside of incorporated places) was 143,070. The rural population was therefore in that year 58.8% of the total, and the urban was only 28.7% of the total, but from 1890 to 1900 the urban increased 185% while the rural increased only 55.6%. The principal cities are: Butte, whose population increased from 10,723 in 1890 to 30,470 in 1900 and to 39,165 in 1910; Great Falls (1910) 13,948; Helena, the capital, (1910) 12,515; and Anaconda (1910) 10,134.

Administration.—The state is governed under a constitution adopted in 1889, a month before Montana's admission into the Union. The requirements for amending this constitution are: an affirmative vote in each house of the legislature of two-thirds of its members, followed, not less than three months later, by an affirmative vote of a majority of the electors voting thereon at a general election; or, by a like vote of each house of the legislature and of the electorate, a convention may be called to revise or amend it, a revision or amendment in this manner requiring the ratification of the electorate not less than two months nor more than six months after the adjournment of the convention. General suffrage is conferred on every male citizen of the United States who is twenty-one years of age and who has lived in the state one year, and in the county thirty days immediately preceding an election, the only exceptions being idiots or insane persons; a woman who has the qualifications for suffrage that are required of a man, may vote at any school district election

and if a tax-payer she may vote on all questions submitted to the tax-payers of the state or of any political division thereof.

The officers of the executive department are the governor, lieutenant-governor, secretary of state, attorney-general, treasurer, auditor and superintendent of public instruction, each of whom is elected for a term of four years. No person is eligible to any of these offices who shall not have lived within the state for two years next preceding the election; no person is eligible to the office of governor, lieutenant-governor, attorney-general or superintendent of public instruction who is not thirty years of age; no person is eligible to the office of secretary of state, treasurer or auditor who is not twenty-five years of age; no person is eligible to the office of attorney-general who has not been admitted to practice in the supreme court of the state; and the treasurer is ineligible to his office for the immediately succeeding term. The governor's powers are limited. As in other states he is commander-in-chief of the militia. With the advice and consent of the senate he appoints various administrative officers. With the approval of the majority of a board of pardons (composed of the secretary of state, attorney-general and auditor), he may pardon offences or commute punishment, and remit fines and forfeitures. He may veto any bill passed by the assembly, or in the case of a bill making appropriations of money he may veto any item of it, and no bill or item of an appropriation bill which he vetoes within five days (Sunday excepted) after it has been presented to him, can become a law or part of a law unless passed over his veto in each house by a two-thirds vote of the members present. Under an amendment to the Constitution adopted in 1906 his veto power does not extend to measures referred to the people by the legislative assembly or by initiative and referendum petitions. Without his approval, also, no order or resolution of either House, other than to adjourn or relating solely to the business of the assembly, can take effect until passed again by a two-thirds vote as in case of a bill.

The legislature consists of a senate and a house of representatives. Except when called in special session by the governor it meets (at Helena) on the first Monday of January in odd numbered years only, and the length of its session is limited by the constitution to sixty days. Senators are elected, one from each county, for a term of four years; representatives are elected, one or more from each county according to population, for a term of two years. The qualifications for a senator are that he be at least twenty-four years of age and have resided in his county or district at least one year next preceding his election; for a representative there are no qualifications other than those required for suffrage. The action of the legislature is much restricted by the constitution: a long list of cases is named in which that body is prohibited from passing any local or special laws; it is prohibited from delegating to any special commission power to perform any municipal functions whatever; from making any appropriations for charitable, industrial, educational or benevolent purposes to any person, corporation or community not under the absolute control of the state; and from authorizing the state to contract any debt or obligation in the construction of any railway, or to lend its credit in aid of such railway construction. In 1906 an amendment to art. 5, sec. 1 of the state constitution, authorized the initiative and referendum, but two-fifths of the entire number of counties must each furnish for initiative petitions signatures amounting in number to 8% of the whole number of votes cast for governor at the election last preceding the filing of the petition; for referendum petitions two-fifths of the counties must each furnish as signers 5% of the legal voters; and any measure referred to the people shall be in full force unless the petition for the referendum be signed by 15% of the legal voters (whose number is that of the total votes cast for governor, &c., as above) of a majority of the whole number of counties, but that in such case the law to be referred shall be inoperative until it is passed at the popular election.

The administration of justice is intrusted to a supreme court, an increasing number of district courts, and at least two justices'

courts in each organized township, besides police and municipal courts. The supreme court is composed of a chief justice and two associate justices elected for a term of six years. It holds four sessions a year at Helena and has both original and appellate jurisdiction. For most district courts there is only one judge, but for the more populous there are two; they are all elected for four years. These courts have original jurisdiction in cases at law and in equity in which the value in controversy exceeds \$50, in criminal cases amounting to felony, in all matters of probate, in actions for divorce, &c., and appellate jurisdiction in cases arising in the inferior courts. Justices of the peace are elected for two years and have civil jurisdiction in several classes of actions in which the amount demanded does not exceed \$300, and in such cases as petit larceny, assault in the third degree and breach of the peace.

For purposes of local government the state is divided into counties; each county into townships, school districts and road districts; and there are incorporated cities and towns. The county officers are a board of three commissioners, a treasurer, a sheriff, a county clerk, a clerk of the district court, an attorney, a surveyor, a coroner, a public administrator, an assessor, a superintendent of schools, and in some instances, an auditor. The commissioners are elected for six years, the other officers, for two years. Among the commissioners' powers and duties are: the management of county property; the levying of taxes; the equalizing of assessments; the division of the county into townships, school districts and road districts; the laying out and management of public highways and ferries, and the care of the poor. The township is of minor importance, its principal officers being two justices of peace and two constables. Municipal corporations are classified according to population; those having 10,000 inhabitants or more are cities of the first class; those having less than 10,000 but more than 5000 inhabitants, cities of the second class; those having less than 5000 but more than 1000 inhabitants, cities of the third class, and those having less than 1000 but more than 300 inhabitants towns. In a city of the first class, a mayor, two aldermen from each ward, a police judge, and a treasurer who may be *ex officio* tax-collector are elected, and an attorney, a clerk, a chief of police, an assessor, a street commissioner, a jailer, a surveyor, and, where there is a paid fire department, a chief engineer with one or more assistants, may be appointed by the mayor with the consent of the council. The officers of cities of the second and third class are the same, except that the clerk is *ex officio* assessor. In towns only a mayor and aldermen are elected, and the mayor with the consent of the council appoints a clerk who is *ex officio* assessor, a treasurer who is *ex officio* collector, and a marshal who may be *ex officio* street commissioner. The principal municipal officers hold office for two years.

A wife may hold property and make contracts as if she were single, and neither husband nor wife is accountable for the debts of the other. The husband is required to support himself and his wife if he is able to do so; if he is unable, his wife is required to assist him. On the death of either husband or wife at least one-third of his or her property passes to the other. Recognized causes for divorce are adultery, extreme cruelty, wilful desertion, wilful neglect, habitual intemperance or conviction for felony. The homestead of a head of a family consisting either of a farm not exceeding 160 acres or \$2500 in value, or of a house and lot—the lot not exceeding $\frac{1}{2}$ acre, and the house and lot not exceeding \$2500 in value—is secured against debtors except in case of judgments obtained before the homestead was recorded as such, in case of labourers', mechanics' or vendors' liens, and in case of a debt secured by mortgage; if the owner is a married person the homestead cannot be mortgaged without the consent of both husband and wife. For the settlement of disputes between labourers and employers there is a state board, appointed by the governor and consisting of an employer of labour, a labourer and a disinterested citizen. Upon application of either or both of the parties, provided the employees be not less than twenty, this board is required to inquire into the cause of the dispute, with the aid of two expert assistants, who shall be nominated by the parties, and to render a decision, which is binding for at least six months upon the parties to the application.

Charitable and Penal Institutions.—These are a state prison at Deer Lodge, managed by contract; a reformatory school at Miles City, an industrial school at Butte, an orphan's home at Twin Bridge, the soldiers' home at Columbia Falls, a school for deaf and blind

at Boulder, and an insane asylum at Warm Springs, managed by contract. They are all under the supervision of a state board of charities and reform. The state also has a bureau of child and animal protection.

Education.—The public school system is administered by state, county and district officers. The common school of each district is under the immediate supervision of a board of trustees; but a state text-book commission determines what text-books shall be used in the schools; the state superintendent of public instruction prepares the questions that are used in examining applicants to teach, passes judgment on publications for use in school libraries, and advises with the county superintendent of schools. A county board of education examines applicants for teachers' positions and pupils applying to enter high schools. The county superintendent advises the teachers, and holds teachers' institutes. Each school district is required by law to keep its school open at least three months a year and all children between the ages of eight and fourteen are required to attend for the full term; if unemployed they are required to continue in school until they have attained the age of sixteen. In 1908 fifteen of the counties had a county high school, and there were also 10 accredited city high schools in 1908. The state educational institutions are the university of Montana (1895), at Missoula, the normal college at Dillon, the college of agriculture and mechanic arts (1893) at Bozeman; and the school of mines (1900) at Butte. They are all under the supervision and control of the state board of education, which consists of the governor, the state superintendent, the attorney-general and eight other members appointed by the governor for a term of four years, two retiring annually. The entire educational system is maintained very largely out of funds derived from lands appropriated by Congress for that purpose.

Finance.—About one-half of the revenue for state and county purposes is derived from a general property tax. All taxable property in each county except that of railways in more than one county is assessed at its full value by the county assessor. The franchise, roadway, roadbed, rails and rolling stock of railways in more than one county are assessed at their full value by the state board of equalization. The assessment rolls of the county assessor are subject to alteration by the board of county commissioners sitting as a county board of equalization and the assessments as between counties are subject to alteration by the state board of equalization. The state legislature biennially fixes the rate of taxes for state purposes; the amount of this levy is now limited by the Constitution to $\frac{2}{3}$ mills on the dollar. The board of county commissioners fixes the rate of county taxes and levies those taxes; and the county treasurer collects the taxes of the state and those of the county. Among the other sources of revenue are a poll-tax of two dollars on each man between the ages of twenty-one and sixty, licences, an inheritance tax, rent of state lands and the income from invested funds received from the sale of state lands.

The state had a bonded debt in 1909 of \$384,000, authorized by popular vote in November 1908; by the constitution the aggregate indebtedness of the state was limited to \$100,000 except in case of war, invasion or insurrection, or in case a measure authorizing a greater indebtedness should be submitted by the legislature to the electorate and should receive a majority of the votes cast. The constitution limits the indebtedness of a county to 5% of the value of its taxable property and that of a city, town or school district to 3% except that the question may be submitted to a vote of the tax-payers affected when it is deemed necessary to construct a sewerage system or procure a water supply.

History.—The first exploration within the borders of Montana was made in 1743 by Sieur de la Verendrye, who in that year led an expedition up the Missouri river to the Great Falls and near where Helena now stands; the first exploration in that part of the state which lies west of the main range of the Rocky Mountains was made by Meriwether Lewis and William Clark in 1805. That part which lies east of the mountains was included in the Louisiana Purchase of 1803 and became successively a part of Missouri Territory in 1812, of Nebraska Territory in 1854, of Dakota Territory in 1861 and of Idaho Territory in 1863; that which lies west of the mountains became successively a part of Oregon Territory in 1848, of Washington Territory in 1853 and of Idaho Territory in 1863. In 1864 Montana Territory was created, and in 1889 this Territory was admitted to statehood. The report of Lewis and Clark attracted many traders and trappers, and within a few years the Missouri Fur Company, the Rocky Mountain Fur Company, the Hudson Bay Company and the American Fur Company had established fortified trading posts on the Missouri, the Yellowstone, the Marias, the Milk and other rivers; the most prominent among these was Fort Benton, which was established in 1846 at the head of navigation on the Missouri, and was made the headquarters of the American Fur Company. In 1841 Father

Peter John De Smet (1801-1872), a Belgian Jesuit missionary established Saint Mary's Mission in Bitter Root Valley, but, as the Indians repeatedly attacked the mission, it was abandoned in 1850. Fort Owen was, however, established in its place and continued for several years the chief settlement west of the mountains.

The development of Montana was scarcely begun when the discoveries of gold were made at Bannack, Beaverhead Valley, in 1862, at Virginia city, Alder Gulch, in 1863 and at Helena, Last Chance Gulch, in 1864. Several thousand people now rushed in, and before the Territorial government was created, the gold districts and the roads thereto suffered from a reign of lawlessness. The citizens organized a "vigilance committee" and hanged many of the outlaws. Many traders and trappers were butchered by the Indians, who became still more troublesome after the invasion of the Territory by the gold-seekers, and the surveying of railway routes had been undertaken. Treaties and military operations were at first of no avail, but in 1876 the United States government took steps to reduce them to submission, and Generals George Crook (1828-1890), Alfred Howe Terry (1827-1890) and John Gibbon (1827-1896), with 2700 troops (besides the Crow scouts) were sent against the Sioux under Sitting Bull, Crazy Horse and others. On the 17th of June General Crook with 1000 men defeated a large force of the Indians near the Rosebud river. On the 22nd of June General George A. Custer was sent up the Rosebud, and on the morning of the 25th passed over the divide of the Little Big Horn, where the Sioux were soon discovered. Custer divided his regiment into four commands, his own comprising 262 men. Continuing a few miles down stream, he came upon what was supposed to be a single Sioux village; the Indians, however, proved to number from 8000 to 10,000, including 2500 to 3000 warriors. Custer was soon completely surrounded and the entire command, save a single Crow scout, was slaughtered. This was, however, the beginning of the end of the Indian troubles. On the 29th of September a band under American Horse was defeated and their leader killed; in October some 5000 Indians surrendered; and on the 22nd of April 1877, 2000 more under Crazy Horse laid down their arms. General Crook and Colonel Nelson A. Miles especially distinguished themselves. In October 1877 the Nez Percés under Chief Joseph after a masterly retreat from Idaho of over 1000 m., probably unequalled in Indian warfare, were hemmed in by greatly superior forces and captured in the Bear Paw Mountains in Chouteau county.

In most of the territorial or state elections the Democrats, or the Democrats and Populists united, have been triumphant, a Republican governor having been elected only in 1892; but the contests have often been ardent and bitter. In 1889 the Democrats were charged with fraud in the 34th election precinct of Silverbow county, and, the dispute remaining unsettled, two legislatures were seated. Each legislature elected two senators to the United States Senate, which, having a Republican majority, seated the Republicans. More notable, however, was the feud between W. A. Clark and Marcus Daly, both Democrats. William Andrews Clark (b. 1830) removed in 1856 from Pennsylvania to Iowa, in 1862 to Colorado and in 1863 to Montana, where he became the wealthiest mine-owner. Marcus Daly (1842-1900) went from Ireland about 1857 to New York City, and thence to California and Nevada, and in 1876 reached Butte, Montana. In 1882 he discovered one of the richest copper deposits in the world. Clark aspired to be a United States senator, but by ridiculing Daly, provoked a powerful opposition. Clark was one of the two Democratic claimants who had been denied a seat in the senate in 1890. Three years later he was again nominated, but Daly prevented his election. Clark secured his election to the senate in 1899, but Daly furnished to the Committee on Elections and Privileges such evidence of bribery and fraud that it decided against seating him. Daly died on the 12th of November 1900, and in 1901 Clark was elected senator for the full term, which expired in 1907, when he was succeeded by Joseph Moore Dixon (b. 1867), a Republican.

The governors of **Montana** have been as follows:—
Territorial.

Sidney Edgerton	1864-1865
Thomas Meagher (acting)	1865-1866
Green Clay Smith	1866-1869
James Monroe Ashley	1869-1870
Benjamin F. Potts	1870-1883
John Schuyler Crosby	1883-1884
B. Platt Carpenter	1884-1885
Samuel Thomas Hauser	1885-1887
Preston Hopkins Leslie	1887-1889
Benjamin F. White	1889-

State.

Joseph Kemp Toole	Democrat	1889-1893
John Ezra Rickards	Republican	1893-1897
Robert Burns Smith	Democrat and Populist	1897-1901
Joseph Kemp Toole	Democrat	1901-1909
Edwin L. Norris	"	1909-

BIBLIOGRAPHY.—United States Geographical and Geological Survey of the Territories (Washington, 1872-1874); material indexed in the various bibliographies (e.g. Bulletin 301) of the U.S. Geological Survey; *Annual Reports of the Bureau of Agriculture, Labor and Industry of the State of Montana*; Samuel Fortier, *Irrigation in Montana* (Washington, 1906), being Bulletin No. 172 (revised) of the U.S. Department of Agriculture, office of Experiment Stations; the *Reports of the United States Census*; H. H. Bancroft, *The History of Washington, Idaho and Montana* (San Francisco, 1890); Joaquin Miller, *An Illustrated History of the State of Montana* (Chicago, 1884); M. J. Larsen (ed.), *History of Montana* (Chicago, 1885); Alice Harriman, *Pacific History Stories*, Montana Edition (San Francisco, 1903); Robert Vaughn, *Then and Now; or Thirty-six Years in the Rockies* (Minneapolis, 1900); T. J. Dinsdale, *The Vigilantes of Montana* (Virginia City, 1866), and the *Contributions to the Historical Society of Montana* (Helena, 1876 sqq.).

MONTANELLI, GIUSEPPE (1813-1862), Italian statesman and author, was born at Fucecchio in Tuscany, and in 1840 was appointed law professor at Pisa. He contributed to the *Antologia*, a celebrated Florentine review, and in 1847 founded a newspaper called *L'Italia*, the programme of which was "Reform and Nationality." In 1848 Montanelli served with the Tuscan student volunteers at the battle of Curtatone, where he was wounded and taken prisoner by the Austrians. On being liberated he returned to Tuscany, and the grand duke Leopold II, knowing that he was popular with the masses, sent him to Leghorn to quell the disturbances. In October, Leopold, much against his inclinations, asked him to form a Ministry. He accepted, and on the 10th of January 1849, induced the grand duke to establish a national constituent assembly. But Leopold, alarmed at the turn affairs were taking, fled from Florence, and Montanelli, Guerrazzi and Mazzini were elected "triumvirs" of Tuscany. Like Mazzini, Montanelli advocated the union of Tuscany with Rome. But after the restoration of the grand duke, Montanelli, who was in Paris, was tried and condemned by default; he remained some years in France, where he became a partizan of Napoleon III. On the formation of the kingdom of Italy he returned to Tuscany and was elected member of parliament; he died in 1862. He was an enthusiastic, but a fickle and ambitious demagogue, and he achieved a better reputation as a writer.

His most important literary work is his *Memorie sull'Italia e specialmente sulla Toscana dal 1814 al 1850*, in 2 vols. (Turin, 1853); he also wrote *Il Partito nazionale italiano* (Turin, 1856), *L'Impero, il papato, e la democrazia in Italia* (Florence, 1859); and *Dell'ordinamento nazionale in Italia* (Florence, 1862). His dramatic poem *La Tentazione* and his tragedy *Cammeo* achieved some success in their day. See Assunta Marradi, *G. Toscanelli e la Toscana dal 1815 al 1862* (Rome, 1909).

MONTANES, JUAN MARTINEZ (c. 1580-1649), Spanish sculptor, was born at Alcalá-la-real, in the province of Granada. His master was Pablo de Roxas, his first known work (1607) being a boy Christ, now in the sacristy of the *capella antigua* in the cathedral of Seville. The great altar at Santiponce near Seville, was completed in 1812. Montañes executed most of his sculpture in wood, covered with a surface of polished gold, and coloured. Other works were the great altars at Santa Clara in Seville and at San Miguel in Jerez, the Conception and the realistic figure of Christ crucified, in the Seville cathedral; the figure of St John the Baptist, and the St Bruno (1620); a tomb for Don Perez de Guzman and his wife (1619); the St

Ignatius and the St Francis of Borja in the university church of Seville. Montañes died in 1649, leaving a large family. His works are more realistic than imaginative, but this, allied with an impeccable taste, produced remarkable results. The equestrian statue of King Philip IV., cast in bronze by Pietro Tacca in Florence and now in Madrid, was modelled by Montañes. He had many imitators, his son Alonzo Martínez, who died in 1668, being among them.

See B. Haendcke, *Studien zur Geschichte der spanischen Plastik* (Strassburg, 1900); F. Gómez, *Historia de la escultura en España* (Madrid, 1888).

MONTANISM, a somewhat misleading name for the movement in the 2nd century which, along with Gnosticism, occupied the most critical period in the history of the Early Church. It was the overthrow of Gnosticism and Montanism that made the "Catholic" Church. The credit of first discerning the true significance of the Montanistic movement belongs to Ritschl.¹ In this article an account will be given of the general significance of Montanism in relation to the history of the Church in the 2nd century, followed by a sketch of its origin, development and decline.

1. From the middle of the 2nd century a change began to take place in the outward circumstances of Christianity. The Christian faith had hitherto been maintained in a few small congregations scattered over the Roman Empire. These congregations were provided with only the most indispensable constitutional forms ("Corpus summe de conscientia religionis, de unitate disciplinae, de spei foedere"). This state of things passed away. The Churches soon found numbers within their pale who stood in need of supervision, instruction and regular control. The enthusiasm for a life of holiness and separation from the world no longer swayed all minds. In many cases sober convictions or submissive assent supplied the want of spontaneous enthusiasm. There were many who did not *become*, but who *were*, and therefore remained, Christians. Then, in addition to this, Christians were already found in all ranks and occupations—in the Imperial palace, among the officials, in the abodes of labour and the halls of learning, amongst slaves and freemen. Should the Church take the decisive step into the world, conform to its customs, and acknowledge as far as possible its authorities? Or ought she, on the other hand, to remain a society of religious devotees, separated and shut out from the world? That this was the question at issue is obvious enough now, although it could not be clearly perceived at the time. It was natural that warning voices should then be raised in the Church against secular tendencies, that the well-known counsels about the imitation of Christ should be held up in their literal strictness before worldly Christians. The Church as a whole, however, under pressure of circumstances rather than by a spontaneous impulse, decided otherwise. She marched through the open door into the Roman state, and settled down there to Christianize the state by imparting to it the word of the Gospel, but at the same time leaving it everything except its gods. On the other hand, she furnished herself with everything of value that could be taken over from the world without overstraining the elastic structure of the organization which she now adopted. With the aid of its philosophy she created her new Christian theology; its polity furnished her with the most exact constitutional forms; its jurisprudence, its trade and commerce, its art and industry, were all taken into her service; and she contrived to borrow some hints even from its religious worship. With this equipment she undertook, and carried through, a world-mission on a grand scale. But believers of the old school protested in the name of the Gospel against this secular Church. They joined an enthusiastic movement which had originated in a remote province, and had at first a merely local importance. There, in Phrygia, the cry for a strict Christian life was reinforced by the belief in a new and final outpouring of the Spirit—a coincidence which has been observed elsewhere in Church history—as, for instance, among the early Quakers and in the Irvingite movement. These

¹ *Entstehung der altkatholischen Kirche*, 2nd ed. Bonn. (1857).

zealots hailed the appearance of the Paraclete in Phrygia, and surrendered themselves to his guidance. In so doing, however, they had to withdraw from the Church, to be known as "Montanists," or "Kataphrygians," and thus to assume the character of the sect. Their enthusiasm and their prophesying were denounced as demoniacal; their expectation of a glorious earthly kingdom of Christ was stigmatized as Jewish, their passion for martyrdom as vainglorious and their whole conduct as hypocritical. Nor did they escape the more serious imputation of heresy on important articles of faith; indeed, there was a disposition to put them on the same level with the Gnostics. The effect on themselves was what usually follows in such circumstances. After their separation from the Church, they became narrower and pettier in their conception of Christianity. Their asceticism degenerated into legalism, their claim to a monopoly of pure Christianity made them arrogant. As for the popular religion of the larger Church, they scorned it as an adulterated, manipulated Christianity. But these views found very little acceptance in the 3rd century, and in the course of the 4th they died out.

2. Such is, in brief, the position occupied by Montanism in the history of the ancient Church. The rise and progress of the movement were as follows.

At the close of the reign of Antoninus Pius—probably in the year 156 (Epiphanius)—Montanus appeared at Ardabau in Mysia, near the Phrygian border, bringing revelations of the "Spirit" to Christendom. Montanus claimed to have a prophetic calling in the very same sense as Agabus, Judas, Silas, the daughters of Philip, Quadratus and Ammia, or as Hermas at Rome. At a later time, when the validity of the Montanistic prophecy was called in question, the adherents of the new movement appealed explicitly to a sort of prophetic succession, in which their prophets had received the same gift which the daughters of Philip, for example, had exercised in that very country of Phrygia. The burden of the new prophecy seems to have been a new standard of moral obligations, especially with regard to marriage, fasting and martyrdom. But Montanus had larger schemes in view. He wished to organize a special community of true Christians to wait for the coming of their Lord. The small Phrygian towns of Pepuza and Tymion were selected as the headquarters of his church. Funds were raised for the new organization, and from these the leader and missionaries, who were to have nothing to do with worldly life, drew their pay. Only two women, Prisca and Maximilla, were moved by the Spirit; like Montanus, they uttered in a state of frenzy the commands of the Spirit, which urged men to a strict and holy life. This does not mean that visions and significant dreams may not have been of frequent occurrence in Montanistic circles.¹

For twenty years this agitation appears to have been confined to Phrygia and the neighbouring provinces. But after the year 177 a persecution of Christians broke out simultaneously in many provinces of the Empire. Like every other persecution it was regarded as the beginning of the end. It would seem that before this time Montanus had disappeared from the scene; but Maximilla, and probably also Prisca, were working with redoubled energy. And now, throughout the provinces of Asia Minor, in Rome, and even in Gaul, amidst the raging of persecution, attention was attracted to this remarkable movement. The desire for a sharper exercise of discipline, and a more decided renunciation of the world, combined with a craving for some plain indication of the Divine will in these last critical times, had prepared many minds for an eager acceptance of the tidings from Phrygia. And thus, within the large congregations where there was so much that was open to censure in doctrine and constitution and morals, conventicles were formed in order that Christians might prepare themselves by strict discipline for the day of the Lord.

¹ Theodotus, "the first steward of the New Prophecy," was a fellow-worker with Montanus, and almost certainly a prophet. Later on, Firmilian, writing to Cyprian, mentions a prophetess who appeared in Cappadocia about A.D. 236, and Epiphanius (*Hæc.* 49) tells of another called Quintilla.—(Ed.)

Meanwhile in Phrygia and its neighbourhood—especially in Galatia, and also in Thrace—a controversy was raging between the adherents and the opponents of the new prophecy. Between 150 and 176 the authority of the episcopate had been immensely strengthened, and along with it a settled order had been introduced into the Churches. As a rule, the bishops were resolute enemies of the Montanistic enthusiasm. It disturbed the peace and order of the congregations, and threatened their safety. Moreover, it made demands on individual Christians such as very few could comply with. But the disputation which Bishops Zoticus of Cumana and Julian of Apamea arranged with Maximilla and her following turned out disastrously for its promoters. The "spirit" of Maximilla gained a signal victory, a certain Themiso in particular having reduced the bishops to silence. Sotas bishop of Anchialus attempted to refute Prisca, but with no better success (Eusebius, *Hist. eccl.* v. 19). These proceedings were never forgotten in Asia Minor, and the report of them spread far and wide. In after times the only way in which the discomfiture of the bishops could be explained was by asserting that they had been silenced by fraud or violence. This was the commencement of the excommunication or secession of the Montanists in Asia Minor. Not only did an extreme party arise in Asia Minor rejecting all prophecy and the Apocalypse of John along with it, but the majority of the Churches and bishops in that district appear (c. 178) to have broken off all fellowship with the new prophets, while books were written to show that the very form of the Montanistic prophecy was sufficient proof of its spuriousness.² In Gaul and Rome the prospects of Montanism seemed for a while more favourable. The confessors of the Gallican Church at Lyons were of opinion that communion ought to be maintained with the zealots of Asia and Phrygia; and they addressed a letter to this effect to the Roman bishop, Eleutherus. There was a momentary vacillation even in Rome. Nor is this to be wondered at. The events in Phrygia could not appear new and unprecedented to the Roman Church. If we may believe Tertullian, it was Praxeas of Asia Minor, the relentless foe of Montanism, who succeeded in persuading the Roman bishop to withhold his letters of conciliation.³

Early in the last decade of the 2nd century two considerable works⁴ appeared in Asia Minor against the Kataphrygians. The first, by a bishop or presbyter whose name is not known, is addressed to Abircius bishop of Hierapolis, and was written in the fourteenth year after the death of Maximilla—i.e. apparently about the year 193. The other was written by a certain Apollonius forty years after the appearance of Montanus, consequently about 196. From these treatises we learn that the adherents of the new prophecy were very numerous in Phrygia, Asia and Galatia (Ancyra), that they had tried to defend themselves in writing from the charges brought against them (by Miltiades), that they possessed a fully developed independent organization, that they boasted of many martyrs, and that they were still formidable to the Church in Asia Minor. Many of the small congregations had gone completely over to Montanism, although in large towns, like Ephesus, the opposite party maintained the ascendancy. Every bond of intercourse was broken, and in the Catholic Churches the worst calumnies were retailed about the deceased prophets and the leaders of the societies they had founded. In many Churches outside of Asia Minor a different state of matters prevailed. Those who accepted the message of the new prophecy did not at once leave the Catholic Church in a body. They simply formed small conventicles within the Church. Such, for example, appears to have been the case in Carthage (if we may judge from the Acts of the martyrs Perpetua and Felicitas) at the commencement of the persecution of Septimius Severus about the year 202. But even here it was impossible that an open rupture

² Miltiades, περί τοῦ μή δεῖν προφήτην ἐκκοινοῦσαι λαλεῖν. At the same time as Miltiades, if not earlier, Apollinaris of Hierapolis also wrote against the Montanists.

³ It was Zephyrinus in A.D. 202 who took the decisive step of refusing to communicate with the Asiatic Montanists.—(Ed.)

⁴ Quoted in Eusebius, *Hist. Eccl.* v. 16-18.

should be indefinitely postponed. The bishops and their flocks gave offence to the spiritualists on so many points that at last it could be endured no longer. The latter wished for more fasting, the prohibition of second marriages, a frank, courageous profession of Christianity in daily life, and entire separation from the world; the bishops, on the other hand, sought to make it as easy as possible to be a Christian, lest they should lose the greater part of their congregations. And lastly, the bishops were compelled more and more to take the control of discipline into their own hands, while the spiritualists insisted that God Himself was the sole judge in the congregation. On this point especially a conflict was inevitable. It is true that there was no rivalry between the new organization and the old, as in Asia and Phrygia, for the Western Montanists recognized in its main features the Catholic organization as it had been developed in the contest with Gnosticism; but the demand that the "organs of the Spirit" should direct the whole discipline of the congregation contained implicitly a protest against the actual constitution of the Church. Even before this latent antagonism was made plain there were many minor matters which were sufficient to precipitate a rupture in particular congregations. In Carthage, for example, it would appear that the breach between the Catholic Church and the Montanistic conventicle was caused by a disagreement on the question whether or not virgins ought to be veiled. For nearly five years (202-207) the Carthaginian Montanists strove to remain within the Church, which was as dear to them as it was to their opponents. But at length they quitted it, and formed a congregation of their own.

It was at this juncture that Tertullian, the most famous theologian of the West, left the Church whose cause he had so manfully upheld against pagans and heretics. He too had come to the conviction that the Church had forsaken the old paths and entered on a way that must lead to destruction. The writings of Tertullian afford the clearest demonstration that what is called Montanism was, at any rate in Africa, a reaction against secularism in the Church. There are other indications that Montanism in Carthage was a very different thing from the Montanism of Montanus. Western Montanism, at the beginning of the 3rd century, admitted the legitimacy of almost every point of the Catholic system. It allowed that the bishops were the successors of the apostles, that the Catholic rule of faith was a complete and authoritative exposition of Christianity, and that the New Testament was the supreme rule of the Christian life. Montanus himself and his first disciples had been in quite a different position. In his time there was no fixed, divinely instituted congregational organization, no canon of New Testament Scriptures, no anti-Gnostic theology, and no Catholic Church. There were simply certain communities of believers bound together by a common hope, and by a free organization, which might be modified to any required extent. When Montanus proposed to summon all true Christians to Pepusa, in order to live a holy life and prepare for the day of the Lord, there was nothing whatever to prevent the execution of his plan except the inertia and lukewarmness of Christendom. But this was not the case in the West at the beginning of the 3rd century. At Rome and Carthage, and in all other places where sincere Montanists were found, they were confronted by the imposing edifice of the Catholic Church, and they had neither the courage nor the inclination to undermine her sacred foundations. This explains how the later Montanism never attained a position of influence. In accepting, with slight reservations, the results of the development which the Church had undergone during the fifty years from 160 to 210 it reduced itself to the level of a sect. Tertullian exhausted the resources of dialectic in the endeavour to define and vindicate the relation of the spiritualists to the "psychic" Christians; but no one will say he has succeeded in clearing the Montanistic position of its fundamental inconsistency.

Of the later history of Montanism very little is known. But it is at least a significant fact that prophecy could not be resuscitated. Montanus, Prisca, and Maximilla were always

recognized as the inspired authorities. At rare intervals a vision might perhaps be vouchsafed to some Montanistic old woman, or a brother might now and then have a dream that seemed to be of supernatural origin; but the overmastering power of religious enthusiasm was a thing of which the Montanists knew as little as the Catholics. Their discipline was attended with equally disappointing results. In place of an intense moral earnestness, we find in Tertullian a legal casuistry, a finical morality, from which no good could ever come. It was only in the land of its nativity that Montanism held its ground till the 4th century. It maintained itself there in a number of close communities, probably in places where no Catholic congregation had been formed; and to these the Novatians at a later period attached themselves. In Carthage there existed down to the year 400 a sect called Tertullianists; and in their survival we have a striking testimony to the influence of the great Carthaginian teacher. On doctrinal questions there was no real difference between the Catholics and the Montanists. The early Montanists (the prophets themselves) used expressions which seem to indicate a Monarchian conception of the person of Christ. After the close of the 2nd century we find two sections amongst the Western Montanists, just as amongst the Western Catholics—there were some who adopted the Logos-Christology, and others who remained Monarchians.¹

SOURCES.—The materials for the history of Montanism, although plentiful, are fragmentary, and require a good deal of critical sifting. They may be divided into four groups: (1) The utterances of Montanus, Prisca and Maximilla² are our most important sources, but unfortunately they consist of only twenty-one short sayings. (2) The works written by Tertullian after he became a Montanist furnish the most copious information—not, however, about the first stages of the movement, but only about its later phase, after the Catholic Church was established. (3) The oldest polemical works of the 2nd century, extracts from which have been preserved, especially by Eusebius (*Hist. Eccles.* bk. v.), form the next group. These must be used with the utmost caution, because even the earliest orthodox writers give currency to many misconceptions and calumnies. (4) The later lists of heretics, and the casual notices of Church fathers from the 3rd to the 5th century, though not containing much that is of value, yet contain a little.³

¹ It is evident that Montanism was by no means homogeneous. Too often the primitive "heresy of the Phrygians" has been studied in the light of the matured system of Tertullian. One great divergence is manifest: Tertullian never himself deviated from orthodoxy and vehemently asserts the orthodoxy of all Montanists, but both Montanus ("I am the Father and the Son and the Holy Ghost") and Maximilla ("I am Word and Spirit and Power") used language which has a distinctly "monarchian" flavour. There were really divided views on the question of the Divine Monarchy among the Montanists as among the Catholics. The orthodox party were known as the Cataproclans, the heterodox as Cataeschinites, and both appealed to the oracles of their prophets. Other influences tending to diversity were the rise of later prophets and visionaries, the personality of prominent members of the sect (like Tertullian himself, who gave to Montanism much more than he received from it), and the power of local environment. An examination of Phrygian as distinct from African Montanism leads to the following conclusions: (1) the Phrygians claimed to have received the prophetic gift by way of succession just as the bishops traced their office back to the apostles; Tertullian seems to ignore the intermediate steps between the apostles and Montanus; (2) the "ecstasy" of the African section was much more restrained than the ravings of the Phrygians; (3) the original Montanists followed the example of the Phrygian native cults in assigning a prominent place to women, Tertullian on the other hand (*De virg. vel.* 9) says, "It is not permitted to a woman to speak in church, nor yet to teach, nor to baptize, nor to offer, nor to assume any office which belongs to a man, least of all the priesthood"; (4) while both sections gave to prophets the power of abjuration, the Phrygians extended it to martyrs also—at Carthage the Catholics did this contrary to the views of Tertullian. There is also good reason to doubt whether the Phrygian Montanists were anything like so ascetic and desirous of martyrdom as has been generally considered. Apollonius (Eusebius, *Hist. Eccles.* v. 16) accuses them of covetousness and tells us that Themiso purchased his freedom from imprisonment by a considerable payment. Sir William Ramsay has also shown that martyrdoms in Phrygia were rare during the end of the 2nd and the whole of the 3rd century, a spirit of religious compromise prevailing between the Christian and pagan populations (see a paper by H. J. Lawlor in the *Journal of Theological Studies* for July, 1908, vol. 481).

² Collected by Minter and by Bonwetsch, *Geschichte des Montanismus*, p. 197.

³ On the sources see Bonwetsch, op. cit. pp. 16-55.

LITERATURE.—Ritschl's investigations, referred to above, supersede the older works of Tillemont, Wernsdorf, Mosheim, Walch, Neander, Baur and A. Schwieger (*Der Montanismus und die christliche Kirche des zten Jahrhunderts*, Tübingen, 1841). The later works, of which the best and most exhaustive is that of N. Bonwetsch, *Die Geschichte des Montanismus* (1881), all follow the lines laid down by Ritschl. See also Gottwald, *De montanism Tertulliani* (1862); Réville, "Tertullien et le montanisme" in the *Revue des deux mondes* (Nov. 1, 1864); Stroelin, *Essai sur le montanisme* (1870); De Vos, *Montanisme and the Primitive Church* (London, 1878); W. Cunningham, *The Churches of Asia* (London, 1880); Renan, "Les Crises du Catholicisme Naissant" in *Rev. d. deux mondes* (Feb. 15, 1881); H. Weinel, *Die Wirkungen des Geistes und der Geister im nachapostol. Zeitalter* (Freiburg, 1899); G. G. Selwyn, *The Christian Prophets* (London, 1900); Bonwetsch, art. "Montanismus" in Hauck-Herzog's *Realencyklopädie*. Special points of importance in the history of Montanism have been investigated by Lipsius, Overbeck, Weissäcker (*Theol. Lit.-Zeitung*, Nov. 4, 1882), Harnack, *Das Mönchtum, seine Ideale und seine Geschichte*, 2nd ed., 1882; Eng. trans., 1901; and *Z. f. Kirchengesch.* iii. 367-408), and H. J. Lawlor. Weissäcker's short essays are extremely valuable, and have elucidated several important points previously overlooked. (A. HA.)

MONTARGIS, a town of central France, capital of an arrondissement in the department of Loiret, 47 m. E.N.E. of Orléans by rail. Pop. (1906), 11,038. The town is traversed by the Vernisson, by numerous arms of the Loing, and by the Briare canal, which unites with the canal of Orléans a little below it. It has a church (St Madeleine), dating in part from the 12th century and including a fine choir of Renaissance architecture, and still preserves portions of its once magnificent castle (12th to 15th centuries), which, previous to the erection of Fontainebleau, was a favourite residence of the royal family. A handsome modern building contains the town-hall, public library, and museum; in the courtyard is a bronze group, "The Dog of Montargis"; the town has a statue of Mirabeau, born in the neighbourhood. Montargis is the seat of a sub-prefecture, and has tribunals of first instance and of commerce and colleges for both sexes. It manufactures paper, gold chains, rubber, tar, asphalt, chemical manures, woodwork and leather. The town is an agricultural market, and its port has trade in coal, timber, sheep and farm produce.

Montargis was formerly the capital of the Gâtinais. Having passed in 1188 from the Courtenay family to Philip Augustus, it long formed part of the royal domain. In 1528 Francis I. gave it as dowry to Renée d'Este, daughter of Louis XII., the famous Huguenot princess; from her it passed to her daughter Anne, and through her to the dukes of Guise; it was repurchased for the Crown in 1612. From 1626 till the Revolution the territory was the property of the house of Orléans. Montargis was several times taken or attacked by the English in the 15th century, and is particularly noted for its successful defence in 1427. Both Charles VII. and Charles VIII. held court in the town; it was the latter who set the famous Dog of Montargis to fight a duel with his master's murderer whom he had tracked and captured.

MONTAUBAN, ARTHUR DE (d. 1479), French magistrate and prelate, belonged to one of the great families of Brittany. To satisfy a private grudge against Gilles, brother of Duke Francis II. of Brittany, he intrigued to such good purpose that Gilles was arraigned for treason, and finally assassinated in prison in 1450. When Montauban's duplicity was discovered he was deprived of his office of *bailli* of Cotentin and banished. He then turned monk, and through the support of his brother, John de Montauban (1412-1466), Louis XI.'s favourite, obtained the archbishopric of Bordeaux in 1468. He died in Paris on the 9th of March 1479.

MONTAUBAN, a town of south-western France, capital of Tarn-et-Garonne, 31 m. N. of Toulouse by the Southern railway. Pop. (1906), town, 16,813; commune, 28,688. The town, built mainly of a reddish brick, stands on the right bank of the Tarn at its confluence with the Tescou. Its fortifications have been replaced by boulevards beyond which extend numerous suburbs, while on the left bank of the Tarn is the suburb of Villebourbon, which is connected with the town by a remarkable bridge of the early 14th century. It is a brick structure over 200 yds. in length, and though its fortified towers have disappeared it is

otherwise in good preservation. The hôtel de ville, on the site of a castle of the counts of Toulouse and once the residence of the bishops of Montauban, stands at the east end of the bridge. It belongs chiefly to the 17th century, but some portions are much older, notably an underground chamber known as the Hall of the Black Prince. Besides the municipal offices it contains a valuable library, and a museum with collections of antiquities and pictures. The latter comprise most of the work (including his "Jesus among the Doctors") of Jean Ingres, the celebrated painter, whose birth in Montauban is commemorated by an elaborate monument. The Place Nationale is a square of the 17th century, entered at each corner by gateways giving access to a large open space surrounded by houses carried on double rows of arcades. The prefecture, the law-courts and the remaining public buildings are modern. The chief churches of Montauban are the cathedral, remarkable only for the possession of the "Vow of Louis XIII." one of the masterpieces of Ingres, and the church of St Jacques (14th and 15th centuries), the façade of which is surmounted by a handsome octagonal tower. Montauban is the seat of a bishop, a prefect and a court of assize. It has tribunals of first instance and of commerce, a chamber of commerce and a board of trade arbitration, lycées and a training college, schools of commerce and viticulture, a branch of the Bank of France, and a faculty of Protestant theology. The commercial importance of Montauban is due rather to its trade in agricultural produce, horses, game and poultry, than to its industries, which include nursery-gardening, cloth-weaving, cloth-dressing, flour-milling, wood-sawing, and the manufacture of furniture, silk-gauze and straw hats. The town is a junction of the railways of the Southern and Orléans companies, and communicates with the Garonne by the Canal of Montech.

With the exception of Mont-de-Marsan, Montauban is the oldest of the *bastides* of southern France. Its foundation dates from 1144 when Alphonse Jourdain, count of Toulouse, granted it a liberal charter. The inhabitants were drawn chiefly from Montauriol, a village which had grown up around the neighbouring monastery of St Théodard. In the 13th century the town suffered much from the ravages of the Albigensians and from the Inquisition, but by 1317 it had recovered sufficiently to be chosen by John XXII. as the head of a diocese of which the basilica of St Théodard became the cathedral. By the treaty of Brétigny (1360) it was ceded to the English; but in 1414 they were expelled by the inhabitants. In 1560 the bishops and magistrates embraced Protestantism, expelled the monks, and demolished the cathedral. About ten years later it became one of the Huguenot strongholds, and formed a small independent republic. It was the headquarters of the Huguenot rebellion of 1621, and was vainly besieged by Louis XIII. for eighty-six days; nor did it submit until after the fall of La Rochelle in 1629, when its fortifications were destroyed by Richelieu. In the same year the plague cut off over 6000 of its inhabitants. The Protestants again suffered persecution after the repeal of the Edict of Nantes.

MONTAUSIER, CHARLES DE SAINTE-MAURE, Duc DE (1610-1690), French soldier, was born on the 6th of October 1610, being the second son of Léon de Sainte-Maure, baron de Montausier. His parents were Huguenots, and he was educated at the Protestant College of Sedan under Pierre du Moulin. He served brilliantly at the siege of Casale in 1630. Becoming marquis de Montausier by the death of his elder brother in 1635, he was the recognized aspirant for the hand of Mme de Rambouillet's daughter Julie Lucine d'Angennes (1607-1671). Having served under Bernard of Saxe-Weimar in Germany in 1634 he returned to the French service in 1636, and fought in the Rhenish campaigns of the following years. He was taken prisoner at Rantzau in November 1643, and only ransomed after ten months' captivity. On his return to France he became a lieutenant-general. On the 15th of July 1645 he married "the incomparable Julie," thus terminating a courtship famous in the annals of French literature because of the *Guirlande de Julie*, a garland of verse consisting of madrigals by Montausier, Jean Chapelain, Guillaume Colletet, Claude de

Malleville, Georges de Scudéry, Pierre Corneille (if M. Uzanne is correct in the attribution of the poems signed M.C.), Philippe Hubert, Simon Arnould de Pomponne,¹ Jean Desmarets de Saint Sorlin, Antoine Gombaud (*le nain de la Princesse Julie*) and others. It was copied by the famous calligraphist N. Jarry in a magnificent MS., on each page of which was painted a flower, and was presented to Julie on her fête day in 1641. The MS. is now in possession of the Uzès family, to whom it passed by the marriage of Julie's daughter to Emmanuel de Crussol, duc d'Uzès.

Montausier had bought the governorship of Saintonge and Angoumois, and became a Roman Catholic before his marriage. During the Fronde he remained, in spite of personal grievances against Mazarin, faithful to the Crown. On the conclusion of peace in 1653 the marquis, who had been severely wounded in 1652, obtained high favour at court in spite of the roughness of his manners and the general austerity which made the Parisian public recognize him as the original of Alceste in the *Misanthrope*. Montausier received from Louis XIV. the order of the Saint Esprit, the government of Normandy, a dukedom, and in 1668 the office of governor of the dauphin, Louis. He initiated the series of classics *Ad usum Delphini*, directed by the learned Huet, and gave the closest attention to the education of his charge, who was only moved by his iron discipline to a hatred of learning. Court gossip assigned some part of Montausier's favour to the complaisance of his wife, who, appointed lady-in-waiting to the queen in 1664, favoured Louis XIV.'s passion for Louise de la Vallière, and subsequently protected Mme de Montespan, who found a refuge from her husband with her. He died on the 17th of November 1690.

See Père Nicolas Petit, *Vie du duc de Montausier* (1729); Puget de Saint Pierre, *Histoire du duc de Montausier* (1784); Amédée Roux, *Un Misanthrope à la cour de Louis XIV.* Montausier (1860); O. Uzanne, *La Guirlande de Julie* (1875); E. Fichère, *Oraisons funèbres du duc et de la duchesse de Montausier* (Paris, 1691); and contemporary memoirs.

MONTBÉLIARD, a town of eastern France, capital of an arrondissement in the department of Doubs, 49 m. N.E. of Besançon on the Paris-Lyon line between that town and Belfort. Pop. (1906), town, 8723; commune, 10,455. Montbéliard is situated 1050 ft. above sea-level on the right bank of the Allaine at its junction with the Luzine (Lizaine or Lisaine). It is an important point in the frontier defences of France since 1871. Forts on outlying hills connect it with Belfort on the one side and (through Blamont and the Lomont fortifications) with Besançon on the other. The old castle of the counts of Montbéliard is now used as barracks; its most conspicuous features, the Tour Bossue and the Tour Neuve, date respectively from 1425 and 1504. Most of the inhabitants are Protestant, and the church of St Martin, built early in the 17th century, now serves as a Protestant place of worship. The old market-hall and some old houses of the 16th century also remain. A bronze statue of George Cuvier, the most illustrious native of Montbéliard, and several fountains adorn the town. Montbéliard is the seat of a sub-prefect and has a tribunal of first instance, a board of trade-arbitrators, a communal college, a practical school of industry, a chamber of arts and manufactures and a museum of natural history. Since 1870 a considerable impetus has been given to its prosperity by the Alsatian immigrants. Its industries include watch and clock making and dependent trades, cotton spinning and weaving, the manufacture of hosiery, textile machinery, tools, nails and wire, and brewing. There is commerce in wine, cheese, wood and Montbéliard cattle.

After belonging to the Burgundians and Franks, Montbéliard (*Mons Peligardi*) was, by the treaty of Verdun (843), added to Lorraine. In the 11th century it became the capital of a county, which formed part of the second kingdom of Burgundy and latterly of the German Empire. Its German name is Mûmpelgard. In 1397 it passed by marriage to the house of Württemberg, to whom it belonged till 1793. It resisted the attacks of Charles the Bold (1473) and Henry I. of Lorraine,

¹ (1618-1699), a son of Arnauld d'Andely and minister of foreign affairs in succession to Lionne.

(1587 and 1588), duke of Guise, but was taken in 1676 by Marshal Luxembourg, who razed its fortifications. The tolerance of the princes of Württemberg attracted to the town at the end of the 16th century a colony of Anabaptists from Frisia, and their descendants still form a separate community in the neighbourhood. In 1703 the inhabitants voluntarily submitted to annexation by France. In 1871 the battle of the Lisaine between the French and Germans was fought in the neighbourhood and partly within its walls.

MONTBRISON, a town of east-central France, capital of an arrondissement in the department of Loire, France, 21 m. N.W. of St Étienne, on the railway from Clermont to St Étienne. Pop. (1906), 6564. It is situated on a volcanic hill overlooking the Vizezy, a right-hand affluent of the Lignon du Nord. The principal buildings are the once collegiate church of Notre-Dame d'Espérance, founded about 1220 but not finished till the 15th century, and the 14th-century edifice known as the Salle de la Diana (Decana), which was restored by Viollet-le-Duc. There is a statue of the poet Victor de Laprade (d. 1883), a native of the town. Montbrison is the seat of a sub-prefect, of a court of assize and of a tribunal of first instance. There are liqueur-distilleries and flour-mills, and silk ribbons are manufactured; there is considerable commerce in grain.

Montbrison belonged to the counts of Forez during the middle ages. In 1801 it became the capital of its department in place of Feurs, but in 1836 the more important town of St. Étienne was substituted for it.

MONTBRUN, LOUIS PIERRE, COUNT (1770-1812), French cavalry general, served with great distinction in the cavalry arm throughout the wars of the Revolution and the Consulate, and in 1800 was appointed to command his regiment, having served therein from trooper upwards. At Austerlitz (Dec. 2, 1805) he was promoted general of brigade. He earned further distinction in Germany and Poland as a dashing leader of horse, and in 1808 he was sent into Spain. Here occurred an incident which unfavourably influenced his whole career. He found himself obliged to overstay his leave of absence in order to protect the lady who afterwards became his wife. Napoleon was furious, and deprived him of his command, and Montbrun was awaiting his master's decision when an opportunity came to retrieve his reputation. Some doubt exists as to the events of the famous cavalry charge at the Somosierra, but Montbrun's share in it was most conspicuous. Soon afterwards he was promoted to be general of division, and in 1809 his cavalry took no inconsiderable part in the victories of Eckmühl and Raab. He was employed in the Peninsula, 1810-1811. He was killed, when commanding a cavalry corps, at the beginning of the battle of Borodino (Sept. 7, 1812). Montbrun was considered, as a leader of heavy cavalry, second only to Kellermann of all the generals of the First Empire.

MONTCALM DE SAINT VÉRAN, LOUIS JOSEPH, MARQUIS DE (1712-1759), French soldier, was born at Condiac near Nîmes on the 28th of February 1712,² and entered the army in 1721, becoming captain in 1727. He saw active service under Berwick on the Rhine in 1733, and in 1743, having become a colonel of infantry, he served in Bohemia under Mallebois, Broglie and Belleisle. He became intimate with François de Chevert (1695-1769), the gallant defender of Prague, and in Italy repeatedly distinguished himself, being promoted brigadier in 1747, shortly before the disastrous action of Exilles, in which he was severely wounded. In 1749 he received the colonelcy of a cavalry regiment, and in 1756, with the rank of *maréchal de camp*, he was sent to command the French troops in Canada. In the third year of his command, having been meanwhile promoted lieutenant-general, he defended Quebec (a.r.) against General Wolfe. The celebrated siege ended with the battle

² A younger brother, Jean Louis Pierre (or Philippe) Elizabeth Montcalm de Condiac (1719-1726), was a child of astonishing precocity. At the age of four he read Latin; at six he understood Greek and Hebrew. It was for his benefit that the *bureau typographique*—a mechanism for teaching children reading, writing and arithmetic at the same time that it amused them—was contrived by their tutor Louis Dumas (1676-1744).

of the Heights of Abraham (Sept. 12, 1750), in which Wolfe was killed and Montcalm mortally wounded. The French commander died two days later, while the place, with which his name and Wolfe's are ever associated, was still in the hands of the garrison.

BIBLIOGRAPHY.—See CANADA: *History*; and SEVEN YEARS' WAR, also Parkman's *Montcalm and Wolfe*. The chief French authorities are Pinard, *Chronologie militaire*, v. 616 (1762); *Montcalm et le Canada français*, by F. Joubreau (Paris, 1874) and C. de Bonnechose (Paris, 1877); Le Moine, *La Mémoire de Montcalm vengée* (Montreal, 1889).

MONTCEAU-LES-MINES, a town of east-central France, in the department of Saône-et-Loire, 14 m. S. by W. of Le Creusot on the Paris-Lyon railway. Pop. (1906), town, 9701; commune, 26,305. Its importance is due chiefly to its position as the centre of the Blanzay coal basin, on the Canal du Centre, which, is connected with the coalfield by numerous lines of railway. Its manufacturing establishments include weaving and spinning factories, iron and copper foundries, and engineering workshops.

MONT CENIS, a pass (6893 ft.) in Savoy (France) which forms the limit between the Cottian and Graian Alps. A carriage road was built across it between 1803 and 1810 by Napoleon, while a light railway (named after its inventor, Mr. Fell, and worked by English engine-drivers) was opened alongside the road in 1868, but was destroyed in 1871, on the opening of the tunnel. This tunnel (highest point 4249 ft.) is really 17 m. west of the pass, below the Col de Fréjus. From Chambéry the line runs up the Isère valley, but soon bears through that of the Arc or the Maurienne past St Jean de Maurienne to Modane (61 m. from Chambéry). The tunnel is 8 m. in length, and leads to Bardonnèche, some way below which, at Oulx (18 m. from Modane) the line joins the road from the Mont Genève. Thence the valley of the Dora Riparia is followed to Turin (64½ m. from Modane). The carriage road mounts the Arc valley for 16 m. from Modane to Lanslebourg, whence it is 8 m. to the hospice, a little way beyond the summit of the pass. The descent lies through the Cenis valley to Susa (37 m. from Modane) where the road joins the railway. To the south-west of the Mont Cenis is the Little Mont Cenis (7166 ft.) which leads from the summit plateau (in Italy) of the main pass to the Étache valley on the French slope and so to Bramans in the Arc valley (7 m. above Modane). This pass was crossed in 1689 by the Vaudois, and by some authors is believed to have been "Hannibal's Pass." (W. A. B. C.)

MONTCHRÉTIEN, ANTOINE DE (1575 or 1576–1621), French dramatist and economist, son of an apothecary at Falaise named Mauchrestien, was born about 1576. In one of his numerous duels he had the misfortune to kill his opponent. He consequently took refuge in England, but through the influence of James I., to whom he dedicated his tragedy, *L'Écoissaise*, he was allowed to return to France, and established himself at Auxonne-sur-Loire, where he set up a steel foundry. In 1621 he abandoned this enterprise to serve on the Huguenot side in the civil wars. He raised troops in Maine and Lower Normandy, but was killed in a skirmish near Tourailles on the 8th of October 1621. There is no evidence that he shared the religious opinions of the party for which he fought, and in any case he belonged to the moderate party rallied round Henry IV. In 1615 he published a valuable *Traité de l'économie politique*, based chiefly on the works of Jean Bodin. He had the good fortune to write before the pruning processes of Vaugelas and Balzac had been applied to the language, and M. Lanson praises him as one of the best prose-writers of his time.

His dramas are *Sophonisbe* (1596), afterwards remodelled as *La Cartaginnoise*; *L'Écoissaise*, *Les Lacènes*, *David*, *Aman* (in 1601); *Hector* (1604). As plays they have little technical merit, but they contain passages of great lyrical beauty. In *L'Écoissaise* Elizabeth first pardons Mary Queen of Scots, and no explanation is given of the change that leads to her execution. *Aman* has been compared not too unfavourably with *Esther*, and the hatred of Haman for Mordecai is expressed with more

vigour than in Racine's play. All Montchrétien's heroes face death without fear. M. Petit de Julleville finds the characteristic note of his plays in the same cult of heroism which was later to inspire the plays of Corneille. Poet, economist, iron-master, and soldier, Montchrétien represents the many-sided activity of a time before literature had become a profession, and before its province had been restricted in France to polite topics.

The tragedies were edited in 1901 by M. Petit de Julleville with notice and commentary; the *Traité de l'économie politique* in 1889 by Th. Funck Brentano, whose estimate of Montchrétien is severely criticized by W. I. Ashley in the *Eng. Hist. Rev.* (Oct. 1891). See also Emile Faguet, *La Tragédie au XVII^e siècle*, ch. xi. (1883); G. Lanson, *Revue des deux mondes* (Sept. 1891).

MONTCLAIR, a town of Essex county, New Jersey, U.S.A., 5 m. N.N.W. of Newark. Pop. (1910 census) 21,550. It is served by the Erie and the Delaware, Lackawanna & Western railways, and by electric lines to Caldwell and Newark. It is situated at the base and on the slopes of the Orange Mountains (its altitude above the sea varying from 217 to about 665 ft.) has an irregular street plan, and is a residential suburb of New York and other neighbouring cities. Montclair has excellent public schools. Among the town's institutions are the Mountainside hospital, a state normal school (1908), Montclair academy (1887), a public library, and two orphan asylums. An annual Bach festival was first held here in June 1905. The lower part of Montclair was settled about 1675 and gradually became known as Cranetown, which name it retained until 1812. In that year Bloomfield, including Cranetown, was organized as a separate township. In 1868 Cranetown, then popularly known as West Bloomfield, with the addition of the Dutch-settled Speertown, was incorporated as Montclair. Montclair became a town in 1804.

See Henry Whittemore, *History of Montclair* (New York, 1894).

MONT-DE-MARSAN, a town of south-west France, capital of the department of Landes at the confluence of the Midou and the Douze, 92 m. S. of Bordeaux on the Southern railway between Morcenx and Tarbes. Pop. (1906), 9059. Most of the buildings are in the older quarter, on the peninsula between the two rivers forming the Midouze. La Pépinière, a beautiful public garden, extends along the right bank of the Douze. A keep of the 14th century, now used for military purposes, was built by Gaston Phoebus, count of Foix, to overawe the inhabitants, and goes by the name of Nou-li-Bos (in modern French "Tu ne l'y veux pas"). The finest of the modern buildings is an officers' club, which contains a small museum. A court of assizes sits in the town; the local institutions comprise a tribunal of first instance, a branch of the Bank of France, and a lycée. The industries include distillation of turpentine and resinous oils, tanning, the founding and forging of metal, wood-sawing, and manufactures of machinery and straw envelopes for bottles. There is trade in resin, wine, brandy, timber, cattle, horses and other live stock.

Mont-de-Marsan, the first of the Bastides (*q.v.*) of the middle ages, dates from 1141, when it was founded by Pierre, vicomte de Marsan, as the capital of his territory. In the 13th century it passed to the viscounts of Béarn, but the harsh rule of Gaston Phoebus and some of his successors induced the people to favour the English. The territory was united to the French Crown on the accession of Henry IV.

MONTDIDIER, a town of northern France, capital of an arrondissement in the department of Somme, 23 m. S.E. of Amiens by rail. Pop. (1906), 4159. The town, situated on an eminence on the right bank of the Don, dates from the Merovingian period, and perhaps owes its name to the imprisonment of the Lombard king Didier in the 8th century. The church of St Pierre, dating chiefly from the 15th century, has a beautiful portal of the 16th century and contains the tomb of Raoul III., count of Crépy (12th century), founts of the 11th century and other works of art. The church of St Sulpice belongs, with the exception of the modern portal, to the 15th and 16th centuries. In the interior there is a well-known "Holy Sepulchre" of the

latter period. The law-court, once the castle, partly dating from the 12th century, possesses fine tapestries of the 17th century. A statue commemorates the birth at Montdidier of Antoine Parmentier (1737-1813), with whose name are connected the beginnings of potato-culture in France. The town has a sub-prefecture and a tribunal of first instance; its industries include tanning and the manufacture of zinc-white.

Held first by its own lords, afterwards by the counts of Crépy and Valois, Montdidier passed to the Crown in the 12th century, at the end of which it was granted a charter of liberties. The town offered a brave and successful resistance to the Spanish troops in 1636.

MONT-DORE-LES-BAINS, a watering-place of central France in the department of Puy-de-Dôme, situated at a height of 3440 ft., on the right bank of the Dordogne not far from its source, and 31 m. by road S.W. of Clermont-Ferrand. Pop. (1906), 1677. The Monts Dore close the valley towards the south. The thermal springs of Mont Dore, now numbering twelve, were known to the Romans. Bicarbonate of soda, iron and arsenic are the principal ingredients of the waters, which are used both for drinking and bathing, baths of high temperature being characteristic of the treatment; they are efficacious in cases of pulmonary consumption, bronchitis, asthma, and nervous and rheumatic paralysis. From the elevation and exposure of the valley, the climate of Mont-Dore-les-Bains is severe, and the season only lasts from the 15th of June to the 15th of September. The bath-house was rebuilt in 1891-1894. In the "park," along the Dordogne, relics from the old Roman baths have been collected. The surrounding country, with its fir woods, pastures, waterfalls and mountains, is very attractive. To the south is the Puy de Sancy (6188 ft.), the loftiest peak of central France.

MONTAEGLE, THOMAS SPRING-RICE, 1st BARON (1790-1866), English statesman, son of S. E. Rice and Catherine Spring, came of a Limerick family, whose ancestor was Sir Stephen Rice (1637-1715), chief baron of the Irish exchequer and a leading Jacobite. In 1820 he became Whig member for Limerick (from 1832 member for Cambridge); and after holding minor offices became secretary for war and the colonies in 1834 and in 1835-1839 chancellor of the exchequer. He was disappointed in not obtaining the speakership, but in 1839 was created Baron Montaeagle of Brandon (a title intended earlier for his ancestor Sir Stephen Rice), and made controller of the exchequer. He differed from the government as regards the exchequer control over the treasury, and the abolition of the old exchequer (q.v.) was already determined upon when he died on the 7th of February 1866. His eldest son, Stephen Edmund Spring-Rice (1814-1865), deputy chairman of the board of customs, having predeceased him, he was succeeded in the title by his grandson, Thomas, 2nd baron (b. 1849). Another son was father of S. E. Spring-Rice (1856-1902), of the treasury, and of Sir Cecil A. Spring-Rice (b. 1859), the diplomatist.

MONTAEGLE, WILLIAM PARKER, 4th BARON, and 11th BARON MORLEY (1575-1622), was the eldest son of Edward Parker, 10th Baron Morley (d. 1618), and of Elizabeth, daughter and heiress of William Stanley, 3rd Baron Montaeagle (d. 1581). When quite a youth he married Elizabeth, daughter of Sir Thomas Tresham, and was styled Lord Montaeagle in right of his mother. He was allied with many Roman Catholic families, and during the reign of Elizabeth was in sympathy with their cause. He received knighthood when with Essex in Ireland in 1599, and in 1601 took part in the latter's rebellion in London, when he was punished by imprisonment and a fine of £8000. He subsequently in 1602 joined in sending the mission to Spain inviting Philip III. to invade England. He was intimate with Catesby and others, and according to Father Garnet expressed an opinion some few months before gunpowder plot that the Romanists had a good opportunity of making good their claims by taking up arms against the king. It is certain that he was one of those who acquiesced in James I.'s accession and assisted Southampton in securing the Tower for the king. He was taken into favour, and received a summons to attend the parlia-

ment of the 5th of November 1605 as Lord Montaeagle. On the 26th of October 1605, while sitting at supper at Hoxton, he received the celebrated letter giving warning of the gunpowder plot, probably written by Francis Tresham. After having caused it to be read aloud by Ward, a gentleman in his service and an intimate friend of Winter, one of the chief conspirators, he took it to Whitehall and showed it to Lord Salisbury and other ministers. On the 4th of November he accompanied Lord Suffolk, the lord chamberlain, in his visit to the vault under the parliament house, where Guy Fawkes was found. Montaeagle received £700 a year for his services in averting the disaster. In 1609 he was chosen a member of the council of the Virginia Company and subscribed to its funds. The same year "disorders in his house" are reported, probably referring to his harbouring of Roman Catholic students from St Omer (*Cal. of St Pap. Dom.*: 1603-1610, p. 533). In 1618, on the death of his father, he was summoned to parliament as Baron Morley and Montaeagle. He died on the 1st of July 1622 at Great Hallingbury, Essex, where he was buried. By his marriage with Elizabeth Tresham he had, besides daughters, three sons, the eldest of whom, Henry, (d. 1655) succeeded him as 12th Baron Morley and 5th Baron Montaeagle. These baronies fell into abeyance when Henry's son Thomas died about 1686.

MONTE CASSINO, an isolated hill overhanging the town of Cassinum, about midway between Rome and Naples. Hither St Benedict migrated from Subiaco in the early years of the 6th century, and established the monastery that became the metropolis of Western monachism. About 580-590 it was sacked by the Lombards, and the monks fled to Rome, where they were established at the Lateran basilica. The monastery was rebuilt in 720, again destroyed by the Saracens in 884, and restored seventy years later. It reached its highest point of prosperity and influence from 1050 to 1105, under Desiderius (who became Pope Victor III. in 1087) and Odeisius. The abbot became overlord of an extensive territory and bishop of several dioceses: now, though not a bishop, he is ordinary of seven dioceses. At the dissolution of monasteries in 1866 Monte Cassino was spared, owing mainly to a remonstrance by English well-wishers of United Italy. The monastery became a national monument and the monks were recognized as custodians. There is a large secondary school with 250 boys, and rich archives.

See L. Tosti, *Storia della badia di M.C.* (1841; 2nd ed., 1888); Wetzer u. Welte, *Kirchenlexicon* (2nd ed.) and Herzog, *Realencyklopädie* (3rd ed.). (E. C. B.)

MONTecatini, two much-frequented mineral baths of Tuscany, Italy. (1) Montecatini in Val di Cecina, in the province of Pisa, 5 m. W. of Volterra. Pop. (1901), 5009. The water is saline, with a temperature of 78°-8° F. There are copper mines, which have been worked since the 15th century, 1358 ft. above sea-level. (2) Montecatini in Val di Nievole, in the province of Lucca, 7 m. W. by S. of Pistoja, 105 ft. above sea-level. Pop. (1901), 3048 (Bagni di Montecatini); 2856 (Montecatini). The springs, which number ten, are saline, and range in temperature from 82°-4° to 86° F. The water is both drunk and used for bathing by some 40,000 visitors annually, and is exported in bottles. There is also a natural vapour bath (80°-95° F.) in the Grotta Giusti (so-called from the satirist Giuseppe Giusti, a native of the place), at Monsummano near by, discovered in 1849. Another attraction of the place is the gardens of Collodi. At the town of Montecatini, on the hill above (951 ft.), the Florentines were defeated by Uguccione della Faggiuola of Pisa in 1315.

MONTE CORVINO, GIOVANNI DI (c. 1247-1328), Franciscan missionary, traveller and statesman, founder of the earliest Roman Catholic missions in India and China, and archbishop of Peking. In 1272 he was commissioned by the emperor Michael Palaeologus, to Pope Gregory X., to negotiate for the reunion of Greek and Latin churches. From 1275 to 1289 he laboured incessantly as a missionary in the Nearer and Middle East. In 1289 he revisited the Papal Court, and was sent out as Roman legate to the Great Khan, the Ilkhan of Persia, and other leading personages of the Mongol world, as well as to the

"Emperor of Ethiopia" or Abyssinian Negus. Arriving at Tabor, then the chief city of Mongol Persia, and indeed of all Western Asia, Monte Corvino moved down to India to the Madras region or "Country of St Thomas," from which he wrote home, in December 1291 (or 1292), the earliest noteworthy account of the Coromandel coast furnished by any Western European. He next appears in "Cambalich" or Peking, and wrote letters (of Jan. 8, 1305, and Feb. 13, 1306), describing the progress of the Roman mission in the Far East, in spite of Nestorian opposition; alluding to the Roman Catholic community he had founded in India, and to an appeal he had received to preach in "Cathay" and dealing with overland and overseas routes to "Ethiopia," from the Black Sea and the Persian Gulf respectively. In 1303 he received his first colleague, the Franciscan Arnold of Cologne; in 1307 Pope Clement V. created him archbishop of Peking, and despatched seven bishops to consecrate and assist him; three only of these arrived (1308). Three more suffragans were sent out in 1312, of whom one at least reached East Asia. A Franciscan tradition maintains that about 1310 Monte Corvino converted the Great Khan (i.e. Khaishan Kuluk, third of the Yuen dynasty; 1307-1311): this has been disputed, but he unquestionably won remarkable successes in North and East China. Besides three mission stations in Peking, he established one near the present Amoy harbour, opposite Formosa. At his death, about 1328, heathen vied with Christian in honouring him. He was apparently the only effective European bishop in the Peking of the middle ages.

The MSS. of Monte Corvino's *Letters* exist in the Laurentian Library, Florence (for the Indian Epistle) and in the National Library, Paris, 5006 Lat.—viz. the *Liber de aetibus*, fols. 170, v.-172, r. (for the Chinese). They are printed in Wadding, *Annales minorum* (A.D. 1305 and 1306) vi. 69-72, 91-92 (ed. of 1733, &c.), and in the *Münchener gelehrte Anzeigen* (1855), No. 22, part iii, pp. 171-175. English translations, with valuable comments, are in Sir H. Yule's *Cathay*, i. 197-221. See also Wadding, *Annales*, v. 195-198, 199-203, vi. 93, &c., 147, &c., 176, &c., 467, &c.; C. R. Beazley, *Dawn of Modern Geography*, iii. 162-178, 206-210; Sir H. Yule, *Cathay*, i. 165-173. (C. R. B.)

MONTECRISTO, (anc. Oglasa), an island of Italy, belonging to the province of Leghorn, 25 m. S. of Elba. Its highest point is 2126 ft. above sea-level, and its area about 6 sq. m. It contains the ruins of a Camaldulensian monastery, founded in the 13th century and destroyed in the 16th, and is the private property of the king of Italy, who has a shooting-lodge there. The fame of the island is due to the novel, *Le Comte de Montecristo*, by the elder Dumas.

MONTECUCULLI (MONTECUCOLI), **RAIMONDO**, COUNT OF (1609-1680), prince of the holy Roman Empire and Neapolitan duke of Meli, Austrian general, was born on the 21st of February 1608/9, at the castle of Montecucullo in Modena. His family was of Burgundian origin and had settled in north Italy in the 10th century. At the age of sixteen Montecuculli began as a private soldier under his uncle, Count Ernest Montecuculli, a distinguished Austrian general (d. 1633). Four years later, after much active service in Germany and the Low Countries, he became a captain of infantry. He was severely wounded at the storming of New Brandenburg, and again in the same year (1631) at the first battle of Breitenfeld, where he fell into the hands of the Swedes. He was again wounded at Lützen in 1632, and on his recovery was made a major in his uncle's regiment. Shortly afterwards he became a lieutenant-colonel of cavalry. He did good service at the first battle of Nördlingen (1634), and at the storming of Kaiserslautern in the following year won his colonelcy by a feat of arms of unusual brilliance, a charge through the breach at the head of his heavy cavalry. He fought in Pomerania, Bohemia and Saxony (surprise of Wolmirstädt, battles of Wittstock and Chemnitz), and in 1639 he was taken prisoner at Melnik and detained for two and a half years in Stettin and Weimar. In captivity he studied, not only military science, but also geometry in Euclid, history in Tacitus, and architecture in Vitruvius, and planned his great work on war. On his release he distinguished himself again in Silesia. In 1643 he went to Italy, by the emperor's request, and made a successful campaign in Lombardy. On his return to Germany

he was promoted lieutenant-field-marshal and obtained a seat in the council of war. In 1645-46 he served in Hungary against Prince Rakoczy of Transylvania, on the Danube and Neckar against the French, and in Silesia and Bohemia against the Swedes. The victory of Triebel in Silesia won him the rank of general of cavalry, and at the battle of Zusmarshausen in 1648 his stubborn rearguard fighting rescued the imperialists from annihilation. For some years after the peace of Westphalia Montecuculli was chiefly concerned with the business of the council of war, though he went to Flanders and England as the representative of the emperor, and to Sweden as the envoy of the pope to Queen Christina, and at Modena his lance was victorious in a great tourney. In 1657, soon after his marriage with Countess Margarethe Dietrichstein, he took part in, and after a time commanded, an expedition against Rakoczy and the Swedes who had attacked the king of Poland. He became field-marshal in the imperial army, and with the Great Elector of Brandenburg completely defeated Rakoczy and his allies (peace of Oliva, 1660). From 1661 to 1664 Montecuculli with inferior numbers defended Austria against the Turks; but at St Gotthard Abbey, on the Raab, he defeated the Turks so completely that they made a truce for twenty years (Aug. 1, 1664). He was given the Golden Fleece, and became president of the council of war and director of artillery. He also devoted much time to the compilation of his various works on military history and science. He opposed the progress of the French arms under Louis XIV., and when the inevitable war broke out received command of the imperial forces. In the campaign of 1673 he completely out-manoeuvred his great rival Turenne on the Neckar and the Rhine, and secured the capture of Bonn and the junction of his own army with that of the prince of Orange on the lower Rhine. He retired from the army when, in 1674, the Great Elector was appointed to command in chief, but the brilliant successes of Turenne in the winter of 1674 and 1675 brought him back. For months the two famous commanders manoeuvred against each other in the Rhine valley, but on the eve of a decisive battle Turenne was killed and Montecuculli promptly invaded Alsace, where he engaged in a war of manoeuvre with the great Condé. The siege of Philippsburg was Montecuculli's last achievement in war. The rest of his life was spent in military administration and literary and scientific work at Vienna. In 1679 the emperor made him a prince of the empire, and shortly afterwards he received the dukedom of Meli from the king of Naples. Montecuculli died at Linz on the 16th of October 1680, as the result of an accident. With the death of his only son in 1698 the principality became extinct, but the title of count descended through his daughters to two branches, Austrian and Modenese. As a general, Montecuculli shared with Turenne and Condé the first place amongst European soldiers of his time. His *Memorie della guerra* profoundly influenced the age which followed his own; nor have modern conditions rendered the advice of Montecuculli wholly valueless.

AUTHORITIES.—The *Memorie della guerra*, &c., was published at Venice in 1703 and at Cologne in the following year. A Latin edition appeared in 1718 at Vienna, a French version at Paris in 1712, and the German *Kriegs geschichten des Fürsten Raymundi Montecuculli* at Leipzig in 1736. Of this work there are MSS. in various libraries, and many memoirs on military history, tactics, fortification, &c., written in Italian, Latin and German, remain still unedited in the archives of Vienna. The collected *Opere di Raimondo Montecuculli* were published at Milan (1807), Turin (1821) and Venice (1840), and include political essays and poetry.

See Campori, *Raimondo Montecuculli* (Florence, 1876); Spenholtz, *Aureum vellus seu catena*, &c. (Vienna, 1668); memoir prefaced to the *Memorie* (Cologne edition); this appears also in v. der Groeben's *Neuer Kriegsbibliothek*, vi. 230 (Breslau, 1777); *Morgenster's Oesterreichs Helden* (St Pölten, 1782); Schweigerd, *Oesterreichs Helden* (Vienna, 1853); Paradisi, *Di Ego storico del conte Raimondo Montecuculli* (Modena, 1766); Schels, *Oesterreichische militärische Zeitschrift* (Vienna, 1818, 1828 and 1842); Pezzl, *Lebensbeschreibung Montecuculli* (Vienna, 1792); Hormayr, *Oesterreichischer Plutarch*, XIII. (Vienna, 1808); Reilly, *Biographie der berühmtesten Feldherrn Oesterreichs* (Vienna, 1813); Würzbach, *Biographisches Lexikon des Kaiserthums*, &c., pt. 19 (Vienna, 1868); Teuffenbach, *Vaterländisches Ehrenbuch* (Vienna and Teschen, 1877); *Die Hofkriegsrathspräsidenten* (Vienna, 1874); Weingärtner, *Heldenbuch* (Teschen, 1882); Grossmann, *Archiv für öst. Geschichte* (Vienna, 1878); also

supplement to *Militär. Wochenblatt* (Berlin, 1878); *Organ des militärwissenschaftl. Vereins* (Vienna, 1881); *Reale istituto veneto di scienze*, viii. 5, 6 (Venice, 1881); *Rivista militare Italiana* (March and April 1882); *Allgemeine deutsche Biographie*, vol. xxii. (Leipzig, 1885). Important controversial works are those of Turpin and Warner, two distinguished soldiers of the 18th century (*Commentaires sur les mémoires*, &c. (Paris, 1769, and *Commentaires sur les camps*, &c. du comte Turpin, Breslau, 1777). A critical estimate of Montecucculi's works will be found in *Jähns Gesch. der Kriegswissenschaften*, ii. 1162-1178 (Leipzig, 1890).

MONTEFALCO, a town of the province of Perugia, Italy, 6 m. S.W. of Foligno, situated on a hill, 1550 ft. above sea-level. Pop. (1901), 3397 (town); 5726 (commune). Its churches contain a number of pictures of the Umbrian school; S. Francesco has good frescoes (scenes from the life of S. Francis) of 1452, by Benozzo Gozzoli, in the choir. There is also a communal picture-gallery in the picturesque Palazzo Comunale.

MONTEFASCONI, a town and episcopal see of the province of Rome, Italy, built on a hill (2077 ft.) on the S.E. side of the Lake of Bolsena, 70 m. by rail N.W. of Rome. Pop. (1901), 3041 (town); 9731 (commune). The cathedral (1519) is one of the earliest structures by Sammiceli, S. Maria della Grazie is also by him. The town has in San Flaviano (built in 1032, repaired and enlarged in the Gothic style later in the 14th century), a curious double church of importance in the history of architecture (cf. G. T. Rivoira, *Origini dell' architettura lombarda*, i. 326 sqq.); in its interior some 14th-century frescoes were discovered in 1896. In the crypt is the grave of a traveller, who succumbed to excessive drinking of the local wine known as Est, est, est. The story is that his valet who preceded him wrote "est" on the doors of all the inns where good wine was to be had, and that here the inscription was thrice repeated. It is possible that Montefasconi occupies the site of the Fanum Voltumnae, at which the representatives of the twelve chief cities of Etruria met in the days of their independence; while under the Empire the festival was held near Volsinii.

MONTEFIORE, SIR MOSES HAIM (1784-1885), Jewish philanthropist, eldest son of Joseph Elias Montefiore, a London merchant, and of Rachel, daughter of Abraham Lumbroso de Mattos Mocatta, was born at Leghorn, on the 24th of October 1784. His paternal ancestors were Jewish merchants who settled at Ancona and Leghorn in the 17th century, whilst his grandfather, Moses Haim Montefiore, emigrated from the latter town to London in 1758. Montefiore entered the Stock Exchange, his uncle purchasing for him at a cost of £1200 the right to practise as one of the twelve Jewish brokers licensed by the city of London. Although belonging to the Sephardic or "Spanish" congregation of Jews, he married in 1812 Judith, a daughter of Levi Barent Cohen, of the "German" Jews, another of whose daughters was the wife of Nathan Mayer Rothschild, the head of the great banking firm; this relationship led to a close connexion in business between Montefiore and that house, and his brother Abraham married Henrietta Rothschild, a sister of the financier. In 1824 Montefiore, having amassed a fortune, retired from the Stock Exchange. From his forty-third year Montefiore devoted all his energies to ameliorating the lot of his co-religionists. His first pilgrimage to Palestine was undertaken in 1827, and resulted in a friendship with Mehemet Ali which was to lead to much practical good. Immediately on his return, Montefiore began to take an active part in the struggle which British Jews were then carrying on to obtain full political and civic rights. In 1837 he became the city of London's second Jewish sheriff, and was knighted. In 1838, accompanied by Lady Montefiore, he started on a second voyage to Palestine, in order to submit to Mehemet Ali a scheme for Jewish colonization in Syria. Though political disturbances rendered his efforts again unsuccessful, the year 1840 brought Montefiore once more before Mehemet, this time to plead the cause of some Jews imprisoned at Damascus on a charge of ritual murder. He obtained their release, and on his way back wrung from the Porte a decree giving Jews throughout Turkey the utmost privileges accorded to aliens. In 1846 the threatened re-issue in Russia of an Imperial ukase (first promulgated in 1844) ordering the withdrawal of all Jews from within 50 versts of the

German and Austrian frontiers, caused Montefiore to proceed to St Petersburg, where in an interview with the tsar he succeeded in getting the ukase rescinded. On his return, Queen Victoria, on the recommendation of Sir Robert Peel, made him a baronet. In 1859 a case of injustice which attracted the attention of all Europe brought Sir Moses to the gates of the Vatican. A Jewish child named Mortara had been secretly baptized by his nurse and stolen from his mother, who died of grief. Cardinal Antonelli, in the name of the pope, refused to give up the boy, who became a priest. In 1863 we find Montefiore on a mission in Constantinople to obtain from the Sultan, Abdul Aziz, the confirmation of his predecessor's decrees in favour of the Jews; in 1864 in Morocco to combat an outbreak of anti-Semitism; in 1866 in Syria, relieving the distress resulting from a plague of locusts and an epidemic of cholera; and in 1867 in Rumania, once more pleading the cause of the oppressed Jews with Prince Charles. In 1872 Montefiore was deputed by the British Jews to present to Alexander II. their congratulations on the bicentenary of the birth of Peter the Great, and was received by the tsar with great honour at the Winter Palace. His seventh and last pilgrimage to the Holy Land was made in 1875, of which he wrote an account in his *Narrative of a Forty Days' Sojourn in the Holy Land*, published in that year. The last decade of his life was passed in comparative quiet upon his estate near Ramsgate, in Kent; and there, after having received general congratulations on the completion of his hundredth year, he passed peacefully away on the 28th of July 1885. Sir Moses Montefiore was a strictly orthodox Jew, scrupulously observant of both the spirit and the letter of the Scriptures; in his grounds he had a synagogue built where services are still held twice a day, a college where ten rabbis live and expound the Jewish law, and a mausoleum that contains the remains of himself and of Lady Montefiore, who died in 1862.

MONTEFRIO, a town of southern Spain, in the province of Granada, on the river Bilano. Pop. (1900), 10,725. Montefrio is largely Moorish in character, and dominated by a Moorish castle. Being built midway between the Sierra de Priego and Sierra Parapanda, and commanding the open valley between these ranges, it became one of the chief frontier fortresses of the Moors in the 15th century. Its industries include manufactures of cotton stuffs, alcohol and soap.

MONTEGÜT, JEAN BAPTISTE JOSEPH ÉMILE (1825-1895), French critic, was born at Limoges on the 14th of June 1825. He began to write for the *Revue des deux mondes* in 1847, contributing between 1851 and 1857 a series of articles on the English and American novel, and in 1857 he became chief literary critic of the review. Émile Montégüt translated *Essais de philosophie américaine* (1850) from Emerson; *Révolution de 1688* (2 vols. 1853) from Macaulay's *History*; and also produced the *Œuvres complètes* (10 vols. 1868-1873) of Shakespeare. Among his numerous critical works are *Écrivains modernes d'Angleterre* (3rd series, 1885-1892) and *Heures de lecture d'un critique* (1891), studies of John Aubrey, Pope, Willie Collins and Sir John Mandeville. Montégüt died in Paris on the 11th of December 1895.

MONTEIL, AMANS ALEXIS (1769-1850), French historian, was born at Rodez in 1769, and died at Cely (Seine-et-Marne) in 1850. His tastes were historical, and he taught history at Rodez, at Fontainebleau and at St Cyr. He held that a disproportionate importance had been given to kings, their ministers and generals, and that it was necessary rather to study the people. In his *Histoire des français des divers états, ou histoire de France aux cinq derniers siècles* (10 vols., 1828-1844) he undertook to describe the different classes and occupations of the community. For this he made a collection of manuscripts, which he sold in 1835 (many of them passed into the library of Sir Thomas Phillipps), drawing up a catalogue under the singular title of *Traité de matériaux manuscrits de divers genres d'histoire*. He boasted of having been the first to write really "national" history, and he wished further to show this in a memoir entitled *L'Influence de l'histoire des divers états, ou comment fut allée la France si elle eût eu cette histoire* (1840; reprinted in 1841 under

the title: *Les Français pour la première fois dans l'histoire de France, ou poétique de l'histoire des divers états*. Monteith did not invent the history of civilization, but he was one of the first in France, and perhaps in Europe, to point out its extreme importance. He revised the third edition of his history himself (5 vols., 1848); a fourth appeared after his death with a preface by Jules Janin (5 vols., 1853).

MONTEITH, the name given to a large bowl, often made of silver, with a movable rim and scalloped edges, from which wine glasses, punch ladle, &c., could be hung, so that they might be cooled in the water with which it was filled. According to Anthony Wood (*Life and Times*, iii. 84, quoted in the *New English Dictionary*) the name was given to the bowl from a "fantastical Scot . . . Monsieur Monteith who . . . wore the bottom of his cloake or coate so notched," i.e. scalloped.

MONTELEONE CALABRO, a city of Calabria, Italy, in the province of Catanzaro, beautifully situated on an eminence gently sloping towards the Gulf of Sta Eufemia, 1575 ft. above sea-level, 70 m. N.N.E. of Reggio di Calabria by rail. Pop. (1901), 10,066 (town); 13,481 (commune). It was almost totally destroyed by earthquake in 1783, but under the French occupation it was rebuilt and made the capital of a province. It suffered, however, considerably in the earthquake of 1905. The castle was built by Frederick II. The principal church contains some sculptures by the Gagini of Palermo.

Monteleone is identical with the ancient Hipponium, said to be a Locrian colony and first mentioned in 388 B.C., when its inhabitants were removed to Syracuse by Dionysius. Restored by the Carthaginians (379), occupied by the Brutii (356), held for a time by Agathocles of Syracuse (294), and afterwards again occupied by the Brutii, Hipponium ultimately became as Vibula Valentia a flourishing Roman colony, founded in 239 or 192 B.C. It was important as the point where a branch from Scolacium (Squillace) on the east coast road joined the Via Popillia. The harbour established by Agathocles proved of great service as a naval station to Caesar and Octavian in their wars with Pompeius Magnus and Sextus Pompeius, and remains of its massive masonry still exist at the village of Bivona on the coast, while the fort occupies the site of a temple. Its tunny-fish were famous. In the town itself there are remains of a theatre, of Roman baths (?), a mosaic pavement in the church of St Leolucia (patron saint of Monteleone), and some Latin inscriptions. The town walls too of the Greek city can be traced for their whole extent, about 4 m. They are well constructed of regular parallelograms of a sandy tufa, laid in headers and stretchers. The Roman town occupied only a part of the Greek site, the portion occupied by the modern town, the streets of which still preserve the Roman arrangement. It was supplied with water by an aqueduct, the reservoir of which is situated at the village of Papaglianti. The Capialdi and Cordopatri families have private collections of antiques.

See V. Capialdi in *Mem. Inst. (Rome, 1832)*, pp. 159 sqq.; F. Lenormant, *La Grande-Grece* (Paris, 1882), iii. 155 sqq. (T. As.)

MONTÉLIMAR, a town of south-eastern France, capital of an arrondissement in the department of Drôme, near the left bank of the Rhone, 93 m. S. of Lyons on the railway to Marseilles. Pop. (1906), town, 9162; commune, 13,554. The ancient castle is now used as a prison. Remains of the ramparts and four old gates are also preserved. The chief public institutions are the sub-prefecture, the tribunal of first instance and the communal college. The industries include flour-milling, silk-throwing and spinning, and the manufacture of hats, lime, farming implements, preserved foods and nougat.

Montélimar was called by the Romans *Acunnum*. At a later period it belonged to the family of Adhémar and received the name Monteith d'Adhémar, whence the present name. Towards the middle of the 14th century it was sold by them partly to the dauphins of Viennois and partly to the pope, and in the next century it came into the possession of the Crown. During the religious wars it valiantly resisted Gaspard de Coligny in 1570, but was taken by the Huguenots in 1587.

MONTMAYOR (or **MONTMÔR**), **JORGE** (1520?-1561), Spanish novelist and poet, of Portuguese descent, was born about 1520 at Montemor o Velho (near Coimbra), whence he derived his name, the Spanish form of which is Montemayor. He seems to have studied music in his youth, and to have gone to Spain in 1543 as chorister in the suite of the Portuguese Infanta Maria, first wife of Philip II. In 1552 he went back to Portugal in the suite of the Infanta Juana, wife of D. João, and on the death of this prince in 1554 returned to Spain. He is said to have served in the army, to have accompanied Philip II. to England in 1555, and to have travelled in Italy and the Low Countries; but it is certain that his poetical works were published at Antwerp in 1554, and again in 1558. His reputation is based on a prose work, the *Diana*, a pastoral romance published about 1559. Shortly afterwards Montemayor was killed in Piedmont, apparently in a love affair; a late edition of the *Diana* gives the exact date of his death as the 26th of February 1561. The *Diana* is generally stated to have been printed at Valencia in 1542; but, as the *Canto de Orfeo* refers to the widowhood of the Infanta Juana in 1554, the book must be of later date. It is important as the first pastoral novel published in Spain; as the starting-point of a universal literary fashion; and as the indirect source, through the translation included in Googé's *Eglogs, epytaphes and sonnets* (1563), of an episode in the *Two Gentlemen of Verona*. Though Portuguese was Montemayor's native language, he only used it for two songs and a short prose passage in the sixth book of the *Diana*. His mastery of Spanish is amazing, and even Cervantes, who judges the verses in the *Diana* with unaccustomed severity, recognizes the remarkable merit of Montemayor's prose style. That he pleased his own generation is proved by the seventeen editions and two continuations of the *Diana* published in the 16th century, by parodies, imitations and renderings in French and English.

BIBLIOGRAPHY.—G. Schönherr, *Jorge de Montemayor, sein Leben und sein Schöpfwerk* (Halle, 1886); D. García Peres, *Código razonado biográfico y bibliográfico de los autores portugueses que escribieron en castellano* (Madrid, 1890); Hugo A. Rennert, *The Spanish Pastoral Novel* (Baltimore, 1892); J. Fitzmaurice-Kelly, "The Bibliography of the *Diana*" in the *Revista hispanica* (1895); R. Tobler, "Shakespeare's Sommernachtsstraum und Montemayor's *Diana*" in the *Jahrbuch der deutschen Shakespeare-Gesellschaft* (1898); M. Menéndez y Pelayo, *Orígenes de la novela* (Madrid, 1905).

MONTENEGRO, a country of south-eastern Europe, forming an independent kingdom situated upon the western side of the Balkan Peninsula, and possessing a small coast-line on the Adriatic Sea. The name is the Venetian variant of the Italian *Monte Nero*, and together with the Albanian *Mal Esiya*, the Turkish *Kara-dagh*, and the Greek *Mavro Vouno*, reproduces the native, or Serb, *Tzrnágora*, "the Black Mountain"; it is derived from the dark appearance of Mount Lovčén, the culminating summit of Montenegro proper, of which the northern and eastern declivities, those which are viewed from the country itself, are in shadow for the greater part of the day.¹ The dusky pine forests, which once clothed the mountain and of which remnants exist on its northern slope, contributed to its sombre aspect. Up to the end of the 15th century, when its territory became restricted to the mountainous districts immediately north and east of Mount Lovčén, the kingdom was known as the Zenta or Zeta, but the name Tzrnágora was probably used locally in this region from the time of the earliest Slavonic settlements.

Montenegro extends between 41° 55' and 43° 21' N., and between 18° 30' and 20° E.; its greatest breadth from north to south is about 100 m.; its greatest breadth from east to west about 80 m. It is bounded by the Adriatic *Area and Boundaries* on the S., the seaboard extending for 28 m.; by the Primore, a strip of the Dalmatian littoral, on the S.W. and W.; by the Austrian (formerly Turkish) provinces

¹ Cf. the similarly-named *Tzerna Planina* in eastern Montenegro, *Tcherni Vrkh*, the culminating summit of Mount Vitosh in Bulgaria, and *Mavro Vouno* the island of Salamis. Various other explanations of the name Montenegro, mostly of a fanciful character, have been put forward; see Kurt Hassert, "Der Name Montenegro" in *Globus*, No. 67, pp. 111-113 (Leipzig, 1895).

of Bosnia and Herzegovina on the N.W. and N.; by the Ottoman empire both in the sanjak of Novibazar, on the N. and N.E., and also in the vilayets of Kossovo and Scutari on the N.E., E. and S.E. Its area, as officially estimated after the treaty of Berlin had been enforced in 1880, amounts to 3255 sq. m., or considerably less than half the size of Wales. The present frontier, which was not finally delimited till 1881, ascends the Boyana river from its mouth as far as Lake Sass (Shas), then follows the river Megured to the summit of Mount Bratovitch, reaching Lake Scutari at a spot opposite the island of Goritza Topal. Crossing the lake north-east to a point a little south-east of Plavnitza, and leaving the territory of the Hoti and Klementi tribes to the south, and the districts of Kutchka Kraina to the north, it passes north of the districts of Plava and Gusiynve and reaches the western end of the Mokra Planina, where it turns to the north-west. After crossing the Lim at its junction with the Skula, it coincides with the old frontier for some distance; then reaching the Tara at Maikovtza, it follows the course of that river to its junction with the Piva: turning southwards, it reaches the old frontier once more at Klobuk, and, passing between the district of Grabovo and the Krivoslian Mountains, approaches to within a few miles of the Bocche di Cattaro: then, following the maritime mountain ridges for a considerable distance, it rejoins the coast a little south of Spizza.

Physical Features.—Montenegro, which forms the meeting-point of the Dalmatian, Bosnian and Albanian ranges, seems at first a mere chaos of mountains. It is, however, naturally divided into three parts, each with its own character. (1) Fertile and well-watered plains, not unlike those of Lombardy, border the river Zeta, and after its junction with the Moratcha extend along the course of that river to Lake Scutari. A fringe of similar lowland forms the maritime plain extending between the Sutoran range and the mouth of the Boyana. (2) Westward, under the shadow of Lovchen, is the Katunsko, or "Shepherds' Huts," the cradle of Montenegrin liberty. This region presents a surface of hard crystalline rock, bare and calcined, with strata sinking to the south-west at an angle often of 70°. The rocks have been split by atmospheric agencies into huge prismatic blocks, and the cracks have been gradually worn into fissures several fathoms deep. In some places the interior of the stony mass is hollowed out into galleries and caves, some of great length; during the rainy season subterranean landslides frequently produce local earthquakes, extending over an area of 10 or 12 m. The small basins of Cettigne and Niegush are practically the only cultivable districts in this region. (3) Over the entire north stretch the massive mountain chains which link the Herzegovinian Alps to those of Albania, the scenery recalling that of Switzerland or the Tirol. In the north-west there are finely wooded tracts extending north of Nikshitch to the Dormitor mountain group. The Dormitor district contains rich grassy uplands dotted with numerous small lakes, from which it derives its name of Yezera (the lakes); the rivers Tara and Piva flow through magnificent gorges clothed with rich forests, and unite near the forenoon north of the frontier. On the north-east are the high but rounded Bria Mountains, covered with virgin forest or Alpine pastures, and broken here and there by jagged dolomitic peaks. In the district of the Vasovjevitchi, which surrounds the little town of Andrijevitcha, is the fine double peak of Kom, and, a little to the south-west, the summit of Maglitch, commanding a magnificent view over the wooded valley of Gusiynve to the great Prokletia range in Albania.¹ The contrast between the rich undulating landscape of the northern regions and the sterile calcined rocks of Montenegro proper is very remarkable.

The Montenegrin mountain system is divided into four masses: (1) the group enclosed by the Tara and Piva rivers with Dormitor, one of the highest mountains in the peninsula (9146 ft.), Yablonov Vrh (7113 ft.), and the Vrkhove Pochoratz (6601 ft.); (2) the group between the Zeta and the Moratcha with Ostri-Kuk (7546 ft.), Vlasuyia (7533 ft.), Brnik (6860 ft.) and Maganik (6621 ft.); (3) the ranges between the Moratcha and Tara with Sto (7323 ft.) and Gradishite (7156 ft.); and (4) those between the upper Tara and the upper Lim with Kom, the second highest mountain in the country (Kom Kutchki, 8035 ft., Kom Vasovjevitchki, 7946 ft.), separating the districts of the Vasovjevitchi on the north-east from that of the Kutchi on the south-west, and Visi tor (6936 ft.) on the frontier. In Montenegro proper the only prominent summit is Lovchen (5653 ft.), between Cettigne and the western frontier. Between Lake Scutari and the sea is the Sutoran range with the fine pyramidal summit of Rumiya (5148 ft.)

¹ This mountain must be distinguished from the higher Maglitch (7699 ft.) on the northern frontier, near the junction of the rivers Tara and Piva.

overhanging Antivari. The prevailing formations of the north and east are Palaeozoic sandstones and schists, with underlying trap. Throughout Montenegro the following have been identified: (1) Palaeozoic schists, (2) Wirten strata of Lower Trias, (3) Trap of the Palaeozoic and Wirten strata, (4) Triassic limestone, (5) Jurassic limestone, (6) Cretaceous limestone, (7) Flysch, in part certainly Eocene, (8) Neogenic or younger Tertiary formations.

The watershed between the Adriatic and the Black Sea crosses the country from west to east in a very irregular line, the southern districts being drained by the Zeta-Moratcha river system, which finds its way to the Adriatic by Lake Scutari and the Boyana, while the streams from the northern districts form the headwaters of the Drina, which reaches the Danube by way of the Save. The Zeta, rising in Lake Slano, near Nikshitch, is remarkable for its subterranean passage beneath a mountain range 1000 ft. high. At Ponor, not far from that



town, the water vanishes in a deep chasm, reappearing at a distance of several miles on the other side of the mountains. Its whole course to its junction with the Moratcha is about 30 m. Rising in the Yavorve Planina, the Moratcha sweeps through mountain gorges till it reaches the plain of Podgoritza; then for a space it almost disappears among the pebbles and other alluvial deposits, nor does it again show a current of any considerable volume till it approaches Lake Scutari. In the neighbourhood of Duklë and Leskopolje it flows through a precipitous ravine from 50 to 100 ft. high. In the dry season it is navigable from the lake to Zhabliak. The whole course is about 60 m. Of the left-hand tributaries of the Moratcha the Sem or Tezem deserves to be mentioned for the magnificent cañon through which it flows between Most Tamarui and Dinosa. On the one side rise the mountains of the Kutchi territory on the other the immense flanks of the Prokletia range—the walls of the gorge varying from 2000 to 4000 ft. of vertical height. Lower down the stream the rocky banks approach so close that it is possible to leap across without trouble. The Sem rises in northern Albania, and has a length of 70 m. The Rieka issues full-formed from an immense cave south-east of Cettigne and falls into Lake Scutari. The three tributaries of the Drina which belong in part to Montenegro are the Piva, the Tara, and the Lim, respectively 55, 95 and 140 m. in length. The Tara forms the northern boundary of the kingdom for more than 50 m., but the Lim flows beyond the border after the first 30 m. of its course. The western half of Lake Scutari, or Skodra, belongs to Montenegro;

² Duklëa is the name still borne by the ruins of the Roman Doclea, often, but wrongly, written Dioclea, from its association with the Emperor Diocletian.

the eastern, with Scutari itself, to Albania. It is a magnificent sheet of water, measuring about 135 sq. m., with an average depth of two to three fathoms. The northern end is studded with picturesque islands. The level of Lake Scutari underwent several changes in the 19th century; notably when the Drin, an Albanian river, which before 1830 entered the Adriatic near San Giovanni di Medua, changed its course so as to join the Boyana just below its exit from the lake. This raised the level of the lake, flooding the lower valleys of its tributary streams and permanently enlarging its area. A few small lakes are scattered among the mountains, and it is evident that their number was formerly much greater. Montenegro proper (i.e. the departments of Katunska, Rietchka and Liohsanska) is almost absolutely waterless, the only stream being the Rieka, which probably drains the Cetigne basin by an underground outlet. Its lower course is practically an inlet from Lake Scutari, and is navigable up to the town of Rieka. The upland plain of Cetigne, now waterless, was doubtless the bed of a lake at no very distant (geological) period; it is still sometimes flooded after heavy rains. The scarcity of water largely contributed to the successful defence of the country against Turkish invasion: the few springs are hidden in deep crannies among the rocks, and the inhabitants are accustomed to preserve artificial snow for use during the summer. On the other hand, the Brda¹ and north-eastern districts are abundantly watered. The maritime district possesses two small streams.

Climate.—The climate generally resembles that of northern Albania; it is severe in the higher regions, and comparatively mild in the valleys, while in the maritime districts of Antivari and Dulcigno it may be compared with that of central Italy. The mean annual temperature is about 58° F. Snow lies for most of the year on many heights, and in some of the darker gorges it is never thawed. The high basin of Cetigne (2093 ft.) is deeply covered with snow during the winter months, and the capital is sometimes almost inaccessible; in summer the days are hot, but the nights are cool and frequently chilly. The climate is generally healthy except in a few marshy districts.

Flora and Fauna.—The Alpine vegetation of the summits gives way to pine forests in the sub-Alpine zone (about 6000 ft.); below these the beech, and then the oak, the walnut, the wild pear, and wild plum make their appearance; the fig-tree, the mulberry, and the vine grow in the middle Zeta and Moratcha valleys, the myrtle, orange, laurel and olive in the lower Moratcha region, and more abundantly in the Tzernitza and maritime districts. In the forest districts the beech is the prevailing tree up to a height of about 5000 ft. The chestnut forms little groves in the country between the sea and Lake Scutari but never ascends more than 1000 ft. Pomegranate bushes grow wild, and in many parts of the south cover the foot of the hills with dense thickets, the crimson blossoms of which are one of the special charms of the spring landscapes. The leaves of the sumach (*Rhus cotinus*), which flourishes in the warmer districts, are exported for use in dye-works; the *Pyrethrum cinerariaefolium* supplies material for the manufacture of insect-powder; the fruit of the wild plum (*Cornus mascula*), as well as the grape, is employed for the production of *raki* or *rakiyo*, a mild spirit, which is the favourite beverage with the people inhabiting the hills; and in the higher forests; wolves, and especially foxes, over a much wider area. A few chamois still roam on the loftiest summits, the roebuck is not infrequent in the backwoods, the wild boar may be met with in the same district, and the hare is abundant wherever the ground is covered with herbage. There are one or two species of snakes in the country, including the poisonous Illyrian viper (*Vipera ammodytes*). Esculent frogs, tree frogs, the common tortoise, and various kinds of lizards are all common. Scorpions and numerous reptiles infest the arid rocks of the Katunska. The list of birds includes golden eagles and vultures, twelve species of falcons, several species of owls, hawks, larks, buntings, 100 species of partridges, herons, pelicans, ducks (ten species), nightjars, &c. Immense flocks of water-fowl haunt the upper reaches of Lake Scutari. The rivers abound with trout, tench, carp and eels; the trout of the Moratcha are especially fine. More important from an economic point of view is the *scarpane* (*Leuciscus alburnus*; Servian *uhliava*), a kind of sardine, which supplies an article of food and merchandise to a considerable portion of the population. The fish, which enter the Rieka inlet of Lake Scutari during the winter, are taken with nets during a few weeks in the spring, when the fishing season is inaugurated with a religious service; they are salted and exported in large quantities to Trieste and the Dalmatian coast. The annual take is valued at £4000. The sea-fisheries are of less value. As regards mineral resources, traces of iron, copper and coal are said to exist; there is a natural petroleum spring in the neighbourhood of Virbazar.

Agriculture and Stock-farming.—Except in the lowlands, which serve as the granary of Montenegro, furnishing wheat, maize, barley, rye, potatoes and capsicums, there is little tillage. Methods and implements are alike primitive. In the Katunska the peasants are glad to enclose the smallest spaces of the fertile red soil which is

left after rain in the crevices of the rocks, and one may see harvests only a few yards square. The vineyards produce excellent grapes, but wine production, which might become an important industry, is at present limited to home consumption. Tobacco is largely cultivated, especially in the neighbourhood of Podgoritza; the annual produce amounts to 550,000 lb. Stock-raising is more largely carried on than agriculture. In the north droves of swine fatten on the mast of the beech woods; goats and large flocks of sheep, celebrated for their thick fleeces, thrive on the high pastures, and the lower slopes afford excellent grazing for lake stock. The native breed of cattle is small, but among other efforts made to improve it a stock-farm is maintained by Prince Nicholas near Nikshitch. The horses, as elsewhere in the Balkan Peninsula, are diminutive, wiry and intelligent. Bee-keeping is practised in the Kutchi districts, and mulberries are grown for silkworms.

Commerce and Industries.—The exports, valued at £80,265 in 1906, include cattle (large and small), smoked and salted meat known as *castradina*, cheese, undressed hides, *scarpane*, sumach, pyrethrum, tobacco and wool. The imports, valued in the same year at £239,505, consist mainly of manufactured articles, such as iron utensils and weapons, soap, candles, &c., and colonial products. In 1904, when Montenegro renounced its commercial treaties, the old 8% *ad valorem* duty levied on imports was in many cases raised to 25%. This caused much discontent among the people, who had been growing steadily poorer since 1900; and many families emigrated. The exportation of cattle is greatly hindered by the high tariff imposed on the Austrian frontier, which is productive of much illicit trading. There are practically no manufactures: the men disdain industrial employment, while the women are occupied by household duties or work in the fields. A brewery and a cloth factory, however, exist at Nikshitch, a soda-water factory at Cetigne, and a glass-works refinery at Antivari. The coarser cloth worn by the peasants is home-made; the finer kind worn by the wealthier class is imported.

Communications.—The progress of trade and the development of the natural resources of the country must largely depend on improved means of communication. In this direction considerable progress has already been achieved. Montenegro possessed in 1907 228 m. of excellent carriage roads, admirably engineered and maintained. The remarkable zigzag road from Cattaro to Niegush and Cetigne was completed in 1881; it was afterwards prolonged to Rieka, Podgoritza, Danilovgrad (where a fine bridge across the Zeta was erected in 1879), and Nikshitch. Another road connects Podgoritza with the port of Plavnitza. Lake Scutari, a third runs from Antivari to Rieka, and unites the sea-coasts with the richest districts of the interior. The ports of Antivari and Dulcigno are insufficiently sheltered, but are capable of considerable improvement; both are places of call for the Austrian Lloyd steamers, and a regular service between Antivari and Bari on the Italian coast is maintained by the "Puglia" Steamship Company. The Boyana is navigable by sea-going vessels as far as Oboti (12½ m. from its mouth), where cargoes from Scutari must be transferred to small river craft. Important harbour works were inaugurated in 1905 at Antivari by the Italo-Montenegrin *Compagnia d'Antivari*, which in the same year began the construction of a railway from that port to Virbazar on Lake Scutari. Four steamers belonging to the same company ply on the lake. Postal and telegraphic communication is fairly complete. There were, in 1906, 16 post offices and 20 telegraph stations, with 412 miles of wire. The number of letters posted in that year was 91,250. The telegraph is much used by the people: the number of telegrams sent in 1906 was 54,750.

Population.—In 1882 the population of Montenegro was estimated as low as 160,000 by Schwartz. A more usual estimate is 230,000. According, however, to information officially furnished at Cetigne, the total number of inhabitants in 1900 was 311,564, of whom 293,527 belonged to the Orthodox Church; 12,493 were Moslems and 554 were Roman Catholics; 71,528, or 23%, were literate and 240,036, or 77%, were illiterate. The total number in 1907 was officially given as 282,000. The population is densest in the fertile eastern districts; Montenegro proper is sparsely inhabited. Emigration is greatly increasing, especially to America; the number of emigrants is given as 6674 in 1905 and 4346 in 1906. The bulk of the inhabitants belongs to the Serbo-Croatian branch of the Slavonic race. There were about 5000 Albanians resident in the country in 1900, besides a small colony of gypsies, numbering about 800, a few of whom have abandoned their nomadic life and settled on the soil. The Moslems, whose thrift and industry have won encouragement from the Crown, greatly decreased for some years after 1880 owing to emigration. The capital of Montenegro is Cetigne (3200 inhabitants in 1900, 5138 in 1907). The chief commercial centres are Podgoritza (12,347) and Nikshitch (6872), with the ports of Antivari (2717) and Dulcigno (5166). These towns are described under separate headings. Danilovgrad (1226) on the

Zeta was founded in 1871 by Prince Nicholas and named after his predecessor, Danilo II. In the vicinity is Orialuka, the prince's palace, with its mulberry nurseries. Spuzh (1000), a little lower on the east bank of the Zeta, possesses a fortified acropolis. Niegush or Nyegosh (1893), on the road from Cettigne to Cattaro, is the ancestral abode of the ruling family, which originally came from Niegush in Herzegovina. Zhabliak (1200), near Lake Scutari, was the capital until late in the 15th century. It was a Venetian stronghold. Rieka (1768), near the northern end of Lake Scutari, derives some commercial importance from its position. Grahovo (1000), in the extreme west, is famous for the Turkish defeats of 1851 and 1876. Other small towns are Kolashin, Virbazar and Andrijevitz.

The Montenegrins present all the characteristics of a primitive race as yet but little affected by modern civilization. Society **National Character-istics.** is still in that early stage at which personal valour is regarded as the highest virtue, and warlike prowess constitutes the principal, if not the only, claim to pre-eminence. The chiefs are distinguished by the splendour of their arms and the richness of their costume; women occupy a subject position; the physically infirm often adopt the profession of minstrels and sing the exploits of their countrymen like the bards of the Homeric age. A race of warriors, the Montenegrins are brave, proud, chivalrous and patriotic; on the other hand, they are vain, lazy, cruel and revengeful. They possess the domestic virtues of sobriety, chastity and frugality, and are well-mannered, affable and hospitable, though somewhat contemptuous of strangers. They are endowed in no small degree with the high-flown poetic temperament of the Serb race, and delight in interminable recitations of their martial deeds, which are sung to the strains of the *gása*, a rudimentary one-stringed fiddle. Dancing is a favourite pastime. Two characteristic forms are the slow and stately ring-dance (*kolo*),¹ in which women sometimes participate, though it is usually performed by a circle of men; and the livelier measure for both sexes (*oro*), in which the couples face one another, leaping high into the air, while each man encourages his partner by rapid revolver-firing. The *oro* is the traditional dance in the Katunska district. Women chant wild dirges, generally improvised, over the dead; mourners try to excel one another in demonstrations of grief; and funerals are celebrated by an orgy very like an Irish "wake." Like most imaginative peoples, the Montenegrins are extremely superstitious, and belief in the vampire, demons and fairies is almost universal. Among the mountains they can converse fluently at astonishing distances. The physical type contrasts with that of the northern Serbs: the features are more pronounced, the hair is darker, and the stature is greater. The men are tall, often exceeding 6 ft. in height, muscular, and wonderfully active, displaying a cat-like elasticity of movement when scaling their native rocks; their bearing is soldier-like and manly, though somewhat theatrical. The women, though frequently beautiful in youth, age rapidly, and are short and stunted, though strong, owing to the drudgery imposed on them from childhood; they work in the fields, carry heavy burdens, and are generally treated as inferior beings. Like the Albanians, the Montenegrins take great pride in personal adornment. The men wear a red waistcoat, embroidered with gold or black braid, over which a long plaid is sometimes thrown in cold weather; a red girdle, in the folds of which pistols and yataghans are placed; loose dark-blue breeches and white stockings, which are generally covered with gaiters. The *opanka*, a raw-hide sandal, is worn instead of boots; patent leather long boots are sometimes worn by military officers and a few of the wealthier class. The head-dress is a small cap (*kapa*), black at the sides, in mourning for Kossovo; red at the top, it is said, in token of the blood shed then and afterwards. On the top near the side, five semicircular bars of gold braid, enclosing the king's initials, are supposed to represent the five centuries of Montenegrin liberty. There ¹The ring-dance, known as the *kolo* (literally, "wheel") in all Serb countries, corresponds with the Bulgarian *horo* (to be distinguished from the Montenegrin *oro*), and is almost universal throughout the Balkan Peninsula; it is seldom, however, danced in the rocky Katunska district, where level spaces are rare.

is little authority, however, for this and other fanciful interpretations of the pattern, which was adopted in the reign of Peter I.; the red fez, from which the *kapa* probably derives its colour, was previously worn. A blue or green mantle is sometimes worn in addition by the chiefs. The poorer mountaineers are often dressed in coarse sacking, but all without exception carry arms. The women, as befits their servile condition, are generally clothed in black, and wear a black head-dress or veil; on Sundays and holidays, however, a white embroidered bodice, silver girdle, and bright silk skirt are worn beneath an open coat. Over this is placed a short, sleeveless jacket of red, blue, or violet velvet, according to the wearer's age. Unmarried girls are allowed to wear the red *kapa*, but without the embroidered badge. The Vasoyevitch tribe retain the Albanian costume, in which white predominates. Turkish dress is often seen at Antivari, Dulcigno and Podgoritzta. The dwelling-houses are invariably of stone, except in the eastern districts, where wooden huts are found. As a rule, only the mansions of cattle-owners have a second storey: the ground floor, which is dark and unventilated, is occupied by the animals; the upper chambers, in which the family reside, are reached by a ladder or stone staircase. Chimneys are rare, and the smoke of the fireplace escapes through the windows (if any exist) or the open doorway. The principal food of the people is rye or maize cake, cheese, potatoes and salted *scoranz*; their drink is water or sour milk; meat is seldom tasted, except on festive occasions, when raki and red wine are also enjoyed. The Montenegrins are great smokers, especially of cigarettes; in the districts which formerly belonged to Turkey the men, whose dignity never permits them to carry burdens, may be seen going to market with the *chibák*, or long pipe, slung across their backs. The mother possesses little influence over her sons, who are trained from their earliest infancy to cultivate warlike pursuits and to despise the weaker sex. Betrothals often take place in early childhood. Young men who are attached to each other are accustomed to swear eternal brotherhood (*pobratimstvo*); the bond, which receives the sanction of the Church, is never dissolved. Marriages between Montenegrins and converted Turkish girls are a common source of blood-feuds. The *vadruqa*, or house-community, under the rule of a *starešina*, or house-father, is found in Montenegro as in other Slavonic lands (see *SERVIA*). The tribal system still exists, but possesses less significance than in Albania, owing to the centralization of authority at Cettigne. The tribe (*pleme*, pl. *plemena*) is subdivided into clans (*bratstva*).

Constitution and Government.—Notwithstanding the creation of an elective senate in 1831, the grant of a so-called constitution in 1868, and the establishment of a responsible ministry in 1874, the government remained autocratic till 1905, the whole power, even the control of religion and finance, which the constitution of 1868 had conceded to the senate, being centred in the hands of the prince, who in 1910 assumed the title of king. The senate, instituted by Peter II. with the object of limiting the power of the tribal chieftains, was in 1881 merged in a council of state, the members of which, six in number, were nominated and dismissed by the prince. The council supervises measures to be laid before the *Skupština*, or national assembly, and exercises a disciplinary control over officials. The ministry comprises six departments: (1) the interior, with separate sections for public works, posts and telegraphs, commerce and industry, shipping, sanitary service and agriculture; (2) foreign affairs; (3) war; (4) finance; (5) justice; and (6) education. On the 10th of December 1905 a new constitution was proclaimed by Prince Nicholas. A *Skupština* was instituted, consisting of 62 elected deputies, 9 *ex officio* members (the higher ecclesiastical and civil dignitaries), and 3 generals nominated by the prince. The *Skupština* is elected by manhood suffrage for a period of four years, and is summoned annually on the 31st of October. In conjunction with the Crown it exercises the legislative power; the ministers are responsible to it as well as to the Crown. The constitution affords financial supervision to the *Skupština*, which elects a board of control and votes an annual budget; it guarantees liberty of the person, of religious belief, and of the

press, together with the right of public meeting, and abolishes the death penalty for political offences.

Administration and Justice.—For purposes of local administration the country is divided into 5 departments (*oblasti*), each governed by a prefect (*supravlati*), and 56 districts (*kapetanati*), each under an official styled *kapetan*. The prefects and *kapetans* are nominated by the king on the recommendation of the minister of the interior. Rural communes, each under an elected *kmec*, or mayor, exist in Montenegro as in all Slavonic countries. The *kmets* act as justices of the peace, and there is an appeal from their decisions to the courts of first instance (*kapetanski sudove*), of which there is one in each district, the *kapetan* acting as judge. In each of the five departments there is a superior court (*oblastni sud*), with a president and two judges; at Cetigne there is a high court of justice (*veliki sud*), which is the final court of appeal. The ultimate appeal to the prince was abolished in 1902, when Prince Nicholas laid aside his judicial functions, retaining only the prerogative of pardon. The judges, who are removable, are nominated by the king on the recommendation of the minister of justice. With a single exception there are no professional advocates in Montenegro; each man is his own counsel, bringing his own witnesses. The local gendarmerie, numbering 150 men, is distributed in the five departments. The *kapetanati* have replaced the former local divisions according to *plemena*; in each of the communes there is one or more of the *bratsva*. The codification of the law, which had previously been administered according to unwritten custom, was first undertaken by Peter I. in 1796. An improved code, issued by Danilo II. in 1855, still contained many quaint enactments. The excellent code drawn up by Professor Bogishitch, a native of Ragusa, in 1888, was revised and enlarged in 1890. It contains elements from various foreign systems scientifically adapted to national usages and requirements. A large number of judicial reforms were carried out by Count Voinovitch, who succeeded Professor Bogishitch in 1899; in 1905 a new code of civil procedure was promulgated, and a criminal code in the following year. The only prison is at Podgoritz. In the old prison at Cetigne, closed after 1902, many of the inmates were free to walk in and out at pleasure. Some were burdened with fetters, rather as a punishment than for restraint. Until the completion of an asylum in 1903, dangerous lunatics were confined in prison. The commonest offences are murder and robbery; despite vigorous measures taken by the king and his predecessors, the blood-feud, or vendetta, cannot be stamped out, being approved, and even enforced, by public sentiment. Only women are held exempt from the duty of avenging their next-of-kin; they have been known, however, to undertake it, disguising themselves in male attire. A man who kills his slanderer, or otherwise avenges his honour, often receives a nominal term of imprisonment. Robbery, if practised by means of raids across the frontier, is popularly regarded as a venial offence. Other forms of crime are rare, and foreigners may traverse all parts of the kingdom, except the neighbourhood of the Albanian border, in perfect safety. The death penalty was first introduced by Peter I. Executions are carried out by a firing party selected from the various tribes, in order to prevent the relatives of the criminal from exacting vengeance. Exceptional severity is shown in the treatment of political offenders, who in some instances have been subjected to solitary confinement for years without trial.

Finance.—Financial statistics are not published. The total receipts were estimated in 1907 at 2,773,600 Austrian kronen, the principal sources of income being the taxes on land, houses and cattle, the monopolies of tobacco, salt, petroleum and alcohol, and the customs dues. The total expenditure was estimated at 2,730,994 kronen, the principal items being: civil list, &c., 189,586 kronen; ministry of interior, 574,822 kronen; of foreign affairs, 144,547 kronen; of justice, 232,710 kronen; of finance, 592,561 kronen; of war, 133,696 kronen; of worship and education, 269,208 kronen; service of national debt, 244,500 kronen. The public debt is under £300,000. The contribution of Montenegro to the Ottoman debt has been fixed. From time to time considerable subventions have been

received from Russia and Austria. The annual Russian subsidy, mainly for military and educational purposes, is stated to be about £40,000. Montenegro has no mint; Austrian paper money and coins are generally employed together with Montenegrin nickel and bronze coins struck in Austria. Turkish gold and silver are also in circulation. The former Turkish and Venetian weights and measures have been superseded by the French.

Defence.—The Montenegro is a born warrior; his weapons, which he never lays aside, are his most precious possessions, and distinction in battle is the sole object of his ambition. Persons of all classes wear a revolver in the *kolan* or waistband. "You might as well take from me my brother as my rifle," says a native proverb; and rifles are almost universally carried near the Albanian frontier, where the tribesmen on either side are in a state of chronic hostility. Brave to a fault, an unerring marksman, hardy, agile, crafty and enduring, the Montenegrin has few rivals in the practice of guerrilla warfare. The traditional method of fighting is by ambuscade; the enemy is enticed into some intricate defile, surrounded, and harassed by fire-fire; then the mountaineers, throwing aside their firearms, deliver a swift attack with the *kanjar*, or yatagan, which they wield with terrific effect. A number of heads cut off in battle adorned the parapet of a small tower outside Cetigne, called the "Turks' Tower," as late as 1850. When reduced to extremity the Montenegrins often committed suicide rather than fall into the hands of the enemy, the last cartridge being reserved for this purpose; disabled comrades who could not be removed used to be beheaded, in 1876 a Montenegrin offered to perform this kindly service for a Russian officer who was wounded at Klobuk. Savage methods of warfare, however, have been strongly discontinued by King Nicholas and his predecessor. At the middle of the 19th century the forces of the principality consisted of undisciplined bands of tribesmen under local chiefs, whose rivalries often proved injurious to the national cause. The supreme command, however, always rested with the prince. The nucleus of a permanent corps was created by Peter II., who formed a bodyguard of picked men known as *perianiki*, from the feathers (*pera*) which adorned their caps. The name is still borne by a small corps (20 men in 1907) which guards the residences of the king and his sons, but the feathers are no longer worn. In 1853 Danilo II. ordered the enrolment of all persons capable of bearing arms, and instituted a military hierarchy of *sotenski* (generals), *pod-sotenski* (lieutenants), and *pod-officers*, the latter, which was based on the tribal system, was remodelled by Serbian officers in 1870, when the chiefs were brought to Cetigne to receive military instruction. In the same year arms of precision were introduced: the cost and complex structure of the new weapons threatened to cause serious difficulty, but Russian aid was soon forthcoming. Since 1870, though arms and ammunition are manufactured on a small scale within the kingdom, the chief supplies have come from Russia. In 1895 the tsar presented Prince Nicholas with 30,000 Berdan rifles, besides ordnance and other war material, and in 1898 sent a further gift of 35,000 Moskovska rifles. Every able-bodied citizen must serve in the army, except Moslems, who are exempt on payment of a capitation tax. The military organization has undergone a gradual transformation under Prince Nicholas in conformity with the changed circumstances of the country and the requirements of modern warfare. The militia system on the tribal basis is maintained, but in 1896 a permanent battalion of 500 men was established at Cetigne, and two years later another at Podgoritz, each under a *komandir*, or major, 4 captains and 15 lieutenants. A permanent brigade of artillery was formed at Nikshitch in 1897. In 1905 these were abolished through motives of economy. There is a standing corps of officers, but no standing army. All young men of military age go through an obligatory period of twelve days' service at the various local military centres. Candidates for a commission afterwards proceed to a military school at Podgoritz for one year; the best and most promising then receive commissions as *pod-officieri* or *sons-officers*, and are sent for a further course of instruction of two years to military schools either at Cetigne for the infantry, or at Nikshitch for the artillery. They then receive full commissions and are sent to the local centres to superintend the training of the militia, thus gradually superseding the tribal officers, and replenishing the standing corps of officers of the regular army. Officers in the army, except Moslems, if study abroad are allowed to wear a distinctive emblem on the *kapa*. The war strength is estimated at from 38,000 to 42,000 men, the infantry being composed of about 32,000 men of the first ban and of 5000 or 6000 of the second or reserve (which, however, would scarcely be employed in the field), the artillery of about 1500. Considerable deduction must be made from these numbers in view of the emigration of recent years; according to some authorities between 20,000 and 22,000 men of military age are absent in America and elsewhere. It is expected, however, that many of these would return should the country become involved in war. The infantry is divided into 11 brigades, each containing from 4 to 6 battalions; the total number of battalions is 56. The battalion is composed of a varying number of *ichele*, or companies, each of which belongs to a separate clan and has its own *bairaktar*, or standard-bearer. The younger men of the first ban are occasionally exercised in the neighbourhood of their homes on Sundays and holidays. They are armed with the Moskovska (repeating) rifle, but a Berdan rifle is

¹ The kronen = 10d. English.

also kept in each household. The artillery was composed in 1910 of 18 siege, 25 field and 38 mountain guns, with 4 howitzers, 15 mortars and 18 machine-guns (6 Gatling and 12 Maxim-Nordenfeldt); the principal arsenal is at Spuzh, where the heavier guns are kept, the others are distributed among 8 of the 11 local brigades. The *perianiki*, whose numbers were increased by Prince Danilo, were disbanded in 1898, when steps were taken to form a bodyguard of 3000 picked men under Prince Mirko, King Nicholas's second son, but the project was abandoned in view of the jealousy to which the selection gave rise. Owing to the lack of open country there is no cavalry. In 1894 the sultan presented Prince Nicholas with equipment for a small mounted body-guard (32 men), and offered the services of three instructors. This corps, however, ceased to exist in 1898. About 20,000 men can concentrate at a given spot within 48 hours. The signal for mobilization is mainly given by telegraph; bonfires, trumpet-calls and volley-firing are also employed. The warriors were formerly summoned by stentorian couriers, who shouted from the tops of the mountains. An ambulance corps has been formed. Transport is deficient, all draught animals, however, in the country have been registered and a few carts have been provided. The wives and daughters of the troops provide the commissariat, and carry the ammunition.

Religion.—The Montenegrin Church is an autocephalous branch of the Eastern Orthodox communion. In 1894 it formally vindicated its independence against the claims of the Russian synod. The *vladikas*, or prince-bishops, formerly depended on the patriarchate of Ipek. The theocratic system of government which existed from 1516 to 1851 tended to unite the patriotic and the religious instincts of the people. Since the separation of the spiritual and temporal powers in 1851, the sees of Cetigne, in the diocese of Stroug and the one which has been occupied by metropolitan *Metropolit*, who included a nominal jurisdiction over Scutari and the Primorie. In judgments relative to divorce his verdicts may be reversed by the king. Otherwise he is supreme in matters spiritual. There are 159 parishes of the Orthodox Church, 10 Roman Catholic parishes under the archbishop of Antivari and 10 Mahomedan parishes under a mufti. The churches are small unpretending structures, almost all exactly alike; a handsome cathedral, however, has been erected at Nikshitch. The principal monasteries, in addition to the convent at Cetigne, are those of St. Nicholas, on the Zeta, and of St. Basil, near Scutari. The monastary of St. George is extinct; the parochial clergy, who numbered about 400 in 1900, are only distinguishable from the laity by their beards; they wear the national costume, carry weapons, take part in warfare, and follow the ordinary avocations of the peasantry. Even the old vladikas discarded the episcopal robe, except when engaged in sacerdotal duties. The clergy are still for the most part extremely ignorant.

Education.—The *Bogoslovna*, a seminary for the instruction of the young priests and schoolmasters, was established at Cetigne in 1869. It is maintained by a subvention from the emperor of Russia, while the empress supports the Zenski *gorski* *gimnazij* Institut, an excellently managed school for girls (98 pupils in 1907). Government lecturers go on circuit to instruct the older men. They may be seen on Sundays, not only distributing general information, but teaching the shepherds how to safeguard their flocks from disease, and the lowland cultivators how to tend their vines and tobacco crops. An agricultural college at Podgoritza supplements their work. Primary education is compulsory. In the rural districts it is free; in the towns a small fee is charged. In 1906 there were 112 primary schools in the principality with 150 teachers and 9765 pupils, and 116 copies of the gospel (into all Slavonic countries). Podgoritza has 2 professors and about 1000 pupils; the Moslems and Roman Catholics have separate schools. There are also gymnasia, or high schools, at Cetigne and Podgoritza, with about 700 pupils. Students desirous of higher education proceed abroad, for the most part to the university in Belgrade. The progress of education under Prince Nicholas was very remarkable. In the time of his predecessor, Danilo II., who taught the sons of his chieftains in the palace, there were only three schools in the principality. In 1876, at the beginning of the war, there were 52 schools, with 62 teachers and 3159 pupils. The schools were closed during the war, and its course could be resumed only when the people wanted funds. Elementary education was reorganized in 1878.

Language and Literature.—The Montenegrin language is practically identical with the Serbo-Croatian; it exhibits certain dialectical variations, and has borrowed to some extent from the Turkish and Italian. Existing manuscripts and printed books, chiefly psalters and gospels, bear witness to a period of literary culture among the clergy contemporaneous with the activity of the printing-press at Obod. This was established in 1493, a few years after Caxton set up his first press in Westminster. It was destroyed by the Turks in 1466, after sending out copies of the gospel (into all Slavonic countries). The folk-songs, however, of which the first collection was made in the reign of Peter II., constitute the bulk of the national literature. The poems of that ruler are accounted among the classics of the Servian language, especially his *Gorski Vjenatz*, or "Mountain Wreath," a drama describing the massacre of the Montenegrin Moslems by their Christian kinsmen in 1702. The reigning family has produced a succession of poets; the songs of Mirko Petrovitch,

the father of Prince Nicholas, and the lyrics and dramas of Prince Nicholas himself enjoy great celebrity. The *Grlitze*, or "Turtle-doves," a kind of almanac published at Cetigne by Milakovitch between 1835 and 1839, contained poems, tales, statistics and an abridgment of the Montenegrin annals down to 1830; it was succeeded in the time of Danilo II. by the *Orlich*, or "Eagle." The first Montenegrin newspaper, the *Zrnogoratz*, or "Montenegrin," founded in 1870, was prohibited on the Austrian frontier, and soon disappeared; it was replaced by the *Glas Zrnogoratz*, or "Voice of the Montenegrin," a semi-official publication. There were in 1910 three other journals in the kingdom.

Antiquities.—In Montenegro, as in Albania, the monuments of early civilization bear witness to Roman rather than to Greek influence. Roman remains occur in many parts of the country east of the Zeta, and early Latin churches exist at Dulcigno (*Ulciniam*) and other places. "The organization and forms of the churches, the architecture and ornamentation, point to the West and not to the East." It is evident that Latin civilization was firmly planted in Illyria before the barbarian incursions of the 6th century. Latin sepulchral inscriptions and some finely cut marble blocks have been found at Berane, a little beyond the eastern frontier, and at Budimlje in its neighbourhood. Especially interesting and important are the extensive ruins of Doclea, now known as Duklje, the birthplace of the Emperor Diocletian. The city, which received the franchise under the Flavian emperors, occupied a remarkable site at the junction of the rivers Zeta and Moratcha. The outer walls are standing in many places, and excavations carried out in 1893 by M. Rovinski and Messrs J. A. R. Munro, Milne and Anderson revealed a considerable portion of the ground-plan, including several streets and a forum. Among the buildings are a fine civil basilica, a church, and a group of three churches, of two small temples, an early Christian basilica, and a later church; several inscriptions, columns, richly worked capitals and tracery, and mosaic pavements have been brought to light. At Medun there are remnants of polygonal masonry. Illyrian forts are found in many parts of the country. The ravages of the Turks obliterated almost every trace of medieval culture. The fortress of Obod, the site of the famous printing-press, is a heap of ruins; a fragment of one of the first missals printed here is shown at Cetigne; it bears the date 1494. Other editions are preserved at the monastery of Zeta, and in the Bosnian side of the frontier, and at Moscow. The precious books and relics stored in the monastery of Ivan the Black at Cetigne perished with the destruction of the monastery in 1687. The building, the home of the reigning vladikas, had been previously sacked by the Turks in 1623, and was again destroyed by them in 1714. In the fortress-monastery of St. Nicholas (founded in 1252), which overlooks the headwaters of the Moratcha, are some interesting and well-preserved frescoes which date from the 13th century. The monastery of Ostrog, about twelve miles from Nikshitch, is a comparatively recent foundation, dating from the 18th century. It has been styled "the Lourdes of the Balkans," owing to its reputation for miraculous cures, and is visited in addition by thousands of Orthodox pilgrims, and even by Roman Catholics and Moslems. The upper portion, situated in the cleft of a precipitous rock, was in 1768 and again in 1862 successfully defended by a handful of men against the Turks.

History.—The history of Montenegro as an independent state begins with the battle of Kosovo (1389), but the country had enjoyed periods of independence or semi-independence at various epochs before that event. It formed a portion of the district of *Prævalitana* in the Roman province of Illyria, and, lying on the borderland of the empires of the West and East, it alternately shared the fortunes of either till the close of the 5th century. It was then conquered by the Ostrogoths (A.D. 493), but half a century later definitely passed under Byzantine rule, having already acknowledged the ecclesiastical authority of Constantinople, a circumstance which determined the course of its subsequent history. Illyria and Dalmatia succumbed to the great Serbo-Croat invasion of the 6th and 7th centuries; the Serb race by which Montenegro is now inhabited occupied the country about the middle of the 7th century. A confederacy of Serb states was formed under *zhupans*, or feudal princes, dependent on the grand *zhupan*, who was nominally the vassal of the Greek emperor. The Serb principality of the Zeta, or Zenta, originally included the Herzegovina, Cattaro and Scutari, as well as the Montenegro of to-day, and was ruled by a *zhupan* resident at Doclea. The principality, though retaining its *zhupans*, was practically united with the Servian kingdom between 1150 and 1356 under the Nemanya dynasty, which sprang from Doclea. After the death of the great Servian tsar Dushan in 1356 the feudatory princes of his empire became more or less independent, and the powerful family of Balsha established a dynasty in the Zeta, eventually transferring its capital from Doclea to Scutari.

After the fatal defeat of Kosovo, which extinguished the independence of Serbia for more than four centuries (see SERBIA), George Balsha, the ruling prince of the Zeta, withdrew to the mountainous portion of his realm, which became an asylum for many of the Servian nobles and for others who had been outlawed or persecuted by the Turkish conqueror. The principality now owned no suzerain, and the history of its heroic struggle with the Turks began. The long record of warfare is varied by conflicts with the Venetians, who at times allied themselves with the mountaineers, but usually deserted them in the hour of need. The Balsha family became extinct in 1421, and a new dynasty was founded by Stephan Tzernoyevitch, or Tzernovitch, who fixed his capital at Zhabliak on the north-east side of Lake Scutari, and joined with his relative, the famous Scanderbeg (*q.v.*) in many campaigns against the Turks. After the Turkish conquest of Bosnia in 1463, of the Herzegovina in 1476 and of Albania in 1478, and the surrender of Scutari by the Venetians in 1479, the Montenegrins found themselves surrounded on all sides by the Ottoman power, and the struggle was henceforth for existence. Abandoned by Venice and unable to obtain succour from any Christian state, Ivan the Black, the son and successor of Stephan, set fire to Zhabliak in 1484, and withdrew with his people to the mountain village of Tzettine (Cettigne) which has ever since been the capital of the little principality. Here he founded the famous monastery and created a bishopric in order to establish the spiritual power at the seat of government. Ivan was one of the greatest heroes of Montenegrin history: according to the national legend, he still sleeps in a cave near his fortress of Obod—to awake when the hour arrives for the expulsion of the Turks from Europe.

The Tzernoyevitch dynasty came to an end in 1516, and from this date till 1696 the mountaineers were ruled by the *vladikas* or bishops of Cettigne, elected by assemblies of the *vladikas*, chiefs and people, and consecrated by the patriarch of Ipek. The elective *vladikas* were aided in matters relating to national defence by a civil governor. The institution of a theocratic sovereignty probably saved the country from absorption in the Turkish Empire, the supreme power being vested in a sacrosanct person, whose position was unattainable by ambitious chieftains, and whose holy office precluded the possibility of his defection to Islam. The earlier *vladikas* were left comparatively unmolested by the Turks, and were enabled to devote their attention to the issue of numerous psalters, missals and gospels from the printing-press at Obod. But the beginning of the 17th century was marked by renewed Turkish aggression. Cettigne was taken in 1623 and again in 1687, when the monastery of Ivan the Black was blown up by the monks; a tribute was for a time imposed on the mountaineers, but the bolder spirits maintained their resistance in the heights, and the invading armies found it impossible to prolong their stay in these inhospitable regions.

In 1696 it was decided to continue the hereditary principle with the theocratic system, and Danilo Petrovitch of Niegush, the first ruler of the present reigning family, was nominated *vladika* with power to select his successor from among his relatives. The succession was henceforth regularly from uncle to nephew, owing to the rule of celibacy imposed on the monastic order. The reign of Danilo I. was memorable for the massacre of the Moslems settled in the principality (the "Montenegrin vespers") on Christmas Eve 1702, the great defeat of the Turkish invaders at Tzarevlatz (1712), the capture of Cettigne by the Turks and the destruction for the third time of its monastery (1714), and the inauguration of the intimate relations which have ever since existed with Russia by the visit of the *vladika* to Peter the Great in 1715. With Russian aid Danilo was enabled in some degree to repair the ruin which had overtaken his little realm. In the time of his successor Sava (1737-1782) an impostor named Stephan Mali, who represented himself as the Russian emperor Peter III., won the confidence of the Montenegrins, and governed the country with ability for several years (1768-1773), the mountaineers defeating the combined efforts of the Turks and

Venetians to remove him. He was eventually assassinated by a Greek suborned by the pasha of Scutari. Peter I. (1782-1830), the greatest of the *vladikas*, took part in the war of Austria and Russia against Turkey (1788-92), but was abandoned by his allies in the treaties of Sistova and Jassy. He nevertheless completely routed the Turks in the battle of Krussa (1796), annexed the Brda region to the principality, and obtained a formal recognition of Montenegrin independence from the sultan in 1799. In concert with the Russians he besieged the French in Ragusa (1806), and in 1813-14 expelled them from the Bocche di Cattaro with the aid of a British fleet under Admiral Fremantle. The much-coveted seaport, however, was almost immediately occupied by an Austrian force. Peter I. reorganized the internal administration and promulgated the first Montenegrin code of laws. After his death he was canonized as a saint by the people. His successor Peter II. (1830-1851), a poet, statesman and reformer, as well as a capable military chief, instituted a senate (1831), abolished the office of civil governor (1832), revived the national printing-press, and did much to educate and civilize his people. He was buried by his desire on the summit of Mount Lovchen that his spirit might survey his beloved land. He was the last of the *vladikas*; his nephew Danilo II. (1851-1860) at once declined the ecclesiastical dignity, and assuming the title of *gospodar*, or prince, settled the succession on his direct male descendants. He defeated the Turks near Ostrog in 1853, but refrained from attacking them during the Crimean War. His pacific policy produced much discontent among the warlike mountaineers, which culminated in an open revolt. His demand for the recognition of Montenegrin independence and other claims were set aside by the Congress of Paris. In 1858 his brother Mirko, "the Sword of Montenegro," routed the Turks with great slaughter at Grahovo. In 1855 Danilo II. promulgated a new code, assuring civil and religious liberty to his subjects. On the 11th of August 1860 he was shot at Persano on the Bocche di Cattaro by a Montenegrin whom he had exiled after the revolt, and died two days afterwards. He left no male offspring, and was succeeded by Nicholas, the son of his brother Mirko.

Shortly after the accession of Prince Nicholas (Aug. 13, 1860), an insurrection broke out in Herzegovina, and the sympathy which the mountaineers displayed with their Christian kinsmen led to a rupture with Turkey (1862). Notwithstanding the heroic defence of Ostrog by the prince's father, Mirko, the war proved disastrous, owing to the superior armament and discipline of the Turkish troops, and severe terms were imposed on the principality by the convention of Scutari (Aug. 31). During the fourteen years of peace which followed, the country suffered greatly from pestilence and famine. Within this period a series of reforms were carried out by the prince: the army was rearmed and reorganized, an educational system was initiated, and a constitution under which the prince surrendered various prerogatives to the Senate was granted. In 1869 the Krivoshtians, or Serb inhabitants of the northern shores of the Bocche di Cattaro, rose against the Austrian government; the excitement in Montenegro was intense, but the prince succeeded in checking the warlike ardour of his subjects. The revolt in Bosnia and Herzegovina in 1875 had more important consequences for the principality. On the 2nd of July 1876 Prince Nicholas, in alliance with Prince Milan of Serbia, declared war against Turkey and invaded Herzegovina. A victory was gained at Vuchidol (July 28), and Medun was captured; but the Servian army suffered reverses, and an armistice was arranged in November. In the following spring the determination of Russia to take the field against Turkey encouraged the Montenegrins to renew the war. The Turks succeeded in occupying Ostrog, but were subsequently repulsed; the greater part of their forces was soon withdrawn to Bulgaria, and Prince Nicholas captured successively Nikshitch, Antivari and Dulcigno. The recovery of the seaboard, which had belonged to Montenegro in the middle ages, was perhaps the principal achievement of the war. The enlargement of territory stipulated for by Russia under the treaty

The Elective

Vladikas.

chiefs and people, and consecrated by the patriarch of Ipek. The elective *vladikas* were aided in matters relating to national defence by a civil governor. The institution of a theocratic sovereignty probably saved the country from absorption in the Turkish Empire, the supreme power being vested in a sacrosanct person, whose position was unattainable by ambitious chieftains, and whose holy office precluded the possibility of his defection to Islam. The earlier *vladikas* were left comparatively unmolested by the Turks, and were enabled to devote their attention to the issue of numerous psalters, missals and gospels from the printing-press at Obod. But the beginning of the 17th century was marked by renewed Turkish aggression. Cettigne was taken in 1623 and again in 1687, when the monastery of Ivan the Black was blown up by the monks; a tribute was for a time imposed on the mountaineers, but the bolder spirits maintained their resistance in the heights, and the invading armies found it impossible to prolong their stay in these inhospitable regions.

In 1696 it was decided to continue the hereditary principle with the theocratic system, and Danilo Petrovitch of Niegush, the first ruler of the present reigning family, was nominated *vladika* with power to select his successor from among his relatives. The succession was henceforth regularly from uncle to nephew, owing to the rule of celibacy imposed on the monastic order. The reign of Danilo I. was memorable for the massacre of the Moslems settled in the principality (the "Montenegrin vespers") on Christmas Eve 1702, the great defeat of the Turkish invaders at Tzarevlatz (1712), the capture of Cettigne by the Turks and the destruction for the third time of its monastery (1714), and the inauguration of the intimate relations which have ever since existed with Russia by the visit of the *vladika* to Peter the Great in 1715. With Russian aid Danilo was enabled in some degree to repair the ruin which had overtaken his little realm. In the time of his successor Sava (1737-1782) an impostor named Stephan Mali, who represented himself as the Russian emperor Peter III., won the confidence of the Montenegrins, and governed the country with ability for several years (1768-1773), the mountaineers defeating the combined efforts of the Turks and

The House of Petrovitch.

chiefs and people, and consecrated by the patriarch of Ipek. The elective *vladikas* were aided in matters relating to national defence by a civil governor. The institution of a theocratic sovereignty probably saved the country from absorption in the Turkish Empire, the supreme power being vested in a sacrosanct person, whose position was unattainable by ambitious chieftains, and whose holy office precluded the possibility of his defection to Islam. The earlier *vladikas* were left comparatively unmolested by the Turks, and were enabled to devote their attention to the issue of numerous psalters, missals and gospels from the printing-press at Obod. But the beginning of the 17th century was marked by renewed Turkish aggression. Cettigne was taken in 1623 and again in 1687, when the monastery of Ivan the Black was blown up by the monks; a tribute was for a time imposed on the mountaineers, but the bolder spirits maintained their resistance in the heights, and the invading armies found it impossible to prolong their stay in these inhospitable regions.

Prince Nicholas.

Shortly after the accession of Prince Nicholas (Aug. 13, 1860), an insurrection broke out in Herzegovina, and the sympathy which the mountaineers displayed with their Christian kinsmen led to a rupture with Turkey (1862). Notwithstanding the heroic defence of Ostrog by the prince's father, Mirko, the war proved disastrous, owing to the superior armament and discipline of the Turkish troops, and severe terms were imposed on the principality by the convention of Scutari (Aug. 31). During the fourteen years of peace which followed, the country suffered greatly from pestilence and famine. Within this period a series of reforms were carried out by the prince: the army was rearmed and reorganized, an educational system was initiated, and a constitution under which the prince surrendered various prerogatives to the Senate was granted. In 1869 the Krivoshtians, or Serb inhabitants of the northern shores of the Bocche di Cattaro, rose against the Austrian government; the excitement in Montenegro was intense, but the prince succeeded in checking the warlike ardour of his subjects. The revolt in Bosnia and Herzegovina in 1875 had more important consequences for the principality. On the 2nd of July 1876 Prince Nicholas, in alliance with Prince Milan of Serbia, declared war against Turkey and invaded Herzegovina. A victory was gained at Vuchidol (July 28), and Medun was captured; but the Servian army suffered reverses, and an armistice was arranged in November. In the following spring the determination of Russia to take the field against Turkey encouraged the Montenegrins to renew the war. The Turks succeeded in occupying Ostrog, but were subsequently repulsed; the greater part of their forces was soon withdrawn to Bulgaria, and Prince Nicholas captured successively Nikshitch, Antivari and Dulcigno. The recovery of the seaboard, which had belonged to Montenegro in the middle ages, was perhaps the principal achievement of the war. The enlargement of territory stipulated for by Russia under the treaty

of San Stefano (March 3, 1878) would have brought Montenegro into close contiguity with Servia, thus facilitating the eventual union of the Serb race and closing the path of Austria towards the Aegean. The Berlin Treaty (article xxvii), gave to Montenegro Nikshitch, Spuzh, Podgorizza, Plava, Gusinye and Antivari, but restored Dulcigno to Turkey. The resistance of the Moslem inhabitants of Plava and Gusinye to annexation led to long negotiations, and eventually the "Corti Compromise" was agreed to by a conference of the Powers at Constantinople (April 18, 1880). Plava and Gusinye were to be restored to Turkey, while the Montenegrin frontier was extended so as to include the Hoti and the greater part of the Klementi tribes. This arrangement, which could hardly have proved successful, was not carried out by Turkey, and the Powers subsequently decided to annex Dulcigno to Montenegro in exchange for Plava and Gusinye. The Porte interposed delays, though consenting in principle, and the Albanian League (see ALBANIA) assumed a menacing attitude. On the 28th of September the fleets of the Powers under Admiral Seymour appeared off Dulcigno, and the British government shortly afterwards proposed to occupy Smyrna. On the 11th of November the Porte yielded; on the 22nd the Turkish troops defeated the Albanians, and on the 25th Montenegro obtained possession of Dulcigno. The present frontier, as already described, was shortly afterwards delimited by an international commission. With the exception of some frontier troubles, the years since 1880 have been spent in peace, and the country has advanced in prosperity under the autocratic but enlightened rule of Prince Nicholas. The relations with Turkey, the traditional foe, have improved, while those with Austria have become less friendly. In July 1893 the four-hundredth anniversary of the foundation of the printing-press at Obod was celebrated at Cetigne, several foreign universities and learned bodies being represented at the festivities. In September 1896 the bi-centenary of the Petrovitch dynasty was commemorated. The marriage in the same year of Princess Helen, fourth daughter of Prince Nicholas, with the crown prince of Italy, subsequently King Victor Emmanuel III., led to an increase of Italian influence in the principality. In December 1900 Prince Nicholas assumed the title "Royal Highness." In October 1906 the first Montenegrin parliament assembled at Cetigne; and on the 28th of August 1910, Prince Nicholas (g.g.) assumed the title of king.

AUTHORITIES.—Militinovich, *Historia di Montenegro* (in Russian), (St Petersburg, 1835); Wilkins, *Dalmatia and Montenegro* (London, 1848); Vuk Karajich, *Montenegro und die Montenegriner* (Stuttgart, 1857); Kallay, *Geschichte der Serben von den ältesten Zeiten bis 1815* (trans. from the Hungarian by J. H. Schwicker; Budapest, 1885); Servian trans., *Istoria Srpskoga naroda*, (Belgrade, 1876); Frilley and Wlahowitj, *Le Monténégro contemporain* (Paris, 1876); Rash, *Montenegro* (Leipzig, 1877); Milakovich, *Storia del Montenegro* (Ragusa, 1877); Gopchevitch, *Montenegro und die Montenegriner* (Leipzig, 1877); Yriarte, *Les Bords de l'Adriatique et le Monténégro* (Paris, 1878); Stefanovitch von Vilovo, *Wanderungen durch Montenegro* (Vienna, 1880); Chindina, *Storia del Montenegro* (Spalato, 1882); Tietze, *Geologische Uebersicht von Montenegro* (Vienna, 1884); Rovinsky, *Tchernagora* (in Russian; St Petersburg, 1888); Duchitch, *Tzernagora* (in Servian; Belgrade, 1891); Medakovich, *Pietro II. Petrovic Niegus* (Neusatz, 1892); Hassert, *Reise durch Montenegro* (Vienna, 1893); Couelle, *Histoire du Monténégro et de la Bosnie* (Paris, 1895); Miller, *The Balkans*, pp. 353-468 (London, 1896); Mantegazza, *Al Montenegro* (Florence, 1896); Tomanovitch, *Petar Drugi Petrovitch Niegosh* (Cetigne, 1896); Antonio Martini, *Il Montenegro* (Turin, 1897); Bouchier, "Montenegro and her Prince," in *Zeitschrift für Reisen* (December, 1898); Rouvaratz, *Monténégro* (in Servian; Smilna, 1899); Geichlich, *La Zedda e la Cinastia dei Balisti* (Spalato, 1899); R. Wyon and G. France, *The Land of the Black Mountain* (London, 1903). The best map is that of the Austrian staff. (J. D. B.)

MONTE OLIVETO MAGGIORE, a monastery of Tuscany, Italy, 6 m. S. of Asciano. It was founded in 1320, and is mainly celebrated for the beautiful frescoes in the monastery court, which are by Luca Signorelli (1497-1498) and Antonio Bazzi, called Sodoma (1505), representing scenes from the legend of St Benedict. The church and library contain fine inlaid wood-work by Fra Giovanni da Verona.

MONTEPULCIANO, a town and episcopal see of the province of Siena, Tuscany, Italy, 44 m. S.E. of Siena by rail. Pop. (1901), 6288 (town); 15,384 (commune). The town, 6 m. W. of

the station, crowns the summit of a hill (1084 ft.), and is surrounded by medieval walls. It is not traceable in history before A.D. 715. It was under the protection of Siena till 1202, when it declared for Florence and thenceforward passed from one mistress to the other, until early in the 16th century when it finally became Florentine. In 1561 it became an episcopal see. Most of the buildings belong to the Renaissance; except the castle, the 14th-century Palazzo Pubblico, and the portals of two or three churches, especially that of S. Maria (13th century). There are a number of fine private houses, some built by Antonio da Sangallo the elder (1455?-1534) and Baldassare Peruzzi (1481-1536) and others by Vignola (1507-1573). The beautiful church of the Madonna di S. Biagio—probably Sangallo's masterpiece—was built in 1518-1537. The cathedral built by Bartolommeo Ammanati (1570), modified by Ippolito Scalza, and completed in 1680 (with the exception of the façade, which is still unfinished) contains a large altar-piece by Taddeo di Bartolo of Siena, and the fragments of an imposing monument erected in 1427-1436 by the Florentine architect Michelozzo in honour of Bartolommeo Aragazzi, secretary of Pope Martin V., which was taken down in the 18th century. The façade of S. Agostino is probably also Michelozzo's work. Montepulciano is famous for its wine, and was the birthplace of the scholar and poet Angelo Anbrogini (1454-1494), generally known as Poliziano (Politian) and of Cardinal Bellarmine (1542-1621).

See F. Bargagli-Petrucchi, *Montepulciano, Chiusi, &c.* (Bergamo, 1907).

MONTEREAU, a town of northern France, in the department of Seine-et-Marne at the confluence of the Yonne with the Seine, 21 m. S.E. of Melun by rail. Pop. (1906), 7870. The church dates from the 13th century, with a façade of the Renaissance period. The industries include the manufacture of porcelain, fire-proof and decorative bricks, boots and shoes and agricultural machines and colours, varnish, &c. Among the institutions are a tribunal of commerce and a chamber of arts and manufactures.

Monterceau was in the beginning of the 15th century a place of some importance. Here, on the bridge over the Yonne, Jean Sans-Peur, duke of Burgundy was assassinated in the presence of the Dauphin, afterwards Charles VII., in 1419. In 1438 the town was captured by Charles VII., and during the wars of religion it was several times taken and retaken. In 1814 Napoleon gained a victory at Monterceau over the Würtemberg troops under Schwarzenberg, and in memory of this his statue has been erected on the bridge.

MONTEREY, a city of Monterey county, California, U.S.A., on the Pacific coast, about 90 m. in a straight line S. by E. from San Francisco, at the S.E. extremity of the Gulf of Monterey, a great open bay 22 m. wide from headland to headland and facing S.W. The harbour is protected by a peninsula extending N.W. Pop. (1900), 1748, largely of Spanish descent; (1910) 4923. It is served by the Southern Pacific railroad, and for freight by the Pacific Coast Steamship Co. It is built in an amphitheatre formed by gently sloping pine-clad hills. In 1881 the Southern Pacific Company erected the Del Monte hotel, with beautiful grounds several miles in extent, and since then the city has come to be one of the favourite resorts of the Pacific coast. The difference between the mean temperatures of the coldest and warmest months of the year (rarely below 47° or above 66° F. respectively) is from 10° to 20°; while the thermometer rarely registers below freezing or above 80° F. Within the city limits there is a United States Army post, the Presidio of Monterey, with a musketry school. There are sardine canneries here and good salmon and other fishing; some salmon are shipped to Germany to be smoked. In 1907 the south side of the Gulf of Monterey was made by the state legislature into a preserve for squid and other food for salmon. To San Francisco, Hawaii, Alaska, and elsewhere, Monterey ships annually about 60,000 tons of crude oil, piped here into great steel tanks from the Coalinga oil fields 112 m. away. Sand lime brick is manufactured here.

Before the coming of the Americans, Monterey was the gayest and most ambitious city of California. It was discovered by Sebastian Vizcaino in December 1602, and was named in honour of the then viceroy of New Spain. For a time all trace was lost of Monterey, but in May 1770 the bay was found again by Junípero Serra and Captain Gaspar de Portolá. The San Carlos mission of the Franciscans was founded on the 3rd of June 1770, and a presidio was completed in 1778. Near Monterey, in Carmel Valley, whither the mission was almost immediately removed, Father Junípero built a church, in which his remains now rest. In 1801 a statue, representing Junípero stepping from a boat, was erected on the site of the old Mexican fort, on a hill near the landing-place of both Vizcaino and Junípero. Monterey necessarily played a prominent part in the jealousies that divided the north and south; the rivalry of Los Angeles for the dignity of capital being a powerful influence in politics from 1827-1846. In 1845 Los Angeles gained the prize, but in 1847 the American authorities again made Monterey the capital. Even in these years the treasury, custom-house and military headquarters had remained at Monterey. In 1818 it was captured and momentarily held by a Buenos Aires privateer. Here, in 1842, Commodore T. ap C. Jones raised the flag of the United States for a day, and here on the 7th of July 1846, Commodore J. D. Sloat again raised the same flag, which this time was not to come down again. The first American newspaper on the Pacific coast was published at Monterey; and the convention that framed the first constitution of the state met here in September 1849 in Colton Hall, still standing and originally built for a schoolhouse by Walter D. Colton, the first alcalde under American rule. Monterey was never the capital of the new state, and its importance declined after the discovery of gold near Sacramento, San Francisco becoming the leading city. In 1872 the county-seat was removed from Monterey to Salinas. For many years Monterey remained one of the most Spanish towns of California, and though tourists have somewhat disturbed its peace and checked its decay, it still retains much of the quaint aspect and the drowsy contentment of spirit of Mexican days. Since 1900 the population has considerably increased.

MONTERREY (usually spelled Monterey in English), a city of Mexico and capital of the state of Nuevo León, 606 m. by the old wagon road, and 671 m. by the Mexican National railway N. by W. of the city of Mexico, in lat. 25° 40' N., long. 100° 25' W. Pop. (1900), 62,266. Railway communications are provided by the Mexican National with the United States, with the national capital and southern Mexico, and with Matamoros, and by the Belgian line with Tampico on the Gulf coast, and with Treviño, or Venadito, on the Mexican International line, which gives access to the iron deposits of Durango. The city stands 1624 ft. above sea-level, between two spurs of one of the Sierra Madre ranges—the Cerro de la Silla (4149 ft.) on the east, and the Cerro de las Mitras (3618 ft.) on the west. The Santa Catarina river furnishes water-power for some of its industries. The surrounding district is fertile, and the rainfall about 22 in. The climate is dry and mild, and the city is frequented in winter by invalids from the United States. Monterey is laid out with broad, straight streets crossing each other at right angles, and spreads over a large area. It is the see of the bishop of Linares, and has a large cathedral, a bishop's palace and numerous churches. Among the public edifices are the government palace, municipal hall, national college, girls' college, medical school, public hospital, theatre and penitentiary. Its public works include an interesting old reservoir, called the "Ojo de Agua," and the "Puente Nuevo" (new bridge). Monterey is the most important centre of northern Mexico, and large sums of foreign capital have been invested in its industries. Among its manufactures are woollen mills, smelting works, brass and iron foundries, a steel producing plant, saw-mills, flour-mills, breweries, and a carriage and wagon factory.

Monterrey was founded in 1560 under the name of Santa Lucía de León; and in 1596, as Monterey, was raised to the dignity of a city. In 1777 it became the see of a bishop, now

suffragan to the archbishop of Guadalajara. During the war between Mexico and the United States General Zachary Taylor arrived before the city on the 19th of September 1846, with about 6600 men. Monterey was defended by a Mexican force of about 10,000 under General Pedro de Ampudia. On the 20th Colonel John Garland (1792-1861) assaulted the lower (north-eastern) part of the city; he was driven back, but captured one of the forts. The attacks on the other forts on the east were unsuccessful. On the 21st and 22nd General W. J. Worth carried the forts west of Monterey, and on the 23rd attacked the western part of the city, the troops slowly working their way toward the central plaza. On the same day American troops again advanced from the east, and were again forced back. On the morning of the 24th the terms of a capitulation were agreed upon—the Mexicans were permitted to retire, retaining their small arms and one field battery of six pieces with twenty-one rounds of ammunition, and an armistice of eight weeks was arranged. A disastrous flood, caused by heavy rains and the sudden overflow of the Santa Catarina river on the 28th of August 1900, swept away about one-fourth of the city, drowning 1200-1400 persons, and destroying about \$12,000,000 (Mex.) worth of property.

MONTE SAN GIULIANO, a town and episcopal see of Sicily, in the province of Trapani, 2 m. E.N.E. of Trapani, on the summit of an isolated bare hill, 2465 ft. above the sea. Pop. of commune (1901), 28,939; of town, about 3000. The town occupies the site of the ancient *Eryx*, a city of the Elymi, a people who claimed to be sprung from a mixed settlement of Trojans and Phocians after the fall of Troy (E. A. Freeman, *History of Sicily*, i. 195, 542), but regarded as *βάρβαροι* by the Greeks. The city was famous for the temple of Venus Erycina, to the foundations of which a wall of 12 courses of masonry in the castle probably belongs. The worship was a relic of the Phœnician cult of Astarte. In 415 B.C. the Athenian envoys were shown the treasure of the temple at Eryx as available for the expenses of the war, which treasure turned out to be only silver-gilt and not of solid gold (Thucydides vi. 46). The town must have become a part of the Carthaginian dominion in 405 B.C. It was seized by Pyrrhus in 278 B.C., and was ceded to Rome at the end of the First Punic War. In Roman times the temple (like that of Diana Tifatana, near Capua) possessed territory of its own, being dependent neither on the state nor on any neighbouring town, and a considerable number of female slaves. The place was the residence of the quaestor in charge of the western half of the island, and Verres, as praetor, seems to have spent a good deal of time here. Considerable portions of the city wall are preserved on the north-west; on the east and south the precipitous cliffs formed a sufficient defence. The remains date from a reconstruction of Roman times, in which the material of two earlier periods has been used: the large blocks belonging to the original fortifications bear Phœnician masons' marks; but the long line of towers at regular intervals is a thoroughly Roman characteristic. The castle, dating from the middle ages, with three lofty towers guarding the entrance, occupies the south-eastern extremity of the town. The cathedral, founded in 1314, has a fine porch and Gothic facade.

MONTE SAN SAVINO, a town of Tuscany, Italy, in the province of Arezzo, from which it is 12 m. S.W. by road, 1083 ft. above sea-level. Pop. (1901), 4810 (town); 8498 (commune). It was the birthplace of the sculptor and architect Andrea Contucci, generally known as Sansovino (1460-1529), and there are various works in the town by him, a loggia opposite the Palazzo Municipale (itself by Antonio da Sangallo the elder and one of his best works), the monastery courts of S. Agostino and S. Giovanni Battista, and some sculptures.

MONTE SANT' ANGELO, a town of Apulia, Italy, in the province of Foggia, 10 m. N. of Manfredonia by road, 2765 ft. above sea-level, on the southern slopes of Monte Gargano. Pop. (1901), 17,360 (town); 21,997 (commune). It has a castle and a famous

¹ This has been demonstrated by O. Richter, *Über antike Steinmetzzeichen* (Berlin, 1885), pp. 43-51.

sanctuary of S. Michele, founded in 491 over a cave in which the archangel is said to have appeared to S. Laurentius, archbishop of Sipontum; the bronze doors, made in Constantinople, bear the date 1076. The octagonal campanile dates from 1273. The portal of S. Maria Maggiore is noteworthy. The Tomba di Rotari is a domed building of the Norman period. To the north lies the highest point of the Monte Gargano (3460 ft.). Strabo speaks of an oracle of Calchas on the top of the mountain, and a healing spring at Podalirius at the bottom, 12 m. from the sea.

See S. Beltramelli, *Il Gargano* (Bergamo, 1907).

MONTESPAN, FRANÇOIS-ATHENAÏS DE PARDAILLAN, MARQUISE DE (1641-1707), mistress of Louis XIV., was born at the château of Tonnay-Charente (Charente-Inférieure), the daughter of Gabriel de Rochechouart, duc de Mortemart. She was educated at the Convent of St Mary at Saintes, and when she was twenty she became maid-of-honour to Queen Maria Theresa. She married in January 1663 L. H. de Pardaillan de Gondrin, marquis de Montespan, who was a year younger than herself. By him she had two children, L. H. Pardaillan de Gondrin, duc d'Antin, born in 1665, and a daughter. Her brilliant and haughty beauty was only one of the Montespan's charms; she was a cultivated and amusing talker who won the admiration of such competent judges as Saint-Simon and Mme de Sévigné. Nevertheless she was a profound believer in witchcraft, and La Reynie, the chief judge of the court before which the famous poisoning cases were brought, places her first visits to La Voisin (q.v.) in 1665. She received from the sorceress love powders concocted of abominable ingredients for Louis XIV., and in 1666 the "black mass" was said by the priest Étienne Guibourg over her with the usual horrible ceremonial. In 1667 she gained her end, becoming Louis XIV.'s mistress in July. Montespan astounded the court by openly resenting his wife's position. He made a scandal by accusing Mme de Montespan of acting as go-between in order to secure the governorship of the dauphin for her husband. He even wore mourning for his wife. Montespan was arrested, but released after a few days' imprisonment. The first of the seven children whom Mme de Montespan bore to the king was born in March 1669, and was entrusted to Mme Scarron, the future Mme de Maintenon, who acted as companion to Mme de Montespan while the king was away at the wars. Her children were legitimized in 1673 without mention of the mother's name for fear that Montespan might claim them. The eldest, Louis Auguste, became duc de Maine, the second, Louis César, comte de Vexin, and the third, Louis François, demoiselle de Nantes (afterwards duchess of Bourbon). Meanwhile Montespan had been compelled to retire to Spain, and in 1674 an official separation was declared by the *procureur-général* Achille de Harlay, assisted by six judges at the Châtelet. When Louis's affections showed signs of cooling, Mme de Montespan had recourse to magic. In 1675 absolution was refused to the king, with the result that his mistress was driven from the court for a short time. It has been thought that she had conceived the intention of poisoning even as early as 1676, but in 1679 Louis's intrigue with Angélique de Fontanges and her own relegation to the position of superintendent of the queen's household brought matters to a crisis. Mlle de Fontanges died a natural death in 1681, though poisoning was suspected. Meanwhile suspicion was thrown on Mme de Montespan's connexion with La Voisin and her crew by the frequent recurrence of her maid's name, Mlle Desoillets, in the evidence brought before the Chambre Ardente. From the end of 1680 onwards Louvois, Colbert and Mme de Maintenon all helped to hush up the affair and to prevent further scandal about the mother of the king's legitimized children. Louis XIV. continued to spend some time daily in her apartments, and apparently her brilliance and charm in conversation mitigated to some extent her position of discarded mistress. In 1691 she retired to the Convent of St Joseph with a pension of half a million francs. Her father was governor of Paris, her brother, the duc de Vivonne, a marshal of France, and one of her sisters,

Gabrielle, whose vows were but four years old, became abbess of the wealthy community of Fontevault. Besides the expenses of her houses and equipage Mme de Montespan spent vast sums on hospitals and charities. She was also a generous patron of letters, and befriended Corneille, Racine and La Fontaine. The last years of her life were given up to penance. When she died at Bourbon l'Archambault on the 27th of May 1707 the king forbade her children to wear mourning for her. Real regret was felt for her by the duchess of Bourbon and by her younger children—Françoise Marie, Mlle de Blois (1677-1749), married in 1692 to the future regent Orleans, then duc de Chartres, and Louis Alexandre, comte de Toulouse (1678-1737).

See P. Ciément, *Madame de Montespan et Louis XIV.* (Paris, 1869); monographs by Arsène Houssaye (1865) and by H. Williams (1903); also J. Jaur, *Louise de la Vallière* (Eng. trans., 1908); F. Funck-Brentano, *Le Drame des poisons* (1899); A. Durand, "Un épisode du grand règne" in *Rev. des questions hist.* (Paris, 1868); the contemporary memoirs of Mme de Sévigné, of Saint-Simon, of Bussy-Rabutin and others; also the proceedings of the Chambre Ardente preserved in the *Archives de la Bastille* (Arsenal Library) and the notes of La Reynie preserved in the Bibliothèque Nationale. She figured in V. Sardou's play, *L'Affaire des poisons* (1907).

MONTESQUIEU, CHARLES LOUIS DE SECONDAT, BARON DE LA BRÈDE ET DE (1689-1755), French philosophical historian, was born at the château of La Brède, about 10 m. south-east of Bordeaux, in January 1689, and was baptized on the 18th of that month. His mother was Marie Françoise de Penel, the heiress of a Gascon-English family. She had brought La Brède as a dowry to his father, Jacques de Secodant, a member of a good if not extremely ancient house, which seems first to have risen to importance in the early days of the 16th century. The title of Montesquieu came from his uncle, Jean Baptiste de Secodant, "président à mortier" in the parliament of Bordeaux—an important office, which, as well as his title, he left to his nephew. Montesquieu was in his youth known as M. de la Brède. His mother died when he was seven years old, and when he was eleven he was sent to the Oratorian school of Juilly, near Meaux, where he stayed exactly five years, and where, as well as afterwards at Bordeaux, he was thoroughly educated. The family had long been connected with the law, and Montesquieu was destined for that profession. His father died in 1713, and a year later Montesquieu was admitted counsellor of the parliament. In little more than another twelvemonth he married Jeanne Lartigue, an heiress and the daughter of a knight of the order of St Louis, but plain, somewhat ill-educated, and a Protestant. Montesquieu does not seem to have made the slightest pretence of affection or fidelity towards his wife, but there is every reason to believe that they lived on perfectly good terms. In 1716 his uncle died, leaving him his name, his important judicial office and his whole fortune.

He continued to hold his presidency for twelve years, and took part in the proceedings of the Bordeaux Academy, to which he contributed papers on philosophy, politics and natural science. He also wrote much less serious things, and it was during the earlier years of his presidency that he finished, if he did not begin, the *Lettres persanes*. They were completed before 1721, and appeared in that year anonymously, with Cologne on the title-page, but they were really printed and published at Amsterdam. In the guise of letters written by and to two Persians of distinction travelling in Europe, Montesquieu not only satirized unmercifully the social, political, ecclesiastical and literary follies of his day in France, but indulged in a great deal of the free writing which was characteristic of the tale-tellers of the time. But what scandalized grave and precise readers naturally attracted the majority, and the *Lettres persanes* were very popular, passing, it is said, through four editions within the year, besides piracies. Then the vogue suddenly ceased, or at least editions ceased for nearly nine years to appear. It is said that a formal ministerial prohibition was the cause of this, and it is not improbable; for, though the regent and Guillaume Dubois must have enjoyed the book thoroughly, they were both shrewd enough to perceive that underneath its playful exterior there lay a spirit of

very inconvenient criticism of abuses in church and state. The fact is that the *Lettres persanes* is the first book of what is called the Philosophie movement. It is amusing to find Voltaire describing the *Lettres* as a "trumpery book," a "book which anybody might have written easily." It is not certain that, in its peculiar mixture of light badinage with not merely serious purpose but gentlemanlike moderation, Voltaire could have written it himself, and it is certain that no one else at that time could.

The reputation acquired by this book brought Montesquieu much into the literary society of the capital, and he composed for, or at any rate contributed to, one of the coteries of the day the clever but rather rhetorical *Dialogue de Sylla et d'Euclate*, in which the dictator gives an apology for his conduct. For Mlle de Clermont, a lady of royal blood, a great beauty and a favourite queen of society, he wrote the curious prose-poem of the *Temple de Guide*. This is half a narrative, half an allegory, in the semi-classical or rather pseudo-classical taste of the time, decidedly frivolous and dubiously moral, but of no small elegance in its peculiar style. A later *jeu d'esprit* of the same kind, which is almost but not quite certainly Montesquieu's, is the *Voyage à Paphos*, in which his warmest admirers have found little to praise. In 1725 Montesquieu was elected a member of the Academy, but an almost obsolete rule requiring residence in Paris was appealed to, and the election was annulled. It is doubtful whether a hankering after Parisian society, or an ambition to belong to the Academy, or a desire to devote himself to literary pursuits of greater importance, or simple weariness of not wholly congenial work determined him to give up his Bordeaux office. In 1726 he sold the life-tenure of his office, reserving the reversion for his son, and went to live in the capital, returning, however, for half of each year to La Brède. There was now no further formal obstacle to his reception in the Académie Française, but a new one arose. Ill-wishers had brought the *Lettres persanes* specially under the minister André Hercule de Fleury's attention, and Fleury, a precisian in many ways, was shocked by them. There are various accounts of the way in which the difficulty was got over, but all seem to agree that Montesquieu made concessions which were more effectual than dignified. He was elected and received in January 1728.

Almost immediately afterwards he started on a tour through Europe to observe men, things and constitutions. He travelled through Austria to Hungary, but was unable to visit Turkey as he had proposed. Then he made for Italy, where he met Chesterfield. At Venice, and elsewhere in Italy, he remained nearly a year, and then journeyed by way of Piedmont and the Rhine to England. Here he stayed for some eighteen months, and acquired an admiration for English character and polity which never afterwards deserted him. He returned, not to Paris, but to La Brède, and to outward appearance might have seemed to be settling down as a squire. He altered his park in the English fashion, made sedulous inquiries into his own genealogy, arranged an entail, asserted, though not harshly, his seigniorial rights, kept poachers in awe and so forth. But these matters by no means engrossed his thoughts. In his great study at La Brède (a hall rather than a study, some 60 ft. long by 40 wide) he was constantly dictating, making abstracts, revising essays, and in other ways preparing his main book. He may have thought it wise to soften the transition from the *Lettres persanes* to the *Esprit des lois*, by interposing a publication graver than the former and less elaborate than the latter. The *Considérations sur les causes de la grandeur et de la décadence des Romains* appeared in 1734 at Amsterdam, without the author's name. This, however, was perfectly well known; indeed, Montesquieu formally presented a copy to the French Academy. But the author's reputation as a jester stuck to him, and the salons affected to consider the *Lettres persanes* and the new book respectively as the "grandeur" and the "décadence de" M. de Montesquieu; but more serious readers at once perceived its extraordinary merit, and it was eagerly read abroad. A copy of it exists or existed which had the singular misfortune to be annotated by Frederick the Great, and to be abstracted from

the Potsdam library by Napoleon. It is said, moreover, by competent authorities to have been the most enduringly popular and the most widely read of all its author's works in his own country, and it was certainly been the most frequently and carefully edited. Merely scholastic criticism may of course object to it, as to every other book of the time, the absence of the exactness of modern critical inquiry into the facts of history; but the virtue of Montesquieu's book is in its views, not in its facts. It is (putting Bossuet and Giovanni Vico aside) almost the first important essay in the philosophy of history. The point of view is entirely different from that of Bossuet, and it seems entirely improbable that Montesquieu knew anything of Vico. In the *Grandeur et décadence* the characteristics of the *Esprit des lois* appear with the necessary subordination to a narrower subject. Two things are especially noticeable in it: a peculiarity of style, and a peculiarity of thought. The style has a superficial defect. The page is broken up into short paragraphs of but a few lines each, which look very ugly, which irritate the reader by breaking the sense, and which prepare him to expect an undue and ostentatious sententiousness. On the other hand, the merits of the expression are very great. It is grave and destitute of ornament, but extraordinarily luminous and full of what would be called epigram, if the word epigram had not a certain connotation of flippancy about it. It is a very short book; for, printed in large type with tolerably abundant notes, it fills but two hundred pages in the standard edition of Montesquieu's works. But no work of the century, except Turgot's second Sorbonne *Discourse*, contains, in proportion to its size, more weighty and original thought on historical subjects, while Montesquieu has over Turgot the immense advantage of style.

Although, however, this *ballon d'essai*, in the style of his great work, may be said to have been successful, and though much of that work was, as we have seen, in all probability already composed, Montesquieu was in no hurry to publish it. He went on "cultivating the garden" diligently both as a student and as an improving landowner. He wrote the sketch of *Lysimaque* for Stanislaus Leczinski; he published new and final editions of the *Temple de Guide*, of the *Lettres persanes*, of *Sylla et Euclate* (which indeed had never been published, properly speaking). After allowing the *Grandeur et décadence* to be reprinted without alterations some half-dozen times, he revised and corrected it. He also took great pains with the education of his son Charles and his daughter Denise, of whom he was extremely fond. He frequently visited Paris, where his favourite resorts were the salons of Mme de Tencin and Mme d'Aiguillon. Yet it seems that he did not begin the final task of composition till 1743. Two years of uninterrupted work at La Brède finished the greater part of it, and two more the rest. It was finally published at Geneva in the autumn of 1748, in two volumes quarto. The publication was, however, preceded by one of those odd incidents which in literature illustrate Clive's well-known saying about courts-martial in war. Montesquieu summoned a committee of friends, according to a very common practice, to hear and give an opinion on his work. It was an imposing and certainly not an unfriendly one, consisting of Charles Jean François Hénault, Helvétius, the financier Etienne de Silhouette, the dramatist Joseph Saurin, Crébillon the younger, and, lastly, Fontenelle—in fact, all sorts and conditions of literary men. They unanimously advised the author not to publish a book which has been described as "one of the most important books ever written," and which may be almost certainly ranked as the greatest book of the French 18th century.

Montesquieu, of course, did not take his friends' advice. In such cases no man ever does, and in this case it was certainly fortunate. The *Esprit des lois* represents the reflections of a singularly clear, original, and comprehensive mind, corrected by forty years' study of men and books, arranged in accordance with a long deliberated plan, and couched in language of remarkable freshness and idiosyncrasy. In the original editions the full title runs *L'Esprit des lois: ou du rapport que les lois*

doivent avoir avec la constitution de chaque gouvernement, les mœurs, le climat, la religion, le commerce, &c. It consists of thirty-one books, which in some editions are grouped in six parts. Speaking summarily, the first part, containing eight books, deals with law in general and with forms of government; the second, containing five, with military arrangements, with taxation, &c.; the third, containing six, with manners and customs, and their dependence on climatic conditions; the fourth, containing four, with economic matters; and the fifth, containing three, with religion. The last five books, forming a kind of supplement, deal specially with Roman, French, and feudal law. The most noteworthy peculiarity of the book to a cursory reader lies in the section dealing with effects of climate, and this indeed was almost the only characteristic which the vulgar took in, probably because it was easily susceptible of parody and *reductio ad absurdum*. The singular spirit of moderation which distinguishes his views on politics and religion was indeed rather against it than in its favour in France, and Helvétius, who was as outspoken as he was good-natured, had definitely assigned this as the reason of his unfavourable judgment. On the other hand, if not destructive it was sufficiently critical, and it thus raised enemies on more than one side. It was long suspected, but is now positively known, that the book (not altogether with the goodwill of the pope) was put on the Index, and the Sorbonne projected, though it did not carry out, a regular censure. To all these objectors the author replied in a masterly *defense*; and there seems to be no foundation for the late and scandalous stories which represent him as having used Mme de Pompadour's influence to suppress criticism. The fact was that, after the first snarlings of envy and incompetence had died away, he had little occasion to complain. Even Voltaire, who was his decided enemy, was forced at length to speak in public, if not in private, complementarily of the *Esprit*, and from all parts of Europe the news of success arrived.

Montesquieu enjoyed his triumph rather at La Brède than at Paris. He was becoming an old man, and, unlike Fontenelle, he does not seem to have preserved in old age the passion for society which had marked his youth. He certainly spent much of his later years in the country, though he sometimes visited Paris, and on one visit procured the release of his admirer Laurent Angliviel de La Beaumelle from an imprisonment which La Beaumelle had suffered at the instance of Voltaire. He is said also to have been instrumental in obtaining a pension for Alexis Piron. Nor did he by any means neglect literary composition. The curious little romance of *Arsace et Isménie*, a short and unfinished treatise on Taste, many of his published *Pensees*, and much unpublished matter date from the period subsequent to the *Esprit des lois*. He did not, however, live many years after the appearance of his great work. At the end of 1754 he visited Paris, with the intention of getting rid of the lease of his house there and finally retiring to La Brède. He was shortly after taken ill with an attack of fever, which seems to have affected the lungs, and in less than a fortnight he died, on the 10th of February 1755, aged sixty-six. He was buried in the church of St Sulpice with little pomp, and the Revolution obliterated all trace of his remains.

The literary and philosophical merits of Montesquieu and his position, actual and historical, in the literature of France and of Europe, are of unusual interest. At the beginning of the next century the vicomte de Bonald classed him with Racine and Bossuet, as the object of a "religious veneration" among Frenchmen. But Bonald was not quite a suitable spokesman for France, and it may be doubted whether the author of the *Esprit des lois* has ever really occupied any such position in his own country. For a generation after his death he remained indeed the idol and the great authority of the moderate reforming party in France. Montesquieu is not often quotable, or quoted, at the present day, and the exact criticism of our time challenges the accuracy of his facts. Although he was really the founder, or at least one of the founders, of the sciences of comparative politics and of the philosophy of history, his descendants and

followers in these sciences think they have outgrown him. In France his popularity has always been dubious and contested. It is a singular thing that for more than a century there was no properly edited edition of his works, and nothing even approaching a complete biography of him, the place of the latter being occupied by the meagre and rhetorical *Éloges* of the last century. According to his chief admirers, he is hardly read at all in France to-day, and they attempt to explain the fact by confessing that Montesquieu, great as he is, is not altogether great according to French principles. It is not only that he is an Anglo-maniac, but that he is rather English than French in style and thought. He is almost entirely dispassionate in politics, but he lacks the unswerving deductive consistency which Frenchmen love in that science. His wit, it is said, is quaint and a little provincial, his style irregular and in no definite genre.

Some of these things may be allowed to exist and to be defects in Montesquieu, but they are balanced by merits which render them almost insignificant. It is on his three principal works that his fame does and must rest. Each one of these is a masterpiece in its kind. It is doubtful whether the *Lettres persanes* yield at their best either in wit or in giving lively pictures of the time to the best of Voltaire's similar work, though they are more unequal. There is, moreover, the great difference between Montesquieu and Voltaire that the former is a rational reformer, and not a mere *persifleur* or *frondeur*, to whom fault-finding is more convenient than acquiescence for showing off his wit. Of course this last description does not fully or always describe Voltaire, but it often does. It is seldom or never applicable to Montesquieu. Only one of Voltaire's own charges against the book and its author must be fully allowed. He is said to have replied to a friend who urged him to give up his habit of sneering at Montesquieu, "Il est coupable de lèse-poésie," and this is true. Not only are Montesquieu's remarks on poetry childish (he himself occasionally wrote verses, and very bad ones), but he is never happy in purely literary appreciation. The *Considerations* are noteworthy, not only for the complete change of style (which from the light and mocking tone of the *Lettres* becomes grave, weighty and sustained, with abundance of striking expression), but for the profundity and originality of the views, and for the completeness with which the author carries out his plan. These words—except, perhaps the last clause—apply with increasing force to the *Esprit des lois*. The book has been accused of desultoriness, but this arises, in part at least, from a misapprehension of the author's design. At the same time, it is impossible to deny that the equivocal meaning of the word "law," which has misled so many reasoners, has sometimes misled Montesquieu himself. For the most part, however, he keeps the promise of his sub-title (given above) with fidelity, and applies it with exhaustive care. It is only in the last few books, which have been said to be a kind of appendix, that something of irrelevancy suggests itself. The real importance of the *Esprit des lois*, however, is not that of a formal treatise on law, or even on polity. It is that of an assemblage of the most fertile, original and inspiring views on legal and political subjects, put in language of singular suggestiveness and vigour, illustrated by examples which are always apt and luminous, permeated by the spirit of temperate and tolerant desire for human improvement and happiness, and almost unique in its entire freedom at once from doctrinarism, from visionary enthusiasm, from egotism, and from an undue spirit of system. As for the style, no one who does not mistake the definition of that much used and much misused word can deny it to Montesquieu. He has in the *Esprit* little ornament, but his composition is wholly admirable. Yet another great peculiarity of this book, as well as of the *Considerations*, has to be noticed. The genius of the author for generalization is so great, his instinct in political science so sure, that even the falsity of his premises frequently fails to vitiate his conclusions. He has known wrong, but he has thought right.

The best edition of Montesquieu is that of Edouard Laboulaye (7 vols., Paris, 1875-1879), the best biography that of Louis Via

(Paris, 2nd ed., 1879). The bibliography of Montesquieu was dealt with by L. Dangeau in 1874. There is known to exist at La Brède a great mass of MS. materials for the *Esprit des lois*, additional *Lettres persanes*, essays, and fragments of all kinds, diaries, letters, notebooks and so forth. The present possessors, however, who represent Montesquieu, long refused permission to examine these to all editors and critics, and they were chiefly known by a paper contributed in 1834 to the *Transactions* of the Academy of Agén. At last in 1801 Baron Charles de Montesquieu published *Deux opuscules* of his ancestors, and in 1809 Baron Gaston de Montesquieu added *Pensées*, &c. Nothing, however, of much interest has yet appeared. For a thorough student *L'Esprit de Montesquieu* by A. Chabraux (1885) has value, for it is written, with some ability, from a point of view now very uncommon, that of a convinced Roman Catholic, anti-parliamentarian and anglophobe critic, who regards Montesquieu as an "evangelist of social atheism" and the like. The view is quite untenable but useful as a corrective. An article by Churton Collins on "Montesquieu in England" (*Quarterly Review*, No. 394, April 1903) may be also consulted.

(G. SA.)

MONTESQUIOU-FÉZENSAC, ANNE PIERRE, MARQUIS DE (1730-1708), French general and writer, was born in Paris on the 17th of October 1730, of an ancient family of Armagnac. He was brought up with the children of the king of France, and showed some taste for letters. He entered the army in 1754, was successively colonel of the Grenadiers and the Royal-Vaissaux regiment, and in 1780 was made *maréchal-de-camp*. Some pieces of verse and several comedies gained him admission to the French Academy in 1784. He was elected deputy to the states general of 1789 by the nobles of Paris, and, animated by Liberal ideas, he soon joined the Third Estate, and seconded Necker's financial schemes. He served on the committee charged with the issue of *assignats*, and was named president of the Constituent Assembly on the 14th of March 1791. In May 1791 he was promoted lieutenant-general, served under Lafayette, and in February 1792 was given the command of the Army of the South. In September of the same year he completed the conquest of Savoy, but in November 1792 he was accused of royalist leanings, and had to take refuge in Switzerland. In 1795 his name was erased from the list of *émigrés* and he returned to Paris, where he died on the 30th of December 1798.

See P. L. Roederer, *Éloge de Montesquieu*, reprinted in Roederer's *Works* (1853-1859).

MONTESSEON, CHARLOTTE JEANNE BÉRAUD DE LA HAYE DE RIOU, MARQUISE DE (1737-1805), was born in Paris of an old Breton family. About 1754 she married Jean Baptiste, marquis de Montesson, who died in 1769. Her beauty and intelligence attracted the attention of Louis Philippe, duke of Orleans, whom she secretly married in 1773 with the authorization of the king. For her husband's amusement she set up a little theatre and wrote several plays, in the acting of which she herself took part. She was imprisoned for some time during the Terror, but was released after the fall of Robespierre, became the friend of the empress Josephine, and was a prominent figure at the beginning of the empire.

The best edition of her works appeared under the title of *Œuvres anonymes* in 1782-1785. See Charles Collé, *Journal* (1868); the *Memoirs* of St Simon, Madame de Genlis, the duchesse d'Abrantès and Mme de Lévis; G. Sirenger, "La Société de la marquise de Montesson," in the *Nouvelle revue* (1902); J. Turquan, *Madame de Montesson douzière d'Orléans* (Paris, 1904); and G. Capon and R. Ivo-Plessis, *Les Théâtres clandestins du XVIII^e siècle* (1904).

MONTEVERDE, CLAUDIO (1567-1643), Italian priest and musician, was born at Cremona in May 1567; he was engaged at an early age as violist to the duke of Mantua, and studied composition under Ingegneri, the duke's maestro di capella. His bold experiments, while bringing upon him the attacks of Artusi and Banchieri (*q.v.*), led to discoveries which exercised a lasting influence upon the progress of musical art. He was the first to make deliberate use of unprepared dissonances, or what are now known as fundamental discords. These discords constituted a revolution against the laws of 16th century music. He employed them first in his madrigals, where they are a sign of decadence, but afterwards introduced them into music of another kind with such excellent effect that their

value was universally recognized. Before 1595 Monteverde was married to the singer Claudia Cattaneo, who died in 1607. In 1602 he succeeded Ingegneri as maestro di capella; and in 1607 he produced, for the marriage of Francesco Gonzaga, his first opera, *Ariana*, in which he employed the newly-discovered discords with irresistible effect. Though he did not invent the lyric drama—Pieri's *Euridice* having been produced at Florence in 1600—he raised it to a level which distanced all contemporary competition. His second opera, *Orfeo*, composed in 1608, was even more successful than *Ariana*. In 1613 Monteverde was invited to Venice, as maestro di capella at St Mark's, with a stipend of 300 ducats, which in 1616 was raised to 400. Here he composed much sacred music, the greater part of which is lost. In 1630 he wrote another grand opera, *Proserpina rapita*. He did not become a priest until 1632. In 1639 he produced *L'Adone*, and in 1641 *Le Nozze di Enea* and *Il Ritorno d'Ulisse*. He died in Venice on the 29th of November 1643. Monteverde's harmonic innovations and power of musical rhetoric seemed to put an end to the school of Palestrina, and led the way to modern music. (See *Muscic*.)

MONTEVIDEO, SAN FELIPE Y SANTIAGO DE, capital and chief port of Uruguay, and capital of the department of Montevideo, on the northern shore of the Rio de la Plata estuary, 120 m. E.S.E. of Buenos Ayres, in lat. 34° 54' 33" S., long. 56° 12' 18" W. Pop. (1908, estimate), 312,946. The old city (*ciudad vieja*) occupies a low rocky headland that projects westward between the estuary and an almost circular bay which forms the harbour; it was once enclosed with walls and defended by small forts, all of which have been removed. The new city (*ciudad nueva* and *ciudad novísima*) extends eastward over a beautiful tract of rolling country and is extending northward around the eastern shore of the bay. The site of the old city resembles a whale's back in shape; it slopes gently to its western extremity at Punta Sarandi and to the water's edge on either side. The general plan is that of rectangular squares, except at the western extremity of the old city and its union with the newer or extra-mural city, on the line of the old ramparts, known as Calle de la Ciudadada. The streets are well paved and have sufficient slope at all points to give easy surface drainage; Montevideo has the reputation of being one of the cleanest cities of the world. The rainfall is ample (about 44 in. a year), and the prevailing winds help to clean the streets. The westerly winds, however, sometimes bring across the bay the offensive smells of the great abattoirs and meat-curing establishments (*saladeros*) at the foot of the Cerro. The mean annual temperature is about 62° F. An abundant water supply is brought from the Santa Lucia River, 32 m. distant, with a receiving reservoir at Piedras, 100 ft. above the level of the Plaza de la Independencia. The ciudad vieja is largely devoted to commercial, shipping and financial interests. The government edifices, large retail shops and most of the fine urban residences are in the ciudad nueva, while most of the urban industries, the railway stations and the dwellings of the poorer classes are in the ciudad novísima. Beyond these is a fringe of suburbs (La Union and Paso Molino), and on the western side of the bay is the straggling suburb of Cerro, largely industrial in character. In 1908 eight tramway lines (all electric but one) extended out to these suburbs, some of the lines extending to the bathing resorts of Ramirez and Pocitos and the Buco cemeteries on the eastern coast.

The principal street, which is considered one of the finest boulevards in South America, is the Calle 18 de Julio, extending eastward from the Plaza de la Independencia to the suburb of Cordón; one of its features is its Sunday morning market, occupying the whole street from the Plaza de la Independencia to the Plaza Libertad, a distance of half a mile—a survival of the old market that existed here at the fortified entrance to the walled town in the earlier years of its history. There are seven plazas, or squares, within the urban limits: Zabala or Rincon, Constitución or Matriz, Independencia, Libertad or Cagancha, Treinte y Tres, Flores and Frutos; and two suburban parks or public gardens: the Pasco del Prado and Parque

Urbano. The Plaza de la Independencia stands at the junction of the old and new towns and is the centre of the city's political and social life. This square is distinguished for a uniform and nearly completed line of colonnades in front of the buildings surrounding it. The Paseo del Prado, which ranks high among the public gardens of South America, is beautifully situated beyond the suburb of Paso Molino, 3 m. from the city. The Paseo was originally the *quinta* of a German of cultivated tastes named Joseph Buschenthal, who spent a fortune in its adornment. The Parque Urbano, at the Playa Ramirez bathing resort, is a modern creation. The buildings of Montevideo are chiefly of brick and broken stone, covered outside with plaster and stucco, of one to three storeys, with flat roofs, usually surmounted by a square tower, or *mirador*. The roofs, or *azoteas*, are largely used for domestic purposes, or roof gardens. The city contains a large number of handsome edifices, both public and private, among which are the Bolsa, Government House, municipal hall, cathedral, Cabildo, Hospital de Caridad, insane asylum, Italian hospital, Teatro Solís, Athenaeum, and the Club Uruguayo. The Bolsa (exchange), custom-house, cathedral, and Cabildo are in the old town; the Bolsa is a copy of the Bordeaux exchange. The cathedral faces on the Plaza de la Constitución. Its two square towers rise 133 ft. above the pavement, and these, with the large dome behind, rise far above the surrounding buildings and make a very conspicuous landmark. The church was consecrated in 1804, and in 1860 was raised to the dignity of a cathedral. Montevideo is now the seat of a small archiepiscopal see with only two suffragan dioceses. Directly across the plaza is the old Cabildo, a plain, heavy-looking two-storeyed edifice of the colonial period, the seat of municipal administration during Spanish rule, but now occupied by the two chambers of the Uruguayan Congress and by the higher police authorities of the city.

The people of Montevideo maintain more than forty charitable associations, including the Caridad (charity) hospital on Calle 25 de Mayo, and the insane asylum in the suburb of La Unión, both built and largely supported from the proceeds of frequent lottery drawings. They also maintain a beggars' asylum and a foundlings' asylum. The national museum (founded in 1830) and public library (founded 1833) are in one wing of the Solís theatre. There are a British hospital (founded 1857, the present edifice dating from 1867) chiefly for the use of sailors, an Anglican church in Calle Santa Teresa dating from 1847, and a handsome Italian hospital of modern construction. The university, in Calle Uruguay, has faculties of law, medicine, letters, mathematics, engineering, and some minor groups of studies, including agriculture and veterinary science. The government maintains two normal schools, a school of arts and trades (*artes y oficios*), and a military school.

The harbour of Montevideo consists of a shallow bay, circular in shape and about 2½ m. from shore to shore, and an outer roadstead exposed to the violent winds of this latitude, where the larger ocean-going steamers were compelled to anchor before the construction of the new port works. In 1899 the Uruguayan government entered into a contract for the dredging of the bay, the construction of two long breakwaters, the dredging of a channel to deep water, and the construction of a great basin and docks in front of the city. Surtaxes were imposed on imports and exports to meet the expenditure, and work was begun in 1901. In 1908 the breakwaters and the greater part of the dredging had been completed, and the entrance channel, with a minimum depth of 24½ ft., permitted the admission of large steamers. Another important improvement, for which a concession was given to an English syndicate and work was begun in 1909, is the construction of an embankment and new shore line on the south side of the city, to be finished in five years at a cost of \$7,211,126. There are three large dry docks connected with the port, known as the Mauá (275 ft. long, inside) and the Gounouilhou (300 ft.) on the east side of the bay, and Jackson & Cibils (450 ft.) on the west side at the foot of the Cerro. Four railways terminate at Montevideo, one of them (the Central Uruguay) extending to the Brazilian

frontier. In 1908 20 lines of ocean-going steamers made regular calls at the port and several lines of river steamers ran to Buenos Aires and the ports of the Paraná, Paraguay and Uruguay rivers. The exports consist chiefly of livestock, jerked beef, hides, wool, and other animal products, wheat, flour, corn, linseed, barley, hay, tobacco, sealskins, fruit, vegetables, and some minor products. Manufactures exist only to a limited extent and chiefly for domestic consumption.

The suburbs of Montevideo include the fashionable bathing resorts of Playa Ramirez and Pocitos on the coast east of the city, the inland suburbs of Paso Molino and La Unión, and the industrial town of Cerro, across the bay. The Flores Island quarantine station is 12 m. east of the city. The station was formerly on Rat Island (within the bay), which is now used as a public deposit for inflammables. The chief point of interest in this suburb is the conical hill known as the Cerro, or "mount," from which the city takes its name, on which stands an old Spanish fort, sometimes garrisoned and sometimes used for the incarceration of political prisoners. Its elevation is 486 ft. (Reclus), and a lighthouse rises from within the fort carrying a revolving light that can be seen 25 m. at sea.

Montevideo was founded in 1726 through the efforts of Don Mauricio Zabala, governor of Buenos Aires, who wished to check the advance of the Portuguese on this side of the La Plata. A small military post had existed there since 1717, but efforts to create a town had been fruitless until Zabala offered to make *hidalgos* of the first settlers and to give them cattle and sheep. The first families to accept this offer came from the Canary Islands in 1726 under the direction of Don Francisco Alzeibar; they were followed by others from Andalusia and some of the Spanish-American settlements. Its growth at first was slow, but on the abolition of the Cadiz monopoly in 1778 it became a free port and its trade increased so rapidly that it soon became one of the chief commercial centres of South America. The city was captured in 1807 by a British expedition under Sir Samuel Auchmuty, but was abandoned when the expedition against Buenos Aires under General Whitelocke was defeated. In 1808 the governor of Montevideo established an independent junta, but after the Buenos Aires declaration of independence in 1810 the Spanish forces were concentrated in Montevideo and held it until expelled in 1814 by the Argentine land and sea forces under General Alvear and Admiral Brown. The dissensions following the expulsion of the Spanish and the rivalries of Argentina and Brazil over the possession of Uruguay, then commonly termed the "Banda Oriental," greatly reduced the population of the city and partially destroyed its trade. It was made the capital of the republic in 1828 and had partially recovered its population and trade when the disastrous struggle with Rosas, dictator of Buenos Aires, broke out and the city was subjected to a nine years' siege (1843-52), the investment being conducted by General Oribe, and the defence by General Paz. In 1864-1865 Brazil intervened in the affairs of the republic, blockaded the port, and reinstated ex-president Flores. The war with Paraguay that followed, which lasted until 1870, made Montevideo the base of supplies for the Brazilian army and navy and added largely to its trade and wealth. The valuation of the city and suburbs, which was \$14,156,000 in 1860, was \$74,000,000 in 1872. In addition to the reckless speculation of this period, there were continued political dissensions, repeated dictatorships and financial mismanagement on the part of the government. Not the least of these burdens were the personal and irregular drafts of some of the executives upon the treasury and revenue officers, particularly the custom-house of this port, upon which the republic depended for the major part of its revenue. The commercial and financial collapse that followed lasted through the greater part of the last three decades of the century; but settled government and improved finances subsequently contributed to a slow but steady recovery in the trade and industrial activities of the city.

MONTE VULTURE (anc. *Vultur*), a mountain of Basilicata, Italy, in the province of Potenza, the summit of which is about

5 m. S. of Melfi. It is an extinct volcano rising to 4365 ft. above sea-level, belonging in Roman times to Apulia, and lying on the boundary between it and Lucania. The crater is densely overgrown with oaks and beeches which harbour wild boars and wolves. There are two small lakes. On the banks of the upper lake stand the Capuchin monastery of San Michele and the picturesque ruined church of Sant' Ippolito. The city of Rionero in Vulture is pleasantly situated 27 m. by rail N. of Potenza, at the foot of Monte Vulture. Pop. (1901), 11,834. It does not seem to be older than the first half of the 17th century. In 1851 it suffered severely from an earthquake.

See G. de Lorenzo, *Venosa e la regione del Vulture* (Bergamo, 1906).

MONTFAUCON, BERNARD DE (1655-1741), French scholar and critic, was born at the château of Soulagé (now Soulatgé, in the department of Aube, France), on the 13th of January 1655. Belonging to a noble and ancient line, and destined for the army, he passed most of his time in the library of the family castle of Roquetaillade, devouring books in different languages and on almost every variety of subject. In 1672 he entered the army, and in the two following years served in Germany under Turenne. But ill-health and the death of his parents brought him back to his studious life, and in 1675 he entered the cloister of the Congregation of St Maur at La Daurade, Toulouse, taking the vows there on the 13th of May 1676. He lived successively at various abbeys—at Sorèze, where he specially studied Greek and examined the numerous MSS. of the convent library, at La Grasse, and at Bordeaux; and in 1687 he was called to Paris, to collaborate in an edition of Athanasius and Chrysostom, contemplated by the Congregation. From 1698 to 1701 he lived in Italy, chiefly in Rome in order to consult certain manuscripts, those available in Paris being insufficient for the edition of Chrysostom. After a stay of three years he returned to Paris, and retired to the abbey of St-Germain-des-Prés, devoting himself to the study of Greek and Latin MSS. and to the great works by which he established his reputation. He died suddenly on the 21st of December 1741. His first publication, in which he was assisted by Jacques Loppin and Antoine Pouget, was the first volume of a never-completed series of previously unpublished *Analecta graeca* (1688). In 1690 appeared *La Vérité de l'histoire de Judith. Athanasii opera omnia*, still the best edition of that Father, was issued with a biography and critical notes in 1698. In connexion with this may be mentioned *Collectio nova patrum et scriptorum graecorum* (1706), containing some newly discovered works of Athanasius, Eusebius of Caesarea, and the *Topographia christiana* of Cosmas Indicopleustes. His copious *Diarium italicum* (1702) gives an account of the principal libraries of Italy and their contents; this work has been translated into English by J. Henley (1725). The *Palaeographia graeca* (1708), illustrating the whole history of Greek writing and the variations of the characters, has not yet been superseded; in its own field it is as original as the *De re diplomatica* of Mabillon. In 1713 Montfaucou edited *Hexaplorum originis quae subsunt*, not superseded till the work of Field (1875); and between 1718 and 1738 he completed his edition of *Joannis Chrysostomi opera omnia*. His *L'Antiquité expliquée et représentée en figures* (1719) laid the foundation of archaeological knowledge. It was continued by him in *Les Monumens de la monarchie française, 1720-1733*. Both these works have been translated into English. Montfaucou's *Bibliotheca bibliothecarum manuscriptorum* (1739) is a list of the works in MS. in the libraries with which he was acquainted.

A list of his works will be found in *Bibliothèque des écrivains de la congrégation de Saint-Maur*, by C. de Lame (1882), and in the article in the *Nouvelle biographie générale*, which gives an account of their scope and character; see also Emmanuel de Broglie, *La Société de l'abbaye de St-Germain-des-Prés au 18^e siècle: Bernard de Montfaucou et les bernardins* (2 vols., Paris, 1891).

MONTFERRAT, COUNT OF, a title derived from a territory south of the Po and east of Turin, and held by a family who were in the 12th century one of the most considerable in Lombardy.

In 1147 a count of Montferrat took part in the Second Crusade; but the connexion with the Holy Land begins to be intimate in 1176. In that year William Longsword, eldest of the five sons of Count William III., came to the kingdom of Jerusalem, on the invitation of Baldwin IV. and the baronage, and married the heiress of the kingdom, Sibylla. He died within a few months; but his wife bore a posthumous son, who became Baldwin V. Count William III. himself (uncle to Philip of France and brother-in-law to Conrad III.) afterwards came to the Holy Land to watch over the interests of his grandson; and he was among the prisoners taken by Saladin at Hittin in 1187. Shortly after the battle of Hittin there appeared in Palestine the ablest and most famous of the family, Count William's second son, Conrad. Conrad, following the family tradition, and invited by the emperor Isaac Angelus, had gone to serve at the court of Constantinople. He soon became a considerable person; married Isaac's sister, and defeated and killed a usurper; but he was repaid by ingratitude and suspicion, and fled from Constantinople to Palestine in 1187. Putting into Tyre he was able to save the city from the deluge of Mahomedan conquest which followed Saladin's victory at Hittin. He established himself firmly in Tyre (refusing admission to Guy, the king of Jerusalem); and from it he both sent appeals for aid to Europe—which largely contributed to cause the Third Crusade—and despatched reinforcements to the crusaders, who, from 1188 onwards, were engaged in the siege of Acre. His elder brother had been the husband of the heiress Sibylla; and on the death of Sibylla, who had carried the crown to Guy de Lusignan by her second marriage, Conrad married her younger sister, Isabella, now the heiress of the kingdom, and claimed the crown (1190). The struggle between Conrad and Guy paralysed the energies of the Christians in 1191. While Richard I. of England espoused the cause of Guy, who came from his own county of Poitou, Philip Augustus espoused that of Conrad. After the departure of Philip, Conrad fomented the opposition of the French to Richard, and even intrigued with Saladin against him. But he was the one man of ability who could hope to rule the débris of the kingdom of Jerusalem with success; he was the master of an Italian statecraft which gave him the advantage over his ingenuous rival; and Richard was finally forced to recognize him as king (April 1192). In the very hour of success, however, Conrad was struck down by the emissaries of the Old Man of the Mountain (the chief of the Assassins).

Still another son of Count William III. achieved distinction. This was Boniface of Montferrat, the younger brother of Conrad, who was chosen leader of the Fourth Crusade in 1201, on the death of Theobald of Champagne. In the winter of 1201-1202 he went to Germany to visit Philip of Swabia; and there it has been suggested, he arranged the diversion of the Fourth Crusade to Constantinople (see CRUSADES). Yet in the course of the crusade he showed himself not unsubmitive to Innocent III., who was entirely opposed to such a diversion. After the capture of Zara, however, he joined the crusaders, and played a great part in all the events which followed till the capture of Constantinople by the Latins in 1204. But Baldwin of Flanders was elected emperor over his head; and his irritation was not wholly allayed by the grant of Macedonia, the north of Thessaly, and Crete (which he afterwards sold to Venice). In 1207 he died, killed in battle with the Bulgarians. He left a son Demetrius, who assumed the title of king of Thessalonica, which the father had never borne (cf. Luichaire, *Innocent III.: La question d'Orient*, p. 190). In 1222 Demetrius lost his kingdom to Theodore Angelus, and the house of Montferrat its connexion with the East.

See Savio, *Studi storici sul marchese Guglielmo III. di Montferrat* (Turin, 1885); Ilgen, *Markgraf Konrad von Montferrat* (1880); and also the works of Cerrato (Turin, 1884) and Desimoni (Genoa, 1886).

MONTFLEURY (d. 1667), French actor, whose real name was Zacharie Jacob, was born in Anjou during the last years of the 16th century. He was enrolled as one of the pages to the duc de Guise, but he ran away to join some strolling players,

assuming the name of Montfleury. About 1635 he was a valued member of the company at the Hôtel de Bourgogne, and he was in the original cast of the *Cid* (1636) and of *Horace* (1640). Richelieu thought highly of him, and when in 1638 Montfleury married the actress Jeanne de la Chalpe (d. 1683), the cardinal desired the ceremony to take place at his own country house at Rueil. Montfleury died in Paris from the rupture of a blood-vessel, while playing the part of Orestes in *Andromaque*, in December 1667. He was the author of a tragedy, *La Mort d'Androbal*, performed in 1647.

MONTFORT, the name of a famous French family long seated at Montfort l'Amauri, near Paris, descended from a certain William, a descendant of the counts of Flanders, who flourished during the latter part of the 10th century, and who built a castle at Montfort l'Amauri. Until 1209, when Simon IV. took the title of count, William and his successors were known as barons de Montfort. This Simon IV. de Montfort (c. 1160-1218), a son of Simon III. (d. 1181), is chiefly known for the very active part which he took in the crusade against the Albigenses. Twice he went to Palestine as a crusader, and in 1209, answering the call of Pope Innocent III., he joined the host which marched against the enemies of the Church in Languedoc. He became vicomte of Beziers and of Carcassonne, and was soon the leader of the crusaders. He took place after place, defeated Raymond VI., count of Toulouse, at Castelnaudary, and about a year later (September 1213) gained a victory over Raymond's ally, Peter II., king of Aragon, under the walls of Muret. Simon then turned his attention to administering and organizing Languedoc. After a lively discussion in the Lateran Council of 1215, the pope, somewhat reluctantly, confirmed him in the possession of the greater part of the lands of the count of Toulouse, and after two more years of warfare he was killed whilst besieging the city of Toulouse on the 25th of June 1218. The count's eldest son, Amauri de Montfort (1192-1241), was unable to hold his own, although Philip Augustus sent some troops to his assistance in 1222. He abandoned his interests in the south of France in favour of the new king Louis VIII., and in 1230 he went on crusade to the Holy Land, dying soon afterwards at Otranto. In 1230 Amauri was made constable of France. Simon IV. had a brother, Guy de Montfort (d. 1228), who shared his military exploits both in Asia and in Europe, and who was afterwards employed by Louis VIII. to negotiate with the pope at Rome. He was killed before Vareilles on the 31st of January 1228. In 1294 Yolande (d. 1322), the heiress of the Montforts, married Arthur II., duke of Brittany, and the county of Montfort became part of this duchy. Their son, John, count of Montfort, claimed Brittany in opposition to Charles, count of Blois, and at length secured the duchy. Except for one interval his descendants held it until it was united with the French crown at the end of the 15th century.

See A. Molinier, *Catalogue des actes de Simon et d'Amauri de Montfort* (1873); and C. Douais, *La Soumission de la vicomté de Carcassonne par Simon de Montfort et la croisade contre Raimond VI.* (1884).

MONTFORT, SIMON DE, EARL OF LEICESTER (d. 1265), English statesman and soldier, was born in France about the year 1200. He was the fourth and youngest son of Simon IV. de Montfort (see above), the leader of the Albigensian crusade, by Alicia de Montmorenci. Simon IV., whose mother was an heiress of the Beaumont family, claimed in her right, and received from King John, the earldom of Leicester (1207), only to lose it again through espousing the French side in the wars between that sovereign and Philip Augustus. The young Simon, of whose youth and education nothing is recorded, came to England in 1230 and attached himself to Henry III., obtaining with the consent of his sole surviving brother Amauri a re-grant of the family earldom. Simon was for a time unpopular with the English and closely attached to the royal party. He gave, however, an early proof of religious fervour, and of an unbending harshness, by the expulsion of all the Jews who had settled in his borough of Leicester to practise usury. In 1238 he obtained the hand of the king's sister Eleanor, the widow

of the younger William Marshal. The king approved of the match, but it was resented by his brother Richard of Cornwall and the baronage, and objections were raised on the ground that Eleanor had previously taken vows of chastity. With some difficulty Earl Richard was pacified; and Montfort obtained the pope's confirmation of the marriage by a personal visit to Rome. In 1239, however, the influence of detractors and a quarrel over some obscure financial transactions in which he appears to have used Henry's name without a formal warrant led to a breach between himself and the king. The earl and his wife went for a time to France; and, though a nominal reconciliation with the king was soon effected, both departed on crusade with Richard of Cornwall in 1240. Eleanor was left behind in Apulia while her husband proceeded to the Holy Land. He acquitted himself with distinction, and there was some thought among the Frankish barons of appointing him to act as regent of the Latin kingdom of Jerusalem. But he returned in 1241, took part in Henry's disastrous French expedition of 1242, and was readmitted to full favour. Between 1243 and 1248 he received many gifts from the king; he stood forward in parliament as a mediator between the court party and the opposition; it is only from the correspondence of his friends Grosseteste and Adam de Marsh that we learn of his dissatisfaction with the condition of church and state. He was keenly interested in Grosseteste's proposals for ecclesiastical reformation, and was considered the mainstay of the reforming party. In 1248 he again took the cross, with the idea of following Louis IX. to Egypt. But, at the repeated requests of the king and council, he gave up this project in order to act as governor in the unsettled and disaffected duchy of Gascony. Bitter complaints were excited by the rigour with which the earl suppressed the excesses of the seigneurs and of contending factions in the great communes. Henry yielded to the outcry and instituted a formal inquiry into the earl's administration. Montfort was formally acquitted on the charges of oppression, but his accounts were disputed by the king, and he retired in disgust to France (1252). The nobles of France offered him the regency of the kingdom, vacant by the death of the Queen-mother Blanche of Castile, but he preferred to make his peace with Henry (1253), in obedience to the exhortations of the dying Grosseteste. He helped the king in dealing with the disaffection of Gascony; but their reconciliation was a hollow one, and in the parliament of 1254 the earl led the opposition in resisting a demand for a subsidy. In 1256 and 1257, when the discontent of all classes was coming to a head, Montfort nominally adhered to the royal cause. He undertook, with Peter of Savoy, the queen's uncle, the difficult task of extricating the king from the pledges which he had given to the pope with reference to the crown of Sicily; and Henry's writs of this date mention the earl in friendly terms. But at the "Mad Parliament" of Oxford (1258) Montfort appeared side by side with the earl of Gloucester at the head of the opposition. It is said that Montfort was reluctant to approve the oligarchical constitution created by the Provisions of Oxford, but his name appears in the list of the Fifteen who were to constitute the supreme board of control over the administration. There is better ground for believing that he disliked the narrow class-spirit in which the victorious barons used their victory; and that he would gladly have made a compromise with the moderate royalists whose policy was guided by the Lord Edward, Henry's eldest son. But the king's success in dividing the barons and in fostering a reaction rendered such projects hopeless. In 1261 Henry revoked his assent to the Provisions, and Montfort left the country in despair.

He returned in 1263, at the invitation of the barons, who were now convinced of the king's hostility to all reform; and raised a rebellion with the avowed object of restoring the form of government which the Provisions had ordained. For a few weeks it seemed as though the royalists were at his mercy; but he made the mistake of accepting Henry's offer to abide by the arbitration of Louis IX. of France. At Amiens, in January 1264, the French king decided that the Provisions were unlawful and

invalid. Montfort, who had remained in England to prepare for the worst, at once resumed the war, and thus exposed himself to accusations of perfidy, from which he can only be defended on the hypothesis that he had been led to hope for a genuine compromise. Though merely supported by the towns and a few of the younger barons, he triumphed by superior generalship at Lewes (May 14, 1264), where the king, the Lord Edward, and Richard of Cornwall fell into his hands. Montfort used his victory to set up the government by which his reputation as a statesman stands or falls. The weak point in his scheme was the establishment of a triumvirate (consisting of himself, the young earl of Gloucester, and the bishop of Chichester) in which his colleagues were obviously figureheads. This flaw, however, is mitigated by a scheme, which he simultaneously promulgated, for establishing a thorough parliamentary control over the executive, not excepting the triumvirs. The parliament which he summoned in 1265 was, it is true, a packed assembly; but it can hardly be supposed that the representation which he granted to the towns (see **PARLIAMENT AND REPRESENTATION**) was intended to be a temporary expedient. The reaction against his government was baronial rather than popular; and the Welsh Marchers particularly resented Montfort's alliance with Llewellyn of North Wales. Little consideration for English interests is shown in the treaty of Pippen which sealed that alliance (June 22, 1265). It was by the forces of the Marchers and the strategy of Edward that Montfort was defeated at Evesham (Aug. 4). Divided from the main body of his supporters, whose strength lay in the east and south, the earl was outnumbered and surrounded before reinforcements could reach him. For years after his death he was revered by the commons as a martyr, and the government had no little difficulty in reducing the remnants of his baronial supporters. His character has suffered in the past from indiscriminate eulogy as much as from detractors. He was undoubtedly harsh, masterful, impatient and ambitious. But no mere adventurer could have won the friendship of such men as Marsh and Grosseteste; their verdict of approval may be the more unhesitatingly admitted since it is not untempered with criticism.

The original authorities are those for the reign of Henry III. The best biographies are those by R. Pauli (trans. C. M. Goodwin, London, 1876); G. W. Prothero (London, 1877); C. Bémont (Paris, 1884). See also the letters of Adam de Marsh in J. S. Brewer's *Monumenta Francicana*, vol. 1 (Rolls series, 1858); H. R. Luard, *Epistolae Roberti Grosseteste* (Rolls series, 1861); F. S. Stevenson, *Robert Grosseteste* (London, 1899); W. H. Blaauw, *The Barons' War* (Cambridge, 1871). (H. W. C. D.)

MONTGAILLARD, JEAN GABRIEL MAURICE ROQUES, COMTE DE (1761-1841), French political agent, was born at Montgailard, near Villefranche (Haute Garonne), on the 16th of November 1761. His parents belonged to the minor nobility, and he was educated at the military school of Sorèze, where he attracted the notice of the comte de Provence (afterwards Louis XVIII.). After serving for some years in the West Indies Maurice de Roques returned to France. In 1789 he was established in Paris as a secret diplomatic agent, and though he emigrated to England after the 10th of August 1792, he returned six weeks later to Paris, where his security was most probably purchased by services to the revolutionary government. He was again serving the Bourbon princes when he met Francis II. of Austria at Ypres in 1794 and saw Pitt in London, where he published his *État de la France au mois de mai 1794*, predicting the fall of Robespierre. He was employed by Louis XVIII. to secure Austrian intervention on behalf of Mme Royale (afterwards duchess of Angoulême), still a prisoner in the Temple, and he drew up the proposition made by the prince to Charles Pichegru, the details of which appear in his "Mémoire sur la trahison de Pichegru" (*Moniteur*, April 18, 1804). In June 1796 he made a journey to Italy in the hope of opening direct relations with Bonaparte. On his return to the princes at Blankenburg he was regarded with suspicion, and he departed for Paris to await events. He is thought to have indicated the possession by the comte d'Antraigues, agent of the princes, of documents compromising Pichegru. In April 1798 he

surrendered to Claude Roberjot, the Hamburg minister of the Directory, further papers relating to the matter. He followed Roberjot to Holland, and there wrote a memorandum to prove that the only hope for France lay in the immediate return of Bonaparte from Egypt, followed by assumption of the supreme power. This note reached Alexandria by way of Berlin and Constantinople. When he ventured to return to Paris in the hope of recognition from the First Consul he was imprisoned, and on his release he was kept under police supervision. Napoleon, who appreciated his real insight into European politics and his extraordinary knowledge of European courts, attached him to his secret cabinet in spite of his intriguing and mendacious character. He received a salary of 14,000 francs, reduced later to 6000, for reports on political questions for Napoleon's use, and for pamphlets written to help the imperial policy. He tried to dissuade Napoleon from the Austrian marriage and the Russian campaign, and counselled the limitation of the empire within the Rhine, the Alps and the Pyrenees. The Bourbon restoration made no change in his position; he was maintained as confidential adviser on foreign and home politics, and gave shrewd advice to the new government. His career ended with the old monarchy, and he died in obscurity at Chaillot on the 8th of February 1841.

His *Souvenirs*, which must be read with the utmost caution, were edited by Clément de Lacroix (3rd ed., 1895); his *Mémoires diplomatiques* (1805-1819) were published by the same editor in 1896. His *État de la France* was translated into English by Edmund Burke. His other writings include *Ma conduite pendant le cours de la révolution française* (London, 1795); *Histoire secrète de Coblenz dans la révolution des français* (London, 1795); *De la France et de l'Europe sous le gouvernement de Bonaparte* (Lyons, 1904); *Situation de l'Angleterre en 1811* (Paris, 1811); *De la restauration de la monarchie des Bourbons et du retour à l'ordre* (Paris, 1814); and *Histoire de France depuis 1825 jusqu'à 1830* (Paris, 1839).

MONTGELAS, MAXIMILIAN JOSEF GARNERIN, COUNT VON (1759-1838), Bavarian statesman, came of a noble family in Savoy. His father John Sigmund Garnerin, Baron Montgelas, entered the military service of Maximilian Joseph III., elector of Bavaria, and married the countess Ursula von Trauer. Maximilian Josef, their eldest son, was born on the 10th of September 1759. He was educated successively at Nancy, Strassburg and Ingolstadt. Being a Savoyard on his father's side, he naturally felt the French influence, which was then strong in Germany, with peculiar force. To the end of his life he spoke and wrote French more correctly and with more ease than German. In 1779 he entered the public service in the department of the censorship of books. The elector Charles Theodore, who had at first favoured him, became offended on discovering that he was associated with the Illuminati, the supports of the anti-clerical movement called the *Aufklärung*. Montgelas therefore went to Zweibrücken, where he was helped by his brother Illuminati to find employment at the court of the duke, the head of a branch of the Wittelsbach family. From this refuge also he was driven by orthodox enemies of the Illuminati. The brother of the duke of Zweibrücken—Maximilian Joseph—took him into his service as private secretary. When his employer succeeded to the duchy Montgelas was named minister, and in that capacity he attended the conference of Rastadt in 1798, where the reconstruction of Germany, which was the consequence of the French Revolution, was in full swing. In 1799 the duke of Zweibrücken succeeded to the electorate of Bavaria, and he kept Montgelas as his most trusted adviser. Montgelas was the inspirer and director of the policy by which the electorate of Bavaria was turned into a kingdom, and was very much increased in size by the annexation of church lands, free towns and small lordships. As this end was achieved by undeviating servility to Napoleon, and the most cynical disregard of the rights of Bavaria's German neighbours, Montgelas became the type of an unpatriotic politician in the eyes of all Germans who revolted against the supremacy of France. From his own conduct and his written defence of his policy it is clear that such sentiments as theirs appeared to be merely childish to Montgelas. He was a thorough politician of the

18th-century type, who saw and attempted to see nothing except that Bavaria had always been threatened by the house of Habsburg, had been supported by Prussia for purely selfish reasons, and could look for useful support against these two only from France, who had selfish reasons of her own for wishing to counterbalance the power both of Austria and Prussia in Germany. As late as 1813, when Napoleon's power was visibly breaking down, and Montgelas knew the internal weakness of his empire well from visits to Paris, he still continued to maintain that France was necessary to Bavaria. The decision of the king to turn against Napoleon in 1814 was taken under the influence of his son and of Marshal Wrede rather than of Montgelas, though the minister would not have been influenced by any feeling of sentimentality to adhere to an ally who had ceased to be useful. In internal affairs Montgelas carried out a policy of secularization and of administrative centralization often by brutal means, which showed that he had never wholly renounced his opinions of the time of the Enlightenment movement. His enemies persuaded the king to dismiss him in 1817, and he spent the remainder of his life in retirement till his death in 1838. He had married the countess von Arco in 1803, and had eight children; in 1809 he was found to be sane.

See *Denkwürdigkeiten des bayr. Staatsministers Maximilian Graf von Montgelas*, a German version of the French original, ed. by Ludwig Graf v. Montgelas (Stuttgart, 1887); *Briefe des Staatsministers Grafen Montgelas*, ed. by Julie von Czernog (Regensburg, 1853); Dumoulin Eckart, *Bayern unter dem Ministerium Montgelas* (Münch., 1894).

MONT GENÈVE, a very easy and remarkable pass (6083 ft.) between France and Italy, which is now considered by high authorities to have been crossed by Hannibal, as it certainly was by Julius Caesar, Charles VIII., and in the war of 1859. An excellent carriage-road mounts in 7 m. from Briançon, at the very head of the Durance valley, to the pass. On the French side of the divide is the village of Bourg Mont Genève, and on the Italian side that of Clavières, both inhabited all the year round, as the pass runs east and west, and is thus sheltered from the north wind. A descent of 5 m. leads down to Césanne in the Doria Riparia valley, which is followed for 5 m. more to Oulx (17 m. from Briançon), on the Mont Cenis railway.

MONTGOMERIE, ALEXANDER (c. 1550-c. 1610), Scottish poet, was the second son of Hugh Montgomerie of Hesselhead, Ayrshire, and was born about the middle of the 16th century.¹ He spent some part of his youth in Argyleshire and afterwards lived for a time at Compton Castle, in Galloway. He was in the service of the regent Morton; thereafter, on the regent's demission of office in 1578, in that of the king, James VI. In 1583 the grant by the Crown of a pension of 500 marks was confirmed; and three years later he set out on a tour through France, Flanders and other countries. He appears to have got into trouble, to have been imprisoned abroad, and to have lost favour at the Scottish court, and (for a time) his pension. We have no record of his closing years.

Montgomerie's chief poem is the *Cherry and the Slae*, first printed in 1597 (two impressions). It was frequently reprinted in the 17th and 18th centuries, and appeared twice in Latin guise in 1631, in Dempster's *Cerasum et sylvestre prunum, opus poematium*. It is included in the collected edition of Montgomerie's Poems, by David Irving (1821), and by James Cranston, for the Scottish Text Society (1887). The text in the latter is a composite of 930 lines from the second impression of 1597 (u.s.) and 666 lines from the version in Allan Ramsay's (g.z.) *Euer Green* (1724); but a better text, from a MS. in the Laing collection in the university of Edinburgh, has been prepared (1907) for the Scottish Text Society by Mr George Stevenson. The poem, written in the complicated alliterative fourteen-lined stanza, is a confused allegory—the confusion

¹ Alexander's brother, Robert Montgomerie (d. 1609), was made bishop or archbishop, of Glasgow, in 1581, an appointment which was strongly objected to by the General Assembly. The long struggle which ensued was only terminated by Montgomerie's resignation of the see in 1587.

being due to the fact that sections of the poem were written at different times—on Youth's choice between a richly laden cherry-tree on a high crag and a sloe "bush" at his feet. His other poems are: *The Flying betwixt Montgomery and Polwart* (1629; 1st ed., 1621), which reproduces the literary habit of the *Flying of Dunbar and Kennedy*; a series of 70 sonnets; a large number of miscellaneous poems, amatory and devotional; and *The Mindes Melodie, Containing certayne Psalmes of the Kinglie Prophete David, applyed to a new pleasant tune* (Edinburgh, 1605). The formal value of Montgomerie's verse was fittingly acknowledged by James VI. in his early critical essay *An Schort Treatise containing some reulis and cautelis to be obseruit and eschewit in Scottis Poetrie*, where the author makes three quotations from Montgomerie's poems, then in circulation in manuscript. Montgomerie had written a sonnet to his majesty, which is prefixed to the *Essays of a Prentise*.

Montgomerie stands apart from the courtier-poets Ayton, Stirling, and others, who write in the literary English of the South. He carries on the Middle Scots tradition, and was not without influence in the vernacular revival, in Allan Ramsay and his successors. (G. G. S.)

MONTGOMERY, GABRIEL, SEIGNEUR DE LORGES, COMTE DE (c. 1530-1574), French soldier, became a lieutenant in the king of France's Scottish guards, of which his father was captain, and engaged in police operations against the Protestants. Having inadvertently caused the death of King Henry II. in a tournament (June 30, 1559) he was disgraced and retired to his estates in Normandy. He studied theological questions and espoused the cause of the Reformers. In 1562 he allied himself with the prince of Condé, took Bourges, and defended Rouen from September to October 1562 against the royal army. In the third War of Religion he occupied Béarn and Bigorre (1566). Escaping from the massacre of St Bartholomew, he went to England and returned with a fleet for the relief of La Rochelle (1573), but soon had to withdraw to Cornwall. Returning to Normandy in 1574, he defended Domfront, which was being besieged by Marshal de Matignon, and was forced to capitulate on the 25th of May. He was sentenced to death by the parlement, and beheaded in Paris on the 26th of June 1574.

See L. Marlet, *Le Comte de Montgomery* (Paris, 1890).

MONTGOMERY, JAMES (1771-1854), British poet and journalist, son of a Moravian minister, was born on the 4th of November 1771, at Irvine in Ayrshire, Scotland. Part of his boyhood was spent in Ireland, but he received his education in Yorkshire, at the Moravian school of Fulneck near Leeds. He edited the *Sheffield Iris* for more than thirty years. When he began his career the position of a journalist who held pronounced views on reform was a difficult one, and he twice suffered imprisonment (in 1795 and 1796). His *Wanderer of Switzerland* (1806), describing the French occupation, attracted considerable attention. The author was described by Lord Byron in a footnote to *English Bards and Scotch Reviewers*, as "a man of considerable genius," whose *Wanderer of Switzerland* was worth a thousand "Lyrical Ballads." The book had been mercilessly ridiculed by Jeffrey in the *Edinburgh Review* (1807), but in spite of this Montgomery achieved a wide popularity with his later volumes of verse: *The West Indies* (1810); *The World Before the Flood* (1812); *Greenland* (1819); *Songs of Zion* (1822); *The Pelican Island* (1826). On account of the religious character of his poetry, he is sometimes confounded with Robert Montgomery, very much to the injustice of his reputation. His verses were dictated by the inspiring force of humanitarian sentiment, and he was especially eloquent in his denunciation of the slave trade. The influence of Campbell is apparent in his earlier poems, but in the *Pelican Island*, his last and best work as a poet, he evidently took Shelley as his model. His reputation now rests chiefly on his lyrics, about a hundred of which are still in current use. His *Lectures on Poetry and General Literature* (1833) show considerable breadth of sympathy and power of expression. A pension of

£150 was bestowed on him by Sir Robert Peel in 1835. He died at Sheffield on the 30th of April 1854.

His poems were collected and edited by himself in 1841. The voluminous *Memoirs*, published in seven volumes (1856-1858) by John Holland and James Everett, contain valuable information on English provincial politics.

MONTGOMERY, RICHARD (1736-1775), American soldier, was born in Co. Dublin, Ireland, in 1736. Educated at St Andrew's and at Trinity College, Dublin, he entered the British army in 1756, becoming captain six years later. He saw service at Louisbourg in 1757 and in the Lake Champlain expedition of 1759, and as adjutant of his regiment (the 17th foot) he shared in the final threefold advance upon Montreal. Later he was present at Martinique and Havana. In 1772 he left the army, settled in New York, and married a daughter of Robert R. Livingston. Three years later he was a delegate to the first provincial congress of New York, and became brigadier-general in the Continental Army. He was sent with Schuyler on the Canadian expedition, and on Schuyler's falling ill, the command devolved upon him. Hampered by the inclemency of the season and the gross indiscipline of the troops, he went forward, gaining a few minor successes and capturing the colours of the 7th (Royal) Fusiliers, and met Benedict Arnold's contingent at Point aux Trembles. They pushed on to Quebec barely 800 strong, but an assault was made on the 31st of December 1775, and almost at the first discharge Montgomery was killed. The body of the American general was honourably interred by the Quebec garrison. Congress caused a memorial to be erected in St Paul's church, New York, and in 1818 his remains were conveyed thither from Quebec.

MONTGOMERY, ROBERT (1807-1855), English poet, natural son of Robert Gomersy, was born at Bath in 1807. He was educated at a private school in Bath, and founded an unsuccessful weekly paper in that city. In 1828 he published *The Omnipresence of the Deity*, which hit popular religious sentiment so exactly that it ran through eight editions in as many months. In 1830 followed *The Puffad* (a satire), and *Satan*. An exhaustive review in *Blackwood* by John Wilson, followed in the thirty-first number by a burlesque of *Satan*, and two articles in the first volume of *Fraser*, ridiculed Montgomery's pretensions and the excesses of his admirers. But his name was immortalized by Macaulay's famous onslaught in the *Edinburgh Review* for April 1830. As a poet, he deserved every word of Macaulay's severe censure, though the brutality of the attack cannot be defended. This exposure did not, however, diminish the sale of his poems; *The Omnipresence of the Deity* reached its 28th edition in 1858. In 1830 Montgomery entered Lincoln College, Oxford, graduating B.A. in 1833 and M.A. in 1838. Taking holy orders in 1835 he obtained a curacy at Whittington, Shropshire, which he exchanged in 1836 for the charge of the church of St Jude, Glasgow. In 1843 he removed to the parish of St Pancras, London, when he was minister of Percy Chapel. He died at Brighton in 1855. He also wrote *The Messiah* (1832), *Woman, the Angel of Life* (1833), *Oxford* (1831), and many devotional and theological works.

MONTGOMERY, a city of Alabama, U.S.A., the capital of the state and the county-seat of Montgomery county, situated (about 162 ft. above the sea) S.E. of the centre of the state, on the left bank of the Alabama river, which is here navigable. Pop. (1900), 30,346, of whom 17,229 were of negro descent and 666 were foreign-born; (1910, census), 38,136. Montgomery is served by the Louisville & Nashville, the Mobile & Ohio, the Atlantic Coast Line, the Seaboard Air Line, the Central of Georgia, and the Western of Alabama railways, and by freight steamers plying between Montgomery and Mobile. Among the principal buildings are the state capitol, near which is a Confederate soldiers' monument (erected by the women of Alabama), the county court-house, the Federal building, the Carnegie library, the masonic temple and the First National Bank and Bell buildings. The public institutions include the city infirmary and St Margaret's hospital, the latter under the direction of the Sisters of Charity. The city has about 100 acres

of parks, Oak Park being the most important. Situated in the "Cotton Belt" of Alabama, Montgomery handles 160,000-200,000 bales annually. Truck-gardening is an important industry. The Alabama state fair is held here annually. Among the manufactures are fertilizers, machine-shop products, cotton goods, lumber products, cigars, harness, beer, stone-ware, and bricks. The value of the factory products in 1905 was \$3,877,653 (an increase of 31·7% over that in 1900). The leading newspapers are the *Montgomery Advertiser* (morning) and the *Montgomery Journal* (evening).

The site of Montgomery was once occupied by an Indian village known as Ecunchatty. The first permanent white settlement was made in 1814 by Arthur Moore. In 1817 Samuel Dexter of Massachusetts laid out a town and named it New Philadelphia. In 1819 it was united with East Alabama Town, an adjoining settlement on the river, under the present name (in honour of General Richard Montgomery), and a third settlement, Alabama Town, later became a part of Montgomery. Montgomery was first incorporated in 1837. The place soon became the commercial emporium of the Alabama "Cotton Belt." In 1847 it became the capital of the state instead of Tuscaloosa. On the 7th of January 1861, the State Convention through which Alabama seceded from the Union met in the capitol; at the same place delegates from six states met, on the 4th of February, and organized the Confederate States of America. Montgomery was the capital of the new government (hence the popular name "Cradle of the Confederacy") until May 1861, when that honour was transferred to Richmond, Virginia. It was the seat of Confederate military factories, and on the 12th of April 1865 it was captured by Federal troops. Montgomery received a new city charter in 1905.

MONTGOMERY, a town and district of British India, in the Lahore division of the Punjab. The town has a station on the North-Western railway about half-way between Lahore and Multan. Pop. (1901), 6602. It was founded in 1864 on the opening of the railway, and called after Sir Robert Montgomery, then lieutenant-governor. It is situated in a desolate upland, and though not unhealthy is singularly uncomfortable.

The DISTRICT OF MONTGOMERY lies in the Bari Doab, or tract between the Sutlej and the Ravi, extending also across the latter river. Area, 4771 sq. m. In the former tract a fringe of cultivated lowland skirts the bank of either river, but the whole interior upland consists of a desert plateau partially overgrown with brushwood and coarse grass, and in places with impenetrable jungle. On the farther side of the Ravi, again, the country at once assumes the same desert aspect. The population in 1901 was 463,586, showing an apparent decrease of 0·4% in the decade due to emigration to the Chenab Colony. The principal crops are wheat, pulse, cotton and fodder. Camels are bred for export. The leading manufactures are of cotton and silk, and lacquered woodwork, and there are factories for ginning and pressing cotton. The district is traversed by the main line of the North-Western railway, from Lahore to Multan, and is irrigated by the Upper Sutlej inundation canal system, and also from the Ravi.

From time immemorial the Rechna Doab has formed the home of a wild race of pastoral Jāts, who have constantly maintained a sturdy independence against the successive rulers of northern India. The sites of Kot Kamalia and Harappa contain large mounds of antique bricks and other ruins, while many other remains of ancient cities or villages lie scattered along the river bank, or dot the now barren stretches of the central waste. The pastoral tribes of this barren expanse do not appear to have paid more than a nominal allegiance to the Moslem rulers, and even in later days, when Ranjit Singh extended the Sikh supremacy as far as Miltān, the population for the most part remained in a chronic state of rebellion. British influence was first exercised in the district in 1847, when an officer was deputed to effect a summary settlement of the land revenue. Direct British rule was effected on the annexation of the Punjab in 1849. There was a general rising of the wild clans during the Mutiny of 1857, several actions being fought before order was restored.

MONTGOMERY (*Tre' Faldwyn*), a municipal and parliamentary borough, market town, and the county town of Montgomeryshire, Wales, situated on a wooded hill near the east bank of the Severn, 7 m. S. of Welshpool (Cambrian railway). Pop. (1001), 1034. The principal feature of the town is the ruined castle. Not far off are the traces of an extensive British fort, and, about a mile east, the line of Offa's Dyke, forming the Shropshire boundary. The borough was incorporated by Henry III., when the castle was enlarged, and was the scene of frequent contests between that king and Llewelyn the Great. In the 14th century the castle was held by the Mortimers, from whom it passed to the Yorkists. The Crown gave it, in the 15th century, to the Herberts of Cherbury, one of whom, in 1644, surrendered it to the Parliamentarians, who dismantled it.

MONTGOMERYSHIRE (Welsh *Swydd Fyfe' Daldwyn*, Baldwin's town shire), a county of Wales, bounded N. by Denbigh, N.E. and E. by Shropshire, S. by Radnor and Cardigan, W. and N.W. by Merioneth. Its length from S.E. to N.W. is about 30 m.; N.E. to S.W. it measures about 35 m. The surface is broken, though the highest hills are only round the county borders—to the north Berwyn (stretching into Denbighshire); to the south-west Plinlimmon (*q.v.*); east, the Breidden hills; south, the Kerry hills. The principal rivers and streams are: the Severn, flowing east and north; the Wye, farther south; the Dyfi, Fyrnwy (Fyrnwy), Clywedog, Tanat and Rhw. Except the Wye and Dyfi, the principal streams are tributaries of the Severn. Lake Fyrnwy, formed in 1888, is the chief water-supply of Liverpool. The Montgomeryshire canal, some 24 m. long, is connected with the Shropshire Union and Ellesmere canals. The county was formerly a recognized source of oak timber for the navy.

Geologically, the county is occupied almost exclusively by Ordovician and Silurian rocks. The latter, mainly Wenlock beds bordered by a fringe of Llandovery rocks, lie in the form of a complex syncline down the centre of the county from a few miles north of Lake Fyrnwy through Llangadfan, Llanfyllin, Llanfair, Welshpool, Montgomery and Newtown. The boundary is very irregular. Between Newtown and Kerry hill Ludlow beds come in, and on the edge of the forest of Clun the Old Red Sandstone just crosses the boundary into this county. North and south of the Silurian tract the Ordovician rocks occupy the remaining area; they contain bands of andesite and felsite in the Berwyn hills, also east of Criggion and south-west of Corndon. In the last-named hill there is a large laccolitic mass of dolerite and similar rocks at Criggion. At Machynlleth slate is worked in the Ordovician, and numerous metalliferous mines exist in the neighbourhood of Newtown from which lead, silver and zinc are obtained. Glacial deposits are prevalent over much of the county.

The climate is mild, and the soil generally fertile, especially in the Severn valley, though towards Merionethshire there are heath and moss. Small holdings (under about 50 acres) tend to diminish. The hardy, small, mountain pony is still to be found here. Hunters and cart-horses are bred. Sheep-breeding is practised, and Shropshire downs are superseding the little *cluns*. Of the relatively few green crops potatoes are the most important; oats are the principal grain. Permanent pasture covers a large area. Hill pasture is also extensive. Woollen cloth and flannel manufacture have revived considerably.

The Cambrian railway, entering Montgomeryshire in the north-east, by Llanymynech, crosses it to the south-west with branches to Llanfyllin, Westbury and Van. There is also a branch from Caersws to Glandyfi (Glandovey) junction, with the coastwise branch of the same company.

The area of the ancient and administrative counties is 510,111 acres, or 797 sq. m., with a population of 54,901 in 1901. Many of the people know no English, and Welsh is everywhere the favourite speech. The county returns one member to parliament, and includes the Montgomeryshire district of parliamentary boroughs: Llanfyllin (pop. 1632), Llanidloes (2770), Montgomery (1034), Machynlleth, Newtown and Welshpool (6121). The first three and last of these are municipal boroughs. The urban districts are: Newtown and Llanllwchaearn (6500), and Machynlleth (2038). The county is in the North Wales and Chester circuit, assizes being held alternately at Newtown and Welshpool.

Welshpool borough has a separate commission of the peace, but no separate court of quarter sessions. The ancient county (in Bangor, Hereford, and St Asaph dioceses) has 59 ecclesiastical parishes or districts, with parts of 11 others.

History and Antiquities.—The Welsh name of Baldwin's town shire is taken from a Norman who did homage to William the Conqueror for this division of Wales. The English name is from Roger de Montgomery, earl of Shrewsbury (*temp.* William Rufus). At the coming of the Romans this county was part of the Ordovices' territory (*Britannia secunda*), and there are remains of Roman encampments and fortifications at Caersws, Mathrafal, and near Montgomery. The roads connecting these stations can often be traced. Vestiges of a Roman camp are visible near Welshpool. Machynlleth was perhaps the Roman *Maglona*. Remains of old British camps are to be seen at Dolarddny, on Breidden hill and at Caereinion. There are many cairns and barrows. Crossing the county was the *Via Devana*, joined by other roads. From the Roman evacuation under Flavius Honorius (d. A.D. 423) little is known of Montgomery until Wales was subdivided into three districts at the death of Rhodri Fawr, when Montgomery was included in Powys (*Powys Gwentwynnwy*, Upper Powys). Powys Castle was founded in 1108. About the end of the 11th century, probably, was built Baldwin's Castle, taken later by the Welsh and retaken by Roger de Montgomery. In 1345 Roger Mortimer held it. At Carno, 11 m. from Newtown and 17 from Machynlleth, a battle decisive of North Wales sovereignty was fought in 946, and in 1081 the rightful heir, Gruffydd ab Cynan, together with Rhys ab Tudur, prince of South Wales, here killed in battle Trahaearn ab Caradoc, the usurper, and most of his men. At Machynlleth is seen Owen Glendower's senate house (1402) where he was crowned prince of Wales.

MONTH (a common Teutonic word, cf. Ger. *Mond*, Du. *maand*, Dan. *maaned*, &c., and cognate with Lat. *mensis*, Gr. *μήν*, &c., in other branches of the Indo-Germanic family; all ultimately from the root seen in the word for the moon in nearly all those languages), originally the period between two returns of the new moon; generally called a *lunar* and sometimes a *synodic* or *illuminative month*. The *anomalistic month* is the mean time taken by the moon in passing from one perigee to the next; the *sidereal month* is the mean time in which the moon makes a circuit among the stars; the *tropical month* is the mean time in which the moon traverses 360° of longitude; the *nodical* or *draconic month* is the mean time taken by the moon in passing from one rising node to the next; the *solar month* is one-twelfth of a tropical year. The lengths of the various months are: synodic = 29.53059 days; anomalistic = 27.55460, sidereal = 27.32166, tropical = 27.32156, nodical = 27.21122, solar = 30.43685. (For the calendar months see CALENDAR.)

In law a month may mean either a lunar month, that is, a period of twenty-eight days, or a calendar month. At common law, "month" generally means a lunar month, although in mercantile matters it has been generally understood to mean a calendar month, but there is no general exception giving it that meaning in commercial documents. It can only have that meaning where according to the ordinary rules of construction a secondary meaning can be admitted (*Bruner v. Moore*, 1904, 1 Ch. 305). In bills of exchange or promissory notes month means a calendar month (Bills of Exchange Act, 1882, s. 14 [4]). Where a servant is engaged subject to a month's notice or payment of a month's wages month is interpreted as a calendar month (*Gordon v. Potter*, 1 F. & F. 644). In acts of parliament passed before the year 1850 month, unless otherwise specially interpreted, means lunar month, but in all acts passed since that date, month, unless words be added showing that lunar month was intended, means calendar month (Interpretation Act 1880, s. 3). In the rules of the supreme court and in the county court rules month means a calendar month. In mercantile contracts in computing the period of a month the day from which the time is to begin to run is excluded, but in sentences of imprisonment the day on which the sentence begins is included, so that the numerically corresponding

day in the month in which the sentence expires would be excluded.

MONTHOLON, CHARLES TRISTAN, MARQUIS DE (1782-1853), was born at Paris. He was trained for a military career, and in his tenth year shared in the expedition of Admiral Truguet to the coast of Sardinia. Entering the army in 1798, he rose with rapidity and avowed himself, when *chef d'escadron* in Paris at the time of the *coup d'état* of Brumaire (November 1799), entirely devoted to Bonaparte. He served with credit in the ensuing campaigns, and distinguished himself at the battle of Aspern-Essling (May 1806) where he was wounded. At the end of that campaign on the Danube he received the title of count and remained in close attendance on Napoleon, who confided to him several important duties, among others, a mission to the Archduke Ferdinand at Würzburg. At the time of the first abdication of Napoleon at Fontainebleau (April 11, 1814), Montholon was one of the few generals who advocated one more attempt to rally the French troops for the overthrow of the allies. After the second abdication (June 22, 1815) he with his wife accompanied the emperor to Rochefort, where Napoleon and his friends finally adopted the proposal, which emanated from Count Las Cases (*q.v.*), that he should throw himself on the generosity of the British nation and surrender to H.M.S. "Bellerophon." Montholon afterwards, at Plymouth, asserted that the conduct of Captain Maitland of the "Bellerophon" had been altogether honourable, and that the responsibility for the failure must rest largely with Las Cases. Montholon and his wife accompanied the ex-emperor to St Helena. To Montholon chiefly, Napoleon dictated the notes on his career which form so interesting, though far from trustworthy, a commentary on the events of the first part of his life. Montholon is known to have despised and flouted Las Cases, though in later writings he affected to laud his services to Napoleon. With Gourgaud, who was no less vain and sensitive than himself, there was a standing feud, which would have led to a duel but for the express prohibition of Napoleon. Las Cases left the island in November 1816, and Gourgaud in January 1818; but Montholon, despite the departure of his wife, stayed on at Longwood to the end of the emperor's life (May, 1821). In a letter written to his wife he admitted that Napoleon died of cancer, though he afterwards encouraged the belief that death was due to a liver complaint aggravated by the climate and by the restrictions to which Napoleon was subjected. After that event Montholon and Bertrand became reconciled to Sir Hudson Lowe (*q.v.*); but this did not prevent him, on his return to France, from vilifying that much abused man. Colonel Basil Jackson found him very frank as to the *politique* of Longwood which aimed at representing Napoleon as a martyr, and Sir Hudson Lowe as his persecutor. Montholon admitted that an "angel from heaven as governor would not have pleased them." Montholon had to spend many years in Belgium; and in 1840 acted as "chief of staff" in the absurd "expedition" conducted by Louis Napoleon from London to Boulogne. He was condemned to imprisonment at Ham, but was released in 1847; he then retired to England and published the *Récits de la captivité de Napoléon à Ste Hélène*. In 1849 he became one of the deputies for the Legislative Assembly under the Second French Republic. He died on the 21st of August 1853.

See *Recueil de pièces authentiques sur le captif de Ste Hélène: suite de lettres de MM. . . le Général Montholon, &c.* (Paris, 1821); *Mémoires pour servir à l'histoire de France sous Napoléon* (ed. Gourgaud and Montholon, Paris, 1823; Eng. ed., London, 1823; new ed., Paris, 1905); *Récits de la captivité de l'empereur Napoléon à Ste Hélène* (2 vols., Paris, 1847). Also the Marquise de Montholon's *Souvenirs de Ste Hélène, 1815-16* (Paris, 1901). Of Montholon's own writings the only one of note is *De l'Armée française* (1834). For the conversations of Montholon with Basil Jackson in 1828, see Lieut.-Colonel Basil Jackson, *Notes and Reminiscences of a Staff Officer* (London, 1903). (J. H. R.)

MONTH'S MIND, in medieval and later England a service and feast held one month after the death of anyone in his or her memory. Bede speaks of the day as *commemoracionis dies*. These "Minding days" were of great antiquity, and were survivals of the Norse *minne* or ceremonial drinking to the dead.

"Minnying Days," says Blount, "from the Saxon Lemynde, days which our ancestors called their Monthes mind, their Year's mind and the like, being the days whereon their souls (after their deaths) were had in special remembrance, and some office or obsequies said for them, as Orbits, Dirges." The phrase is still used in Lancashire. Elaborate instructions for the conduct of the commemorative service were often left in wills. Thus, one Thomas Windsor (who died in 1479) orders that "on my month's mind there be a hundred children within the age of sixteen years, to say for my soul," and candles were to be burned before the rood in the parish church and twenty priests were to be paid by his executors to sing *Placibo, Dirige, &c.* In the correspondence of Thomas, Lord Cromwell, one in 1536 is mentioned at which a hundred priests took part in the mass. Commemorative sermons were usually preached, the earliest printed example being one delivered by John Fisher, bishop of Rochester, on Margaret, countess of Richmond and Derby, in 1509.

MONTILLA, a town of southern Spain, in the province of Cordova, 32 m. S. of the city of Cordova, by the Cordova-Bobadilla railway. Pop. (1900), 13,603. The oil of the district is abundant and good; and it is the peculiar flavour of the pale dry light wine of Montilla that gives its name to the sherry known as *Montillado*. Montilla was the birthplace of "The Great Captain," Gonzalo or Gonsalvo of Cordova (1453-1515), and contains the ruined castle of his father, Pedro Fernandez de Cordova.

MONTLOSIER, FRANÇOIS DOMINIQUE DE REYNAUD, COMTE DE (1755-1838), French publicist, was born at Clermont-Ferrand (Puy-de-Dôme) on the 16th of April 1755, the youngest of a large family belonging to the poorer nobility. He was returned in 1791 to the Constituent Assembly, where he sat on the Royalist side, and he emigrated on its dissolution in September 1791. He was received into the emigrant army at Coblenz after some protest against the Liberal leanings he had shown in the Assembly. After the cannonade of Valmy, he withdrew to Hamburg, and thence to London, where he avoided English society, moving exclusively among the French exiles. In his *Courrier de Londres*, published in London, he advocated moderation and the abandonment by the exiles of any idea of revenge. He was recalled to Paris in 1801, with permission to publish his paper in London. The *Courrier* was soon suppressed, nevertheless, its editor being compensated by a comfortable sinecure in the ministry of foreign affairs. Next year he sold his pen to the government to edit the violent anti-English *Bulletin de Paris*. At Napoleon's request he undertook an account of the ancient monarchy of France, which should serve as a justification for the empire. After four years' labour Montlosier submitted his work to a specially appointed committee, by which it was rejected because of the stress laid on the feudal limitations of the royal authority. The work *De la monarchie française . . . ou recherches sur les anciennes institutions françaises . . . et sur les causes qui ont amené la révolution . . .* appeared in 1814 in three volumes, a fourth and supplementary volume in the next year containing a preface hostile to Napoleon. His views were no more acceptable to Louis XVIII. than they had been to the emperor, and he devoted himself to agriculture until he was roused by the clerical and reactionary policy of Charles X. His anti-clerical *Mémoire à consulter sur un système religieux, politique . . .* (1826) rapidly passed through eight editions. He had no part in the revolution of 1830, but supported Louis Philippe's government and entered the House of Peers in 1832. He died on the 9th of December 1838 at Blois. Ecclesiastical burial was denied him because he had refused to abjure his anti-clerical writings.

Among his works should be mentioned: *Mémoires sur la révolution française, le consulat, l'empire, la restauration, et les principaux événements qui l'ont suivie* (2 vols., 1829).

MONTLUC (or MONLUC), BLAISE DE LASSARAN-MASSEN-CÔME, SEIGNEUR DE (c. 1502-1577), marshal of France, was born about 1502, at the family seat near Condom in the modern department of Gers. He was the eldest son, and his family was a good one, but, like most gentlemen of Gascony, he had to

trust to his sword. He served first as a private archer and man-at-arms in Italy, with Bayard for his captain, fought all through the wars of Francis I., and was knighted on the field of Cériseles (1544), to which victory he had brilliantly contributed as adviser to the young duke of Enghien. Having apparently enjoyed no patronage, he was by this time a man of middle age. Thenceforward, however, his merits were recognized. His chief feat was the famous defence of Siena (1555), which he has told so admirably. When the religious wars broke out in France, Montluc, a staunch royalist, held Guyenne for the king. Henry III. made him in 1574 marshal of France, an honour which he had earned by nearly half a century of service and by numerous wounds. He died at Estillac near Agen in 1577. Montluc's eminence above other soldiers of his day is due to his *Commentaires de Messire Blaise de Montluc* (Bordeaux, 1592), in which he described his fifty years of service (1521-1574). This book, the "soldier's Bible" (or "breviary," according to others), as Henry IV. called it, is one of the most admirable of the many admirable books of memoirs produced by the unlearned gentry of France at that time. It is said to have been dictated, which may possibly account in some degree for the singular vivacity and picturesqueness of the style.

The *Commentaires* are to be found conveniently in the collection of Michaud and Poujoulat, but the standard edition is that of the *Société de l'histoire de France*, ed. by M. de Ruble (5 vols., 1865-1872). See Rüstow, *Militärische Biographien*, v. i. (Zürich, 1858).

MONTLUÇON, a town of central France, capital of an arrondissement, and the most important industrial centre in the department of Allier. Pop. (1906), 31,888. It is situated on the Cher, 50 m. S.W. of Moulins by the Orléans railway. The upper town, on an eminence on the right bank, consists of steep, narrow, winding streets, and preserves several buildings of the 15th and 16th centuries; the lower town, traversed by the Cher, is the seat of the industries, which embrace the manufacture of glass, chemicals, mirrors, sewing-machines, and iron and steel production. The Commentry coal-mines and Nérís, a town with thermal springs, are a few miles distant to the south-east. Of the churches, Notre-Dame is of the 15th century, St Pierre partly of the 12th and St Paul modern. The town-hall, with a library, occupies the site of an old Ursuline convent, and two other convents are used as college and hospital. Overlooking the town is the castle rebuilt by Louis II., duke of Bourbon, and taken by Henry IV. during the religious wars; it serves as a barracks. Montluçon is the seat of a sub-prefect and has tribunals of first instance and of commerce, a board of trade arbitration, a chamber of commerce and a lycée. The town, which formed part of the duchy of Bourbon, was taken by the English in 1271, and by Philip Augustus in 1181; the English were beaten under its walls in the 14th century.

MONTMORENCY, the name of one of the oldest and most distinguished families in France, derived from Montmorency, now in the department of Seine-et-Oise, in the immediate neighbourhood of Enghien and St Denis, and about 9 m. N.N.W. of Paris. The family, since its first appearance in history in the person of BOUCHARD I., sire de Montmorency in the 10th century, has furnished six constables and twelve marshals of France, several admirals and cardinals, numerous grand officers of the Crown and grand masters of various knightly orders, and was declared by Henry IV. to be, after that of the Bourbons, the first house in Europe. MATTHEU I., sire de Montmorency, received in 1138 the post of constable, and died in 1160. His first wife was Aline, the natural daughter of Henry I. of England; his second, Adelaide or Alice of Savoy, widow of Louis VI. and mother of Louis VII., and according to Duchesne, he shared the regency of France with Suger, during the absence of the latter king on the second crusade. MATTHEU II. had an important share in the victory of Bouvines (1214), and was made constable in 1218. During the reign of Louis VIII. he distinguished himself chiefly in the south of France (Niort, La Rochelle, Bordeaux). On the accession of Louis IX. he was one of the chief supports of the queen-regent Blanche of Castile, and was successful in reducing all the vassals to obedience. He died in

1230. His younger son, Guy, in right of his mother, became head of the house of Montmorency-Laval. ANNE de Montmorency (*q.v.*), so named, it is said, after his godmother Anne of Brittany, was the first to attain the ducal title (1551). His eldest son, FRANÇOIS de Montmorency (1530-1579), was married to Diana, natural daughter of Henry II.; another son, HENRI I. de Montmorency (1534-1614), who became duc de Montmorency on his brother's death in 1579, had been governor of Languedoc since 1563. As a leader of the party called the *Politiques* he took a prominent part in the French wars of religion. In 1593 he was made constable, but Henry IV. showed some anxiety to keep him away from Languedoc, which he ruled like a sovereign prince. HENRY II. (1595-1632), son of duke Henry I., succeeded to the title in 1614, having previously been made grand admiral. He also was governor of Languedoc. In 1625 he defeated the French Protestant fleet under Soubise, and seized the islands of Ré and Oléron, but the jealousy of Richelieu deprived him of the means of following up these advantages. In 1628-1629 he was allowed to command against the duke of Rohan in Languedoc; in 1630 he defeated the Piedmontese, and captured Prince Doria, at Avigliana, and took Saluzzo. In the same year he was created marshal. In 1632 he joined the party of Gaston, duke of Orleans, and placed himself at the head of the rebel army, which was defeated by Marshal Schomberg at Castelnaudary (Sept. 1, 1632); severely wounded, he fell into the enemy's hands, and, abandoned by Gaston, was executed as a traitor at Toulouse on the 30th of October. The title passed to his sister CHARLOTTE-MARGUERITE, princess of Condé.

From the barons of Fosseux, a branch of the Montmorency family established in Brabant in the 15th century, sprang the seigneurs de Boutteville, among whom was the duellist François de Montmorency-Boutteville, who was beheaded in 1627. His son, François Henri, marshal of France, became duke of Piney-Luxemburg by his marriage with Madeleine Charlotte Bonne Thérèse de Clermont, daughter of Marguerite Charlotte de Luxemburg, duchesse de Piney. Charles François Frédéric, the son of the marshal, was created duke of Beaufort in 1688 and duke of Montmorency in 1689. In 1767 the title of duke of Beaufort-Montmorency passed by marriage to another branch of the Montmorency-Fosseux. This branch becoming extinct in 1862, the title was taken by the duc de Valençay, who belonged to the Talleyrand-Périgord family and married one of the two heiresses of this branch (1864). There were many other branches of the Montmorency family, among others that of the seigneurs de Laval (*q.v.*), a cadet branch of which received the title of duke of Laval and settled on the estate of Magnac in 1758. It is to this branch that Mathieu, duc de Montmorency (1767-1826), diplomatist and writer, and tutor of Charles X.'s grandson, Henri, duke of Bordeaux, belonged.

MONTMORENCY, ANNE, DUC DE (1493-1567), constable of France, was born at Chantilly, and was brought up with the future King Francis I., whom he followed into Italy in 1515, distinguishing himself especially at Marignano. In 1516 he became governor of Novara; in 1520 he was present at the Field of Cloth of Gold, and afterwards had charge of important negotiations in England. Successful in the defence of Mézières (1521), and as commander of the Swiss troops in the Italian campaign of the same year, he was made marshal of France in 1522, accompanied Francis into Italy in 1524, and was taken prisoner at Pavia in 1525. Released soon afterwards, he was one of the negotiators of the treaty of Madrid, and in 1530 reconducted the king's sons into France. On the renewal of the war by Charles V.'s invasion of France in 1536, Montmorency compelled the emperor to raise the siege of Marseilles; he afterwards accompanied the king of France into Picardy, and on the termination of the Netherlands campaign marched to the relief of Turin. In 1538, on the ratification of the ten years' truce, he was rewarded with the office of constable, but in 1541 he fell into disgrace, and did not return to public life until the accession of Henry II. in 1547. In 1548 he repressed the insurrections in the south-west, particularly at Bordeaux, with great severity,

and in 1549-50 conducted the war in the Boulonnais, negotiating the treaty for the surrender of Boulogne on the 24th of March 1550. In 1551 his barony was erected into a duchy. Soon afterwards his armies found employment in the north-east in connexion with the seizure of Metz, Toul and Verdun by the French king. His attempt to relieve St Quentin resulted in his defeat and captivity (Aug. 10, 1557), and he did not regain his liberty until the peace of Cateau-Cambresis in 1559. Supplanted in the interval by the Guises, he was treated with coldness by the new king, Francis II., and compelled to give up his mastership of the royal household—his son, however, being appointed marshal by way of indemnity. On the accession of Charles IX. in 1560 he resumed his offices and dignities, and, uniting with his former enemies, the Guises, played an important part in the Huguenot war of 1562. Though the arms of his party were victorious at Dreux, he himself fell into the hands of the enemy, and was not liberated until the treaty of Amboise (March 19, 1563). In 1567 he again triumphed at St Denis, but received the death-blow of which he died at Paris, on the 15th of March, 1567.

See F. Decrue, *Anne de Montmorency* (Paris, 1885), and *Anne, duc de Montmorency* (Paris, 1889).

MONTMORENCY, MATHIEU JEAN FÉLICITÉ DE MONTMORENCY-LAVAL, Duc de (1766-1826), French politician, was born in Paris on the 10th of July 1766. He served with his father, the vicomte de Laval, in America, and returned to France imbued with democratic opinions. Mathieu de Montmorency was governor of Compiègne when he was returned as deputy to the states-general in 1789, where he joined the Third Estate and sat on the left of the Assembly. He moved the abolition of armorial bearings on the 19th of June 1790. The dissolution of the Constituent Assembly in September 1791 set him free to join Lütkner's army on the frontier early in the next year. After the revolution of the 10th of August he abandoned his revolutionary principles; and he took no part in politics under the empire. At the Restoration he was promoted *maréchal de camp*, and accompanied Louis XVIII. to Ghent during the Hundred Days. At the second restoration he was made a peer of France, and two years later received the title of viscount. He adopted strong reactionary and ultramontane views, and became minister of foreign affairs under Villèle in 1821. He recommended armed intervention in Spain at the Congress of Verona in October 1822, but he resigned in December, being compensated by the title of duke and the cross of the Legion of Honour in the next year. He was elected to the French Academy in 1825, though he appears to have had small qualifications for the honour, and in the next year became tutor to the six-year-old Henri, duke of Bordeaux (afterwards known as the comte de Chambord). He died two months after receiving this last appointment, on the 24th of March 1826.

See Vétillard, *Notice sur la vie de M. le duc Mathieu de Montmorency* (Le Mans, 1826), and, for his curious relations with Mme de Staël, P. Gautier, *Mathieu de Montmorency et Mme de Staël, d'après les lettres inédites de M. de Montmorency à Mme Necker de Saussure* (1908).

MONTMORENCY, a town of northern France in the department of Seine-et-Oise, 23 m. from the right bank of the Seine and 11 m. N. of Paris by rail. Pop. (1906), 5723. In the middle ages it was the seat of the family of Montmorency. There is a church built for the most part in the 16th century by Anne de Montmorency. The town is a well-known resort of Parisians. To the north-east lies the fine forest of Montmorency. Bleaching and dyeing and the manufacture of lime plaster, bricks and tiles are carried on. About a mile south-west lies Engchien-les-Bains (pop. 4925), the waters of which are used in cases of catarrh and skin disease.

MONTMORILLON, a town of western France, capital of an arrondissement in the department of Vienne, on the Gartempe, 34 m. E.S.E. of Poitiers by rail. Pop. (1906), 3924. The ecclesiastical seminary occupies a building of the 12th century, formerly an Augustinian convent. The convent church is Romanesque in style and there is a curious two-storied chapel

of octagonal form, of the same period. The church of Notre-Dame is a combination of Romanesque and Gothic, dating from the 12th and 13th centuries.

MONTMORIN DE SAINT HÉREM, ARMAND MARC, COMTE DE (1745-1792), French statesman, belonged to a cadet branch of a noble family of Auvergne. He was gentleman-in-waiting to Louis XVI. when dauphin, and was subsequently appointed ambassador at Madrid. From Madrid he was suddenly summoned to the governorship of Brittany, and in 1787 was appointed by the king to succeed Vergennes in the ministry of foreign affairs. Montmorin was a devoted admirer of Necker, whose influence at the court he was mainly instrumental in maintaining. He retired when Necker was dismissed on the 12th of July 1789, but on Necker's recall after the taking of the Bastille again resumed his office, which he continued to hold till October 1791. Mirabeau (*q.v.*) had approached him so early as December 1788, with a plan for the policy to be pursued by the court towards the new states general; but Montmorin, offended by Mirabeau's attacks on Necker and by his *Histoire secrète de la cour de Berlin*, refused to see him. With the progress of the Revolution, however, this attitude was changed. The comte de la Marck was exerting himself to bring Mirabeau into touch with the court (see MIRABEAU), and for this purpose it was important to secure the assistance of Montmorin. The convenience of an understanding between the two men was obvious; and they were soon on the closest terms. While Montmorin continued minister in name, Mirabeau became so in fact. Montmorin did not dare to come to a decision without consulting his masterful friend, but on the other hand neither Mirabeau nor La Marck were under any illusions as to the broken character of the reed on which they had perforce to lean. Mirabeau complained bitterly that Montmorin was "slack" (*Rasque*) and a "poltroon" (*gavache*). On the other hand, La Marck thought that Montmorin's feebleness was occasionally useful in restraining Mirabeau's impetuosity. The death of Mirabeau in April 1791 was a severe blow to Montmorin, the difficulty of whose position was enormously increased after the flight of the royal family to Varennes, to which he was not privy. He was forced to resign office, but still continued to advise Louis, and was one of the inner circle of the king's friends, called by the revolutionists "the Austrian Committee." In June 1792 his papers were seized at the foreign office, without anything incriminating being discovered; in July he was denounced, and after the 10th of August was proscribed. He took refuge in the house of a washerwoman, but was discovered, haled before the Legislative Assembly, and imprisoned in the Abbaye, where he perished in the September massacres. His relative, Louis Victor Henri, marquis de Montmorin de Saint Hérem, head of the elder branch, also perished in the massacre.

See A. Bardoux, *Pauline de Montmorin, comtesse de Beaumont: Études sur la fin du XVIII^{ème} siècle* (Paris, 1884), for a defence of Montmorin's policy; F. Masson, *Le Département des affaires étrangères pendant la révolution, 1787-1804*, ch. ii. (Paris, 1877); A. de Bacourt, *Correspondance entre Mirabeau et le comte de La Marck, 1789-1791* (3 vols., Paris, 1851), contains many letters of Montmorin; "Correspondance of the Comte de Moustier with the Comte de Montmorin," in the *Amer. Hist. Rev.*, vol. viii. (1902-1903).

MONTORO, a town of southern Spain, in the province of Cordova, 27 m. E. by N. of the city of Cordova, on the Madrid-Cordova railway. Pop. (1900), 14,581. Montoro was the *Epora* of the Romans, and became an important Moorish fortress in the middle ages, but it has been largely modernized. It stands on a rocky peninsula on the south bank of the Guadalquivir, here crossed by a fine bridge of four arches dating from the 16th century. Oil is largely manufactured, and there is considerable trade in timber, agricultural produce and livestock.

MONTPELIER, a city, the capital of Vermont, U.S.A., and the county-seat of Washington county, on the Winooski river, 40 m. (by rail) E.S.E. of Burlington. Pop. (1900), 6266 (952 foreign-born); (1910), 7856. Montpelier is served by the Central Vermont and the Montpelier & Wells River railways. Barre granite is mined extensively in the vicinity, and the city manufactures marble and granite products, flour, lumber, saddlery

hardware and wood-working machinery. The principal building is the state house, crowned by a statue of Agriculture by Larkin G. Mead. The state house was first occupied in 1836. It was almost completely destroyed by fire in 1857, and was subsequently rebuilt and enlarged. Other prominent features of the city are the United States government building, the county court house, the Montpellier seminary and the Wood art gallery, a collection consisting principally of paintings by Thomas Waterman Wood (1823-1903), a native of Montpellier. The township of Montpellier, named from the city in France, was granted to a company of sixty proprietors in 1780. The first permanent settlement was made in 1787; and the township was organized in 1791 under a charter of 1781, replaced by another in 1804. In 1805 it was selected as the capital of the state, and in 1808 the legislature met here for the first time. At first the township was a part of Orange county, but in 1810 Washington county was created, and in 1811 Montpellier became the seat of government of the new county. In 1849 East Montpellier was set apart as a separate township, and in 1894 the township of Montpellier was chartered as a city.

MONTPELLIER, a town of southern France, capital of the department of Hérault, about 7 m. from the Mediterranean, and 31 m. S.W. of Nîmes on the Paris-Lyon railway between that town and Cette. Pop. (1906), 65,983. Montpellier, the seat of a university and the principal place of lower Languedoc, is situated in a fruitful plain less than a mile from the right bank of the small river Lez. Composed for the most part of narrow winding streets, the town has at the same time several spacious thoroughfares and some fine squares and promenades, notably the much-frequented Place de la Comédie, the Esplanade and the Peyrou. The last terminates in a terrace commanding a magnificent view of the coasts of the Mediterranean, and of the Pyrenees and Alps. On the terrace is situated the reservoir of the town, the water being brought from a distance of about 8 m. by an aqueduct. In the centre of the square is an equestrian statue of Louis XIV., while opposite the entrance is the Porte de Peyrou, a triumphal arch erected at the end of the 17th century to commemorate the achievements of Louis XIV. The Boulevard Henri IV. to the north leads past the botanical garden, founded in 1593 and thus the oldest in France, the medical college, and the cathedral; to the east the Rue Nationale leads to the palace of justice, the prefecture, and the citadel. The cathedral (14th century), which until 1536 was the church of a Benedictine monastery, suffered severely during the religious wars, and about the middle of the 19th century the choir and one of the four towers at the angles of the nave were rebuilt in the style of the 13th century. The monastery, after being converted into the bishop's palace, has since 1795 been occupied by the famous medical school. A gallery devoted to the portraits of professors since 1239 contains one of Rabelais. Close to the medical school is the Tour des Pins, the chief relic of the medieval fortifications. The museum (Musée Fabre) contains rich collections of Italian, Flemish, Dutch and modern French paintings and of French sculptures. Its nucleus was the collection given to it by the painter F. X. P. Fabre (1766-1837), born at Montpellier. The principal public buildings are the palace of justice—a modern structure, the theatre and the prefecture, also modern. Montpellier possesses old houses of the 15th and 16th centuries. The Lez is canalized so as to connect Montpellier with the canal du Midi and with the sea at Palavas. The town has a considerable trade in wine, brandy, fruit and silk. The principal industrial establishment is a manufactory for candles and soap. There are also tanneries, distilleries and manufactories of cotton and woollen goods, chemicals, casks, hosiery and chocolate. The town is the centre of an *académie* (educational division) and has long been renowned as a seat of learning. Montpellier university comprises faculties of medicine, law, science and letters, and a higher school of pharmacy. Montpellier is also the seat of a bishop and a prefect, of courts of appeal and assizes, tribunals of first instance and of commerce, a chamber of commerce, a board of trade arbitration, and headquarters of the XVI. army corps.

Montpellier first rose into importance after the destruction of Maguelonne by Charles Martel in 737. In the 10th century it consisted of two portions, Montpellier and Montpelliéret, held from the bishops of Maguelonne by the family of Guilhem. The Guilhems were succeeded, through marriage, by the house of Aragon, a member of which in 1349 sold his rights to Philip of Valois, Montpelliéret having already in 1292 been ceded to the Crown by the bishops. In 1141 Montpellier acquired a charter afterwards materially extended, and the same century saw the rise of its school of medicine. Several of the ablest teachers of that school were members of an important Jewish colony established in the town. It had a school of law in 1160, and a university was founded by Pope Nicholas IV. towards the close of the 13th century. Louis IX. granted to Montpellier the right of free trade with the whole of the kingdom, a privilege which greatly increased its prosperity. The importance of the town was enhanced when the bishopric of Maguelonne was transferred thither in 1536. During the wars of religion the town was a stronghold of the Protestants, who captured it in 1567. It strenuously supported the duke of Rohan in his revolts and in 1622 only succumbed to Louis XIII. after a siege of eight months. In 1628 the duke was defeated there and the walls of the town razed, the royal citadel built in 1624 being, however, spared. Louis XIII. made Montpellier the seat of one of the *généralités* of Languedoc, and the states of that province met there during the 17th and 18th centuries.

See A. C. Germain, *Histoire du commerce de Montpellier antérieure-ment à l'ouverture du port de Cette* (2 vols., Montpellier, 1861), and *Histoire de la commune de Montpellier* (3 vols., Montpellier, 1851); Aigreulle, *Histoire de la ville de Montpellier* (4 vols., Montpellier, 1875-1882).

MONTPENSIER, COUNTS AND DUKES OF. The French lordship of Montpensier (department of Puy-de-Dôme), which became a countship in the 14th century, was sold in 1384 by Bernard and Robert de Ventadour to John, duke of Berry, whose daughter Marie brought the countship to her husband, John I., duke of Bourbon, in 1400. The countship was subsequently held by Louis de Bourbon, younger son of Duke John, and by his descendants up to Charles de Bourbon-Montpensier, the famous constable, who became duke of Bourbon by his marriage with his cousin, Suzanne de Bourbon, in 1505. Confiscated by King Francis I., the countship was restored in 1538 to Louise de Bourbon, sister of the constable, and widow of the prince de La Roche-sur-Yon, and to her son Louis (1513-1582), and was erected into a duchy in the peerage of France (*duché-pairie*) in 1539. Marie, daughter and heiress of Henri de Bourbon, duke of Montpensier, brought the duchy to her husband Gaston, duke of Orleans, brother of Louis XIII., whom she married in 1626, and their daughter and heiress (see below), known as "La Grande Mademoiselle," was duchess of Montpensier. The title subsequently remained in the Orleans family, and was borne in particular by Antoine Philippe (1775-1807), son of Philippe "Égalité," and Antoine Marie Philippe Louis (1824-1890), son of King Louis Philippe and father-in-law of King Alphonso XII. of Spain.

MONTPENSIER, ANNE MARIE LOUISE D'ORLÉANS, DUCHESSE DE (1627-1693), French memoir-writer, was born at the Louvre on the 29th of May 1627. Her father was Gaston of Orleans, "Monsieur," the brother of Louis XIII. Her mother was Marie de Bourbon, heiress of the Montpensier family. Being thus of the blood-royal of France on both sides, and heiress to immense property, she appeared to be very early destined to a splendid marriage. It was perhaps the greatest misfortune of her life that "la grande mademoiselle" was encouraged to look forward to the throne of France as the result of a marriage with Louis XIV., who was, however, eleven years her junior. Ill-luck, or her own wilfulness, frustrated numerous plans for marrying her to persons of exalted station, including even Charles II. of England, then prince of Wales. She was just of age when the Fronde broke out, and, attributing as she did her disappointments to Mazarin, she sympathized with it not a little. In the new or second Fronde she not only took nominal command of one of the

armies on the princes' side, but she literally and in her own person took Orleans by escalade. However, she had to retreat to Paris, where she practically commanded the Bastille and the adjoining part of the walls. On the 2nd of July 1652, the day of the battle of the Faubourg Saint Antoine, between the Frondeurs under Condé and the royal troops under Turenne, Mademoiselle saved Condé and his beaten troops by giving orders for the gates under her control to be opened and for the cannon of the Bastille to fire on the royalists. In the heat of the *émeute* which followed she installed herself in the Hôtel de Ville, and played the part of mediatrix between the opposed parties. Her political importance lasted exactly six months, and did her little good, for it created a lifelong prejudice against her in the mind of her cousin, Louis XIV. She was for some years in disgrace, and resided on her estates. It was not till 1657 that she reappeared at court, but, though projects for marrying her were once more set on foot, she was now past her first youth. She was nearly forty, and had already corresponded seriously with Mme de Motteville on the project of establishing a ladies' society "sans mariage et sans amour," when a young Gascon gentleman named Puyguilhem, afterwards celebrated as M. de Lauzun (*q.v.*), attracted her attention. It was some years before the affair came to a crisis, but at last, in 1670, Mademoiselle solemnly demanded the king's permission to marry Lauzun. Louis, who liked Lauzun, and who had been educated by Mazarin in the idea that Mademoiselle ought not to be allowed to carry her vast estates and royal blood to anyone who was himself of the blood-royal, or even to any foreign prince, gave his consent, but it was not immediately acted on, as the other members of the royal family prevailed with Louis to rescind his permission. Not long afterwards Lauzun, for another cause, was imprisoned in Pignerol, and it was years before Mademoiselle was able to buy his release from the king by settling no small portion of her estates on Louis's bastards. The elderly lovers (for in 1681, when Lauzun was released, he was nearly fifty, and Mademoiselle was fifty-four) were then secretly married, if indeed they had not gone through the ceremony ten years previously. But Lauzun tyrannized over his wife, and it is said that on one occasion he addressed her thus, "Louise d'Orléans, tire-moi mes bottes," and that she at once and finally separated from him. She lived for some years afterwards, gave herself to religious duties, and finished her *Mémoires*, which extend to within seven years of her death (April 9, 1693), and which she had begun when she was in disgrace thirty years earlier. These *Mémoires* (Amsterdam, 1729) are of very considerable merit and interest, though, or perhaps because, they are extremely egotistical and often extremely desultory. They are to be found in the great collection of Michaud and Poujoulat, and have been frequently edited apart. Her *Eight Beauties* has been edited by E. Rodocanachi as *Un Ouvrage de piété inconnu* (1908).

See the series of studies on La Grande Mademoiselle, by "Arvédé Barine" (1902, 1905). (G. SA.)

MONTREAL, a city of the Dominion of Canada, its leading seat of commerce and principal port of entry, as well as the centre of many of its important industries. It is situated on the south-east of the island of Montreal, at the confluence of the Ottawa and St Lawrence rivers, in the county of Hochelaga and province of Quebec. The observatory in the grounds of McGill University, in the city, has been determined to be in 45° 30' 17" N. lat., and 73° 34' 40-05" W. long. The city holds a fine position at the head of ocean navigation, nearly a thousand miles inland, and at the foot of the great system of rivers, lakes and canals upon which the commerce of the interior is carried to the Atlantic seaboard. The ship channel below Montreal permits the passage of ocean vessels drawing 30 ft. at low water. The deepening of the channel, largely due to the initiative of Montreal merchants, was begun in 1844 by the government of Canada. The work was transferred to the Harbour Commissioners of Montreal in 1850. The depth of the channel was then 11 ft. Fifteen years later it had gradually been increased to 20 ft.; and in 1888, when the work was taken over by the Dominion government, the depth was 27 ft. 6 in. The Lachine canal,

with the chain of artificial waterways that succeeded it, opened the way for the shipping of the Great Lakes. The first sod in the digging of the Lachine canal was turned in July 1821 by John Richardson of Montreal. The same public-spirited merchant presided in April of the following year at the preliminary meeting which led to the formation of the committee of trade, itself the forerunner of Montreal's indispensable board of trade. Even before the close of the French régime in Canada efforts had been made to cut a canal across the island of Montreal, and M. de Catalogne succeeded in building a waterway practicable for the canoes of the fur-traders. The more ambitious canal commenced in 1821 was completed four years later, at a cost of \$440,000. Before its completion, however, the increasing draught of inland shipping made it practically useless, and in 1843 work was begun on an enlargement. Since then the canal has been repeatedly deepened, to keep pace with the requirements of lake shipping, until to-day a 14-ft. channel is available. In the meantime the rival method of rail transportation was taking shape, and in 1836 the first Canadian railway was opened, between Laprairie, opposite Montreal and St Johns, in the eastern townships. In 1848 a second railway, from Longueuil to St Hyacinthe, was opened; both these projects owing their existence to the enterprise of Montreal citizens. The broad St Lawrence, however, still lay between the city and the outside world. In 1854 work was commenced upon the famous Victoria tubular bridge, designed by Robert Stephenson and A. M. Ross. The bridge was opened by King Edward VII, then prince of Wales, in 1860. In 1898 it was replaced by the Victoria Jubilee bridge, built on the piers of the old bridge. At the foot of Lake St Louis, some distance above the Victoria Jubilee bridge, the Canadian Pacific railway crosses the river on a graceful cantilever bridge with two central spans each 408 ft. long. Montreal is on the Canadian Pacific, Grand Trunk, Intercolonial, Canadian Northern, New York Central, Rutland, Central Vermont and Delaware & Hudson railways. During the season of navigation several lines of well-appointed steamers maintain communication with Liverpool, London, Glasgow, Bristol and other British and European ports, as well as the principal ports on the river and gulf of St Lawrence and the Great Lakes. A system of electric railways covers every section of the city and affords easy communication with the suburbs and neighbouring towns.

Built originally along the water-front, Montreal has in the course of years swept back over a series of terraces—former levels of the river or of a more ancient sea—to the foot of Mount Royal. Held there, it has been forced around the mountain on either side. Mount Royal, from which the city derives its name and so much of its natural beauty, is a mass of trap-rock thrown up through the surrounding limestone strata to a height of 753 ft. above the level of the sea. Under the direction of Frederick Law Olmsted, it was converted into a magnificent park. Between mountain and river the Lachine canal winds through the plain. In the middle of the river lies the beautifully wooded St Helen's island, rising to a height of 150 ft. above the water, and itself commanding an excellent view of the city. The island, named after Helen Boullé, wife of Champlain, belonged at one time to the barons of Longueuil. The British government purchased it for military purposes, and it still contains a battery of guns and barracks, the latter tenantless, since the island has been loaned to the city for use as a public park.

The city is substantially built, grey limestone, quarried from the mountain, predominating in the public and many of the private edifices. On the south of the Place d'Armes, a small enclosure covering the site of an ancient burying-ground, stands the parish church of Notre Dame, whose Gothic outlines form one of the striking features of the city. Designed by James O'Donnell, the church was built in 1824 to take the place of an earlier structure dating back to 1672. The existing church is 255 ft. long and 134 ft. wide, and accommodates 10,000 worshippers. Its twin towers (227 ft.) contain ten bells, one of which, known as "Le Gros Bourdon," weighs 24,780 lb, the largest in America. Two others weigh respectively 6041 and 3633 lb. Beside the church stands the historic seminary of St Sulpice, one of the

few remaining relics of the days of French rule. This ancient building is now used for the offices of the Order of Sulpicians, founded by the Abbé Olier in the early half of the 17th century. This zealous enthusiast had sent out Paul de Chomedey, sieur de Maisonneuve, in 1641 to establish the missionary enterprise which afterwards developed into the city of Montreal, and six years later the Abbé de Quélus, with three devoted companions, landed at Ville-Marie de Montreal and laid the foundations of the future powerful Order of Sulpicians. The seignury of Montreal, acquired by Olier in 1640, is still held by the Sulpicians, and as they have retained large blocks of land in the heart of the city as well as elsewhere on the island, these "Gentlemen of the Seminary," as they were locally called, rank among the wealthiest societies in America. The head offices of the Bank of Montreal face Notre Dame church, on the north of the Place d'Armes, and several other of the leading banking institutions of the city have their quarters in the immediate neighbourhood. In the Place d'Armes itself stands a striking figure in bronze erected to the memory of the founder of Montreal, Maisonneuve. At the base are a series of bas-reliefs setting forth historical incidents connected with the early history of the town. The monument is the work of a Canadian sculptor, Louis Philippe Hébert, C.M.G. The Roman Catholic cathedral of St James stands upon Dominion Square. It is an almost exact reproduction, reduced to one-half the scale, of St Peter's at Rome. The building, projected by the late Archbishop Bourget to replace the old church on St Denis street destroyed in the great fire of 1852, was begun in 1868. On the west of the square stand the Windsor Street station of the Canadian Pacific railway; St George's (Anglican) church, which possesses a fine chime of bells; and the Windsor Hotel. A statue of Sir John Macdonald occupies the centre of the square. Close to the historic Bonsecours Market stands the church of Notre Dame de Bonsecours, founded by Sister Marguerite Bourgeoise in 1673 as a sanctuary for a miraculous statue of the Virgin. The original church was burned in 1754, and the present building, erected in 1771, an example of Norman architecture transplanted to the New World, narrowly escaped destruction to make room for a railway station. Curiously enough, it remained for a number of English Protestants to secure the preservation of this relic of the French period. Jacques Cartier Square, adjoining Bonsecours Market, is notable for its column and statue of Nelson, erected in 1808. As the Roman Catholic cathedral owes its existence to the energy and enthusiasm of Archbishop Bourget, so Christ Church cathedral must always be associated with the name of the first resident Anglican bishop of Montreal, Dr Fulford. The church is a fine example of the Early English style of architecture. Beside it stands a memorial of Bishop Fulford, modelled after the famous Martyr's Memorial at Oxford.

The mixture of races and creeds, which is so striking a characteristic of Montreal life, has not only endowed the city with many beautiful churches, but also with varieties of philanthropic institutions. Each of the several national societies—St George's, St Andrew's, St Patrick's, and that of the French-Canadian patron saint, St Jean Baptiste, to mention no others—looks after the welfare of its own adherents. Of the several hospitals, the most venerable is the Hôtel Dieu, founded in 1644 by Mme de Bouillon, a French lady of high rank. The original building, in the early days of Ville Marie, stood without the fort, and was fortified to withstand the attacks of the Iroquois. The site is now covered by a block of warehouses on St Paul Street. The present buildings, completed in 1861, contain both a hospital and nunnery. The Order of the Grey Nuns, founded by a Canadian lady, Mme d'Youville, in 1737, cares for hundreds of foundlings and aged and infirm people in the great hospital in Guy Street. The Montreal General hospital was founded in 1819 by public subscriptions, and the Royal Victoria hospital is a monument to the generosity of Lord Strathcona and Lord Mount-Stephen. Besides these should be mentioned the Notre Dame, the Western and the Children's Memorial hospitals. Separate hospitals for contagious diseases are maintained both by the Roman Catholics and Protestants.

Montreal provides for the education of its young people through two distinct systems of public schools, one for Roman Catholics, the other for Protestants, each governed by a board of commissioners. The schools are maintained by an annual tax based upon the assessment, two-fifths of 1% being levied upon the Protestant section of the community for the support of the Protestant schools, and one-quarter of 1% upon the Catholics for their schools. Unlike the neighbouring provinces of Ontario, Quebec makes no provision for a state university. But James McGill (1744-1813) left property, valued at the time of his death at £30,000, for the foundation of a university, one college of which was to bear his name. A royal charter conferring university powers was obtained in 1821. During early years slow progress was made, but with the appointment of Sir William Dawson as principal, in 1855, the institution entered on a career of prosperity. It now embraces five faculties: arts, applied science, law, medicine, agriculture, and comprises the following: McGill College, Montreal, the original foundation; the Royal Victoria College for Women, Montreal, built and endowed by Lord Strathcona; four affiliated theological colleges in Montreal; the Macdonald College, erected and endowed by Sir William C. Macdonald, at Ste Anne de Bellevue, 20 m. from the city; the McGill University College of British Columbia, Vancouver, B.C.; and three affiliated colleges: Stanstead Wesleyan College, Stanstead, P.Q.; Victoria College, Victoria, B.C.; Alberta College, Edmonton. The finely-equipped Macdonald scientific laboratories, with the Redpath Museum and University Library (114,000 vols. in 1907), form part of a noble group of buildings on the campus in Montreal. Disastrous fires in April 1907 wiped out two buildings and destroyed the splendid medical museum, but the plans for rebuilding provided for further extension and improvement. Previous to the fires the property of the university in buildings in Montreal, including equipment and endowment, was valued at \$6,000,000.

The French university of Laval, the chief seat of which is in the city of Quebec, also maintains a branch at Montreal, established in 1877. It embraces the faculties of arts, law, medicine and theology, the latter conducted through the Seminary of St Sulpice. The college library has been enriched by a rare collection of Canadian books and manuscripts, bequeathed by Judge Louis François Georges Baby (1834-1906), of Montreal. The medical school, which now occupies a portion of the university building, formerly held its sessions in the historic Chateau de Ramesay, built by the Chevalier de Ramesay, governor of Montreal, in 1704, and occupied after the conquest by the British governors of Canada, until the stoning of Lord Elgin and the burning of the Parliament Buildings in 1849 brought about the removal of the seat of government from Montreal. The Chateau de Ramesay is now the fitting home of a public collection of historic relics. Of other educational institutions in the city the most important is St Mary's College, founded in 1848 by the Jesuits, and removed to the present building in 1855. The archives boast a notable collection of early Canadian manuscripts, upon which Francis Parkman drew in preparing his histories of New France.

Montreal's position as the chief doorway of the outgoing and incoming trade of the Dominion is largely due to the foresight of her great merchants. With the gradual opening up of means of communication by land and water, and the development of her facilities for handling the exports and imports of the country, the city has increased rapidly in importance, until to day one-third of the imports of the Dominion come through Montreal, and nearly 30% of the exports. In shipments of grain Montreal has outstripped all her rivals on the continent except New York and New Orleans, and the building of the Georgian Bay canal will, by materially shortening the distance between the western grainfields and European markets, give her a very considerable advantage over both these ports. In dairy produce she is already the chief export centre of the continent. Montreal is also the financial centre of Canada, and in it are to be found the head offices of more than 25 important banks, of the leading insurance companies, and of the two greatest railways of the country.

Montreal is governed by a mayor and 36 aldermen, elected every two years. The city returns 5 members to the Dominion House of Commons and 6 to the Provincial Legislature of Quebec.

The population of Montreal, according to the census of 1907, was 266,826. With the suburbs, it was estimated in 1907 at over 405,000, about three-fifths French.

The history of the town is steeped in romance. From that first remarkable scene, so graphically described by Francis Parkman, when, on the 18th of May 1642, Maisonneuve and his little band of religious enthusiasts landed upon the spot where the Montreal Custom House now stands, and planted, in the words of the saintly Dumont, a grain of mustard seed destined to overshadow the land, the history of the town was to be intimately associated with missionary enterprise and such missionary heroism as the world has rarely seen. Montreal began as a religious colony, but its very situation, on the outer confines of civilization and at the door of the Iroquois country, forced it to become a military settlement, a fortified town with a military garrison. Similarly its position, even then an ideal one from a commercial point of view, made it the dominating centre of the fur-trade. For a hundred years after its foundation these three influences held sway, more or less mutually antagonistic, the streets of Montreal presenting an animated picture of sombre priests and jovial soldiers, savage hunters in their native finery and more than half-savage fur traders. Within another hundred years, although both priests and soldiers were still to be seen on her streets, they had become but atoms in a larger and more varied population. The fur trader of New France, merged after the conquest in the fur trader of the North West Company—which had its origin in Montreal—remained for a time the one picturesque survival of earlier and more romantic days. Finally, he too disappeared in the multifarious and strenuous life of the modern city.

BIBLIOGRAPHY.—Francis Parkman, *Jesuits in North America and The Old Régime in Canada* (Boston, new ed., 1902); Newton Bosworth, *Hochelaga depicta* (Montreal, 1846; repr. Toronto, 1901); A. Sandham, *Montreal Past and Present* (Montreal, 1870); W. D. Lighthall, *Montreal after Two Hundred and Fifty Years* (Montreal, 1892); N. M. Hinselwood, *Montreal and Vicinity* (Montreal, 1904); S. E. Dawson, *Handbook for the City of Montreal* (Montreal, 1888); A. Leblond de Brumath, *Histoire populaire de Montréal* (Montreal, 1890); H. Beaugrand, *Le Vieux Montréal* (Montreal, 1884); Dollier de Casson, *Histoire du Montréal, 1640-1672* (Montreal, 1868); J. D. Borthwick, *Montreal, its history, &c.* (Montreal, 1875). (L. J. B.)

MONTRÉSOR, CLAUDE DE BOURDEILLE, COMTE DE (c. 1606-1663), French intriguer and memoir-writer, was the grand-nephew of Pierre de Brantôme. He was the second favourite of Gaston, duke of Orleans, the weak brother of Louis XIII., succeeding Antoine de Laage, duc de Puylaurens, in this position in 1635. He planned the assassination of Cardinal Richelieu at the camp of Amiens in 1636, a plan which failed through the cowardice of Orleans. Montrésor was obliged to spend the next six years on his estate, but in 1642 he entered into the plot of Cinq Mars against Richelieu. On its failure he escaped to England, but his estates were confiscated. Returning after Richelieu's death, he entered into the intrigues of the period just preceding the Fronde, and was imprisoned in the Bastille, then in Vincennes, having risked his safety by coming back from exile in Holland to aid the duchess of Chevreuse. Mazarin attempted to win him over in vain, but in 1653 he made his submission to the victorious minister, and from that time on played no part in public life. He had three children by Mlle de Guise, with whom he had a lasting liaison.

His *Mémoires* have preserved his name from the oblivion otherwise awaiting such intriguers; they are written with naive frankness and are extremely interesting. They are printed by A. Petitot and Monmerqué in *Collection des mémoires relatifs à l'histoire de France* (Paris, 1876).

MONTRÉUIL, GERBERT DE (fl. 13th century), French troubadour, author of the *Roman de la violette*. He dedicated his poem (c. 1221) to the Countess Marie of Ponthieu, wife of Simon, count of Damartin and a niece of Philip Augustus. The count

Gerard de Nevers of the story stakes his domains on the fidelity of his wife Euriant. Lisard by calumniating Euriant wins the wager, but in the end the traitor is exposed, and, after many adventures, Euriant is reinstated. Another version of the story is given in the *Roman du comte de Poitiers* and in the tale in the *Decameron* (ii. 9) in which Shakespeare founded *Cymbeline*. Lyrics are inserted in the narrative of the *Roman de la violette*, as they had been in the *Conte de la rose* (1200), known also as *Guillemme de Dole*. A prose version, dating from the early 15th century, provided Wilhelmine de Chézy with the material for her libretto of Weber's opera, *Euryanthe* (1823).

See *Hist. litt. de France*, xxii. 782, xviii. 760, xxii. 826; *Le comte de Poitiers* (ed. F. Michel, 1831); *Le Roman de la violette* (ed. F. Michel, 1834); *Le Conte de la rose* (ed. Servois, 1893); F. Kraus, *Über Gerbert de Montréuil* (Erlangen, 1897); Rudolf Ohle, *Shakespeares Cymbeline und seine romanischen Vorläufer* (Berlin, 1890).

MONTRÉUIL-SOUS-BOIS, a town of northern France in the department of Seine, 5 m. E. of Paris, on the slope and summit of a hill, about 1 m. N. of Vincennes. Pop. (1906), 35,831. Montréuil is specially noted for its extensive peach orchards. The manufactures include paint, oils and varnish, glass and chemical products.

MONTRÉUIL-SUR-MER, a town of northern France, capital of an arrondissement in the department of Pas-de-Calais, 24 m. S. by E. of Boulogne by rail. Pop. (1906), 2883. The town with its old citadel and ramparts, due largely to Vauban, is prettily situated on an eminence on the left bank of the Canche 10 m. from the English Channel. The chief buildings are the church of St Sauve (12th, 13th and 16th centuries), and a hospital founded in 1200 and rebuilt in the 19th century, with a fine chapel in the Flamboyant style. The buildings of the old abbey of Ste Austreberthe, founded originally in the 11th century, still remain. Montréuil is the seat of a sub-prefect and has a tribunal of first instance and a preparatory infanry school. The town owes its origin to a monastery established in the 7th century by St Sauve, bishop of Amiens.

MONTRÉUX, the general name applied to the villages situated along the shore at the east of the Lake of Geneva in Switzerland, from Clarens to Veveytaux: sometimes the name is specially given to Vernex only. These villages form part of 3 communes, those of Le Châtelard (including Clarens and Vernex) and of Les Planches (including Territet), while a bit (not Chillon) of that of Veveytaux is alone included. The total population of this "agglomeration" was 14,144 in 1900, mostly French-speaking, while there were 9730 Protestants to 4301 Romanists and 55 Jews. There are railway stations at Clarens (15 m. south-east of Lausanne), at Vernex (3 m. on), and Territet (1 m. on, or 1/2 m. from Veveytaux, which is 1 1/2 m. north of Villeneuve), as well as an electric tramway along the shore of the lake, and frequent communication over the lake by steamer. From Territet there is a mountain railway past Glion and Caux nearly to the top of the Rochers de Naye (6710 ft.), while from Vernex the Montreux-Bernese-Oberland railway mounts past Les Avants, pierces the ridge of the Col de Jaman by a tunnel, and so reaches (14 m.) Montbovon in the Gruyère portion of the upper Sarine valley. At first foreigners were attracted by the cheapness and good air of the region, added to the grape cure. As the delights of clear, cold weather in winter and of tobogganing (here called "luging") and skiing became appreciated, the higher hotels (such as Les Avants, Caux, Glion) were frequented at that season, as well as at other times. It is stated that in 1902 31,473 foreigners (in 1903, 39,493) visited Montréux, 7634 being Germans, 7327 English, and 5651 French. Montréux was not a Roman settlement, but otherwise its history is similar to that of Vevey.

MONTROND, CASIMIR, COMTE DE (1768-1843), French diplomatic agent, was the son of a military officer; his mother, Angélique Marie d'Arles, comtesse de Montrond (d. 1827), was a royalist writer, said to be the author of the *Troubadour béarnois*, a song which has the refrain "Louis, le fils de Henri, Est prisonnier dans Paris." Casimir was imprisoned in 1794 in St Lazare, where he met the divorced duchesse de Fleury (née Franquetot de

Coigny), the "jeune captive" of André Chénier's famous verses. He bought her freedom and his own with 100 louis. They married and crossed to London, but the union proved unhappy, and they were divorced on their return to Paris.

Turning to the fashionable world, Casimir de Montrond became famous for his successes. He was the confidant and political agent of Talleyrand, and his inside knowledge of politics enabled him to make a large fortune on the Bourse. In 1809 he was disgraced for some imprudent comments on the imperial system, and exiled from Paris. After spending some time at Antwerp he removed to Spa, where he was on intimate terms with Pauline Borghèse, and in 1811 he returned to Antwerp; here he was arrested by Napoleon's orders and sent to the fortress of Ham. After a month's imprisonment he received permission to reside, under police supervision, at Châtillon-sur-Seine, whence he presently escaped to England. He returned to France at the first Bourbon restoration, and during the Hundred Days was entrusted with a mission to Vienna to convert Talleyrand to Napoleon's interests, to see Metternich and Nesselrode, and to bring back if possible Marie Louise and the king of Rome. The second restoration restored him to his social triumphs, though he was always under police supervision, and on Talleyrand's fall he accompanied him to Valençay and continued to help with his intrigues. He followed Talleyrand to London in 1832. Montrond returned to Paris some time before his death in 1843.

See H. Welschinger, "L'Ami de M. de Talleyrand," in the *Revue de Paris* (Feb. 1895); Lanzac de Laborie, *La Domination française en Belgique* (1895); and Amédée Pichot, *Souvenirs sur M. de Talleyrand* (1870).

MONTROSE, MARQUESSES AND DUKES OF. David Lindsay, 5th earl of Crawford (c. 1440-1495), was created duke of Montrose in 1488 (the first dukedom conferred in Scotland on a person not of royal blood), as a reward for remaining loyal to James III. during the rebellion of Angus and Prince James. Montrose was deprived of his dukedom by James IV., but it was restored in 1489 for life only. On his death in 1495 the title therefore became extinct.

In 1505, William, 4th Lord Graham, whose wife Annabella Drummond was the duke's niece, was created earl of Montrose; and this title was held by his descendants till 1644, when James Graham, 5th earl, was created marquess of Montrose and earl of Kincardine. This was the celebrated marquess of Montrose (q.v.) of the Civil War, whose son and successor, James (c. 1631-1669), was known as "the Good Marquess." The latter refused to vote at the trial of his hereditary enemy the marquess of Argyll in 1661, admitting that he could not act impartially in such a matter; and the two noblemen afterwards became firm friends. The good marquess died in 1669, and was succeeded by his son James, 3rd marquess of Montrose (d. 1684). The 4th marquess, son of the last mentioned, who was also named James (d. 1742), was lord high admiral of Scotland in 1705, and lord president of the council in 1706. He was an ardent supporter of the Hanoverian succession; he also favoured the union of Scotland with England, for his services in regard to which he was created duke of Montrose and marquess of Graham in 1707, becoming in the same year one of the first representative peers of Scotland in the parliament of Great Britain. He was one of the regents of the kingdom on the death of Queen Anne, and was appointed a secretary of state by George I. He took an active part in suppressing the Jacobite rising in 1715, after which he was made keeper of the great seal in Scotland. He died in 1742. During his lifetime his son David was raised to the peerage of Great Britain with the title of Earl Graham; and on David's death without issue in 1731 this earldom passed under a special remainder to his brother William (c. 1710-1790), who on his father's death in 1742 succeeded to the dukedom also. William's son James, 3rd duke of Montrose (1755-1836), held office in Pitt's administrations in 1783 and 1804, and in that of the duke of Portland in 1807. He obtained the annulment of the law prohibiting Highlanders from wearing the kilt. He was succeeded by his son James (1799-1874), who held office under the earl of Derby in 1852, and again in 1858

and 1866, and was father of Douglas Beresford Malise Ronald, 5th duke (b. 1852). In 1853 James Lindsay, 24th earl of Crawford, claimed the title of duke of Montrose on the ground that the patent granted to his ancestor David Lindsay in 1488 (see above) had not been effectually rescinded, but his petition was dismissed by the House of Lords.

MONTROSE, JAMES GRAHAM, MARQUESSES OF (1612-1650), was born in 1612, and became 5th earl of Montrose (see above) by his father's death in 1626. He was educated at St. Andrews, and at the age of seventeen married Magdalene Carnegie, daughter of Lord Carnegie (afterwards earl of Southesk). Not long after the outbreak of the Scottish troubles in 1637 he joined the party of resistance, and was for some time one of its most energetic champions. He had nothing puritanical in his nature, but he shared in the ill-feeling aroused in the Scottish nobility by the political authority given by Charles to the bishops, and by Hamilton's influence with the king, and also in the general indignation at the scheme of imposing upon Scotland a liturgy which had been drawn up at the instigation of the English court and corrected by Archbishop Laud. He signed the Covenant, and was told off to suppress the opposition to the popular cause which arose around Aberdeen and in the country of the Gordons. Three times, in July 1638, and in March and June 1639, Montrose entered Aberdeen, where he succeeded in effecting his object, on the second occasion carrying off the head of the Gordons, the marquess of Huntly, as a prisoner to Edinburgh, though in so doing, for the first and last time in his life, he violated a safe-conduct.

In July 1639, after the signature of the treaty of Berwick, Montrose was one of the Covenanting leaders who visited Charles. This change of policy on his part, frequently ascribed to the fascination of the king's conversation, arose in reality from the nature of his own convictions. He wished to get rid of the bishops without making presbyters masters of the state. His was essentially a layman's view of the situation. Taking no account of the real forces of the time, he aimed at an ideal form of society in which the clergy should confine themselves to their spiritual duties, and the king, after being enlightened by open communication with the Scottish nation, should maintain law and order without respect of persons. In the Scottish parliament which met in September, Montrose found himself in opposition to Argyll, who had made himself the representative of the Presbyterian and national party, and of the middle classes. Montrose, on the other hand, wished to bring the king's authority to bear upon parliament to defeat this object, and offered him the support of a great number of nobles. He failed, because Charles could not even then consent to abandon the bishops, and because no Scottish party of any weight could be formed unless Presbyterianism were established ecclesiastically.

Rather than give way, Charles prepared in 1640 to invade Scotland. Montrose was of necessity driven to play something of a double part. In August 1640 he signed the Bond of Cumberland as a protest against the "particular and direct practising of a few," in other words, against the ambition of Argyll. But he took his place amongst the defenders of his country, and in the same month he displayed his gallantry in action at the forcing of the Tyne at Newburn. After the invasion had been crowned with success, Montrose still continued to cherish his now hopeless policy. On the 27th of May 1641 he was summoned before the Committee of Estates charged with intrigues against Argyll, and on the 11th of June he was imprisoned in Edinburgh Castle. When Charles visited Scotland to give his formal assent to the abolition of Episcopacy, Montrose communicated to him his belief that Hamilton was a traitor. It had indeed been alleged, on Clarendon's authority, that he proposed to murder Hamilton and Argyll; but this is in all probability only one of Clarendon's many blunders. (See S. R. Gardiner, *Hist. of England, 1603-1642*, x. 26). Upon the king's return to England Montrose shared in the amnesty which was tacitly accorded to all Charles's partisans.

For a time Montrose retired, perforce, from public life. After the Civil War began in England (see GREAT REBELLION) he

constantly pressed Charles to allow him to make a diversion in Scotland. Hamilton's impracticable policy of keeping Scotland neutral for long stood in the way of Charles's consent. But in 1644, when a Scottish army entered England to take part against the king, Montrose, now created a marquess, was at last allowed to try what he could do. He set out to invade Scotland with about 1000 men. But his followers deserted, and his condition appeared hopeless. Disguised as a groom, he started on the 18th of August with only two gentlemen to make his way to the Highlands. Highlanders had never before been known to combine together, but Montrose knew that most of the clans detested Argyle, and the clans rallied to his summons. About 2000 disciplined Irish soldiers had crossed the sea to assist him. In two campaigns, distinguished by rapidity of movement, he met and defeated his opponents in six battles. At Tippermuir and Aberdeen he routed Covenanted levies; at Inverloch he crushed the Campbells, at Auldearn, Alford and Kilsyth his victories were obtained over well-led and disciplined armies. At Dundee he extricated his army from the greatest peril, and actually called his men off from the sack that had begun—a feat beyond the power of any other general in Europe. The fiery enthusiasm of the Gordons and other clans often carried the day, but Montrose relied more upon the disciplined infantry which had followed Alastair Macdonald from Ireland. His strategy at Dundee and Inverloch, his tactics at Aberdeen, Auldearn and Kilsyth furnished models of the military art, but above all his daring and constancy marked him out as the greatest soldier of the war, Cromwell alone excepted. His career of victory was crowned by the great battle of Kilsyth (Aug. 15, 1645). Now Montrose found himself apparently master of Scotland. In the name of the king, who now appointed him lord-lieutenant and captain-general of Scotland, he summoned a parliament to meet at Glasgow on the 20th of October, in which he no doubt hoped to reconcile loyal obedience to the king with the establishment of a non-political Presbyterian clergy. That parliament never met. Charles had been defeated at Naseby on the 14th of June, and Montrose must come to his help if there was to be still a king to proclaim. David Leslie, the best of the Scottish generals, was promptly despatched against Montrose to anticipate the invasion. On the 12th of September he came upon Montrose, deserted by his Highlanders and guarded only by a little group of followers, at Philiphaugh. He won an easy victory. Montrose cut his way through to the Highlands; but he failed to organize an army. In September 1646 he embarked for Norway.

Montrose was to appear once more on the stage of Scottish history. In June 1649, burning to revenge the death of the king, he was restored by the exile Charles II. to the now nominal lieutenancy of Scotland. Charles however did not scruple shortly afterwards to disavow his noblest supporter in order to become a king on terms dictated by Argyle and Argyle's adherents. In March 1650 Montrose landed in the Orkneys to take the command of a small force which he had sent on before him. Crossing to the mainland, he tried in vain to raise the clans, and on the 27th of April he was surprised and routed at Carbisdale in Ross-shire. After wandering for some time he was surrendered by Macleod of Assynt, to whose protection, in ignorance of Macleod's political enmity, he had entrusted himself. He was brought a prisoner to Edinburgh, and on the 20th of May sentenced to death by the parliament. He was hanged on the 21st, with Wishart's laudatory biography of him put round his neck. To the last he protested that he was a real Covenanter and a loyal subject.

The principal authorities for Montrose's career are Wishart's *Res gestae*, etc. (Amsterdam, 1647); Patrick Gordon's *Short Abridgement of Britane's Distemper* (Spalding Club); and the comprehensive work of Napier, *Memorials of Montrose*, is abundantly documented, containing Montrose's poetry, in which is included his celebrated lyric "My dear and only love."

MONTROSE, a royal, municipal, and police burgh and seaport of Forfarshire, Scotland. It is situated 30½ m. N.E. of Dundee by the North British railway and is also connected with the Caledonian railway company's system by a branch to Dubton. Pop. (1901), 12,427. The town occupies a considerable area on a

sandy peninsula, and is bounded on the E. by the North Sea, on the N. by the North Esk, on the S. by the South Esk, and on the W. by Montrose Basin, a large depression, about 7 m. in circuit. The reclamation of the Basin has been attempted, but an embankment constructed by Dutch diikers for this purpose was demolished in a few hours by a storm. In the mouth of the channel of the South Esk lies the island of Rossie, or Inchbrayock (pop. 160), which in 1829 was connected with the burgh by means of a suspension bridge 432 ft. long and by a drawbridge with the south bank near the fishing village of Ferryden (pop. 1330). The harbour lies between the suspension bridge and the sea, and is provided with a wet dock. The links form one of the best golf-courses in Scotland and are played over by several clubs. Besides the staple industry of flax-spinning, there are manufactures of linen, canvas, sheetings, starch, soap, chemicals, rope and manures, while iron-founding, tanning and brewing are also carried on. The fisheries are of very considerable importance and the shipping is usually brisk. There is a large trade, especially in timber (the chief import), mainly from Baltic ports and Canada. The parish church is a plain structure, but has a handsome steeple 200 ft. high. The principal buildings include the town-hall, the academy on the links, dating from 1820, though its predecessor belonged to the 16th century; the museum, Dorward's house of refuge, erected in 1839; the infirmary and the royal asylum at Sunnyside on the outskirts to the north-west. Panmure barracks are not far from the wet dock. In High Street are statues to Sir Robert Peel and Joseph Hume. Montrose is governed by a provost, bailies and council, and unites with Arbroath, Brechin, Forfar and Inverbervie (the Montrose burghs) in returning one member to parliament, a district group that was represented for many years by John Morley. Montrose received its charter from David I., and was made a royal burgh in 1352. It was destroyed by fire in 1244. Here Edward I. accepted John Baliol's surrender of the kingdom on the 10th of July 1296. Sir James Douglas sailed from the port in 1330 bound for the Holy Land with the heart of Robert Bruce; and here, too, the Old Pretender embarked in 1716 for France after the failure of his cause. In 1745 the town threw in its lot with the Hanoverians, a fact which lent zest to the daring capture of the "Hazard" sloop of war off Ferryden, by Captain David Ferrier of Brechin, a thorough-going Jacobite.

MONT ST MICHEL, a rocky islet of western France, off the coast of the department of Manche, some 6 m. N. of Pontorson. Pop. (1906), 238. It forms a towering mass of granite about 3000 ft. in circumference and 165 ft. in height, rising near the mouth of the Couesnon nearly a mile from the shore, to which it is united by a causeway. The fortress-abbey to which Mont St Michel owes its fame stands upon the more precipitous side of the islet towards the north and west, the sloping portion towards the east and south being occupied by houses. A strong machicolated and turreted wall surrounds the rock, running along its base on the south, ascending half-way up the cliff on the north, on which side it stands close to the abbey wall, and again descending on the west. The northern and oldest portion of the ramparts dates from the 13th century; the single gateway by which they are pierced is on the south and is a good example of the military architecture of the 15th century. The single street of the island curves from the gateway up to the abbey, ending in flights of steps leading to the donjon or châtelet. It is bordered by old houses, among which is one built by Bertrand du Guesclin in 1366, and contains a parish church of the 15th century. The abbey itself consists of an assemblage of buildings in three stores upon massive foundations around the church, the most important portion, the Merveille, extending to the north. The floor of the church, built partly on the rock, partly upon foundations, and, at the east end, over a crypt, is on a level with the uppermost storey of the monastic buildings. To the north and below the apse lies the group of buildings known as the Belle-Chaise. It comprises the châtelet (15th century), a square entrance structure strengthened by flanking turrets and machicolation, the adjoining guard-room (13th century) with the salle

des officers above it, and behind all the Tour Perrine. The Merveille (1203-1264) consists of two continuous buildings of three storeys, that on the east containing, one above the other, the hospium (*aumônerie*), refectory and dormitory, that on the west the cellar, knights' hall (*salle des chevaliers*) and cloister. Of the apartments, all of the finest Gothic architecture, the chief are the refectory, divided down the centre by columns and lighted by large embrasured windows, and the knights' hall, a superb chamber, the vaulting of which is supported on three rows of cylindrical pillars. The cloister, one of the purest and most graceful works of the 13th century, is surrounded by double lines of slender columns carrying pointed arcades, between which delicate floral designs are carved. The exterior wall of the Merveille is of remarkable boldness; reaching a height of 108 ft., it is supported by twenty buttresses and pierced with a variety of openings. The church, which rises high above the buildings clustering round it, consists of transepts and four bays of the nave of Romanesque architecture and of a fine choir (1450-1521) in the Flamboyant Gothic style with a triforium surmounted by lofty windows. This choir replaced one which collapsed in 1431. In 1776 three of the seven bays of the nave were pulled down, and soon after the incongruous western front was added. The finest part of the exterior is the choir, which is ornamented with a profusion of carved pinnacles and balustrading. The central tower terminates in a Gothic spire surmounted by a gilded bronze statue of St Michael.

Mont St Michel was a sacred place from the earliest times. In the 8th century an oratory was established there by St Aubert, bishop of Avranches, in obedience to the commands of an apparition of St Michael. The place soon became a noted resort of pilgrims, not only from all parts of France, but also from Great Britain, Ireland and Italy. In 966 Richard I., duke of Normandy, founded in place of the oratory a Benedictine monastery, which in the succeeding century received a considerable share of the spoils of the conquest of England. In 1203 the monastery was burnt by the troops of Philip Augustus, who afterwards furnished large sums for its restoration (La Merveille). St Louis made a pilgrimage to Mont St Michel, and afterwards supplied funds which were spent on the fortifications. A garrison and military governor subordinate to the abbot were also installed. During the last thirty years of the Hundred Years' War the abbey offered a persistent resistance to the English. In 1469 Louis XI. instituted the Order of St Michel, which held its meetings in the *salle des chevaliers*. During the Wars of Religion, the Huguenots repeatedly made unsuccessful attempts to seize the fortress, which opened its gates to Henry IV. in 1595 after his abjuration. In 1622 the Benedictine monks of Mont St Michel were replaced by monks of the Congregation of St Maur. In the 18th and 19th centuries the abbey was used as a prison for political offenders, serving this purpose until 1863, when an extensive restoration, begun in 1838, was resumed. The building is the property of the Commission of Historical Monuments, which has carried on the work of restoration with great architectural and antiquarian ability.

MONTSERRAT, or **MONSERRAT**, a remarkable mountain and monastery in north-east Spain, 30 m. N.W. of Barcelona. The mountain is of grey conglomerate; its main axis trends from N.W.N.W. to E.S.E., and its circumference is about 18 m. The loftiest point is the Turó de San Jeronimo, also called Mirador and La Miranda (4070 ft.), which commands a view of the Pyrénées, and the Mediterranean Sea as far as the Balearic Islands. On the east the base of the Montserrat is washed by the river Llobregat. The Montserrat consists of jagged pinnacles and spires (*peñascos*) rising abruptly from the base of the mass, which is cloven by many ravines, and abounds with steep precipices. It is the *mons serratus* of the Romans, the *monte serrado* of the Spaniards, and is thus named either in allusion to its jagged appearance, like the teeth of a saw, or because it is split, as if seen by the vast fissure of the Valle Malo, which extends from north-west to east. This occurred, say the Spanish legends, at the time of the Crucifixion, when the rocks were rent. In medieval German legends, which located here the castle of the Holy Grail, the

mountain is called *Monslwaitsch*, a name analogous to the modern Catalan form *Montserrat* "sacred mountain." From Monistrol, a village on the north-east, with a station on the Barcelona-Lérida railway, the monastery can be reached either by the carriage road built in 1857, or by the mountain railway opened in 1892. The ascent is also frequently made by a bridle path from the village of Collbató, on the south-west, where there are some interesting caverns.

The monastery stands 2910 ft. above sea-level upon a narrow platform on the edge of the Valle Malo. It owes its existence to an image of the Virgin, said to have been carved by St Luke, and brought to Barcelona by St Peter in A.D. 30. When the Moors invaded the province in 717 the image was taken to Montserrat, where a Benedictine convent appears to have already existed, and hidden in a cave. In 880 Gondemar, bishop of Vich, was attracted to the cave by sweet sounds and smells, and there found the image, which he determined to take to Manresa. But at a certain spot on the mountain the image refused to proceed farther; there it was consequently deposited, and a chapel was erected to contain it. Round the chapel a nunnery was built, and in 976 this was enlarged and converted into a second Benedictine convent. The old monastery (*monasterio antiguo*) is chiefly in ruins. The cloisters, belfry and part of the church were Gothic of the 15th century. The church of the new monastery (*monasterio actual*) was built in Renaissance style under Philip II. (1560-1502); in 1811 it was partially burned, and in 1880 a Romanesque apse was added. New buildings for the monks were erected under Ferdinand VII. (1784-1833), but left partly unfinished. During the Napoleonic wars (1808-14) it was despoiled of the vast treasures which had accumulated during the middle ages. In 1835, as a result of the Carlist insurrection, the convent was deprived of its estates and the number of monks reduced to about twenty. The monks are largely occupied by the management of a school of sacred music. In 1874 the convent, which by a grant of Pope Benedict XIII. had been an independent abbey since 1410, was made subject to the bishops of Barcelona.

Nuestra Señora de Montserrat, Patrona de Cataluña ("Our Lady of Montserrat, Patron Saint of Catalonia"), is one of the most celebrated images in Spain, and her church is visited annually by more than 60,000 pilgrims. The image is small, black, and carved of wood, but possesses magnificent robes and jewels. In September 1881 it was solemnly crowned by Leo XIII., who sent a crown from Rome for that purpose. As the celebrity and sanctity of Montserrat increased, so did the number of devotees. Ignatius Loyola (1491-1556) laid his sword upon the altar of the Virgin, and, placing himself under her protection, started from Montserrat to begin his new life. Many eminent Spaniards, weary of the world, have retired to this monastery to end their days. Some preferred solitary hermitages perched among the rocks. Of these there were fifteen, eleven of which once formed a *via sacra*, ending at the summit of San Jeronimo. They were destroyed by the French, but the ruins of some remain. There are also caves in the mountain, some of which were formerly occupied by monks. The most celebrated of these are the cave of the Virgin, in which the *santa imagen* remained hidden until found by Gondemar, and the cave of Fray Juan Garin, a notorious sinner, who ended his days in the practice of revolting penances at Montserrat.

MONTSERRAT, an island in the British West Indies, one of the five presidencies in the colony of the Leeward Islands. Pop., mostly negroes (1001), 12,215. It lies 27 m. S.W. of Antigua, in 16° 45' N. and 62° 7' W.; is 11 m. long and 7 m. broad, and has a total area of 32½ sq. m. The island is a cluster of rugged volcanic peaks rising from the Caribbean Sea, their summits clothed with forests; the still active Soufrière (3000 ft.) in the south being the highest point. The average temperature is 81° F., the hottest weather being usually tempered by cool sea breezes; the rainfall averages 94 in. per annum. There is a plentiful supply of water, and the roads are macadamized and well drained. The principal products are sugar and raw and concentrated lime-juice. Minerals are also found. Montserrat has a local legislature of six members, nominated by the Crown, and sends representatives to the general legislative council of the colony. Education is compulsory, and the majority of the schools are managed by the Church of England, to which most of the islanders belong; but the Wesleyans and the Roman

Catholics also support schools. Plymouth (pop. 1461), the chief town, stands on an open roadstead on the south-west coast.

The island was discovered by Columbus in 1493, who named it after Monserrado, a mountain in Spain. It was colonized by the British under Sir Thomas Warner in 1632, and was taken by the French in 1664. Restored to the British in 1668, it capitulated to the French in 1782, but was again restored in 1784.

MONTT, MANUEL (1809–1880), Chilean statesman, was born on the 5th of September 1809. He had a distinguished career as a scholar, and was introduced into public life during the presidency (1831–1841) of Arieto by Diego Portales. Montt distinguished himself by his courage in the crisis that followed upon Portales' assassination in 1837, though only holding a subordinate post in the government, and afterwards he held several ministerial offices, and during the presidency (1841–1851) of Bulnes he became minister of justice and public instruction, and later of the interior. He was elected president in 1851 and again in 1856, and though the Liberals chafed under his rule, and two revolutions, in 1851 and 1859, took place during his administration, he governed Chile with an energy and wisdom that laid the foundation of her material prosperity. He was ably assisted by his minister of the interior Antonio Varas, and it was from the union of the two statesmen that the well-known ultra-conservative faction, the Montt-Varistas, took their name. His presidency was marked by the establishment of railways, telegraphs, banks, schools and training-colleges. On giving up his post in 1861 he became president of the Supreme Court of Justice, a position which he held up to his death on the 20th of September 1880. His son Jorge (b. 1846) was president of Chile in 1891–1896, and a younger son, Pedro (d. 1910), in 1906–1910.

See P. B. Figueroa, *Diccionario biografico de Chile, 1550–1887* (Santiago, 1888); and J. B. Suarez, *Rasgos biograficos de hombres notables de Chile* (Valparaiso, 1886).

MONTUCLA, JEAN ÉTIENNE (1725–1799), French mathematician, was born at Lyons on the 5th of September 1725. In 1754 he published an anonymous treatise entitled *Histoire des recherches sur la quadrature du cercle*, and in 1758 the first part of his great work, *Histoire des mathématiques*, the first history of mathematics worthy of the name. He was appointed intendant-secretary of Grenoble in 1758, secretary to the expedition for colonizing Cayenne in 1764, and "premier commis des bâtiments" and censor-royal for mathematical books in 1765. The Revolution deprived him of his income and left him in great destitution. The offer in 1795 of a mathematical chair in one of the schools of Paris was declined on account of his infirm health, and he was still in straitened circumstances in 1798, when he published a second edition of the first part of his *Histoire*. In 1778 he re-edited Jacques Ozanam's *Récréations mathématiques*, afterwards published in English by Charles Hutton (4 vols., London, 1803). He died on the 18th of December 1799. His *Histoire* was completed by J. J. Le F. de Lalande, and published at Paris in 1799–1802 (4 vols.).

MONTYON, ANTOINE JEAN BAPTISTE ROBERT AUGET, BARON DE (1733–1820), French philanthropist, was born in Paris on the 23rd of December 1733. His father was a *maître des comptes*; he was educated for the law, and became advocate at the Châtelet in 1755, master of requests to the council of state in 1760, and intendant successively of Auvergne, Provence and La Rochelle. He had repeatedly shown great independence of character, protesting against the accusation of Caradec de La Chalotais in 1766, and refusing in 1771 to suppress the local courts of justice in obedience to Maupeou. He was made a councillor of state in 1775 by the influence of Louis de Bourbon, duke of Penthièvre, and in 1780 he was attached to the court in the honorary office of chancellor to the comte d'Artois (afterwards Charles X.). He followed the princes into exile, and lived for some years in London. During the emigration period he spent large sums on the alleviation of the poverty of his fellow immigrants, returning to France only at the second restoration. Between 1780 and 1787 he had founded a series of prizes, the awards to be made by the French academy and the academies of science and medicine. These prizes fell into abeyance during

the revolutionary period, but were re-established in 1815. Montyon died on the 29th of December 1820, bequeathing 10,000 francs for the perpetual endowment of each of the following prizes: for the discovery of the means of rendering some mechanical process less dangerous to the workman; for the perfecting of any technical improvement in a mechanical process; for the book which during the year rendered the greatest service to humanity; the "prix de vertu" for the most courageous act on the part of a poor Frenchman—the awards being left as before to the learned academies. He also left 10,000 francs to each of the Parisian hospitals.

Montyon wrote a series of works, chiefly on political economy: *Éloge de Michel de l'hôpital* (Paris, 1777); *Recherches et considérations sur la population de la France* (1778), a share of which is attributed to his secretary, Moheau; *Rapport fait à Louis XVIII.* (Constance, 1796), in which he maintained in opposition to Calonne's *Tableau de l'Europe* that France had always possessed a constitution, which had, however, been violated by the kings of France; *L'état statistique du Tunkin* (1811); and *Particularités . . . sur les ministres des finances en France* (1812).

See Lacretelle, "Discours sur M. Montyon," in the *Recueil de l'académie* (1820–1820); Quéran, *La France littéraire*, vol. vi. (1834); and, further, F. Labour, *M. de Montyon d'après des documents inédits* (Paris, 1880); G. Dumoulin, *Montyon* (Paris, 1884); and especially L. Guimbaud, *Augé de Montyon* (1909).

MONUMENT (*lat. monumentum* or *monimentum*; from *monere*, to advise, bring to mind, remind; the German equivalent is *Denkmal*), literally that which serves to keep alive the memory of a person, an event, or a period. The word is thus applied to a column, statue, or building erected for that particular purpose, as "The Monument" (*i.e.* of the Great Fire) in London; to all the various memorials which man throughout the ages has raised over the buried dead, the barrows and cairns of prehistoric times, the representation of the living figure of the dead, brasses, busts, &c., or the varying forms, allegorical or otherwise, taken by the tombstones of the modern cemetery. In a wider sense "monument" is used of all survivals of a past age, in which sense it may include all the vestiges of prehistoric man, dolmens, menhirs, remains of lake-dwellings, stone-circles, and the like, buildings large and small, cities, castles, palaces, and examples of domestic architecture, which have any interest, historic or artistic, as well as movable artistic or archaeological treasures, which exist in private or public collections, or which are discovered by excavation, &c. In a more restricted sense the word "monument" is also applied to a comprehensive treatise on any particular subject—such as the *Monumenta typographica*, or an historical collection such as the *Monumenta Germaniae historica*. In the English law of conveyancing a "monument" is an object fixed in the soil, whether natural or artificial, and referred to in a document, and used as evidence for the delineation of boundaries or the situation of a particular plot of land, &c.

For a description of various kinds of monuments see such articles as ARCHAEOLOGY; STONE MONUMENTS; EFFIGIES, MONUMENTAL; BRASSES; SCULPTURE; many particular monuments, such as Stonehenge, are treated under their respective names, or in the articles on the towns, &c., in which they stand.

The present article deals with the preservation, by government action, local or central, of the evidences and remains of past history and civilization, and, incidentally, with similar action extended to sites and places of natural beauty and interest, which the Germans call *Naturdenkmäler*, natural monuments. The important work of G. Baldwin Brown, *The Care of Ancient Monuments*, published in 1905, is practically the only book in English on this subject. It contains a most ample bibliography for each country and gives many references to various periodicals in different languages. In 1897 was issued a report (C. 8443, *Miscell. Reports*, 2) from British representatives abroad as to "the statutory provisions existing in foreign countries for the preservation of historical buildings." Reference also should be made to *The Care of Natural Monuments* (1909), by H. Conwentz, Prussian State Commissioner for the Care of Natural Monuments.

The chief question at issue is, how far does the national

artistic or historic interest of a monument, in the widest sense of the word, justify the interference of the state with the right of a private owner, whether corporate body or individual, to do what he likes with his own? Nearly every European country other than the United Kingdom has given a decided answer to this question. It may be noticed, as showing the extreme reluctance to state interference in the United Kingdom, that a clause, laying on an owner of a monument, scheduled under the Monument Act 1882, the obligation of offering it for purchase to the state if he wished to destroy it, was struck out of that act.

The main lines followed by legislation or regulation for the preservation of monuments may be briefly indicated. Central organizations of commissions and conservators, with a staff of architects, inspectors, and archaeological or artistic experts for consultation, are established. These may have large legal powers of enforcing their decisions, or may act chiefly by advice or persuasion. The national treasures are catalogued and scheduled, and the value estimated in an exhaustive inventory, in many cases supplemented by local inventories. In many cases, unfortunately, a valuable monument has been destroyed through ignorance of its value. A special form of inventory, carrying with it legal consequences, is that known as the *classement* system; of this form the French is the typical example. In this only the outstanding monuments find a place, and such either become national property altogether, or the protection and preservation is undertaken by the state, or may be left in the hands of the private owner; but in any case the monument cannot be destroyed, restored or repaired without the consent of the central authority. The *classement* system has been criticized as tending to depreciate the consideration paid to such monuments as do not appear in the list—*monuments non-classes*. The British Monument Acts adopt a narrow kind of *classement* in the schedule attached to the 1882 act. Most states have powers of expropriation or compulsory purchase of private property on grounds of *public utility*, and English law is no exception—as in the case of the compulsory purchase of land for railways. The majority of states have made the protection of monuments such a matter of public utility. Further, the exportation of artistic or historic treasures, *i.e.* movable monuments, has been controlled by the state, notably in the case of Italy and Greece, Turkey and Egypt. Connected with this side of the question is the control by the state of excavations undertaken by private persons, even on their own property. In Germany considerable protection is effected by the powers given to municipalities to make by-laws, respecting not only the preservation of the monuments, but also the erection of new buildings that may interfere with the monuments or with the general characteristic appearance (*Stadtbild*) of the town. This is also the case in Italy, where there are frequent regulations as to town-planning (*piano regolamento*).

The following is a brief account of the measures adopted in the principal countries of the world for the preservation and protection of their artistic and historic treasures.

United Kingdom.—There are four acts: the Ancient Monuments Protection Acts of 1882, 1900 and 1910, and the Ancient Monuments Protection (Ireland) Act 1892. The act of 1882, due primarily to Lord Avebury, then Sir John Lubbock, provided that a list of monuments¹ in Great Britain and Ireland should be made to which the act was to apply; the number of these monuments was sixty-eight, all being of the kind known as prehistoric (barrows, stone-circles, dolmens, &c.). An owner of one of these scheduled monuments may by deed place it in the guardianship of the commissioners of works, who are then responsible for its preservation and can protect it even against the owner. The commissioners may purchase any of the scheduled monuments, but only by agreement, the compulsory clauses of the Lands Clauses Consolidation Act being expressly excluded, though any purchase is to be made under those acts. An owner of any monument other

than those scheduled may place it in the care of the commissioners. The funds for the working of the act are to be provided by parliament, and an inspector of ancient monuments was appointed. General Pitt-Rivers, the first inspector appointed, found that without compulsory powers the act was useless, and for many years did not draw his official salary. After his death in 1900 the office was left unfilled until 1910. The act of 1892 applied to Ireland only, and is supplementary to that of 1882, which applied to the whole of the United Kingdom. The Irish act gave to the commissioners of public works in Ireland powers—only to be exercised with the consent of the owner—of applying the act of 1882 to any monument possessing such public interest as might render it worthy of preservation. It is to be noticed that after the disestablishment of the Irish Church certain unused churches of artistic or historic interest were placed in the charge of the commissioners as national monuments, with a sum of £50,000 to defray expenses. The Irish commissioners have therefore monuments in their care other than those scheduled in the acts, and may apply towards the expenses of the preservation of the scheduled monuments any surplus over from the fund above mentioned. The act of 1900 applied the Irish act to Great Britain, but the powers have not been exercised by the first commissioner of works. The act also gave the powers of the act of 1892 to county councils, allowed the authorities, local or central, to make arrangements for the preservation of monuments with owners or others, including societies, and to receive subscriptions for the same object, and also provided for public access to such monuments as are in the guardianship of the commissioners under the act. The acts of 1892 and 1900, though allowing buildings of historic or other interest to be placed under the care of the commissioners, exclude buildings occupied as a dwelling-place by any person other than a caretaker and his family. The act of 1910 gives to the commissioners of works power to acquire by *bequest* buildings of historic or architectural interest. The act of 1900 had given power to acquire such by gift or purchase, and the act of 1882 had given power by bequest also, but only referred to prehistoric remains. The London County Council possesses powers of purchasing by agreement any building of historic or other interest under a General Powers Act of 1898, and exercised these in 1900 by purchasing a 17th century house in Fleet Street (known as Cardinal Wolsey's palace). It will be seen that the United Kingdom possesses no official commission, no conservators, no consultative official body, and no compulsory powers of expropriation. The acts dealing with the subject are entirely permissive. Towards the making of a national inventory the first step taken was the appointment in 1908 of three royal commissions, for England, Scotland and Wales respectively, "to make an inventory of the ancient and historical monuments and constructions connected with or illustrative of the contemporary culture, civilization and conditions of life of the people from the earliest times": to the year 1700 in the case of England; 1707 in that of Scotland; for Wales no date is specified; and "to specify those which seem worthy of preservation." The Housing, Town Planning, &c. Act 1909, §45, and the Development and Road Improvement Funds Act, 1909, excepts the sites of ancient monuments or of other objects of historical interest from compulsory acquisition for the purposes of those acts. The Finance Act 1896, §20, granted a qualified exemption from estate duty to pictures, prints, books, MSS., works of art, scientific collections and other things not yielding income, as appear to the Treasury to be of national, scientific or historic interest; this exemption only extends where such property is settled to be enjoyed in kind in succession by different persons; if the property is sold or is in the possession of a person competent to dispose of it, it becomes liable to estate duty. The Finance Act 1909 extends the exemption to legacy and succession duty, removes the restriction to settled property, and adds "artistic" to "national and historic interest."

The Committee for the Survey of the Memorials of Greater London, supported by the London County Council, has begun a complete register and survey of the historic buildings of London. Apart from the numerous national and archaeological

¹The names of the monuments so scheduled are given in an appendix to Sir R. Hunter's *Lecture on the Preservation of Places of Interest and Beauty* (1907).

societies, whose proceedings contain invaluable accounts of practically every monument of interest throughout the kingdom, there are two societies directly formed with the object of monument preservation in its widest sense, the Society for the Protection of Ancient Buildings, founded in 1877, and the National Trust for Places of Historic Interest and Natural Beauty, constituted in 1894 under the Joint Stock Companies Acts for the purchase and preservation of sites and buildings, which it can hold in perpetuity for the benefit of the public. In 1907 the latter was dissolved and re-incorporated as a statutory body by the National Trust Act 1907. It possesses twenty-eight properties, amounting to 2000 acres, and twelve interesting buildings.

India.—The Archaeological Survey of Upper India was established in 1862, with a director-general at its head, and surveys for other parts of India were also begun later. The chief object of these was the making of an inventory, and the preservation of the monuments was neglected. In 1878 a curator of ancient monuments was appointed. A period of activity with regard to monument preservation set in during the viceroyalty of Lord Curzon; this culminated in the Ancient Monuments Preservation Act of 1904. The main provisions are as follows: The local government of any province may declare any monument to be a "protected monument within the meaning of the act," and when so declared no one may injure, remove or alter it under penalty of a fine or imprisonment. This, however, does not apply to the owner, except when the government has, by purchase or gift, or by taking over the guardianship of the monument, assumed the duty of preserving it. This assumption of guardianship is by agreement with the owner. Power of expropriation under the Land Acquisition Act 1894 is given if a monument protected under the act is threatened with destruction or injury, or if an owner refuse to come to an agreement with the authority for its guardianship. The act includes movable antiquities, and the governor-general in council can prohibit their exportation. Control over excavations is also given.

Egypt.—A Commission of Egyptology (*Comité permanent d'égyptologie*) has the care of the monuments of early Egyptian civilization. The monuments of the Arab occupation are in the charge of a separate commission (*Comité de conservation des monuments de l'art arabe*). The Commission of Egyptology acts under khedival decrees of 1883, 1897 and 1891. By the first the state claims control over all antiquities and declares the contents of the Giza (Gizeh) Museum, now the National Museum of Egyptian Antiquities, and of any future collection, to be the property of the state and inalienable. The second decree penalizes any injury to monuments or attempt to appropriate a monument belonging to the state. The third deals with excavations; permission must be granted by the director-general of museums; objects discovered belong to the state and must go to the museum, but a part of the objects will be granted to the discoverer under special regulations, the government reserving the right to special objects with compensation for the expense of excavation.

France.—The *Commission des monuments historiques* was established in 1837. It is attached to and acts through the department of the minister of public instruction and of the fine arts, who is the president of the commission. There are thirty members, partly nominated by the minister out of names selected by the commission, partly *ex officio*, such as the directors of civil buildings and national palaces and of public worship. The buildings which these officials control are, however, not directly under the commission. The presence of a certain number of deputies on the commission secures its representation in the legislature. Upon the commission fall the following duties: (a) The *classement* or selection of the monuments of national interest, artistic, historic, or both, for the schedule of protected monuments. A particular portion of a building, such as a door, window, &c., may be alone protected. (b) The restoration and repair of the monuments so classed. (c) A general power of giving advice and watching the monuments of the country as a whole. The commission has the charge of the Musée Cluny, and

is also the centre for all inquiries, reports, &c. The official staff of the commission consists of four general inspectors, one of whom, since the Monument Act of 1887, has charge of the movable monuments, and of forty architects, who have a subordinate staff of inspectors of works. Since 1830 a sum has been voted yearly for the finances of the commission. The largest sum (£120,000) that has appeared in the budget was voted in 1896; there are, however, other sources of revenue available.

The Monument Act of 1887.—This, together with certain administrative decrees, gave legal powers to the commission, which it had hitherto lacked, or had only been able to enforce by a difficult process of expropriation if owners, whether private or public, of monuments *classés* objected to the work of the commission. If a monument *classé* belong to the state or is under the administration of a minister other than the minister of public instruction and fine arts, or if it belong to any public body, such as a department or commune in whose hands the churches mainly lie, the consent of these controlling bodies must be given, otherwise the decision is left to the *conseil d'état*. If the owner be a private person, his consent is also necessary to the *déassement*. If he refuses, the minister may expropriate the monument by compulsory purchase, which must have the consent of the *conseil d'état*. Once a monument has been *classé*, it cannot be destroyed even partially, and no repairs or other work can be effected upon it without the consent of the minister. An action, for damages only, lies against a person infringing the law in this respect. The act deals also with the *classement* and protection of movable objects of national interest, historic or artistic, but only if they belong to the state, when they cannot be alienated, or to public bodies, when the consent of the minister is required for repairs or alienation. The act does not affect movables belonging to private persons. Owing to the numerous thefts from churches, museums, and other places, which attracted particular attention in 1907, proposals have been made for the better protection of such objects, as well as of those in private collections, by gathering together the objects at present scattered in churches, &c., into provincial and local museums, and also by charging an entrance fee for museums, &c. With regard to the discovery of monuments by excavation works or accident, the minister must receive immediate notice from the mayor of the commune through the prefect of the department, and will decide what is to be done. If such discovery is on private property he may proceed to expropriation. The act applies to Algeria. Here all objects of archaeological or artistic interest are reserved to the state, if on ground belonging to the government or granted by it to public bodies or private persons or in military occupation. The act is similarly extended to all French protectorates. Tunis has more stringent regulations; for by a decree of the bey, 1886, the consent of the owner to the *déassement* of a monument is not required, and penalties under the French penal code attach to infringements.

There is a strong feeling in France as to the protection and preservation of sites of natural beauty. A *Société pour la protection des paysages* was founded in 1901, and in 1904 the minister of public works issued a circular to the government engineers emphasizing the obligation of preserving and, if possible, enhancing the natural beauties of any locality in which public works were being carried out. An act (*Loi organisant la protection des sites et monuments naturels de caractère artistique*) was adopted in 1906, extending a protection to such sites analogous to that under the Monument Act (Appendix B in Sir R. Hunter's *Lecture*, already cited, gives the regulations under this measure).

A law of 1910 prohibits the affixing of bills or advertisements on monuments and sites officially recognized as historical and in sites recognized as picturesque by the law of 1906. The prefect also fixes a zone near such sites or monuments within which advertisement is prohibited.

Societies, both national and local, are numerous and active in France, but the centralizing policy does not favour any close working with the commission. The most important are the *Société nationale des antiquaires de France*, founded in 1804, and the *Société française d'archéologie pour la conservation et*

description des monuments historiques, founded in 1834, by the archaeologist Arctisse de Caumont (1802-1873). Its publication, the *Bulletin monumental*, is extremely valuable. In 1887 was founded the *Comité des monuments français*, which confines itself more particularly to the practical side of monument preservation and protection, and publishes an illustrated periodical, *L'Ami des monuments*. Of the numerous local societies the semi-official *Commission du vieux Paris* and the private *Société des amis des monuments parisiens* and the *Commission municipale du vieux Lyon* may be mentioned.

Germany.—Legislation and administration with regard to monuments and their protection are not imperial, but are matters for the various states. Of these Hesse-Darmstadt alone has a Monument Act (1902), but in nearly all the states the system adopted for monument preservation and protection has been the appointment of conservators (*Denkmalpfleger*), with commissions attached, and a careful system of inventory. There are also in many of the states decrees and administrative orders. In Prussia provincial conservators and commissions, appointed in 1801, assist the central conservator. The general absence of special legislation leaves private owners of monuments amenable only to advice and persuasion and to the pressure of public opinion. The official and legal control exercised by the conservators and commissions is restricted to those monuments which belong to the state. The wide powers, however, given to local and municipal authorities in Germany, enable much to be done without state legislation. Many towns have powers to make by-laws regulating building and street-planning with a view not only of the preservation of the actual monuments but also of what is known as *Stadtbild*, the characteristic appearance given to a town by its ancient buildings, walls, gateways, &c. The regulations of many of the Bavarian towns are excellent examples of what can be done in this way.

The final control of the monuments of Hesse-Darmstadt is in the hands of the minister of the interior, who presides over a *Denkmalrat*, or council on monuments, consisting of owners of historical monuments, members of societies interested in such objects, and representatives of the Catholic and Protestant Churches. There is also a general conservator. The act protects *Naturdenkmäler*, such as water-courses, rocks, and even trees. No excavations can be carried on without permission, and all finds must be reported to the local authority.

The principal German society is the *Gesamtverein der deutschen Geschichts- und Altertumsvereine*, founded in 1852. This is a general association of all the various societies throughout Germany. There are also many societies in the various towns, as well as local associations more directly concerned with the practical protection and preservation of monuments. The chief periodical—perhaps the most important of any dealing with the subject in Europe—is *Die Denkmalpflege*, published first in 1890. It is connected with the society known as *Heimatschutz*, the "defence of home."

Italy.—There is a long history of monument regulation, dating back to a provision against the destruction of monuments in the statutes of the city of Rome of the 14th century and to the appointment of Raphael by Leo X. as controller of the city's monuments. Throughout the various states of Italy during the 17th, 18th and 19th centuries till the unification of the kingdom, stringent regulations by decree or statute were in force to preserve the relics of the past in which the country is so peculiarly rich. Mariotti (*La Legislazione delle belle arti*, 1892) gives a full account of many of these regulations. It must suffice here to mention the Doria Pamphili Edict of 1802 and the Pacca Edict of 1820, named after the two Cardinal-Camerlenghi subscribing the same. It was not until 1902 that an act was passed for the whole of Italy. This act, with a supplementary act of 1903, and the code of regulations (*Regolamento*) of 1904, has been superseded by the acts of 1907 and 1909 and the *Regolamento* of 1910, which constitute the whole body of the provisions in force for the protection of monuments. The minister of public instruction is the final authority, and under him the director-general of antiquities and fine arts.

The Superior Council of Antiquities and Fine Arts, created by the law of 1907, consists of 21 members; it is divided into three sections of 7 members each for antiquities, medieval and modern art, and contemporary art respectively. All the members of each are nominated by royal decree, and so are three members of the third, being elected, one by the architects, one by the sculptors, and one by the painters of Italy. This is an advisory body. The minister presides, and the director-general can be present and has a vote. The administrative organization under the director-general consists of the divisional superintendencies (each having a group of provinces under it) divided into three categories: (a) 18 superintendencies of monuments (preservation, administration, and surveillance of monuments even in private hands); (b) 14 superintendencies of archaeological excavations and museums (with control of objects in private hands and of the offices for exportation); (c) 15 superintendencies of galleries, medieval and modern museums and objects of art. Under each superintendent is a staff of directors of monuments, museums and galleries, of inspectors, architects, secretaries, custodians, &c. The nominations to the superior grades are by competition. There are offices for the examination of objects before exportation in those towns in which there reside a superintendent of monuments or a director of a gallery or a museum in which it is necessary. The official organizations are assisted by (a) honorary inspectors, nominated by royal decree in any commune or *circondario* where it may seem advisable; (b) provincial commissions, meeting in the chief town of each province, composed of not less than 7 members, nominated by royal decree, and including of right the superintendents, and meeting normally twice a year.

The monuments within the purview of the act of 1909 and its administration comprise all movable (including MSS., incunabula, rare engravings and coins) and immovable objects of historical, archaeological, palaeo-ethnological or artistic value and interest, so long as they are not less than fifty years old nor the work of living persons. Such objects, if they belong to the state, a province, a commune, a religious corporation or any recognized corporation (*ente morale*), cannot be parted with at all, except as from one such body to another, and this only with the leave of the ministry; and the authorities of such bodies must present to the ministry an inventory of such objects. Nor may repairs or alterations be made to them without the consent of the ministry, which has the right to interfere by regulations (such as, e.g., the prohibition of the use of tapers, &c., which are liable to damage a picture) for the preservation and restoration (and in extreme cases even the removal) of such objects, if necessary, the latter being at the expense of the body to which they belong in so far as it can afford it. Any private person owning or possessing any object falling under the law, the importance and interest of which has been notified to him as the regulations provide, cannot transfer his property in or abandon his possession of it without informing the ministry, which has the right of pre-emption within two months (or four in case of financial pressure owing to many simultaneous offers) at the price for which he has contracted to sell it; and, if it is subject to damage and the proprietor will not provide for its repair, it may be expropriated by the state, by a province or commune—or even by bodies which have legal personality and aim at the preservation of such objects for the public enjoyment. It has not yet been possible, however, to secure the right of search nor of public access; so long as an object is well kept up by the owner, he may refuse the right of access except to the officials.

The exportation of objects of importance is forbidden, even if their importance has not been notified to the owner, who is under the obligation to advise the government of his intention to export, it having the right of pre-emption within two or four months, as the case may be; and even if the government does not purchase the object, it may still return it to the proprietor, forbidding him to export it. The objects exported are subject to a progressive tax, with a maximum of 20%. Objects temporarily imported from foreign countries, and re-exported within five years, are not subject to tax. Temporary exportation, if

permitted, is allowed on deposit of the tax; and if objects of importance are allowed to be sent from one part of Italy to another (especially to the islands), this is done by the government at the owner's expense.

As to excavations, in every case application to excavate must be made to the minister, who has a general supervision over the work and may stop it temporarily or assume the conduct of it. The state can excavate on private ground, but pays compensation; and can expropriate ground on which it wishes to excavate or on which discoveries have been made, the "archaeological value" not being reckoned. As to finds, if the state conducts the excavation, the owner retains one-fourth of the value or of the objects discovered at the choice of the state, the rest belongs to the state. In other cases, and in the case of chance discoveries (notice of which must be given immediately), the state takes one-half, but if the excavation is conducted by foreign institutions or persons, then the discoveries must be given to a public museum, or if part is handed over to the finder, it must be kept in such a way as to be accessible to the Italian public. The ministry gives periodical reports of all work carried out by the authorities in the *Notizie degli Scavi* and the *Bollettino d'arte*, both of which appear every month. The funds at the disposal of the ministry for purchases include (a) a sum of £40,000 already invested, (b) the interest upon £100,000 rentes regularly paid in, (c) other sums from sales of publications, fines, &c.; (d) an annual credit voted in the budget (£12,000 in 1909-10), forming an account called the *monte di belle arti*.

The regulations issued in 1910 for the execution of the new law consist of some 200 articles in three divisions—one dealing with the artistic and historical patrimony of Italy and its internal administration, a second with the question of exportation, and the third with financial matters. (T. As.)

Greece.—The earliest regulations are those contained in the law of 1837, promulgated by royal decree. This has been replaced by the Monument Act of 1809, but the principles of the earlier law remain, and the later act still lays down "the most extensive claim that any state has ever put forward in the matter of monuments," viz. that "all objects of antiquity in Greece, as the productions of the ancestors of the Hellenic people, are regarded as the common national possession of all Hellenes." The department in charge of the administration of the act is that of the minister of religion and public instruction. There is a central commission working with local commissions and a body of conservators. The control of this executive is in the hands of the ephor-general of antiquities. The act protects medieval monuments as well as those of classical Greece. All immovable monuments are public property, but compensation is to be paid to private owners if such monuments are to be preserved. Movable antiquities, if worthy of preservation by the state, must be placed in public museums. If discovered on private property the owner receives half the value, and may keep those not removed to a museum; all, however, must be registered. Excavations can be made anywhere by the state, and permission for private work must be first obtained. Expropriation is allowed. The export of antiquities is strictly forbidden under severe penalties, and the infringement of the various provisions of the act can be punished by heavy fines or imprisonment.

Austria-Hungary.—There is no legislation for the empire as a whole. In Austria there is a central commission, established 1850, whose authority is regulated by rescripts of 1873 and 1899 of the minister of religion and education. It consists of twenty members selected from experts in history, art and archaeology; there is also a numerous body of conservators who have districts covering the country assigned to them. They have no executive powers, but report on all new works likely to injure monuments, make inventories, influence public opinion, and work with archaeological societies for the general protection of ancient monuments. Hungary, on the other hand, has a Monument Act of 1881. With regard to any existing monument, the minister of religion and education decides whether it is worth preserving. Then the owner, whether

public or private, must preserve it at his own cost. If that is impossible the minister may expropriate it. Compulsory purchase may also be resorted to for the purpose of excavation.

Belgium.—There is no monument legislation, but there is a royal commission, resembling that of Austria, founded in 1835, and a royal decree of 1824 prevents alienation of objects of interest contained in churches or alienation or reconstruction of churches without state permission. An inventory has been in progress since 1861, and the commission publishes a *Bulletin*. By a communal law of 1836 local administrations have to submit proposals for the destruction or repair of monuments to the committee of the provincial council, and must obtain royal approval. Expropriation on the ground of public utility may be resorted to for the protection of a threatened monument in the hands of a private owner.

Holland.—A state commission (*Rijkscommissie*) was established in 1903, and began an inventory of all monuments, movable and immovable. Any proposed alteration or demolition of buildings of interest in a town must be reported by the burgomaster to the minister of the interior. The annual budget of the minister of the interior contains sums to be allotted for the repair of specified monuments.

Switzerland.—Legislation is in the hands of the cantons; Vaud, Neuchâtel and Bern have passed Monuments Acts, modelled on that of France. The federal government may allot an annual grant for the acquisition and upkeep of national monuments and for excavations. There is a federal commission, established in 1886, whose functions, mainly those of other countries, are exercised by the Swiss Society for the Preservation of Monuments of Historical Art.

The preservation of scenery and of natural monuments is considered a matter of great importance, and in 1905 was founded a Swiss society which has a branch in the United Kingdom, *La Ligue pour la conservation de la Suisse pittoresque*—*Die schweizerische Vereinigung für Heimatschutz*. The special object of the society is the prevention of the defacement of Alpine scenery by funicular and other railways, mountain-lifts, power-stations, &c. It was successful in protecting the falls of the Rhine at Schaffhausen from a Zurich electric-power scheme.

Denmark.—The means adopted are an excellent example of what can be done without legislation by appeals made by a central authority working with expert knowledge to an enlightened public opinion and to national sentiment. The authority consists of an inspector of ancient monuments and the directorate of the Museum of Northern Antiquities at Copenhagen, exercising the functions of a royal commission that was established in 1807 and dissolved in 1849. The successful preservation of antiquities is also due to an old law, modified by royal decrees of 1737 and 1752, by which all finds of gold, silver and precious objects belong to the state, and to a declaration of 1848 that all monuments on the Crown domains are national property and are to be specially reserved in case of sale. Many private owners have followed the example of the Crown. G. Baldwin Brown (*op. cit.* p. 188 seq.) gives some interesting examples of the success of the directorate of the museum in preserving monuments by appeals to ecclesiastical owners, projectors of railways and other works, and companies engaged in reclaiming land.

Sweden.—There is a state antiquary (*Riksantikvar*), appointed first by Gustavus Adolphus; the functions of a commission are exercised by the Royal Academy of Science, History and Antiquities, founded in 1786. There is an elaborate and stringent code of regulations protecting monuments, contained in royal decrees of 1867, 1873 and 1886. These are based on the edict of Charles XI. (1666), declaring all ancient monuments under royal protection. Sweden possesses one of the fullest inventories contained in the antiquarian topographical archives.

Norway.—Here there is also a state antiquary, and a state-subsidized society, *Foreningen til norske Fortidsmindesmaerkers Bevaring*, founded in 1844, which acts much as a commission, and advises the state official.

Russia.—The care of ancient monuments is in the charge

of the ministry of the imperial court, of which the Imperial Archaeological Commission, founded in 1850, is a department. The Imperial Academy of the Fine Arts is joined in this charge with the commission, whose duties resemble in the main those of the commissions of other countries. By a circular of 1901 a complete inventory of the monuments of the country was ordered to be made by the local authorities.

Spain.—A monument commission was established in 1844; it works under regulations issued in 1865. It is composed of the Royal Academies of Fine Arts and of History, corresponding members of which form commissions for the provinces of the kingdom. A complete inventory of all monuments is being made. The minister in charge is that of public instruction and of the fine arts.

Portugal.—A decree of John V. (1721) protected the monuments of ancient times; in 1840 this protection was extended to medieval monuments. An inventory was begun in 1841. A council of national monuments was established in 1901 by a royal decree, with a code of regulations. The French system of *classement* is adopted, and the regulations under the French act of 1887 are generally followed. The minister responsible is that of public works, commerce and industry.

Turkey.—The regulations, as embodied in an *irade* of 1884, are very stringent, and the principle adopted is that of Greece, that all objects of antiquity belong to the state. The private owner of such has no power of disposition, and must not injure nor destroy them. All excavations are under the control of the government, and permission must be first obtained. The exportation of finds is forbidden, and all movables discovered belong to the Imperial Museum. If these finds are the result of excavations, one-twentieth of the value goes to the discoverer; if of accidental discovery, the owner of the soil and the state divide.

United States.—With regard to the remains of prehistoric man, earthworks, barrows, &c., some of those states, such as Ohio, which are specially rich in such monuments, have particular laws protecting individual remains, e.g. the earthworks in Warren county. The state exercises control over other remains of interest, e.g. the Eagle earthworks in Licking county. There is also an archaeological and historical society, partly maintained by the state, with the object of the better preservation of the evidences of the prehistoric occupation. In North Dakota a state historical commission was created in 1895 "to collect and preserve the records and relics pertaining to the early history, settlement and development of North Dakota." The sites of the battle-fields, and statues, &c., erected in commemoration of the War of Independence or the Civil War, are preserved by various methods—by state or municipal regulations, by the action of incorporated bodies or trustees, &c. Most of the states rely on statutory prohibitions of malicious damage to protect their monuments and old buildings, &c. (C. WR.)

MONVEL (1745–1812), French actor and dramatic writer, whose real name was Jacques Marie Boutet, was born in Lunéville on the 25th of March 1745. He was a small, thin man without good looks or voice, and yet he became one of the greatest comedians of his time. After some years of apprenticeship in the provinces, he made his début in 1770 at the Comédie Française in *Méropé and Zénobie*; he was received *sociétaire* in 1772. For some reason unknown Monvel secretly left Paris for Sweden about 1781, and became reader to the king, a post which he held for several years. At the Revolution he returned to Paris, embraced its principles with ardour, and in 1791 joined the theatre in the rue Richelieu (the rival of the Comédie Française), which, under Talma, with Dugazon, his sister Mme Vestris, Grandmesnil (1737–1816) and Mme Desgarcins, was soon to become the Théâtre de la République. After the Revolution Monvel returned to the reconstituted Comédie Française with all his old companions, but retired in 1807. Monvel was made a member of the Institute in 1795. He wrote six plays (four of them performed at the Comédie Française), two comedies, and fifteen comic operas, seven with music by N. Dezède (1740–1792), eight by Nicolas d'Alayrac (1753–1809). He also

published an historical novel, *Frédérinde et Brunehaut* (1776). He was professor of elocution at the Conservatoire. Monvel's two daughters, Milles Mars *aînée* and *cadette*, were well-known actresses.

MONZA (locally *Monscia*), a city of Lombardy, Italy, in the province of Milan, 8 m. by rail N.N.E. of that city, with which it is also connected by both steam and electric trams. It lies on the Lambro, a tributary of the Po, 532 ft. above sea-level. Pop. (1906), 32,000 (town); 53,330 (commune). Of the medieval fortifications little remains save the Porta d'Agate. Near it is the nunnery in which the nun of Monza (see Manzoni's *Promessi sposi*) was enclosed. The cathedral of St John Baptist is the principal object of interest; Theodelinda's basilica of 590 was enlarged at the close of the 13th century by throwing the atrium into the main building, and the present fine black-and-white marble façade was erected about the middle of the 14th by Matteo da Campione, and restored in 1809–1901. On the left-hand side of the front rises an incongruous brick-built tower, 278 ft. high, erected by Pellegrini in 1592–1606. Within the church are the iron crown of Lombardy, supposed to have been beaten out of one of the nails used at the Crucifixion, and the treasury containing the relics of Theodelinda, comprising her crown, fan and comb of gold, and the golden hen and seven chickens, representing Lombardy and her seven provinces, and crosses, reliquaries, &c., of the Lombard and Gothic periods. The interior has been modernized; there is a fine relief by Matteo da Campione in the organ-loft, representing the coronation of a king, and some 15th-century frescoes with scenes from the life of Theodelinda. Next to the cathedral in artistic importance come the church of Santa Maria in Istrada, and the broletto or old palace of the commune, usually styled the Arengario; the former (founded in 1357) has a rich terra-cotta façade of 1303, and the latter is raised on a system of pointed arches, and has a tall square tower terminating in machicolations surrounding a sharp central cone. The royal palace of Monza (built in 1777 for the archduke Ferdinand) lies not far from the town on the banks of the Lambro. Cotton goods and felt hats are the staple products of the flourishing Monza industry; then dyeing, organ-building, and a publishing trade.

Monza (anc. *Modicia*) was not a place of consequence till it attracted the eye of Theodorici; and its first important associations are with Theodelinda. During the period of the republics Monza was sometimes independent, sometimes subject to Milan. The Visconti, who ultimately became masters of the city, built a castle in 1325 on the site now occupied by the Palazzo Durini. In the course of its history Monza stood thirty-two sieges, and was repeatedly plundered—notably by the forces of Charles V. The township (1499–1796) was purchased in 1546 by the wealthy banker Durini, and remained in his family till the Revolution. At Monza King Humbert was assassinated on the 20th of July 1900.

MONZONITE, the group-name of a type of rocks which have acquired it from their most celebrated occurrence, that of Monzoni in Tirol. The rocks are of granitic appearance, usually rather dark grey in colour and fine to moderately coarse grained. The special characteristic which distinguishes them from granites and ordinary syenites is the presence of plagioclase and orthoclase feldspars in nearly equal amounts. Labradorite, andesine and oligoclase are present, usually in well-shaped crystals, often zoned; orthoclase forms large irregular plates in which the other minerals are embedded. There is rarely any considerable amount of quartz, though in a few of these rocks this mineral occurs (the quartz-monzonites). Other features are the abundance of augite, pale green or brownish green, and of large bronze-coloured plates of biotite which are of quite irregular shapes and full of enclosures. Hypersthene or bronzite is less common, but dark brown and green hornblende are sometimes abundant. Olivine also may be present; when the rock contains this in notable quantity it may be called an olivine monzonite. Numerous large prisms of apatite often characterize micro-sections of monzonites, and zircon, iron ores and pyrites are frequent accessory minerals.

The monzonites of Tirol show a great variability in appearance, structure, and the relative proportions of their minerals. They tend to pass into rocks which have been called diabases and gabbros, and near the margins of the outcrop facies very rich in pyroxene (pyroxenites) occur. Many authors believe that this variety of types is associated with the fact that the monzonites occupy a middle place as regards their chemical composition between the acid and the basic igneous rocks, and that such a magma is naturally somewhat unstable, and likely to split up or differentiate into partial magmas of more siliceous and less siliceous character. The monzonites in fact approach rather closely to the calculated mean composition of the outer portion of the earth's crust and from a molten magma of this nature it is natural to suppose that all kinds of igneous rocks have been derived.

Rocks of monzonitic facies occur also in Norway, where they have been described as *akerites*. They contain quartz, orthoclase and plagioclase, augite and dark hornblende, hornblende and hypersthene also may be present. Some of them have porphyritic rather than granitic texture, especially near the margins of the localities. From a study of these and other occurrences Brogger proposed to define the monzonites as orthoclase-plagioclase rocks in which the two chief classes of felspar occur in nearly equal quantities (as distinguished from the orthoclase rocks or granites and syenites and the plagioclase rocks or diorites and gabbros).

At Yogo Peak and Beaver Creek in Montana, U.S.A., there are masses of granitoid rock which bear a close resemblance to the monzonites of Tirol. Two main types occur: (a) *yogite*, which differs little from monzonite, and (b) *shonkinite*, which is a more basic rock richer in plagioclase and augite; this rock contains olivine and in places passes into dark pyroxenites. In shonkinite also a little nepheline may be present. In several places in the west of Scotland (Argyllshire) intrusive bosses are known which consist of an olivine-bearing rock closely related to monzonite. It has been called *kentallinite* because it is quarried at Kentallen in Argyllshire. Large crystals of pale green augite and irregular plates of biotite which enclose idiomorphic plagioclase felspar are conspicuous in micro-sections of this rock, and the abundance of olivine is rather greater than is usual in the monzonites; it is associated with diorites of lamprophyric character and dark pyroxenites and peridotites.

The following analyses show the chemical peculiarities of the principal rocks of the monzonite group:—

	SiO ₂	Al ₂ O ₃	Fe ₂ O ₃	FeO	MgO	CaO	K ₂ O	Na ₂ O
Monzonite, Monzoni	54.20	15.73	3.67	5.40	3.40	8.50	4.42	3.07
Yogite, Yogo Peak	54.42	14.28	3.32	4.13	6.12	7.72	4.22	3.44
Kentallinite, Argyllshire	52.09	11.93	1.84	7.11	12.48	7.84	3.01	2.04

(J. S. F.)

MOOD. (1) (O. Eng. *mód*, a word common to Teutonic languages; cf. Ger. *Mut*; Du. *moed*, mind, courage), a particular state of mind or feeling. (2) (Adapted from Lat. *modus*, measure), a grammatical term for one of the various forms into which the conjugation is grouped, showing whether the verb is used as a predicate, a wish, a command, &c. In syllogistic logic the term is used of the various classes into which the "figures" of valid syllogisms are divided. (See SYLLOGISM.)

MOODKEE, or **MUDKI**, a town in the Ferozepore district of the Punjab, India. Pop. (1901), 2977. It is situated 26 m. S. of the Sutlej, on the old road from Ferozepore to Karnal, and is notable as the scene of the first battle (Dec. 18, 1845) in the first Sikh war. (See SIKH WARS.)

MOODY, DWIGHT LYMAN (RHYTER) (1837-1899), American evangelist, was born in the village of East Northfield (Northfield township), Massachusetts, on the 5th of February 1837. His father died in 1841, and young Dwight, a mischievous independent boy, got a scanty schooling. In 1854 he became a salesman in a shoe-store in Boston; in 1855 he was "converted"; and in 1856 he went to Chicago and started business there. Beginning with a class gathered from the streets, he opened (1858) a Sunday school in North Market Hall, which was organized in 1863 as the Illinois Street Church, and afterwards became the Chicago Avenue Church, of which he was layman pastor. In 1860 he gave up business and devoted himself to city missionary work. He was prominent in raising money for Farwell Hall in Chicago (1867), and in 1865-1869 was president of the Chicago Young Men's Christian Association. Ira David Sankey (1840-1908) joined him in Chicago in 1870 and helped him greatly by the singing of hymns; and in a series

of notable revival meetings in England (1873-1875, 1881-1884, 1891-1892) and America they carried on their gospel campaign, and became famous for the Moody and Sankey *Gospel Hymns*. In 1879 Moody opened the Northfield seminary for young women, at Northfield, Mass., and in 1881 the adjacent Mount Hermon school for boys; in each a liberal practical education centres about Bible training; the boys do farm-work and the girls house-work. In 1880 he opened in Chicago the Bible Institute, and there trained Christian workers in Bible study and in practical methods of social reform; at Northfield in 1890 he opened a Training School in domestic science in the Northfield Hotel, formerly used only in summer for visitors at the annual conferences, of which the best known are the Bible (or Christian Workers') Conference, first held at Northfield in 1880, and the Students' (or College Men's) Conference, first held in 1887.

Moody died at Northfield on the 22nd of December 1899. His sermons were colloquial, simple, full of conviction and point. In his theology he laid stress on the Gospel and on no sectarian opinions—he was, however, a pre-millenarianite—and he worked with men as much more "advanced" than himself as Henry Drummond, whom he eagerly defended against orthodox attack, and George Adam Smith. Moody's sermons were sold widely in English, and in German, Danish and Swedish versions.

See the (official) *Life of Dwight L. Moody* (New York, 1900), by his son, W. R. Moody (b. 1869), and the estimate in Henry Drummond's *Dwight L. Moody: Impressions and Facts* (New York, 1900), with an introduction by George Adam Smith.

MOOLVIE (an Urdu variant of Arabic *mawlavī*, a derivative of *mullah*, a man learned in the law), the name used in India of a man learned in Mahomedan law, and hence used generally of a teacher or as a complimentary title of one learned in any branch of knowledge.

MOON, SIR RICHARD, 1ST BARONET (1814-1899), English railway administrator, was the son of a Liverpool merchant, and was born on the 23rd of September 1814. The history of his life is practically the history of the London & North-Western railway for the period in which he lived. When he first became a member of the board in 1847, the company had just come into existence by the amalgamation of the London & Birmingham, the Manchester & Birmingham, and the Grand Junction lines, and it was during his long connexion with it—first as director and then (from 1862 to 1891) as chairman—that its system was developed substantially into what it is now. The Chester & Holyhead, the Lancaster & Carlisle, and many smaller lines were gradually added to it, either by leasing or by complete absorption, and finally in 1877 an act was obtained consolidating all into one homogeneous whole. Throughout his career, Sir Richard Moon's powers of organization and his genius for what may be called railway diplomacy were of the greatest advantage to the company, and to him it owed in very large measure its commanding position. An extremely hard worker himself, he expected equal diligence of his subordinates; but energy and capacity did not go unrewarded, for he made promotions, not by standing or seniority, but by merit. Sir Richard Moon, who was created a baronet in 1887, died at Coventry on the 17th of November 1899.

MOON (a common Teutonic word, cf. Ger. *Mond*, Du. *maan*, Dan. *maane*, &c., and cognate with such Indo-Germanic forms as Gr. *μήν*, Sans. *mās*, Irish *mí*, &c.; Lat. uses *luna*, i.e. *lucina*, the shining one, *lucere*, to shine, for the moon, but preserves the word in *mensis*, month; the ultimate root for "moon" and "month" is usually taken to be *me-*, to measure, the moon being a measurer of time), in astronomy, the name given to the satellite of any planet, specifically to the only satellite of the earth.

The subject of the moon may be treated as twofold, one branch being concerned with the aspects, phases and constitution of the moon; the other with the mathematical theory of its motion. As the varying phenomena presented by the moon grow out of its orbital motion, the general character of the latter will be set forth in advance.

A luminous idea of the geometrical relations of the moon,

earth and sun will be gained from the figure, by imagining the sun to be moved towards the left, and placed at a distance of 20 ft. from the position of the earth, as represented at the right-hand end of the figure. We have here eight positions of the moon, $M_1, M_2, \&c.$, as it moves round the earth E . The general average distance of the sun is somewhat less than four hundred times that of the moon. We have next to conceive that, as the earth performs its annual revolution round the sun in an orbit whose diameter, as represented on the diagram, is nearly 40 ft., it carries the orbit of the moon with it. Conceiving the plane of the earth's motion, which is that of the ecliptic, to be represented by the surface of the paper, the orbit of the moon makes a small angle of a little more than 5° with this plane. Conceiving the line NN' to be that of the nodes at any time, and the earth and lunar orbit to be moving in the direction of the straight arrows, the earth will be on one side of the ecliptic from M_2 to M_6 , and on the other side from M_6 to M_1 , intersecting it at the nodes. The absolute direction of the line of nodes changes but slowly as the earth and moon revolve; consequently, in the case shown in the figure, the line

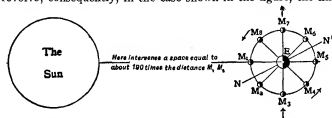

of nodes will pass through the sun after the earth has passed through an arc nearly equal to the angle M_1, N . Six months later the direction of the opposite node will pass through the sun. Actually, the line of nodes is in motion in a retrograde direction, the opposite of that of the arrows, by 19.3° per year, thus making a revolution in 18.6 years, or 6,793.39 days. (See ECLIPSE.)

The varying phases of the moon, due to the different aspects presented by an opaque globe illuminated by the sun, are too familiar to require explanation. We shall merely note some points which are frequently overlooked: (1) the crescent phase of the moon is shown only when the moon is less than 90° from the sun; (2) the bright convex outline of the crescent is then on the side toward the sun, and that the moon is seen full only when in opposition to the sun, and therefore rising about the time of sunset. In consequence of the orbital motion the moon rises, crosses the meridian, and sets, about 48 m. later every successive day. This excess is, however, subject to wide variation, owing to the obliquity of the ecliptic and of the lunar orbit to the equator, and therefore to the horizon. The smaller the angle which the orbit of the moon, when near the point of rising, makes with the horizon the less will be the retardation. Near the autumnal equinox this angle is at a minimum; hence the phenomenon of the "harvest moon," when for several successive days the difference of times of rising on one day and the next may be only from 15 to 20 minutes. Near the vernal equinox the case is reversed, the interval between two risings of the nearly full moon being at its maximum, and between two settings at its minimum. Generally, when the rising is accelerated the setting is retarded, and vice versa.

The moon always presents nearly the same face to the earth, from which it follows that, when referred to a fixed direction in space, it revolves on its axis in the same time in which it performs its revolution. Relatively to the direction of the earth there is really no rotation. The rate of actual rotation is substantially uniform, while the arc through which the moon moves from day to day varies. Consequently, the face which the moon presents to the earth is subject to a corresponding variation, the globe as we see it slightly oscillating in a period nearly that of revolution. This apparent oscillation is called *libration*, and its amount on each side of the mean is commonly between 6° and 7° . There is also a libration in latitude, arising from the fact that the axis of rotation of the moon is not

precisely perpendicular to the plane of her orbit. This libration is more regular than that in longitude, its amount being about $6^\circ 44'$ on each side of the mean. The other side of the moon is therefore invisible from the earth, but in consequence of the libration about six-tenths of the lunar surface may be seen at one time or another, while the remaining four-tenths are for ever hidden from our view.

It is found that the direction of the moon's equator remains nearly invariable with respect to the plane of the orbit, and therefore revolves with that plane in a nodal period of 18.6 years. This shows that the side of the moon presented to us is held in position as it were by the earth, from which it also follows that the lunar globe is more or less elliptical, the longer axis being directed toward the earth. The amount of the ellipticity is, however, very small.

Two phenomena presented by the moon are plain to the naked eye. One is the existence of dark and bright regions, irregular in form, on its surface; the other is the complete illumination of the lunar disk when seen as a crescent, a faint light revealing the dark hemisphere. This is due to the light falling from the sun on the earth and being reflected back to the moon. To an observer on the moon our earth would present a surface more than ten times as large as the moon presents to us, consequently this earth-light is more than ten times brighter than our moonlight, thus enabling the lunar surface to be seen by us.

The surface of the moon has been a subject of careful telescopic study from the time of Galileo. The early observers seem to have been under the impression that the dark regions might be oceans; but this impression must have been corrected as soon as the telescope began to be improved, when the whole visible surface was found to be rough and mountainous. The work of drawing up a detailed description of the lunar surface, and laying its features down on maps, has from time to time occupied telescopic observers. The earliest work of this kind, and one of the most elaborate, is the *Selenographia* of Hevelius, a magnificent folio volume. This contains the first complete map of the moon. Names borrowed from geography and classical mythology are assigned to the regions and features. A system was introduced by Riccioli in his *Almagestum novum* of designating the more conspicuous smaller features by the names of eminent astronomers and philosophers, while the great dark regions were designated as oceans, with quite fanciful names: *Mare imbrium*, *Oceanus proceliarum*, &c. More than a century elapsed from the time of Hevelius and Riccioli when J. H. Schröter of Lilienthal produced another profusely illustrated description of lunar topography.

The standard work on this subject during the 19th century was long the well-executed description and map of W. Beer and J. H. Mädler, published in 1836. It was the result of several years' careful study and micrometric measurement of the features shown by the moon. The volume of text gives descriptive details and measurement of the spots and heights of the mountains.

In recent times photography has been so successfully applied to the mapping of our satellites as nearly to supersede visual observation. The first photograph of the moon was a daguerreotype, made by Dr J. W. Draper of New York in 1840; but it was not possible to do much in this direction until the more sensitive process of photographing on glass was introduced instead of the daguerreotype. The taking of photographs of the moon then excited much interest among astronomical observers of various countries. Bond at the Harvard observatory, De la Rue in England, and Rutherford in New York, produced lunar photographs of remarkable accuracy and beauty. The fine atmosphere of the Lick observatory was well adapted to this work, and a complete photographic map of the moon on a large scale was prepared which exceeded in precision of detail any before produced. The most extended and elaborate work of this sort yet undertaken is that of Maurice Loewy (1833-1907) and Pierre Puiseux at the Paris observatory, of which the first part was published in 1895.

The broken and irregular character of the surface is most evident near the boundary between the dark and illuminated portions, about the time of first quarter. The most remarkable

feature of the surface comprises the craters, which are scattered everywhere, and generally surrounded by an approximately circular elevated ring. Yet another remarkable feature comprises bright streaks, branching out in various directions and through long distances from a few central points, especially that known as Tycho.

The height of the lunar mountains is a subject of interest. It cannot be stated with the same definiteness that we can assign heights to our terrestrial mountains, because there is no fixed sea-level on the moon to which elevations can be referred. The only determination that can be made on the moon is that of the height above some neighbouring hollow, crater or plain. The most detailed measures of this sort were made by Beer and Mädler, who give a great number of such heights. These generally range between 500 and 3000 toises, or 3000 and 20,000 English feet. The highest which they measured was Newton, 3727 toises, or 24,000 ft.

The general trend of lunar investigation has been against the view that there is any resemblance between the surfaces of the moon and of the earth, except in the general features already mentioned. No evidence has yet been found that the moon has either water or air. The former, if it existed at all, could be found only in the more depressed portions; and even here it would evaporate under the influence of the sun's rays, forming a vapour which, if it existed in considerable quantity, would in some way make itself known to our scrutiny. The most delicate indication of an atmosphere would be through the refraction of the light of a star when seen coincident with the limb of the moon. Not the slightest change in the direction of such a star when in this position has ever been detected, and it is certain that if any occurs it can be but a minute fraction of a second of arc. As an atmosphere equal to ours in density would produce a deviation of an important fraction of a degree, it may be said that the moon can have no atmosphere exceeding in density the $\frac{5}{80000}$ that of the earth.

Devoid of air and atmosphere, the causes of meteorological phenomena on the earth are non-existent on the moon. The only active cause of such changes is the varying temperature produced by the presence or absence of the sun's rays. The range of temperature must be vastly wider than on the earth, owing to the absence of an atmosphere to make it equable. Elaborate observations of the heat coming from the moon at its various phases were made and discussed in 1871-1872 by Lord Rosse. Among his results was that during the progressive phases from before the first quarter till the full moon the heat received increases in a much greater proportion than the light, from which it followed that the former was composed mainly of heat radiated from the moon itself in consequence of the temperature which it assumed under the sun's rays. So far as could be determined, 86% of the heat radiated was by the moon itself, and 14% reflected solar heat. But it seems probable that this disproportion may be somewhat too great. Rosse's determinations, like those of his predecessors, were made with the thermopile. After S. P. Langley devised his bolometer, which was a much more sensitive instrument than the thermopile, he, in conjunction with F. W. Very, applied it to determine the moon's radiation at the Allegheny observatory. His results for the ratio of the total radiation of the full moon to that of the sun ranged from 1 : 70,000 to 1 : 110,000, which were in substantial agreement with those of Rosse, who found 1 : 82,000. When Langley published his work the law of radiation as a function of the temperature was not yet established. He therefore wrongly concluded that the highest temperature reached by the moon approximated to the freezing-point of water. Stefan's law of radiation, on the other hand, shows that the temperature must have been about the boiling-point in order that the observed amount of heat might be radiated. This is in fair agreement with the computed temperature due to the sun's radiation upon a perpendicular absorbing surface when no temperature is lost through conduction to the interior. The agreement thus brought about between the results deduced from the law of radiation and the most delicate observa-

tions of the quantity of heat radiated is of great interest, as showing that the theory of cosmic temperature now rests upon a sound basis. There is, however, still room for improved determinations of the moon's heat by the use of the bolometer in its latest form.

Possibility of Changes on the Moon.—No evidence of life on the moon has ever been brought out by the minutest telescopic scrutiny, nor does life seem possible in the absence of air and water. Some bright spots are visible by the earth-light when the moon is a thin crescent, which were supposed by Herschel to be volcanoes in eruption. But these are now known to be nothing more than spots of unusual whiteness, and if any active volcano exists it is yet to be discovered. Still, the question whether everything on the moon's surface is absolutely unchangeable is as yet an open one, with the general trend of opinion toward the affirmative, so far as any actual proof from observation is concerned. The spot which has most frequently exhibited changes in appearance is near the centre of the visible disk, marked on Beer and Mädler's map as *Linne*. This has been found to present an aspect quite different from that depicted on the map, and one which varies at different times. But the question still remains open whether these variations may not be due wholly to the different phases of illumination by the sunlight as the latter strikes the region from various directions.

Intensity of Moonlight.—An interesting and important quantity is the ratio of moonlight to sunlight. This has been measured for the full moon by various investigators, but the results are not as accordant as could be desired. The most reliable determinations were made by G. P. Bond at Harvard and F. Zöllner at Leipzig, in 1860 and 1864. The mean result of these two determinations is the ratio 1 : 570,000. We may therefore say that the intensity of sunlight is somewhat more than half a million times that of full moonlight. A remarkable feature of the reflecting power of the moon, which was made known by Zöllner's observations, is that the proportion of light reflected by a region on the moon is much greater when the light falls perpendicularly, which is the case near the time of full moon, and rapidly becomes less as the light is more oblique. This result was traced by Zöllner to the general irregularity of the lunar surface, and the inference was drawn that the average slope of the lunar elevation amounts to 47°.

Motion of the Moon.—The orbit of the moon around the earth, though not a fixed curve of any class, is elliptical in form, and may be represented by an ellipse which is constantly changing its form and position, and has the earth in one of its foci. The eccentricity of the ellipse is in the general average about 0.055, whence the moon is commonly more than $\frac{1}{8}$ further from the earth at apogee than at perigee. The line of apsides is in continual motion, generally direct, and performs a revolution in about 12 years. The inclination to the ecliptic is a little more than 5°, and the line of nodes performs a revolution in the retrograde direction in 8.6 years. The parallax of the moon is determined by observation from two widely separated points; the most accurate measures are those made at Greenwich and at the Cape of Good Hope. The distance of the moon can also be computed from the law of gravity, the problem being to determine the distance at which a body having the moon's mass would revolve around the earth in the observed period. The measures of parallax agree perfectly with the computed distance in showing a mean parallax of 57' 2.8", and a mean distance of 238,800 miles. The period of revolution, or the lunar month, depends upon the point to which the revolution is referred. Any one of five such directions may be chosen, that of the sun, the fixed stars, the equinox, the perigee, or the node. The terms synodical, sidereal, tropical, anomalistic, nodical, are applied respectively to these months, of which the lengths are as follow:—

	Length.	Deviation from sidereal month.
Synodical month	29.53095 days.	+2.20893 days.
Sidereal month	27.32166 "	0.00000 "
Tropical month	27.32156 "	-0.00010 "
Anomalistic month	27.55460 "	+0.23294 "
Nodical month	27.21222 "	-0.10944 "

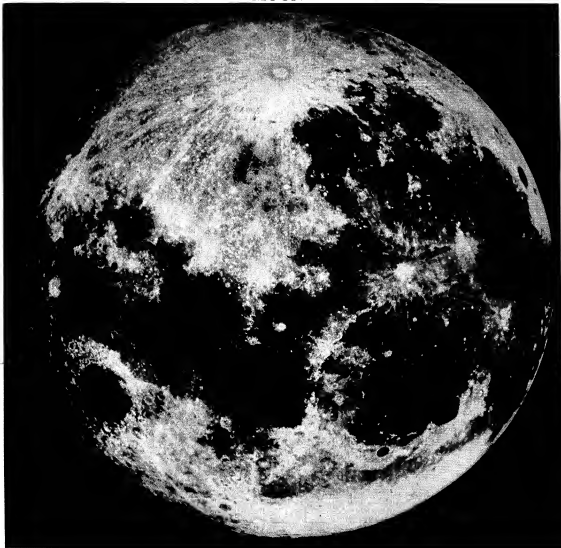

THE MOON (Age 14d. th.), 1890, October 27.

By permission of Lick Observatory.

- Maria or Seas.*
- A. Mare Crisium.
 - B. " Foecunditatis.
 - C. " Nectaris.
 - D. " Tranquillitatis.
 - E. " Serenitatis.
 - F. Lacus Somniorum.
 - G. " Mortis.
 - H. Mare Frigoris.
 - I. Sinus Roris.
 - K. Mare Imbrium.
 - L. Oceanus Procellarum.
 - M. Mare Vaporum.
 - N. " Humorum.
 - O. " Nubium.

- Mountains.*
- (a) Caucasus.
 - (b) Apennines.
 - (c) Alps.
 - (d) Carpathians.

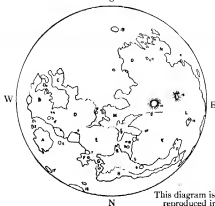
*Volcanoes.*

- 1. Apollonius.
- 2. Firmicus.
- 3. Tarantius.
- 4. Secchi.
- 5. Macrobius.
- 6. Vitruvius.
- 7. Posidonius.
- 8. Plato.
- 9. Aristillus.
- 10. Autolyeus.
- 11. Archimedes.
- 12. Julius Caesar.
- 13. Boscovich.
- 14. Copernicus.
- 15. Herodotus.
- 16. Kepler.
- 17. Borda.
- 18. Bohnenberger.
- 19. Tycho.

This diagram is a key to some of the features reproduced in the photograph.

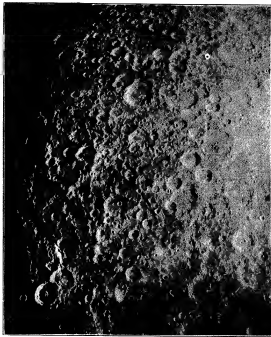

1. TYCHO, THEOPHILUS, 1900, October 12.

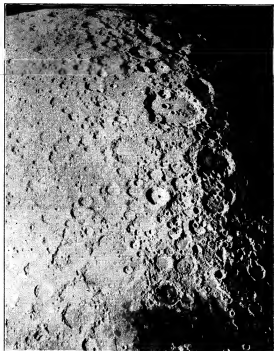

2. MARE NUBIUM, &c., 1901, November 21.

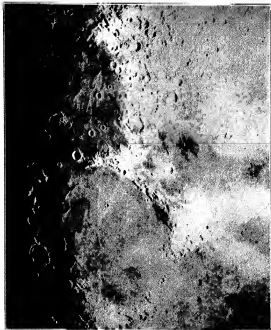

3. MARE SERENITATIS, 1901, August 3.

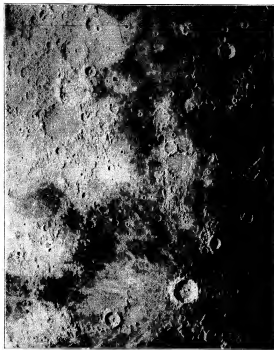

4. BULLIALDUS, COPERNICUS, 1901, November 20.

Other numerical particulars relating to the moon are:—

Mean distance from the earth (earth's radius as 1)	60·2634
Mean apparent diameter	31' 51·5"
Diameter in miles	2159·6
Moon's surface in square miles	14,600,000
Diameter (earth's equatorial diameter as 1)	0·2725
Surface (earth's as 1)	0·0742
Volume (earth's as 1)	0·0209
Ratio of mass to earth's mass ¹	1:81·53 = 0·017
Density (earth as 1)	0·60735
Density (water's as 1, and earth's assumed as 5)	3·46
Ratio of gravity to gravity at the earth's surface	1:6
Inclination of axis of rotation to ecliptic	1° 30' 11·3"

The Lunar Theory.

The mathematical theory of the moon's motion does not yet form a well-defined body of reasoning and doctrine, like other branches of mathematical science, but consists of a series of researches, extending through twenty centuries or more, and not easily welded into a unified whole. Before Newton the problem was that of devising empirical curves to formally represent the observed inequalities in the motion of the moon around the earth. After the establishment of universal gravitation as the primary law of the celestial motions, the problem was reduced to that of integrating the differential equations of the moon's motion, and testing the completeness of the results by comparison with observation. Although the precision of the mathematical solution has been placed beyond serious doubt, the problem of completely reconciling this solution with the observed motions of the moon is not yet completely solved. Under these circumstances the historical treatment is that best adopted to give a clear idea of the progress and results of research in this field. Modern researches were developed so naturally from the results of the ancients that we shall begin with a brief mention of the work of the latter.

It is in the investigation of the moon's motion that the merits of the ancient astronomy are seen to the best advantage. In the hands of Hipparchus the theory was brought to a degree of precision which is really marvellous when we compare it either with other branches of physical science in that age or with the views of contemporary non-scientific writers. The discoveries of Hipparchus were:—

1. *The Eccentricity of the Moon's Orbit.*—He found that the moon moved most rapidly near a certain point of its orbit, and most slowly near the opposite point. The law of this motion was such that the phenomena could be represented by supposing the motion to be strictly circular and uniform, the apparent variations being explained by the hypothesis that the earth was not situated in the centre of the orbit, but was displaced by an amount about equal to one-twentieth of the radius of the orbit. Then, by an obvious law of kinematics, the angular motion round the earth would be most rapid at the point nearest the earth, that is at perigee, and slowest at the point most distant from the earth, that is at apogee. Thus the apogee and perigee became two definite points of the orbit, indicated by the variations in the angular motion of the moon. These points are at the ends of that diameter of the orbit which passes through the eccentrically situated earth, or, in other words, they are on that line which passes through the centre of the earth and the centre of the orbit. This line was called the *line of apsides*. On comparing observations made at different times it was found that the line of apsides was not fixed, but made a complete revolution in the heavens, in the order of the signs of the zodiac, in about nine years.

2. *The Numerical Determination of the Elements of the Moon's Motion.*—In order that the two capital discoveries just mentioned should have the highest scientific value, it was essential that the numerical values of the elements involved in these complicated motions should be fixed with precision. This Hipparchus was enabled to do by lunar eclipses. Each eclipse gave a moment at which the longitude of the moon was 180° different from that of the sun. The latter admitted of ready calculation. Assuming the mean motion of the moon to be known and the perigee to be fixed, three eclipses, observed in different points of the orbit, would give as many true longitudes of the moon, which longitudes could be employed to determine three unknown quantities—the mean longitude at a given epoch, the eccentricity, and the position of the perigee. By taking three eclipses separated at short intervals, both the mean motion and the motion of the perigee would be known beforehand, from other data, with sufficient accuracy to reduce all the observations to the same epoch, and thus to leave only the three elements already mentioned unknown. The same three elements being again determined from a second triplet of eclipses at as remote an epoch as possible, the difference in the

longitude of the perigee at the two epochs gave the annual motion of that element, and the difference of mean longitudes gave the mean motion.

The eccentricity determined in this way is more than a degree in error, owing to the effect of the *evectio*, which was unknown to Hipparchus. The result of the latter inequality is brought out when it is sought to determine the eccentricity of the orbit from the observations near the time of the first and last quarter. It was thus found by Ptolemy that an additional inequality existed in the motion, which is now known as the *evectio*. The relations of the quantities involved may be shown by simple trigonometric formulæ. If we put g for the moon's anomaly or distance from the perigee, and D for its elongation from the sun, the inequalities in question as now known are—

$$\begin{aligned} & 6\cdot29' \sin g && \text{(equation of centre)} \\ & +1\cdot27' \sin 2(D-g) && \text{(evectio).} \end{aligned}$$

During a lunar eclipse we always have $D=180^\circ$, very nearly, and $2D=360^\circ$. Hence the evectio is then $-1\cdot2^\circ \sin g$, and consequently has the same argument g as the equation of centre, so that it is confounded with it. The value of the equation of centre derived from eclipses is thus—

$$6\cdot29' \sin g - 1\cdot27' \sin g = 5\cdot02' \sin g.$$

Therefore the eccentricity found by Hipparchus was only $5'$, and was more than a degree less than its true value. At first quarter we have $D=90^\circ$ and $2D=180^\circ$. Substituting this value of $2D$ in the last term of the above equation, we see that the combined equation of the centre and evectio are, at quadrature—

$$6\cdot29' \sin g + 1\cdot27' \sin g = 7\cdot56' \sin g.$$

Thus, in consequence of the evectio, the equation of the centre comes out $2^\circ 30'$ larger from observations at the moon's quarters than during eclipses.

The next forward step was due to Tycho Brahe. He found that, although the two inequalities found by Hipparchus and Ptolemy correctly represented the moon's longitude near conjunction and opposition, and also at the quadratures, it left a large outstanding error at the octants, that is when the moon was 45° or 135° on either side of the sun. This inequality, which reaches the magnitude of nearly $1'$, is known as the *variation*. Although Tycho Brahe was an original discoverer of this inequality, through whom it became known, Joseph Bertrand of Paris claimed the discovery for Abu 'l-Wefa, an Arabian astronomer, and made it appear that the latter really detected inequalities in the motion which we now know to have been the variation. But he has not been shown, on the part of the Arabian, any such exact description of the inequality as is necessary to make clear his claim to the discovery. We may conclude the ancient history of the lunar theory by saying that the only real progress from Hipparchus to Newton consisted in the more exact determination of the mean motions of the moon, its perigee and its line of nodes, and in the discovery of three inequalities, the representation of which required geometrical constructions increasing in complexity with every step.

The modern lunar theory began with Newton, and consists in determining the motion of the moon deductively from the theory of gravitation. But the great founder of celestial mechanics employed a geometrical method, ill-adapted to lead to the desired result; and hence his efforts to construct a lunar theory are of more interest as illustrations of his wonderful power and correctness in mathematical reasoning than as germs of new methods of research. The analytic method sought to express the moon's motion by integrating the differential equations of the dynamical theory. The methods may be divided into two classes—

1. Laplace used his immediate successors, especially G. A. A. Plan (1781-1864), effected the integration by expressing the time in terms of the moon's true longitude. Then, by inverting the series, the longitude was expressed in terms of the time.

2. By the second general method the moon's co-ordinates are obtained in terms of the time by the direct integration of the differential equations of motion, retaining as algebraic symbols the values of the various elements. Most of the elements are small numerical fractions: e , the eccentricity of the moon's orbit, about 0·055; e' , the eccentricity of the earth's orbit, about 0·017; γ , the sine of half the inclination of the moon's orbit, about 0·046; m , the ratio of the mean motions of the moon and earth, about $\frac{1}{13}$. The expressions for the longitude, latitude and parallax appear as an infinite trigonometric series, in which the coefficients of the sines and cosines are themselves infinite series proceeding according to the powers of the above small numbers. This method was applied with success by Pontécoulant and Sir John W. Lubbock, and afterwards by Delaunay. By these methods the series converge so slowly, and the final expressions for the moon's longitude are so long and complicated, that the series has never been carried far enough to ensure the accuracy of all the terms. This is especially the case with the development in powers of m , the convergence of which has often been questioned.

3. The third method seeks to avoid the difficulty by using the numerical values of the elements instead of their algebraic symbols. This method has the advantage of leading to a more rapid and certain

¹A. R. Hinks, "Mass of the Moon, from Observations of Eros, 1900-1901," *M. N. Roy. Ast. Soc.*, 1900, Nov., p. 73.

determination of the numerical quantities required. It has the disadvantage of giving the solution of the problem only for a particular case, and of being inapplicable in researches in which the general equations of dynamics have to be applied. It has been employed by Damoiseau, Hansen and Airy.

The methods of the second general class are those most worthy of study. Among these we must assign the first rank to the method of C. E. Delaunay, developed in his *Théorie du mouvement de la lune* (Paris, 1860, 1867), because it contains a germ which may yet develop into the great desideratum of a general method in celestial mechanics.

Among applications of the third or numerical method, the most successful yet completed is that of P. A. Hansen. His first work, *Fundamenta nova*, appeared in 1838, and contained an exposition of his ingenious and peculiar methods of computation. During the twenty years following he devoted a large part of his energies to the numerical computation of the lunar inequalities, the redetermination of the elements of motion, and the preparation of new tables for computing the moon's position. In the latter branch of the work he received material aid from the British government, which published his tables on their completion in 1857. The computations of Hansen were published some seven years later by the Royal Saxon Society of Sciences.

It was found on comparing the results of Hansen and Delaunay that there are some outstanding discrepancies which are of sufficient magnitude to demand the attention of those interested in the mathematical theory of the subject. It was therefore necessary that the numerical inequalities should be again determined by an entirely different method.

This has been done by Ernest W. Brown, whose work may be regarded not only as the last word on the subject, but as embodying a seemingly complete and satisfactory solution of a problem which has absorbed an important part of the energies of mathematical astronomers since the time of Hipparchus. We shall try to convey an idea of this solution. We have just mentioned the four small quantities e, e', γ and m , in terms of the powers and products of which the moon's co-ordinates have to be expressed. Euler conceived of the idea of starting with a preliminary solution of the problem in which the orbit of the moon should be supposed to lie in the ecliptic, and to have no eccentricity, while that of the sun was circular. This solution being reached, the additional terms were found, which were multiplied by the first power of the several eccentricities and of the inclination. Then the terms of the second order were found, and so on to any extent. In a series of remarkable papers published in 1877-1888 Hill improved Euler's method, and worked it out with much more rigour and fullness than Euler had been able to do. His most important contribution to the subject consisted in working out by extremely elegant mathematical processes the method of determining the motion of the perigee. John Couch Adams afterwards determined the motion of the node in a similar way. The numerical computations were worked out by Hill only for the first approximation. The subject was then taken up by Brown, who in a series of researches published in the *Memoirs of the Royal Astronomical Society* and in the *Transactions of the American Mathematical Society* extended Hill's method so as to form a practically complete solution of the entire problem. The principal feature of his work was that the quantity m , which is regarded as constant, appears only in a numerical form, so that the uncertainties arising from development in series are confined to its powers, and done away by the method.

The solution of the main mathematical problem thus reached is that of the motion of three bodies only—the sun, earth and moon. The mean motion of the moon round the earth is then invariable, the longitude containing no inequalities of longer period than that of the moon's node, 18.6 y. But Edmund Halley found, by a comparison of ancient eclipses with modern observations, that the mean motion had been accelerated. This was confirmed by Richard Dunthorne (1711-1775). Corresponding to this observed fact was the inference that the action of the planets might in some way influence the moon's motion. Thus a new branch of the lunar theory was suggested—the determination by theory of the effect of planetary action.

The first step in constructing this theory was taken by Laplace, who showed that the secular acceleration was produced by the secular diminution of the earth's orbit. He computed the amount as about $10''$ per century, which agreed with the results derived by Dunthorne from ancient eclipses. Laplace's immediate successors, among whom were Hansen, Plana and Pontécoulant, found a larger value, Hansen increasing it to $12.5''$, which he introduced into his tables. This value was found by himself and Airy to represent fairly well several ancient eclipses of the sun, notably the supposed one of Thales. But Adams in 1853¹ showed that the previous computations of the acceleration were only a rude first approximation, and that a more rigorous computation reduced the result to about one-half. This diminution was soon fully confirmed by others, especially Delaunay, although for some time Pontécoulant stoutly maintained the correctness of the older result. But the demonstration of Adams's result was soon made

conclusive, and a value which may be regarded as definitive has been derived by Brown. With the latest accepted diminution of the eccentricity, the coefficient is $5.91''$.

The question now arose of the origin of the discrepancy between the smaller values by theory, and the supposed values of $12''$ derived from ancient eclipses. In 1856 William Ferrel showed that the action of the moon on the ocean tidal waves would result in a retardation of the earth's rotation, a result, at first unnoticed, which was independently reached a few years later by Delaunay. The amount of retardation does not admit of accurate computation, owing to the uncertainty both as to the amount of the oceanic friction from which it arises and of the exact height and form of the tidal wave, the action of the moon on which produces the effect. But any rough estimate that can be made shows that it might well be supposed much larger than is necessary to produce the observed differences of $6''$ per century. It was therefore surprising when, in 1877, Simon Newcomb found, by a study of the lunar eclipses handed down by Ptolemy and those observed by the Arabians—data much more reliable than the vague accounts of ancient solar eclipses—that the actual apparent acceleration was only about $8.3''$. This is only $2.4''$ larger than the theoretical value, and it seems difficult to suppose that the effect of the tidal retardation can be as small as this. This suggests that the retardation may be in great part compensated by some accelerating cause, the existence of which is not yet well established. The following is a summary of the present state of the question:—

The theoretical value of the acceleration, assuming the day to be constant, is	5.91''
Hansen's value in his <i>Tables de la lune</i> is	12.19
Hansen's revised, but still theoretically erroneous, result is	12.56
The value which best represents the supposed eclipses—(1) of Thales, (2) at Larissa, (3) at Stikkelstad—is about	11.7
The result from purely astronomical observation is	8.3

Inequalities of Long Period.—Combined with the question of secular acceleration is another which is still not entirely settled—that of inequalities of longer period in the mean motion of the moon round the earth. Laplace first showed that modern observations of the moon indicated that its mean motion was really less during the second half of the 18th century than during the first half, and hence inferred the existence of an inequality having a period of more than a century.

The existence of one or more such inequalities has been fully confirmed by all the observations, both early and recent, that have become available since the time of Laplace. It is also found by computation from theory that the planets do produce several appreciable inequalities of long period, as well as a great number of short period, in the motion of the moon. But the former do not correspond to the observed inequalities, and the explanation of the outstanding differences may be regarded to-day as the most perplexing enigma in astronomy. The most plausible explanation is that, like the discrepancy in the secular acceleration, the observed deviation is only apparent, and arises from slow fluctuations in the earth's rotation, and therefore in our measure of time produced by the motion of great masses of polar ice and the variability of the amount of snowfall on the great continents. Were this the case a similar inequality should be found in the observed times of the transits of Mercury. But the latter do not certainly show any deviation in the measure of time, and seem to preclude a deviation so large as that derived from observations of the moon. This suggests that inequalities in the action of the planets may have been still overlooked, the subject being the most intricate with which celestial mechanics has to deal. But this action has been recently worked up with such completeness of detail by Radau, Newcomb and Brown, that the possibility of any unknown term seems out of the question. The enigma therefore still defies solution.

BIBLIOGRAPHY.—Works on selenography: Hevelius, *Selenographia sive lunae descriptio* (Danzig, 1647); Riccioli, *Almagestum novum* (Bologna, 1651); J. H. Schroeter, *Selenographische Fragmente zur genaueren Kenntniss der Mondfläche* (Lilienthal, 1791); W. Beer and J. H. Mädler, *Der Mond nach seinen kosmischen und individuellen Verhältnissen, oder Allgemeine vergleichende Selenographie* (Berlin, 1837); Richard A. Proctor, *The Moon* (London, 1875); the first edition contains an excellent geometrical demonstration of the inequalities produced by the sun in the moon's motion, which were partly omitted in the second edition; J. Nasmith and J. Carpenter, *The Moon, Considered as a Planet, a World, and a Satellite* (London, 1903; fine illustrations); E. Neison (now Neville), *The Moon and the Conditions and Configurations of its Surface* (London, 1876); M. Loewy and P. Puisseux, *Atlas géographique de la lune* (Imprimerie Royale, Paris, 1896-1908); W. H. Pickering, *The Moon, from photographs* (New York, 1904); G. P. Serviss, *The Moon* (London, 1908), a popular account illustrated by fine photographs. On the subject of lunar geology, see N. S. Shaler in *Smithsonian Contributions to Knowledge*, vol. xxvii, pt. 1, 1888, and P. Puisseux, "Recherches sur l'origine probable des formations lunaires," in *Annales de l'observatoire de Paris, Mémoires*, tome xxii.

¹ *Philosophical Transactions*, 1853.

The following are among the works relating to the motion of the moon, which are of historic importance or present interest to the student: Clairaut, *Théorie de la lune* (2nd ed., Paris, 1765); L. Euler, *Theoria motuum lunae novo methodo pertractata* (Petropolis, 1772); G. Plana, *Théorie du mouvement de la lune* (3 vols., Turin, 1832); P. A. Hansen, *Fundamenta nova investigationis orbitae verae quae luna peritratra* (Gotha, 1838); *Darlegung der theoretischen Berechnung der in den Mondtafeln angewandten Störungen* (Leipzig, 1862); C. Delaunay, *Théorie du mouvement de la lune* (2 vols., Paris, 1860-1867); F. F. Tisserand, *Traité de mécanique céleste*, tome iii., *Exposé de l'ensemble des théories relatives au mouvement de la lune* (Paris, 1894); E. W. Brown, "Theory of the Motion of the Moon," *Memoirs of the Royal Astronomical Society*, various vols.; also *Transactions of the American Mathematical Society*, vols. iv. and vi.; E. W. Brown, *Introductory Treatise on the Lunar Theory* (Cambridge University Press, 1896); Hansen, *Tables de la lune* (London, 1857) (Admiralty publication); W. Ferrel, "On the Effect of the Sun and Moon on the Rotary Motion of the Earth," *Astron. Jour.*, vol. iii. (1854); S. Newcomb, "Researches on the Motion of the Moon" (Appendix to *Washington Observations for 1875*, discussion of the moon's mean motion); S. Newcomb, "Transformation of Hansen's Lunar Theory," *Ast. Papers of the Amer. Ephemeris*, vol. i.; R. Radau, "Inégalités planétaires du mouvement de la lune" (*Annales*, Paris Observatory, vol. xxi.); S. Newcomb, "Action of the Planets on the Moon," *Ast. Papers of the Amer. Ephemeris*, vol. v., pt. 3 (1896). Also, Publication 72 of the Carnegie Institution of Washington (1907); E. W. Brown, *Inequalities in the Moon's Motion produced by the Action of the Planets* (the Adams prize essay for 1907). (S. N.)

MOONSEED, in botany, a common name for *Menispermum*, a genus of climbing deciduous shrubs, containing one species in North America and another in Eastern Asia. The former, *M. canadense*, is a handsome plant, suited to damp and shady walls, with large reniform petlate leaves and yellowish flowers borne in profusion on long pendulous racemes.

MOONSTONE, a variety of felspar, occurring in certain directions a bluish opalescence, whence its value as an ornamental stone. When cut with a convex surface it displays a soft milky reflection, forming a luminous band, but not sharply defined as in cat's-eye. The ordinary moonstone is a translucent variety of orthoclase known as adularia (see ORTHOCLASE),

whence the peculiar sheen has been called "adularescence." The effect is probably caused by interference from twin lamellae, or by numerous enclosures of microscopic laminae, definitely orientated, and it has been suggested that these may often be flakes of kaolin due to incipient decomposition of the felspar. Practically all the moonstone of commerce comes from Ceylon, principally from the Dumbura district of the Central Province. It occurs as pebbles and irregular masses in the gem-gravels and clay-deposits, and is also obtained by quarrying an adularia leptynite, as described by Dr. A. K. Coomáraswamy. Very similar in some respects to moonstone is the chatoyant soda-felspar which was called by T. Sterry Hunt peristerite, from Gr. *περιστέρα*, a dove, in allusion to the resemblance of its lustre to that of the bird's neck. The original peristerite was from Bathurst, near Perth, Lanark county, Ontario, but it occurs also at Macomb, St Lawrence county, New York.

MOONWORT, or MOON-FERN, in botany, the popular name of a small fern (*Botrychium Lunaria*), belonging to the order Ophioglossaceae (see FERNS). It has a tuberous root-stock and a stout fleshy glabrous frond 3 to 6 in. long, with a sterile and fertile portion; the former bears several pairs of close-set, semi-circular or moon-shaped pinnae, the latter

is pinnately branched and covered, on the face opposed to the sterile portion, with small globose spore-cases which burst transversely. It is a widely distributed plant in the north and south temperate and cold zones, and is found in pastures and grassy banks in Britain.

MOOR. (1) A heath, an unenclosed stretch of waste or uncultivated land, covered with heather; also such a heath preserved for game-shooting, particularly for the shooting of grouse. The O. Eng. *mōr*, bog, moor, is represented in other Teutonic languages; cf. Dan. *mor*, Ger. *Moor*, O. Du. *moer*, &c.; from an O. Du. adjectival form *moerasc* comes Eng. *moorass*, a bog. Probably *mere*, *marsh*, are not to be connected with these words. (2) The verb "to moor," to fasten a ship or boat to the shore, to another vessel, or to an anchor or buoy, by cables, &c., is probably from the root seen in mod. Du. *meren*, which also gives the English nautical term "marline," small strands of rope used for lashings or seizings, and "marline-spike," a small iron tool for separating the strands of rope, &c.

MOORCROFT, WILLIAM (c. 1770-1825), English traveller, was born in Lancashire, about 1770. He was educated as a surgeon in Liverpool; but on completing his course he resolved to devote himself to veterinary surgery, and, after studying the subject in France, began practice in London. In 1795 he published a pamphlet of directions for the medical treatment of horses, with special reference to India, and in 1800 a *Cursorio Account of the Methods of Shoeing Horses*. Having been offered by the East India Company the inspectorship of their Bengal stud, Moorcroft left England for India in 1808. Under his care the stud rapidly improved; in order to perfect the breed he resolved to undertake a journey into Central Asia to obtain a stock of Turkoman horses. In company with Captain William Hearsey, and encumbered with a stock of merchandise for the purpose of establishing trade relations between India and Central Asia, Moorcroft left Josimath, well within the mountains, on the 26th of May 1812. Proceeding along the valley of the Dauli, they reached the summit of the frontier pass of Niti on the 1st of July. Descending by the towns of Darba and Gartok, Moorcroft struck the main upper branch of the Indus near its source, and on the 5th of August arrived at the sacred lake of Manasarovar. Returning by Bhutan, he was detained some time by the Gurkhas, and reached Calcutta in November. This journey only served to whet Moorcroft's appetite for more extensive travel, for which he prepared the way by sending out a young Hindu, who succeeded in making extensive explorations. In company with him and George Trebeck, Moorcroft set out on his second journey in October 1819. On the 14th of August the source of the Beas (Hyphasis) was discovered, and subsequently that of the Chenab. Leh, the capital of Ladakh, was reached on the 24th of September, and here several months were spent in exploring the surrounding country. A commercial treaty was concluded with the government of Ladakh, by which the whole of Central Asia was virtually opened to British trade. Kashmir was reached on the 3rd of November 1822, Jalalabad on the 4th of June 1824, Kabul on the 20th of June, and Bokhara on the 25th of February 1825. At Andkhui, in Afghan Turkestan, Moorcroft was seized with fever, of which he died on the 27th of August 1825, Trebeck surviving him only a few days. But according to the Abbé Huc, Moorcroft reached Lhasa in 1826, and lived there twelve years, being assassinated on his way back to India in 1838. In 1841 Moorcroft's papers were obtained by the Asiatic Society, and published, under the editorship of H. H. Wilson, under the title of *Travels in the Himalayan Provinces of Hindustan and the Punjab, in Ladakh and Kashmir, in Peshawar, Kabul, Kunduz and Bokhara, from 1819 to 1825*.

See Graham Sandberg, *The Exploration of Tibet* (1904).
MOORE, ALBERT JOSEPH (1841-1893), English decorative painter, was born at York on the 4th of September 1841. He was the youngest of the fourteen children of the artist, William Moore, of York who in the first half of the 19th century enjoyed a considerable reputation in the North of England as a painter of portraits and landscape. In his childhood Albert Moore showed



From Strachburger's *Lehrbuch der Botanik*, by permission of Gustav Fischer, Botany Club, Lunaria.

an extraordinary love of art, and as he was encouraged in his tastes by his father and brothers, two of whom afterwards became famous as artists—John Collingham Moore, and Henry Moore, R.A.—he was able to begin the active exercise of his profession at an unusually early age. His first exhibited works were two drawings which he sent to the Royal Academy in 1857. A year later he became a student in the Royal Academy schools; but after working in them for a few months only he decided that he would be more profitably occupied in independent practice. During the period that extended from 1858 to 1870, though he produced and exhibited many pictures and drawings, he gave up much of his time to decorative work of various kinds, and painted, in 1863, a series of wall decorations at Coombe Abbey, the seat of the earl of Craven; in 1865 and 1866 some elaborate compositions: "The Last Supper" and "The Feeding of the Five Thousand" on the chancel walls of the church of St Alban's, Rochdale; and in 1868 "A Greek Play," an important panel in tempera for the proscenium of the Queen's Theatre in Long Acre. His first large canvas, "Elijah's Sacrifice," was completed during a stay of some five months in Rome at the beginning of 1863, and appeared at the Academy in 1865. A still larger picture, "The Shunamite relating the Glories of King Solomon to her Maidens," was exhibited in 1866, and with it two smaller works, "Apricots" and "Pomegranates." In these Albert Moore asserted plainly the particular technical conviction which for the rest of his life governed the whole of his practice, and with them he first took his place definitely among the most original of British painters. Of his subsequent works the most notable are "The Quartette" (1869), "Sea Gulls" (1871), "Follow-my-Leader" (1873), "Shells" (1874), "Topaz" (1879), "Rose Leaves" (1880), "Yellow Marguerites" (1881), "Blossoms" (1881), "Dreamers" (1882), "Reading Aloud" (1884), "Silver" (1886), "Midsummer" (1887), "A River Side" (1888), "A Summer Night" (1890), "Lightning and Light" (1892), "An Idyll" (1893), and "The Loves of the Winds and the Seasons," a large picture which was finished only a few days before his death. He died on the 25th of September 1893, at his studio in Spenser Street, Westminster. Several of his pictures are now in public collections; among the chief are "Blossoms," in the National Gallery of British Art; "A Summer Night" in the Liverpool Corporation Gallery; "Dreamers" in the Birmingham Corporation Gallery; and a water-colour, "The Open Book," in the Victoria and Albert Museum, South Kensington. In all his pictures, save two or three produced in his later boyhood, he avoided any approach to story-telling, and occupied himself exclusively with decorative arrangements of lines and colour masses. The spirit of his art is essentially classic, and his work shows plainly that he was deeply influenced by study of antique sculpture; but he was not in any sense an archaeological painter, nor did he attempt reconstructions of the life of past centuries. Artistically he lived in a world of his own creation, a place peopled with robust types of humanity of Greek mould, and gay with bright-coloured draperies and brilliant-hued flowers. As an executant he was careful and certain; he drew finely, and his colour-sense was remarkable for its refinement and subtle appreciation. Few men have equalled him as a painter of draperies, and still fewer have approached his ability in the application of decorative principles to pictorial art.

MOORE, EDWARD (1712-1757), English dramatist and miscellaneous writer, the son of a dissenting minister, was born at Abingdon, Berkshire, on the 22nd of March 1712. He was the author of the domestic tragedy of *The Gamberger*, originally produced in 1753 with Garrick in the leading character of Beverly the gambler. As a poet he produced clever imitations of Gay and Gray, and with the assistance of George, 1st Lord Lyttelton, Lord Chesterfield and Horace Walpole, conducted *The World* (1753-1757), a weekly periodical on the model of the *Rambler*. Moore collected his poems under the title of *Poems, Fables and Plays* in 1756. He died in Lambeth on the 1st of March 1757. His *Dramatic Works* were published in 1788.

MOORE, GEORGE (1853-), Irish novelist and poet, was born in Ireland, son of George Henry Moore, M.P., a well-known orator and politician. He studied art in London and finished his education in Paris. He was a regular contributor to various London magazines when he published his first volume, in verse, *The Flowers of Passion* (1877). A second, *Pagan Poems*, appeared in 1881. As a novelist he followed the French school of Flaubert and Zola, and became prominent for deliberate realism. His powerful *Mummer's Wife* (1885) had decidedly repulsive elements. But Zolaism meanwhile was a thing to which the reading public was gradually becoming acclimatized. George Moore's *Esther Waters* (1894), a strong story with an anti-gambling motive, had a more general success, and was followed by *Evelyn Innes* (1898), a novel of musical life, and its sequel, *Sister Teresa* (1901). He interested himself in the Irish Gaelic revival, and was one of the founders of the Irish Literary Theatre. His play, *The Strike at Arlingford* (three acts, in prose, 1893), was written for the Independent Theatre, and his satirical comedy, *The Bending of the Bough* (1900), dealing with Irish local affairs, was played by the Irish Literary Theatre in Dublin. His *Diarmuid and Grania*, written with Mr. W. B. Yeats, was produced by Mr. F. R. Benson's company at the same theatre in 1901. *The Untilled Field* (1903) and *The Lake* (1905) are romantic pictures of Irish life. Moore had originally come to the front in London about 1888 as an art critic, and his published work in that line includes *Impressions and Opinions* (1891) and *Modern Painting* (1893, 2nd ed., 1897). Among his other books are *A Drama in Muslin*, (1886), *A Mere Accident* (1887), *Parnell and His Island* (1887), *Mike Flecher* (1887), *Spring Days* (1888), *Vain Fortune* (1890), *Celibates* (1895), *Confessions of a Young Man* (1888), and *Memoirs of My Dead Life* (1906).

MOORE, GEORGE FOOT (1851-), American Biblical scholar, was born in West Chester, Pennsylvania, on the 15th of October 1851, the son of William Eves Moore (1823-1890), a prominent Presbyterian minister, long the permanent clerk of the Presbyterian General Assembly. The son graduated at Yale in 1872 and at Union Theological Seminary in 1877, was ordained in 1878, and from 1878 to 1883 was pastor of the Putnam Presbyterian Church, Zanewille, Ohio. He was Hitchcock professor of the Hebrew language and literature in Andover Theological Seminary in 1883-1902, and was president of its faculty in 1899-1901; in 1902 he became professor of theology and in 1904 professor of the history of religion at Harvard University. His chief critical work dealt with the Hexateuch, and more particularly the Book of Judges (Commentary, 1895; text, translation and notes, 1898; text with critical notes, 1900).

MOORE, HENRY (1831-1895), English painter, the ninth son of William Moore, of York, and brother of Albert Joseph Moore, was born in that city on the 7th of March 1831. His artistic education was chiefly supervised by his father, but he also attended the York School of Design, and worked for a short time in the Royal Academy Schools. He first exhibited at the Academy in 1853, and was a constant contributor to its exhibitions till his death. At the outset of his career he occupied himself mostly with landscapes and paintings of animals, executed with extraordinary detail in imitation of the prevailing taste of the Pre-Raphaelite Brotherhood; but in 1857, while on a visit to the West of England, he made his first attempts as a sea-painter. His success was immediate, and it had the effect of diverting him almost entirely from landscapes. Among his most important canvases must be reckoned "The Pilot Cutter" in 1866, "The Salmon Poachers" in 1869, "The Lifeboat" in 1876, "Highland Pastures" in 1878, "The Beached Margent of the Sea" in 1880, "The Newhaven Packet" (bought by the Birmingham Corporation), and "Catspaws off the Land" (bought by the Chantry Fund trustees); in 1885, "Mount's Bay" (bought by the Manchester Corporation) in 1886, "Nearing the Needles" in 1888, "Machrihanish Bay, Cantyre," in 1892, "Hove-to for a Pilot" in 1893, and "Glen Orchy," a landscape, in 1895. He was elected an associate

of the Royal Society of Painters in Water Colours in 1876, and a full member in 1880; an associate of the Royal Academy in 1885, and an academician in 1893; and at Paris, in 1887, where he exhibited "The Newhaven Packet" and "The Cleanness after Rain," he received a *grand prix* and was made a knight of the Legion of Honour. He died at Margate on the 22nd of June 1895. His works are marked by admirable appreciation of nature, and by a rare understanding of wave-form and colour and of the subtleties of atmospheric effect; and as a sea-painter he may fairly be regarded as almost without a rival.

MOORE, JOHN (1729-1802), Scottish physician and writer, was born at Stirling in 1729, the son of a clergyman. After taking his medical degree at Glasgow, he served with the army in Flanders, then proceeded to London to continue his studies, and eventually to Paris, where he was attached to the household of the British ambassador. His novel *Zeluco* (1789), a close analysis of the motives of a selfish profligate, produced a great impression at the time, and indirectly, through the poetry of Byron, has left an abiding mark on literature. Byron said that he intended Childe Harold to be "a poetical Zeluco," and the most striking features of the portrait were undoubtedly taken from that character. Moore's other works have a less marked individuality, but his sketches of society and manners in France, Germany, Switzerland, Italy and England furnish valuable materials for the social historian. In 1792 he accompanied Lord Lauderdale to Paris, and witnessed some of the principal scenes of the Revolution. His *Journal during a Residence in France* (1793) is the careful record of an eye-witness, and is frequently referred to by Carlyle. He died in London on the 21st of January 1802, leaving five sons, the eldest of whom was General Sir John Moore. James Moore (1763-1834), who wrote Sir John's *Life*, was also the author of some important medical works, and Sir Graham Moore (1764-1843), saw much active naval service and became an admiral.

MOORE, SIR JOHN (1761-1809), British general, the son of John Moore, was born at Glasgow on the 13th of November 1761. From his early years he intended to become a soldier, learned the Prussian firing exercise, and was "always operating in the field and showing how Geneva could be taken." By the duke of Hamilton's influence he obtained an ensigncy in the 51st foot (1776), learned his drill at Minorca, and in 1778 was appointed captain-lieutenant in a new regiment raised by Hamilton for service in the American War. Moore remained in America to the peace of 1783, after which the Hamilton regiment was disbanded. In 1784 he was returned by the Hamilton interest as member of parliament for the united boroughs of Lanark, Selkirk, Peebles and Linlithgow. In parliament, though he never spoke, he seems to have taken his duties very seriously, and to have preserved an independent position, in which he won the friendship of Pitt and the respect of Burke, and (more important still) the friendship of the duke of York. In 1787 he became major in the 60th (now King's Royal Rifles), but in the following year he was transferred to his old corps, the 51st. In 1792 Moore sailed with his corps to the Mediterranean. He was too late to assist at Toulon, but was engaged throughout the operations in Corsica, and won particular distinction at the taking of Calvi, where he was wounded. Soon after this he became adjutant-general to Sir Charles Stuart, with whom he formed a close friendship. After the expulsion of the French Moore became very intimate with many of the leading Corsican patriots, which intimacy was so obnoxious to Sir Gilbert Elliot (later Lord Minto) that Moore was eventually ordered to leave the island in forty-eight hours, though Elliot wrote in warm terms of his ability. Pitt and the duke of York thought still more highly of Colonel Moore, who was soon sent out to the West Indies in the local rank of brigadier-general. Here he came under the command of Sir Ralph Abercromby, whose most valued adviser and subordinate Moore soon became. In the Santa Lucia expedition he won further distinction by his conduct at the capture of the Vigie and Morne Fortuné, and when Sir Ralph left the island he appointed Moore governor and military commander. In 1798 he accompanied Abercromby

to Ireland as a major-general, and during the rebellion was actively engaged in command of a corps in the south, defeating a large force of the Irish, and saving Wexford from destruction after the battle of Vinegar Hill (June 21). His services were in universal request, and Abercromby had him appointed to the command of a brigade destined for the expedition to Holland. At the action of Egmont-op-Zee, on the 2nd of October 1799, his brigade lost very heavily, and he himself was wounded for the fourth time, on this occasion severely. On his return from Holland he was made colonel of the 52nd regiment, with which he was connected for the rest of his career, and which under his supervision became one of the finest regiments in Europe.

Throughout the Egyptian expedition he commanded the reserve. The 28th and 42nd regiments in this corps gained great distinction at the battle of Alexandria, where Moore himself was again wounded. He returned to duty, however, before the surrender of the French forces to General Hutchinson, and added so much to his reputation by his conduct in this brilliant campaign that after the short peace came to an end he was appointed to command the force assembled at Shorncliffe camp (1803) as a part of the army intended to meet the projected invasion of Napoleon. Here were trained some of the best regiments of the service, amongst others the 43rd, 52nd and 95th Rifles, the regiments which afterwards formed the famous "Light Division" and won in the Peninsula an unsurpassed reputation, not only for the skilful performance of the duties of light troops, but also for invincible steadiness in the line of battle. These corps (now represented in the army by the 1st and 2nd battalions of the Oxfordshire Light Infantry and the Rifle Brigade) bore the impress of Moore's training for thirty years and more, and as early as 1804, on account of the "superior state" of the 52nd, the king granted the officers exceptional promotion (August 29, 1804). The system of light infantry tactics taught at Shorncliffe was not invented by Moore; but he had always advocated the creation of these troops, and he supervised the training which produced such great results. While at Shorncliffe he renewed his intimacy with Pitt, who was then residing at Walmer Castle, and his close friendship with Lady Hester Stanhope led to the erroneous belief that he was betrothed to her. On his return to office Pitt caused Moore to be made a Knight of the Bath, and about the same time came his promotion to the rank of lieutenant-general. Fox, when he succeeded to office, showed the same appreciation of Moore, and in 1806 sent him to the Mediterranean as second-in-command to his brother, General H. E. Fox. In the various minor expeditions of the time Moore had a share, at first as a subordinate, but soon, when Fox went home on account of ill-health, as commander-in-chief of the British army employed in the Mediterranean. About this time he formed an attachment for Caroline Fox (afterwards the wife of Sir William Napier), to whom, however, he did not offer marriage, fearing to "influence her," by his high position and intimacy with her father, "to an irretrievable error for her own future contentment" (*Life of Sir C. Napier*, i. 39). In 1808 Moore was ordered to the Baltic, to assist Gustavus IV., king of Sweden, against Russia, France and Denmark. The conduct of the king, who went so far as to place Sir John Moore under arrest when he refused to acquiesce in his plans, ruined any chance of successful co-operation, and the English general returned home, making his escape in disguise. He was at once ordered to proceed with his division to Portugal, where he was to be under the command of Sir Hew Dalrymple and Sir Harry Burrard. To Moore, as a general of European reputation, who had held a chief command, the appointment of two senior officers to be over him appeared as a bitter insult, though his resentment did not divert him from his duty. He met his reward, for when, in the excitement caused by the convention of Cintra, Dalrymple and Burrard were ordered home, Moore was left in command of the largest British army that had been employed since the commencement of the war. Wellesley, who returned home with the other generals, showed his appreciation of Moore, and in an interesting letter (*Wellington Despatches*, Oct. 8, 1808) expressed his desire to use his own

great political influence to effect a reconciliation between Moore and the ministers.

It was not long before the Spaniards summoned Sir John Moore's army to assist them against the advance of Napoleon, and the troops were marched into Spain, Salamanca being their rendezvous. There Moore remained for a month, calling up Sir David Baird's corps from Corunna to assist him. Soon, however, the overwhelming success of the emperor's attack threatened to isolate Moore, and it was then that he formed the magnificent resolution of marching northwards against the French line of retreat. The bold and skilful operations which followed this step will be found outlined in the article PENINSULAR WAR. Moore's advance paralysed the Emperor's victorious armies. Napoleon himself turned against the British army, which was soon in grave danger, but Spain was saved. Under these circumstances took place the famous retreat on Corunna. The indiscipline of a large proportion of the troops made it painful and almost disastrous, but the reserve under Edward Paget, in which served Moore's old Shorncliffe regiments, covered itself with glory in the ceaseless rearward fighting which marked every step of the retreat. The march ended with the glorious battle of Corunna (Jan. 16, 1809), where, early in the day, Sir John Moore received his death wound. He would not suffer his sword to be unbuckled, though the hilt galled his wound, and so he was borne from the field. His last hours were cheered by the knowledge of victory, and his only care was to recommend his friends, and those who had distinguished themselves, to the notice of the government. He died with the name of Lady Hester Stanhope on his lips. By his own wish he was buried, before dawn on the 17th, in the ramparts of Corunna. Marshal Soutz designed that a monument should be erected, with an inscription framed by himself, and the Spanish general La Romana afterwards carried out Soutz's wishes. The temporary monument thus erected was made permanent in 1811 by Sir Howard Douglas, acting for the prince regent. The duke of York issued to the army on the 1st of February a noble order in which reference was made to the services of the general, and, above all, to the fact that "the life of Sir John Moore was spent among the troops." A memorial was erected in St Paul's Cathedral by order of parliament early in 1809, and his native city of Glasgow erected in George Square a bronze statue by Flaxman. The poem by the Rev. Charles Wolfe, "The Burial of Sir John Moore," became one of the most popular in the language. The best-known portrait of Sir John Moore is that by Sir Thomas Lawrence, P.R.A.

For many years controversy, largely political, raged over the events of the Corunna campaign, and only at a later period has any examination of Sir John Moore's merits and services been made in a dispassionate spirit. Mistakes were doubtless made in the retreat, but it is sufficient to accept Napoleon's view that they were probably inseparable from the difficulties with which Moore was surrounded. His greatest claim to renown is, however, independent of his conduct of armies in the field. He was the finest trainer of men that the British army has ever known. He had the true gift of the great man, judgment of character. While Wellington, whose work would have been vain but for Moore's achievements, perpetually complained of his officers and formed no school, Moore's name is associated with the career of all who made their mark. The history of the Light Division is sufficient in itself to indicate the results of Moore's training on the rank and file. In opposition to the majority, who regarded the lash and the gallews as the source of discipline, he sought always and by every means to develop the moral qualities no less than the physical. Of the senior officers Hope, Graham, Edward Paget, Hill and Craufurd all felt and submitted to his ascendancy. The flower of the younger generation, Colborne, Hardinge and the Napiers, even though they gained their laurels under Wellington and in chief command, were ever proud to call themselves "Sir John Moore's men."

See, besides the works mentioned in the article PENINSULAR WAR, J. C. Moore, *Life of Sir John Moore* (1833); Sir J. F. Maurice,

Sir John Moore's Journal (1904); and the Records of the 52nd (Oxfordshire Light Infantry). A shorter memoir will be found in *Twelve British Soldiers* (London, 1899).

MOORE, THOMAS (1779-1852), Irish poet, was born in Dublin on the 28th of May 1779. His father was John Moore, a prosperous grocer and wine merchant, and his mother's maiden name was Anastasia Codd. In 1793 Tom Moore's name first appeared in print, as a contributor of some verses "To Zelia," to a Dublin periodical, the *Anthologia Hibernica*. In the same year Roman Catholic students began to be admitted to Trinity College, Dublin, and in 1794 Moore's name was entered on the books, curiously enough, as a Protestant. At Trinity he made friends with Robert Emmet, and was nearly dragged into the plots of the United Irishmen. The events of 1798 and the execution of Emmet in 1803 made a deep impression on him. The words of Emmet's address to his judges, asking the charity of silence—"Let no man write my epitaph"—are enshrined by Moore in one of his lyrics, "Oh, breathe not his name!" (*Irish Melodies*, 1808). The next song in the same collection—"When he who adores thee"—also owes its inspiration to Emmet's fate, and the conscientious Orientalism of *Lalla Rookh* does not conceal the pre-occupation of the writer with the United Irishmen when he writes of "The Fire Worshipers," and with Emmet and Sarah Curran when he describes the loves of Hafed and Hinda, especially in the well-known song, "She is far from the Land where her young Hero sleeps." In 1798 Moore graduated, and in the next year left for England to keep his terms at the Middle Temple.

He rapidly became a social success in London. Joseph Atkinson, secretary in Ireland to the ordnance board, had been attracted to Moore in Dublin at first by his gifts as a singer. He now gave him an introduction to Francis Rawdon-Hastings, 2nd earl of Moira, who invited him to his country seat at Donington Park, Leicestershire. Here Moore became a frequent guest. He had brought with him from Ireland a translation of the *Odes of Anacreon*, and the prince of Wales consented to have the volume dedicated to him. It was issued in 1800 with notes and a list of distinguished subscribers. His social successes involved him in expenses far beyond his means. His publisher had advanced him money, and he resolved to pay his debt by the anonymous publication of his juvenile poems, *The Poetical Works of the Late Thomas Little, Esq.* (1801), a collection of love poems which Moore afterwards regretted. Through Lord Moira's influence he was, in 1803, appointed registrar of the admiralty prize-court at Bermuda. He went there to take possession of the post, but soon tired of the monotonous life, and in 1804, after appointing a deputy, returned to England by way of the United States and Canada. In 1806 he published *Epistles, Odes and other Poems*, chiefly dealing with his impressions of travel. The volume contained the "Canadian Boat Song" ("Faintly as tolls the evening chime"), and some love poems of the same kind as those connected with the name of "Mr Little." Jeffrey made an unjustifiable onslaught on this collection in the *Edinburgh Review* for July 1806. Moore was in his view "the most licentious of modern versifiers, and the most poetical of those who, in our time, have devoted their talents to the propagation of immorality," and the book was a "public nuisance." Moore challenged Jeffrey, and a duel was arranged at Chalk Farm. The police interrupted the proceedings. Jeffrey's pistol was found to be unloaded, and the ludicrous affair ended in a fast friendship between them.

The success of the satirical epistles in the 1806 volume encouraged Moore to produce further work of a similar kind, *Corruption and Intolerance, Two Poems* (1808), and *The Sceptic: a Philosophical Satire* (1809), but the heroic couplet and the manner of Pope did not suit his talents. At the end of 1806 he went to Dublin, and, with the exception of about six months in 1807 spent at Donington Park, the next three years were spent in Ireland. Here he met Miss Elizabeth Dyke, an actress, who became his wife in March 1811. They lived at first in London, but soon removed into the country, to Kegworth, near Lord Moira's seat, and then to Mayfield Cottage, near

Ashbourne, Derbyshire. Moore had to spend much of his time in London, for the popularity of his songs led to an agreement with his publisher to increase the success of these by singing them himself at great houses. The inception of his *Irish Melodies* dates from 1807, and many of the best were written during the three years of his Irish visit. He had already published separate songs, some of them set to music of his own, when William Power suggested to him in 1807 the task of fitting words to a series of Irish airs supplied by Sir John Stevenson. He could not have found a task more exactly suited to his powers, and for a quarter of a century he enjoyed a regular income of £500 a year from Power for writing words to music. The first number of the *Irish Melodies* appeared in 1808, and contained some of his best and most popular work. The rest appeared between 1808 and 1834. In 1816 Stevenson and Moore published *Sacred Songs*, followed by a second number in 1824. In 1818 they began to adapt melodies from other nations. The first number of *National Airs* appeared in 1818, and was followed by others in 1820, 1822, 1826, and 1827.

After 1812 he broke ground in a new field—political squib-writing. His first butt was the prince regent, once his friend and patron, whose foibles, fatness, love for cutlets and curaçao, for aged mistresses and practical jokes, were ridiculed with the lightest of clever hands. His earlier political poems appeared in the *Morning Chronicle*, but in 1813 he published a thin volume of *Intercepted Letters: The Twopenny Post Bag*. Other volumes of squibs, most of which passed through several editions, followed: *The World at Westminster* (1816), *The Fudge Family in Paris* (1818), *The Journal of a Member of the Pococurante Society* (1820), *Fables for the Holy Alliance* (1823), *Odes on Cash, Corn, Catholics, and other Matters* (1828), *The Fudge Family in England* (1835). The only failure among his satirical writings was *Tom Crib's Memorial to Congress* (1819) for which he had made an elaborate study of thieves' argot.

In 1814 he contracted with the firm of Longmans to supply a metrical romance on an Eastern subject, which should contain at least as many lines as Scott's *Robey*, the publishers binding themselves to pay 3000 guineas on delivery. Moore had begun *Lalla Rookh* two years before. He was a careful and laborious writer, and retired to a cottage in the neighbourhood of Donington Park, where with the help of Lord Moira's library he read himself slowly into familiarity with Eastern scenery and manners. He was already far advanced in his work when Byron in *The Giaour* and again in *The Bride of Abydos* largely forestalled him. The depression following on the peace of 1815 deferred the publication of *Lalla Rookh* until 1817. It was an immediate success. The Eastern local colouring which dazzled Moore's contemporaries has, however, faded, and the interest still existing in the poem is chiefly due to the undercurrent of Irish patriotism which he cleverly worked into it. Immediately after the completion of *Lalla Rookh*, Moore removed with his family to Sloperton Cottage, Wiltshire, where he was close to Bowood, Lord Lansdowne's country seat. Moore's plans were interrupted by the embezzlement of some £6000 by the deputy he had left in Bermuda, for whose default he was fully liable. To avoid a debtors' prison Moore retired to the Continent. He visited Byron in Italy, and in October 1819 received from him the first part of the *Memoirs*. The continuation was sent to Moore in Paris the next year, with Byron's suggestion that the reversion of the MS. should be sold. Moore did not remain long in Italy, but made his home in Paris, where he was joined by his wife and children. He was not able to return to England until 1822, when the Bermuda affair was compromised by a payment through Longmans of £1000. Moore had had many offers of help, but preferred to be indebted to his publishers only. During his exile he had written another Oriental poem, *The Loves of the Angels* (1822), which was hardly less popular than *Lalla Rookh*. He now became a contributor of satirical verse to *The Times*, the connexion lasting until 1827. He now wrote his *Memoirs of the Life of Sheridan*, first contemplated in 1814, which appeared, after some delay, in 1825. *The Memoirs of Captain Rock* (1824), in which he gives a

humorous but convincing account of English misgovernment in Ireland, was the result of a tour with Lord Lansdowne in western Ireland. His prose tale, *The Epicurean*, appeared in 1827, and the *Legendary Ballads* in 1830. In 1831 he completed his *Life and Death of Lord Edward Fitzgerald*, probably his best piece of prose work.

The death of Byron in 1824 raised the question of the publication of his *Memoirs*. Moore had parted with them in 1821 to John Murray for £2000. After they had come into Murray's possession, Moore began to have doubts about the propriety of publishing them, and an arrangement was therefore made that the £2000 should be regarded as a loan, to be repaid during Byron's lifetime, and that the MS. should be retained as a security. When Byron died the *Memoirs* were still unredeemed, and the right of publication therefore rested with Murray. Moore now borrowed the money from Longmans and induced Murray to give up his claim. The money was paid, and, after a heated discussion with Byron's executors, the MS. was burnt. It was partly the pressure of the debt thus contracted, and partly the expressed wish of Byron, that induced Moore to undertake for Murray *The Letters and Journals of Lord Byron, with Notices of his Life* (1830). The difficult task was executed with great skill and tact, and it remains, with all its defects and omissions, a valuable record.

Moore's countrymen desired him to accept a seat in parliament for Limerick. The offer was accompanied by a scheme to present Moore with an estate in the county worth £300 a year. It was made through the poet Gerald Griffin, who has left on record an account of the interview. Moore declined the honour. In 1830 he allowed himself to be drawn into a project for writing a *History of Ireland* (4 vols., 1835, 1837, 1840 and 1846) for *Lardner's Cyclopaedia*. He hoped that by writing the history of Ireland he might arouse in his own countrymen an interest in their past, and open the eyes of Englishmen to the misgovernment of the country. He had neither the historical training nor the despatch in writing which enabled Scott to scribble off the companion volumes on Scotland, and the history sat like a nightmare on him, and was left unfinished on the melancholy collapse of his powers in 1845. He had, however, the temper of the student, and was always a voracious reader.

Moore's last years were harassed by pecuniary difficulties, and by the weakness and misconduct of his sons, the elder of whom retired from the English army to enter the foreign legion of France. After the death of his last child in 1845, Moore became a total wreck, but he lived until the 25th of February 1852. He left sufficient provision for his wife in the *Diary* which he kept chiefly on her behalf.

His other works are, *A Letter to the Roman Catholics of Dublin* (1810); *A Melodist upon National Music* (1811); an operetta, *M.P. or The Blue Glove* (1811); *A Set of Glees* (1827); *The Summer Fête* (1831); *Evenings in Greece* (1826-1832); *Travels of an Irish Gentleman in Search of a Religion*; *Alciphron, a Poem* (1830).

See *Memoirs, Journal and Correspondence of Thomas Moore* (8 vols., 1853-1856), ed. by Lord John Russell, which contains an immense quantity of biographical material; *The Poetical Works of Thomas Moore, Collected by Himself* (10 vols., 1840-1842); also *Notes from the Letters of Thomas Moore to his Music Publisher, James Power* (1854); and *Prose and Verse, Humorous, Satirical and Sentimental, by Thomas Moore, with suppressed passages from the Memoirs of Lord Byron* . . . (1878), which includes Moore's contributions to the *Edinburgh Review* (1814-1834). Among modern editions of Moore's *Poetical Works* may be mentioned that by Charles Kent (the Centenary ed., 1879), and that by W. M. Rossetti (1880). *Memoirs of Moore* are prefixed to these editions. There are many contemporary references to him, especially in the journals and letters of Byron. There is an excellent life, by Stephen Cwynn, *Thomas Moore* (1905), written for the "English Men of Letters Series." See also monographs on Moore, by G. Vallat (1886 and 1895), an essay on him as the poet "of Irish opposition and revolt" in Georg Brandes, *Main Currents in Nineteenth Century Literature* (vol. iv., 1875; Eng. trans., 1905).

MOORHEAD, a city and the county-seat of Clay county, Minnesota, U.S.A., opposite Fargo, North Dakota, on the E. bank of the Red River and about 215 m. N.W. of Minneapolis. Pop. (1890), 2088; (1900), 3730; (1905), 4794; (1910),

4840. Moorhead is served by the Great Northern and the Northern Pacific railways. The city is the seat of one of the state normal schools (1888) and of Concordia College (Norwegian Lutheran; 1891), which in 1907-1908 had 500 students. Moorhead, named in honour of James K. Moorhead (1806-1884), a Republican representative in Congress from Pennsylvania in 1850-1869, was settled in 1871, was incorporated as a village in 1875, and was chartered as a city in 1881.

MOOR-HEN, the name by which a bird, often called water-hen and sometimes gallinule, is most commonly known in England. An earlier name was moat-hen, which was appropriate in the days when a moat was the ordinary adjunct of most considerable houses in the country. It is the *Gallinula chloropus* of ornithologists, about the size of a small bantam-hen, but with the body much compressed (as is usual with members of the family *Rallidae*, to which it belongs), its plumage above is of a deep olive-brown, so dark as to appear black at a short distance, and beneath iron-grey, relieved by some white stripes on the flanks, with the lower tail-coverts of pure white—these last being very conspicuous as the bird swims. A scarlet frontlet, especially bright in the spring of the year, and a red garter on the tibia render it very showy. Though often frequenting the neighbourhood of man, the moor-hen seems unable to overcome the inherent stealthy habits of the *Rallidae*, and hastens to hide itself on the least alarm; but under exceptional circumstances it may be induced to feed, yet always suspiciously, with tame ducks and poultry. It appears to take wing with difficulty, and may be often caught by an active dog; but, in reality, it is capable of sustained flight, its longer excursions being chiefly performed by night, when the peculiar call-note it utters is frequently heard as the bird, itself invisible in the darkness, passes overhead. The nest is a mass of flags, reeds, or other aquatic plants, often arranged with much neatness, almost always near the water's edge, where a clump of rushes is generally chosen; but should a mill-dam, sluice-gate, or boat-house afford a favourable site, advantage will be taken of it, and not infrequently the bough of a tree at some height from the ground will furnish the place for a cradle. The eggs, from seven to eleven in number, resemble those of the coot but are smaller, lighter, and brighter in colour, with spots or blotches of reddish-brown. The common moor-hen is extensively spread throughout the Old World, being found also at the Cape of Good Hope, in India and in Japan. In America it is represented by a very closely allied form, *G. galacta*, so called from its rather larger frontal helm, and in Australia by another, *G. tenebrosa*, which generally wants the white flank-markings. Both closely resemble *G. chloropus* in general habits, as does also the *G. pyrrhorhoa* of Madagascar, which has the lower tail-coverts buff instead of white. Celebes and Amboyna possess a smaller cognate species, *G. haematopus*, with red legs; tropical Africa has the smallest of all, *G. angulata*. One of the most remarkable varieties is the *G. nesiotis* of Tristan da Cunha,² which has wholly lost the power of flight.³ Among other forms are the common *Gallinula (Erythra) phoenicea*, and *Gallinula cristata* of India, as well as the South American species classed in the genus *Porphyrio*, and the remarkable Australian genus *Tribonyx* contains three species,⁴ which seem to be more terrestrial than aquatic in their haunts and habits.

Allied to all these is the genus *Porphyrio*, including the bird so named by classical writers, and perhaps a dozen other species often called sultanas and purple water-hens, for they all have a plumage of deep blue—some becoming violet, green, or black in parts, but preserving the white lower tail-coverts, so generally characteristic of the group; and their beauty is enhanced by their scarlet bill and legs. Two, *P. alleni* of the Ethiopian region and the South American *P. parva*, are of small size.

¹ Not to be confounded with "Moor-cock" or "Moor-fowl," names formerly in general use for the red grouse.

² *Proc. Zool. Soc.* (1861), p. 260, pl. xxx.

³ A somewhat intermediate form seems to be presented by the moorhen of the island of St. Denis, to the north of Madagascar (*Proc. Zool. Soc.*, 1867, p. 1036).

⁴ *Ann. Nat. History*, 3rd series, xx. 123.

Of the larger species, *P. caeruleus* is the "Porphyrio" of the ancients, and inhabits certain localities on both sides of the Mediterranean, while the rest are widely dispersed within the tropics, and even beyond them, as in Australia and New Zealand. But this last country has produced a more exaggerated form, *Notornis*, which has an interesting and perhaps unique history. First described from a fossil skull by Sir R. Owen,⁵ and then thought to be extinct, an example was soon after taken alive,⁶ the skin of which (with that of another procured like the first by Walter Mantell) may be seen in the British Museum. Other fossil remains were from time to time noted by Sir R. Owen⁷; but it began to be feared that the bird had ceased to exist,⁸ until a third example was taken about the year 1879, the skin and most of the bones of which, after undergoing examination in New Zealand by Sir W. Buller and T. J. Parker,⁹ found their way to the museum of Dresden, where A. B. Meyer discovered the recent remains to be specifically distinct from the fossil, and while keeping for the latter the name *N. mantelli* gives the former that of *N. hochstetteri*. What seems to have been a third species of *Notornis* formerly inhabited Lord Howe's Island, but is now extinct. Whether the genus *Aphornis*, of which Owen described the remains from New Zealand, was most nearly allied to *Notornis* and *Porphyrio* cannot here be decided. T. J. Parker considers it a "development by degeneration of an ocydromine type." (See *OCYDROME*.) (A. N.)

MOORS (Lat. *Mauri*; Gr. *Μαυροί*, dark men), the name which, as at present used, is loosely applied to any native of Morocco, but in its stricter sense only to the townsmen of mixed descent. In this sense it is also used of the Mahomedan townsmen in the other Barbary states. It has been by some connected with the Hebrew and Phœnician *mahur*, western. Wetstein derives it from *mahir*, a corruption of *Amásir* with its plurals *Imásir* and *Másir*, archaic forms of the Berber native name *Amasigh*, the free. From *Mauri*, the classic name for the north-western African tribes, the north-western districts of that continent came to be called by the Romans Mauretania. The term "Moors" has no real ethnological value. The tribes known to the Romans by that name were undoubtedly of Berber stock (see BERBERS). They first appear in history at the time of the Jugurthine War (110-106 B.C.), when Mauretania west of the Mulucha was under the government of a king called Bocchus, and appears to have constituted a regular and organized state. It retained its independence till the time of Augustus, who in 25 B.C. bestowed the sovereignty of the previously existing kingdom upon Juba II., king of Numidia, at the same time uniting it with the western portion of Numidia, from the Mulucha to the Ampsaga, which received the name of Mauretania Caesariensis, while the province that had previously constituted the kingdom, or Mauretania proper, came to be known as Mauretania Tingitana (see MAURETANIA). With the rest of North Africa Mauretania was overrun by the Arabs in the 7th century. The subsequent conquest of Spain was effected chiefly by Berber tribes, but the Moslems in the peninsula—known to the Christian nations as Moors—always had a strong strain of Arab blood and in most respects became Arabized. The race was also influenced considerably by intermarriage with the natives of Spain, and when the Moors were finally expelled from that country they had become almost entirely distinct from their Berber kinsfolk, to whom they were known as Andalusians. While the mountainous parts of Morocco continued to be occupied by pure Berber people, the Shlùh or Shilluh, the Andalusian Moors flocked to

⁵ *Proc. Zool. Soc.*, 1848, p. 7; *Trans. iii.* 336, pl. lvi.

⁶ *Proc.* 1850, pp. 209-214, pl. xxi.; *Trans. iii.* 69-74, pl. xxv.

⁷ Thus the leg-bones and what appeared to him the sternum were described and figured (*Trans. iv.* pp. 12, 17, pls. ii, iv.), and the pelvis and another femur (vii. pp. 369, 373, pls. xlii., xliii.); but the supposed sternum afterwards proved not to be that of *Notornis*, and Owen (*Proc.* 1882, p. 689) rectified the error, to which his attention had been drawn, and which he had already suspected (*Trans.* viii. 120).

⁸ Notwithstanding the evidence, which presented some incongruities, offered by Mr Mackay (*Ibis*, 1867, p. 144).

⁹ *Trans. N. Zeal. Inst.* xiv. 238-258.

the coast towns and the plains of Morocco, occupied largely by Arabs. The name Moor is however still applied to the populations speaking Arabic who inhabit the country extending from Morocco to the Senegal, and to the Niger as far east as Timbuktu, *i.e.* the western Sahara. In this vast region and in all the towns of Barbary many of the Andalusians settled.

The Moors are ethnically a very hybrid race with more Arab than Berber blood. A common mistake is to regard them as a black race, as indicated by the old English phrase "Black-a-Moor," *i.e.* black as a Moor. They are a white race, though often sunburnt and bronzed for generations, and both their children and those who have lived in the cities might pass anywhere as Europeans.

The typical Moors of Morocco are a handsome race, with skin the colour of coffee-and-milk, with black eyes and black silky hair, and the features of Europeans. They wear a full beard, and are characterized by a marked dignity of demeanour. There is a general tendency to obesity, which is much admired by the Moors in their women, young girls being stuffed like chickens, with paste-balls mixed with honey, or with spoonfuls of olive oil and sesame, to give them the necessary corpulence. The Moors are an intellectual people, courteous in manner and not altogether unlettered; but they are cruel, revengeful and bloodthirsty. Among the pirates who infested the Mediterranean none were worse than the Moors.

They are fanatical Mahomedans, regarding their places of worship as so sacred that the mere approach of a Jew or a Christian is forbidden. The Moors are temperate in their diet and simple in their dress, though among the richer classes of the towns the women cover themselves with silks, gold and jewels, while the men indulge to excess their love of fine horses and splendid arms. The national fault is gross sensuality. The position of women is little better than a pampered slavery. They are uneducated, indolent and vicious. Such education as the children receive is of a superficial kind. Slavery flourishes, and slave auctions, conducted like those of cows and mules, take place on the afternoons of stated days, affording a lounge for the rich Moors, who discuss the "goods" offered and seek for bargains. This public sale of slaves was prohibited in the coast towns, *c.* 1850, under pressure from European powers, but means are found to evade the prohibition.

Of games the young Moors play a great number; the principal one is a kind of football, more like that of Siam and Burma than that of England; wrestling and fencing are popular, but the chief amusement of the adult Moors is the "powder-play" (*Ja'ab el bārād*), which consists of a type of military tournament, the horsemen going through lance and musket exercises or charging in review fashion, firing volleys as they gallop. Other recreations much in favour throughout Morocco are music, singing, jugglery, snake-charming and acrobatic performances. As professional story-tellers many Moors are remarkable, but the national music is monotonous and not very harmonious.

See Dr Arthur Leared, *Morocco and the Moors* (1891); Budget Meakin, *The Moorish Empire* (1899); *The Moors* (1902); Frances Macnab, *A Ride in Morocco* (1902); and see under MOROCCO; MAURETANIA; BERBERS, &c.

MOOSE, the North American Indian (Algonquian) name of the North American representative of the European elk (*q.v.*). The word is said to mean "cropper" or "trimmer," from the animal's habit of feeding on the branches of trees.

MOOT, a meeting or assembly, in O. Eng. *mōt*, *gemōt*, a word of which "to meet" is a derivative. "Moot" or its alternative form "mote" is the common term for the assemblies of the people of the hundred, burgh, &c., in the history of early English institutions, and especially for the national assembly or council, the Witenagemot. The name survives in "moot hall," the term still given to town-halls and council buildings in some towns in England, as at Aldeburgh. From its meaning of assembly, the word was applied to a debate or discussion, especially of the discussion of a hypothetical case by law students at the Inns of Court. These moots are still carried on at Gray's Inn. As an adjective, "moot" means doubtful, undecided.

MOP, a piece of cloth, rags or coarse yarn, fastened to a pole and serving as a broom or brush for swabbing up wet floors or other surfaces and for cleaning generally. The word is usually taken to be an adaptation of Lat. *mappa*, cloth, napkin, *cf.* "map." A particular application of the term in provincial English is to an annual hiring or statute-fair, a "mop-fair," at which domestic and agricultural servants out of places attended, carrying a broom, a mop or other implement indicative of their calling.

MOPLAH (Malayalam *moppila*), a fanatical Mahomedan sect found in Malabar. The Moplahs, who number upwards of a million, are believed to be descended from Arab immigrants, who landed on the western coast of India in the 3rd century after the Hegira. They are remarkable for the fanaticism displayed in successive attacks upon the Hindus, and they have several times resisted British troops. A regiment of the Indian army was recruited among them, but the experiment proved a failure, and the Moplah Rifles were disbanded in April 1907.

MOPSIUS, in Greek legend, the name of two seers. (1) Son of Amphyx (or Ampycus) and the nymph Chloris, a Lapith of Oechalia in Thessaly. He took part in the Calydonian boar hunt and accompanied the Argonauts as their prophet. He died from the bite of a serpent which sprang from the blood of the Gorgon Medusa. He is represented on the chest of Cypselus as boxing with Admetus. He was afterwards worshipped as a hero and an oracle was consecrated to him. (2) Son of Rhacius (or Apollo) and Manto, daughter of Teiresias. The rival seer Calchas is said to have died of chagrin because the predictions of Mopsus were fulfilled, while his own proved incorrect. Together with another seer, Amphilochous, Mopsus founded Mallus in Cilicia after the return from Troy; and in a quarrel for its possession both lost their lives. According to Pausanias (*vii.* 3, 2) Mopsus expelled the native inhabitants of Caria, and built the town of Colophon. Mopsus was worshipped as a god by the Cilicians, and had two famous oracles at Colophon and Mallus. His name survives in the town of Mopsuestia (*Μόψου Έστρία*) and the spring of Mopsucene. Mopsus appears to be the incarnation of Apollo of Claros.

MOQUEGUA, a maritime province of southern Peru, bounded N. by the departments of Arequipa and Puno, and S. by the republic of Chile. Area, 5550 sq. m.; pop. (1906 estimate), 31,920. The province extends from the Pacific coast eastward to the Cordillera Occidental, which forms the boundary line with Puno and the Republic of Bolivia. Eastern Moquegua is volcanic, and is broken by the high range that forms the western rim of the Titicaca basin. Among the volcanoes in the province are Tutupacu, the last eruption of which occurred in 1802, Huaynaputina and Hachalayhua, which were in violent eruption in 1606, Copuna, Omate, Ubinas and Candarave—the last three still showing signs of activity. This region is also subject to severe earthquake shocks. On the lower slopes of the Cordillera there are fertile irrigated valleys which produce grapes and olives for commercial purposes, and a considerable variety of fruits, cereals and vegetables for local consumption. The best-known grape-producing districts are Moquegua (capital) and Locumba—the product being converted into wine and brandy for export. The capital is Moquegua (pop. about 5000 in 1906), in the upper valley of the Ilo River, 4500 ft. above sea-level, and 65 m. by rail from the small port of Ilo on the Pacific coast.

Moquegua was formerly one of the three provinces forming a department of the same name. The other two provinces (Tacna and Arica) were held for indemnity by Chile after the war of 1879-1883 with the understanding (treaty of Ancon, March 8, 1884) that at the expiration of ten years a *plébiscite* should be taken in the two provinces to determine whether they should remain with Chile, or return to Peru—the country to which they should be annexed to pay the other 10,000,000 pesos. Chile did not comply with this treaty agreement, and in 1910 still held both provinces.

MORA, JOSÉ (1638-1725), Spanish sculptor, was a pupil of Alonso Cano. He died in Granada in 1725 and was buried in

the Albaicin church. His work can be usefully studied in the eight statues in the Capella del Cardenal in the Cordova Cathedral and in the figures of St Bruno and St Joseph in the Cartuja near Granada.

See B. Haendeke, *Studien zur Geschichte der spanischen Plastik* (Strassburg, 1900).

MORA, or **MORRA** (Ital. *delay*), a game, universally popular in Italy, in which one player endeavours to guess instantly the number of fingers held up by the other. Ancient Egyptian sculptors represent a game of this kind, and it was played by the Romans, who called it *micare digitis*, or finger-flashing. It is known to the Chinese and to certain tribes of the Pacific Islands. There are several methods of playing mora, but in the one most common in Italy the two players, placed face to face, throw out at the same instant one or more fingers of one hand, each crying out simultaneously a number guessed to be that of his adversary's exposed fingers. A correct guess counts one; if both guess correctly or wrongly there is no score. The game, which is generally five or nine points, is played for stakes, and with extraordinary swiftness.

MORACEAE, in botany, an order of dicotyledons, belonging to the series *Urticiflorae*, to which belongs also the nettle family (*Urticaceae*, *q.v.*). It contains about 60 genera with about 1000 species, mostly trees or shrubs, widely distributed in the

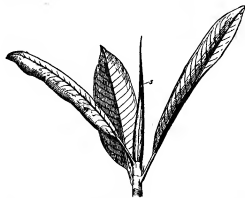

Fig (*Ficus carica*), Shoot bearing Leaves and Fruit.

1, Inflorescence cut lengthwise to show the numerous flowers crowded on the inner surface. 2, A female flower, enlarged. 3, Fruit cut lengthwise.

warmer parts of the earth. The largest genus, *Ficus* (the fig, *q.v.*), contains 600 species spread through tropical and sub-tropical regions, and includes the common fig of the Mediterranean region (*Ficus carica*), the banyan (*F. bengalensis*), and the india-rubber plant (*F. elastica*); many of the species are epiphytic, sometimes clinging so tightly round the host-plant with their roots as to strangle it. *Morus* (mulberry, *q.v.*) contains ten species of trees or bushes in north temperate regions and in the mountains of the tropics. *Artocarpus*, including *A. incisa* (bread-fruit, *q.v.*), and *A. integrifolia* (jack-tree), has forty species, chiefly natives in the Indian Archipelago. The plants are rich in latex which may be very poisonous as in *Antiaris toxicaria*, the Upas-tree (*q.v.*) of Java, or sweet and nutritious as in *Brosimum galactodendron*, the cow-tree (*q.v.*) of Venezuela. The latex

often yields caoutchouc as in species of *Ficus* (e.g. *F. elastica*), *Cecropia* (*q.v.*), a tropical American genus with thirty to forty species, and others.



End of Shoot showing Stipule, *s*, of India-rubber Plant (*Ficus elastica*).

The leaves, which are entire or more or less divided, are stipulate, the stipules being small and lateral as in *Morus* and allied general or intrapetiolar, each pair uniting to form a cap round the younger leaves, as in *Ficus* and allied genera, and very well shown in *F. elastica*, the common india-rubber plant of greenhouses. The plants are monoecious or dioecious, and the small unisexual flowers are borne in cymose inflorescences which are condensed into apparent racemes, spikes or heads. In the fig they coalesce to form a fleshy hollow axis on the inner face of which the flowers are situated, while in *Dorstenia* they form a flat, often lobed, expansion with the flowers sunk on the upper face. The flower resembles



Mulberry (*Morus nigra*), Shoot bearing Leaves and Fruit.

1, Catkin of male flowers. 2, One male flower. 3, Spike of female flowers. 4, Single female flower.

that of *Urticaceae*; there are generally four free or more or less united perianth leaves, with, in the male flower, a stamen opposite each perianth leaf; the filaments are incurved in the mulberry and allied genera and straight in the fig and its allies. *Artocarpus* has only one stamen. The female flower contains two carpels in the median plane, the posterior one of which is often more or less aborted. Each developed ovary chamber contains a solitary pendulous more or less curved ovule. The fruit is an achene or drupe, often surrounded by the fleshy perianth and still further complicated by the union of fruits of different flowers as in mulberry, the development of a fleshy receptacle as in fig, or as in *Artocarpus* (bread-fruit), by the union of fruits, perianth and axis into a solid fleshy mass. The embryo is generally curved and surrounded by a fleshy endosperm.

From the evidence of leaf-fossils it is probable that the genus *Ficus* existed as far north as Greenland in the Cretaceous era and was generally distributed in North America and Europe in the Tertiary period up to miocene times.

MORADABAD, a city and district of British India, in the Bareilly division of the United Provinces. The city is on the

right bank of the river Ramganga, 655 ft. above sea-level, and has a station on the Oudh & Rohilkhand railway, 868 miles from Calcutta. Pop. (1901), 75,128. It was founded in 1625 by Rustam Khan, who built the fort which overhangs the river bank, and the fine Jama Masjid or great mosque (1631). The town forms a large centre of trade in country produce. It has a special industry in ornamental brassware, sometimes plated with lac or tin, which is then engraved. Cotton weaving and printing is also carried on.

The DISTRICT OF MORADABAD lies east of the Ganges and west of the native state of Rampur. Area, 2285 sq. m. It lies within the great Gangetic plain, and is demarcated into three subdivisions by the rivers Ramganga and Sot. The eastern tract consists of a submontane country, with an elevation slightly greater than the plain below, and is traversed by numerous streams descending from the Himalayas. The central portion consists of a level central plain descending at each end into the valleys of the Ramganga and Sot. The western section has a gentle slope towards the Ganges, with a rapid dip into the lowlands a few miles from the bank of the great river. In addition to Moradabad the principal towns are Amroha (q.v.), Sambhal (39,715) and Chaudansi (25,711).

For the early history of Moradabad see BAREILLY. It passed into the possession of the British in 1801. The population in 1901 was 1,191,993, showing an increase of 1.1% in the decade. Mahomedans are more numerous than in any other district of the province, forming more than one-third of the total. The principal crops are wheat, rice, millet, pulse, sugar-cane and cotton. The main line of the Oudh & Rohilkhand railway traverses the district from south to north, with branches towards Aligarh and Rampur. A third branch from Moradabad city towards Delhi crosses the Ganges at Garhmukhteshwar by a bridge of eleven spans of 200 ft. each.

MORAES, FRANCISCO DE (c. 1500-1572), Portuguese romance writer, was probably born at the close of the 15th century. We know very little of his life, except that he was treasurer of the household to King John III., and he is first found in Paris in the suite of the Portuguese ambassador, D. Francisco de Noronha, who had gone there in 1540. He was a commander of the Order of Christ, and was called *O Palmeirim* on account of his authorship of the famous romance of chivalry *Palmeirim de Inglaterra*; in 1572 he was assassinated at Evora. He appears to have written his book in France (perhaps in Paris) in 1544, dedicating it to the Infanta D. Maria, daughter of King Manoel, but the first extant Portuguese edition only came out in 1567. A Spanish version was published as early as 1548, and on the strength of this many critics have contended that the book was originally written in that language and that Moraes only translated it into Portuguese. Both tradition and a critical examination of the Portuguese and Spanish texts, however, tell overwhelmingly in favour of the first being the original with Moraes as its author. The episode of the four French ladies shows an intimate acquaintance with the court of Francis I., where Moraes spent some years, and one of these ladies named Torsi is the one he loved and to whom he addressed some verses entitled "Desculpa de huns amores." The *Palmeirim de Inglaterra* belongs to another branch of the same cycle as the *Amadis de Gaula*; the two romances are the best representatives of their class, and for their merits were spared from the *auto da fé* to which Cervantes condemned other romances of chivalry in *D. Quixote*. It has a well-marked plot, clearly drawn characters, and an admirable style, and has been reckoned a Portuguese classic from the time of its issue.

BIBLIOGRAPHY.—The *Palmeirim de England*, by W. E. Purser (Dublin, 1904). Contains an exhaustive study of the romance and the controversy concerning its authorship, with a sketch of the plot. The existing Portuguese editions bear the dates 1567, 1592, 1786 and 1852, while translations exist in Spanish, Italian and French. An English version from the French by A. Munday was first published in 1609. In 1807 Robert Southey issued in 4 vols. 4to an incomplete translation from the Portuguese which is really a revision of Munday. In addition Moraes wrote some *Dialogues*, which were published at Evora in 1624, and are incorporated in the last two editions of *Palmeirim de Inglaterra*. (E. Pr.)

MORAINE, a term adopted from the French for the rocky material carried downwards on the outside of a glacier, and deposited at its sides and foot. The position of the moraine with regard to the glacier is indicated by the names applied to it. The *lateral moraine* is the fringe of rock fragments at the glacier side. The glacier is always slowly moving down the valley. There are always points in the valley where rock falls are more frequent than in other places. The glacier as it moves forward catches this material and carries it onward in a long heaped line distributing it evenly all down the valley sides. When two glacial valleys converge into one valley two lateral moraines unite at the point of junction and form a *median moraine* in the resultant broader glacier, which now has two lateral moraines and one median. All this material carried by the glacier is deposited where the glacier ends, and forms the *terminal moraine*, frequently in the form of a crescentic dam across the valley. This material is carried farther downwards by stream action and distributed; otherwise the end of all glacial valleys would be blocked with debris against which the ice would be piled to a great height, and the glacier would finally become stationary. The material pushed forward beneath the glacier is sometimes called the *ground moraine*, the part left beneath the ice the *ledge moraine*, that carried to the edge and dropped the *dump moraine*, and that carried forward the *push moraine*. (See GLACIER.)

MORAN, EDWARD (1829-1901), American artist, was born at Bolton, Lancashire, England, on the 10th of August 1829. He emigrated with his family to America at the age of fifteen, and subsequently settled in Philadelphia, where after having followed his father's trade of weaver, he became a pupil of James Hamilton and Paul Weber. In 1862 he became a pupil of the Royal Academy in London; he established a studio in New York in 1872, and for many years after 1877 lived in Paris. He was a painter of marine subjects and examples of his work are in many prominent collections. Among his canvases are thirteen historical paintings, intended to illustrate the marine history of America from the time of Leif Ericsson to the return of Admiral Dewey's fleet from the Philippines in 1899. He died in New York City on the 9th of June 1901. His sons (Edward) Percy Moran (b. 1862) and Léon Moran (b. 1864), and his brothers Peter Moran (b. 1842) and Thomas Moran (q.v.), also became prominent American artists.

MORAN, THOMAS (1837-), American artist, was born at Bolton, Lancashire, England, on the 12th of January 1837, and emigrated with his parents to America in 1844, the family settling in Philadelphia. After having been apprenticed for some years to a wood-engraver, he studied under his brother Edward and under James Hamilton, in Philadelphia, and later studied in London, Paris and Italy. In 1871 he accompanied Professor F. V. Hayden's exploring expedition to the Yellowstone, and in 1873 he went down the Colorado with Major J. W. Powell's famous exploring party; and on these two trips he made sketches for two large pictures, "The Grand Cañon of the Yellowstone" and "Chasm of the Colorado River," both of which were bought by the United States government and are now in the Capitol at Washington. He became a member of the National Academy of Design in 1884 and of the American Water Color Society. His wife, Mary Nimmo Moran (1842-1899), who was born in Strathaven, Scotland, and emigrated to America in 1852, was also an artist, and was particularly prominent as an etcher.

MORAR, a town of Central India, in the native state of Gwalior, 3 m. E. of Gwalior city. Pop. (1901), 19,179. It was formerly a British military cantonment and residence of a political agent, but in 1886, when the fortress of Gwalior was restored to Sindhia, the troops at Morar were withdrawn to Jhansi, and the extensive barracks were likewise made over to Sindhia. In the Mutiny of 1857 Morar was the scene of the most serious uprising in Central India. It is a centre for local trade, and has an important tanning industry.

MORAT (Ger. *Murten*), a small town on the east shore of the Lake of Morat, in the Swiss canton of Fribourg, and by rail

14 m. N. of Fribourg or 18½ m. W. of Bern. In 1900 its population was 2263, of whom 1840 were German-speaking and 1966 were Protestants. It is a most picturesque little town, overlooked by the 13th-century castle and the quaint tower of the *Rathhaus*, while it is still surrounded by its 15th century walls that are studded at intervals with watch towers. In 1264 it exchanged its position as a free imperial city (enjoyed since 1218) for the rule of the count of Savoy. In 1475 it was taken by the Swiss at the commencement of their war with Charles the Bold, duke of Burgundy, whose ally was the duchess of Savoy. But in 1476 it was besieged by Charles, though it held out till the Swiss army arrived in haste and utterly defeated (22nd June) the Burgundians. An obelisk a little way southwest of the town stands on the site of the bone-house (destroyed by the French in 1798, wherein the remains of many victims had been collected. Morat was ruled in common from 1475 to 1798 by Bern and Fribourg, being finally annexed to Fribourg in 1814. The Lake of Morat has an area of 10½ sq. m., and is connected with that of Neuchâtel by way of the Broye canal. On its shores many lake dwellings have been found.

See F. L. Engelhard, *Der Stadt Murten Chronik* (Bern, 1828); G. F. Ochsenein, *Die Urkunden der Belagerung u. Schlacht von Murten* (Freiburg, 1876); H. Wattelet, *Die Schlacht bei Murten* (Fribourg, 1894). (W. A. B. C.)

MORATA, OLYMPIA FULVIA (1526–1555), Italian classical scholar, was born at Ferrara. Her father, who had been tutor to the young princes of the ducal house of Este, was on intimate terms with the most learned men of Italy, and the daughter grew up in an atmosphere of classical learning. At the age of twelve she was able to converse fluently in Greek and Latin. About this time she was summoned to the palace as companion and instructress of the younger but equally gifted Anne, daughter of Renée, duchess of Ferrara. Olympia's father having died a convert to Protestantism, she met with a cold reception at the palace, and withdrew to her mother's house. Olympia now embraced the doctrines of Luther and Calvin. About the end of 1550 she married a young student of medicine and philosophy, Andrew Grunthler of Schweinfurt in Bavaria. In 1554 she accompanied Grunthler to his native place, where he had been appointed physician to the garrison of Spanish troops. In 1553 the margrave Albert of Brandenburg on one of his plundering expeditions took possession of Schweinfurt, and was in turn besieged by the Protestants. At length Albert evacuated the place, and Olympia and her husband made their escape. They finally succeeded in reaching Heidelberg (1554), where a medical lectureship had been obtained for Grunthler through the influence of the Erbach family, by whom they had been hospitably entertained during their flight. Here she died on the 25th of October in the following year.

BIOGRAPHY.—The scanty remains of her works—letters, dialogues, Greek verses—were collected and published by Celio Secondo Curione (1558). Monographs by Caroline Bowles, wife of Robert Southey the poet (1834), J. Bonnet (1850; Eng. trans., Edinburgh, 1854), and R. Turnbull (Boston, 1846); see also Caroline Geary, *Daughters of Italy* (1886).

MORATALLA, a town of eastern Spain, in the province of Murcia, 40 m. W.N.W. of the city of Murcia. Pop. (1900), 12,689. Moratalla is built on a mountainous peninsula, almost surrounded by the Grande and Benamor, small rivers which meet and flow eastward to join the Segura. The town is a labyrinth of narrow, crooked streets, and some of its houses are Moorish in character. Its chief buildings are the modern hospital and theatre, and the 17th-century church. It has manufactures of coarse cloth, spirits and soap. The nearest railway station is Calasparra, 6 m. east, on the Murcia-Albacete railway.

MORATÍN, LEANDRO ANTONIO EULOGIO MELITÓN FERNANDEZ DE (1760–1828), Spanish dramatist and poet, the son of N. F. de Moratín, was born at Madrid on the 10th of March 1760. Though his poetical tastes were early developed, his father apprenticed him to a jeweller. At the age of eighteen Moratín won the second prize of the Academy for a heroic poem on the conquest of Granada, and two years afterwards he attracted more general attention with his *Lección política*, a satire upon

the popular poets of the day. He was appointed secretary to Cabarrús on a special mission to France in 1787. On his return to Spain, Moratín was tonsured and presented to a sinecure benefice in the diocese of Burgos, and in 1786 his first play, *El Viejo y la niña*, was produced at the Teatro del Príncipe. Owing to the opposition of the clerical party, it was speedily withdrawn. The prose comedy, *El Café ó la comedia nueva*, given at the same theatre six years afterwards, at once became popular. On the fall of Florida Blanca, Moratín found another patron in Godoy, who provided him with a pension and the means for foreign travel; he accordingly visited England, where he began a prose translation of *Hamlet*, printed in 1798 but never performed. From England he passed to the Low Countries, Germany, Switzerland and Italy, and on his return to the Peninsula in 1796 was appointed official translator to the foreign office. In 1803 he produced *El Barón* in its present form; originally written (1791) as a *zarzuela*, it was shamelessly plagiarized by Andrés de Mendoza, but the recast, a far more brilliant work, still keeps the stage. It was followed in 1804 by *La Mogigata*, written between 1797 and 1803. This piece was favourably received, and an attempt to suppress it on religious grounds failed. Moratín's crowning triumph in original comedy was *El St de las Niñas* (1806), which was performed night after night to crowded houses, ran through several Spanish editions in a year, and was soon translated into a number of foreign languages. In 1808 Moratín was involved in the fall of Godoy, but in 1811 accepted the office of royal librarian under Joseph Bonaparte—a false step, which alienated from him all sympathy and compelled him to spend his last years in exile. In 1812 his *Escuela de los maridos*, a translation of Molière's *École des maris*, was produced at Madrid, and in 1813 *El Médico ó Palos* (a translation of *Le Médecin malgré lui*) at Barcelona. From 1814 to 1828 Moratín lived in Italy and France, compiling a work on the early Spanish drama (*Orígenes del teatro español*). He died at Paris on the 21st of June 1828.

The most convenient edition of his works is that given in vol. ii. of the *Biblioteca de autores españoles*; this is supplemented by the *Obras póstumas* (3 vols., Madrid, 1867–1868).

MORATÍN, NICOLÁS FERNANDEZ DE (1737–1780), Spanish poet and dramatist, was born at Madrid in 1737. He was educated at the Jesuit College in Calatayud and afterwards studied law at the university of Valladolid. In 1772 he was called to the bar; four years afterwards he was nominated to the chair of poetry at the imperial college. He died on the 11th of May 1780. A partisan of French methods, Moratín published in 1762 his *Desengaño al teatro español*, a severe criticism of the national drama, particularly of the *auto sacramental*; and his protests were partly responsible for the prohibition of *autos* three years afterwards (June 1765). In 1762 he also published a play entitled *La Petimetra*. Neither the *Petimetra* nor the *Lucrecia* (1763), an original tragedy still more strictly in accordance with French conventions, was represented on the stage, and two subsequent tragedies, *Hormesinda* (1770) and *Guzmán el Bueno* (1777), were played with no great success. In 1764 Moratín published a collection of pieces, chiefly lyrical, under the title of *El Poeta*, and in 1765 a short didactic poem on the chase (*Diana ó arte de la caza*). His "epic canto" on the destruction of his ships by Cortés (*Las Naves de Cortés destruidas*) failed to win a prize offered by the Academy in 1777, and was published posthumously (1785). But a better idea of Moratín's talent is afforded by his anacreontic verses and by his *Carta histórica sobre el origen y progresos de las fiestas de toros en España*.

His works are included in the *Biblioteca de autores españoles*, vol. ii.

MORATORIUM (from Lat. *morari*, to delay), a term used to express a legal authorization postponing for a specified time the payment of debts or obligations. The term is also sometimes used to mean the period over which the indulgence or period of grace stretches, the authorization itself being called a moratory law. A moratory law is usually passed in some special period of political or commercial stress; for instance, on several occasions during the Franco-German War the French government passed

moratory laws. Their international validity was discussed at length and upheld in *Rosquette v. Oerzman*, 1875, L. R. 10 Q. B. 525.

MORAVIA (Ger., *Mähren*; Czech, *Morava*), a margraviate and crownland of Austria, bounded E. by Hungary, S. by Lower Austria, W. by Bohemia and N. by Prussian and Austrian Silesia. Area, 8,583 sq. m. Physically Moravia may be described as a mountainous plateau sloping from north to south, just in the opposite direction of the adjoining Bohemia plateau, which descends from south to north, and bordered on three sides by mountain ranges. On the north are the Sudetes, namely the Altvater Gebirge, with the highest peaks the Grosse Schneeberg (4,664 ft.) and the Altvater (4,887 ft.), which sink gradually towards the west, where the valley of the Oder forms a break between the German mountains and the Carpathians. The latter separate Moravia from Hungary. Parallel to the Carpathians are the Marsebirge (1,915 ft.) and its continuation, the Steinitzer Wald (1,450 ft.). On the west are the so-called Bohemian-Moravian Mountains, forming the elevated east margin of Bohemia. The principal passes are those at Iglau and Zwittau to Bohemia and the Wlra Pass to Hungary. Almost the whole of Moravia belongs to the basin of the March or Morava, from which it derives its name and which rises within its territory in the Sudetes. It traverses the whole country in a course of 140 m., and enters the Danube near Pressburg. Its principal tributaries are the Thaya, the Hanna, the Iglawa with the Zwittawa and the Schwarzawa, &c. The Oder also rises among the mountains in the north-east of Moravia, but soon turns to the north and quits the country. With the exception of a stretch of the March, none of the rivers are navigable. Amongst the mineral springs worth mentioning are the sulphur springs at Ullersdorf, the saline ones at Luhatschowitz and the alkaline springs at Töplitz.

Owing to the configuration of the soil, the climate of Moravia varies more than might be expected in so small an area, so that, while the vine and maize are cultivated successfully in the southern plains, the weather in the mountainous districts is somewhat rigorous. The mean annual temperature at Brünn is 48° F. Of the total area 54.8% is occupied by arable land, 7% by meadows, 5.7% by pasturages, 1.2% by gardens, 0.5% by vineyards, while 27.4% are forests. The principal products are corn, oats, barley, potatoes, rye, beetroot, hemp, flax, hay and other fodder. Forestry is greatly developed; the breed of sheep in the Carpathians is of an improved quality, and the horses bred in the plain of the Hanna are highly esteemed. The mineral wealth of Moravia, consisting chiefly of coal and iron, is very considerable. Coals are extracted at Neudorf, Lešitz, Ratiškovitz and Čeč; lignite at Rossitz, Oslavan and Mährisch-Ostrau. Iron-ore is found at Zöptau, Blansko, Adamsthal, Witkowitz, Rossitz and Stefanau. Other minerals found here are graphite, alum, potter's clay and roofing-slate, and, besides, famous silver-mines were worked at Iglau during the middle ages. From an industrial point of view Moravia belongs to the foremost provinces of the Austrian Empire. The principal manufactures are woollen, linen, cotton, cast-iron goods, beet-sugar, leather and brandy. The cloth industry was introduced in the 14th century at Iglau, where it soon obtained a great reputation; it developed afterwards at Olmütz, and since the middle of the 18th century it has its principal centre at Brünn. The linen industry is concentrated at Schönberg, Mistek, Wiesenberg and Heidenpilsitz; while the cotton industry has its principal seat at Sternberg. The chief iron-foundries are to be found at Witkowitz, Stefanau, Zöptau and Rossitz; while industrial machines are manufactured at Brünn, Blansko and Adamsthal. Large works of earthenware are established at Znaim and Frain.

Moravia had in 1900 a population of 2,435,081 inhabitants, which is equivalent to 284 inhabitants per sq. m. It belongs to the group of old Slavonic states which have preserved their nationality while losing their political independence. Of the total population 71.36% were Slavs, who were scarcely distinguishable from their Bohemian neighbours. The name of Czech, however, is usually reserved for the Bohemians, while

the Slavs of Moravia and West Hungary are called Moravians and Slovacs. The Germans form 27.9% of the population, and are found mostly in the towns and in the border districts. Fully 95% of the inhabitants are Roman Catholics, under the ecclesiastical jurisdiction of the archbishop of Olmütz and the bishop of Brünn; 2.7% Protestants and 2% Jews. In educational matters Moravia compares favourably with most of the Austrian provinces. It is well provided with schools of every description, and the number of illiterates is steadily decreasing. The local diet is composed of 100 members, of which the archbishop of Olmütz and the bishop of Brünn are members *ex officio*. To the Reichsrat at Vienna Moravia sends 36 members. For administrative purposes Moravia is divided into 34 districts and 6 towns, with autonomous municipalities: Brünn (pop., 108,944), the capital, Iglau (24,387), Olmütz (21,933), Znaim (16,261), Krensim (13,991) and Ungarisch-Hradisch (5,137). Other principal towns are Königfeld (11,022), Göding (10,231), Mährisch-Ostrau (30,125), Witkowitz (19,128), Mährisch-Schönberg (11,636), Zwittau (9,063), Neutitschein (11,891), Prrau (16,738), Prossnitz (24,054), Sternberg (15,195) and Trebitsch (10,507).

History.—At the earliest period of which we have any record Moravia was occupied by the Boii, the Celtic race which has perpetuated its name in Bohemia. Afterwards it was inhabited by the Germanic Quadi, who accompanied the Vandals in their westward migration; and they were replaced in the 5th century by the Rugii and Heruli. The latter tribes were succeeded about the year 550 A.D. by the Lombards; and these in their turn were soon forced to retire before an overwhelming invasion of Slavs, who on their settlement there took the name of Moravians (German, *Mehranen* or *Mähren*) from the river Morava. These new colonists became the permanent inhabitants of this district, and in spite of the hostility of the Avars on the east founded the kingdom of Great Moravia, which was considerably more extensive than the province now bearing the name. Towards the end of the 8th century they aided Charlemagne in putting an end to the Avar kingdom, and were rewarded by receiving part of it, corresponding to North Hungary, as a fief of the German emperor, whose supremacy they also acknowledged more or less for their other possessions. After the death of Charlemagne the Moravian princes took advantage of the dissensions of his successors to enlarge their territories and assert their independence, and Rastislav (c. 850) even formed an alliance with the Bulgarians and the Byzantine emperor. The chief result of the alliance with the latter was the conversion of the Moravians to Christianity by two Greek monks, Cyril and Methodius, despatched from Constantinople (863). Rastislav finally fell into the hands of Louis the German, who blinded him, and forced him to end his days as a monk; but his successor, Svatopluk (d. 894), was equally vigorous, and extended the kingdom of Great Moravia to the Oder on the west and the Gran on the east. At this period there seemed a strong probability of the junction of the north-western and south-eastern Slavs, and the formation of a great Slavonic power to east of the German empire. This prospect, however, was dissipated by the invasions of the Magyar hordes in the 10th century, the brunt of which was borne by Moravia. The invaders were encouraged by the German monarchs and aided by the dissensions and mismanagement of the successors of Svatopluk, and in a short time completely subdued the eastern part of Great Moravia. The name of Moravia was henceforth confined to the district to which it now applies. For about a century the possession of this marchland was disputed by Hungary, Poland and Bohemia, but in 1029 it was finally incorporated with Bohemia, and so became an integral part of the German empire. Towards the close of the 11th century Moravia was raised to the dignity of a margraviate, but with the proviso that it should be held as a fief of the crown of Bohemia. It henceforth shared the fortunes of this country, and was usually assigned as an appanage to younger members of the Bohemian royal house. In 1410 Jobst, margrave of Moravia, was made emperor of Germany, but died a few months after his election. In 1526, on the death of Louis II. of Hungary Moravia came with the rest

of that prince's possessions into the hands of the Austrian house. During the Thirty Years' War the depopulation of Moravia was so great that after the peace of Westphalia the states-general published an edict giving every man permission to take two wives, in order to "repeople the country." After the Seven Years' War Moravia was united in one province with the remnant of Silesia, but in 1849 it was made a separate and independent crownland. The most noticeable feature of recent Moravian history has been the active sympathy of its inhabitants with the anti-Teutonic home-rule agitation of the Bohemian Czechs.

See *Die Länder Oesterreich-Ungarns in Wort und Bild*, vol. 8 (Vienna, 1881-1880, 15 vols.); *Die österreichisch-ungarische Monarchie in Wort und Bild*, vol. 17 (Vienna, 1886-1902, 24 vols.); B. Bretholz, *Geschichte Mährens* (Brünn, 1893, &c.).

MORAVIAN BRETHREN, or **MORAVIAN CHURCH**, a Christian communion founded in the east of Bohemia. For some years after the death of John Huss (1415), the majority of his followers were split into two contending factions: the Hussite Wars began; and the net result of the conflict seemed to be that while the Utraquists, content with the grant of the cup to the laity, were recognized by the pope as the national Church of Bohemia (1433), the more radical Taborites were defeated at the battle of Lipan (1434) and ceased to exist. But with this result some of Huss's followers, who wished to preserve his spiritual teaching, were not content. They laid great stress on purity of morals; and convinced that the Utraquist Church was morally corrupt, they founded a number of independent societies, first at Kremsir and Meseritsch in Moravia, and then at Wilenow, Divischau and Chelcic in Bohemia. At this crisis Peter of Chelcic became the leader of the advanced reforming party. In ethics he anticipated much of the teaching of Tolstoy; in doctrine he often appealed to the authority of Wycliffe; and in some of his views it is possible to trace the influence of the Waldenses. He interpreted the Sermon on the Mount literally, denounced war and oaths, opposed the union of Church and State, and declared that the duty of all true Christians was to break away from the national Church and return to the simple teaching of Christ and His apostles. His followers were known as the Brethren of Chelcic, and wore a distinctive dress. His most noted supporter was John Rockycana, archbishop-elect of Prague. He was pastor of the Thein Church (1444), preached Peter's doctrines, recommended his works to his hearers, and finally, when these hearers asked him to lead them, he laid their case before King George Podiebrad, and obtained permission for them to settle in the deserted village of Kunwald, in the barony of Senftenberg. It was here that the new community was founded (1457 or 1458). At their head was Gregory, the patriarch; a layman, said later to be Rockycana's nephew; in Michael Bradacius, the priest of Senftenberg, they found a spiritual teacher; and fresh recruits came streaming in, not only from the other little societies at Kremsir, Meseritsch, Chelcic, Wilenow and Divischau, but also from the Waldenses, the Adamites, the Utraquist Church at Königgratz, and the university of Prague. They called themselves *Jednota Bratrska*, i.e. the Church or Communion of Brethren; and this is really the correct translation of their later term, *Unitas fratrum*. At the Synod of Lhota (1467), they broke away entirely from the papacy, elected ministers of their own, and had Michael Bradacius consecrated a bishop by Stephan, a bishop of the Waldenses. At the synod of Reichenau (1495), they rejected the authority of Peter of Chelcic, and accepted the Bible as their only standard of faith and practice. In doctrine they were generally broad and radical. They taught the Apostles' Creed, rejected Purgatory, the worship of saints and the authority of the Catholic Church, practised infant baptism and confirmation, held a view on the Sacrament similar to that of Zwingli, and, differing somewhat from Luther in their doctrine of justification by faith, declared that true faith was "to know God, to love Him, to do His commandments, and to submit to His will." With the Brethren, however, the chief stress was laid, not on doctrine, but on conduct. For this purpose they instituted a severe system of discipline, divided their members into three classes—the Perfect,

the Proficient, and the Beginners, and appointed over each congregation a body of lay elders. For the same purpose they made great use of the press. In 1501 Bishop Luke of Prague edited the first Protestant hymn-book; in 1502 he issued a catechism, which circulated in Switzerland and Germany and fired the catechetical zeal of Luther; in 1565 John Blahoslav translated the New Testament into Bohemian; in 1579-1593 the Old Testament was added; and the whole, known as the *Kralitz Bible*, is used in Bohemia still. The constitution was practically Presbyterian. At the head of the Church was a body of ten elders, elected by the synod; this synod consisted of all the ministers, and acted as the supreme legislative authority; and the bishops ruled in their respective dioceses, and had a share in the general oversight. The growth of the Brethren was rapid. In 1549 they spread into Great Poland; in the latter half of the century they opened many voluntary schools, and were joined by many of the nobility; and the result was that by 1600, when Rudolph II. granted the *Letter of Majesty*, they were half the Protestants in Bohemia and more than half in Moravia.

At the very height of their power, however, they were almost crushed out of existence. The cause was the outbreak of the Thirty Years' War (1618). At the battle of the White Hill (1620) the Bohemian Protestants were routed; the Brethren were driven from their homes; the Polish branch was absorbed in the Reformed Church of Poland; and then many fled, some to England, some to Saxony, and some even to Texas. For a hundred years the Brethren were almost extinct. But their bishop, John Amos Comenius (1592-1672), held them together. With an eye to the future, he published their *Ratio disciplinæ*, collected money for the "Hidden Seed" still worshipping in secret in Moravia, and had his son-in-law, Peter Jablonsky, consecrated a bishop, and Peter passed on the succession to his son Daniel Ernest Jablonsky.

The revival of the Moravian Brethren was German in origin. Of the "Hidden Seed" the greater number were Germans; they were probably descended from a colony of German Waldenses, who had come to Moravia in 1480 and joined the Church of the Brethren; and, therefore, when persecution broke out afresh they naturally fled to the nearest German refuge. With Christian David, a carpenter, at their head, they crossed the border into Saxony, settled down near Count Zinzendorf's estate at Berthelsdorf, and, with his permission, built the town of Herrnhut (1722-1727). But under Zinzendorf the history of the Moravians took an entirely new turn. He was a fervent Lutheran of the Pietist type; he believed in Spener's "ecclesiola" conception; and now he tried to apply the conception to the Moravian refugees. For some years he had a measure of success. Instead of reviving Moravian orders at once, the settlers attended the Berthelsdorf parish church, regarded themselves as Lutherans, agreed to a code of "statutes" drawn up by the count, accepted the Augsburg Confession as their standard of faith, and, joining with some Lutheran settlers in a special Communion service in Berthelsdorf (Aug. 13, 1727), had such a powerful unifying experience that modern Moravians regard that day as the birthday of the renewed Moravian Church. From that period two conflicting ideals were at work among the Moravians. In form the Moravian Church was soon restored. Before long persecution broke out against Herrnhut; the count sent a band of emigrants to Georgia; and as these emigrants would require their own ministers, he had David Nitschmann consecrated a bishop by Jablonsky (1735). In this way the Moravian orders were maintained; the "ecclesiola" became an independent body, and the British parliament recognized the Brethren as "an ancient Protestant Episcopal Church" (1749, 22 Geo. II. cap. 120). And yet, on the other hand, Zinzendorf's conception continued long in force. It hampered the Brethren's progress in Germany, and explains the smallness of their numbers there. Instead of aiming at Church extension, they built settlements on the estates of friendly noblemen, erected Brethren's and Sisters' houses, and cultivated a quiet type of spiritual life. It is true that they evangelized all over Germany; but this part of their work was known as the *Diaspora* (1 Pet. i. 1); and the idea

underlying this word is that the Brethren minister to the "scattered" in other Churches without drawing them into the Moravian Church. In Germany, therefore, the importance of the Moravians must be measured, not by their numbers, but by their influence upon other Christian bodies. It was from the Moravians that Schleiermacher learnt his religion, and they even made a passing impression on Goethe; but both these men were repelled by their doctrine of the substitutionary sufferings of Christ.

In reply to the very natural question why the Moravians began their work in England, the answer given by history is that John Wesley, on his voyage to Georgia (1735) met some Moravian emigrants; that on his return he met Peter Boehler, who was on his way to North Carolina; that through Boehler's influence both John and Charles Wesley were "converted" (1738). For a few years they took an active share in the Evangelical Revival (1738-1755); but Zinzendorf's "ecclesiola" policy prevented their growth, and not till 1853 did the English Moravians resolve to aim at "the extension of the Brethren's Church." In foreign missions the distinctive feature about the Moravians is, not that they were so early in the field (1732), but that they were the first Protestants to declare that the evangelization of the heathen was the duty of the Church as such. Hitherto it had been a part of colonial policy. It was this that made their missions so influential.

Present Condition.—I. *Enterprises*: (1) Foreign missions in Labrador, Alaska, Canada, California, West Indies, Oregon, Demerara, Surinam, Cape Colony, Kaffraria, German East Africa, North Queensland, West Himalaya. (2) Leper Home near Jerusalem (1867). (3) Diaspora in Germany, Switzerland, France, Denmark, Norway, Russia, Poland. (4) Church extension in Germany, Great Britain, North America. (5) Boarding Schools: German province, 14; British, 7; American, 5. (6) Church Revival in Bohemia and Moravia, begun in 1869, and sanctioned by the Austrian government (1880).

II. *Orders and Constitution.*—The orders of the ministry are bishops, presbyters, deacons. But the bishops have no dioceses. Their chief function is to ordain, and to act as "intercessors." The supreme legislative board is the General Synod. It consists of delegates elected by each province, certain *ex officio* members, and representatives from the mission field. At present the Moravian Church is divided into four provinces, German, British, American North and American South (North Carolina). In provincial matters each province is independent, holds its own synods, makes its own laws, and elects its own governing board; but the General Synod meets, on the average, every ten years at Herrnhut, and its regulations are binding in all the provinces. The foreign missions are managed by a mission board, elected by the General Synod. There is also a standing court of appeal, known as Unity's Elders' Conference, and consisting of the Mission Board and four provincial boards. It is the Church's representative in the eyes of the law. In Germany the official title of the Church is *Evangelische Brüder-Unität*; in Austria, *Evangelische Brüder-Kirche*; in England and America, *Moravian Church*.

III. *Doctrine.*—At the last General Synod (1909) they repeated their old fundamental principle that "the Holy Scriptures are our only rule of faith and practice"; but at the same time they declared their entire interpretation of Scripture agreed substantially with the Nicene Creed, the Westminster and Augsburg Confessions, and the Thirty-nine Articles. Since 1879 their leading doctrines have been formulated as follows: (1) the total depravity of man; (2) the real Godhead and real humanity of Christ; (3) justification and redemption through the sacrifice of Christ; (4) work of the Holy Spirit; (5) good works as fruits of the Spirit; (6) fellowship of believers; (7) second coming of Christ; (8) resurrection of the dead to life or judgment.

IV. *Ceremonies.*—At morning worship the service consists of a litany, scripture lessons, sermon, singing, extempore prayer. At the evening service a litany is rarely used. The Communion is celebrated once a month. Infant Baptism is practised. There are three modes of admission to membership: in the case of the unbaptized, adult baptism (not immersion); in other cases confirmation or reception. Members from other Churches are generally admitted by reception.

V. *Church Policy.*—It is now held by some Moravians that their Church offers a *via media* between Anglicanism and Dissent. At the last meeting of the Lambeth Conference (1907) some overtures, on certain conditions, were made for (a) joint consecration of bishops, (b) joint ordination of ministers, (c) interchange of pulpits. In response the Moravians, at the General Synod (1909), welcomed the offer, but also declared their wish (a) to preserve their independence as a "Protestant Episcopal Church"; (b) to co-operate freely as heretofore with other Evangelical Churches. On this question negotiations are still in progress.

VI. Statistics 1909.

Province.	Congregations.	Communicants.
German	23	6,213
British	42	3,782
American (N.)	96	13,932
American (S.)	26	4,019
Bohemia	12	684
Foreign Field	245	33,466
Total	444	62,096

LITERATURE.—Gindely, *Geschichte der Böhmischen-Brüder* (1858); Goll, *Quellen u. Untersuchungen zur Gesch. d. Böhm.-Brüder* (1882); Müller, *Das Bischofstum der Brüder-Kirche* (1888); Zinzendorf als Erneuerer der alten Brüder-Kirche (1900); *Die deutschen Katechismen d. Böhm.-Brüder* (1887); Becker, *Zinzendorf und sein Christentum im Verhältnis zum christlichen u. religiösen Leben seiner Zeit* (1900); Schultze, *Abriss einer Geschichte der Brüder-Mission* (1901); Seiffert, *Church Constitution of the Bohemian and Moravian Brethren* (1866); De Schweinitz, *History of the Unities Fratrum* (1888); Wauer, *Beginnings of the Brethren's Church in England* (1901); Hamilton, *History of the Moravian Church in the 18th and 19th Centuries* (1900); Hutton, *History of the Moravian Church* (1909); *Moravian Church Book* (1902); *Moravian Almanac* (annual). For other sources see articles "Böhmische-Brüder" and "Zinzendorf" in Hauck's *Realencyclopædie*; and for latest results of historical research, *Zeitschrift für Brüdergeschichte* (half-yearly). (J. E. H.)

MORAY, THOMAS RANDOLPH, 1ST EARL OF (d. 1332), Scottish warrior and statesman, was the only son of Thomas Randolph of Nithsdale, who had been chamberlain of Scotland, and through his mother Lady Isabel Bruce he was nephew to King Robert the Bruce. Randolph joined Bruce after the murder of the Red Comyn, and was present at his coronation in 1306. In June of that year he was captured by Aymer de Valence in a fight at Methven, and saved his life by becoming Edward's man. He joined in the hunt for Bruce, but in 1308 he was captured by Sir James Douglas and imprisoned. He began by defying his uncle, but presently made his submission, becoming the friendly rival of the exploits of Sir James Douglas and the confidant of Bruce's plans. In 1312 or 1314 the Scottish king made him earl of Moray and lord of Man and Annandale, while the estates held from Edward I. were confiscated. By a brilliant feat of arms he captured and destroyed Edinburgh Castle early in 1314, scaling the rock by a path pointed out by a certain William François who had made use of it in a love intrigue. On the eve of Bannockburn Randolph was posted in a wood in charge of the van with orders to prevent the English from throwing cavalry into Stirling. On the approach of a body of three hundred English horse under Sir Robert Clifford, Sir Henry de Beaumont and Sir Thomas Gray, Randolph came out of cover, and his spearman, drawn up in a square, were vainly attacked on all sides by the English, who were driven to retreat on the appearance of Sir James Douglas with reinforcements; these, however, took no share in the action, the site of which is still known as Randolph's Field. The next day found Randolph in command of the centre of the Scottish battle. He shared in Edward Bruce's expedition to Ireland in 1315, and returned to Scotland in 1317 with Robert Bruce. With Sir James Douglas Randolph was closely allied and the two were associated in a series of brilliant exploits. In 1318 they seized the town of Berwick by escalade; being aided by the treachery of one of the burgesses, Simon of Spalding, and reinforced by Bruce they became masters of the castle some months later. In the next spring they made a raid on the northern English counties, laying waste the country as far as York, where they hoped to seize the English queen. They routed the militia hastily raised by William de Melton, archbishop of York, in a fight known as the "Chapter of Myton" because of the number of clerics who fell in the battle. Edward II., who was laying siege to Berwick, sought in vain to intercept them on their return journey. Later in the year the two Scottish nobles again raided England, and at length Edward II. signed a truce for two years. In 1322 Moray shared in Douglas's exploit at Byland Abbey. In the next year he was one of the Scottish ambassadors charged to conclude a truce with England, and was further sent to Avignon to persuade the pope to acknowledge

¹ In general, for "Moray" see MURRAY, the spelling having been constantly interchangeable. The present earls keep the spelling Moray.

Bruce's claims by addressing him as king of Scotland. In the spring of 1326 he was again in France, when he concluded an offensive and defensive alliance between France and Scotland. The death of Bruce in 1329 made Moray regent of Scotland and guardian of the young king David II. in accordance with enactments made by the Scottish parliaments of 1315 and 1318. He died at Musselburgh on the 20th of July 1332, while preparing to resist an invasion by the English barons. Allegations of poisoning are made both by Barbour and Wyntoun, but without substantial grounds.

Moray married Isabel, daughter of Sir John Stewart of Bonkyll. His son Thomas, the 2nd earl, was killed at the battle of Dupplin in 1332; his second son John, the 3rd earl, was killed at Neville's Cross in 1346. The earldom then became extinct and the estates passed to their sister Agnes (c. 1312-1369), countess of Dunbar and March, known as "Black Agnes," and celebrated for her gallant defence of Dunbar Castle in 1337 and 1338. (See MARCH, EARLS OF.)

MORBHANJ, or **MAYURBHANJ**, a native state of India, in the Orissa division of Bengal. Area 4243 sq. m.; pop. (1901), 610,383, showing an increase of 14.7% in the preceding decade; revenue, £64,000. It contains a large proportion of mountain and forest, where wild elephants are numerous, and also some of the richest iron ores in India. The capital is **BARIPADA** (pop. 5613), which is connected by a narrow-gauge line with the Bengal-Nagpur railway.

MORBIHAN, a department of western France on the Atlantic seaboard, formed of part of Lower Brittany, and bounded S.E. by the department of Loire-Inférieure, E. by that of Ille-et-Vilaine, N. by Côtes-du-Nord, and W. by Finistère. Area, 2738 sq. m. Pop. (1906), 573,152. From the Montagnes Noires on the northern frontier the western portion of Morbihan slopes southward towards the Atlantic, being watered by the Ellé, the Blavet with its affluent the Scorf, and the Auray; the eastern portion, on the other hand, dips towards the south-east in the direction of the course of the Oust and its feeders, which fall into the Vilaine. Though the Montagnes Noires contain the highest point (974 ft.) in the department, the most striking orographic feature of Morbihan is the dreary, treeless, streamless tract of moorland and marsh known as the Landes of Lanvaux, which extends (W.N.W. to E.S.E.) with a width of from 1 to 3 miles for a distance of 31 miles between the valley of the Claic and that of the Arz (affluents of the Oust). A striking contrast to this district is afforded by the various inlets of the sea, whose shores are clothed with vegetation of exceptional richness, large fig-trees, rose-laurels, and aloes growing as if in Algeria. The coast-line is exceedingly irregular: the mouth of the Vilaine, the peninsula of Ruis, the great gulf of Morbihan (Inner Sea), from which the department takes its name, and the mouth of the Auray, the long Quiberon peninsula attached to the mainland by the narrow isthmus of Fort Penhièvre, the deep-branching estuary of Etel, the mouths of the Blavet and the Scorf uniting to form the port of Lorient, and, finally, on the borders of Finistère the mouth of the Laita, follow each other in rapid succession. Off the coast lie the islands of Groix, Belle-Ile (*q.v.*), Houat and Hoëdik. Vessels drawing 13 ft. can ascend the Vilaine as far as Redon; the Blavet is canalized throughout its course through the department; and the Oust, as part of the canal from Nantes to Brest, forms a great waterway by Redon, Josselin, Rohan and Pontivy. The climate of Morbihan is characterized by great moisture and mildness. Unproductive heath occupies more than a quarter of the department, about a third of which is arable land. Rye, buckwheat and wheat, potatoes and mangels are the chief crops; hemp and flax are also grown. Horned cattle are the chief livestock and bee-keeping is extensively practised. The sea-weed gathered along the coast helps greatly to improve the soil of the region bordering thereon. Outside of Lorient (*q.v.*), a centre for naval construction, there is little industrial activity in Morbihan. The catching and curing of sardines and the breeding of oysters (Auray, St Armel, &c.) form the business of many of the inhabitants of the coast, who also fish for anchovies, lobsters, &c., for tinning.

The forges of Hennebont are of some importance for the production of sheet-iron.

The department is served by the Orleans railway. It is divided into four arrondissements—Vannes, Lorient, Ploermel and Pontivy—with 37 cantons and 256 communes. The capital Vannes is the seat of a bishopric of the province of Rennes. The department belongs to the region of the XIth army corps and to the académie (educational division) of Rennes, where also is its court of appeal. The principal places are Vannes, Lorient, Ploermel, Pontivy, Auray, Hennebont, Carnac and Locmariaque, the last two famous for the megalithic monuments in their vicinity. Other places of interest are Erdeven and Plouharnel, also well known for their megalithic remains; Elven, with two towers of the 15th century, remains of an old stronghold; Josselin which has the fine château of the Rohan family and a church containing the tomb (15th century) of Olivier de Clisson and his wife; Guern with a chapel of the 15th and 16th centuries and le Faouët with a chapel of the 15th century; Quiberon, which is associated with the disaster of the French *émigrés* in 1795; Sarzeau, near which is the fortress of Sucinio (13th and 15th centuries); Ste Barbe with a chapel, dating from about the end of the 15th century, finely situated, overlooking the Ellé; St Gildas-de-Ruis, with a ruined Romanesque church and other remains of a Benedictine abbey of which Abeldar was for a time abbot. The principal *pardons* (religious festivals) of the department are those of Ste Anne-d'Auray and St Nicolas-des-Eaux.

MORCAR, **EARL** (fl. 1066), son of Earl Ælfgar, brother of Edwin, earl of the Mercians. They assisted the Northumbrians to expel Tostig, of the house of Godwin, in 1065 and Morcar was chosen earl by the rebels. Harold, Tostig's brother, consented to this extension of the power of the Mercian house. In spite of this concession, and the help which he gave them against Tostig and Harold Hardrada, the two brothers left him to fight alone at Hastings. After trying to secure the crown for their own house, they submitted to William, but lost their earldoms. They attempted to raise the North in 1068, and failed ignominiously. They were pardoned, but Morcar afterwards joined Hereward in the Isle of Ely (1071), while Edwin perished in attempting to raise a Welsh rebellion. Morcar died in prison; at what date is unknown.

See E. A. Freeman, *Norman Conquest and William Rufus*, vol. i.

MORDECAI BEN HILLEL, a German rabbi, who died as a martyr at Nuremberg in 1298. His great legal (Halachic) work is usually cited as "the Mordecai," and its value consists in its thorough use of the medieval authorities. It acquired wide authority, and was one of the sources of the *Code* of Joseph Caro. Mordecai was also the author of *Responsa*.

See L. Ginzberg in *Jew. Ency.* ix. 10-13.

MORDVINIANS, otherwise called **MORDVA**, **MORDVS**, or **MORDVINS**, a people numbering about one million, belonging to the Ural-Altai family, who inhabit the middle Volga provinces of Russia and spread in small detached communities to the south and east of these. Their settlement in the basin of the Volga is of high antiquity. One of the two great branches into which they are divided, the Erzya, is perhaps the same as the Aorses mentioned by Ptolemy as dwelling between the Baltic Sea and the Ural Mountains. Strabo mentions also the Aorses as inhabitants of the country between the Don, the Caspian Sea and the Caucasus. The Russians made raids on the Mordvins in the 12th century, and after the fall of Kazan rapidly invaded and colonized their country.

The Mordvins are now found in the governments of Simbirsk, Penza, Samara and Nizhniy-Novgorod, as well as Saratov and Tambov. But their villages are dispersed among those of the Russians, and they constitute only 10 to 12% of the population in the four first-named governments, and from 5 to 6% in the last two. They are unequally distributed over this area in ethnographical islands, and constitute as much as 23 to 44% of the population of several districts of the governments of Tambov, Simbirsk, Samara and Saratov, and only 2 or 3% in other districts of the same provinces. They are divided into two great

branches, the Erzya (Erza, or Ersa) and the Moksha, differing somewhat in their physical features and language. The southern branch, or the Moksha, have a darker skin and darker eyes and hair than the northern. A third branch, the Karatays, found in Kazan, appears to be mixed with Tatars. The language is a branch of the Western Finnish family, and most nearly allied to the Chermessian, though presenting many peculiarities (see FINNO-UGRIC). The Mordvins have largely abandoned their own language for Russian; but they have maintained a good deal of their old national dress, especially the women, whose profusely embroidered skirts, original hair-dress large ear-rings which sometimes are merely hare-tails, and numerous necklaces covering all the chest and consisting of all possible ornaments, easily distinguish them from Russian women. They have mostly dark hair, but blue eyes, generally small and rather narrow. Their cephalic index is very near to that of the Finns. They are brachycephalous or sub-brachycephalous, and a few are mesati-cephalous. They are finely built, rather tall and strong, and broad-chested. Their chief occupation is agriculture; they work harder and (in the basin of the Moksha) are more prosperous than their Russian neighbours. Their capacities as carpenters were well known in Old Russia, and Ivan the Terrible used them to build bridges and clear forests during his advance on Kazan. They now manufacture wooden ware of various sorts. They are also masters of apiculture, and the commonwealth of bees often appears in their poetry and religious beliefs. They have a considerable literature of popular songs and legends, some of them recounting the doings of a king Tushtyan who lived in the time of Ivan the Terrible. Nearly all are Christians; they received baptism in the reign of Elizabeth, and the Nonconformists have made many proselytes among them. But they still preserve much of their own mythology, which they have adapted to the Christian religion. According to some authorities, they have preserved also, especially the less russified Moksha, the practice of kidnapping brides, with the usual battles between the party of the bridegroom and that of the family of the bride. The worship of trees, water (especially of the water-divinity which favours marriage), the sun or Shkay, who is the chief divinity, the moon, the thunder and the frost, and of the home-divinity Kardaz-serko still exists among them; and a small stone altar or flat stone covering a small pit to receive the blood of slaughtered animals can be found in many houses. Their burial customs seem founded on ancestor-worship. On the fortieth day after the death of a kinsman the dead is not only supposed to return home but a member of his household represents him, and, coming from the grave, speaks in his name.

The language is treated in Ahlquist's *Versuch einer Mokschamordvinischen Grammatik nebst Texten und Wörter-Verzeichniss* (St. Petersburg, 1861), and their history, customs and religion by Smirnov (trans. by Boyer), "Les Populations finnoises de la Volga" (in *Publications de l'école des langues orientales, vivantes*, 1898). Much valuable information respecting customs, religion, language and folk-lore will be found in papers by Paasonen, Heikel, Ahlquist, Mainoff and others printed in the *Journal de la Société Finno-Ougrienne* and the *Finnisch-ugrische Forschungen*. (C. EL.)

MORE, HANNAH (1745-1833), English religious writer, was born at Stapleton, near Bristol, on the 2nd of February 1745. She may be said to have made three reputations in the course of her long life: first, as a clever verse-writer and witty talker in the circle of Johnson, Reynolds and Garrick; next, as a writer on moral and religious subjects on the Puritanic side; and lastly, as a practical philanthropist. She was the youngest but one of the five daughters of Jacob More, who, though a member of a Presbyterian family in Norfolk, had become a member of the English Church and a strong Tory. He taught a school at Stapleton in Gloucestershire. The elder sisters established a boarding-school at Bristol, and Hannah became one of their pupils when she was twelve years old. Her first literary efforts were pastoral plays, suitable for young ladies to act, the first being written in 1762 under the title of *A Search after Happiness* (2nd ed. 1773). Metastasio was one of her literary models; on his opera of *Attilio regolo* she based a drama, *The Inflexible Captive*, published in 1774. She gave up her share in the school

in view of an engagement of marriage she had contracted with a Mr Turner. The wedding never took place, and, after much reluctance, Hannah More was induced to accept from Mr Turner an annuity which had been settled on her without her knowledge. This set her free for literary pursuits, and in 1772 or 1773 she went to London. Some verses on Garrick's *Lea* led to an acquaintance with the actor-playwright; Miss More was taken up by Elizabeth Montague; and her unaffected enthusiasm, simplicity, vivacity, and wit won the hearts of the whole Johnson set, the lexicographer himself included, although he is said to have told her that she should "consider what her flattery was worth before she choked him with it." Garrick wrote the prologue and epilogue for her tragedy *Percy*, which was acted with great success at Covent Garden in December 1777. Another drama, *The Fatal Falsehood*, produced in 1779 after Garrick's death, was less successful. The Garricks had induced her to live with them; and after Garrick's death she remained with his wife, first at Hampton Court, and then in the Adelphi. In 1781 she made the acquaintance of Horace Walpole, and corresponded with him from that time. At Bristol she discovered a poetess in Mrs Anne Yearsley (1756-1806), a milkwoman, and raised a considerable sum of money for her benefit. "Lactilla," as Mrs Yearsley was called, wished to receive the capital, and made insinuations against Miss More, who desired to hold it in trust. The trust was handed over to a Bristol merchant and eventually to the poetess.

Hannah More published *Sacred Dramas* in 1782, and it rapidly ran through nineteen editions. These and the poems *Bas-Bleu* and *Florio* (1786) mark her gradual transition to more serious views of life, which were fully expressed in prose in her *Thoughts on the Importance of the Manners of the Great to General Society* (1788), and *An Estimate of the Religion of the Fashionable World* (1790). She was intimate with Willberforce and Zachary Macaulay, with whose evangelical views she was in entire sympathy. She published a poem on *Slavery* in 1788. In 1785 she bought a house, at Cowslip Green, near Wrington, near Bristol, where she settled down to country life with her sister Martha, and wrote many ethical books and tracts: *Structures on Female Education* (1790), *Hints towards forming the Character of a Young Princess* (1805), *Coelebs in Search of a Wife* (only nominally a story, 1809), *Practical Piety* (1811), *Christian Morals* (1813), *Character of St Paul* (1815), *Moral Sketches* (1819). The tone is uniformly animated; the writing fresh and vivacious; her favourite subjects the minor self-indulgences and infirmities. She was a rapid writer, and her work is consequently discursive and formless; but there was an originality and force in her way of putting commonplace sober sense and piety that fully accounts for her extraordinary popularity. The most famous of her books was *Coelebs in Search of a Wife*, which had an enormous circulation among pious people. Sydney Smith attacked it with violence in the *Edinburgh Review* for its general priggishness. It is interesting to note that the model Stanley children have been said to be drawn from T. B. Macaulay and his sister. She also wrote many spirited rhymes and prose tales, the earliest of which was *Village Politics* (1792), by "Will Chip," to counteract the doctrines of Tom Paine and the influence of the French Revolution. The success of *Village Politics* induced her to begin the series of "Cheap Repository Tracts," which were for three years produced by Hannah and her sisters at the rate of three a month. Perhaps the most famous of these is *The Shepherd of Salisbury Plain*, describing a family of phenomenal frugality and contentment. This was translated into several languages. Two million copies of these rapid and telling sketches were circulated in one year, teaching the poor in rhetoric of most ingenious homeliness to rely upon the virtues of content, sobriety, humility, industry, reverence for the British Constitution, hatred of the French, trust in God and in the kindness of the gentry.

Perhaps the best proof of Hannah More's sterling worth was her indefatigable philanthropic work—her long-continued exertions to improve the condition of the children in the mining districts of the Mendip Hills near her home at Cowslip Green and Barley Wood. The More sisters met with a good deal of

opposition in their good works. The farmers thought that education, even to the limited extent of learning to read, would be fatal to agriculture, and the clergy, whose neglect she was making good, accused her of Methodist tendencies. In her old age, philanthropists from all parts made pilgrimages to see the bright and amiable old lady, and she retained all her faculties till within two years of her death, dying at Clifton, where the last five years of her life were spent, on the 7th of September 1833.

See *The Life of Hannah More, with Notices of Her Sisters* (1838), by the Rev. Henry Thompson. The article in the *Dict. Nat. Biog.* is by Sir Leslie Stephen. Some letters of Hannah More, with a very slight connecting narrative, were published in 1872 by William Roberts as *The Life of Hannah More*. See also *Hannah More* (1888), by Charlotte M. Yonge, in the "Eminent Women" series, and *Hannah More* (New York and London, 1900), by "Marion Harland." *Letters of Hannah More to Zachary Macaulay* were edited (1866) by Arthur Roberts. The contemporary opposition to her may be seen in an abusive *Life of Hannah More, with a Critical Review of Her Writings* (1802), by the "Rev. Archibald Maccarescum" (William Shaw, rector of Chelvey, Somerset).

MORE, HENRY (1614-1687), English philosopher of the Cambridge Platonist school, was born at Grantham in 1614. Both his father and his mother, he tells us, were "earnest followers of Calvin," but he himself "could never swallow that hard doctrine." In 1631 he was admitted at Christ's College, Cambridge, about the time Milton was leaving it. He immersed himself "over head and ears in the study of philosophy," and fell for a time into a scepticism, from which he was delivered by a study of the "Platonic writers." He was fascinated especially by Neoplatonism, and this fascination never left him. The *Theologia germanica* also exerted a permanent influence over him. He took his bachelor's degree in 1635, his master's degree in 1639, and immediately afterwards was chosen fellow of his college. All other preferment he refused, with one exception. Fifteen years after the Restoration he accepted a prebend in Gloucester Cathedral, but only to resign it in favour of his friend Dr Edward Fowler, afterwards bishop of Gloucester. He would not accept the mastership of his college, to which, it is understood, he would have been preferred in 1654, when Cudworth was appointed. He drew around him many young men of a refined and thoughtful turn of mind, but among all his pupils the most interesting was a young lady of noble family. This lady, probably a sister of Lord Finch, subsequently earl of Nottingham, a well-known statesman of the Restoration, afterwards became Lady Conway, and at her country seat at Ragley in Warwickshire More continued at intervals to spend "a considerable part of his time." She and her husband both appreciated him, and amidst the woods of this retreat he composed several of his books. The spiritual enthusiasm of Lady Conway was a considerable factor in some of More's speculations, none the less that she at length joined the Quakers. She became the friend not only of More and Penn, but of Baron van Helmont and Valentine Greatrakes, mystical thaumaturgists of the 17th century. Ragley became a centre not only of devotion but of wonder-working spiritualism.¹ From this, his genius suffered, and the rationality which distinguishes his earlier is much less conspicuous in his later works. He was a voluminous writer both in verse and in prose, but his works, except the *Divine Dialogues* (1688), are now of little interest. This treatise, animated and sometimes brilliant, is valuable for modern readers in that it condenses his general view of philosophy and religion.

Henry More represents the mystical and theosophic side of the Cambridge movement. The Neoplatonic extravagances which lay hidden in the school from the first came in his writings to a head, and merged in pure phantasy. He can never be spoken of, however, save as a spiritual genius and a significant figure in British philosophy, less robust and in some respects less learned than Cudworth, but more interesting and fertile in thought, and more genial in character. From youth to age he describes himself as gifted with a buoyant temper. His own thoughts were to him a never-ending source of pleasurable excitement. This mystical elevation was the chief feature of his character, a certain

¹ The place and its religious marvels are glanced at in the romance of *John Inglesant* (ch. xv.).

radiancy of thought which carried him beyond the common life without raising him to any artificial height, for his humility and charity were not less conspicuous than his piety. The last ten years of his life were uneventful. He died on the 1st of September 1687, and was buried in the chapel of the college he loved.

Before his death More issued complete editions of his works, his *Opera theologica* in 1675, and his *Opera philosophica* in 1678. The chief authorities for his life are *Ward's Life* (1710); the preface generalissima prefixed to his *Opera omnia* (1679); and also a general account of the manner and scope of his writings in a *Program* published in 1664. The collection of his *Philosophical Poems* (1647), in which he has "compared his chief speculations and experiences," should also be consulted. An elaborate analysis of his life and works is given in Tulloch's *Rational Theology*, vol. ii. (1874); see also R. Zimmermann, *Henry More und die vierde Dimension des Raums* (Vienna, 1881). For his ethical theory, as contained in the *Enchiridion Ethicum*, see ERNICUS.)

MORE, SIR THOMAS (1478-1535), English lord chancellor, and author of *Utopia*, was born in Milk Street in the city of London, on the 7th of February 1478. He received the rudiments of education at St Anthony's School in Threadneedle Street, at that time under Nicolas Holt, held to be the best in the city. He was early placed in the household of Cardinal Morton, archbishop of Canterbury. Admission to the cardinal's family was esteemed a high privilege, and was sought as a school of manners and as an introduction to the world by the sons of the best families in the kingdom. Young Thomas More obtained admission through the influence of his father, Sir Thomas, then a rising barrister and afterwards a justice of the court of king's bench. The usual prognostication of future distinction is attributed in the case of More to Cardinal Morton, "who would often tell the nobles sitting at table with him, where young Thomas waited on him, whosever liveth to trie it shall see this child prove a notable and rare man."¹ At the proper age young More was sent to Oxford, where he is said vaguely to have had Colet, Grocyn and Linacre for his tutors.² All more himself says is that he had Linacre for his master in Greek. Learning Greek was not the matter of course which it has since become. Greek was not as yet part of the arts curriculum, and to learn it voluntarily was ill looked upon by the authorities. Those who did so were suspected of an inclination towards novel and dangerous modes of thinking, then rife on the Continent and slowly finding their way to England. More's father, who intended his son to make a career in his own profession, took the alarm; he removed him from the university without a degree, and entered him at New Inn to commence at once the study of the law. After completing a two-years' course in New Inn, an inn of chancery, More was admitted in February 1496 at Lincoln's Inn, an inn of court. "At that time the Inns of Court and Chancery presented the discipline of a well-constituted university, and, through professors under the name of readers and exercises under the name of mootings, law was systematically taught" (CAMPBELL). In his professional studies More early distinguished himself, so that he was appointed reader-in-law in Furnival's Inn; but he would not relinquish the studies which had attracted him in Oxford. We find him delivering a lecture to audiences of "all the chief learned of the city of London."³ The subject he chose was a compromise between theology and the humanities, being St Augustine's *De civitate*. In this lecture More sought less to expound the theology of his author than to set forth the philosophical and historical contents of the treatise. The lecture-room was a church, St Lawrence Jewry, placed at his disposal by Grocyn, the rector.

Somewhere about this period of More's life two things happened which gave in opposite directions the determining impulse to his future career. More's was one of those highly susceptible natures which take more readily and more eagerly than common minds the impress of that which they encounter on their first contact with men. Two principal forms of thought and feeling were at this date in conflict, rather unconscious than declared, on English soil. Under the denomination of the "old learning," the sentiment of the middle ages and the idea of Church authority was

¹ *Life* by B. R.

² *Ibid.*

³ *Roper, Life.*

established and in full possession of the religious houses, the universities, and the learned professions. The foe that was advancing in the opposite direction, though without the conscience of a hostile purpose, was the new power of human reason animated with the revived sentiment of classicism. In More's mind both these hostile influences found a congenial home. Each had its turn of supremacy, and in his early years it seemed as if the humanistic influence would gain the final victory. About the age of twenty he was seized with a violent access of devotional rapture. He took a disgust to the world and its occupations, and experienced a longing to give himself over to an ascetic life. He took a lodging near the Charterhouse, and subjected himself to the discipline of a Carthusian monk. He wore a sharp shirt of hair next his skin, scourged himself every Friday and other fasting days, lay upon the bare ground with a log under his head, and allowed himself but four or five hours' sleep. This access of the ascetic malady lasted but a short time, and More recovered to all outward appearance his balance of mind. For the moment the balance of his faculties seemed to be restored by a revival of the antagonistic sentiment of humanism which he had imbibed from the Oxford circle of friends, and specially from Erasmus. The dates as regards More's early life are uncertain, and we can only say that it is possible that the acquaintance with Erasmus might have begun during Erasmus's first visit to England in 1499. Tradition has dramatized their first meeting into the story given by Cresacre More¹—that the two happened to sit opposite each other at the lord mayor's table, that they got into an argument during dinner, and that, in mutual astonishment at each other's wit and readiness, Erasmus exclaimed, "Aut tu es Morus, aut nullus," and the other replied, "Aut tu es Erasmus, aut diabolus!" Rejecting this legend, which bears the stamp of fiction upon its face, we have certain evidence of acquaintance between the two men in a letter of Erasmus, with the date "Oxford, 29th October 1499." If we must admit the correctness of the date of Ep. 14 in the collection of Erasmus's *Epistolae*, we should have to assume that their acquaintance had begun as early as 1497. It rapidly ripened into warm attachment. This contact with the prince of letters revived in More the spirit of the "new learning," and he returned with ardour to the study of Greek, which had been begun at Oxford. The humanistic influence was sufficiently strong to save him from wrecking his life in monkish mortification, and even to keep him for a time on the side of the party of progress. He acquired no inconsiderable facility in the Greek language, from which he made and published some translations. His Latin style, though wanting the inimitable ease of Erasmus and often offending against idiom, is yet in copiousness and propriety much above the ordinary Latin of the English scholars of his time.

More's attention to the new studies was always subordinate to his resolution to rise in his profession, in which he was stimulated by his father's example. As early as 1502 he was appointed under-sheriff of the city of London, an office then judicial and of considerable dignity. He first attracted public attention by his conduct in the parliament of 1504, by his daring opposition to the king's demand for money. Henry VII. was entitled, according to feudal laws, to a grant on occasion of his daughter's marriage. But he came to the House of Commons for a much larger sum than he intended to give with his daughter. The members, unwilling as they were to vote the money, were afraid to offend the king, till the silence was broken by More, whose speech is said to have moved the house to reduce the subsidy of three-fifteenths which the Government had demanded to £30,000. One of the chamberlains went and told his master that he had been thwarted by a beardless boy. Henry never forgave the audacity; but, for the moment, the only revenge he could take was upon More's father, whom upon some pretext he threw into the Tower, and he only released him upon payment of a fine of £100. Thomas More even found it advisable to withdraw from public life into obscurity. During this period of retirement the old dilemma recurred. One while he devoted himself to the sciences, "perfecting himself in music, arithmetic, geometry and

¹ *Life*, p. 93.

astronomy, learning the French tongue, and recreating his tired spirits on the viol,"² or translating epigrams from the Greek anthology; another while resolving to take priest's orders.

From dreams of clerical celibacy he was roused by making acquaintance with the family of John Colt of New Hall, in Essex. The "honest and sweet conversation" of the three daughters attracted him, and though his inclination led him to prefer the second he married the eldest, Jane, in 1505, not liking to put the affront upon her of passing her over in favour of her younger sister. The death of the old king in 1509 restored him to the practice of his profession, and to that public career for which his abilities specially fitted him. From this time there was scarce a cause of importance in which he was not engaged. His professional income amounted to £400 a year, equal to £4,000 in present money, and, "considering the relative profits of the law and the value of money, probably indicated as high a station as £10,000 at the present day" (CAMPBELL). It was not long before he attracted the attention of the young king and of Wolsey. The spirit with which he pleaded before the Star Chamber in a case of *The Crown v. The Pope* recommended him to the royal favour, and marked him out for employment. More obtained in this case judgment against the Crown. Henry, who was present in person at the trial, had the good sense not to resent the defeat, but took the counsel to whose advocacy it was due into his service. In 1514 More was made master of the requests, knighted, and sworn a member of the privy council. He was repeatedly employed on embassies to the Low Countries, and was for a long time stationed at Calais as agent in the shifty negotiations carried on by Wolsey with the court of France. In 1510 he was compelled to resign his post of under-sheriff to the city and his private practice at the bar. In 1521 he was appointed treasurer of the exchequer, and in the parliament of 1523 he was elected Speaker. The choice of this officer rested nominally with the house itself, but in practice was always dictated by the court. Sir Thomas More was pitched upon by the court on this occasion in order that his popularity with the Commons might be employed to carry the money grant for which Wolsey asked. To the great disappointment of the court More remained firm to the popular cause, and it was greatly owing to his influence that its demands were resisted. From this occurrence may be dated the jealousy which the cardinal began to exhibit towards More. Wolsey made an attempt to get him out of the way by sending him as ambassador to Spain. More defeated the design by a personal appeal to the king, alleging that the climate would be fatal to his health. Henry, who saw through the artifice, and was already looking round for a more popular successor to Wolsey, made the gracious answer that he would employ More otherwise. In 1525 More was appointed chancellor of the duchy of Lancaster, and no pains were spared to attach him to the court. The king frequently sent for him into his closet, and discoursed with him on astronomy, geometry and points of divinity. This growing favour, by which many men would have been carried away, did not impose upon More. He discouraged the king's advances, showed reluctance to go to the palace, and seemed constrained when there. Then the king began to come himself to More's house at Chelsea, and would dine with him without previous notice. William Roper, husband of More's eldest daughter, mentions one of these visits, when the king after dinner walked in the garden by the space of an hour holding his arm round More's neck. Roper afterwards congratulated his father-in-law on the distinguished honour which had been shown him. "I thank our Lord," was the reply, "I find his grace my very good lord indeed; and I believe he doth as singularly favour me as any subject within this realm. Howbeit, son Roper, I may tell thee I have no cause to be proud thereof, for if my head would win him a castle in France it should not fail to go." As a last resource More tried the expedient of silence, dissembling his wit and affecting to be dull. This had the desired effect so far that he was less often sent for. But it did not alter the royal policy, and in 1529, when a successor had to be

² Roper, *Life*.

found for Wolsey, More was raised to the chancellorship. The selection was justified by More's high reputation, but it was also significant of the modification which the policy of the court was then undergoing. It was a concession to the rising popular party, to which it was supposed that More's politics inclined him. The public favour with which his appointment had been received was justified by his conduct as judge in the court of chancery. Having heard causes in the forenoon between eight and eleven, after dinner he sat again to receive petitions. The meaner the suppliant was the more affably he would speak to him and the more speedily he would despatch his case. In this respect he formed a great contrast to his predecessor, whose arrears he soon cleared off. One morning being told by the officer that there was not another cause before the court, he ordered the fact to be entered on record, as it had never happened before. He not only refused all gifts—such as had been usual—himself, but took measures to prevent any of his connexions from interfering with the course of justice. One of his sons-in-law, Heron, having a suit in the chancellor's court, and refusing to agree to any reasonable accommodation, because the judge "was the most affectionate father to his children that ever was in the world," More thereupon made a decree against him.

Unfortunately for Sir Thomas More, a lord chancellor is not merely a judge, but has high political functions to perform. In raising More to that eminent position, the king had not merely considered his professional distinction but had counted upon his avowed liberal and reforming tendencies. In the *Utopia*, which, though written earlier, More had allowed to be printed as late as 1516, he had spoken against the vices of power, and declared for indifference of religious creed with a breadth of philosophical view of which there is no other example in any Englishman of that age. At the same time, as he could not be suspected of any sympathy with Lutheran or Wickliffite heretics, he might fairly be regarded as qualified to lead the party which aimed at reform in State and Church within the limits of Catholic orthodoxy. But in the king's mind the public questions of reform were entirely sunk in the personal one of the divorce. The divorce was a point upon which Sir Thomas would not yield. And, as he saw that the marriage with Anne Boleyn was determined upon, he petitioned the king to be allowed to resign the Great Seal, alleging failing health. With much reluctance the royal permission was given and the resignation accepted, on the 10th of May 1532, with many gracious expressions of goodwill on the part of the king. The promise held out of future bounty was never fulfilled, and More left office, as he had entered it, a poor man. His necessitous condition was so notorious that the clergy in convocation voted him a present of £500. This he peremptorily refused, either for himself or for his family, declaring that he "had rather see it all cast into the Thames." Yet the whole of his income after resigning office did not exceed £100 a year.

Hitherto he had maintained a large establishment, not on the princely scale of Wolsey, but in the patriarchal fashion of having all his sons-in-law, with their families, under his roof. When he resigned the chancellorship he called his children and grandchildren together to explain his reduced circumstances. "If we wish to live together," said he, "you must be content to be contributories together. But my counsel is that we fall not to the lowest fare first: we will not, therefore, descend to Oxford fare, nor to the fare of New Inn, but we will begin with Lincoln's Inn diet, where many right worshipful men of great account and good years do live full well; which if we find ourselves the first year not able to maintain, then we will in the next year come down to Oxford fare, where many great learned and ancient fathers and doctors are continually conversant; while if our purses stretch not to maintain neither, then may we after, with bag and wallet, go a-begging together, hoping that for pity some good folks will give us their charity."

More was now able, as he writes to Erasmus, to return to the life which had always been his ambition, when, free from business and public affairs, he might give himself up to his favourite

studies and to the practices of his devotion. Of the Chelsea interior Erasmus has drawn a charming picture, which may vie with Holbein's celebrated canvas, "The Household of Sir Thomas More."

"More has built, near London, upon the Thames, a modest yet commodious mansion. There he lives surrounded by his numerous family, including his wife, his son, and his son's wife, his three daughters and their husbands, with eleven grandchildren. There is not any man living so affectionate to his children as he, and he loveth his old wife as if she were a girl of fifteen. Such is the excellence of his disposition that whatsoever happeneth that could not be helped, he is as cheertful and as well pleased as though the best thing possible had been done. In More's house you would see that Plato's Academy was revived again, only, whereas in the Academy the discussions turned upon geometry and the power of numbers, the house at Chelsea is a veritable school of Christian religion. In it is none, man or woman, but readeth or studieth the liberal arts, yet is their chief care of piety. There is never any seen idle; the head of the house governs it not by a lofty carriage and oft rebukes, but by gentleness and amiable manners. Every member is busy in his place, performing his duty with alacrity; nor is sober mirth wanting."

But More was too conspicuous to be long allowed to enjoy the happiness of a retired life. A special invitation was sent him by the king to attend the coronation of Anne Boleyn, accompanied with the gracious offer of £20 to buy a new suit for the occasion! More refused to attend, and from that moment was marked out for vengeance. A first attempt made to bring him within the meshes of the law only recoiled with shame upon the head of the accusers. They were maladroit enough to attack him on his least vulnerable side, summoning him before the privy council to answer to a charge of receiving bribes in the administration of justice. One Parnell was put forward to complain of a decree pronounced against him in favour of the contending party Vaughan, who he said had presented a gilt cup to the chancellor. More stated that he had received a cup as a New Year's gift. Lord Wiltshire, the queen's father, exultingly cried out, "So, did I not tell you, my lords, that you would find this matter true?" "But, my lords," continued More, "having pledged Mrs Vaughan in the wine wherewith my butler had filled the cup, I restored the cup to her." Two other charges of a like nature were refuted as triumphantly. But the very futility of the accusations must have betrayed to More the bitter determination of his enemies to compass his destruction. Foiled in their first ill-directed attempt, they were compelled to have recourse to that tremendous engine of regal tyranny, the law of treason. A bill was brought into parliament to attain Elizabeth Barton, a nun, who was said to have held treasonable language. Barton turned out afterwards to have been an impostor, but she had duped More, who now lived in a superstitious atmosphere of convents and churches, and he had given his countenance to her supernatural pretensions. His name, with that of Fisher, was accordingly included in the bill as an accomplice. When he came before the council it was at once apparent that the charge of treason could not be sustained, and the efforts of the court agents were directed to draw from More some approbation of the king's marriage. But to this neither cajolery nor threats could move him. The preposterous charge was urged that it was by his advice that the king had committed himself in his book against Luther to an assertion of the pope's authority, whereby the title of "Defender of the Faith" had been gained, but in reality a sword put into the pope's hand to fight against him. More was able to reply that he had warned the king that this very thing might happen, that upon some breach of amity between the crown of England and the pope Henry's too pronounced assertion of the papal authority might be turned against himself, "therefore it were best that place be amended, and his authority more slenderly touched." "Nay," replied the king, "that it shall not; we are so much bound to the see of Rome that we cannot do too much honour unto it. Whatsoever impediment be to the contrary, we will set forth that authority to the utmost; for we have received from that see our crown imperial," "which," added More, "till his grace with his own mouth so told me

I never heard before." Anything more defiant and exasperating than this could not well have been said. But it could not be laid hold of, and the charge of treason being too ridiculous to be proceeded with, More's name was struck out of the bill. When his daughter brought him the news, More calmly said, "I faith, Meg, quod diffitur, non aufertur: that which is postponed is not dropt." At another time, having asked his daughter how the court went and how Queen Anne did, he received for answer, "Never better; there is nothing else but dancing and sporting." To this More answered, "Alas, Meg, it pitieth me to remember unto what misery, poor soul, she will shortly come; these dances of hers will prove such dances that she will spurn our heads off like footballs; but it will not be long ere her head will dance the like dance."¹ So the speech runs in the *Life* by More's great-grandson; but in the only trustworthy record, the life by his son-in-law Roper, More's reply ends with the words, "she will shortly come." In this, as in other instances, the later statement has the appearance of having been an imaginative extension of the earlier.

In 1534 the Act of Supremacy was passed and the oath ordered to be tendered. More was sent for to Lambeth, where he offered to swear to the succession, but steadily refused the oath of supremacy as against his conscience. Thereupon he was given in charge to the abbot of Westminster, and, persisting in his refusal, was four days afterwards committed to the Tower. After a close and even cruel confinement (he was denied the use of pen and ink) of more than a year, he was brought to trial before a special commission and a packed jury. Even so More would have been acquitted, when at the last moment Rich, the solicitor-general, quitted the bar and presented himself as a witness for the Crown. Being sworn, he detailed a confidential conversation he had had with the prisoner in the Tower. He affirmed that, having himself admitted in the course of this conversation "that there were things which no parliament could do—e.g. no parliament could make a law that God should not be God," Sir Thomas had replied, "No more could the parliament make the king supreme head of the Church." By this act of perjury a verdict of "guilty" was procured from the jury. The execution of the sentence followed within the week, on the 7th of July 1535. The head was fixed upon London Bridge. The vengeance of Henry was not satisfied by this judicial murder of his friend and servant; he enforced the confiscation of what small property More had left, expelled Lady More from the house at Chelsea, and even set aside assignments which had been legally executed by More, who foresaw what would happen before the commission of the alleged treason. More's property was settled on Princess Elizabeth, afterwards queen, who kept possession of it till her death.

Sir Thomas More was twice married, but had children only by his first wife, who died about 1511. His only son, John, married an heiress, Ann Cresacre, and was the grandfather of Cresacre More, Sir Thomas More's biographer. His eldest daughter, Margaret (1505-1544), married to William Roper (1496-1578), an official of the court of king's bench and a member of parliament under Henry VIII., Edward VI. and Mary, is one of the foremost women in the annals of the country for her virtues, high intelligence and various accomplishments. She read Latin and Greek, was a proficient in music, and in the sciences so far as they were then accessible. Her devotion to her father is historical; she gave him not only the tender affection of a daughter but the high-minded sympathy of a soul great as his own.

More was not only a lawyer, a wit, a scholar, and a man of wide general reading; he was also a man of cultivated taste, who delighted in music and painting. He was an intimate friend of Holbein, whose first introduction to England was as a visitor to More in his house at Chelsea, where the painter is said to have remained for three years, and where he probably first met Henry VIII. Holbein painted portraits of Sir Thomas and his family. More was beatified by Leo XIII. in 1886.

The *Epistola ad Dorpium* exhibits More emphatically on the

¹ Cresacre More, p. 231.

side of the new learning. It contains a vindication of the study of Greek, and of the desirability of printing the text of the Greek Testament—views which at that date required an enlightened understanding to enter into, and which were condemned by the party to which More afterwards attached himself. On the other hand, he can at the most be doubtfully exculpated from the charge of having tortured men and children for heresy. It is admitted by himself that he inflicted punishment for religious opinion. Erasmus only ventures to say in his friend's defence "that while he was chancellor no man was put to death for these pestilent opinions, while so many suffered death in France and the Low Countries." His views and feelings contracted under the combined influences of his professional practice and of public employment. In the *Utopia*, published in Latin in 1516 (1st English translation, 1551), he not only denounced the ordinary vices of power, but evinced an enlightenment of sentiment which went far beyond the most statesmanlike ideas to be found among his contemporaries, pronouncing not merely for toleration, but rising even to the philosophical conception of the indifference of religious creed. It was to this superiority of view, and not merely to the satire on the administration of Henry VIII., that we must ascribe the popularity of the work in the 16th century. For as a romance the *Utopia* has little interest either of incident or of character. It does not, as has been said, anticipate the economical doctrines of Adam Smith, and much of it is fanciful without being either witty or ingenious. The idea of putting forward political and philosophical principles under the fiction of an ideal state was doubtless taken from Plato's *Republic*. The *Utopia* in turn suggested the literary form adopted by Bacon, Hobbes, Filmer, and other later writers; and the name of the book has passed into the language as signifying optimistic but impracticable ideals of reform.

For a bibliography of More's numerous works see the article in the *Dial. Nat. Bibl.* and the Catalogue of the Alfred Clee collection of books and portraits of or relating to Sir Thomas More which is preserved in the Guildhall Library, London. The more important of his works and their editions are here given. *Luciani dialogi . . . compluria opuscula ab Erasmo Roterdamo et Thoma Moro . . . traducta* (Paris, 1506 and 1514; Venice, Aldus, 1516, &c.) was accomplished by Erasmus and More in 1505. *The Lyfe of John Picus, earle of Mirandula . . .* printed by Wynkyn de Worde in 1510, translated by More from the Venice ed. of 1498, was edited by J. M. Rigg for the Tudor Library in 1890. *Historie of the pitifull Life and unfortunate Death of Edward the Fifth and the lion Duke of York with . . . Richard the Third* was written, according to Rastell, in 1513, and first printed in a corrupt version in Grafton's continuation of Harding in 1543; it is included by Rastell in his 1557 edition of More's *Workes*, but it has been suggested that the Latin original was by Cardinal Morton; as the *History of King Richard III.* it was edited by J. R. Lumby for the Pitt Press in 1883. *The Libellus vere aureus . . .* better known as *Utopia*, was printed at Louvain in 1516, under the superintendence of Erasmus, and appeared in many subsequent editions, many of them of great bibliographical value, the finest being the Basel edition of 1518. It was translated into the chief languages of Europe, and into English by Ralph Robinson as *A fruitful and Pleasant Worke of the best State of a Publique Weale, and of the newe Iye called Utopia* (Abraham Nell, 1551); modern editions are by J. Dibdin (2 vols., 1808), Professor E. Arber (English Reprints, 1869), by J. R. Lumby for the Pitt Press (1879), by William Morris at the Kelmscott Press (1893), by J. Churton Collins for the Clarendon Press (1904), by R. Steele for the King's Classics (1908), &c. Other translations of *Utopia* are by Gilbert Burnet (1684) and by A. Cayley's *Memoirs of More*, 2 vols., 1808. Against Luther and Tyndale Sir T. More wrote *A Dyalogue of Syr Thomas More, Knt.*, written in 1528 and printed by John Rastell in 1529; *Sir Thomas More's Answer to the fyrste parte of the Poyson'd booke . . . The Souper of the Lorde* (William Rastell, 1532) with a "Second Parte" in 1533. *The Apologye of Syr Thomas More*, written in 1533, is a defence of his own polemical style and of the treatment of heretics by the clergy. *A Dyaloge of Comfort against Tribulation*, printed by Rastell in 1533, was destined primarily for More's family.

More's English works were collected by William Rastell and published as *The Worke of Sir Thomas More Knyght* by Cawood, Waly and Tottel in 1557; his Latin works *Thomae Mori . . . Lucubrations* were partially collected at Basel 1563 and in 1566 (*omnia opera*) at Louvain; a fuller edition drawn chiefly from these two appeared at Frankfurt and Leipzig in 1689. Modern selections were edited by W. J. Walter (Baltimore, 1841), by T. E. Bridgett (*Wisdom and Wit of Blessed Thomas More*, London, 1891). His

correspondence with Erasmus is partly included in the editions of the Letters of Erasmus, and much of his correspondence is calendared in Gairdner's *Letters and Papers of Henry VIII.*, the letters written to his family in his last days being found in vol. viii.

The Mirror of Virtue in Worldly Greatness; or, the Life of Sir Thomas More was written by his son-in-law William Roper about the end of Mary's reign. It was preserved in MS. during the reign of Elizabeth, and handed down in copies, many of which were carelessly made. It was not given to the press till 1626, with the date of 1517. Reprints were made by Hearne (Oxford, 1716), by Lewis (1729, 1731), who added an appendix of documents, and by Singer (1817, 1822) and for the King's Library (1902). Roper's *Life* is the source of all the many subsequent biographies. More's *Life* in MS. (Harleian 6253 and elsewhere), anonymous, but by Nicolas Harpsfeld, was also written in Mary's reign. All that is material in this MS. is taken from Roper. Another anonymous *Life*, written in 1599, printed in Wordsworth's *Ecclesiastical Biography*, ii. 433-185, is chiefly compiled from Roper and Harpsfeld. The preface is signed R. Ba. (Robert Barnstable?). William Baret's *Life of More*, of which fragments are preserved in the Arundel Coll. (Brit. Mus.), is, unhappily, lost. Thomas Stapleton (*Tres Thomae, s. res Thomae, s. Thomae apostoli, s. Thomae archiepiscopi Cantuariensis, Thomae Mori* (Douay, 1588; Cologne, 1612) and the *Vita Thomae Mori* (separately), (Graz, 1689) translates Roper, interweaving what material he could find scattered through More's works and letters and the notices of him in the writings of his contemporaries. Cresacre More, great-grandson of Sir Thomas, compiled a new life about the year 1627. It was printed at Paris without date, but, according to the editor, J. Hunter, in 1631. The title of this edition is *The Life and Death of Sir Thomas More, Lord High Chancellor of England*, and it has with new title-page, 1642, 1726, 1828. This biography is cited by the subsequent biographers as an independent authority. But it is almost entirely borrowed from Roper and Stapleton. The additions made have sometimes the appearance of rhetorical amplifications of Roper's simple statements. At other times they are decorative miracles. The whole is couched in that strain of devotional exaggeration in which the lives of the saints are usually composed. The author seems to imply that he had received supernatural communications from the spirit of his ancestor. Stapleton, only thirty years after More's execution, hagiography had taken possession of the facts and was transmuting them into an edifying legend. Cresacre More's *Life* cannot be alleged as evidence for any facts which are not otherwise vouched. It has been remarked by Hunter that More's life and works have been all along manipulated for political purposes, and in the interest of the holy see. In Mary's reign, and in the tide of Catholic reaction, Roper and Harpsfeld wrote lives of him; Ellis Heywood dedicated his *Il Moro* (Florence, 1556) a fanciful account of More's life at Chelsea, to Cardinal Pole, and Tottel reprinted the folio of his English works. Stapleton's *Life* was written in 1588, when the poverty of England to the see of Rome was looked for by the Spanish invasion. In 1599, when there was a prospect of a disputed succession, the anonymous *Life* by Ro. Ba. was composed; and soon after Charles had allied himself with a Catholic, the *Life* by Cresacre More issued from the press. Hunter might have added that Stapleton was being reprinted at Graz at the time when the conversion of England was expected from James II. The later lives of Sir Thomas More have been numerous, the best being those by G. T. Rudhart *Thomas Morus, aus den Quellen bearbeitet* (Nuremberg, 1829); by T. E. Brant, *Life and Writings of Sir Thomas More* (1828); and by W. H. Hutten, *Life and Writings of Sir Thomas More* (1891). Other lives are by J. Hoddesdon (London, 1652, 1662); by Sir A. Cayley (2 vols., London, 1808); by Sir J. Mackintosh, *Lardner's Cab. Cyclop.* (London, 1831, 1844); and in *More's Works* (London, 1845); by Lord Campbell in *Lives of the Chancellors* (vol. 1, 1848-1850); by D. Nisard in *Renaissance et Réforme* (Paris, 1855); by Baumstark (Freiburg, 1879); by F. Seebohm in the *Oxford Reformers of 1408* (London, 1867). A biographical study on More's Latin poems is *Philomorus*, by J. H. Marsden (2nd ed., London, 1878). Cf. John Bruce, "Inscribed document rel. to the imprisonment and condemnation of Sir T. More," in *Archaeologia*, xxvii. 361-374; Southey, *Sir Thomas More, or Colloquies on the Progress and Prospects of Society* (London, 1829); Anne Manning, *The Household of Sir Thomas More* (1851, reprinted in King's Novels, 1905); S. Lee, *Great Englishmen of the Sixteenth Century* (1904). The tragedy of *Sir Thomas More*, edited by A. Dyce for the Shakespeare Society in 1844, and connected by some commentators with Shakespeare, was written about 1590, and therefore gives a nearly contemporary view of More. A later playwright, James Hurdis, made More's career the subject of a play in 1920. (M. P.)

MORÉAS, JEAN (1856-1910), French poet, born at Athens on the 15th of April 1856, was the grandson of Papadiomontopoulos, one of the heroes of Missolonghi. He was one of the leaders of the symbolist movement in French poetry, advocating a relaxation of the stringent rules governing French verse; but his early volumes of poems, *Les Syrtes* (1884), *Les Cantilènes* (1886), and *Le Pèlerin passionné* (1891) won recognition beyond the limits of this school. In the *XIX^e siècle* (August 11,

1885) he formulated the principles of the symbolists, defending them from the appellation of "decadent," and in the literary supplement of the *Figaro* (Sep 18, 1886) he published a manifesto justifying the innovations of the new school as the natural development of the prosody of Baudelaire, Mallarmé and Verlaine. *Le Pèlerin passionné* was sympathetically reviewed by Anatole France. As time went on he repudiated the licence claimed by the symbolists, and became the leader of an offshoot from the main body known as the *école romane*, the chief members of which are Raymond de la Tailhède, Maurice du Plessys, Ernest Raynaud, and the critic Charles Maurras. Moréas and his new followers returned to the traditional severity of French versification, and to the classical and antique tradition. His later volumes are *Poésies, 1886-1896* (1898), and *Stances* (6 vols., complete ed. 1905), *Histoire de Jean de Paris, roi de France* (1902), *Voyage en Grèce en 1897* (1902), *Contes de la vieille France* (1903), and a classic drama in verse, *Iphigénie à Aulis* (1904), in close imitation of Euripides, which was represented on the 24th of August 1903 in the ancient theatre of Orange, and subsequently at the Odéon in Paris. He died on the 31st of March 1910.

See Anatole France, *La Vie littéraire* (4th ser., 1892); A. van Bever and P. Léauté, *Poètes d'aujourd'hui, 1880-1900* (11th ed., 1905); P. Berthelot, art. "Symbolisme" in *La Grande encyclopédie*; and J. de Gourmont, *Jean Moréas, biographie critique* (1905).

MOREAU, GUSTAVE (1826-1898), French painter, was born in Paris on the 6th of April 1826. His father was an architect, who, discerning the lad's promise, sent him to study under Picot, a second-rate artist but clever teacher. The only influence which really affected Moreau's development was that of the painter Chassériau (1810-1857), with whom he was intimate when they both lived in the Rue Frochot, and of whom we find reminiscences even in his later works. Moreau's first picture was a "Pietà" (1852), now in the cathedral at Angoulême. In the Salon of 1853 he exhibited a "Scene from the Song of Songs" (now in the Dijon Museum) and the "Death of Darius" (in the Moreau Gallery, Paris), both conspicuously under the influence of Chassériau. To the Great Exhibition of 1855 he sent the "Athenians with the Minotaur" (in the Museum at Bourg-en-Bresse) and "Moses putting off his Sandals within Sight of the Promised Land." "Oedipus and the Sphinx," begun in 1862, and exhibited at the Salon of 1864, marked the beginning of his best period, during which he chose his subjects from history, religion, legend and fancy. In 1865 he exhibited "Medea and Jason" and "The Young Man and Death"; in 1866, the "Head of Orpheus" (in the Luxembourg Gallery); "Hesiod and the Muse," a drawing; and "The Peri," a drawing; "Prometheus" (in the Moreau Gallery); "Jupiter and Europa," a "Pieta," and "The Saint and the Poet," in 1869. After working in obscurity for seven years, he reappeared at the Salon in 1876 with "Hercules and the Hydra," "Saint Sebastian," "Salome Dancing" (presented to the Luxembourg by M. Hayem); and in 1878 with "The Sphinx's Riddle solved." "Jacob," and "Moses on the Nile." Moreau exhibited for the last time at the Salon of 1880, when he contributed "Helen" and "Galatea," to the Great Exhibition of 1880 he again sent the "Galatea" and "The Young Man and Death." He took prize medals at the Salon in 1864, 1865, 1860 and 1878. He was made knight of the Legion of Honour in 1875 and officer in 1883. He succeeded Delaunay as professor at the École des Beaux Arts, and his teaching was highly popular. When he died, on the 18th of April 1898, he bequeathed to the state his house, containing about 8000 pictures, water-colours, cartoons and drawings, which form the Moreau Gallery, one of the best organized collections in Paris, arranged by M. Rupp, his executor, and, together with Delaunay and Fromentin, one of his closest friends.

See Ary Renan, *Moreau* (Paris, 1900); Paul Fiat, *Le Musée Gustave Moreau* (Paris, 1900).

MOREAU, HÉGÉSIPPE (1810-1838), French lyric poet, was born in Paris on the 9th of April 1810. In his early youth his parents, who were poor, migrated to Provins, where the

mother went into service and the father took the post of usher in a public school. He went to Paris before 1830, and lived a Bohemian life. He was habitually houseless, and exposed himself to the dangers of a cholera hospital in the great epidemic of 1832 simply to obtain shelter and food. Then he revisited Provins and published a kind of satirical serial called *Diogène*. Some years of this life entirely ruined his health, and it was only just before his death that he succeeded in getting his collected poems published, selling the copyright for £4 sterling and 80 copies of the book. This volume, *Myosotis*, was received not unfavourably, but the author's death on the 20th of December 1838, in a refuge of the destitute, created an interest in it which was proportionately excessive. Moreau's work has a strong note of imitation, especially in his earlier songs, distinguished from those of his model, Béranger, chiefly by their elegiac note. Some of his poems, such as the elegy *La Voulaie* (1837) and the charming romance *La Fermière* (1835), have great sweetness and show incontestable poetic power. Moreau wrote some charming prose stories: *Le Gué de chène*, *La Souris blanche*, &c.

MOREAU, JEAN VICTOR MARIE (1763-1813), French general, was born at Morlaix in Brittany on the 14th of February 1763. His father was an avocet in good practice, and instead of allowing him to enter the army, as he attempted to do, insisted on his studying law at the university of Rennes. Young Moreau showed no inclination for law, but revelled in the freedom of a student's life. Instead of taking his degree he continued to live with the students as their hero and leader, formed them into a sort of army, which he commanded as their provost, and when 1789 came he commanded the students in the daily affrays which took place at Rennes between the young noblesse and the populace. In 1791 he was elected a lieutenant-colonel of the volunteers of Ille-et-Vilaine. With them he served under Dumouriez, and in 1793 the good order of his battalion, and his own martial character and republican principles secured his promotion as general of brigade. Carnot, who had an eye for the true qualities of a general, promoted him to be general of division early in 1794, and gave him command of the right wing of the army under Pichegru, in Flanders. The battle of Tourcoing established his military fame, and in 1795 he was given the command of the Army of the Rhine-and-Moselle, with which he crossed the Rhine and advanced into Germany. He was at first completely successful, won several victories and penetrated to the Isar (see FRENCH REVOLUTIONARY WARS), but at last had to retreat before the archduke Charles. However, the skill he displayed in conducting his retreat—which was considered a model for such operations—greatly enhanced his own reputation, the more so as he managed to bring back with him more than 5000 prisoners. In 1797 he again, after prolonged difficulties caused by want of funds and material, crossed the Rhine, but his operations were checked by the conclusion of the preliminaries of Leoben between Bonaparte and the Austrians. It was at this time he found out the traitorous correspondence between his old comrade and commander Pichegru and the émigré prince de Condé. He had already appeared as Pichegru's defender against imputations of disloyalty, and now he foolishly concealed his discovery, with the result that he has ever since been suspected of at least partial complicity. Too late to clear himself, he sent the correspondence to Paris and issued a proclamation to the army denouncing Pichegru as a traitor. He was dismissed, and it was only when in 1799 the absence of Bonaparte and the victorious advance of Suvárov made it necessary to have some tried and experienced general in Italy that he was re-employed. He commanded the Army of Italy, with little success, for a short time before being appointed to the Army of the Rhine, and remained with Joubert, his successor in Italy, till Novi had been fought and lost. Joubert fell in the battle, and Moreau then conducted the retreat of the army to Genoa, where he handed over the command to Championnet. When Bonaparte returned from Egypt he found Moreau at Paris, greatly dissatisfied with the Directory both as a general and as a republican, and obtained his assistance in

the *coup d'état* of 18 Brumaire, when Moreau commanded the force which confined two of the directors in the Luxembourg. In reward, the First Consul again gave him command of the Army of the Rhine, with which he forced back the Austrians from the Rhine to the Isar. On his return to Paris he married Mlle Hullot, a Creole of Josephine's circle, an ambitious woman who gained a complete ascendancy over him, and after spending a few glorious weeks with the army in Germany and winning the celebrated victory of Hohenlinden (Dec. 3, 1800) he settled down to enjoy the fortune he had acquired during his campaigns. His wife collected around her all who were disappointed with the aggrandisement of Napoleon. This "club Moreau" annoyed Napoleon, and encouraged the Royalists, but Moreau, though not unwilling to become a military dictator to restore the republic, would be no party to an intrigue for the restoration of Louis XVIII. All this was well known to Napoleon, who seized the conspirators. Moreau's condemnation was procured only by great pressure being brought to bear by Bonaparte on the judges; and after it was pronounced the First Consul treated him with a pretence of leniency, commuting a sentence of imprisonment to one of banishment. Moreau passed through Spain and embarked for America, where he lived in quiet and obscurity for some years at Morrisville, New Jersey, till news came of the destruction of the *grande armée* in Russia. Then, probably at the instigation of his wife, he committed the last and least excusable of the series of well-meant political errors that marked his career. Negotiations were set on foot with an old friend in the circle of republican intriguers, Bernadotte, who, being now crown prince of Sweden and at the head of an army opposing Napoleon, introduced Moreau to the tsar Alexander. In the hope of returning to France to re-establish the régime of popular government, Moreau gave advice to the allied sovereigns as to the conduct of the war, but fortunately for his fame as a patriot he did not live to invade France. He was mortally wounded while talking to the tsar at the battle of Dresden on the 27th of August 1813, and died on the 2nd of September. He was buried at St Petersburg. His wife received a pension from the tsar, and was given the rank of *maréchale* by Louis XVIII., but his countrymen spoke of his "defection" and compared him to Dumouriez and Pichegru.

Moreau's fame as a general stands very high, though he was far from possessing Napoleon's transcendent gifts. His combinations were skilful and elaborate, and his temper always unflinched when most closely pressed. Moreau was a sincere republican, though his own father was guillotined in the Terror. He was fortunate in the moment of his death, though he would have been more so had he died in America. He seems by his final words, "Soyez tranquilles, messieurs; c'est mon sort," not to have regretted being removed from his equivocal position as a general in arms against his country.

The literature on Moreau is copious, the best book being C. Jochims, *General Moreau—Abriss einer Geschichte seines Lebens und seiner Feldzüge* (Berlin, 1814). A more ordinary work is A. de Beauchamp, *Vie politique, militaire, et privée du Général Moreau*, translated by Philippart (London, 1814); and there is a curious tract on his death in Russian, translated into English under the title, *Some Details Concerning General Moreau and his Last Moments*, by Paul Svinin (London, 1814).

MOREAU DE SAINT MÉRY, MÉDÉRIC LOUIS ÉLIE (1750-1819), French politician, was born at Fort de France, in the island of Martinique, on the 28th of January 1750. He came to Paris at the age of nineteen, and became an avocet at the parlement of Paris. He subsequently returned to Martinique to practise law, and in 1780 was appointed member of the colonial council of San Domingo. Returning to Paris in 1784, he received a commission to study the legislation of the French colonies, and published *Lois et constitutions des colonies françaises de l'Amérique sous le Vent de 1750 à 1785*. In 1789 he was president of the assembly of the electors of Paris, played an active part in the early days of the Revolution, and was designated by Martinique deputy to the Constituent Assembly. His moderate ideas were the occasion of his arrest after the 10th of August 1792, but he contrived to escape to the United States, opened

a bookseller's shop at Philadelphia, and published *Description topographique et politique de la partie espagnole et de la partie française de l'Île de Saint-Dominique* (1796-1798). Returning to France in 1799, he became historiographer to the navy and councillor of state, and drafted in part the colonial and maritime code. In 1802 he was appointed by the First Consul administrator of the duchies of Parma, Piacenza, and Guastalla, but was dismissed in 1806 for slackness in repressing insubordination. From that date until his death he lived on a pension paid him by the Empress Josephine, who was a kinswoman of his.

See Fournier-Tescay, *Discours prononcé aux obsèques de Moreau le 30 Janvier 1819*; Silvestre, *Notice sur Moreau* (Paris, 1819).

MORECAMBE, a municipal borough, watering-place and seaport in the Lancaster parliamentary division of Lancashire, England, on Morecambe Bay, 236 m. N.W. by N. from London by the London & North-Western railway; served also by the Midland railway. Pop. (1901), 11,798. A fine promenade extends along the shore; there are a quay and a pier, a winter garden, and all the appointments of a seaside resort. The Midland railway is the harbour authority. The town was incorporated in 1902, and the corporation consists of a mayor, 6 aldermen and 16 councillors. The former alternative name was Poulton-le-Sands. Area, 1801 acres.

MOREL, the surname of several French classical scholars and printers in the 16th and 17th centuries, known for their editions of classical authors and the Fathers. (1) **GUILLAUME MOREL** (1505-1564) was born at Tilleul in Normandy. After acting as proof-reader in a Paris firm, he set up for himself, and subsequently succeeded Turnebus as king's printer in 1555. His most important work was *Thesaurus vocum omnium latinorum*, containing a number of quotations from Greek authors, taken from hitherto unpublished MSS. in the Paris library. (2) **FÉDÉRIC** (as he always called himself, not Frédéric) **MOREL**, surnamed the Elder (1523-1583), was born in Champagne. He was of noble family, and was not connected with Guillaume Morel. About 1550 he married the daughter of the famous printer, Michel de Vascosan, in 1557 set up in business in the rue Saint Jean de Beauvais, and in 1571 was appointed printer to the king. His chief publications were the *Declamations* of Quintilian and *L'Architecture de Philibert Delorme*. (3) **FÉDÉRIC MOREL**, son of the preceding, surnamed the Younger (1558-1630), was one of the greatest Greek scholars of his time. In addition to the management of his father's business, to which he succeeded, he held the professorship of eloquence at the Collège de France. The number of his translations and commentaries on the Fathers and classical authors (Aristotle, Dio Chrysostom, Strabo) was very large; special mention may be made of his revised edition of Amyot's translation of *Plutarch* and his Latin translations of some of the dissertations of Maximus of Tyre, of Libanius, Hierocles and Theodoret. His commentary on the Psalms is still considered valuable. (4) **CLAUDE MOREL** (1574-1626), brother of the preceding, also published editions of many of the Fathers and other authors, with learned prefaces and notes. (5) **CHARLES MOREL** (1602-1640) was printer and secretary to the king. He followed the example of the other members of his family, and issued the works of Clement of Alexandria, Gregory of Nazianzen, Cyril, Synesius and Chrysostom, and the *Concilia generalia et provincialia* of the German theologian Severin Bini. (6) **GILLES MOREL**, brother of the preceding (the dates of his birth and death are unknown), was the last representative of this learned family. The number of his publications was small, but some of them were of great importance, the chief being the *Grande bibliothèque des pères*, in 17 folio vols. (1643).

See M. Maittaire, *Historia typographorum aliquot parisiensium* (1717), for all the above; Féderic Morel the elder is the subject of a monograph by J. Dumoulin (Paris, 1901).

MORELIA (formerly Valladolid), a city of Mexico and capital of the state of Michoacán, 125 m. direct and 234 m. by rail W. by N. of the city of Mexico, near the southern margin of the great Mexican plateau, 6398 ft. above sea-level, in lat. 19° 42' N. long., 100° 54' W. Pop. (1900), 37,278, partly Indians

and mestizos. Morelia is served by a branch of the Mexican National railway; its station is outside the city, with which it is connected by a small tramway line. The city is built on a rocky hill rising from the Guayángareo valley, which gives to it a strikingly picturesque appearance. It has the usual rectangular plan, with several pretty squares and straight, clean, well-paved streets. Facing the *plaza mayor*, now called the Plaza de los Martires because of the execution there of the patriot Matamoros in 1814, is the cathedral, one of the finest specimens of the old Spanish renaissance church architecture in Mexico.

Among its interior adornments is an onyx font, some fine wood carving in the choir, and the silver doors to the shrines of its chapels. Opposite the cathedral is the government palace, which also contains the public library. The municipal government is housed in an ancient tobacco factory converted to public uses, and a fine old Capuchin convent now serves as a public hospital. The Paseo, or public park, is distinguished for its fine trees and flowers. The Morellanos are noted for their love of music, and musical competitions are held each year, the best band being sent to the city of Mexico to compete with similar organizations from other states. The public water-supply is brought into the city over a fine old aqueduct (3 m. in length, carried on arches), which was built in 1785 by the bishop of the diocese as a famine relief work. In common with the state of Michoacán, Morelia is a stronghold of clericalism and conservatism. A large number of private schools are maintained through Church influence in opposition to the public schools. Conspicuous among these is a large girls' school. Another institution is the college of San Nicolas de Hidalgo, which was founded at Patzcuaro in 1540 by Bishop Quiroga (who had been sent into Michoacán to redress the wrongs committed by Nuño de Guzman), was removed to Valladolid (Morelia) a few years later to be combined with a local college, and was rebuilt in 1882. It is the oldest existing collegiate institution in Mexico; in it Hidalgo once taught and Morelos was a student. The city's manufactures include cotton, woolen and silk textiles, cigars and cigarettes, and *dulces*, or sweetmeats, Morelia being noted throughout Mexico for the latter, particularly for a variety called Guayabate.

Morelia, first known as Valladolid, was founded in 1541 by Viceroy Mendoza. In 1582 Valladolid replaced Patzcuaro as the capital of Michoacán. It was the birthplace of both Morelos and Iturbide, and was captured by Hidalgo at the beginning of the revolutionary outbreak of 1810-11, and by Iturbide in 1821 when on his march to Mexico City, where he was crowned emperor. Its name was changed to Morelia in 1828, in honour of the revolutionary leader José María Morelos y Pavón, and in 1863 it was made the see of an archbishop.

MORELL, JOHN DANIEL (1816-1891), British educationalist, was born on the 18th of June at Little Baddow, Essex, where his father was minister of the Congregational church (1799-1852). He proceeded to Homerton College in 1833, where he studied theology under Dr Pye Smith. He then entered Glasgow University, where he took his M.A. degree in 1841. Subsequently he studied philosophy and theology under Fichte at Bonn, and returned to England to undertake the pastorate of the Congregational church at Gosport. After three years' work, he decided to give up the ministry in favour of philosophical work. As early as 1846 he made his name by his *Historical and Critical View of the Speculative Philosophy of Europe in the Nineteenth Century*, which brought him to the notice of Lord Lansdowne, who made him an inspector of schools. From 1848 till 1876 he was active in this capacity. As a result of his experience he published numerous educational works, e.g. *The Analysis of Sentences* (1852), *The Essentials of English Grammar and Analysis* (1855), *Handbook of Logic* (1855), *Grammar of the English Language* (1857). He also published four lectures on *The Philosophical Tendencies of the Age* (1848), *The Philosophy of Religion* (1849), *Fichte's Contributions to Moral Philosophy* (1860), *Philosophical Fragments* (1878), *An Introduction to Mental Philosophy on the Inductive Method* (1884). He died on the 1st of April 1891.

MOREL-LADEUIL, LÉONARD (1820-1888), French goldsmith and sculptor, was born at Clermont-Ferrand. He was apprenticed first to Morel, a manufacturer of bronzes, under whom he became one of the most expert chasers, or *ciseleurs*, in France, and then to Antoine Vechte, to acquire the art of *reponssé* (q.v.)—the art in which he was to excel. He studied further under J. J. Feuchère and then attracted the notice of the comte d'Orsay and the duc de Morny, through whose recommendation the French government, desirous of popularizing the idea of the new Imperialism, commissioned him to produce the "Empire Shield." Napoleon III. notified his warm approval, but the trade, annoyed that a craftsman should obtain commissions direct, resented the innovation and thenceforward boycotted the young artist, whose beautiful and poetic vase, "Dance of the Willis" (the spirits dancing round the vase, above the lake represented on a dish below) none would take. He was encouraged nevertheless by a foreign dealer in Paris, Marchi, who employed him on statuettes, mainly religious in character, until 1859, when Messrs Eikington, in view of the great exhibition of 1862, engaged him to work in Birmingham for three years in *reponssé*, assuring him a free hand. Following his silver "Night" came "Day," and then the "Inventions" vase, which placed him at once at the top of his profession. This was followed by the beautiful plateau called "Dreams," which was subscribed for (£1500) by Birmingham as the town wedding-gift to the prince and princess of Wales. Morel-Ladeuil's contract was then renewed for five years, but as a matter of fact he remained with the firm for twenty-three years at their London house, the first result being his masterpiece, the "Milton Shield: Paradise Lost" (in *reponssé* steel and silver), which was the sensation of the Paris Exhibition. It was bought by the English government for £3000, and thousands of copies made by "galvanoplastie" or electrotype were sold and spread all over the world. Then after "The Months" came another masterpiece, the "Helicon Vase," in steel, silver, and gold, priced at £6000, which in course of time was presented by the ladies and gentlemen of the royal house to Queen Victoria on her first jubilee. For the Philadelphia Exhibition (1876) Morel-Ladeuil produced "A Pompeian Lady at her Toilet," following it in 1878 with the "Bunyan Shield," a companion to the Milton. After putting forth his reliefs "The Merry Wives of Windsor," "The Merchant of Venice," and "Much Ado about Nothing," in view of his failing health he retired to Boulogne, where he died of angina pectoris on the 15th of March 1888, and was buried with much ceremony at Clermont-Ferrand. His total work, apart from the productions of his youth, numbers 35 pieces, which richly reveal his elegant and refined fancy and grace, his feeling for correct and dainty ornament, and his love of pure art marked by an elevated if rather sentimental taste and a noble style.

See *L'Œuvre de Morel-Ladeuil, sculpteur-ciseleur*, by L. Morel (Paris, 1904).

MORELLET, ANDRÉ (1727-1819), French economist and miscellaneous writer, was born at Lyons on the 7th of March 1727. He was one of the last survivors of the *philosophes*, and in this character he figures in many memoirs, such as Mme de Rémusat's. He was educated by the Jesuits in his native town, and at the Sorbonne; he then took holy orders, but his designation of abbé was the chief thing clerical about him. He had a ready and biting wit, and Voltaire called him "L'Abbé Mord-les." His work was chiefly occasional, and the most notable parts of it were a smart pamphlet in answer to Charles Palissot's scurrilous play *Les Philosophes* (which procured him a short sojourn in the Bastille for an alleged libel on Palissot's patroness, the princesse de Robeck), and a reply to Galiani's *Commerce des blés* (1770). Later, he made himself useful in quasi-diplomatic communications with English statesmen, and was pensioned, being, moreover, elected a member of the Academy in 1785. A year before his death in Paris on the 12th of January 1819 he brought out four volumes of *Mélanges de littérature et de philosophie du XVIII^e siècle*, composed chiefly

of selections from his former publications, and after his death appeared his valuable *Mémoires sur le XVIII^e siècle et la Révolution* (2 vols., 1821).

A bibliography of his numerous works is given in Quérard's *La France littéraire*, vol. vi.; see also Sainte-Beuve, *Causeries du lundi*, vol. 1.

MORELLI, GIOVANNI (1816-1891), Italian patriot and art critic, was born at Verona on the 16th of February 1816. He was educated first at Bergamo, the home of his mother, who had removed thither on the death of her husband; and then at Aarau in Switzerland. At the age of eighteen he commenced his university career at Munich, being debarred as a Protestant from entering any Italian college, and became the pupil of Ignatius Döllinger, the celebrated professor of anatomy and physiology. Natural philosophy and medicine were the studies to which he specially devoted himself, but he was also keenly interested in all scientific and literary pursuits. At Munich, and later at Erlangen, Berlin and Paris, his brilliant gifts and independence of thought and judgment attracted the attention of the most distinguished men of the day. In Paris he became intimate with Otto Münder, and his intercourse with that eminent art critic was not without its effect in determining the direction of his future studies; and, during a summer spent in Switzerland, he formed a friendship with Louis Agassiz; whose teaching made a deep and lasting impression upon him. On his return to Italy in 1840 he became associated in Florence with that band of patriots who were strenuously labouring for the deliverance of their country from the oppressive Austrian rule. He took an active part in the war of 1848, and was subsequently chosen by the provisional Lombard government to plead the cause of Italian unity before the German parliament assembled at Frankfurt. In 1860, in recognition of the great services rendered to his country by Morelli, Victor Emmanuel named him a citizen of the Sardinian kingdom, and in the following year he was elected deputy for Bergamo to the first free Italian parliament. He was a staunch supporter of Cavour, and, though never a leading politician, exercised a considerable influence over the most prominent statesmen of the Right, who valued his sound judgment, integrity, moderation and foresight. One of his first acts after his election was to draw the attention of parliament to the urgent need of reform in the administration of matters relating to the fine arts. In consequence of his representations, a commission was appointed with the object of bringing under government control all works of art which could be considered public property. The commission, of which Morelli was named president, began its work in Umbria and the Marches, and he appointed as his secretary G. B. Cavalcaselle, who was then engaged in collecting materials for a work on Italian art. According to one who knew Morelli well, much that Cavalcaselle then learned from his chief was embodied in the well-known *History of Painting*, which was published in 1864 in conjunction with Sir Joseph Crowe.

The immediate result of Morelli's first labours in the Marches was the passing of the law, which bears his name, strictly prohibiting the sale of works of art from public and religious institutions. In 1873 he was named a senator of the kingdom of Italy, having voluntarily resigned his seat in the Lower House owing to the increasingly democratic tendencies of the Chamber. In Rome, the seat of the government since 1870, he spent several months of each year; but his settled home was Milan, whither he had removed from Bergamo in 1874. Here he published some of his researches into the history of Italian art. In order to be free to speak his mind unreservedly, he determined to adopt a pseudonym and to write in German. His first contributions, a series of articles on the Borghese Gallery, were published in Lützow's *Zeitschrift für bildende Kunst* between the years 1874 and 1876. Posing as an art-loving Russian, who puts forth his opinions with the utmost diffidence, he adopted the pseudonym of Ivan Lermolieff—an anagram of his own name with a Russian termination—and described his essays as *Ein kritischer Versuch*, translated from the Russian by Johannes Schwarz, this time a Germanized form of Morelli.

The originality of the method recommended by the author for studying art, the general soundness of his critical opinions, and the many new (and apparently correct) attributions suggested for pictures in the Borghese Gallery and elsewhere, attracted the attention of all students of art; but failure attended every attempt to discover the identity of the Russian critic. In 1880 Morelli published a small book under the same pseudonym, entitled, *Die Werke italienischer Meister in den Galerien von München, Dresden und Berlin*. The appearance of this volume, which was cast in so original a form that it was altogether unlike anything which had preceded it in the realm of art scholarship, created an extraordinary sensation. The daring opinions expressed by the author struck at the roots of all existing art criticism, and were often diametrically opposed to the views of the most renowned art historians of the day. The importance of the work could not be denied, and in spite of determined opposition and searching and bitter attacks, it gained general recognition as a standard work which no serious student of art could ignore. It inaugurated a new and more scientific method of criticism, and marks an epoch in the art studies of the 19th century. The book was translated into English in 1883, with Morelli's own name upon the title-page, and a few years later into Italian. In the decade between 1880 and 1890 he contributed three articles to German periodicals: *Perugino oder Raffael, Raffaels Jugendentwicklung, Noch einmal das senesische Skizzenbuch*. Being addressed to critics who had challenged his opinions, they are somewhat polemical in character, but contain a mass of information, more especially about drawings. He also wrote a skit on art connoisseurship in Europe, intending to publish it in English as the reflections of an American on the follies of art critics in the Old World; but he never carried out his intention, though some portion of the MS. was embodied in the first part of his *Critical Studies*. This volume, the first of a series of three which, under the title of *Kunstkritische Studien*, was to contain all Morelli's contributions to art literature, was published in 1890. The first part, cast in dialogue form, contains a detailed exposition of his method. Then follow *The Borghese Gallery*, a reissue of his former articles with many important additions, and *The Doria Gallery*, an entirely new contribution. The second volume deals with the galleries of Munich and Dresden, and is a revised edition of the first two parts of the original book of 1880; but here again copious additions rendered it practically a new book. The third volume was to treat of the Berlin Gallery, and was also to contain an exhaustive account of the drawings of Italian masters, but it was destined never to be carried out. Morelli was taken seriously ill towards the middle of February 1891, and was found to be suffering from heart disease and other complications; a fortnight later he died at Milan, on the 28th of February. His collection of drawings by the old masters he bequeathed to his pupil, Dr Frizzoni, and his pictures, over 100 in number, to the city of Bergamo, where they are now exhibited as the Galleria Morelli in two rooms of the Accademia Carrara. A striking half-length portrait by Lenbach, who presented it to his friend in 1886, forms part of the collection. In memory of Morelli a bronze bust of him by a Milanese artist has been placed in the Brera; but his features are more worthily presented in a second portrait by Lenbach and in a life-like pastel sketch executed by the Empress Frederick in 1884, when he was her guest at Baveno. After the death of Morelli the first two volumes of his *Critical Studies* were published in English, Sir Henry Layard, one of his most intimate friends, contributing to the first a biographical sketch of the author; and the fragmentary MS. of the third volume was published in German by Dr Frizzoni, under whose editorship an Italian translation of the first volume has also been issued.

Morelli found art criticism uninspired, unscientific and practically worthless. To be of any real value he held that historical, documentary and traditional knowledge respecting works of art was only of secondary importance as compared with the evidence to be derived from the study of the pictures themselves. He contended that art criticism must be conducted

on scientific principles and follow a strict course of inductive reasoning. A painting should be subjected to a searching analysis, and its component parts and minutest details submitted to methodical and exact investigation.

The study of the individual parts and forms was, in his estimation, of the highest importance, for they were not mere incidents, but the outward and visible seal of an artist's character stamped upon his work, and obvious to all who had eyes to see. By diligent observation of the forms the rudiments of the language of art might be mastered, and the first step taken towards initiating a methodized system of study. The education of a critic consists chiefly in learning to compare, and Morelli soon recognized the value of systematic comparison in the study of art. By the combined methods of critical analysis and comparative observation he found the clue he had so long been seeking. Studying one day in the Uffizi, it suddenly struck him that in a picture by Botticelli containing several figures the drawing of the hands was remarkably similar in all; that the same characteristic but plebeian type, with bony fingers, broad square nails, and dark outlines, was repeated in every figure. Turning to the ears, he observed that they also were drawn in an individual manner, and that in the numerous figures in which the ear was visible the same typical form recurred. Having noted these fundamental forms, he proceeded to an examination of other works by this painter, and found that the same forms were exactly repeated, together with other individual traits which seemed distinctive of the master: the characteristic type of head and expression, the drawing of the nostrils, the vitality of movement, the disposition of drapery, harmony of colour (where it had not been tampered with by the restorer), and quality of landscape. In all Botticelli's true works the presence of these and other characteristics proclaimed their genuineness. In paintings where the forms and types were those of the painter, but where vitality, movement, and all deeper qualities were absent, Morelli recognized works executed from the master's cartoons; while in pictures where neither types nor forms responded to the test, and where only a general family likeness connected them with Botticelli, he discerned the productions of pupils and imitators. After applying his method to the works of Botticelli, he proceeded to examine those of other Florentine masters, and afterwards of painters of other Italian schools, everywhere meeting with results to him not less convincing. If the drawing of the hand and ear were not always conspicuous, there were other peculiarities of this language of form to aid in the identification of a master: the treatment of the hair, as in Piero dei Franceschi; the indication of the sinews, as in Foppa; the drawing of the eye, as in Liberale da Verona; the modelling of the eyelid and upper lip, as in Ambrogio de Predis; the form of the feet, as in Lippi. In short, all apparently insignificant details were of importance in his plan of study, for to him they were like the signature of the master. (C. J. F.*)

MORELOS, an inland state of Mexico on the southern slope of the great Mexican plateau, lying S. of the Federal District, with the states of Puebla on the E. and S.E., Guerrero on the S., and Mexico on the W., N. and N.E. Pop. (1900), 161,697, including a large percentage of Indians and mixed bloods. Area, 2773 sq. m. Its surface is roughly broken by mountain ranges extending southward from the Sierra de Ajusco, forming numerous valleys opening southward. It is drained by the Amacuzac river, a northern tributary of the Mescala, or Balsas. There is a wide variation of climate for so small a territory, the higher elevations of the Sierra de Ajusco being cold and humid (the Mexican Central crosses the range at an elevation of 9974 ft.); the lower spurs mild, temperate and healthy, the lower valleys subtropical, hot and unhealthy. The rainfall is light in the lower regions and irrigation is generally employed. Notwithstanding its mountainous character, Morelos is one of the most flourishing agricultural states of Mexico, producing sugar, rice, Indian corn, coffee, wheat, fruit and vegetables. Although the state is supposed to have several of the minerals found in this part of Mexico (silver, cinnabar, iron, lead, gold, petroleum and coal), its mining industries continue undeveloped

and neglected. San Antonio, a suburb of Cuernavaca, is noted for its pottery, which is highly attractive in form and colour, and finds a ready market among the visitors to that city. Morelos is traversed by two railway lines—the Interoceanic from N.E. to S.W., and the Mexican Central almost N. and S., the latter affording direct communication between the national and state capitals.

The capital, CUERNAVACA (pop. 9584 in 1900), 47 m. S. of the city of Mexico on the Mexican Central railway, is one of the most picturesque towns in Mexico. It dates from the time of Cortés, who built for himself a residence there, and had the town included in the royal grant to himself in 1529. Maximilian had a villa there, and many of the public men of Mexico, natives of the lowlands, have made their homes there rather than in the national capital. The palace of Cortés is now occupied by the state legislature and by various public offices, and Maximilian's villa by a school.

After the capital the largest city in the state is Cuautla Morelos, or Ciudad Morelos (pop. 6269 in 1900), 27 m. east by south of Cuernavaca, on the Interoceanic railway, and in a rich sugar-producing district. Some of the largest and most modern sugar-mills of Mexico are in the Cuautla district. There are hot sulphur springs here. The town is celebrated in Mexican history for the intrepid defence of the place by José María Morelos (1765-1815), the patriot leader, against a greatly superior royalist force, from the 19th of February to the 2nd of May 1812, when he cut his way through the attacking army and escaped. Other important towns are Yauatepec (6139 in 1900), 16 m. east of Cuernavaca, on the Interoceanic line; Teceteca, 13 m. south-west of the capital, a characteristic Indian town near the pyramid of Xochicalco, and Jojutla, 21 m. south of the capital, on the Interoceanic railway near the southern boundary of the state. An interesting local phenomenon is that of lake Tequesquite, which was formed by the subsidence of a large area of ground about the middle of the 19th century, carrying with it an old town of the same name. The hollow filled with water, and the spire of the old church is still to be seen in the middle of the lake.

MORESNET, a small neutral state lying on the borders of Prussia and Belgium, 4 m. S.W. of Aix-la-Chapelle, and embracing an area of nearly 1400 acres. Its only village is that of Neutral Moresnet, also called Kelmis or Kalmis, with 2800 inhabitants. Just over the Prussian frontier is Prussian Moresnet, with 650 inhabitants, and in Belgium is Belgian Moresnet, with about 1200. Moresnet, strictly Montzen-Moresnet, is, as its name implies, a mountain, under which is the extremely valuable zinc mine owned by the "Vieille Montagne Company," which is a Belgian undertaking. The profit of the customs is divided between the two states, but a tendency has been observed to convert it gradually into a German possession. The state of Moresnet owes its origin to the general European settlement of 1815. No agreement could be reached about the ownership of this small district, and it was made a neutral state under the joint government of Prussia and Belgium. This arrangement lasted until 1841, when Moresnet was given an administration of its own, this being composed of a burgo-master and a council of ten members. The inhabitants decide individually whether they will perform military service for Prussia or for Belgium, and also whether they will accept the jurisdiction of the Prussian or of the Belgian courts.

See Hoch, *Un Territoire oublié au centre de l'Europe* (Bern, 1881); Schröder, *Das grossbritische Gebiet von Moresnet* (Aix-la-Chapelle, 1902); and Spandau, *Zur Geschichte von Neutral-Moresnet* (Aix-la-Chapelle, 1904).

MORETON BAY CHESTNUT, a tall tree known botanically as *Casstanospermum australe* (natural order Leguminosae), native of Queensland and New South Wales. The pods are almost cylindrical, about 9 in. long and 2 in. broad, and are divided interly by a spongy substance into three to five cells, each of which contains a large chestnut-like seed. The seeds are roasted and eaten by the natives; the timber, which somewhat

resembles walnut, is soft, fine-grained, and takes a good polish, but is not durable.

MORETO Y CAVANA, AGUSTIN (1618-1661), Spanish dramatist and playwright, was baptized at Madrid on the 9th of April 1618. He graduated at Alcalá in December 1639, and resided in Madrid till 1654, when he removed to Toledo, took orders, and became chaplain to the primate Baltasar de Moscoso y Sandoval. He died at Toledo on the 28th of October 1661, while engaged on *Santa Rosa*, a play which was completed by Pedro Francisco Lanini. The first volume of his dramas was published in 1654; the second and third volumes appeared in 1676. The most celebrated of his pieces is *El Desdén con el Desdén*, imitated by Molière in *La Princesse d'Élide*, by Gozzi in *La Principessa filosofo*, and by Schreyvogel in *Donna Diana*. It is characteristic that four episodes in *El Desdén con el Desdén* are taken from four separate plays of Lope de Vega's (*La Vengadora de las mujeres*, *Las Milagros del desprecio*, *De Corsario à corsario*, and *La Hermosa fea*). Moreto borrows from Castro, Tirso de Molina and others to an extent which is indicated at length in Fitzmaurice-Kelley's *Littérature espagnole* (Paris, 1904), but his adaptation shows great dexterity and charm.

MORETTO, IL ("The Blackamoor," a term which has not been particularly accounted for), the name currently bestowed upon ALESSANDRO BONVICINO (1498-1554), a celebrated painter of Brescia, Venetian school. He was born at Rovato, in the Brescian territory, in 1498, and studied, first under Fioravante Ferramola of Brescia, afterwards, still youthful, with Titian in Venice. His own earlier method, specially distinguished by excellent portrait-painting, was naturally modelled on that of Titian. Afterwards he conceived a great enthusiasm for Raphael (though he does not appear to have ever gone to Rome), and his style became partially Raphaellesque. It was, however, novel in its combination of diverse elements, and highly attractive—with fine pencilling, a rich yet not lavish use of perspective and decorative effects, and an elegant opposition of light and shade. The human figure is somewhat slender in Bonvicino's paintings, the expression earnestly religious, the flesh-tints varied, more so than was common in the Venetian school. The backgrounds are generally luminous, and the draperies well modified in red and yellow tints with little intermixture of blue. The depth of Bonvicino's talent, however, was hardly in proportion to its vigour and vivacity; and he excelled more in sedate altarpieces than in subjects of action, and more in oil-painting than in fresco, although some fine series of his frescoes remain, especially that in the villa Martiniengo at Novarino, near Brescia. Among his celebrated works in the city are—in the church of S. Clemente, the "Five Virgin Martyrs," and the "Assumption of the Madonna" (this latter may count as his masterpiece); in S. Nazaro e Celso, the "Coronation of the Madonna"; in S. Maria della Grazie, "St Joseph"; in S. Maria de' Miracoli, "St Nicholas of Bari." In the Vienna Gallery is a "St Justina" (once ascribed to Pordenone); in the Städel Institute, Frankfurt, the "Madonna enthroned between Sts Anthony and Sebastian"; in the Berlin Museum, a colossal "Adoration of the Shepherds," and a large votive picture (one of the master's best) of the "Madonna and Child," with infant angels and other figures above the clouds, and below, amid a rich landscape, two priests; in the National Gallery, London, St Bernardin and other saints and two impressive portraits. Il Moretto is stated to have been a man of child-like personal piety, preparing himself by prayer and fasting for any great act of sacred art, such as the painting of the Virgin-mother. His dated works extend from 1524 to 1554, and he was the master of the pre-eminent portrait-painter Moroni. He died on the 22nd of December 1554.

MORGAGNI, GIOVANNI BATTISTA (1682-1771), Italian anatomist, was born on the 25th of February 1682 at Forlì.¹ His parents were in comfortable circumstances, but not of the nobility; it appears from his letters to G. M. Lancisi that Morgagni was ambitious of gaining admission into that rank, and it may

¹ His statue was erected at Forlì in 1875, and the town library preserves fourteen manuscript volumes of his writings.

be inferred that he succeeded from the fact that he is described on a memorial tablet at Padua as "*nobilis forlensis*." At the age of sixteen he went to Bologna to study philosophy and medicine, and he graduated with much *éclat* as doctor in both faculties three years later (1701). He acted as prosector to A. M. Valsalva (one of the distinguished pupils of Malpighi), who held the office of "demonstrator anatomicus" in the Bologna school, and whom he assisted more particularly in preparing his celebrated work on the *Anatomy and Diseases of the Ear*, published in 1704. Many years after (1740) Morgagni edited a collected edition of Valsalva's writings, with important additions to the treatise on the ear, and with a memoir of the author. When Valsalva was transferred to Parma Morgagni succeeded to his anatomical demonstratorship. At this period he enjoyed a high repute in Bologna; he was made president of the Academia Inquietorum when in his twenty-fourth year, and he is said to have signalized his tenure of the presidential chair by discouraging abstract speculations, and by setting the fashion towards exact anatomical observation and reasoning. He published the substance of his communications to the Academy in 1706 under the title of *Adversaria anatomica*, the first of a series by which he became favourably known throughout Europe as an accurate anatomist; the book included "Observations on the Larynx, the Lachrymal Apparatus, and the Pelvic Organs in the Female." After a time he gave up his post at Bologna, and occupied himself for the next two or three years at Padua, where he had a friend in Domenico Guglielmini (1655-1710), professor of medicine, but better known as a writer on physics and mathematics, whose works he afterwards edited (1719) with a biography. Guglielmini desired to see him settled as a teacher at Padua, and the unexpected death of Guglielmini himself made the project feasible, Antonio Vallisneri (1661-1730) being transferred to the vacant chair, and Morgagni succeeding to the chair of theoretical medicine. He came to Padua in the spring of 1712, being then in his thirty-first year, and he taught medicine there with the most brilliant success until his death on the 6th of December 1771.

When he had been three years in Padua an opportunity occurred for his promotion (by the Venetian senate) to the chair of anatomy, in which he became the successor of an illustrious line of scholars, including A. Vesalius, G. Fallopius, H. Fabricius, Gasserius, and A. Spigelius, and in which he enjoyed a stipend that was increased from time to time by vote of the senate until it reached twelve hundred gold ducats. Shortly after coming to Padua he married a lady of Forlì, of noble parentage, who bore him three sons and twelve daughters. Morgagni enjoyed an unequalled popularity among all classes. He was of tall and dignified figure, with blonde hair and blue eyes, and with a frank and happy expression; his manners were polished, and he was noted for the elegance of his Latin style. He lived in harmony with his colleagues, who are said not even to have envied him his unprecedentedly large stipend; his house and lecture-theatre were frequented "tanquam officina sapientiae" by students of all ages, attracted from all parts of Europe; he enjoyed the friendship and favour of distinguished Venetian senators and of cardinals; and successive popes conferred honours upon him. Before he had been long in Padua the students of the German nation, of all the faculties there, elected him their patron, and he advised and assisted them in the purchase of a house to be a German library and club for all time. He was elected into the imperial Caesareo-Leopoldina Academy in 1708 (originally located at Schweinfurth), and to a higher grade in 1732, into the Royal Society in 1724, into the Paris Academy of Sciences in 1731, the St Petersburg Academy in 1735, and the Berlin Academy in 1754. Among his more celebrated pupils were Antonio Scarpa (who died in 1832, connecting the school of Morgagni with the modern era), Domenico Cotugno (1736-1822), and L. M. A. Caldani (1725-1813), the author of the magnificent atlas of anatomical plates published in 2 vols. at Venice in 1801-1814.

In his earlier years at Padua Morgagni brought out (1717-1719) five more series of the *Adversaria anatomica*, by which his reputation was first made: but for more than twenty years after the last of

these his strictly medical publications were few and casual (on gall-stones, varices of the vena cava, cases of stone, and several memoranda on medico-legal points, drawn up at the request of the curia). Classical scholarship in those years occupied his pen more than anatomical observation. It was not until 1761, when he was in his eightieth year, that he brought out the great work which, once for all, made pathological anatomy a science, and diverted the course of medicine into new channels of exactness or precision—the *De Sedibus et Causis Morborum per Anatomiam*, which, during the succeeding ten years, notwithstanding its bulk, was reprinted several times (thrice in four years) in its original Latin, and was translated into French (1765), English (1769, 3 vols. 4to), and German (1771). Some account of this remarkable work remains now to be given.

The only special treatise on pathological anatomy previous to that of Morgagni was the work of Théophile Bonet of Neuchâtel, *Sepulchretum: sive anatomia practica ex cadaveribus morbo denatis*, first published (Geneva, 2 vols. folio) in 1679, three years before Morgagni was born; it was republished at Geneva (3 vols. folio) in 1700, and again at Leyden in 1700. Although the normal anatomy of the body had been comprehensively, and in some parts exhaustively, written by Vesalius and Fallopius, it had not occurred to any one to examine and describe systematically the anatomy of diseased organs and parts. Harvey, a century after Vesalius, naively remarks that there is more to be learned from the dissection of one person who had died of consumption or other chronic malady than from the bodies of ten persons who had been hanged. F. Glisson, indeed (1697-1677), shows, in a passage quoted by Bonet in the preface to the *Sepulchretum*, that he was familiar with the idea, at least in systematical comparing the organs of the same series of cadavera, and of noting those conditions which invariably accompanied a given set of symptoms. The work of Bonet was, however, the first attempt at a system of morbid anatomy, and, although it dwelt mostly upon curiosities and monstrosities, it enjoyed much repute in its day; Haller speaks of it as "an immortal work, which may in itself serve for a pathological library." Morgagni, in the preface to his own work, discusses the defects and merits of the *Sepulchretum*: it was largely a compilation of other men's cases, well and ill authenticated; it was prolix, often inaccurate and misleading, and, in regard to anatomical anatomy, and it was wanting in that would now be called objective impartiality—quality which was introduced as decisively into morbid anatomy by Morgagni as it had been introduced two centuries earlier into normal human anatomy by Vesalius. Morgagni has narrated the circumstances under which the *De Sedibus* took origin. Having finished his edition of Valsalva in 1740, he was taking a holiday in the country, spending much of his time in the company of a young friend who was curious in many branches of knowledge. The conversation turned upon the *Sepulchretum* of Bonet, and it was suggested to Morgagni by his diligent friend that he should put on record his own observations. It was the agreement that the anatomy of diseased organs and parts should be written for the perusal of this favoured youth (whose name is not mentioned); and they were continued from time to time until they numbered seventy. Those seventy letters constitute the *De sedibus et causis morborum*, which was given to the world as a systematic treatise in 2 vols. folio (Venice, 1761), twenty years after the task of epistolary instruction was begun. The letters are arranged in five books, treating of the morbid conditions of the body *a capite ad calcem*, and together containing the records of some 640 dissections. Some of these are given at great length, and the arrangement and exhaustiveness of detail hardly surpassed in the so-called "protocols" of the German pathological institutes of the present time; others, again, are fragments brought in to elucidate some question that had arisen. The symptoms during the course of the malady and other antecedent circumstances are always prefixed with more or less fulness, and discussed from the point of view of the conditions found after death. Subjects in all ranks of life, including several cardinals, figure in this remarkable gallery of the dead. Many of the cases are taken from Morgagni's early experiences at Bologna, and from the records of his teachers Valsalva and H. F. Albertus, not elsewhere published. They are selected and arranged with method and purpose, and they are often (and somewhat casually) made the occasion of a long excursus on general pathology and therapeutics. The range of Morgagni's scholarship, as evidenced by his references to early and contemporary literature, is astonishing. It has been contended that he was himself not free from prolixity, the besetting sin of the learned; and certainly the form and arrangement of his treatise are such as to make it difficult to use in the present day, notwithstanding that it is well indexed in the original edition, in that of Tissot (3 vols., 4to, Yverdon, 1779), and in more recent editions. It differs from the older treatises in that its symptoms determine the order and manner of presenting the anatomical facts. Although Morgagni was the first to understand and to demonstrate the absolute necessity of basing diagnosis, prognosis and treatment on an exact and comprehensive knowledge of anatomical conditions, he made no attempt (like that of the Vienna school sixty years later) to exalt pathological anatomy into a science disconnected from clinical medicine and remote from practical needs. His orderliness of anatomical method (implying his skill

with the scalpel, his precision, his exhaustiveness, and his freedom from bias, are his essentially modern or scientific qualities; his scholarship and high consideration for classical and foreign work, his sense of practical ends (or his common sense), and the breadth of his intellectual horizon prove him to have lived before medical science had become largely technical or mechanical. His treatise was the commencement of the era of steady or cumulative progress in pathology and in practical medicine. Symptoms from that time ceased to be made up into more or less conventional groups, each of which was a disease; on the other hand, they began to be viewed as "the cry of the suffering organs," and it became possible to develop Thomas Sydenham's grand conception of a natural history of disease in a catholic or scientific spirit.

A biography of Morgagni by Mosca was published at Naples in 1768. His life may also be read in A. Fabroni's *Vitae illustr. Italor.*, and a convenient abridgment of Fabroni's memoir will be found prefixed to Tissot's edition of the *De sedibus*, &c. A collected edition of his works was published at Venice in 5 vols. folio, in 1765. (C. C.)

MORGAN, DANIEL (1736-1802), American soldier, was born in Hunterdon county, New Jersey, in the winter of 1736, of Welsh ancestry. In 1753 he removed to Virginia. In June 1775, soon after the outbreak of the War of Independence, he was commissioned a captain of Virginia riflemen, and he marched his company to Boston in 21 days. In the winter of 1775 he accompanied General Benedict Arnold to Canada, and in the assault on Quebec (Dec. 31) he and his riflemen penetrated well into the city, where he was hemmed in and was forced to surrender. On the 7th of August 1776 he was discharged on parole; on the 12th of November he was commissioned colonel of the 11th Virginia; and soon afterwards he was released from his parole. In the summer of 1777 he was engaged in minor skirmishes in New Jersey, and early in September joined General Horatio Gates, then engaged in the campaign against General Burgoyne. At the first battle of Saratoga (Sept. 19) he was, until Arnold's arrival late in the day, the ranking officer on the field; and in the second battle (Oct. 7) also took a prominent part. Morgan rejoined Washington in November near Philadelphia. In March 1779 he was commissioned by Congress colonel of the 7th Virginia; but in July, suffering from poor health and dissatisfied because Congress did not advance him further in rank, he resigned from the army and retired to Virginia. After the battle of Camden, however, he joined Gates (then in command in the South) at Hillsborough, North Carolina, and on the 1st of October took command of a corps. On the 13th of the same month Congress tardily raised him to the rank of brigadier-general. In January 1781 Cornwallis and Tarleton attempted to entrap him, but at the Cowpens (Jan. 17) he defeated Tarleton and then escaped from Cornwallis into North Carolina. Apparently Morgan suggested to Greene (who had superseded Gates) that general's plan of battle at Guilford Court House on the 15th of March. In December 1793 he was commissioned major-general of Virginia militia, and in November 1794 commanded troops sent to suppress the Whisky Insurrection in western Pennsylvania. He was a Federalist representative in Congress in 1797-1799, and died in Winchester, Virginia, on the 6th of July 1802.

See James Graham, *The Life of General Daniel Morgan of the Virginia Line* (New York, 1856); and Rebecca McConkey, *The Hero of Cowpens* (rev. ed., New York, 1885).

MORGAN, EDWIN DENNISON (1811-1883), American merchant and philanthropist, one of the "war governors" of New York state, was born in Washington, Berkshire county, Massachusetts, on the 8th of February 1811. He was first a clerk and then a partner in his uncle's store at Hartford, Connecticut, and became head of the New York firm of E. D. Morgan & Co. (formed in 1847). He engaged in politics, first as a Whig and then as a Republican. In 1849 he was elected president of the Board of Assistant Aldermen of New York City; he was a member of the state senate in 1850-1853 and procured the passage of the bill providing for the establishment of Central Park in New York City; in 1855-1858 he was state commissioner of immigration; from 1859 to 1863 he was governor of New York, being the first Republican executive of the state; in 1863-1869 he was United States senator from New York. He died in New York City on the 14th of February 1883. Morgan

was one of the founders of the Republican party, and was chairman of the National Republican Committee in 1856-1864 and in 1872. He was one of the most efficient and able of the warring governors; even before the outbreak of the Civil War he did much to prepare the state government for it, and from September 1861 to January 1863 he was in command of the military department of New York, with the rank of major-general of volunteers. He was a liberal donor to Union Theological Seminary, Williams College and other institutions. His collection of paintings and sculpture, much of which had long been loaned to the Metropolitan Museum, was sold in January 1886.

MORGAN, SIR HENRY (c. 1635-1688), Welsh buccaneer, and lieutenant-governor of Jamaica, was the eldest son of Robert Morgan of Llanrhymny in Glamorganshire. He is said to have been kidnapped as a boy at Bristol and sold as a slave at Barbadoes, thence making his way to Jamaica, and is possibly to be identified with the Captain Morgan who accompanied the expedition of John Morris and Jackman when Vildemos, Trujillo and Granada were taken. In 1666 he commanded a ship in Edward Mansfield's expedition which seized the island of Providence or Santa Catalina, and when Mansfield was captured and killed by the Spaniards shortly afterwards Morgan was chosen by the buccaneers as their "admiral." In 1668 he was commissioned by Sir Thomas Modyford, the governor of Jamaica, to capture some Spanish prisoners, in order to discover details of the threatened attack on Jamaica; and collecting ten ships with 500 men south of Cuba, he landed and marched to Puerto Principe, which he took and pillaged; and afterwards accomplished the extraordinary feat of taking by storm the fortified and well-garrisoned town of Porto Bello on the mainland. The governor of Panama, astonished at this daring adventure, in vain attempted to drive out the invaders, and finally Morgan consented to evacuate the place on the payment of a large ransom. These exploits had considerably exceeded the terms of Morgan's commission and had been accompanied by frightful cruelties and excesses; but the governor endeavoured to cover the whole under the necessity of allowing the English a free hand to attack the Spaniards whenever possible. Morgan was almost immediately entrusted with another expedition by Modyford against the Spaniards, and proceeded to ravage the coast of Cuba. In January 1669 the largest of his ships was blown up accidentally in the course of a carousel on board, Morgan and his officers narrowly escaping destruction. In March he sacked Maracaibo, and afterwards Gibraltar. Returning to Maracaibo, he found three Spanish ships waiting to intercept him; but these he destroyed or captured, recovered a considerable amount of treasure from one which had sunk, exacted a heavy ransom as the price of his evacuating the place, and finally by an ingenious stratagem eluded the enemy's guns altogether and escaped in safety. On his return to Jamaica he was again reproved, but not punished by Modyford. The Spaniards on their side were moreover acting in the same way, and a new commission was given to Morgan, as commander-in-chief of all the ships of war in Jamaica, to levy war on the Spaniards and destroy their ships and stores, the booty gained in the expedition being the only pay. Accordingly, after ravaging the coast of Cuba and the mainland, Morgan determined on an expedition to Panama. He recaptured the island of Santa Catalina on the 15th of December 1670, and on the 27th gained possession of the castle of Chagres, killing 300 of the garrison. Then with 1400 men he ascended the Chagres river, and after overcoming perils and obstacles of all kinds he appeared before Panama on the 18th of January 1671, defeated a much larger force than his own, and took the city. The fame of this brilliant exploit was, however, again obscured by abominable scenes of cruelty and debauchery, during which a galleon containing a considerable part of the booty escaped. Moreover, on returning to Chagres the members of the expedition found themselves cheated of their fair share of the spoil,¹ while Morgan escaped with a

¹ Cal. of St. Pap. America & West Indies 1669-1674, Nos. 580 and 798; Exquemelin (ed. 1898), 237.

few ships to Jamaica, leaving the rest to get home as best they could. On his return he received the thanks of the governor and council; but meanwhile on the 8th of July, 1670, a treaty had been signed between Spain and England, and both Modford and Morgan were ordered home under arrest to answer for their conduct. Morgan, however, soon succeeded in gaining the king's favour, and in the autumn of 1674 he was appointed lieutenant-governor of Jamaica and was knighted, leaving England in December. After such a career as his it is not surprising that Morgan's conduct as a responsible official of the government was not very creditable. He was charged by Lord Vaughan, afterwards earl of Carbery, the governor, soon after his appointment, of persisting in encouraging privateering; he intrigued against his colleagues and successive governors of Jamaica, with the hope of superseding them; raised factious dissensions; and supported the outrageous conduct of his brother, Captain Charles Morgan, a terrible ruffian, and his kinsman, Colonel Byndlos, taking part in their brawls and drunken orgies. He was finally, on the 12th of October 1683, suspended in Jamaica from all his employments; a decision which was confirmed by the government at home after hearing Morgan's defence; but he was restored to his place in the council on the 18th of July 1688, shortly before his death, which took place in August.

See A. O. Exquemelin (one of Morgan's buccaners), *Buccaneers of America* (1684, reprinted in 1891); A. Morgan, *History of the Family of Morgan* (1901).

MORGAN, JOHN HUNT (1825-1864), American Confederate soldier, was born in Huntsville, Alabama, on the 1st of June 1825, and was brought up on a farm near Lexington, Kentucky, to which his parents removed in 1830. In the Mexican War he was a first lieutenant of a Kentucky cavalry regiment. On the outbreak of the Civil War he was captain of the Lexington Rifles (organized in 1857); in September 1861 he succeeded in getting out of Lexington the company's arms after the issue of the order for the disarming of the state guard, and late in the same month reached the Confederate camp at Woodsonville on the Green river. He proved himself an able scout, and was made captain of a cavalry company and commander of a cavalry "squadron," including two other companies, which in February 1862, with General A. S. Johnston's other forces, withdrew from Kentucky to Corinth, Mississippi. He was commissioned a colonel after the battle of Shiloh, and in July 1862, starting from eastern Tennessee, made the first of his famous raids. He routed a Federal force at Lebanon, destroyed much rolling stock and other railway property, and threatened Louisville and Cincinnati. In August and September he took part in General Braxton Bragg's invasion of Kentucky, and again threatened Ohio. In December he defeated the Union garrison at Hartsville, Tennessee, taking prisoners, valuable stores, and many cattle; was commissioned brigadier-general for this success; and soon afterward again raided Kentucky. To cover Bragg's movement from Tullahoma to Chattanooga Morgan made, in July 1863, his famous raid into Indiana and Ohio. Bragg had instructed him to confine himself to Kentucky, but Morgan hoped to gain recruits in Indiana, where opposition to the war was strong. With 2460 men he crossed the Cumberland near Burkesville, Kentucky, on the 2nd of July; on the 5th captured a garrison at Lebanon; and on the 13th entered Ohio near Harrison. The regular cavalry, under Generals E. H. Hobson and James M. Shackelford, was now close behind him, and his way was beset by quickly gathering militia. He marched through the suburbs of Cincinnati on the night of the 13th and on the 18th got to Portland, near Buffington Island, where he attempted to cross on the next day; but gunboats and steamers prevented him. In a sharp battle he lost 600 or more men. As many more surrendered soon afterwards, and about 300 crossed the river. On the 26th he surrendered to General Shackelford at New Lisbon. He was imprisoned with 70 of his men in the penitentiary at Columbus, from which on the night of the 27th of November he and six of his companions escaped by a tunnel they had dug. In the spring of 1864 he

was put in virtual command of the Department of South-western Virginia, which included eastern Tennessee, and late in August he took command at Jonesboro, Georgia. On the 4th of September he was shot in a garden in Greenville, Tennessee, having been betrayed, it appears, to the Federals. Morgan had an excellent eye for topographical details, and by the swiftness of his movements and his sudden blows kept Kentucky in continual alarm. His lieutenant, Basil W. Duke, says that his force at no time reached 4000, but that it "killed and wounded nearly as many of the enemy and captured more than 15,000."

See Basil W. Duke, *History of Morgan's Cavalry* (Cincinnati, 1867).

MORGAN, JOHN PIERPONT (1837-1913), American financier and banker, was born in Hartford, Connecticut, on the 17th of April 1837, a son of Junius Spencer Morgan (1813-1890), who was a partner of George Peabody and the founder of the house of J. S. Morgan & Co. in London. He was educated at the English High School in Boston and at the University of Göttingen. In 1857-1860 he worked in the New York banking house of Duncan, Sherman & Co.; from 1860 to 1864 was agent and attorney in New York for George Peabody & Co. of London, and afterwards for its successor, J. S. Morgan & Co., of which he became head; in 1864-1871 was a member of the firm of Drexel, Morgan & Co.; and in 1871 he entered the firm of Drexel, Morgan & Co., in which he was associated with Anthony J. Drexel, of Philadelphia, upon whose death in 1893 he became senior partner. In 1895 the firm became J. P. Morgan & Co. Closely associated with Drexel & Co. of Philadelphia, Morgan, Harjes & Co. (successors to Drexel, Harjes & Co.) of Paris, and Morgan, Grenfell & Co. (before 1910 J. S. Morgan & Co.) of London, it became, largely owing to Mr Morgan's ability, one of the most powerful banking houses in the world. It carried through the formation of the United States Steel Corporation (which took over the business of Andrew Carnegie and others), harmonized the coal and railway interests of Pennsylvania, and purchased the Leyland line of Atlantic steamships and other British lines in 1902, thus effecting an Atlantic shipping "combine" (See STEAMSHIP LINES); and it, or the banking houses which it succeeded, reorganized the following railways: Albany & Susquehanna (1869); the Chesapeake & Ohio, and the Cleveland, Cincinnati, Chicago & St Louis (1888); the Erie and the Reading (1895); the New York & New England (1896); the Northern Pacific (1897); the Baltimore & Ohio (1899), &c.; and in 1895 it supplied the United States government with \$62,000,000 in gold to float a bond issue and restore the treasury surplus of \$100,000,000. Mr Pierpont Morgan was a prominent member of the Protestant Episcopal Church; an enthusiastic yachtsman, whose "Columbia" defeated the "Shamrock" in 1899 and 1901 for the "America's" cup; a notable collector of books, pictures, and other art objects, many loaned or given to the Metropolitan Museum of Art (of which he was president), and many housed in his London house and in his private library on 36th Street, near Madison Avenue, New York City; and a generous benefactor of the American Museum of Natural History, the Metropolitan Museum of Art, Harvard University (especially its medical school), the Lying-in Hospital of the city of New York and the New York trade schools.

MORGAN, LEWIS HENRY (1818-1881), American ethnologist, was born near Aurora, New York, on the 21st of November 1818. He graduated in 1840 at Union College, then studied law, was admitted to the bar, and practised his profession with success at Rochester, New York. Soon after leaving college Morgan went among the Iroquois, living as far as he could their life and studying their social organization. In October 1847 he was formally adopted into the Hawk gens of the Seneca tribe, and received the name "Ta-ya-da-wah-kugh." The fruit of his researches was *The League of the Iroquois* (1851; new ed. 1904), which, says J. W. Powell, "was the first scientific account of an Indian tribe ever given to the world." The success of the book encouraged him to further research, resulting in his *Systems of Consanguinity and Affinity of the Human Family* (1869). In 1877 he added to his reputation by publishing

Ancient Society, or Researches in the Lines of Human Progress from Savagery, through Barbarism, to Civilization, in which he divided the progress of culture into seven stages—"lower savagery," "middle savagery," "upper savagery," "lower barbarism," "middle barbarism" and "upper barbarism," and "civilization." The book was in four parts, dealing with (1) the growth of intelligence through inventions and discoveries; (2) the growth of the idea of government; (3) the growth of the idea of the family; and (4) the growth of the idea of property. Morgan was a member of the New York assembly in 1861 and of the New York senate in 1868-1869. In 1880 he was president of the American Association for the Advancement of Science. He died in Rochester, New York, on the 17th of December 1881. In addition to the works above mentioned and many magazine articles, he published *The American Beaver and his Works* (1868) and *Houses and House-life of the American Aborigines* (1881).

MORGAN, SYDNEY, LADY (c. 1783-1859), British authoress, daughter of Robert Owenson, an Irish actor, was born in 1783 in Dublin. She was one of the most vivid and hotly discussed literary figures of her generation. She began her career with a precocious volume of poems. She collected Irish tunes, for which she composed the words, thus setting a fashion adopted with signal success by Tom Moore. Her *St Clair* (1804), a novel of ill-judged marriage, ill-starred love, and impassioned nature-worship, in which the influence of Goethe and Rousseau was apparent, at once attracted attention. Another novel, *The Novice of St Dominick* (1806), was also praised for its qualities of imagination and description. But the book which made her reputation and brought her name into warm controversy was *The Wild Irish Girl* (1806), in which she appeared as the ardent champion of her native country, a politician rather than a novelist, extolling the beauty of Irish scenery, the richness of the natural wealth of Ireland, and the noble traditions of its early history. She was known in Catholic and Liberal circles by the name of her heroine "Glorvina." *Patriotic Sketches and Metrical Fragments* followed in 1807. Miss Owenson entered the household of the marquis of Abercorn, and in 1812, persuaded by Lady Abercorn, she married the surgeon to the household, Thomas Charles Morgan, afterwards knighted; but books still continued to flow from her facile pen. In 1814 she produced her best novel, *O'Donnell*. She was at her best in her descriptions of the poorer classes, of whom she had a thorough knowledge. Her elaborate study (1817) of *France* under the Bourbon restoration was attacked with outrageous fury in the *Quarterly*, the authoress being accused of Jacobinism, falsehood, licentiousness and impiety. She took her revenge indirectly in the novel of *Florence Macarthy* (1818), in which a *Quarterly* reviewer, Con Crawley, is insulted with supreme feminine ingenuity. *Italy*, a companion work to her *France*, was published in 1821; Lord Byron bears testimony to the justness of its pictures of life. The results of Italian historical studies were given in her *Life and Times of Salvator Rosa* (1823). Then she turned again to Irish manners and politics with a matter-of-fact book on *Absenteeism* (1825), and a romantic novel, *The O'Briens and the O'Flahertys* (1827). From Lord Melbourne Lady Morgan obtained a pension of £300. During the late years of her long life she published *The Book of the Boudoir* (1820), *Dramatic Scenes from Real Life* (1833), *The Princess* (1835), *Woman and her Master* (1840), *The Book without a Name* (1841), *Passages from my Autobiography* (1859). She died on the 14th of April 1859.

Her autobiography and many interesting letters were edited with a memoir by W. Hepworth Dixon in 1862.

MORGAN, THOMAS (d. 1743), English deist, of Welsh extraction, became an independent minister, but soon after 1720 lost his position owing to the growing unorthodoxy of his views. He took up medicine and became a freethinker, though he describes himself as a Christian deist. He was an energetic controversialist. Among his works are *Philosophical Principles of Medicine* (1725); *Collection of Tracts* (1726), essays dealing with the Trinitarian controversy; *The Moral Philosopher* (1737),

a dialogue between a Christian Jew, Theophanus, and a Christian deist, Philalethes. He died on the 14th of January 1742/3.

MORGANATIC MARRIAGE, a form of marriage properly peculiar to the German peoples, but also found in the royal families of other European countries. It is one in which the contracting parties are not by birth of equal status or rank (*ebenbürtig*), and under which the wife, if not *ebenbürtig*, does not take the rank of her husband, and the children, whether it be the wife or husband that is of lower rank, have no right of succession to the dignities, fiefs or entailed property of the parent of higher rank. This equality by birth was formerly throughout Germany the necessary condition to a complete and perfect marriage, but it is now only applicable to members of reigning houses or of the higher nobility (*hoher Adel*), and it is thus of force among the "mediatized" princes of the German Empire. In the constitution of the various states, and in the "house laws" (*Hausgesetze*) of the reigning families, the rules are laid down as to what constitutes *ebenbürtigkeit*. Generally it may be said that members of a present or former reigning house, either in Germany or Europe, would be recognized as *ebenbürtig*, but a former morganatic marriage would be taken as destroying the qualification. In Great Britain the regulations as to the marriages of members of the royal family are contained in the Royal Marriage Act 1772 (see MARRIAGE). The term "morganatic marriage" is applied generally to any marriage of a person of royal blood with one of inferior rank. The origin of the term, in medieval Latin *matrimonium ad morganaticam*, is usually taken to refer to the *Morgengabe*, i.e. the morning gift, made by a husband to his wife on marriage. The German name is *Ehe zur linken Hand* (marriage by the left hand, whence the phrase a "left-handed marriage"), the husband of such marriage ceremonies giving the left instead of the right hand to the bride. Such marriages are recognized as fully binding by the Church, and the children are legitimate, and no other marriage can take place during the lifetime of the contracting parties.

MORGANTOWN, a city and the county-seat of Monongalia county, West Virginia, U.S.A., on the Monongahela river, about 50 m. S.E. of Wheeling. Pop. (1890), 1011; (1900), 1805; (1910 census), 9150. The city is served by the Baltimore & Ohio and the Morgantown & Kingwood railways, and by several steamboat lines, the Monongahela being navigable to Fairmont, about 25 m. above Morgantown. Morgantown is the seat of the West Virginia University (co-educational), formed from the Monongalia Academy (incorporated, 1814) and the Woodburn Female Seminary (incorporated, 1858), and chartered in 1867 as the Agricultural College of West Virginia; in 1868 the present name was adopted. In 1908 the university had 80 instructors and 1534 students. Coal, glass-sand and limestone are found in the vicinity of Morgantown. The first settlement here was made about 1768 by the brothers David and Zackwill Morgan, and was named in honour of the latter. It was incorporated as Morgan's Town in 1785; and in 1905 a city charter was granted to it after the annexation of Greenmont (pop. 1900, 349), Seneca (pop. 1900, 723), and South Morgantown (pop. 1900, 405).

MORGARTEN, the name of the pasture slopes that descend westwards to the south end of the lake of Aegeri in the Swiss canton of Zug, about 2 m. by road from the Sattel station on the railway line from Schwyz to Zürich. It was at the foot of these slopes and on the shore of the lake that the small Swiss force defeated the large Austrian army, advancing from Zug on Schwyz, on the 15th of November 1315, and so laid the foundations of Swiss liberty. As the lake has shrunk, the exact site of the battle has been disputed. It seems most probable that it took place near the Haselmatt Chapel, in the territory of Zug, where is the official monument, but some hold that the real site was in Schwyz territory, near the old tower and battle chapel of Schornen, in the gorge between the lake and Sattel.

The original accounts of the battle are collected in part iii. (1884) of

the *Mitteilungen* of the Historical Society of Schwyz. See also the careful study in K. Bürkli's *Ein Denkmal am Morgarten wo ist sein Platz?* (Zug, 1895).

MORGEN, a unit of measurement of land in Holland and the Dutch colonies, and hence still current in South Africa, equivalent to about 2 acres. It is also used in Prussia, Norway and Denmark, where it equals about two-thirds of an acre. The word is usually taken to be the same as the German and Dutch word for "morning," the area of a "morgen" being equal to that covered by a morning's ploughing.

MORGHEN, RAFFAELLO SANZIO (1758-1833), Italian engraver, was born at Naples on the 10th of June 1758. He received his earliest instructions from his father, himself an engraver; but, in order to be initiated more fully in the art, he was afterwards placed as a pupil under the celebrated Volpato. He assisted this master in engraving the famous pictures of Raphael in the Vatican, and the print which represents the miracle of Bolsena is inscribed with his name. He married Volpato's daughter, and, being invited to Florence to engrave the masterpieces of the Florentine Gallery, he removed thither with his wife in 1782. His reputation now became so great as to induce the artists of Florence to recommend him to the grand duke as a fit person to engrave the "Last Supper" of Leonardo da Vinci; apart, however, from the dilapidated state of the picture itself, the drawing made for Morghen was unworthy of the original, and the print, in consequence, although an admirable production, fails to convey a correct idea of the style and merit of Leonardo. Morghen's fame, however, soon extended over Europe; and the Institute of France, as a mark of their admiration of his talents, elected him an associate in 1803. In 1812 Napoleon invited him to Paris and paid him the most flattering attentions. He died at Florence on the 8th of April 1833.

A list of the artist's works, published at Florence in 1810, comprised 200 compositions; the number was afterwards considerably increased. Amongst the most remarkable, besides those already mentioned, may be noticed the Transfiguration from Raphael, a Magdalen from Murillo, a Head of the Saviour from da Vinci, the Car of Aurora from Guido, the Hours and the Repose in Egypt from Poussin, the Prize of Diana from Domenichino, the Monument of Clement XIII. from Canova, Theseus vanquishing the Minotaur, Francesco Mocado after Van Dyck, portraits of Dante, Petrarch, Ariosto, Tasso, and a number of other eminent men. His prints were hardly maintained the reputation which they enjoyed during the artist's lifetime. Though carefully and delicately executed, they are somewhat mechanical and wanting in force and spirit.

MORHIER, SIMON (d. c. 1450), provost of Paris during the English occupation in the 15th century, was seigneur of Gilles, near Nogent-le-Roi, in the Chartrain country. Being a member of the duke of Burgundy's party, he was appointed provost at Paris by John, duke of Bedford, on the 1st of December 1422. He was taken prisoner at the siege of Montargis in 1427, and again at the battle of Rouvrai in 1429; but in September of the latter year he repulsed Joan of Arc's attack upon Paris. After a campaign in Cotentin in 1435, he was once more taken prisoner at the bridge of Charenton in 1436. Remaining faithful to the English party, he became captain of Dreux, a councillor of Henry VI., and treasurer of France and Normandy. He assisted in the defence of Meaux (1439), of Creil and of Pontoise (1441), and must have died between 1450 and 1456.

See the *Nouvelle biographie générale*, vol. xxxvi.; and a note on Simon Morhier in the memoirs of the Antiquarian Society of France, vol. xxv.

MORHOF, DANIEL GEORG (1630-1691), German man of letters, was born at Wismar on the 6th of February 1639. He first studied jurisprudence and then *literæ humaniores* at the university of Rostock, where his elegant Latin versification procured for him in 1666 the chair of poetry. In 1665 he went to the new university of Kiel as professor of eloquence and poetry; this chair he exchanged for that of history in 1673. He died at Lübeck on the 30th of July 1691. Of his numerous writings the most important are *Unterricht von der deutschen Sprache und Poesie* (1682; 3rd ed., 1718), the first attempt in Germany at a systematic survey of European literature, and *Polyhistor, sive de auctorum notitiæ et rerum commentarii* (Lübeck,

1688, not completed till 1707; 4th ed., 1747), a kind of encyclopaedia of the knowledge and learning of his time.

See Eymar, *Morhof und sein Polyhistor* (in the *Xenia Austriaca*, Vienna, 1893); and biography by R. v. Liliencron in *Allgem. Deutsche Biographie* (1885).

MORIAH, an obscure place-name of ancient Palestine with apparently two distinct connotations. (1) A land entirely unknown, on a mountain in which Abraham offered Isaac (Gen. xxii. 2). The text is probably corrupt: some have suggested "land of the Amorites," others "land of Midian." The etymology of the word is equally obscure. Traditionally, of course, "the land of Moriah" is identified with the site of the Temple at Jerusalem, except by the Samaritans and a few western scholars (such as Dean Stanley) who accept their belief that the mountain was Gerizim. (2) The upper part of the hill of Ophel, the threshing floor of Araunah, upon which Solomon erected the Temple, is once called Mount Moriah (2 Chron. iii. 1). Whether this name be derived from the corruption in Genesis or not cannot be definitely decided; it very likely is. The testimony of Josephus, who often names the temple hill "Moriah," is of course not original, and of no weight. (R. A. S. M.)

MORIER, JAMES (1780-1840), English traveller and author, was born in 1780. Through the influence of his uncle, Admiral William Waldegrave, Baron Radstock, he entered the diplomatic service, and as secretary to Lord Elgin followed the grand vizier in the Egyptian campaign. An account of his Eastern experiences was published in 1812, under the title *A Journey through Persia, Armenia and Asia Minor to Constantinople in 1808-9*. From 1810 to 1816 he was the British representative at the court of Persia, and after his return he published *A Second Journey through Persia to Constantinople between the years 1810 and 1816*. His knowledge of Eastern life and manners he also turned to account in the composition of several entertaining romances. The most popular of these were *The Adventures of Hajji Baba of Ispahan* (1828), *The Adventures of Hajji Baba of Ispahan in England* (1824), *Zohrab the Hostage* (1832), and *Ayeshah the Maid of Kars* (1834). Morier died at Brighton on the 23rd of March 1840.

MORIER, SIR ROBERT BURNETT DAVID (1826-1893), British diplomatist, was born at Paris on the 31st of March 1826. He was descended from a family of diplomatists of Huguenot origin, the best known of whom were his father David, consul-general for France and minister at Bern, and his uncle James, the author of *The Adventures of Hajji Baba*. After a somewhat defective private education he came up to Balliol College, Oxford. Here he attracted the notice of Jowett, under whose influence his brilliant but wayward mind obtained the discipline of which it stood in need. The relation of tutor and pupil developed into a friendship of rare warmth. Writing towards the close of his life, Jowett, who inspired more devoted friendships than any man of his time, spoke of Morier as his kindest and best friend for forty-five years. On leaving Oxford, Morier at first obtained an appointment in the Education Department, but resigned in 1852, and in the following year became attaché at Vienna. In the succeeding years he was attached in turn to almost every court in Germany. Restless in temperament and unconventional in method, he plunged into the vortex of German politics to a degree that did not always accord with the traditions of diplomacy. The most important years of his career in Germany were from 1866 to 1871, when he was secretary of legation at Darmstadt. Here he became a trusted adviser of the crown princess, and through her acquired an intimate friendship with the crown prince (afterwards the emperor Frederick III.), whose antagonism to Bismarck's reactionary policy met with cordial support from Morier's sturdy Liberalism. Bismarck, already jealous of British influence at court, honoured Morier with a hatred not lessened by the fact that Morier's knowledge of German politics was unrivalled outside Germany. On leaving Darmstadt, Morier became chargé d'affaires, first at Stuttgart

Some of the sects transfer the scene of the sacrifice to the "Chapel of Abraham" in the precincts of the Holy Sepulchre Church.

and then at Munich, and in 1876 was appointed minister at Lisbon. From 1881 to 1884 he was minister at Madrid. In December 1884 he became ambassador at St Petersburg, and almost immediately had to face the alarming situation created by the Russian advance to Penjdeh. Thanks to his efforts, a war that at one moment seemed inevitable was averted. His great popularity at the Russian court contributed towards a marked improvement in the relations between the two countries. Bismarck took alarm at the lessening influence of Germany over Russia, and tried to procure Morier's downfall. The *Kölnische Zeitung* declared in December 1888 that Morier had made use of his position at Darmstadt during the Franco-German War to betray the movements of the German troops to Marshal Bazaine. The authority for this charge was an alleged declaration made by Bazaine to the German military attaché at Madrid. Bazaine had died in September, but Morier had heard rumours in July of the charge brought against him, and had procured from Bazaine a written denial, which he now published in *The Times*. Apart from this, it was clearly shown that Morier could not have transmitted the information by the alleged date, and that Bazaine, according to the testimony of his own books and of other officers, received the information in question by reports from the front. As a matter of fact, Morier was an ardent champion of the German cause. His correspondence with Jowett shows the latter vainly endeavouring to convince his friend that the French were in the right. Public opinion everywhere, except in the German Conservative press, attributed the charge to political motives. Morier's failing health caused him, at his own request, to be appointed Lord Dufferin's successor at Rome in 1891; but it was felt that he could not be spared from St Petersburg, and there he remained till forced to find a milder climate. It was then too late, and he died at Montreux in Switzerland on the 16th of November 1893.

MÖRIKE, EDUARD FRIEDRICH (1804-1875), German poet, was born at Ludwigsburg on the 8th of September 1804. In 1834 he was appointed pastor of Kleversulzbach near Weinsberg, and in 1851 became professor of literature at the Katharinenstift in Stuttgart. This office he held until his retirement in 1866; but he continued to live at Stuttgart until his death on the 4th of June 1875. Mörike is the most lyrically gifted of all the poets belonging to the so-called Swabian school which gathered round Uhland. His poems, *Gedichte* (1838; 2nd ed., 1905), are mostly lyrics, graceful in style, original in conception, often humorous, but expressed in simple and natural language. He also wrote a somewhat fantastic *Idylle vom Bodensee, oder Fischer Martin und die Glockeniede* (1846; 2nd ed., 1856), and published a collection of hymns, odes, elegies and idylls of the Greeks and Romans, entitled *Klassische Blumenlese* (1840), and several novels and narratives, among the former *Maler Nolten* (1832; 6th ed., 1901), which enjoyed great popularity.

Mörike's *Gesammelte Schriften* were first published in 4 vols. (in 1878); the most recent editions are those edited by R. Krauss (6 vols., 1905), and the *Volksausgabe*, published by Geschen (4 vols., 1905). Selections from his literary remains were published by R. Krauss in *Eduard Mörike als Gelegenheitsdichter* (1895), and his correspondence with Hermann Kurz, Moritz von Schwind, and Theodor Storm, by J. Bächtold (1885-1891); an edition of Mörike's *Ausgewählte Briefe*, in 2 vols., appeared 1903-1904. See F. Notter, *Eduard Mörike* (1875); and H. Fischer, *Eduard Mörike* (1881); K. Fischer, *E. Mörike* (1901); H. Maync, *E. Mörike (1802): K. Fischer, Mörikes künstlerisches Schaffen und dichterische Schöpfungen* (1903).

MORILLON, a name commonly given by fowlers to the female or immature male of the GOLDEN-EYE (*g.v.*), the *Clangula glaucion* of modern ornithology, under the belief—which still very generally obtains among them, as it once did among naturalists—that they formed a distinct species of duck. The mistake no doubt originated in, and is partly excused by, the facts that the birds called Morillons were often of opposite sexes, and differed greatly from the adult male Golden-Eye, whose full and beautiful plumage is not assumed until the second year. The word is used in French in precisely the same form, but it is in that language applied to the Tufted Duck, *Puligula cristata*, and is derived, according to Littré, from *more*, signifying black. (A. N.)

MORIN, JEAN (latinized JOANNES MORINUS) (1501-1659), French theologian, was born in 1501 at Blois, of Protestant parents. He learned Latin and Greek at Rochelle, and continued his studies at Leiden, subsequently removing to Paris. His conversion to the Roman Church is ascribed to Cardinal du Perron. In 1618 he joined the congregation of the Oratory, and in due course took priest's orders. In 1625 he visited England in the train of Henrietta Maria; in 1640 he was at Rome, on the invitation of Cardinal Barberini, and was received with special favour by Pope Urban VIII. He was, however, soon recalled to Paris by Richelieu, and the rest of his life was spent in incessant literary labour. The *Histoire de la dévotion de l'église chrétienne par l'emp. Constantin, et de la grandeur et souveraineté-temporelle donnée à l'église romaine par les rois de France* (1630) gave great offence at Rome, and a *Déclaration* (1654), directed against faults in the administration of the Oratory, was strictly suppressed. So, too, his great work on penance gave equal offence to the Jesuits and to Port-Royal, and even after his death, in 1659, the polemical vehemence of his *Exercitios biblicae*, and the exaggeration of his assertion—"apud neotericos Haereticos verba Scripturarum non esse integra, non superfluum, non folia, nedum sensum, medullam et radicem rationis" long led Protestants to treat his valuable contributions to the history of the Hebrew text as a mere utterance of Popish prejudice.

Morin was a voluminous and prolix writer on ecclesiastical antiquities. His principal works in this field are *Commentarius historicus de disciplina in administratione sacramenti poenitentiae XIII. primis saeculis in eccl. occid. et hucusque in orient. observata* (1651), and *Comm. de sacris ecclesiae ordinationibus secundum antiquos et recentiores Latinos, graecos, syros et babilonios* (1655), which expresses those irenic views on the subject of ordination which recommended Morin to Urban VIII. The literary correspondence of Morin appeared in 1682 under the title of *Antiquitates ecclesiae orientalis* (edited by R. Simon).

Morin's chief fame, however, rests on his biblical and critical work. By his *editio princeps* of the Samaritan Pentateuch and Targum, in the Paris Polyglott, he gave the first impulse in Europe to the study of this dialect, which he acquired without a teacher (framing a grammar for himself) by the study of MSS. then newly brought to Europe. Not unnaturally he formed a very exaggerated view of the value of the Samaritan tradition of the text (*Exercitationes in utrumque Samaritanorum Pentateuchum*, 1631). A similar tone of exaggerated depreciation of the Massoretic Hebrew text, coloured by polemical bias against Protestantism, mars his greatest work, the posthumous *Exercitationes biblicae de haereticis graecique textus sinceritate* (1660), in which, following in the footsteps of Cappellus, but with incomparably greater learning, he brings irrefragable arguments against the then current theory of the absolute integrity of the Hebrew text and the antiquity of the vowel points.

MORION (the French form of a word occurring in Spanish as *morrión*, Ital. *morione*, usually connected with the Span. *morra*, top or crown of the head), a light round-shaped head-piece or helmet (*g.v.*). The chief characteristics are a brim, an upright comb running along the crown from back to front, and the absence of guards for the face, ears or neck. The brim was bent sharply upwards at the front and back, and the piece was generally worn tilted backward so as to cover the neck. The morion and the cabasset, a pear-shaped headpiece with a flatter brim and no comb, were the typical infantry helmets of the 16th and early 17th centuries. It was sometimes worn unaccompanied by any body armour.

MORISCOS (*i.e.* little Moors), the name given to the Spanish Mahomedans who accepted baptism and their descendants. Many, if not most, of them were in reality of the same race as the Christians, and were descended from converts to Islam. Those Mahomedans who retained their religion under Christian rulers were known as Mudéjars, a word of Arabic origin which has been interpreted as meaning "those who remained" or "were left." Until the 15th century they were numerous, and enjoyed free exercise of their religion, which was secured to them by capitulations and treaties. Their number had been considerably diminished by the time of the conquest of Granada in 1492. By the terms of the capitulation of the city freedom of worship was secured to the Mahomedans. But the policy of the Catholic sovereigns, who desired to establish unity of faith

among their subjects, and the influence of the Church, soon led to violations of the treaty. The first Christian archbishop of Granada, Talavera, made some progress in converting the people peacefully. But at the end of 1499 Cardinal Jimenez insisted on adopting coercive measures. A rebellion ensued, and the Mohammedans were suppressed. Want of power, or other obstacles, delayed the final extinction of tolerated Mahomedanism in all parts of Spain, but by 1525 it was everywhere suppressed. The last remains of it were crushed in Valencia, where the Mohammedans were furiously attacked by the Christian peasantry during the great agrarian revolt known as the Germania, 1520-1521. As they were dependent on the protection of the landlords, the Mohammedans were docile tenants, and their competition weighed heavily on the Christians. The same quality of industry remained to the Moriscos, and excited the envy of their Christian fellow countrymen. The feelings with which they were regarded are admirably shown by Cervantes (who shared them to the full) in his "Conversation of the Two Dogs." In 1568 the government of Philip II. issued an edict, which ordered them to renounce all their Moorish ways of life and to give up their children to be educated by Christian priests. The result was a rebellion in Granada, which was put down with great difficulty. The Moriscos were expelled from Granada and scattered over other parts of Spain. Many fled to Africa, where the more spirited among them took to piracy at Algiers and other ports. They still maintained relations with their kinsfolk in Spain, and the whole coast suffered from their incursions. The Moriscos entered into relations with other enemies of Spain, and notably, with France. Henry IV. included a plan for supporting a Morisco rebellion in the great scheme for the destruction of the Spanish monarchy, which he was about to put into execution when he was murdered on the 14th of May 1610. These intrigues were known to the Spanish government and inspired it with terror. The expulsion of the whole body of Moriscos was decided on in 1608, and the edict was published on the 22nd of September 1609. The expulsion was carried out with great cruelty. The number driven out has been variously estimated at 120,000, or at 3,000,000. In some known cases the expelled Moriscos suffered martyrdom in Africa as Christians. A few were left in Spain as domestic slaves, and some contrived to return in secret. Cases of crypto-Mahomedanism continued to come before the Inquisition till the 18th century.

See *The Moriscos of Spain: their Conversion and Expulsion*, by H. C. Lea (London, 1901).

MORISON, JAMES AUGUSTUS COTTER (1832-1888), British author, was born in London on the 20th of April 1832. His father, who had made a large fortune as the inventor and proprietor of "Morison's Pills," settled in Paris till his death in 1840, and Cotter Morison thus acquired not only an acquaintance with the French language, but a profound sympathy with France and French institutions. In later life he resided for some years in Paris, where his house was a meeting-place for eminent men of all shades of opinion. He was educated at Highgate grammar school and Lincoln College, Oxford. Here he fell under the influence of Mark Pattison, to whom his impressionable nature perhaps owed a certain over-fastidiousness that characterized his whole career. He also made the acquaintance of the leading English Positivists, to whose opinions he became an ardent convert. Yet he retained a strong sympathy with the Roman Catholic religion, and at one time spent several weeks in a Catholic monastery. One other great influence appears in the admirable *Life of St Bernard*, which he published in 1863—that of his friend Carlyle, to whom the work is dedicated, and with whose style it is strongly coloured. Meanwhile he had been a regular contributor, first to the *Literary Gazette*, edited by his friend John Morley, and then to the *Saturday Review* at its most brilliant epoch. In 1868 he published a pamphlet entitled *Irish Grievances shortly stated*. In 1878 he published a volume on *Gibbon* in the "Men of Letters" series, marked by sound judgment and wide reading. This he followed up in 1882 with his *Macaulay* in the same series. It exhibits, more clearly perhaps

than any other of Morison's works, both his merits and his defects. Macaulay's bluff and strenuous character, his rhetorical style, his unphilosophical conception of history, were entirely out of harmony with Morison's prepossessions. Yet in his anxiety to do justice to his subject he steeped himself in Macaulay till his style often recalls that which he is censuring. His brief sketch, *Mme de Maintenon: une étude* (1885), and some magazine articles, were the only fruits of his labours in French history. Towards the close of his life he meditated a work showing the application of Positivist principles to conduct. Unfortunately, failing health compelled him to abandon the second or constructive part: the first, a brilliant piece of writing which attempts to show the ethical inadequacy of revealed religion and is marked in parts by much bitterness, was published in 1887 under the title of *The Service of Man*. He died in London on the 26th of February 1888.

MORITZ, KARL PHILIPP (1757-1793), German author, was born at Hameln on the Weser on the 15th of September 1757, of humble parentage. After receiving a scanty schooling, he was apprenticed to a hat-maker, but was later enabled to study philosophy at Erfurt and Wittenberg and in 1777 became teacher in a school at Dessau. While on a tour through Italy in 1786 he became acquainted with Goethe, who interested himself in him. On his return, he was appointed professor of archaeology and aesthetics, at the academy of art in Berlin, and in this city he died on the 26th of June 1793. Of Moritz's writings on aesthetic, archaeological and philosophical subjects, the little treatise *Über die bildende Nachahmung des Schönen* (1788; reprinted 1888) and *Die Götterlehre* (1791; 10th ed., 1855, a reprint in Reclam's *Universalsbibliothek*, 1878) are important; interesting, too, are the accounts of his travels, *Reisen eines Deutschen in England* (1788; repr. 1903; also trans. into Eng.) and *Reisen eines Deutschen in Italien* (3 vols., 1792-1793). As an author he is best known by his two novels, *Anton Reiser* (1785-1790; new ed. by L. Geiger, 1886) and *Andreas Hartknopf* (1786), which are mainly autobiographical.

See K. F. Klischning, *Erinnerungen aus den zehn letzten Lebensjahren meines Freundes Anton Reiser* (1794); Varnhagen von Ense, *Denkwürdigkeiten*, vol. iv. (1838); and M. Dessoir, *Karl Philipp Moritz als Aesthetiker* (1889).

MORLAIX, a town of western France, capital of an arrondissement in the department of Finistère, 37 m. E.N.E. of Brest on the railway to Rennes. Pop. (1906), 13,875. Morlaix lies between 4 and 5 m. from the English Channel in a narrow valley where two small streams unite to form the Dossen, the channel of which forms its port. Below the town the river widens into an estuary, the mouth of which is commanded by an old fortress, the Château du Taureau, built in 1542 to protect the town against the English. The railway from Paris to Brest crosses the valley on a striking two-storeyed viaduct some 200 ft. above the quays. Morlaix contains a considerable number of wooden houses of the 15th, 16th and 17th centuries. These have large covered courts, with huge open fireplaces and carved wooden staircases, supported on pillars, leading from the court to the upper storeys.

Morlaix has a sub-prefecture, tribunals of first instance and of commerce, a chamber of commerce, and colleges for boys and girls. The industries include the manufacture of tobacco occupying about 900 hands, tanning, brewing and the manufacture of casks, wooden shoes and candles; there is an active trade in grain, butter, oil-seeds, vegetables, leather, wax, honey and in horses and other livestock, which are exported by sea. The port, consisting of an outer tidal harbour and an inner basin, admits vessels drawing 17 ft. at spring tides and 12 ft. at neap tides.

Judging by the numerous coins found on the spot, the site of Morlaix was probably occupied in the time of the Romans. The counts of Leon held the lordship in the 12th century, but the dukes of Brittany disputed possession with them, and in 1187 Henry II. of England, guardian of Arthur of Brittany, made himself master of the town after a siege of several weeks. During the Hundred Years' War Morlaix was held by the French and the English in turn, and pillaged by the latter in 1522. Queen

Mary of Scots, on her way to be married to the dauphin, made solemn entry into Morlaix in 1548. The town having joined the League, the castle was taken by storm in the name of Henry IV. in 1594.

MORLAND, GEORGE (1763-1804), English painter of animals and rustic scenes, was born in London on the 26th of June 1763. His grandfather, George H. Morland, was a subject painter, three of whose popular pictures were engraved by Watson and Dawe in 1769. The son, H. R. Morland, father of George, was also an artist and engraver, and picture restorer, at one time a rich man, but later in reduced circumstances. His pictures of laundry-maids especially were very popular in their time, and were reproduced in mezzotint. They represented ladies of some importance who desired to be painted, according to the fashion of the day, engaged in domestic work. Morland's mother was a Frenchwoman, who possessed a small independent property of her own; she is believed to have been the Maria Morland who exhibited twice at the Royal Academy in 1785 and 1786, although some writers have stated that Maria Morland was not the mother, but one of the sisters of George Morland.

At a very early age Morland produced sketches of remarkable promise, exhibiting some at the Royal Academy in 1773, when he was but ten years old, and continuing to exhibit at the Free Society in 1775 and 1776, and at the Society of Artists in 1777, and then sending again to the Royal Academy in 1778, 1779 and 1780. His very earliest work, however, was produced even before that tender age, as his father kept a drawing which the boy had executed when he was but four years old, representing a coach and horses and two footmen. He was a student at the Royal Academy in early youth, but only for a very short time. From the age of fourteen he was apprenticed to his father for seven years, and by means of his talent appears to have kept the family together. He had opportunities at this time of seeing some of the greatest artists of the day, and works by old masters, but even then a strange repugnance for educated society showed itself, and no persuasion, for example, could ever allure him within reach of the Angerstein gallery, where he would have been a welcome visitor. Before his apprenticeship came to an end, Romney offered to take Morland into his studio for three years, with a salary of £300 a year, but the offer was rejected, and as soon as his freedom came, he left his dull, respectable home, with its over-strict discipline, and began a career of reckless prodigality which has hardly a parallel in art biography. In 1785 he was in France, whither his fame had preceded him, and where he had no lack of commissions, and in the following year he married Anne, the sister of William Ward, the engraver, and settled down in High Street, Marylebone.

Mrs Morland was a beautiful and virtuous woman, and throughout the whole of her husband's profligate career was deeply attached to him. It was at this time that he painted the six pictures known as the Laetitia series, engraved by J. R. Smith, and, just preceding his marriage, four other didactic works, "The Idle and the Industrious Mechanic" and "The Idle Landress and the Industrious Cottager," engraved by Blake, had been produced by him. Shortly after his marriage Morland resided at Pleasant Passage, Hampstead Road, and at that time his reputation was rapidly increasing, while as he was the sole vendor of his own productions, his expenditure, although very extravagant, was not beyond his income. Soon, however, he moved to Warren Place, and there, although he was making a thousand a year by his pictures, he lived at such an expensive rate that he began the series of financial difficulties which finally ruined him. His wild frolics about town, and the prodigal line of conduct upon which he had entered, resulted in a heavy accumulation of debt, but in 1789 he set himself to clear off his encumbrances, and did so in fifteen months. He then removed to Leicester Square, later to Tavistock Row, then to St Martin's Lane, and finally to Paddington, and was at that time at the very height of his reputation.

After moving to a larger house in Winchester Row, his financial position became so embarrassed that he had to fly from his creditors into Leicestershire, where he indulged to the full his

delight in animal life. After a year, however, he returned to London and settled in Charlotte Street, when his difficulties increased, and time after time he had to obtain letters of licence, in order to avoid being arrested by his creditors. At last, however, he had to cross the water, and change his place of abode from time to time, keeping it as secret as possible, and we hear of him at Lambeth, at East Sheen, in the Minorities, Kentish Town, Soho, Newington, Kennington Green and Hackney, while he had numerous adventures in eluding the attention of those who desired to capture him.

In 1799 he escaped to the Isle of Wight, and settled down for some time at Yarmouth, but returned to London at the end of the year, was arrested and sent to King's Bench prison, where he lived within the rules, occupying a small furnished house in St George's Fields, but keeping his exact residence a secret. In 1802 he was liberated, but in 1803 had to place himself in the custody of the Marshalsea, in order to avoid his creditors. Afterwards he visited Brighton and other places, and by his riotous living brought himself to such a state of health that fits of an apoplectic nature became frequent, and he was for a time paralysed. On the 19th of October 1804 he was arrested by a publican and conveyed to a sponging-house, where, in attempting to make a drawing which could be sold in discharge of the debt, he was seized with a fit which proved the beginning of brain fever. He died on the 29th of the same month. His wife survived him only three days, the news of his death bringing on convulsive fits from which she died on the 2nd of November. Their remains were interred together in the burying-place of St James's Chapel.

The finest of his pictures were executed between 1790 and 1794, and amongst them his picture of the inside of a stable, in the National Gallery, may be reckoned as a masterpiece. His works deal with scenes in rustic and homely life, depicted with purity and simplicity, and show much direct and instinctive feeling for nature. His colouring is mellow, rich in tone, and vibrant in quality, but, with all their charm, his works reveal often signs of the haste with which they were painted and the carelessness with which they were drawn. He had a supreme power of observation and great executive skill, and he was able to select the vital constituents of a scene and depict even the least interesting of subjects with artistic grace and brilliant representation. His pictures are never crowded; the figures in them remarkably well composed, often so cleverly grouped as to conceal any inaccuracies of drawing, and to produce the effect of a very successful composition. As a painter of English scenes he takes the very highest position, and his work is marked by a spirit and a dash, always combined with broad, harmonious colouring. Many of his best works have been well rendered in mezzotint by J. R. Smith, W. Ward, P. Dawe, G. Keating, S. W. Reynolds and other engravers. He exhibited regularly at the Royal Academy from 1784 down to 1804, but few of his academy pictures can be identified owing to the inadequate description of them afforded by their titles.

Four biographies of him appeared shortly after his death, written by W. Collins (1805), F. W. Blagdon (1806), J. Hassell (1806) and George Dawe (1807). Later biographies are those by Ralph Richardson (1895), J. T. Nettleship (1898) and G. C. Williamson (1904 and 1907). (G. C. W.)

MORLANDWELZ, a town of Belgium in the province of Hainaut, 15 m. E. of Mons. It lies in the centre of the coal-mines district and has extensive foundries and ironworks. Pop. (1904), 8200.

MORLEY, BARONS AND EARLS OF.—In 1299 William de Morley of Morley in Norfolk was summoned to parliament as a baron, and his son Robert (d. 1366) was a celebrated warrior, being largely responsible for the English victory at Sluys and fighting at Crecy. His descendant Robert, the 6th baron (d. 1443), had no sons, but he left a daughter Alianore, who married William Lovel (d. 1476), and Lovel was summoned to parliament as Lord Morley, ranking as the 7th holder of the title. He left a son Henry, who was killed in 1489, and Henry's heir was his sister Alice, the wife of Sir William Parker (d. 1510), hereditary marshal of Ireland. Their son Henry Parker (1476-1556) became the 10th baron, as he was summoned to the House of

Lords as Lord Morley in 1523. He was a man of literary attainments and translated some of the writings of Plutarch, Boccaccio, Petrarch, Seneca, Cicero and others into English. Most of these are only found in manuscript, but his *Tryumphes of Francaes Petrarcke* was published a second time in 1887. His eldest son Henry (d. 1553) died during his father's lifetime, leaving a son Henry (d. 1577) who became 11th Baron Morley on his grandfather's death. His son Edward (d. 1618), one of the judges of Mary Queen of Scots, succeeded to the barony; and Edward's son and successor was William Parker, 4th Lord Montague (q.v.). The barony of Morley remained united with that of Montague until the death of William's grandson Thomas about 1686, when it fell into abeyance.

John Parker, 1st earl of Morley (1772–1840), only son of John Parker (1735–1788), who was created Baron Boringdon in 1784, but was no relation of the previous barons Morley, was a prominent supporter of Pitt and of Canning. In 1815 he was created earl of Morley. He was a public benefactor to Plymouth and its neighbourhood. He was succeeded by his son Edmund Henry Parker (1810–1864), whose son, Albert Edmund, the 3rd earl (1843–1905), was chairman of committees in the House of Lords from 1889 to 1905, after having been under-secretary for war and first commissioner of works. In 1905 his son, Edmund Robert (b. 1877), became 4th earl.

MORLEY, GEORGE (1597–1684), English bishop, was born in London and educated at Westminster and Oxford. In 1640 he was presented to the sinecure living of Hartfield, Sussex, and in the following year he was made canon of Christ Church and exchanged to the rectory of Mildenhall, Wiltshire. He preached before the Commons in 1642, but his sermon gave offence, and when in 1647 he took a prominent part in resisting the parliamentary visitation of Oxford University he was deprived of his canonry and living. Leaving England he joined the court of Charles II., and became one of the leading clergy at The Hague. Shortly before the Restoration he came to England on a highly successful mission to gain for Charles the support of the Presbyterians. In 1660 he regained his canonry, and soon became dean of Christ Church. In the same year he was consecrated bishop of Worcester. At the Savoy conference of 1661 he was chief representative of the bishops. He was translated to the see of Winchester in 1662. His works are few and chiefly polemical, e.g. *The Bishop of Worcester's Letter to a friend for Vindication of himself from the Calumnies of Mr Richard Baxter* (London, 1662).

MORLEY, HENRY (1822–1894), British man of letters, was born in London on the 15th of September 1822. After unhappy experiences at English schools, he was sent to the Moravian school at Neuwied, whose system strongly influenced his subsequent theories of education. It was intended that he should follow his father's profession of medicine, and in 1844 he bought a share in a practice at Madeley, Shropshire. Plunged into debt by his partner's dishonesty, he set up a small school for young children at Liscard, near Liverpool. His principle was to abolish all punishment, to make his pupils regard their work as interesting instead of repellent, and to form their character by appealing exclusively to higher motives. This scheme, carried out with much ingenuity, proved a complete success. Meanwhile he had devoted his spare time to writing. His contributions to magazines attracted the notice of Charles Dickens, on whose invitation in 1851 he settled in London as a regular contributor to *Household Words*. He was also on the staff of the *Examiner*, which he edited from 1861 to 1867. Meanwhile he had devoted much research to a life of *Palissy the Potter* (1852), which was at the same time a picture of life in medieval France. Encouraged by its favourable reception, he followed it up with lives of *Jerome Cardan* (1854) and *Cornelius Agrippa* (1856), and subsequently of *Clement Marot* (1870). His dramatic criticisms were reprinted in 1866 under the title of *The Journal of a London Playgoer, 1851–1866*. In 1857 he was appointed evening lecturer in English literature at King's College, and in 1865 became, in succession to David Masson, professor of English literature at University College, London. His *First Sketch of English Litera-*

ture (1873), a comprehensive and useful manual, reached its 34th thousand during the author's lifetime. He published in 1864 the first volume of a monumental history of English literature entitled *English Writers*, which he eventually carried in eleven volumes down to the death of Shakespeare. He was indefatigable as a popularizer of good literature. After editing a standard text of Addison's *Spectator*, he brought out a vast number of classics at low prices in Morley's Universal Library, Cassell's National Library, and the Carisbrooke Library. His ready speech, retentive memory, earnest purpose, and bright style made him perhaps the most popular lecturer of his day. His teaching work at University College was marked by equally extraordinary success. In 1882 he accepted a post that made great calls on his time and energy—the principality of University Hall. This institution was partly a place of residence for students of University College, and partly the home of Manchester New College. During this time he rendered further services to the cause of education in London not only by his work on the council of University College, but by his advocacy of a teaching university for London. In 1880 he resigned the principality of University Hall and his professorship at University College, and retired to Carisbrooke, Isle of Wight, intending to devote his leisure to the completion of the great task of his life, *English Writers*. But with his work only half achieved he died on the 14th of May 1894.

MORLEY [OF BLACKBURN], JOHN MORLEY, VISCOUNT (1838–), English statesman and author, was born at Blackburn on the 24th of December 1838, being the son of Jonathan Morley, surgeon. He matriculated at Lincoln College, Oxford, in 1856, and after taking his degree in 1859 came up to London with the determination of seeking distinction by literature. He almost immediately became editor of the moribund *Literary Gazette*, which not all his ability could preserve from extinction. Gradually, however, he became known as a philosopher and a Radical, and as one of the ablest and most incisive contributors to the literary and political press of the day. His sympathies as a thinker seem to have been at this time chiefly with Positivism, though he never embraced Comte's doctrine in its hierarchical aspects; but he acquired a reputation as an agnostic, which became confirmed in the popular mind when he somewhat aggressively spelt God in one of his essays with a small "g." In 1868 he was editor for a short time of the daily *Morning Star*, which came to an end in 1870. In 1867 he succeeded G. H. Lewes in the editorship of the *Fortnightly Review*, which he conducted with brilliant success until 1883, when he was elected to parliament; he then assumed in exchange, but not for long, the lighter duties of the editorship of *Macmillan's Magazine*. He had been connected with Messrs Macmillan since the commencement under his editorship, in 1878, of the "English Men of Letters" series, a collection of biographies of various merit, in which nothing is better than the editor's own contribution in his *Life of Edmund Burke*, itself an extension of his article in the 9th edition of this encyclopaedia (1876). Since 1880 he had also been editor of the *Pall Mall Gazette*, which had been turned into a Liberal paper (see *NEWSPAPERS*).

In 1883 Mr Morley, who had twice unsuccessfully attempted to enter parliament, was returned for Newcastle-upon-Tyne at a by-election. The prestige thus acquired led to his presiding over a great Liberal congress at Leeds in the same year; and, although the platform never seemed his natural element, the literary finish of his style and the transparent honesty of his reasoning rapidly gained him a prominent position in the House of Commons. When, in February 1886, Mr Gladstone returned to office as a Home Ruler, Mr Morley, who had never before held any public appointment, filled one of the most important posts in the cabinet as secretary for Ireland. He had always expressed his sympathy with the Irish Nationalist movement. He had no opinions to recant, no pledges to explain away. He is credited with an especial influence over Mr Gladstone in the matter of Home Rule, and in particular with having kept him steady in the Bill of 1886 to his original purpose of entirely separating the Irish from the British legislature, a provision which pressure

from their own party afterwards compelled both of them to abandon. After the severe defeat of the Gladstonian party at the general election of 1886, Mr Morley led a life divided between politics and letters until Mr Gladstone's return to power in 1892, when he resumed his former office. He had been re-elected for Newcastle in circumstances entirely honourable to himself, a determined attempt having been made to exclude him in consequence of his resistance to an Eight Hours' Labour Bill, of which he disapproved as an undue interference in principle with the rights of adult labour. His constituents showed their appreciation of his integrity by returning him with a majority of 1739; but the resistance to his views on the labour question went on in his constituency, and was assisted by Joseph Cowen's persistent campaign in the principal Newcastle newspaper against the general lines of Mr Morley's somewhat doctrinaire and anti-Imperialistic views on politics. The result was that at the election of 1895 he lost his seat, but soon found another in Scotland, for the Montrose Burghs. He had during the interval taken a leading part in parliament, but his tenure of the chief secretaryship of Ireland was hardly a success. The Irish gentry, of course, made things as difficult for him as possible, and the path of an avowed Home Ruler installed in office at Dublin Castle was beset with pitfalls. In the intestine disputes which agitated the Liberal party during Lord Rosebery's administration, and afterwards, Mr Morley sided with Sir William Harcourt, and was the recipient and practically co-signatory of his letter resigning the Liberal leadership in December 1898.

Mr Morley's activities were now again turned to literature, the political views most characteristic of him, on the Boer war in particular, being practically swamped by the overwhelming predominance of Unionism and Imperialism. His occasional speeches, however, denouncing the Government policy towards the Boers and towards the war, though not representing the popular side, always elicited a respectful hearing, if only for the eloquence of their language and the undoubted sincerity of the speaker. As a man of letters his work was practically concluded at this period, and may briefly be characterized. His position as a leading English writer had early been determined by his monographs on *Voltaire* (1872), *Rousseau* (1873), *Diderot* and *the Encyclopedists* (1878), *Burke* (1879), and *Walpole* (1886). *Burke* as the champion of sound policy in America and (as Mr Morley deems) of justice in India, *Walpole* as the pacific minister understanding the true interests of his country, fired his imagination. His *Life of Oliver Cromwell* (1900) revises Gardiner as Gardiner revised Carlyle. The *Life of Cobden* (1881) is an able defence of that statesman's views rather than a critical biography or a real picture of the period. Mr Morley's contributions to political journalism and to literary, ethical and philosophical criticism were numerous and valuable. They show great individuality of character, and recall the personality of John Stuart Mill, with whose mode of thought he had many affinities. As in letters, so in politics. A philosophical Radical of a somewhat mid-19th-century type, and highly suspicious of the later opportunistic reaction (in all its forms) against Cobdenite principles, he yet retained the respect of the majority whom it was his usual fate to find against him in English politics by the indomitable consistency of his principles and by sheer force of character and honesty of conviction and utterance.

After the death of Mr Gladstone Mr Morley was principally engaged upon his biography, until it was published in 1903. Representing as it does so competent a writer's sifting of a mass of material, the *Life of Gladstone* was a masterly account of the career of the great Liberal statesman; traces of Liberal bias were inevitable but are rarely manifest; and in spite of the a priori unlikelihood of a full appreciation of Mr Gladstone's powerful religious interests from such a quarter, the whole treatment is characterized by sympathy and judgment. Among the coronation honours of 1902, Mr Morley was nominated an original member of the new Order of Merit; and in July 1902 he was presented by Mr Carnegie with the late Lord Acton's valuable library, which, on the 20th of October, he in turn gave to the university of Cambridge.

When Sir Henry Campbell-Bannerman formed his cabinet at the end of 1905 he was made secretary of state for India. In this position he was conspicuous in May 1907 and afterwards for his firmness in sanctioning extreme measures for dealing with the outbreak in India of alarming symptoms of sedition. Though he was bitterly attacked by some of the more extreme members of the Radical party, on the ground of belying his democratic principles in dealing with India, his action was generally recognized as combining statesmanship with patience; and, though uncompromising in his attitude towards revolutionary propaganda, he showed his popular sympathies by appointing two distinguished native Indians to the council, and taking steps for a decentralization of the administrative government. When Sir Henry Campbell-Bannerman resigned in 1908 and Mr Asquith became prime minister, Mr Morley retained his post in the new cabinet; but it was thought advisable to relieve him of the burden imposed by a seat in the House of Commons, and he was transferred to the upper house, being created a peer with the title of Viscount Morley of Blackburn. His subsequent career at the India office will always be associated with his extensive remodelling (1908-1909) of the system of government in India so as to introduce more fully the representative element (see INDIA). Whatever might be the outcome of this crucial reform, the preparation and execution of Lord Morley's scheme were carried through by him with a statesmanlike and philosophic detachment, and in a spirit of balanced reason, which earned for him the increased respect of all parties in the state. (H. CH.)

MORLEY, SAMUEL (1809-1886), English manufacturer and politician, was born at Homerton, not then a part of London, on the 15th of October 1809, the youngest son of a Nottingham hosier. His father, John, and his uncle, Richard, were the founders of the already prosperous Nottingham firm of I. & R. Morley, dealers in hosiery made in the cottages of the local knitters, and as early as 1797 they had opened a London warehouse, in the counting-room of which Samuel Morley began his career at sixteen. On his father's retirement in 1840 he became practical head of the London concern, and when his brothers retired in 1855 sole owner. In 1860 he was sole owner also of the Nottingham business. Under excellent management the business grew rapidly into the largest of the kind in the world, with huge mills at Nottingham and in Leicestershire and Derbyshire employing thousands of hands. In 1865 Morley was elected M.P. for Nottingham, and from 1868-1885 he sat for one of the Bristol divisions. He was a strong Liberal and a whole-hearted supporter of Gladstone, who in 1885 offered him a peerage. He was one of the principal proprietors of the London *Daily News*, the chief Liberal organ of the period, and it was owing to him that its price was reduced from 3d. to 2d. and its losses turned to great gains. Morley was a deeply religious man. Like his father before him, he was a Dissenter, and for many years he strongly opposed every scheme of state interference with education. He was keenly interested in the temperance movement, and during the closing years of his life his public energies were chiefly confined to its promotion. His philanthropy was active, his charity widespread and munificent, and he was a model employer. He died on the 5th of September 1886. His son, Arnold Morley (b. 1849), was Liberal M.P. for Nottingham from 1886-1888, and for East Nottingham from 1885-1895. From 1886-1892 he was chief Liberal whip, and from 1892-1895 postmaster-general.

See Edwin Hodder, *Life of Samuel Morley* (1887); Frederic M. Thomas, I. & R. *Morley: a Record of a Hundred Years* (1900).

MORLEY, THOMAS (1557-1603), English musical composer, was born in 1557, as may be gathered from the date of his motet, "Domine non est," composed "aetatis suae 10 anno domini 1576," and preserved in Sadler's Part-Books (Bodleian Library). He was a pupil of William Byrd, but nothing is known as to his origin and very little as to the incidents of his career. In the account of the entertainments given at Elvetham by the earl of Hertford in 1591 in honour of Queen Elizabeth, it is stated that there was "a notable consort of six Musitions," whose music so pleased the queen "that in grace and favour thereof, she gave

a new name unto one of their Pavans, made long since by Master *Thomas Morley*, then Organist of Paules Church." This statement, however, lacks corroboration, and if Morley ever held the post he must have done so for a very short time. On the 5th of July 1588 he was admitted Mus. Bac. at Oxford. Four years later (July 24, 1592) he entered the Chapel Royal, where he successively filled the offices of epistler and gospeller. From the dedication to his first book of canzonets it seems that in 1595 Morley was married. His wife's Christian name was Margaret, and before her marriage she apparently held some post in the household of Lady Periam, wife of the lord chief baron of the exchequer. On the 11th of September 1598 Morley received a licence for twenty-one years to print ruled music-paper and song-books in English, Latin, French or Italian. His rights under this grant were assigned by him to various publishers. In *Burton's Life of Gresham* it is stated (ii. 465) that the registers of St Helen's, Bishopsgate, show that Morley lived in that parish. This is inaccurate, and there is no proof that the family of the same name residing in St Helen's between 1594 and 1600 was related to the composer. In the preface to his *Plaine and easie Introduction to Practicall Musicke* (1597), Morley gives as one of his reasons for undertaking that work that he led a solitary life, "being compelled to keepe at home," presumably owing to ill health. On the 7th of October 1602 his place in the Chapel Royal was filled up, and on the 25th of October 1603 administration of his goods was granted to his widow. This document (*Act Book*, 1603, fol. 171) describes him as "late parishioner of St Botolph's near Billingsgate," but the registers of that parish contain no entries relating to him. Morley was incontestably one of the greatest of the secular Elizabethan composers. His madrigals, canzonets and ballets are as remarkable for their beauty as they are for their admirable workmanship, and his *Introduction to Practicall Musicke*, in spite of its frequent obscurity, is an invaluable source of information as to the state of musical science in England at the end of the 16th century. His works are: (1) *Canzonets to Three Voices* (1593; 2nd ed., 1606; 3rd ed., 1631; Ger. trans.: Cassel, 1612, and Rostock, 1624); (2) *Madrigals to Four Voices* (1594; 2nd ed., 1600); (3) *First Book of Ballets to Five Voices* (1595; an Ital. ed. appeared in London in the same year; 2nd ed., 1600; Ger. ed., Nuremberg, 1600); (4) *First Book of Canzonets to Two Voices* (1595; 2nd ed., 1610); (5) *Canzonets or Short Little Songs to Four Voices, selected out of Italian Authors* (1597); (6) *Canzonets to Five and Six Voices* (1597); (7) *A Plaine and easie Introduction to Practicall Musicke* (1597; 2nd ed., 1608; 3rd ed., 1771); (8) *Madrigals to Five Voices, selected out of Italian Authors* (1598); (9) *The First Book of Consort Lessons, made by divers authors, &c.* (1599; 2nd ed., 1611); (10) *The First Book of Aires to Sing and Play to the Lute with the Base Viol* (1600); (11) *The Triumphs of Oriana to Five and Six Voices, composed by divers several authors* (1601). Besides the above, services, anthems, motets and virginal pieces by Morley are to be found in various collections, both printed and manuscript. (W. B. S.*)

MORLEY, a municipal borough in the Morley parliamentary division of the West Riding of Yorkshire, England, 4 m. S.W. of Leeds, on the Great Northern and London & North-Western railways. Pop. (1901), 23,636. The town-hall was opened in 1895; and a park, for which the ground was presented by Lord Dartmouth, in 1890. The chief industries are connected with woollen cloth, machinery for the treatment of wool, coal and stone. The borough, incorporated in 1885, is under a mayor, 7 aldermen and 21 councillors. Area, 3385 acres. In the neighbourhood are ruins of a mansion, Howley Hall, dating from 1590, which, garrisoned for the parliament, sustained a heavy siege from the royalists during the Civil War.

MORMAOR, or **MORMAER** (from two Gaelic words *mor*, great, and *maor*, a steward or bailiff), a title used to designate the rulers of the seven provinces into which Celtic Scotland, i.e. the part of the country north of the Forth and the Clyde, was divided. These seven mormaors, or original "earldoms" of Scotland, as they were afterwards called, were: Angus, Athole with

Gowry, Caithness with Sutherland, Fife, Mar with Buchan, Moray with Ross, and Strathern with Menteith.

MORMONS, the common name given to the Church of Jesus Christ of Latter-Day Saints, a religious sect founded by Joseph Smith, jun., at Manchester, New York, in 1830, and since 1848 largely concentrated about Salt Lake City, Utah. Smith was born on the 23rd of December 1805 at Sharon, Windsor county, Vermont, from which place in 1815 or 1816 his parents, who like his grandparents were superstitious, neurotic, seers of visions, and believers in miraculous cures and in heavenly voices and direct revelation, removed to New York, where they settled on a small farm near Palmyra, Wayne county (then Ontario). In 1819 they removed to Manchester, in what is still Ontario county, about 6 m. from Palmyra. In Manchester Joseph, a good-natured, lazy boy, suffering from a bad heredity physically and psychically, began to have visions which seem to have accompanied epileptoid seizures (his mother's father had falling fits), from which he recovered apparently before he became of age. The boy's father was a digger for hidden treasure and used a divining rod to find proper places to dig wells, and about this time the son became a crystal gazer and by the use of a "peepstone" discovered the whereabouts of pretended hidden treasure. He said (in 1838) that on the night of the 21st of September 1823 the angel Moroni appeared to him three times, and told him that the Bible of the western continent, the supplement to the New Testament, was buried on a hill called Cumorah, now commonly known as Mormon Hill. It seems almost certain that he told other and earlier stories of how he came to find the gold plates, and it is possible that before this time there was a story current in Canada of the recovery of a "Gold Bible." It was not until the 22nd of September 1827 that (as he said) he dug up, on the hill near Manchester, a stone box, in which was a volume, 6 in. thick, made of thin gold plates 8 in. by 7 in., and fastened together by three gold rings. The plates were covered with small writing in characters which, it was said, Professor Charles Anthon declared were in the "reformed Egyptian tongue"; with the golden book Smith claimed that he found a breastplate of gold and a pair of supernatural spectacles, consisting of two crystals set in a silver bow, and called "Urim and Thummim"; by aid of these the mystic characters could be read. Being himself unable to read or write fluently, Smith employed as amanuenses: first Martin Harris (1793-1875); then his own wife, Emma; after the middle of April 1829, Oliver Cowdery, a blacksmith and school teacher; and David Whitmer (1805-1888); to them, from behind a curtain, he dictated a translation, for the printing and publishing of which Martin Harris paid, in spite of the continued opposition of his wife to the scheme. An edition of 5000 copies of *The Book of Mormon* was printed early in 1830 in the printing office of the *Wayne Sentinel* at Palmyra. It was accompanied by "The Testimony of the Three Witnesses," a sworn statement of Oliver Cowdery, David Whitmer and Martin Harris that an angel of God had shown them the plates of which the book was a translation, and by "The Testimony of the Eight Witnesses," four of them Whitmers and three of them Smiths (Joseph's father and his brothers Hyrum and Samuel). Soon afterwards, according to Smith, the plates disappeared, being taken away by the angel Moroni.

The Book of Mormon, in which Joseph Smith was declared to be God's "prophet," with all power and entitled to all obedience,

* Martin Harris took a copy in Smith's hand of certain "characters" (so Smith spelled it) to Dr Anthon, who at first thought it a hoax upon the learned, but, after hearing the story of the diamond spectacles and that Harris had been asked to pay for the publication of the book, said that it was a fraud on Harris. He recognized the miscellaneous and haphazard nature of the "characters," of which facsimiles are given by Riley, p. 81, and Linn, p. 40. Riley thinks that the "characters" were automatic writing, and that "unconscious cerebration played a large part in the evolving of the gold plate scheme."

* More than a dozen years afterwards Smith, when asked if "Mormon" was not connected with the Greek word for "hobgoblin" ("Mormo" is thus used in 17th-century English), explained that it meant "more good," with the "Egyptian mon," with the addition of *more*, or the contraction *mor*.

professes to give the history of America from its first settlement by a colony of "Jaredites" from among the crowd dispersed by the confusion of tongues at the Tower of Babel down to the year 5 A.D. These settlers in course of time destroyed one another. In 600 B.C. Lehi, his wife, and four sons, with ten friends, all from Jerusalem, landed on the coast of Chile. Upon the death of Lehi, the divine appointment to the leadership of Nephi, the youngest son, roused the resentment of his elder brothers, who were in consequence condemned to have dark skins and to be an idle, mischievous race, the "Lamanites" or North-American Indians. Between the Nephites and the bad Hebrews a fierce war was maintained for centuries, until finally, in spite of divine intervention in the person of the risen Christ, who here founded a Church with the same organization "as was enjoyed on the Eastern Continent," the Nephites fell away from the true faith, and in 384 A.D. were nearly annihilated in a battle at the hill of Cumorah, in Ontario county, New York. Among the handful that escaped were Mormon and his son Moroni, the former of whom collected the sixteen books of records, kept by successive kings and priests, into one volume, which on his death was supplemented by his son with some personal reminiscences and by him buried in the hill of Cumorah, where he was divinely assured that the book would one day be discovered by God's chosen prophet. This is Smith's account of the book: it was a contention of the early anti-Mormons, now however discredited, that *The Book of Mormon* as published by Smith was rewritten with few changes from an unpublished romance, *The Manuscript Found*, written before 1812 by Solomon Spaulding¹ (1761-1816), a minister and iron-founder who had become greatly interested in the prehistoric mounds of Ohio and wrote a romance to explain their origin and the Hebrew origin of the North-American Indians. The style of the book is poor; the speeches of primitive Indian chiefs are filled with the phraseology of the 19th-century camp-meeting; there are long extracts from the Westminster Confession, and a speech of Nephi contains a statement of doctrine which corresponds with heretical views held in Smith's own time in the presbytery of Geneva, in which his home lay.

The time was singularly favourable to the founding of a new sect: religious unrest and receptiveness were prevalent; and western New York was the scene of the foundation of various new communities between 1780, when Jemima Wilkinson founded "Jerusalem" in Yates county, New York, and 1848, when the Fox sisters gave their first spiritualistic manifestations about ten miles from Joseph Smith's home. His book and his claim to divine authority, upheld by frequent revelations, soon drew many followers to Smith. A Church was formally organized on the 6th of April 1830 at Fayette, Seneca county, New York; and in June a conference of about thirty members met at Fayette. Smith and Cowdery had previously (May, 1820) baptized each other, in alleged accordance with the instruction of John the Baptist, who had ordained them, conferring "the priesthood of Aaron"; while Peter, James and John afterwards made them priests of "the order of Melchisedec."

¹ It was supposed that Sidney Rigdon had been a compositor in a Pittsburg printing-office, that he had stolen Spaulding's manuscript from this office, or had made a surreptitious copy of it, and that he entered into a plot with Smith to use this material for a new Bible. In support of this are vague stories of a mysterious visitor to Smith at the time he was making his translation; and the argument that Smith did not, and Rigdon did, know enough to get the book in shape. But there is no actual proof that Rigdon lived in Pittsburg or was employed in a printer's shop there as early as when Spaulding's "copy" must have been left with the printer; and there is no evidence that Rigdon knew anything of Mormonism until after the publication of *The Book of Mormon*. The discovery by Professor J. H. Fairchild, in 1884, in Honolulu of a manuscript romance by Spaulding (now in the library of Oberlin College, Ohio), which did not agree at all in style or matter with *The Book of Mormon*, does not entirely settle the matter, as this romance is so different in character from the story read by Spaulding to some of his friends in 1811-1812, that if it was really Spaulding's, it must have been a later work than *The Manuscript Found*. Even, however, if it be true that Smith used Spaulding's story, his own additions to it must have been large, for parts of the *Book* seem autobiographic, and one incident seems to be based on the anti-Masonic excitement prevalent in New York state after the disappearance of William Morgan in 1826—ten years after the death of Solomon Spaulding.

In October 1830 Smith sent out Parley Parker Pratt (1807-1857), Oliver Cowdery, Ziba Peterson, and Peter Whitmer, jun., as missionaries. One of their first converts, in Mentor, Lake county, Ohio, was Sidney Rigdon (1793-1876), whom Pratt had formerly known, who had preached as a Baptist in 1810-1828—a part of this time in Pittsburg—who had then joined Alexander Campbell and Walter Scott in establishing the Disciples of Christ, and who was pastor of a church in Mentor. Rigdon was baptized, became a Mormon leader, and, after a "revelation" of December 1830, made a new translation of the Bible, in which prophecies of the coming of Joseph Smith and the nature of *The Book of Mormon* are inserted in the 50th chapter of Genesis and the 29th chapter of Isaiah respectively. This translation was not published until 1866 and is not in use in the Mormon churches. In January 1831 Smith, who had been "persecuted" in his New York home, where several lawsuits, all unsuccessful, had been brought against him, accompanied Rigdon to Ohio, where at Kirtland (a few miles south-west of Mentor), Lake county, Ohio, the preaching of the new sect was very successful, partly because Pratt and Rigdon were so well known to the Disciples in north-eastern Ohio. Smith at this time seems to have intended to make the New Jerusalem at Kirtland; there he established a general store, a steam saw-mill and a tannery, bought land, platted a great city, and built a stone temple, which was consecrated in 1836. But the church was "persecuted" again, especially by apostates; on the 25th of March 1832 Smith and Rigdon were tarred and feathered at Hiram,² Portage county, where they were then living. In February 1834 the Church was fairly organized; already on the 8th of March 1833 Smith, Rigdon, and Frederick G. Williams had been styled the first presidency, and were entrusted with the keys of the last kingdom. About this time the licentiousness of Smith might have led to the dissolution of the Church but for Brigham Young (1801-1877), a Vermont painter and glazier, who was baptized in 1832 and soon afterwards was ordained elder. Young's indomitable will, persuasive eloquence, executive ability, shrewdness and zeal soon made their influence felt, and, when a further step was taken in 1835 towards the organization of a hierarchy by the institution of the quorum of the "twelve apostles,"³ who were sent out as proselytizing missionaries among the "gentiles," Young was ordained one of the Twelve and despatched to preach throughout the eastern states. In 1836 the Kirtland Safety Society Bank was organized (in accordance with a "revelation" to Smith); as it was unchartered it issued notes under the name of "The Kirtland Safety Society anti-BANK-ing Co.," but in March 1837 Rigdon and Smith, the secretary and treasurer, were charged with violating the state law against unchartered banks, and they were convicted in October; the society appealed, claiming that it was not a bank but an association, but in November the "bank" suspended payments and in Jan. 1838 Smith and Rigdon left the state for Missouri. In 1836-1837 there had been a determined attempt to depose Smith and make David Whitmer head of the Church; Rigdon and Young successfully opposed this movement, which was backed by Whitmer, Pratt, Williams and Harris. Probably in June 1837 (or in July 1838) there was organized under the leadership of Captain "Fear Not" (David W. Patten) a band called "The Daughters of Zion" (see Mic. iv. 13), the "Big Fan" (Jer. xv. 7), "Brothers of Gideon," and finally "Sons of Dan," or "Danites" (Gen. xlix. 17), bound to secrecy under penalty of death, and formed to punish all who opposed the Church and its supreme head. Numerous crimes and outrages were attributed to them.⁴ In the winter

² Rigdon had formerly been well known and respected in Hiram, which was a stronghold of the Disciples; there he had taught Latin and Greek to the father of Mrs James Abram Gardiner.

³ Young received at this time the title of "The Lion of the Lord"; Lyman Wright and Parley Pratt, who also became apostles, were called respectively "The Wild Ram of the Mountains" and "The Archer of Paradise."

⁴ The existence of this organization has been denied by Mormons, but there is abundant evidence that it did exist. See Linn, pp. 212-214, and Bancroft, pp. 124-126; the latter, friendly to the Mormons, says (p. 124) that of the existence of the Danites "there is no question."

of 1830-1831 Pratt, Cowdery and two others had gone as far west as Jackson county, Missouri; in June 1831 Rigdon and Smith joined them there near what is now Independence and (in August) laid corner-stones of Zion and of a Mormon temple; thereafter Mormon immigration to Missouri increased rapidly; and in the early part of 1838 Smith and Rigdon fled to the new settlement called Far West (now Kerr) in Caldwell county, Missouri, which had been made in 1836-1837. Thither many of the saints had taken refuge, having been forcibly driven¹ from Independence and Big Blue in November and December 1833, and having been induced to remove from Clay county after staying there in 1833-1836. In Caldwell and Daviess counties Smith's troubles, however, continued to increase. His profligacy had repelled many of his leading supporters and bred internal dissensions, while from the outside the brethren were harassed and threatened by the steadily growing hostility of the native Missourians. At Far West on the 4th of July 1838 Rigdon preached his "salt sermon" from Matt. v. 13, urging his hearers to wage "a war of extermination" on those who disturbed them. To such a height did the conflicts with the "gentiles" grow that they assumed the proportions of a civil war, and necessitated the calling out of the state militia. A company of Danites from Far West put some Missourian militia to flight but lost their own leader Captain Patten; the gentiles then attacked a Mormon settlement at Hawk's Mill (near Far West) and killed in cold blood about a score of the Mormons. Late in October Far West surrendered to an overwhelming force of militia. Smith and Rigdon with others were arrested and imprisoned on a charge of treason, murder and felony, and their followers to the number of 15,000 crossed over into Illinois and settled near Commerce, Hancock county. Smith, who succeeded in escaping from custody, had rejoined the Mormons in Illinois, and there they were cordially welcomed, especially by the politicians of both parties, who hoped to secure the Mormon vote in the presidential campaign of 1840; and when they founded (on the site of Commerce) the city of Nauvoo, they readily obtained (Dec. 1840) from the state legislature a charter which made the city practically independent of the state government and gave Smith nearly unlimited civil power. He organized a military body called the Nauvoo Legion (also incorporated by the legislature), of which he was commander, being commissioned "lieutenant-general" by the governor of Illinois in 1841; Smith allowed Dr John C. Bennett, an Illinois politician and a new convert, to be the city's first mayor. Foundations of a new temple were laid on the 6th of April 1841 and the temple (83 by 128 ft.) was dedicated on the 1st of May 1846. The city grew very rapidly; a university of the city of Nauvoo was established, among its professors being Rigdon and Orson Pratt (1811-1881), a mathematician, who was called "The Gauge of the Law." In 1842 Smith was charged with instigating an attempt, made by O.P. Rockwell, a Mormon of Nauvoo, to assassinate ex-Governor L. W. Boggs of Missouri; it was impossible to hold either Rockwell or Smith after their indictment and arrest, since the Nauvoo municipal court had the power to determine cases of *habeas corpus*; the influence of Dr Bennett, who had quarrelled with Smith, was not strong enough to outweigh the power of the Mormon vote with the state authorities, and Smith was not held when in June 1843 he was arrested on the old charge of treasonable acts committed in Missouri. His downfall was brought about in a very different manner.

The Book of Mormon had forbidden polygamy: "There shall not any man have save it be one wife, and concubines he shall have none. For if I the Lord God delight² in the chastity of women. . . . For I will, saith the Lord of Hosts, raise up seed unto me, I will command my people, otherwise they shall hearken unto these things." The conditional clause may indicate that Smith from the first had intended to make polygamy a part of the

creed of the Church. There is some evidence that even in Ohio polygamy had been secretly practised by Smith and less probably by other elders. In Illinois there seems to have been no secret about Smith's cohabiting with other women. On the 12th of July 1843 he had a revelation expressly establishing and approving polygamy. This revelation was not published officially until 1852, but its purport immediately became known in Nauvoo and aroused great indignation. Dr R. D. Foster, whose wife Smith seems to have coveted, and whom Smith had accused of theft and immorality, William Law and Wilson Law, wealthy Canadian converts, and Sylvester Emmons, a member of the council, established a newspaper the *Expositor*, which was to work for the repeal of the city charter, "to correct the abuse of the unit power, to advocate disobedience to political revelations"; the first and only number (June 7, 1844) told of Hyrum Smith's reading to the council the "revelation on the eternity of the marriage covenant, including plurality of wives," of Joseph Smith's methods and success in winning spiritual wives, and of the prophet's political ambitions. The city council tried the editors of the *Expositor*, the Smiths denying the "revelation" on plural marriage, and on the 10th of June the *Expositor* printing office was razed. Foster and the Laws fled to Carthage. There was a general uprising against the Mormons and Smith put Nauvoo under martial law; but his most able lieutenants were absent,³ the legion surrendered its arms, and Joseph and Hyrum Smith and others were arrested on the charge of treason (June 25, 1844) and were imprisoned at Carthage. On the night of the 27th a mob, with the collusion of the militia guard, broke into the prison and shot the two brothers dead.

Rigdon, who the survivor of the first presidency, and Brigham Young, who was absent from Illinois at the time of Smith's death, were rivals for Smith's place; Young succeeded in having the Council of Twelve, of which he was head, made the supreme authority, and then had Rigdon⁴ tried for threatening treason and "cut off from the Church." Young had still to meet the opposition of Joseph Smith's family, who claimed for his son, Joseph, the right of succession, and for a time supported the claims of James J. Strang (1813-1856) of Wisconsin, who had been baptized in February 1844, who told of revelations he had received, who settled with his followers on Beaver Island, Michigan, in 1847, was crowned "King of Zion" there in July 1850, and was killed by some of his followers there in June 1856, when his kingdom broke up. In January 1845 the Nauvoo city charter was repealed; hostility and suspicion against the Mormons increased; there were "burnings" of Mormon property in the outlying country and retaliation by the Nauvoo Legion under a pro-Mormon sheriff; a commission of four members (including Stephen A. Douglas), appointed by the governor, arranged with the Mormon authorities in October 1845 that they should all leave the state next spring. In May and June 1846 most of the Mormons left Nauvoo; in September the city was cannonaded and it again surrendered to the gentiles.

Five companies of Mormon volunteers joined the force under Colonel Stephen W. Kearny which marched to California in the winter of 1846-1847; but this was rather in the nature of assistance from the general government, which provided for their western transportation, than a proof of Mormon patriotism. An exploring party under Brigham Young entered (July 24, 1847) the Great Salt Lake valley and chose it as a place for their new city. Young then returned to Winter Quarters, near what is now Florence, Nebraska, and there on the 5th of December 1847 was chosen president as Smith's successor. Under his leadership, and in accordance with a scheme "revealed" to him and announced in January 1847, the march was organized in a

² Brigham Young, Orson Pratt, and others of the Twelve were campaigning for Smith's candidacy for president of the United States, a campaign which he had undertaken because neither Henry Clay nor John C. Calhoun would give him satisfactory pledges as to the attitude he would take toward the Mormons if elected president.

³ Rigdon attempted, with brief success, to establish in Pittsburg a Church of Christ, independent of the Latter Day Saints, but based on much the same plan. He spent his last years at Friendship, Allegany county, New York.

¹ One of the early charges against the Mormons in Missouri was that they invited free negroes and mulattoes to settle with them; and this rather than any disgust at their religious teachings may have been the first source of opposition to them.

² Such solecisms are not infrequent in the Mormon Bible.

masterly way; the main body, for instance, in its trip across the prairies made flour in a mill built by Young and reaped grain sowed months before by an advance guard. The first migration arrived in Salt Lake City in September, and the population of the new settlement before the close of 1848 was about 5000. The city did not prosper, however, during the first few years of its settlement; but in 1849 and 1850 it became a *dépôt* and outfitting place for the immigrants to California in the gold excitement. The great improvement of the country under systematic irrigation (here first used on a large scale in the United States) was another factor in the industrial growth of the settlement. As early as 1837 Mormon missionary work had begun in Great Britain, and many foreign converts had immigrated to Ohio, Missouri and Illinois; in December 1847, in a "general epistle" to the Church, Young urged all Mormons in Europe to emigrate as speedily as possible; 120 British saints immigrated in February 1848; a general "emigrating fund" was established in 1849, and the Perpetual Emigration Fund Company was incorporated in 1850; but in 1855 when there were 4425 emigrants, according to the British agency, as a result of an attempt to cut down expenses, proper provision was not made for their transportation from Iowa City, only hand-carts or push-carts being supplied, and one-sixth of a party of 400 died of starvation or exhaustion in a winter march across the plains.

When the Mormons first went west they thought they would escape from the jurisdiction of the United States, but the treaty of Guadalupe Hidalgo at the close of the Mexican War transferred the region to the United States. In March 1849 a convention at Salt Lake City organized the "State of Deseret," of which Brigham Young was elected governor; a general assembly meeting in July sent a delegate to the Federal Congress and asked through Stephen A. Douglas for admission into the Union as a state or as a Territory; and on the 9th of September 1850 Utah was admitted as a Territory, of which Young became governor. He forced three non-Mormon district judges to leave the Territory in 1851, and by his open opposition to Lieut.-Colonel Edward Jenner Steptoe, U.S.A., who was stationed in Salt Lake City in the winter of 1854-1855 with about 300 soldiers on the way to California, and who was appointed governor of Utah in December 1854, forced Steptoe to decline the nomination. In 1855-1856 actual violence seems to have been offered to Judges George B. Stiles and W. W. Drummond; and about the same time Federal Indian agents in Utah complained that Mormon missionaries to the Indians were rousing them to hostilities against the United States. The defiant attitude of the Mormon Church towards the United States was thus being continually brought to the notice of the Federal authorities by official reports and by officials fugitive from Utah; and at the same time popular sentiment was stirred against Mormonism by constant rumour of violence in Utah against non-Mormons and apostates and by the official publication, in August 1852, of the "revelation on the eternity of the marriage covenant, including plurality of wives." In 1853 Young put down autocritically the "Gladdenites," followers of Gladden Bishop, who opposed polygamy. In 1856 the Mormon "Reformation" had begun: its principal factors were an elaborate system of confession to missionaries of the Church; the apparent inspiration by the Church of assassination of any suspected of hostility to the Church, of opposition to the ambition of its leaders, or of an intention to escape from Utah and the control of Young; and the doctrine of "blood atonement," which was introduced by Jedediah Morgan Grant (1817-1856) and by which the only remission for certain sins was the shedding of the sinner's blood, so that, according to Brigham Young, "cutting people off from the earth . . . is to save them, not to destroy them." Many outrages were committed by a Mormon band of desperadoes who called themselves "Wolf-hunters." Young's agents doubtless killed William P. Parish of Springville, Utah, early in 1857, apparently because he was planning to remove to California; at about the same time a party of six, including two brothers named Aikin, travelling from San Francisco were arrested as spies, were acquitted, and

then were attacked in their camp and murdered, one at least by an assassin who claimed that Young had given him the order; and at Mountain Meadows in Washington county, in the south-western part of Utah, on the 11th of September 1857, about 120 immigrants on their way to southern California, having been attacked four days before by Indians and Mormons and having made a bold defence, were tricked by a flag of truce carried by Mormons who pretended to be a rescuing party, and were killed by armed Mormon troops,¹ seventeen of the younger children being spared.

In 1857 President Buchanan² appointed Alfred Cumming (then superintendent of Indian affairs on the Upper Missouri) as governor of the Territory in place of Young, and sent 1500 men to Utah under Colonel Albert Sidney Johnston. On the 15th of September Young issued a proclamation forbidding all armed forces from entering the Territory, calling to arms all forces in the territory, and declaring martial law. On the 5th and 6th of October a band of mounted Mormons under Major Lot Smith captured and burnt three supply-trains of the Federal troops; soon afterwards 800 oxen were cut out from another supply-train and were driven to Salt Lake City. The main body of the Federal troops under Colonel Johnston went into winter quarters in November at Black's Forks, near Fort Bridger. But in the spring of 1858, through the intervention of Thomas L. Kane of Pennsylvania, who had probably been baptized by Young in 1847 and seems to have been a Mormon agent in the East, and who now received letters of authority from President Buchanan, the Mormons were induced to make a merely formal submission to Federal authority. Governor Cumming acquiesced in this settlement of affairs, by which the actual victory was with the Saints. A peace commission sent to Utah in the summer of 1858 carried to the Mormons a presidential proclamation by which they received pardon for their treason. Practically all the Federal troops were withdrawn from Utah in the summer of 1860; soon afterwards Governor Cumming left the Territory to join the Confederate army. One of his immediate successors, John W. Dawson of Indiana, late in 1861 was forced to leave the territory, having been terribly beaten by several Mormons who professed (with apparent truth) to avenge an insult to a woman. In 1862, because the Mormons were suspected of sympathizing with the Confederate States, Colonel P. E. Connor, in command of the military district of Utah (and Nevada), actually marched United States troops into Salt Lake City. Governor Stephen S. Harding, appointed in 1862, proved less tractable than previous governors; a mass meeting in March 1863 undertook to secure his removal; and in June he and a Federal judge were displaced, possibly by the influence of Young (whom Harding had arrested for polygamy but who was not indicted), through capitalists interested in western mail-express and telegraph projects. The Church became less hostile to the Federal government toward the close of the Civil War, as it became apparent that the Confederacy was to be defeated.

Young made a successful effort in 1868-1869 to assure the industrial and commercial control of Utah: after Colonel Connor established Camp Douglas in the immediate vicinity of Salt Lake

¹ There is no positive proof that this massacre was ordered by the authorities. John Doyle Lee, who was executed in 1877 for the massacre, was a prominent Mormon, had been "adopted," as a spiritual son of Brigham Young in Nauvoo, was one of the founders of Provo and other Mormon settlements in southern Utah, a probate judge, afterwards a member of the Territorial legislature, and his statement implicates the Church. Lee said that he was sacrificed to justice. The only charge against the immigrants seems to have been that they were from Arkansas, and that all Arkansians had forfeited their lives because it was in Arkansas (near Van Buren) that Parley Parker Pratt, the Mormon Isaiah, was killed on the 17th of May 1857 by Hector H. McClean, with whose wife Pratt had eloped. It seems probable that sentiment was aroused against the Arkansians by false stories of their poisoning wells, burning fences, &c.

² Buchanan's message (Dec. 8, 1857) stating that Young and his followers apparently intended "to come into collision with the government of the United States" and his sending troops to Utah were considered by his critics as attempts to create an issue which would overshadow the slavery question and to draw away from the army an important force.

City it became increasingly difficult for the Mormon authorities to prevent trade with gentile stores in the city; and in 1869 there was incorporated the Zion Co-operative Mercantile Institution, to which practically all retailers in the territory were forced to sell out. In 1869 the Pacific Railroad reached Salt Lake City and by lessening its isolation, lessened its control by Young. His power was shaken somewhat, and the general tone of Mormonism was improved greatly by the "Godbeite movement," led by W. S. Godbe and E. L. T. Harrison, who with T. B. H. Stenhouse, author of *The Rocky Mountain Saints* (1874), Edward W. Tullidge, who wrote an official *History of Salt Lake City*, and others, had established in 1868 the *Utah Magazine*, which attacked Young's despotism. Although Godbe and Harrison were "cut off" from the Church they succeeded in founding the *Salt Lake Tribune* (1870), the first permanent protest in Utah against Young. At the same time the power of the Latter-Day Saints and Young's autocracy were threatened by the growth of the Reorganized Church of Jesus Christ of Latter-Day Saints, which was formed in 1852 upon the announcement of the doctrine of polygamy, which declared that polygamy had been foisted upon the Church and that Brigham Young was an interloper, and which chose Joseph Smith III. (son of Joseph Smith, jun.; born in 1832) as its head in 1860; in 1863; and in 1869 representatives of the Reorganized Church preached in Salt Lake City.

As early as 1862 Congress had passed the Morrill Act (introduced by Justin S. Morrill) "to punish and prevent the practice of polygamy in the Territories," but in 1867 the presiding officers of the Utah legislature, petitioning for the repeal of this act, declared that "the judiciary of this Territory has not, up to the present time, tried any case under said law." Attempts to pass some extreme measures in 1866 and in 1869-1870 failed. In October 1871 a grand jury in Utah indicted Young and others for violating a Territorial statute against improper cohabitation; but in April 1872 the Supreme Court of the United States (*Chilton v. Englebrecht*) practically declared the jury incompetent as it had been impanelled by a Federal (and not by a Territorial) marshal, and in October 1873 the same court (*Snow v. The United States*) ruled that the attorney-general appointed by the president in a territory could try no cases save those in which the Federal government was a party, thus putting the prosecution of polygamy cases into the hands of the locally elected attorney-general. But on the 23rd of June 1874 President Grant signed the Poland Act,¹ "in relation to courts and judicial officers in the Territory of Utah," which provided for prosecution by the United States attorney-general (not the locally elected official) in criminal cases in Federal courts in the Territory, for the impanelling of grand and petit jurors by the United States marshal, and for the challenge of any juror practising or believing in polygamy on a trial for adultery or polygamy, and otherwise corrected the defects in the Territorial law as pointed out by the Supreme Court, so that prosecutions for polygamy might no longer be a mere farce. But the law was little more than a dead letter: there were few prosecutions, and the only conviction was that of Young's secretary, George Reynolds, whose case dragged on from 1874 to 1879. In 1873 Ann Eliza Young, called "Wife No. 10," brought a suit for divorce against Brigham Young; the defendant was at various times imprisoned and fined for failure to pay alimony *pendente lite*; and in 1877 the judge decided that the marriage was void as polygamous.

Young died in Salt Lake City on the 20th of August 1877; he left an estate of more than \$2,000,000, and was survived by about 25 wives and more than 40 children. The Church owes much to him, for he was an able leader. It has been said of him that he was "for darning a Cromwell, for intrigue a

Machiavelli, for executive force a Moses, and for utter absence of conscience a Bonaparte." It must be borne in mind that to him, more than to anyone or anything else, was due the long struggle of the Church against the United States. His only doctrinal contribution to the Church was in 1852 when, in a sermon, he said that our Father could be none other than the first Man; that Adam came into the garden of Eden in a celestial body and with one of his wives; and that "He is our Father and our God, and the only God with whom we have to do."

Young's successor in the presidency—acting president until 1880—was John Taylor (1808-1887), an Englishman by birth, who was living at Toronto when P. P. Pratt converted him in 1836; he was a missionary in England in 1840; then went to Nauvoo and was wounded when Smith was killed; preached in France and Germany, and translated *The Book of Mormon* into French. His first counsellor, appointed in 1880, was George Q. Cannon, who was probably the real administrator. On the 22nd of March 1882 President Arthur approved the Edmunds Act, drafted by George F. Edmunds of Vermont, which disfranchised polygamists in the Territories, made ineligible for jury duty in prosecutions for bigamy, polygamy, or unlawful cohabitation all who practised polygamy or believed in it, and made polygamy punishable by a maximum fine of \$500 and imprisonment of not more than five years, and cohabitation with more than one woman punishable by a maximum fine of \$300, imprisonment for not more than six months, or both. The act was opposed because it was *ex post facto*. Under the Edmunds Act and the Edmunds-Tucker Act of March 1887 about 1200 persons were convicted of polygamy or unlawful cohabitation in Utah, Idaho and Arizona. The law was so rigidly enforced that about 12,000 were disfranchised, and the president of the Church had to spend his last years in hiding, and many other prominent Mormons escaped "on the underground." The Edmunds-Tucker Act of 1887 dissolved the Perpetual Emigration Company and the corporation of the Church of Jesus Christ of Latter-Day Saints; and the Supreme Court in May 1890, on the ground that the Church was an organized rebellion, upheld the constitutionality of the confiscation of the Church property. On the 24th of September 1890 Wilford Woodruff² (1807-1898), who had been chosen to succeed President Taylor in 1880, and who was himself a polygamist, issued a manifesto declaring "that my advice to Latter-Day Saints is to refrain from contracting any marriage forbidden by the law of the land"; and on the 6th of October the general conference of the Church approved Woodruff's manifesto and accepted "his declaration concerning plural marriages as authoritative and binding." This apparent rescindment of "revelation" was explained by Mormon scholars as Smith had explained the abandonment of the New Jerusalem in Missouri—the Saints were prevented from carrying out the commands contained in a revelation, but as they had tried to obey, they would not be punished for disobedience.³ On the 4th of January 1893, in response to a petition from the officials of the Church pledging the membership thereof to faithful obedience to the laws against polygamy, &c., President Harrison issued a general pardon to all liable to the penalties of the Edmunds-Tucker Act, on condition that they had not violated its provisions since the 1st of November 1890 and should not violate them in future. On the 4th of January 1896 Utah was admitted to the Union as a state, one of the conditions made by Congress being that polygamy should be prohibited by the state constitution, and that this prohibition be repealable only with the consent of the United States and of the people of the state; and article iii. of the constitution reads: "The following ordinance shall be irrevocable without the consent of the United States and the people of this state: Perfect

¹ This act, introduced by Luke Potter Poland (1815-1887) of Vermont, was bitterly opposed by the Congressional delegate from Utah, George Q. Cannon (1827-1901), an Englishman by birth, a prominent Mormon missionary in Hawaii and Great Britain, and Parley P. Pratt's successor as apostle. He had been elected in 1872, and there was a long fight to prevent his being seated because he was a polygamist.

² Woodruff was born in Connecticut, became a Mormon in 1832, in 1839 was made an apostle, in 1840 and in 1845 was a missionary to England, preached throughout the United States; wrote *Letters from my Journal* (1881), and was called in the Church "Wilford the Faithful."

³ In 1831 the Order of Enoch, or United Order, was established, providing for a community of goods; when the people proved unable to keep this law, the "lesser law of tithing" was given to them in 1838.

toleration of religious sentiment is guaranteed. No inhabitant of this state shall ever be molested in person or property on account of his or her mode of religious worship; but polygamous or plural marriages are for ever prohibited." In March 1836 the escheated property of the Church still in possession of the United States government was restored, but the Church was not again incorporated, its legal business being transacted by its president as trustee-in-trust for the body of religious worshippers known as the Church of Jesus Christ of Latter-Day Saints; each ward of the Church has, however, been incorporated, and its bishop is its executive head. In 1808 President Woodruff died and was succeeded by Lorenzo Snow (1814-1901), a native of Ohio, converted to Mormonism in 1836. In 1808 Brigham Henry Roberts (b. 1857), an Englishman by birth and a Mormon leader, was elected to Congress from Utah; as he had three wives there was objection to his taking his seat in 1899 in the 56th Congress; and on the 25th of January 1900 by a vote of 268 to 50 he was excluded from his seat. In 1903 Reed Smoot (b. 1862), an apostle of the Church, was elected to the United States Senate, where there was an attempt to exclude him (not on the ground that he was a polygamist, for there was no suspicion of his having violated the law, but because the apostles of the Church still advocated polygamy); the Senate Committee on Privileges and Elections reported in favour of his exclusion; but on the 20th of February 1907 the Senate voted against his exclusion (42-28). According to Senator Smoot there were in 1906 not more than 500 householders in Utah who were polygamous; only six of the twelve apostles, and only one chosen since April 1900, were polygamous; and of the fourteen general authorities chosen between 1890 and 1906 twelve were monogamists. Joseph Fielding Smith (b. 1838), a nephew of the prophet, being a son of Hyrum Smith, succeeded to the presidency in 1901; he was a polygamist, and in March 1907, soon after the birth of what was said to be his forty-third child, he pleaded guilty when charged with breaking the law against polygamy and was fined \$300.

The growth of the Latter-Day Saints has been largely in foreign countries. Missionary work in southern Canada was begun in 1833 by Orson Pratt, and in 1836 his brother, Parley P. Pratt, organized a mission in Toronto; in 1837 the work was begun in Liverpool, which is still the headquarters in Great Britain; in Ireland the work met with little success; from Germany missionaries were expelled in 1851 and in 1853; the *Book of Mormon* was translated into Italian by Lorenzo Snow in 1852; a Hawaiian version was made in 1856 by George Q. Cannon; and the missions in Scandinavia were begun about 1850. In the earlier years of the Church all converts were urged to migrate to Utah, and the glowing accounts of life there doubtless increased their number; the later policy of the Church, to which it was forced after 1887, when the Perpetual Emigration Fund was dissolved and assisted immigration was forbidden by the Federal government, was for converts to remain in their native countries. In England (and to a lesser degree on the Continent) the announcement of the doctrine of plural marriage was a disadvantage to the Church, and many converts transferred their allegiance to the Josephites, or Reorganized Church of Jesus Christ of Latter-Day Saints, who always opposed polygamy and attempted to prove that such doctrines had been foisted on the Church by Brigham Young, who had supplanted Joseph Smith's true successor, Joseph Smith III.

In 1908 the total number of Latter-Day Saints in the United States (chiefly in Utah and the neighbouring states) was estimated at 350,000, and there were besides about 48,000 members of the Reorganized Church. In Utah there are four great Mormon temples—at Salt Lake City (1893), Manti (1888), Logan (1884) and St George (1877). The Reorganized Church has twice been declared by United States Courts the legal successor of the Church founded by Joseph Smith, jun.; it holds that "the doctrines of polygamy, human sacrifice, or killing men to save them, Adam being God, Utah being Zion or the gathering place of the saints, are doctrines of devils"; its headquarters are in Lamoni, Iowa, whither it was removed from Plano, Illinois, in 1881; it has several churches in Canada, the largest being at London, Ontario, and Toronto, and it is the owner of a Temple lot at Kirtland, Illinois.

The Temple lot at Independence, Missouri, is owned by the small band of Mormon schismatics (organized in Illinois in 1835) who call themselves "The Church of Jesus Christ," and are known as Hedrickites; the Utah Church considers Independence as the holy city, and made a large settlement there in 1907.

The general morality of the Mormons seems to have been high for a frontier community; there was no gambling nor drunkenness. The Saints, notably in the time of Brigham Young, were fond of dancing, and the Deseret Dramatic Association was formed and a theatre was built in the early years of the settlement in Utah.

Government.—The Mormon hierarchy is highly complicated. At the head of the body is a president, who possesses supreme authority, and is successor to Joseph Smith, jun., "Seer, Translator, Prophet"; the president is supported by two counsellors. These three are supposed to be the successors of Peter, James and John, constitute what is known as the "first presidency," seem to typify the Trinity, and are the head of the priesthood of Melchisedec. Then comes the "patriarch," whose chief duty is to bless and lay on hands, and after him the "twelve apostles," forming a travelling high council. Of these the president is *ex officio* one, and endowed with authority equal to the other eleven. Their duties are important. They ordain the officers just named—president, two counsellors, patriars, apostles, presidents of seventies, elders and high priests, and the Aaronic priesthood, which is subordinate to the priesthood of Melchisedec, and is occupied rather with temporal affairs, the highest office is that of the presiding bishop, who superintends the collection of tithes; other Aaronic officials are styled priests, teachers and deacons. The Church is made up of about 50 stakes (21 in Utah), each having a presidency (a president and two counsellors), and is divided into wards, which are subdivided into districts, each of which has a certain number of teachers, a meeting-house, Sunday school, day school, and dramatic, debating and literary societies.

Doctrine.—A system of polytheism has been grafted on an earlier form of the creed, according to which there are grades among the gods, the place of supreme ruler of all being taken by the primeval Adam of Genesis, who is the deity highest in spiritual rank, while Christ, Mahomet, Joseph Smith and Brigham Young also partake of divinity. The business of these deities is the propagation of souls to people bodies begotten on earth, and the sexual relation permeates the creed. The saints on leaving this world are deified, and their glory is in proportion to the number of their wives and children; hence the necessity and justification of polygamy (although its practice is not now authorized by the Church), and the practice of having many wives sealed to one saint. Marriage, if accompanied by the ecclesiastical ceremony of a sealing, is for eternity, and is a necessary pre-requisite to heavenly bliss. A man may be sealed to any number of women, but no woman may be sealed to more than one man. Both marriage and sealing by proxy are permitted to assure salvation to women who die unsealed. This system of spiritual wives or celestial marriage is based on the idea that a woman cannot be saved except through her husband. Polygamous marriage is supposed to make possible the procreation of enough bodies for thousands of spirits which have long awaited incarnation. Especially in their earlier years the Mormons believed in faith healing, and Joseph Smith bade them "trust in God when sick, and live by faith and not by medicine or poison." Their distinguishing points of faith are: religiously a belief in a continual divine revelation through the inspired medium of the prophet at the head of the Church; morally, polygamy, though this is condemned in the *Book of Mormon*, as has been noticed above; and, socially, a complete hierarchical organization. They believe in the Bible as supplemented by the *Book of Mormon*, the *Book of Doctrine*, and revelation through the president of the Church; in the gift of prophecy, miracles and casting out devils; in the imminent approach of the end of the world; in their own identity with the apocalyptic saints who shall reign with Christ in a temporal kingdom, either in Missouri (at Independence) or in Utah; in the resurrection of the body; in absolute liberty of private judgment in religious matters; and in the salvation of a man on his death-bed by baptism by a Christ-appointed apostle, and receive the laying on of hands for the gift of the Holy Ghost by duly-authorized apostles. Among their minor rules as laid down in a *Word of Wisdom* supposed to have been revealed to Joseph Smith (Feb. 27, 1833), are these recommendations: that it is not good to drink wine or strong drink, except at the Lord's Supper (and even then it should be home-made grape-

wine), or to use hot drinks or tobacco—the former being meant for the washing of the body and the latter for the healing of bruises and sick cattle; man's proper food is herbs and fruit; that for beasts and fowls, grain; and, except in winter and in case of famine and severe cold, flesh should not be eaten by man. Infant baptism is also condemned, but the children of saints who have reached their eighth year should be baptized. The deceased, also, can be baptized by proxy, and in this way—"baptism for the dead" (1 Cor. xv. 29)—Washington, Franklin and others have been vicariously baptized into the Church, since, according to the Mormons, there was no valid baptism between the time of the corruption of the primitive Church and the establishment of the Church of Latter-Day Saints.

BIBLIOGRAPHY.—The *Book of Mormon*, first printed in 1830, has been reprinted and translated frequently. Smith also wrote a *History of Joseph Smith*, being extracts from his journal, published in 1842-1846 in *Times and Seasons*, a church periodical, and a *Book of Commandments, for the Government of the Church of Christ* (Zion, Jackson county, Missouri, 1833), and "compiled" a *Book of Doctrine and Covenants of the Church of the Latter-Day Saints* (Kirtland, Ohio, 1835, and often reprinted); and *The Pearl of Great Price: Being a choice Selection from the Revelations, Translations and Narratives of Joseph Smith, First Prophet, and Revelator to the Church of Jesus Christ of Latter-Day Saints* (Liverpool, 1851; Salt Lake City, 1891). The best bibliographies are in H. H. Bancroft's *History of Utah* (San Francisco, 1889), vol. xxi. of the *History of the Pacific States of North America*, in which the effort to avoid bias against the Mormons has made the work biased in their favour, and in I. Woodbridge Riley's *The Founder of Mormonism, a Psychological Study of Joseph Smith, Jr.* (New York, 1902), the first inquiry by a trained psychologist into Smith's case. More important than either of these works is William Alexander Linn's *The Story of the Mormons from the Date of their Origin to the Year 1901* (New York, 1902); Linn, unlike Riley, thinks it proved that Rigdon used the "spaulding manuscript" in the preparation of the *Book of Mormon*. E. W. Tullidge's *History of Salt Lake City* (Salt Lake City, 1886) and Orson F. Whitney's *History of Utah* (4 vols., Salt Lake City, 1892-1898) are valuable general works by Mormon writers; the leaders of the Reorganized Saints, Joseph Smith III and Herman C. Smith, wrote *A History of the Church of Jesus Christ of Latter-Day Saints* (Lamoni, Iowa, 1901); and Tullidge, a Unitarian of the same name, wrote *A Life of Joseph the Prophet* (Piano, Illinois, 2d ed., 1880). Edward H. Anderson's *Brief History of the Church of Latter-Day Saints* (3rd ed., 1905) and J. E. Talmage's *Story of Mormonism* (reprinted, 1907) are regarded by Mormons as authentic. Early attacks on Mormonism are E. D. Howe's *Mormonism Unveiled* (Painesville, Ohio, 1834) and Pomeroy Tucker's *Origin and Progress of the Mormons* (New York, 1867). And among works descriptive of Mormonism in Utah written by Gentiles the more important are: *History of the Mormons of Utah: their Domestic Policy and Theology* (Philadelphia, 1852), by Lieut. J. W. Gunnison of the U.S. Topographical Engineers, who took part in surveys preliminary to the building of a transcontinental railway; *Life and the Mormons* (New York, 1854), by B. G. Ferris, secretary of Utah Territory in 1854-1853; Horace Greeley, *Overland Journey from New York to San Francisco in 1859* (New York, 1860); Jules Remy, *Journey to Great Salt Lake City* (London, 1861); and *The City of the Saints, and across the Rocky Mountains to California* (London, 1861), by Richard F. Burton, who spent a month in Salt Lake City in 1860. There is much valuable material in the *Reports of the Utah Commission* appointed under the Edmunds Act, in *Testimony before the Senate Committee in the Smoot case* (1903-1905), and in the *Report of the Committee on Privileges and Elections* (Senate Report 4253, 59th Congress, 1st Session), also in the Smoot case.

MORMYR. The mormyrs (*Mormyridae*) are one of the most remarkable families of the Malacopecterygian fishes, confined to the fresh waters of tropical Africa and the Nile. About 100 species, referred to two sub-families and ten genera, are now known, a great number of new forms having recently been discovered in the Congo. They are curious-looking, highly aberrant fishes, very variable in the extent of the vertical fin and in the form of the body, and especially the head, which may be either extremely abbreviated or elongated into a rostrum, with or without a dermal appendage or "feeler." The shape of the head has suggested many of the specific names which have been given to these fish, such as *elephas*, *tapirus*, *tamandua*, *caballus*, *ovis*, *ibis*, *numenius*, &c. Some forms are eel-shaped. The mormyrs are further remarkable for the enormous development of the brain and for the problematic organ which surmounts it; also as being among the few fishes in which an electric organ has been discovered. This organ, situated on each side of the caudal region, is derived from the muscular system and is of feeble power; it was long considered as "pseudoelectric."

Very little is known of the habits of these fishes. Professor G. Fritsch, of Berlin, during his stay in Egypt for the purpose of experimenting on electric fishes, observed that they perish very rapidly when removed from the water, and he had the greatest difficulty in keeping some alive in an aquarium for two or three days. Captain S. Flower has recently been more successful, and the mormyrs have proved a great success in the Gezira aquarium, near Cairo, examples of the species having lived from ten to twenty-six months. The species with comparatively large mouths feed principally on fishes and crustaceans, the others on tiny animals and vegetable and more or less decomposed matter. P. Delhez, on the Congo, found that many are attracted to the borders of the river in the neighbourhood of human dwellings, where they feed on the refuse thrown into the water. It is probable that the species with a rostrum use it to procure small prey hidden between stones or buried in the mud, and that the fleshy mental appendage with which they are provided is a tactile organ compensating the imperfection of the vision in the search for food. Until quite recently absolutely nothing was known of the breeding-habits and development. To the late J. S. Budgett we owe some very interesting observations made in the Gambia on *Gymnarchus niloticus*, which makes a nest, and the larvae of which are provided with filamentous external gills.

Generated by the ancient Egyptians, the mormyrs are often represented on hieroglyphics and mural paintings as well as in bronze models. The "Oxyrhynchus," remarkable for its long, curved snout, is the most frequently depicted. A revision of the *Mormyridae* has been published by G. A. Boulenger in the *Proc. Zool. Soc.* (1898), with a bibliographical index to the various anatomical and physiological contributions. The skull has been minutely studied by W. G. Ridewood, *Journ. Linn. Soc.* (Zool. xxix., 1904, p. 188). Figures of the most remarkable forms will be found in Boulenger's *Poissons nouveaux du Congo*, *Ann. Mus. Congo* (Zool. i. and ii., 1898-1902), and in his *Fishes of the Nile* (London, 1907, 4th). On the breeding habits of *Gymnarchus*, cf. J. S. Budgett, *Trans. Zool. Soc.* (1901), xvi. 126. (G. A. B.)

MORNAY, PHILIPPE DE (1540-1623), seigneur du Plessis-Marly, usually known as Du-Plessis-Mornay or Mornay Du Plessis, French Protestant, was born at Buhy in Normandy on the 5th of November 1540. His mother had leanings toward Protestantism, but his father sought to counteract her influence by sending him to the Collège de Lisieux at Paris. On his father's death in 1559, however, the family formally adopted the reformed faith. Mornay studied law and jurisprudence at Heidelberg in 1565 and the following year Hebrew and German at Padua. On the outbreak of the second religious war in 1567, he joined the army of Condé, but a fall from his horse prevented him from taking an active part in the campaign. His career as Huguenot apologist began in 1571 with the work *Dissertation sur l'église visible*, and as diplomatist in 1572 when he undertook a confidential mission for Admiral de Coligny to William the Silent, prince of Orange. He escaped the St Bartholomew massacre by the aid of a Catholic friend, and took refuge in England. Returning to France towards the end of 1573, he participated during the next two years with various success in the campaigns of Henry of Navarre. He was taken prisoner by the duke of Guise on the 10th of October 1575, but not being recognized was ransomed for a small sum. Shortly afterwards he married Charlotte Arbaleste at Sedan. Mornay was gradually recognized as the right-hand man of the king of Navarre, whom he represented in England from 1577 to 1578 and again in 1580, and in the Low Countries 1581-1582. With the death of the duke of Alençon-Anjou in 1584, by which Henry of Navarre was brought within sight of the throne of France, the period of Mornay's greatest political activity began, and after the death of the prince of Condé in 1588 his influence became so great that he was popularly styled the Huguenot pope. He was present at the siege of Dieppe, fought at Ivry, and was at the siege of Rouen in 1591-92, until sent on a mission to the court of Queen Elizabeth. He was bitterly disappointed by Henry IV's abjuration of Protestantism in 1593, and thenceforth gradually withdrew from the court and devoted himself to writing. He founded in 1593 the Protestant academy or

university at Saumur, which had a distinguished history until its suppression by Louis XIV. in 1683. In 1598 he published a work on which he had long been engaged, entitled *De l'institution, usage et doctrine du saint sacrement de l'eucharistie en l'église ancienne*, containing about 500 citations from the scriptures, fathers and schoolmen. Jacques Davy Du Perron, bishop of Evreux, afterwards cardinal and archbishop of Sens, accused him of misquoting at least 500, and a public disputation was held at Fontainebleau on the 4th of May 1600. Decision was awarded to Du Perron on nine points presented, when the disputation was interrupted by the illness of Mornay. His last years were saddened by the loss of his only son in 1605 and of his devoted wife in 1606, and were marked only by perfecting the Huguenot organization. He was chosen a deputy in 1618 to represent the French Protestants at the synod of Dort, and though prohibited from attending by Louis XIII., he contributed materially to its deliberations by written communications. He was deprived of the governorship of Saumur at the time of the Huguenot insurrection in 1621, and died in retirement on his estate of La Forêt-sur-Sèvre on the 11th of November 1623.

His principal works, in addition to *De l'institution, usage et doctrine du saint sacrement de l'eucharistie en l'église ancienne* (La Rochelle, 1598), mentioned above, are *Excellent discours de la vie et de la mort* (London, 1577), a bridal present to Charlotte Arbalste; *Traité de l'église où l'on traite des principales questions qui ont été mues sur ce point en nostre temps* (London, 1578); *Traité de la vérité de la religion chrétienne contre les athées, épicuriens, payens, juifs, mahométans et autres infidèles* (Antwerp, 1581); *Le mystère d'iniquité, c'est à dire, l'histoire de la papauté* (Geneva, 1611). Two volumes of *Mémoires*, from 1572 to 1589, appeared at La Forêt (1624-1625), and a continuation in 2 vols. at Amsterdam (1625), a more complete but very inaccurate edition (*Mémoires, correspondances, et vie*) in 12 vols. was published at Paris in 1624-1625.

See the life of Mornay written by his wife for the instruction of their son, *Mémoires de Mme Duplessis-Mornay*, vol. i. in the ed. of *Mémoires et correspondances de Duplessis-Mornay* (Paris, 1824-1825); E. and E. Haag, *La France protestante*, article "Mornay"; J. Ambert, *Du Plessis-Mornay* (Paris, 1847); E. Stähelin, *Der Übertritt K. Heinrichs IV. von Frankreich zur katholischen Kirche* (Basel, 1856); Weiss, *Du Plessis Mornay comme théologien* (Strasbourg, 1867). There is a good article "Du Plessis-Mornay" by T. Schott in Hauck's *Realencyklopädie*, and another by Grube in *Kirchenlexikon*.

MORNING, properly the dawn of day, sunrise, but extended to the whole early part of the day, from the dawn to midday. "Morning" (M. Eng. *morveing*) was formed on the analogy of "evening," from "morn," in M. Eng. *morwen*, and originally meant the coming of the sunrise, as "evening," the coming of the close of the day (O. Eng. *afnung*, from *afen*, eve). The O. Eng. *morgen* represents the common Teutonic word for the dawn; the ultimate source has been assigned to the root, seen in "murk" "murky," meaning to be dark, or, with more probability, to the root *mergh*, to twinkle, shine (cf. Lith. *mirga*), and further to the root *mar*, as in Gr. *μαρμαίρω*, to shine (cf. Lat. *marmor*, marble). The M. Eng. *morwen* dropped the *n* and became *morue*, "morrow," which properly means "morning," but was soon used of the day following the present.

The "morning-star" (Ger. *Morgenstern*) was a military weapon of the middle ages, consisting of a mace or club with a ball head studded with spikes; the spiked ball was sometimes swung loose from the head of the mace by a chain. The weapon was also known as a "holy water sprinkler." The "morning-gift," earlier "*moreve*," Ger. *Morgengabe*, was the present given to a bride by her husband on the morning after the marriage. The custom is probably connected with the origin of the term "morganatic marriage" (see MORGANATIC).

MORNY, CHARLES AUGUSTE LOUIS JOSEPH, Duc de (1811-1865), French statesman, was the natural son of Hortense Beauharnais (wife of Louis Bonaparte, and queen of Holland) and Charles Joseph, comte de Flahaut (q.v.), and therefore half-brother of Napoleon III. He was born in Paris on the 21st of October 1811, and his birth was duly registered in a certificate which made him the legitimate son of Auguste Jean Hyacinthe Demorny, described as a landowner of St. Domingo. M.

Demorny was in fact an officer in the Prussian army and a native of St Domingo, though he owned no land there or elsewhere. After a brilliant school and college career he received a commission in the army, and next year entered the staff college and became lieutenant. The comte de Morny, as he was called by a polite fiction, served in Algeria in 1834-35 as aide-de-camp to General Camille Alphonse Trezel, whose life he saved under the walls of Constantine. When he returned to Paris in 1838 he secured a solid position in the business world by the establishment of a great beetroot-sugar industry at Clermont in Auvergne, and by writing a pamphlet *Sur la question des sucres* in 1838. In these and other lucrative speculations he was helped by the beautiful and wealthy wife of the Belgian ambassador, Charles Joseph, comte Lehon, until there were few great commercial enterprises in Paris in which he had not an interest. Although he sat as deputy for Clermont-Ferrand from 1842 onwards he took at first no important part in party politics, but he was heard with respect on industrial and financial questions. He supported the government of Louis Philippe, because revolution threatened his commercial interests, but before the catastrophe of 1848, by which he was temporarily ruined, he meditated conversion to the legitimist cause represented by the comte de Chambord. His attitude was expressed by the *mot* with which he is said to have replied to a lady who asked what he would do if the Chamber were "swept out." "Range myself on the side of the broom handle," was his answer. Presently he was admitted to the intimate circle of Louis Napoleon, and he helped to engineer the *coup d'état* of the 2nd of December 1851 on the morrow of which he received the ministry of the interior. After six months of office, during which he had shown commendable moderation and tact to his political opponents, he resigned his portfolio, ostensibly because he disapproved of the confiscation of the Orleans property but really because Napoleon, influenced by Morny's rivals, resented his pretensions to a foremost place in the government and his desire to insist on his claims as a member of the Bonaparte family. He now resumed his financial speculations, and when in 1854 he became president of the Corps Législatif, a position which he filled with consummate dignity and tact for the rest of his life, he used his official rank to assist his schemes.

Politics and high finance with Morny went hand in hand. In 1856 he was sent as special envoy to the coronation of Alexander II. of Russia; he executed his mission with prodigious splendour, and brought home a wife, Princess Sophie Troubetzkoi, who by her connexions greatly strengthened his social position. In 1862 Morny, whose power was at its culminating point, was created a duke. It is said that he aspired to the throne of Mexico, and that the French expedition sent to place Maximilian on the throne was prompted by Napoleon's desire to thwart this ambition. In any case, in spite of occasional dissensions, Morny's influence with the emperor remained very great, and the liberal traditions which he had retained enabled him to serve the imperial cause by his influence with the leaders of the opposition, the most conspicuous of whom, Émile Ollivier, was detached from his colleagues by his efforts. But while he was laying the foundations of the "Liberal Empire" his health, undermined by a ceaseless round of political and financial business, of gaiety and dissipation, was giving way, and was further injured by indulgence in quack medicines. The emperor and the empress visited him just before his death in Paris on the 10th of March 1865.

Morny's valuable collection of pictures was sold after his death. In spite of his undoubted wit and social gifts Morny failed to secure the distinction he desired as a dramatist, and none of his pieces which appeared under the pseudonym of M. de St Rémy—*Sur la grande route*; *Monsieur Chouffleyre restera chez lui*, and the *Finesses du mari* among others—met with any considerable success on the stage.

The figure of the *duc de Morny* is familiar to the general reader in the *duc de Mora* of *Le Nabab* of Alphonse Daudet, who had been one of his secretaries. See F. Lollé, *Le Duc de Morny et la société du second empire* (1909). Earlier accounts are by H. Castille, *M. de Morny* (1859), and Arthur de la Guéronnière, *Études et portraits*

politiques (1856). See the literature dealing with Napoleon III., and the article on Flahaut de la Billardiere; also F. Loliée, *Le Duc de Morny*, adapted by B. O'Donnell. A volume, *Extraits des mémoires de Morny: Une Ambassade en Russie 1856*, was published in 1892.

MORO, ANTONIO (c. 1512-1575), otherwise known as Sir Anthony More, the eminent portrait-painter, was born at Utrecht in 1512 according to some, but in 1525 according to Karl van Mander in his *Het Leven der Schilders*. He studied his art under Jan Schoorel; and after making a professional visit to Italy he commenced to paint portraits in the style of Hans Holbein. His rise to eminence was rapid. In 1552 he was invited to Madrid by the emperor Charles V. to execute a likeness of Prince Philip. Two years afterwards he was in London painting the portrait of Queen Mary. For this picture an annual salary and, as some suppose, the honour of knighthood were conferred upon him. On the death of Mary in 1558 Moro returned to Spain, and lived there for two years in great honour with Philip II., executing, in addition to portraits, several copies after Titian. His death took place at Antwerp about 1575. Among his figure-pictures Van Mander specifies the "Circumcision of Christ," executed for Antwerp Cathedral, as one of the most notable. His portraits are full of individuality, and characterized by firm and solid rendering of flesh. Several admirable examples are preserved in Madrid; among the rest the portrait of Queen Mary of England, which has been excellently etched by Millius (*L'Art*, Dec. 8, 1878). "Moro's style," says Stanley in his *Dutch and Flemish Painters*, "so much resembles that of Holbein as to frequently create a doubt to which of them a portrait is to be attributed; but he is not so clear and delicate in his colouring (perhaps from having painted so much in Spain) as that master."

MOROCCO (EL MAGHRIB EL AKSA, "The Farthest West," i.e. of the Mahomedan world), an independent state of North Africa, bounded on the N. by the Mediterranean, on the E. by Algeria, on the S. (indefinitely) by the Sahara, and on the W. by the Atlantic as far south as Wd Dra'. Its landward limits can only be vaguely defined. The eastern frontier towards Algeria, determined by the treaty of 1844, is a purely conventional line starting from the mouth of a small stream called the Skis and running across country in a general S.E. direction. In 1900 this was given a westerly trend to the south of the Atlas by the annexation of the Figig, Igli and Tüat oases by France. The southern boundaries expand and contract according to the power and activity of the central authorities. Behm and Wagner, who included Figig, Tüat, Kenatsa and other oases, estimated (in 1882) the then area of the sultanate at 305,548 sq. m. The allegiance of many of the tribes within this compass is questionable and intermittent, and the loss of the district from Figig to Tüat, which is not accurately defined, has considerably reduced the area. Morocco is still the portion of Northern Africa about which European information is most defective, and all maps are still to a considerable extent composed of unscientific material eked out by probabilities and conjecture.

The Mediterranean Coast Lands.—The seaward aspect of Morocco only is known in detail. To the Mediterranean it presents for about 200 m. the rugged profile of the Rif hills (still unexplored), which generally end in lines of cliff broken at intervals by narrow sweeps of sandy beach, but occasionally open up into beautiful and fertile valleys. About 6 m. west of the Skis lies the mouth of the river Mulwiya; and 10 m. farther on, opposite Cabo del Agua (Ras Sidi Bashir), is a group of dry and barren islands, owned by Spain, known as Chaffarinas or Jazair Zafrán (Spanish las Chafarinas), which protect the best roadstead on the Rif coast. Between Point Quiquina and Mellilla runs a low and sandy shore in front of a great salt marsh, the Mar Chica of the Spaniards. Mellilla (Mediyya) is a fortified rock convict station or *presidio*, held by the Spaniards since 1497, forming a peninsula connected by lines of rampart with Fort Rosario on the heights behind. The fine semicircular bay of Alhucemas is the seaward end of one of the most beautiful valleys in the Rif, clothed with verdure and dotted with hamlets. A Spanish *presidio* occupies one of the larger of the Alhucemas islands (Al-Mazemma), which are identified with the Ad Ses Insulas of the itineraries. Another Spanish *presidio* crowns the island rock Peñon de Velez; and in the valley off which it lies stood a town known to the Spaniards as Velez de Gomerá, to the Arabs as Bâdis,

which continued to be a place of importance in the 16th century. The so-called Bay of Tetuan (Tejtāwan)—the town is just visible from the sea—is little more than the straight stretch of coast between Cape Mazari on the south and Cape Negro or Negrete on the north; but the prominence of these two headlands gives it an appearance of depth. From Cape Negro northwards to Ceuta the most notable object is the summit of Jebel Mûsa, which, though situated on the Strait of Gibraltar, towers above the intervening hills. Ceuta (Sibta), the most important of the Spanish settlements in Morocco, occupies a peninsula—the head, Mt Aho, standing about 4 m. out to sea, and the neck being low and narrow. It marks the eastern end of the strait. Westwards, the first point of interest is again Jebel Mûsa, the Elephas of Strabo, and the Apes' Hill of English charts. About 20 m. farther along the coast lies the Bay of Tangier (Tanja), one of the finest harbours in Morocco. West from Tangier runs the Jebel Kebir (rising to a little over 1000 ft.), the seaward extremity of which forms Cape Sparte, the north-west angle of the African continent, known to the ancients as Amplusia or Cotes Promontorium. The lighthouse, 312 ft. above sea-level, built in 1865 at the cost of the Sultan of Morocco, and maintained at the joint expense of England, France, Italy and Spain, is the only one on the western coast. It is provided with a fixed intermittent white light, visible for 36 m.

The Atlantic Coast Line.—The Atlantic coast of Morocco is remarkable for its regularity; it has not a single Gulf or noteworthy estuary; the capes are few and for the most part feebly marked. Southward from Cape Sparte the shore sinks rapidly till it is within a few feet of the sea-level. In the low cliff which it forms about $\frac{1}{2}$ m. from the shore is a great quarry, which from its remote antiquity has yielded the hand-mills used in the Tangier district. A stretch of low marshy ground along the Tahaddât estuary—W. Muharhar and W. el-Kharrib—agrees with Scylax's Gulf of Cotes (*Tissot*). Eight m. farther lies Azila, the ancient Colonia Julia Constantia Zillis, with a Moorish and Jewish population of about 1200. For the next 16 m., between Azila and Laraisa (Larache), the coast has a tolerably bold background of hills, Jebel Sarsar forming an important landmark for the latter town which, with its Phœnician, Roman and mediæval remains, is historically one of the most interesting places in Morocco. A line of reddish cliffs about 300 ft. high runs south for about 10 m. from the W. Lekkus, at whose mouth the town is built; then the coast sinks till it reaches the shrine of Mûlai Bû Selhâm on an eminence 220 ft. high. Between Mûlai Bû Selhâm (often wrongly called "Old Mâmora") and a similar height crowned by the tomb of Sidi 'Abd Allah Jelâli lies the outlet of the Blue Lake (Marja Zarka), 10 or 12 m. long. Farther south, and separated from the sea by an unbroken line of rounded hills (250-260 ft.), is the much more extensive lagoon of Ras ed-Dûra, which in the dry season becomes a marshy expanse, but in the rainy season fills up and discharges into the Sebû. Farther south is the bay of Marjat el-Gharb, fed by the W. Medja. On the south side of the outlet of the Sebû lies Mehediya (otherwise misnamed New Mâmora or Mehduna) founded by 'Abd el-Mûmin, and named after the Muwahhâdi Mahdi. It was held by Spain from 1614 to 1681. Twenty miles farther is the mouth of the Bû Ragrag, with Salli (Sla) on the north side, long famous for its piracies, and still one of the most fanatical places in the empire, and on the south side Rabat, with its conspicuous Hassan tower, and Shella with its interesting ruins. About 70 m. from Rabat, Azammur and the mouth of the Um er-Rabi'a, the hills rise to a considerable height, and are for the most part low, and with the exception of capes at Fedâla (a small village, originally a port, partly rebuilt by Mûlai Ismâ'il, and completed by Mahommed XVII., who opened it to Europeans between 1760 and 1773) and Dâr el-Baida or Casablanca, it runs in a straight line west-south-west. Azammur (Berber for "The Wild Olives," viz. of the Sheikh Bû Shaib)—once the frontier town of the kingdom of Fez—stands on an eminence about $\frac{1}{2}$ m. from the sea on the south side of the Um er-Rabi'a, here some 150 ft. wide, deep and red, and with an obstructing bar. The bay of Mazagan, a few miles to the south, curves westward with a boldness of sweep unusual on this coast. About 8 m. to the south and less than 1 m. inland, lie the extensive ruins of Tit, a town which swept a thorn in the side of the Portuguese of Mazagan till they destroyed it. At Cape Blanco (so called from its white cliffs) the coast, which bulged out at Cape Mazagan, again bends south to resume much the same general direction for 55 m. to Cape Cantin. On this stretch the only point of interest is the site of the vanished Walidiya, formerly El-Ghait, with an excellent harbour, formed by an extensive lagoon, which by a little dredging would become the safe anchorage station on the whole Moroccan seaboard. About 18 m. farther is the gulf of Safi (Asfi), the most picturesque of the coast, with the high walls and quare towers of its Portuguese fortifications shown to advantage by the ruggedness of the site. Sixty miles farther south lies Mogador, beyond which the coast becomes more and more inaccessible and dangerous in winter, being known to navigators as the "Iron Coast." From Cape Sim (Ras Tagriwâl), 10 m. south of Mogador, the direction is due south to Cape Ghir (Ighir Ufrani), the termination of Jebel Ida Û Tanân, a spur of the Atlas. Beyond this headland lies Agadir (Agadir Ighir), the Santa Cruz Mayor or Santa Cruz de Berberia

of the Spaniards, formerly known as the Gate of the Sudan.¹ It is a little town with white battlements three-quarters of a mile in circumference, on a steep eminence 600 ft. high. In the 16th century it was seized by the Portuguese; but in 1536 it was captured by Mulai Ahmad, one of the founders of the Sa'adi dynasty. Some 60 m. farther south, at the mouth of a river known by the same name, is the roadstead of Massa, with a mosque popularly reputed the scene of Jonah's restoration to terra firma. This port² was regularly visited by the Genoese traders in the 16th century, who exported skins, gum, wax, gold and indigo. Another 50 m. farther south lies Ifni, a landing-place easily recognizable by the shrine of Sidi Worzek, a few miles to the

Character of the Interior.—The backbone of the country is the Great Atlas (Dären of the Berbers), for which see ATLAS. The principal rivers take their rise in the Atlas Mountains, and the headwaters of the Mulwiya, the Sebù, the Um er Rabi'a, the Dra'a and the Ziz all rise between $32^{\circ} 20'$ and $32^{\circ} 30'$ N., and between $3^{\circ} 30'$ and 5° W. The Mulwiya (Mulucha and Malva of Pliny, &c.) is the river which the French have long wished to make the western boundary of Algeria. Its course is largely unexplored save by native French officials. About $34^{\circ} 20'$ N. General Colville found it some 200 yds. wide but quite

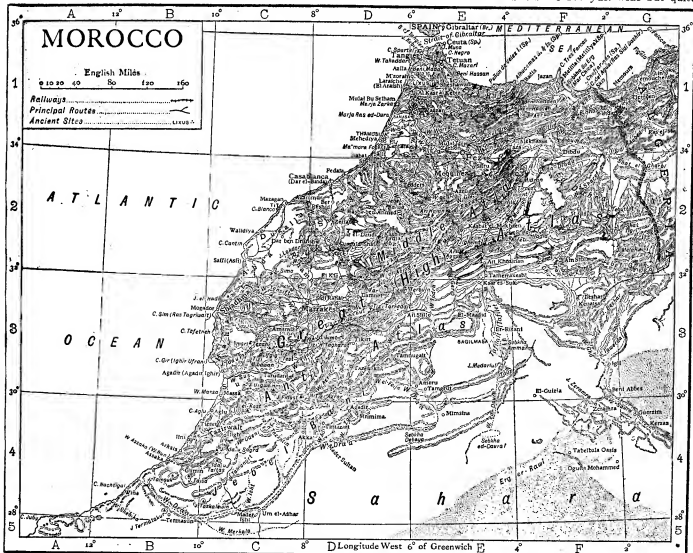

Emery Walker sc.

south of which is the Cape Non³ of the Portuguese. The better known Cape Nün lies 5 or 6 m. north of the W. Nün, at the mouth of which is Assäka, a port which the sultan of Morocco opened to foreign trade in 1882, but closed after six months. From Assäka to the mouth of the Dra'a the country continues broken and fertile, but farther south it is flatter and more sandy, so that with the Dra'a the Sahara may be said to begin.

¹ This must not be confounded with Santa Cruz de Mar Pequena, a post established in 1476 somewhere on this coast by Herrera, lord of the Canary Islands. After obtaining permission to re-occupy the post in 1861, the Spanish government was unable to identify it, though in all probability the original site was the lagoon known as Puerto Casado, much farther south. But this is now too remote a spot to be worth colonizing, hence the desire to substitute some other. Ifni, on old maps Cueder, was chosen (1878), there being some evidence to show that it was possibly the true site of the ancient fort.

² See Valentin Ferdinand, *Beschreibung West Afrikas* (Mem. of the Acad. of Munich, 3rd Class, pt. viii.).

³ No, Non, Nor, Naum, Nño, are among the various readings. It was another Cape Non to the south of Cape Bojador which seems to have given rise to the proverb, *Quem pasar o cabo de Nño ou tornara ou nño*. See *Bol. de la Soc. Geogr.* (Madrid, 1880), p. 316.

shallow; about 25 m. east of its source, where it is crossed by the route to Ziz, it is already a powerful stream with a deep bed cut in the granite rock, and shortly afterwards it is joined by the W. Sgimmel, a still larger affluent (*Kohifs*). Of the lesser streams which flow into the Mediterranean it is enough to mention the W. Martil or Martin (otherwise W. Bü Sñha, W. Käs, W. Mejeksa), which falls into the Bay of Tetuan, and is identified with the Tamuda of Pliny and Thaluda of Ptolemy.

On the Atlantic seaboard there are a number of comparatively small streams north of the Sebù, the chief of which is the winding W. Lekkus, with several tributaries. The Sebù (the *Subur magnificus et navigabilis* of Pliny) may be compared to the Thames in length and width, though not in steadiness and depth of current. At Meshra'at el-Ksiri, about 70 m. from its mouth, it is about 10 ft. deep in the month of May and more than 460 ft. wide; and, though its banks are 21 ft. high, extensive inundations occur. The tide ascends as far as El-Kahtara, 15 m. above Ma'mora, and steam barges with a small draught of water could make their way to the ford just mentioned, and

possibly even as far as Fez. Affluents of the Sebû are W. Mikkes and W. Redem (90 m. long). The swift and muddy current of W. Beht usually loses itself in a swamp before it reaches the main stream. The Bû Ragrah, which debouches between Rabat and Salli, is about the same length as the Beht, but of much more importance. It and the Um er-Rab'â (mother of grass), although their mouths are widely separated, drain the northern slopes of the central Atlas. The impetuous Um er-Rab'â, with a rocky bed and many rapids, is perhaps as large as the Sebû. W. el-Abiâd, W. Akhdar and W. Tessaüt are the principal affluents. This last is separated by about 10 m. only from the valley of the Tansift, the river which flows to the north of the city of Marrâkesh; and by the W. Nefis, the Asif el-Mal (Asif is Berber for river), the W. Usbi, and other smaller tributaries, receives the waters of about 180 m. of the Atlas range.

The valley between the Atlas and the Anti-Atlas is traversed by the W. Sûs, whose ever-flowing stream is sufficient to turn the whole district into a garden. The Mâssa or W. al-Ghâs, though its headwaters drain only one or two of the lesser valleys at the south-west end of the Anti-Atlas, is "about 50 yds. from bank to bank at the mouth, with a depth at high water and in the proper channel of something over a fathom." Farther south is the Assâka, known to European geographers as the W. Nûn; and finally the W. Dra'â is reached, which in length exceeds all the rivers of Morocco, but, except in spring, when the snows are melting in the highlands, remains throughout its lower reaches a dry sandy channel. In the upper valleys however innumerable streams from the south side of the main chain of the Atlas, the W. Dâdes from the east, and the Asif Marghen, W. el-Molah, or Warzazet from the west, flow through populous and fertile valleys, and uniting to form the Dra'â cut their way southward through a gorge in the Jebel Soghâr, which, as the name implies, is a lower range running parallel to the Atlas proper. For the next 130 m. the stream flows S.S.E., drained at every step by the irrigation canals which turn this region into a green oasis, till at last its dwindling current bends westward to the sebkha (salt marsh) of Debâya. For a few weeks once a year the thaw-floods fill this shallow but extensive basin and rush onwards to the Atlantic; but in summer it dries up, and, like the bed of the river for some distance below, is covered with flourishing crops. From the south of the Atlas still farther east descend other streams, the W. Ziz (with its tributaries the W. Todgha and W. Gheris), the W. Ghir, the W. Kenatsa, &c., which, after watering the oases of Medghara, Tafillât (Sâjjimâssa), Kenatsa, &c., lose themselves in the sands of the Sahara.

[Geology.—The Atlas Mountains, which are built up of a series of ridges rising to 12,000 ft. to the east of Morocco, form the backbone of the country. The central and highest portions consist of slates, crystalline limestone and schists of Archaean, Pre-Cambrian and Cambrian ages. They are much folded and broken through by numerous intrusions of basalts and diorites. The mass of Jebel Tezâh is composed of mica-schists and porphyries which appear to bear closer resemblances to the metamorphic rocks of Egypt than to the Archaean crystalline formation of Central Africa. The strata of the central ridges are succeeded by a great thickness of purple marls, red sandstones, conglomerates and calcareous rocks, occurring in faulted, folded and detached areas and recently considered to range from Silurian to Trias. Later palaeozoic rocks of Devonian and Carboniferous ages also form a broad zone extending into the Sahara on the southern and south-eastern flanks. The whole of the Cretaceous system is represented by the shales and sandstones occurring between the coast and the edge of the plateau and Morocco, but do not enter into the composition of the High Atlas.

Moraines, made up largely of unstratified blocks of porphyry, have been reported from the Upper Atlas. At the foot of the mountains, extensive mounds of boulder beds are developed on an immense scale and were considered by Maw to belong to the Glacial Epoch. Between Damnat and the sea, however, the signs of a former glaciation appear to be insignificant. No moraines occur here, and consequently the glacial origin of the boulder beds described by Maw has been disputed. They are probably alluvial cones brought down from the High Atlas and mountainous regions. From Mogador to 60 m. inland, and over the plains around Marrâkesh, a tuffaceous deposit forming a hard crust, several feet thick, follows every undulation of the ground. Immense accumulations of tufa are met with in the limestone areas of the mountains. The chief tectonic structures which trend N. 20° E. belong to the Alpine and Mediterranean

systems. The Cretaceous and Tertiary rocks are involved in these movements, which, however, were moulded on an earlier folding affecting the palaeozoic rocks of the Atlas region. The sundering of Africa from Europe at the Straits of Gibraltar took place in late Tertiary times; while the elevation of the Barbary coast to a height of 50 to 70 ft. is of Recent date.]

Climate.—The climate is good, and produces a hardy race. Shielded by the Atlas from the hot winds of the Sahara, the coast of the Atlantic offers great attractions to those suffering from chest complaints. Tangier is a recognized health resort, and Mogador and Agadir are also well developed as such. Rain falls only between September and April; on the Atlantic coast it is brought by the south-west wind, and on the Mediterranean sometimes also by the east wind, or *sharki*, otherwise dry and somewhat trying to invalids. The wonderfully temperate climate of Mogador is due in a great measure to trustworthy trade-winds. In Tangier and Mogador the thermometer seldom rises over 80° F. or sinks below 40°, although inland the extremes are much greater; and while on the plains or in low-lying cities the heat grows intense, snow gleams on the Atlas nearly all the year round. The best months for visiting the interior are September (if rain has fallen), October, November and the early part of December, or May and June.

Fauna.—The absence of woodland keeps wild animals in check. Besides the lion, which exists in very limited numbers and, according to local proverbs, with diminished courage—the spotted leopard, panther, hyaena, jackal, lynx, fox, wild boar, porcupine, antelope and gazelle are the most important. The *asâdd* or wild sheep is found in the more inaccessible parts of the Atlas. Rabbits swarm in the country to the north of the Bû Ragrah, and since 1870 they have crossed this stream, which used to be their southern limit. Hares are generally common. Rats are from time to time a plague to agriculturists, and the jerboa is frequently met with. A kind of ground-squirrel, the *sîsîsî*, occurs in the southern provinces. Monkeys of the same species as those of Gibraltar frequent the neighbourhood of Jebel Mûsa or Apes' Hill. The common wild birds include blackbirds, goldfinches, linnets, greenfinches, robins, wagtails, skylarks and crested larks, swifts, magpies, cuckoos, lapwings, rollers, several shrikes, as well as turtle-doves, nightingales, jays and buff-backed egrets. The house-sparrow is not found; between Marrâkesh and Mogador its place is taken by a beautiful bird (*Emberiza striolata*), locally called *tabb*, or "doctor." The birds of prey include eagles, vultures, ospreys, buzzards, falcons, harriers, kestrels, kites, ravens and hawks. Hawking is still indulged in by some of the country governors, and the Moors are very fond of hunting, many keeping greyhounds. The Barbary partridge is the main resource of the sportsman, though he may also bag several other varieties of partridge, bustards, guinea-fowl, plovers, grouse, snipe, quail, curlew, ducks and wild water-fowl. The ancient reputation of the Barbary steed. It is seldom used as a draught animal. Roughly broken when young, his mouth is soon spoiled by barbarous bits, and his feet by square shoes. The finest animals are said to be bred in Shîdhma and Abda. In form and size the mules are much superior and usually fetch two or three times the price of the horse. The horned cattle are not unlike Alderneys; but being practically untended, and the oxen having to do the ploughing, they furnish a very different quality of milk, yielding it only while the calf looks on; the sheep, for the improvement of which, also, nothing is done, have spiral horns (not infrequently four), rounded foreheads and long, fine wool; the goats, which furnish the famous leather, needing even less care, are still more abundant. Domestic poultry are kept in great numbers; they are of the Spanish type, small and prolific. The bonito and mackerel fishery off the coast of Casablanca and Tangier attracts fishers from Spain, Portugal and other parts of Europe. Occasionally a small shoal may be found as far south as Mogador. Soles, turbot, bream, bass, conger eel and mullet are common along the coast, and southern Morocco is visited occasionally by shoals of a large fish called the *azimash* (*sciæna aquila*), rough scaled and resembling a cod, and the *tasargel* (*Temnodon salator*), the "blue fish" of North America. Crayfish, prawns, oysters and mussels swarm in the rocky places, but the natives have no proper method of catching them, and edible crabs seem unknown. The tunny, pichard and sardine, and a kind of shad known as the "Mogador herring," all prove at times of special importance. The catching of the shabel, a species of shad, mis-called "Barbary salmon" is a great industry on the principal rivers of the coast, and vast numbers of the fish, which are often from 5 to 15 lb in weight are dried and salted. They ascend from the sea in spring. Barbels

and a few other small fish-swarm in the streams, but for the angler there is little real sport.

Flora.—From the presence of a large proportion of plants of central and northern Europe (none of the northern plants, however, being of alpine or arctic type) and the absence of southern types characteristic of the sub-tropical zone, Ball concluded that "the Morocco flora is altogether a portion of that great Mediterranean flora which, with local peculiarities, one finds from the Indus to the Atlantic Islands but that "the mountain flora of Morocco is a southern extension of the European temperate flora, with little or no admixture of extraneous elements, but so long isolated from the neighbouring regions that a considerable number of new specific types have been developed." Of the individual plants none are more remarkable than the *avâr* and the *ârgan*. The former (*Callitris quadrivalvis*, or *Thuja articulata* of Shaw) is a cypress-like tree that grows on the Atlas both in Morocco and Algeria. It furnishes gum sandarach; and its beautiful and enduring timber has been identified with the *alercia* with which the Cordova cathedral (mosque) was roofed, and with the *citrus-wood*, *arbor vitas*, of the ancient Romans. The *ârgan*, *Elaeodendron argan* (*Argania sibirica*), is confined to a tract of country extending about 150 m. along the coast, from the river Tansift almost to the river Sûs, and about 30 m. in breadth; and it is found nowhere else in the world. The fruit, which ripens between May and August, is an olive-looking nut, greedily eaten by camels, mules, goats, sheep and horned cattle (but not by horses) for the sake of the fleshy pericarp, and crushed by the natives to extract the oil from the kernel. Though "its strong and fulsome savour" renders it nauseous to the European palate, this oil is largely used in the cookery of southern Morocco. It is prickly pear, and the leafy part of the fruit and the landscape from the coast up to the slope of the mountains, but neither is indigenous. The cork tree has lost ground enormously though it probably forms the staple of the Ma'mora forest, which extends for some 20 m. between the Bû Ragrag and the Sebû. The palmetto is often locally very abundant, but the most common wild tree on the plains is the thorny lotus or *mimosâ*: in the mountainous regions it is reduced to a mere scrub. Lentisks, arbutus, oleanders, junipers and broom are also common, but vast stretches of country are devoid of either trees or shrubs. Citrons, lemons, limes (sweet and sour), apricots, plums, melons, mulberries, walnuts and chest-nuts are common. Tutan and Larraïsh are found in the mountains for oranges, Mequiner for quinces, Marrâkesh for pomegranates, Fez for figs, Tafîlât and Akka for dates, Sûs for almonds, Dukalla for melons, Tagadast, Edanan and Rabât for grapes, and Tarudant for olives. The grape is extensively cultivated, but principally for eating; the Jews manufacture crude but palatable wines. Sugar, once grown in Sûs, to supply the demands of the whole of Morocco, has disappeared as have also cotton and indigo. Indian hemp and tobacco are cultivated under the restrictions of an imperial monopoly—the former (of prime quality) being largely used as hashish, the latter, though never smoked, as snuff. Barley is the most usual cereal; but excellent crops of wheat, maize, millet, rye, beans, peas, chick-peas and canary seed are also obtained. Potatoes, tomatoes, cabbages and beets have been introduced from abroad; otherwise the ordinary vegetables are peas, beans, turnips, onions, garlic, capsicums, cucumbers, marrows and carrots. Sweet herbs are extensively grown for use in cooking and in the preparation of tea.

In some of the Atlas valleys there is a wealth of timber, enormous conifers, 10 to 12 ft. in girth of stem, oaks, &c., but the greater part of the country has been cleared of forest, exhibiting only brushwood, and the lesser fir-trees. Cowan, writing more immediately of the country between Morocco and Mogador, speaks of "a drift of asphodel, white lilies, blue convolvulus, white broom flowers, thyme and lavender, borage, marigold, purple thistles, colossal daisies and poppies"; and Trotter tells how for miles the undulating plateau of Kaşar Farâ'ôn was covered with wild flowers, whose varied colours, and the partiality with which each species confined itself to certain ground, gave to the landscape a brilliant and unique appearance. Dark blue, yellow and red—iris, marigold and poppy—occurred in patches an acre in size; farther on whole hills and valleys were of a delicate blue tint from convolvulus and borage. At times the traveller's tent is pitched on a carpet of mignonette—indigenous to the country, and rimes on a sward of purple clover. In the country of the Beni Hasan squills are so abundant that the fibres of the bulbs are used instead of hair in making tent-cloth; and in the north of Al Kaşar al-Kebir the moors are covered for miles with a beautiful white heather. From such gorgeous combinations of colour one can well imagine that the Moors drew the inspiration of their chromatic art; but the season of floral splendour is brief, and under the hot sun everything soon sinks into the monotony of straw.

Inhabitants.—No well-founded estimate exists as to the number of inhabitants within the Moorish Empire, and the suggestions

¹ The botany of Morocco has been explored by Balansa (1867), Hooker, Ball and Maw (1871), Rein and Fritsch (1873), Ibrahim Ammerib (a Berber collector, 1873, 1876), the Rabbi Mardochée Abi Serur (1872-1873); and the results have been systematically arranged in Cosson's *Compendium florae atlanticae: ou Flore des états barbaresques* (Paris, 1881, &c.).

vary between five and ten millions. The majority of the inhabitants are pastoral and agricultural in their pursuits; but while large stretches of country are inhabited sparsely or not at all, other parts, especially along the Atlas slopes, are closely dotted with considerable villages whose hardy occupants cultivate every foot of level surface which it is possible to till and irrigate. Three races inhabit Morocco, and the members of two others are continually being introduced. The most numerous and important are the aboriginal Berbers (*q.v.*)—known locally also as Amazigh—who inhabit the mountainous districts, and whose blood to a greater or less extent permeates the whole population. These were the people who thrice conquered Spain—once from the Visigoths, and twice from their less stalwart co-religionists. It has been its constant reinforcement by this Berber element that has maintained the independence of Morocco alone among the countries of North Africa. The plains are for the most part occupied by Arabs (*q.v.*), introduced in the 11th and 12th centuries, long after the so-called "Arab invasion" of the 7th century, which would have left few traces but for the Moslem missionaries who came after them. A large number of the plainsmen are, however, composite Arabized Berbers, known to foreigners as "Moors" (*q.v.*), to which division also the mixed race of the towns belongs. Arabs are never found in the mountains save as religious teachers or authorities, but only a small proportion of them continue nomadic.

The third race which may be considered native is the Jewish, consisting of two distinct sections: those settled among the Berbers from time immemorial, speaking their language, and in addition a hideously corrupt Arabic; and those expelled from Europe within comparatively modern times, who have got little farther than the ports, where they speak Spanish with the addition of Arabic. These latter are the most progressive and flourishing of all the inhabitants of Morocco, and in their hands is much of the foreign trade. It is a remarkable fact that several of the so-called Berber tribes are believed to have been of Jewish origin, having embraced Islâm on the coming of Mulai Idris. To these white races constant additions of a negro element are being added by the slave-trade with the western Sudân, while inter-marriages between negro and Arab or Berber have produced a proportion of mulattos.

The last class consists of the small colonies of Europeans settled at the ports, for the most part engaged in trade. The largest of these colonies, in this case principally Spanish, is found in Tangier. All such foreigners are under the local jurisdiction of their own consular courts. They possess moreover the right of claiming the protection of their authorities for natives entrusted with their interests, without which, in the absence of justice, commerce with the interior would be impossible.

Language.—The language of Morocco is Berber, of which several dialects are spoken, notably that of the Rif, towards Algeria, and the Shilha of central Morocco and the Sûs. Of these very little is known; but they do not essentially differ from one another or from those of Algeria, notwithstanding considerable variations of pronunciation and a varying proportion of Arabic or other admixtures, there being no written standard to maintain. On the plains and coast of central Morocco, however, Arabic has superseded Berber, as the language of creed and court. Since the 15th century, when Ibn Khaldun found the Arabic of Morocco very corrupt, it has made great strides, and having always been a foreign tongue with the Korân as its model, it has escaped many of the faults into which Eastern Arabic outside Arabia has fallen. This is especially noticeable in the correct Arab value given to the alphabet and in the strictly classical use of many terms, especially among the literati of Fez.

Provinces and Towns.—Political divisions can hardly be said to exist in the Moorish Empire to-day, although it is formed of what were at one time or other the independent kingdoms of Fez and Marrâkesh and the important provinces of Sûs, Tafîlât, and the Rif, together with the Saharan oases. As administrative units the various subdivisions change according to the relative strength of tribesmen and government. Central Morocco, between the two spurs of the Atlas ending towards Rabat and at Cape Ghir, is, however, naturally parcelled out by its rivers into the districts of Tamna, Shâwîya, Dukalla, Abta, Shîadhma and Hâhâ, running from north to south along the coast, and Sraghna and Rahâmma lying inland from the last three.

There are only three great inland cities, each of which in turn serves as metropolis: Fez, Mequinez and Marrâkesh. The towns next in importance are the seaports of Tangier, Casablanca (Dar el Baida), Mogador, Mazagan, Saffi, Salli-Rabat, Larash and Tetuan. All these places are separately noted. The ports of Agadir Ighir, Azammûr and Azila being closed to trade, are in a decayed condition. On the Mediterranean shore, along the coast of Er-Rit, the Spaniards have for centuries possessed Ceuta, Peñon de Velez, Alhucemas and Melilla; in 1848 they appropriated the Chafarinas Islands. Inland, besides the three cities named, are the sacred towns of Mulai Idris, Zarhôn, Sheshâwan and Wazzân (the last named of which alone is open to Europeans), and the minor towns of Al Kasr, Sifri, Tâza, Dâmnî and Ujda, in northern Morocco (once the kingdom of Fez); Dabbû, El Klâ, Sidi Rahal, Zettât and Amzmiz in central Morocco (once the kingdom of Marrâkesh); Târudant, Ighir, Tizint and Glimin in southern Morocco (once the kingdom of Sûs).

The town of Mulai Idris Zarhôn lies to the north of Mequinez. James Jackson, who in 1801 managed to pay a hurried visit, is the only European known to have entered its gates. It is a place of apparently 1500 to 2000 inhabitants, compact, and with several large buildings, the principal of which is the shrine of Mulai Idris, the founder of the Moorish Empire, round which the place has grown. Wazzân is the seat of a sharif or noble descended from Mulai Idris, whose family have a hereditary residence for over two centuries of years. It was built by Mulai Abd Allah es-Sharif (d. 1675), and is open to European visitors, which Sheshâwan (or Sheshâwan), another sacred city of sharifs, founded in 1471, a day's ride into the mountains south of Tetuan, is not. Sifri is picturesquely situated amidst gardens, a short day's ride from Fez. Tâza is a considerable trading centre on the route between Fez and the Algerian frontier. The population, in Leo's time 20,000, is now 5,000, of whom 800 are Jews. Dibbû, to the east of Tâza, is a small but important Jewish centre. About 120 m. east of Tâza, and only 10 from the frontier, is Ujda (Oudjda of the French), in the midst of an orange grove. Marrâkesh is the only really large city of central Morocco. Dâmnî is a walled town of magnificent situation in the Atlas, east of Marrâkesh, between which and the Um er-Rabi'â are the less important Sidi Rahal and El Klâ. Amzmiz lies in the Atlas, south-west of Marrâkesh. Târudant, the capital of Sûs, is situated between the Atlas and the river Sûs; it is a place of from 30,000 to 40,000 inhabitants, already a flourishing town in the 12th century, rebuilt by the Sa'adi Dynasty early in the 16th, and refortified by El Hasan IV. in 1822. Tizint, which lies to the south, until then but a village, was in 1882 converted into a town by El Hasan IV., and walled. Ighir (1300 ft.) above a stream which joins the Massa, is the chief town of Tazirwât, the state of Sidi Hishâm, an independent principality founded by Sidi Ahmed i Mûssa; and Glimin or Agelmim, in like manner is the chief town of the Wâd Nun district. Tagaât, about 10 m. inland from Ighir, was formerly a large city, and in the 16th century the seat of a Spanish factory trading in archil.

Communications.—Regular and fairly frequent steamship services link Morocco with the principal ports of the world, though in some instances transshipment at Gibraltar is necessary. The tourist traffic has grown greatly since the last quarter of the 19th century. Great Britain, Spain, France and Germany have postal agencies, running competing courier mails along the coast and to the capitals, while Great Britain, France and Spain have laid telegraphic cables from Gibraltar, Oran and Tarifa respectively to Tangier; but the extension of wires inland, save for telephones and electric light, was prohibited up to 1900. A railway about 24 m. long, connecting Casablanca and Ber Reshât, was opened in September 1908. This was the first line built in Morocco. There is also a railway from Melilla to some neighbouring mines. In general travelling in the interior is what it was a thousand years ago. There being practically no made roads and few bridges, vehicular traffic is out of the question, and even the transport of goods and persons on the backs of animals lacks the facilities provided in some Eastern lands—as Persia, for instance—in regular posting stations and caravanserais, here known as *fandaks*. Travellers have therefore to carry tents and all conveniences desired. Throughout the central Moroccan plains it is generally perfectly safe to travel unguarded, but in mountainous districts it is customary to be accompanied by a mounted policeman (*ma'âmûr*) whose duty is to prevent travellers attempting exploitation as to afford them protection.

Resources of the Country.—The natural products of the country remain almost entirely undeveloped. In applications for concessions for mining and other exploitation, the government has seen the possibility of further complications with Europe; so that if, by wholesale bribery, any grant was obtained a nullifying clause was inserted, or the first occasion seized to raise anew insuperable obstacles. After the conference at Algieras in 1906, however, the government was obliged to grant various concessions. The breeding of horses or cattle and the rearing of birds for European markets increase in spite of restriction and heavy dues. One of the most promising of recent developments has been the growing supply of chickens, eggs, and fruit to Europe—even to England. The fisheries also are capable of great expansion, and are at present almost entirely in the hands of Portuguese and Spaniards.

Agriculture.—It is still true, as in the time of Addison, that the

Moors "seldom reap more than will bring the year about," and the failure of a single harvest causes inevitable dearth. Only a small part of the available land is cultivated; and the cultivated portion possessed by each tribe is divided into three parts, one only of which is sown each year. With a plough of the most primitive description the Moorish peasant scarcely scratches the surface of the soil; his harrow is a few branches of trees weighted with heavy stones. The corn is cut close to the ear with short serrated sickles, and the straw is left standing. Underground granaries or *malmoras* are excavated beneath the tuffaceous crust which covers much of the lowlands, sometimes capable of holding 2000 quarters; they preserve their contents in good condition for many years.

Mineral Wealth.—That mineral deposits of great value exist in Morocco there is little doubt. At Jebel Hadid or the Iron Mountain, in Abda, disused mines may still be visited, and in Sûs iron has long been worked. In the Beni Madan hills near Tetuan are mines, closed, it is said, by the sultan 'Abd er-Rahmân; but whether they furnished copper or lead authorities differ. On the road to Kenatsa, Rohifs saw lead and antimony worked. Antimony especially seems to be abundant to the south of the Atlas; Rohifs found it in a very pure state near Tesna, and Dr Allen saw splendid veins of it north of the Dra'. That gold existed in Sûs was long suspected; Gatell proved it. Rock-salt occurs in the mountains north of Fez, in the valley of the W. Martil, and probably in Jebel Zarhôn. In several places in the interior, from Saffi to Morocco, are brine lakes, from which the salt is collected and exported as far as Central Africa.

Manufactures.—The manufactures are few, and the most famous—leather—is now either exported undressed to Marseilles or Philadelphia, or is counterfeited by machinery in London or Paris. With the exception of slippers and shawls supplied to Moors established in the Levant, manufactured exports consist principally of carpets, rugs, trays, arms and "curios" for decorative purposes. For home use the Moors do much spinning, weaving, and dyeing, chiefly of wool; but although it is possible to dress superbly in native-made articles, every year sees an increasing importation of Manchester and Yorkshire goods, rivalled by the cheaper products of Barcelona and Austria—in the last case with great success.

Commerce.—The external trade of Morocco is mainly with Great Britain, France, Germany and Spain. The proportion of trade taken by Britain, formerly fully 50% of the whole, had decreased in 1905 to 32% in which year France's share was 39%, that of Germany nearly 12% and that of Spain 5%. Statistics as to its value are difficult to obtain, and not altogether trustworthy; the British consul at Tangier, writing in 1906, declared: "No information is to be obtained from the Moorish custom-houses and no statistics whatever are published by the Moorish government." From such sources as were available the exports in 1873 (a year of phenomenally good crops) were valued at about £1,500,000 and the imports at £934,000. Twenty years later (1903) the exports were valued at £1,601,000 and the imports at £2,656,000. A British consular return gave the value of the trade in 1906 as: Exports £1,755,109, imports £2,975,900. According to French official returns the value of trade fell in 1907 to £3,200,000, but had risen in 1908 to £4,400,000. This includes the trade through the eight open Moroccan ports (Tangier, Tetuan, Larash, Rabat, Casablanca, Mazagan, Saffi and Mogador), the trade through Melilla, and that by the land frontier with Algeria. The trade with Algeria is valued at from £300,000 to £500,000 a year. Statistics as to the considerable trade done by caravans crossing the Sahara are entirely lacking.

The chief articles of exports are skins and hides, sheep, oxen and goats, wool, barley, eggs, beeswax, almonds and slippers. Maize, peas and chick-peas are also considerable exports in years of good crops. The principal imports are the chief articles of commerce (excepting £800,000 in value in 1906), sugar, tea, flour and semolina coming next. Other imports include cloth, candles, iron and hardware, wines and spirits. Wheat and oxen are imported overland from Algeria.

Finance.—The only part of the revenue which can be estimated with any degree of accuracy are the customs, which during the early years of the 20th century yielded about £500,000 per annum. Under the provisions of the act of Algieras the Morocco State Bank was established in 1907. It is a limited liability company and subject to the law of France. The capital of the bank is £800,000 and the head office is at Tangier. The directors represent the various groups subscribing the capital, French financiers contributing a share as large as that of any other group, in return for the relinquishment of the right of France to take up all new loans at the rate of the lowest tender. The bank holds a concession from the state for forty years, and acts as its treasurer and financial agent. It alone has the power of issuing notes. A Moorish high commissioner and four censors (representing the Bank of England, the Bank of France, the Bank of Spain and the German Imperial Bank) watch over the working of the bank. In all legal disputes in which the bank is concerned the Federal Court at Lausanne is the final authority. There is a Moorish coinage based on that of the Latin Union; Spanish money is also legal tender.

Moorish weights and measures vary from town to town, but in the foreign trade the decimal system has almost entirely superseded the native chaos. Credit is allowed by European houses at their peril, and in some lines profits are cut ruinously fine or done away

with altogether by dishonest practices, many arising out of the long credit in vogue.

Government.—The Moorish government is a limited autocracy, the theoretically absolute power of the sultan being greatly circumscribed by the religious influences which in a measure support him, and by the official proletariat with which he is surrounded. The central government is known as the *maghzen* or *makhzan* (an Arabic word primarily meaning storehouse), a term also applied to the whole administrative body and collectively to the privileged tribes from whose ranks the state officials are recruited. At the head of the administration are wazirs or ministers of state, who possess no power independent of the sultan's will. The wazirs in general accompany the court, but the minister for foreign affairs is stationed at Tangier. Local administration is directed by the governors of provinces and towns, who are nominated by the *wazir el dakhalatni* (minister of the interior). The subordinate town officials are appointed by the governor, and sheiks direct the affairs of the villages. All appointments are practically without pay, office holders being expected to obtain remuneration from "presents," i.e. bribes and extortion. Attached to the government service are a number of tribes (called *maghzen* tribes), who furnish the sultan's body-guard, garrison certain towns, and perform other duties in return for exemption from taxation. There was no regular assessment for taxation, but such organized spoliation as might be required for public or private ends. That part of the empire where the sultan's authority is supreme is known as *blad el-maghzen* (government country); those regions where the sultan's authority is precarious are called *blad es-siba* (the unsubmitive country).

All the powers are represented in Tangier by diplomatic and consular officials, whose independent jurisdiction over their respective fellow-subjects leads to the frequent confusion of justice. The evidence of non-Mahomedans is not accepted in Moorish courts, where venality reigns, and unprotected Jews suffer constant injustice, besides daily indignities, for which they repay themselves by superior astuteness.

Army.—A half-organized army, service in which is partly hereditary, partly forced—is periodically employed in collecting taxes at sword-point, and in "eating up" the provinces; with it the custom is (or was) for the sultan to go forth to war each summer, spending the winter in one of his capitals. The only approach to a regular army consists of certain hereditary troops furnished by the *maghzen* tribes, the *Bokhâra* (black), the *Udaïa* (mulatto), the *Ashragah* and *Ashrâdah* (white), and the *Gaish*, who form a body of police, *Makhkiznia* (mixed), all of whom are horsemen. The infantry (*Askâria*) are mostly rough levies; only a small portion being well trained under European officers. No accurate estimate can be formed of the total available forces, and the arms are of every pattern. There is no navy, but the government possesses several small steamers, one or two mounting guns.

Religion.—The religion of Morocco is Islam, the Moors being among the strictest followers of Mahomet. The divisions of the East are unknown, and their tenets include the principal teachings of both Shias and Sunnis, but, as employing the *Mâleki* ritual, they must be classed with the latter. Recognizing their own sultan as *Amir el Mu'minin* ("Commander of the Faithful") and *Khalifa* of God on earth, they acknowledge no other claimant to that position, and have few dealings with the Turks, whom they consider corrupt. They have not yet given way extensively to strong drink.

Missions.—The Franciscans for six and a half centuries did brave work in the country, since the founder of their order offered himself for that task in 1214, and many of them, including several British and Irish missionaries, suffered martyrdom; but they have long abandoned attempts to convert the Moors. The London Jewish Society was established in Mogador in 1875, and since 1883 various Protestant agencies support a considerable number of missionaries, men and women, including doctors and nurses.

Education.—The level of education could hardly be lower, although most males have an opportunity of learning to recite or read the Korân, if not to write. Only traders trouble about arithmetic. Youths who desire to pursue their studies attend colleges in Fez or elsewhere to acquire some knowledge of Mahomedan theology, logic, composition and jurisprudence.

Literature and Travel.—Journalism is entirely foreign, and was introduced in 1883, at the same time as the printing-press, Spanish, French and English newspapers being established in quick succession. The sultan el Hassan III. set up a lithographic establishment in Fez, from which a valuable series of Arabic theological, legal and historical works have been issued, but most noteworthy of all is the publication in Cairo in 1895 of an Arabic history of Morocco, in four volumes, by

a native of Sallî, Ahmad bin Khalid en-Nâsiri. A most practical step was taken by the French, on the conclusion of the agreement with Great Britain in 1904, in the establishment of a state-subsidized *Mission scientifique au Maroc*, which, in addition to establishing at Tangier the only public library in the empire, engaged a number of able students in research work, the results of which are embodied in the periodical publications *Archives marocaines* (6 vols., 1904-1906) and *L'Afrique française*.

Other forward steps have been taken in the production of several important volumes on the country and in serious attempts to explore the Atlas. The vicomte de Foucauld attained the first place by his intrepid journeys as a Jew through the forbidden regions and by his workman-like geographical records; Joseph Thomson did good work in the Great Atlas, though within a limited area; the vicomte de la Martinière excavated some of the Roman remains; Mr Walter B. Harris made a bold journey to Tafilaît; and the marquis de Genzacc and Louis Gentil added to the knowledge of the Atlas by interesting expeditions.¹ A hydrographic mission under A. H. Dyé also did valuable work (1905-1909). An equally important service was rendered by the compilation by Sir R. Lambert Playfair and Dr Robert Brown of an invaluable *Bibliography of Morocco to the end of 1891* (1893), containing over two thousand entries.

History.—The prehistoric antiquities of Morocco are of considerable interest. In the cave at Cape Spartel Tissot found regularly shaped arrow-heads, and in the north of the country he met with dolmens, barrows and cromlechs, just as in Algeria or Tunisia. The dolmens usually form a trapezium, and the body seems to have been buried with the knees drawn up to the chin. At M'zôrah, a quaint little village of widely-scattered houses built of rough blocks of yellow soft sandstone, about 8 or 10 m. south-east from Azlâ, stands a group of megalithic monuments of some interest. They have been visited and described by many travellers, but Watson's account is the most detailed. Round the base of a mound (15 ft. high) of yellow sandstone lies a circle of sixty-seven large stones, one of which (at the west side) is more than 20 ft. high. In the vicinity are several other groups, some of still larger blocks. Roman roads (see AFRICA, ROMAN) seem to have run from Tangier southwards to the neighbourhood of Mequinez (Miknâs), and from Azlâ to the south of Kabât; and Roman sites are in several instances marked by considerable remains of masonry. At Kaşar Farâ'ou (Pharaoh's Castle), on the western slope of J. Zarhôn, are the ruins of Volubilis. The *enceinte*, constructed of large stones and flanked by round towers, is 12,000 ft. in extent. Four gates are still recognizable, and a triumphal arch erected in A.D. 216 in honour of Caracalla and Julia Domna. The stones of this site have been used for Mequinez Miknâs. Banasa (Colonia Aelia, originally Valentia) is identified with the ruins of Sidi Ali Bû Jenun, and Thamusia with those of Sidi Ali b. Hamed. At Shammish, up the river from Laraish, the city of Lixus (Trinx of Strabo) has splendid specimens of Punic and Roman stonework, and the similar remains on the headland of Mûlaf Bû Selham probably belong to the *Mudelacha* of Polybius. Of early Moorish architecture good examples are comparatively few and badly preserved. Besides those in Fâs, Miknâs, and Marrâkesh, it is sufficient to mention the mausoleum of the Benî-Marîn (13th to 16th centuries) at Shella, which, with the adjoining mosque, is roofless and ruined, but possesses a number of funeral inscriptions.

The earliest records touching on Morocco are those of Hanno's *Periplus*, which mentions that Carthaginian colonies were planted along the coast. The savage and inhospitable tribes with whom they came in contact included cave-dwellers; but megalithic remains point to a yet earlier race. It is not till the last century B.C. that Moroccan Berbers are found supplying troops to Pompey or Sertorius, and later, under Augustus, becoming themselves incorporated in the Roman province of Mauretania (q.v., and also AFRICA, ROMAN). But the Roman province reached only to the Bû Ragrag, on which Sala, now Sallî, was its outpost; Volubilis, near Mequinez, being its principal, if not its only, inland city. In the fifth century A.D. the country became subject to the Vandals and, about 618, to the Goths.

¹Gentil, in *La Géographie*, No. 3 (1908), describes the Siroua region, which, N.N.W. of Tikrit, connects the Anti Atlas and the High Atlas. The Siroua volcano compares with the finest volcanoes of Europe.

The coming of the Arabs under 'Oqba ('Okba) in 682 was of far greater moment, though it was not till twenty years later that his successor, Mūsa ibn Nōsair, undertook a successful expedition as far as Tāfilāt and the Dra'a. The force of ten thousand Arabs and Egyptians with whom Tariq (Tārik) ibn Zāid held the Tangier district in 710 was trebled by the enrolment of the Berbers, who enabled him next year to invade Spain, burning his boats behind him (see CALIPHATE, § C. Abbasids). But the Moroccan Berbers chafed beneath the Arab rule, and in 730 successfully revolted, setting up their first independent ruler, Maisara. Their kinsmen in Spain followed suit with equal success, and though subdued for a time, they retained their independence in certain parts till the 11th century, when, as masters of Granáda, they subjugated their implacable foes, the Arabs; and finally, under the Murābtī and Muwāhhādī dynasties, conquered all Mahommedan Spain.

The recorded history of the Moorish Empire commences with the tradition near the Roman ruins of Volubilis in A.D. 788 of the **Early Dynasties**. Idrīs the elder (Idrīs b. Abdallah), one of the fugitive descendants of Mahomet during the struggles between rival claimants of the caliphate. Islām had then been established in these parts for eighty years, but Idrīs and his son, Idrīs II., the builder of Fez, extended its influence, uniting the Berbers into a kingdom. Their line controlled a limited portion of northern Morocco for nearly two centuries, in part supplanted by the Miknāsā in 922, until displaced by the Maghrāwā in 988. These two dynasties were exterminated in 1061 by Yūsef I. (bin Tashfīn), founder of the Murābtī dynasty of Berbers (Almoravides), who added the remainder of Morocco, most of Spain and Portugal, and Tlemçen. Their principal existing monument is the city of Marrākesh. In 1149 the Murābtī power was overthrown by another religious leader, 'Abd el Mumin at the head of the Muwāhhādī—i.e. "Unitarian"—horde (Almohades), under whom the Moorish Empire reached its zenith at the close of the 12th century. It then included, in addition to the Murābtī realm, what now are Algeria, Tunisia and Tripoli, extending to the frontier of Egypt, which they were prevented from occupying by the rise of Saladin. Before the middle of the 13th century they had been driven out of Spain, and had lost all but what is now known as Morocco, whence, between 1217 and 1269, they were ousted by the Beni Marīn (Marinides). To them we owe the Giralda, Hasan and Kūtūbiya towers of Seville, Rabat and Marrākesh respectively, the Torre de Oro at Seville, Gibraltar Castle, and the towns of Rabat and Al ḡasar. It was under their rule that Francis of Assisi despatched to Morocco the first Christian missionaries of modern times. (See ALMORAVIDES and ALMOHADES.)

The new dynasty differed from the two which had preceded it in being frankly part of a Berber tribe, the Zenāta, who carved out a kingdom for themselves. Having assisted the Murābtīs and Muwāhhādīs respectively at the battles of El Arcos (1109) and Las Navas (1212), the defection of their amir on that occasion offered an opportunity for Abd-el-Haḡk, the son of their general, to attempt the overthrow of the reigning house. At first the Beni Marīn professed allegiance to Tunis, where the Hafsis, a branch of the Muwāhhādīs, had thrown off the Moorish yoke and secured acknowledgement in northern Morocco and parts of Spain. But they were soon in a position to proclaim complete independence, and by the time that Abu Bakr, the third son of Abd-el-Haḡk to succeed him, died, in 1258, they held sway over all that is now known as Morocco, and 1269 saw the death of the last Muwāhhādī prince.

On the death of Abu Bakr there succeeded Yākūb II., one of the few amirs of Morocco who have left a name for just administration and for philanthropic undertakings. Although of strict religious habits, he displayed no bigotry, studying philosophy, and entering into friendly intercourse with Europeans, whom he encouraged to trade with Sali. In 1261, 1275 and 1277-1279, he undertook successful expeditions to Spain, and again in 1284, this time, in alliance with Alphonso of Leon, against his

rebel son Sancho. But Alphonso dying during the struggle, Yākūb found himself master of his country, and Sancho had to acknowledge his suzerainty. All Mahommedans within his realm were freed from all taxes, and all the Arabic manuscripts of the country—thirteen loads—were despatched to the college Yākūb had built in Fez.

But Yākūb did not live to reap the benefits of his conquest, which were enjoyed by his son, Yūsef IV. (1286), who was courted by his father's old foes, entering into amicable relations with Tunis, Egypt, Arabia and the neighbouring European states. With the contemporaneous Beni Zeiyān dynasty of Tlemçen, sworn foes of his house, however, he was still at war when stabbed (1307) in the new town of Tlemçen, which he had built while conducting a siege of the old town. A second siege was begun in 1335, and Tlemçen fell in 1337 to the fourth ruler of the dynasty, Ali V., Abu 'l Hasan, better known as "The Black Sultan." Unsuccessful in his invasion of Spain and Tunisia, Ali had eventually to abdicate in 1351 in favour of his rebel son, the famous "Abu Aīnān," Fāris I., who during a short reign recovered Algeria and Tunisia.

The Beni Marīn were soon driven back, till a few years later Tlemçen alone remained to them, and this they held only till 1350 (see TLEMÇEN). Thereafter their empire became habitually divided between rival claimants, and the Portuguese began to obtain footholds on the coast, Ceuta being lost to them in 1415, Al Kasar in 1458, and Azilā and Tangier in 1471.

On the failure of the Beni Marīn the amirate was seized by Sa'id III., "El Waṭṭās," head of another branch, founder of the short-lived Waṭṭāsī dynasty. His reign is memorable as that in which the "Catholic Princes" expelled his co-religionists from Spain, the last amir of Granáda and many others taking refuge in Morocco, where in 1492 they built for themselves Tetuan. His son, Mahomet VIII., surnamed "the Portuguese," because so long a prisoner of that people, had to suffer the loss to Portugal of practically all his Atlantic ports but Sali-Rabat, and of Peñon de Velez to Spain, which had a few years previously captured Melilla. Although two more reigns carried the dynasty down to 1550, it has barely left its mark upon the country. From the beginning of the new century a rising power had been making itself felt in the south, over which the Waṭṭāsīs never held sway.

The family of sharifs or "nobles"—that is, descendants of Mahomet—popularly known as the Sa'adi or Hasani (Hosaini), settled in the Dra'a district, but originally came from Sa'adi Yanboa, near Medina. Their opportune religious leadership rallied the disjointed members of the empire for a *jahād* against the Portuguese, but ultimately, on the death of Mahomet VIII., when in possession of the kingdom of Marrākesh, the sharifs defeated his successor and arranged a formal division of the country at the Um er-Rabi'a. At the head of the movement were then the two sons of the sharf who had started it, Ahmed III. and Mahomet IX., between whom rivalry broke out, resulting in the success of the latter, who by 1550 found himself the master of the whole empire on carrying off the last Waṭṭāsī amir Mahomet and espousing his daughter.

On the assassination of Mahomet IX. in 1557, the succession passed by a previous agreement to his brother's son, 'Abd-Allah IV., who secured himself against the possible rivalry of his brothers by putting ten of the twelve to death. One of the survivors, however, Abd-el-Mālek I., deposed Abd-Allah's son, Mahomet XI., whose appeal to Sebastian of Portugal for assistance, brought about the celebrated "battle of the three kings," in which they all perished in 1578 near Al Kasar. This opened the way to the most famous of his line, Ahmed IV., Ed-Dhāhebi, or "the Golden," who proclaimed himself caliph, the last (nominal) Abbasid holder of that office having been superseded by the Turks on their conquest of Egypt in 1517. He entered into friendly relations with Queen Elizabeth and other European potentates, and the oases of Tūat, &c., were added to his dominions, which embraced also Timbuktu, whence came gold and tobacco. Ahmed fell a victim of the plague in 1603, and the

succession was disputed by three of his sons. In 1608 one of them, Zidān, became supreme and reigned twenty years. To subdue rebellions Zidān twice obtained the assistance of English troops from Charles I., and, like his father, employed large numbers of European artificers in the various palaces he built or completed. The two sons who succeeded him had both become drunkards from intercourse with these foreigners, but a third, Mahomet XIII., called from prison to reign in 1636, proved himself a wise and beneficent ruler. But his friendship for Europeans displeased the more fanatical among his subjects, and after a futile attempt on the part of a central Moroccan "saint" of great reputation to oust him, and the "Christians" on the coast as well, another family of sharifs was invited from Taflālt to undertake the task, and by 1649 they were masters of Fez.

Before tracing the history of the Filāli dynasty, which still holds its own, it will be convenient to refer briefly to the relations which subsisted then (17th century) and for many years afterwards, apart from wars with Spain and Portugal, between the Moors and Europeans. From the early part of the 13th century there are records of Christian mercenaries and others in the Moorish service, while intermittent trading expeditions had already brought the principal European ports of the Mediterranean into touch with Morocco. The settlement of European traders in Moorish ports does not appear to have commenced till later; but it soon became an important factor, for the Moors have always appreciated the advantages of foreign commerce, and thus the way was opened up for diplomatic intercourse and treaty privileges. Even while their rovers were scouring the seas and making slaves of the foreigners captured, foreign merchants were encouraged to trade among them under guarantees and safe-conducts. Thus originated all the rights enjoyed by foreigners in Morocco to-day, as subsequently confirmed by treaties. France was the first to appoint a consul to Morocco, in 1577, Great Britain only doing so a century later. For centuries the treatment of foreign envoys in Morocco was most humiliating, the presents they brought being regarded in the light of tribute. It was not till the year 1900 that the custom was abolished of mounted sultans under umbrellas receiving ambassadors on foot and bareheaded.

While, from the European point of view, the pirates of the Barbary coast were a bloodthirsty set of robbers, in no way to be distinguished from the sweepings of Western civilization who scoured the seas farther east, from the standpoint of the Moors they were the pious religious warriors for the faith, who had volunteered to punish the Nazarenes for rejecting Mahomet, and it is difficult to realize the honour in which their memory is held save by comparison with that of the Crusaders, in which the positions were exactly reversed. The Moorish rovers approached as nearly to an organized navy as anything the country ever possessed, and at times they were fitted out by the state, to whom their prizes therefore belonged. They made descents on the opposite coasts, even as far as Devon and Cornwall, carrying off the population of whole hamlets.

Sallī, Mā'mora (Mehediya), Laraiṣh, Tangier, Ceuta, Tetuan, and Bādīs were their principal rendezvous in Morocco, and their vessels, an assortment of almost every known build and rig of the day, varied greatly in numbers and size. It is probable, however, that contemporary writers greatly over-estimated their importance. They appear to have flourished chiefly throughout the 16th, 17th and 18th centuries, and to have attained the zenith of their power during the latter part of the 17th century. A great impetus was given to their raids by the expulsion of the Moors from Spain in 1610, and their operations were facilitated later by the recovery of most of the Moorish ports from foreign hands. The varying influence of the different European states could be gauged at first by the prices they were compelled to pay to ransom their captive subjects, and later by the annual tribute which they were willing to present to protect their vessels. Some countries continued the payment

well into the 19th century, although the slavery of Christians in Morocco had been abolished by treaty in 1814.

During the time that piracy flourished hundreds of thousands of foreigners suffered captivity, torture and death in Morocco rather than abjure their faith, the one condition on which a measure of freedom within Morocco was offered to them. The horrors of that time were keenly felt in Christendom, and collections were constantly made at church doors for the ransom of Moorish captives. Frequent expeditions for that purpose were undertaken by members of religious brotherhoods, not a few of whom themselves became martyrs. The lot of the European slave was infinitely worse than that of the negro who indifferently embraced Islām, and was at once admitted to equality in all points save freedom. They were principally employed on public works or in galleys under the task-master's lash, both men and women being subjected to every indignity.

The record of the Filāli dynasty may now be considered. The first of this line proclaimed in Fez was Mahomet XIV., but the first of European fame was his brother, **FILALI DYNASTY (1649-)** Rashid II., "The Great Taflāṭta," as he was styled by the English, who then occupied Tangier, sultan from 1664 to 1672. With him opened a terrible epoch of bloodshed and cruelty, only once revived since—during the short reign of El Yāzīd (1790-1792)—the horrors of which for both natives and Europeans, are often indescribable. It reached its climax under his brother Ismā'īl. A man of wonderful vitality, his reign lasted 55 years (1672-1727), during which his fierce grasp never relaxed. Many hundreds of sons and countless daughters were born to him in a harem rivalling that of Solomon, for which he even asked a daughter of Louis XIV. Having, as he supposed, driven the English from Tangier, he laid unsuccessful siege to Ceuta for 26 years, but otherwise his military measures were confined to subduing internal enemies, in which he was supported by his faithful black troops, the Bokhāris, and also by a foreign legion of renegades.

For 30 years after Ismā'īl's death one son after another was set up by the Bokhāris, seven succeeding—some of them more than once—till one, Abd-Allah V., who partook of his father's bloodthirsty nature, ended his sixth turn of power in 1757. Then, at last, this dynasty provided a beneficent sovereign in the person of his son, Mahomet XVI., during whose reign of 33 years the land prospered. By him Mogador was built and Mazagan, the last hold of the Portuguese, recovered. He was followed by the wretch Yāzīd, his son by an English or Irish woman, whose reign was fortunately cut short while contending with four rival brothers, two of whom in turn succeeded him, the second, Sulaiman II., proving as wise a ruler as his father. Under his reign (1795-1822) piracy was abolished, but the policy, maintained till the end of the century, of having as little as possible to do with foreigners was initiated.

By Sulaiman's direction the imperial umbrella passed to his nephew, Abd-er-Rahmān II., on whom he could rely to maintain his policy. Although disposed to promote foreign trade, he made a futile attempt in 1828 to revive piracy, which the Austrians frustrated by reprisals next year. Following this was the war of 1830 with France over the partition of Algeria, as a result of which the Moors renounced all claim to Tlemcen and entered into agreements the infraction of which led to a second war between the two in 1844, during which Tangier and Mogador were bombarded. A bombardment of Sallī in 1851 secured for the French the settlement of various claims, and when Abd-er-Rahman died, in 1859, the Spaniards were threatening Tetuan.

War being declared, the Spaniards marched on the town, which they captured after two months, and held till peace was signed six months later on their own terms. The vanquished sultan, Mahomet XVII., reigned till his death in 1873, when his son, El Hasan III., succeeded, having the usual fight to secure the supremacy. In comparison with his predecessors El Hasan was mild and gentle, too much so to maintain continual

peace among the more turbulent of his subjects. From early in the century Sûs had practically maintained independence, but in 1882 was reduced to submission, as also were subsequently the other great Berber centres, one by one, till the land had rest. Fighting between the Rifians and Spaniards in 1894 having involved the sultan in the payment of some £650,000 indemnity, he was on his way to recover this from the culprits when he died in camp and was interred at Rabat.

El-Hasan's death was kept secret till the coffin reached its destination, so that a peaceful proclamation was secured for

'Abd-el-'Aziz IV., his son by a Circassian slave who possessed great influence over him. His trusted chamberlain, Si Ahmed ben Mûsa, became Wazir regent, and put down all opposition, ruling with a

firm, wise hand till 1900, when he died just as his ward attained his majority. Drastic changes thereon took place, and a new set of ministers came into power. The young sultan now showed himself desirous of acquiring and practising foreign arts and of introducing foreign reforms. Under his mother's advice he sought especially the friendship and advice of Great Britain, on whose disinterested friendship he believed he could rely. But lack of training and experience frustrated his praiseworthy efforts, and he became the prey of schemers and speculators, who pandered to his worst traits and squandered his treasure.

This turn of affairs aroused the fanaticism of his people, and in 1902 the Berber tribes of the Algerian frontier rose in rebellion under Jelâli Zarihoûni, nicknamed "Bu Hamâra," who claimed to be fighting on behalf of the sultan's brother Mahomet, already imprisoned in Mequinez for revolt.¹ Unable to subdue the rebellion, which did not, however, affect the rest of the empire, 'Abd-el-'Aziz borrowed money from France to reorganize his army, but failed to effect his purpose. Meanwhile a local sharîf, Mulai Ahmed er-Raisûli, made himself master of the district round Tangier, holding even foreigners to ransom, and creating a false impression abroad as to the general state of the empire.

The end appeared near when by a declaration, signed in London on the 8th of April 1904, Great Britain, in return for concessions in Egypt, agreed not to interfere with French action in Morocco. In this declaration, one of the series of arrangements marking the establishment of the *entente cordiale*, France declared that she had no intention of changing the political status of Morocco. She designed, however, a system of "pacific penetration," and administrative, economic, financial and military reforms—reforms which the Moorish court did not desire. By a separate convention with Spain in October 1904 the interests of that country were safeguarded, and it seemed that the Anglo-French agreement had the approval of all the powers. Some weeks before its conclusion its terms had been communicated to Germany, and four days after its signature Count Bülow had stated in the Reichstag that there was no ground to apprehend that German interests ("essentially economic") in Morocco would be disregarded. During the remaining months of 1904, however, and in the opening months of 1905, the international situation was changed. Germany had viewed with concern the increased influence of France in Europe, but remained quiescent until after the reverses to the Russian arms in Manchuria, when it was judged in Berlin that the time had arrived for Germany to become the arbiter of European policy; and the means to demonstrate her position were found in the Moroccan question. After having turned a deaf ear to the demands of the Pan-Germanic party for the "vindication" of German rights in Morocco, after in fact nearly a year of acquiescence in the predominant position of France in that country² the German

¹ Mulai Mahomet, eldest son of El Hasan and a generally popular prince, was released from prison by 'Abd-el-'Aziz early in 1908 and placed in command of his army. On the defeat of 'Aziz by Mulai Hafîd, Mahomet contemplated seizing the throne. He was, however, imprisoned by Hafîd in the palace at Fez, where he was reported to have died, in mysterious circumstances, in June 1909.

² Shown *inter alia* by the landing of 500 Algerian troops at Tangier (a step taken to secure the release of Ion Perdricat and his stepson, captives of Raisûli), and of a detachment at Rabat.

government now complained of being ignored in the Anglo-French arrangement and proceeded to extend its patronage to 'Abd-el-'Aziz. On the 31st of March 1905 the German emperor landed at Tangier and had conferences with the sultan's representatives. The emperor was reported to have declared that he had come to enforce the sovereignty of the sultan, the integrity of Morocco, and the equality of commercial and economic interests. The effect of this intervention was soon apparent. The sultan rejected the scheme of reforms proposed

by France, and at the suggestion of Germany issued invitations to the powers to meet his representatives and advise him concerning the reforms needed.

The French foreign minister, M. Delcassé, held that there was no need for a conference, but Prince Bülow used menacing language and after a period of much stress M. Delcassé resigned (June, 1905), the French government thereupon agreeing to the holding of a conference. So far the German policy had triumphed; the conference met at Algier on the 16th of January 1906 and engaged in the delicate task of reconciling French claims for predominance with the German demand of equality for all. The British delegates gave firm support to their French colleagues, while Austria proved "a brilliant second" to Germany. With great difficulty a scheme of reforms was elaborated, Germany having previously acknowledged the privileged position of France along the Moroccan-Algerian frontier. The general act embodying the resolutions of the conference was signed on the 7th of April; it was accepted by the sultan on the 18th of June, and the ratifications of the act by the other powers were deposited at the Spanish Foreign Office on the 31st of December 1906. The act provided for a Moorish police force from 2000 to 2500 strong, distributed among the eight open ports of Morocco, to be commanded by Moorish kaid, assisted by French and Spanish instructors and officers, with a Swiss inspector-general—the arrangement to continue for five years. The act provided also for the institution of a state bank (see *supra* § Finance). Other provisions dealt with (a) the acquisition of land round the ports by foreigners, and the consequent payment by them of the regulated or *tertib* taxes; (b) the more efficient control of the customs administration, first by an annual assessment of the average values of all imports as a basis for the tariff during the following year, and, secondly, by a strict supervision of the administration itself; and (c) the authority of the state over the public services and public works, tenders for which were to be adjudicated impartially without reference to the nationality of the bidder.

Throughout 1906 the country was in a disturbed condition, and while a Franco-Spanish demonstration off Tangier succeeded in obtaining the removal of Raisûli from the governorship of the town, various outrages occurred (including the murder of a Frenchman in the suburbs of Tangier) for which no satisfaction could be obtained.

At length the murder of Dr. Emile Mauchamp at Marrakesh on the 19th of March 1907 determined the French to take prompt action, and Ujda was occupied (March 20) by Algerian troops, the French government determining to hold the town until satisfaction had been given to their demands. This satisfaction 'Abd-el-'Aziz promised in May, and some progress was made towards carrying out the Algierias programme, the state bank being organized in July 1907. Meantime the weakness of the sultan's rule was illustrated in many quarters: near Tangier by the continued activity of Raisûli, that chieftain securing in June another European captive—Sir Harry Maclean,³ who after over seven months' detention had to be ransomed by the British government for £20,000.

³ Kaid Sir Harry Maclean (b. 1848) after serving in the British army became instructor to the Moorish army, which he accompanied in several expeditions. He was also colonel of the sultan's body-guard. For services rendered to the British government he was made a C.M.G. in 1898 and a K.C.M.G. in 1901. On the occasion of his capture he had gone, as he thought, to receive the submission of Raisûli, and had with him one or two attendants only. The sum paid for his ransom was subsequently refunded—as to £15,000 by Raisûli himself and the remainder by Mulai Hafîd.

The
Algierias
Conference.

France
occupies
Ujda.

At Casablanca at this time works were in progress, with the sanction of the sultan, for improving the harbour. The works were beyond the ramparts, close to the Moslem cemetery; and the neighbouring tribesmen (the Shawia) were excited by reports that the cemetery had been desecrated. On the 30th of July they attacked the European labourers and killed nine of them (three French, three Spaniards, and three Italians), afterwards entering the town and raiding the Jewish quarter. Refugees fled by boat to Tangier with news of the massacre. The French government decided to occupy Casablanca, and a strong naval and military force was sent thither. Before the arrival of the troops the commander of the cruiser "Galilée" landed a party (Aug. 5) to guard the French consulate. The passage of the detachment was opposed, whereupon the "Galilée," aided by the "Du Chayla" bombarded the town. Casablanca was at the same time entered by the tribesmen, who began a general **Casablanca** pillage. On the 7th the French troops arrived and were landed, and further fighting took place. Before order was restored nearly every inhabitant had been killed or wounded or had fled; the dead alone numbered thousands. The European colony was, however, saved. Though masters of the town, the French found the Shawia tribes still full of fight, and, first under General Drude and afterwards (Jan. 1908) under General Amadé, the French proceeded to the reduction of the Shawia country. At one time the expeditionary force numbered 15,000 men.¹ By June 1908 the district was quiet and thereafter the strength of the force was gradually reduced.²

The action of France at Casablanca aroused the fanaticism of the tribes of Tafilalet and those dwelling near the Algerian border. In November 1907 the Beni Snassen crossed the frontier and were not reduced to submission until after hard fighting. Another outbreak occurred in April 1908, when a French column in the Guir district, west of Figig was surprised, and had difficulty in beating back the enemy. In that and a subsequent engagement, which resulted in the dispersal of the foe in May, the French casualties were over 200. French and Moorish commissioners were then appointed to preserve order along the frontier.

While thus engaged on the eastern frontier and on the Atlantic coast of Morocco France had given financial and moral support to 'Abd-el-'Aziz, whose position was threatened by his brother Mulai Hafid. On the 16th of August 1907, within a fortnight of the bombardment of Casablanca, the ulema of Marrakesh had declared 'Abd-el-'Aziz deposed and Hafid sultan; and from September onwards the tribes round Casablanca opposing the French were supported by troops sent from Marrakesh. Aziz having been furnished with money by the state bank, he was enabled to reach the seaport of Rabat at the head of his army in September 1907. There he was visited by the French minister and appeared willing to grant all the demands of France in return for help against his brother. A loan was forthcoming but no military assistance save that some of 'Abd-el-'Aziz's troops were taken by a French warship to Mazagan. While desultory fighting between the supporters of the rival brothers was proceeding Hafid was proclaimed sultan at Fez on the 4th of January 1908; Hafid now sought support from France, Germany, and other powers, and moving from Marrakesh passed the French

¹ A Spanish force of 600 men was also sent to Casablanca. Throughout the crisis Spain, with some misgiving, co-operated in the actions of France.

² In September 1908 the German consul at Casablanca gave safe-conduct to six deserters from the Foreign Legion, of whom three were Germans. On the way to embark for Hamburg, and while under guard from the German consulate, all six deserters were forcibly arrested by a French patrol. The matter created great excitement both in Germany and France, chiefly from the demand of the German government that France should express regret for the action of its agents before the facts were fully established. A way of escape was found in the formula "the two governments, regretting the events which occurred at Casablanca, . . . refer the matter to arbitration . . . and agree to express regret . . . according to the judgment of the court." The case then went to The Hague Court of Arbitration, which gave its decision in May 1909, substantially in favour of France. In July the French government pardoned the deserters.

lines in the Shawia country, entered Mequinez in May and Fez in June 1908. At length 'Abd-el-'Aziz made an effort to reassert his authority and with a force numbering 4000 he left Rabat in July for Marrakesh. He reached the neighbourhood of that city on the 2nd of August, having received the adhesion of numerous tribes, including the Shawia. On the 19th he started for the final march on Marrakesh. He appears to have been betrayed, for hardly had his force started when it was assailed on all sides, whereupon the tribesmen deserted in a body and the "regulars" ran away. The day was irretrievably lost and 'Abd-el-'Aziz sought safety in flight. On the 22nd he arrived at Settat in the Shawia country, and within the French lines, with only a handful of followers. For a short time he talked of continuing the struggle, but ended by accepting a pension from his brother Hafid and was assigned a residence in Tangier. That town, the last in Morocco to acknowledge Hafid, did so on the 23rd of August; the change of sultans being accomplished without any disturbance of public order.

Germany was anxious for the immediate recognition of Hafid and caused some perturbation in France by a circular to the powers to that effect dated the 2nd of September; the French and Spanish governments replied by **Mulai Hafid Sultan** proposals for guarantees that Hafid would respect the Act of Algeçiras. This course received general assent and Hafid having given the guarantees demanded he was formally recognized as sultan at the beginning of 1909. His relations with Europe were made easier by the conclusion, in February 1909, of a Franco-German agreement designed to avoid all cause of misunderstanding between those powers in Morocco. Germany put on record that her interests in the sultanate were "only economic," and France agreeing to "safeguard economic equality" Germany undertook not to impede the political interests of France in the country.

The weakness of the central government was exemplified by the inability of Mulai Hafid to control the Rif tribesmen, who in July 1909 killed a number of European labourers in the neighbourhood of the Spanish fortress of Melilla (*q.v.*). Spain sent an army of 50,000 men to vindicate its authority. After a severe campaign the Rifians were reduced to submission (Nov. 1909). Though powerless in the Rif, Mulai Hafid's army succeeded in defeating Bu Hamāra's force and in capturing (Aug. 1909) that pretender, otherwise known as el Roghi.³ Bu Hamāra and many of his followers were taken to Fez. The tortures inflicted upon them evoked strong protests from the European powers. In 1910 Mulai Hafid obtained a loan, chiefly from France, of £4,000,000; the greater part of the loan went to liquidate claims by Europeans against the *maghzen*.

AMIRS AND SULTANS OF MOROCCO

I.—Idrisi Dynasty (Arab), A.D. (Capital, Fez.)

- 788. Idris I.
- 791. Rashid (regent).
- 804. Idris II.
- 828. Mahomet I.
- 836. 'Ali I.
- 848. Yahya I.
- 881. Yahya II.
- 894. 'Ali II.
- Yahya III.
- 904. Yahya IV.
- (Interregnum from 917.)
- 922. El Hasan I. "El Hajjām." (Fez lost to the Miknāsā 925.)
- 935. El Kennūn (at Hajrat en-Nasr).
- 963. 'Abu'l-'Aish Ahmed.
- 954. El Hasan II. (at Basra).
- 961. 'Abd-Allah I.
- 970. Mahomet II. (Subjugated by the Maghrāwa 985.)

II.—Miknāsā Dynasty (Berber). (Capital, Fez.)

- 925. Musa I. "Ibn Abd-el-'Aafia."
- 938. Mādin.
- 952. Ibrāhīm I.
- 973. El Būrī.
- 1014. El Kāsem I.

³ For an account of Bu Hamāra's career see *Questions diplomatiques* (Oct. 16, 1909).

⁴ Title of sultan adopted about 1640.

III.—Maghrawa Dynasty (Berber). (Capital, Fez.)

988. Ziri ibn 'Atia.
1000. El Mūāz.
1026. Hammāma.
1039. Dūnas.
1060. El Fatūh and 'Ajisa.
1065. El Moānāsir.
1067. Tamim.

IV.—Murābti Dynasty (Berber). (Capital, Marrākesh.)

1061. Yūsef I. (Bin Tashfin.)
1106. 'Alī III.
1143. Tashfin I.
1145. Ibrāhīm II.
1146. Ishāk.

V.—Mūwāhhadi Dynasty (Berber). (Capitals, Marrākesh and Seville.)

1145. 'Abd-el-Mūmin.
1164. Yūsef II., "Abu Ya'kūb."
1184. Ya'kūb I., "Abu Yūsef el Mansūr."
1199. Mahomet III., "En-Nāsir."
1214. Yūsef III., "Abu Yākūb el Mustansir."
1223. 'Abd-el-Wāhid, "El Makhlūwī."
1224. 'Abd-Allah II., "Abu Mahomet."
1226. Yahya V., "El Mu'tasim."
1229. Idrīs III., "El Māmun."
1232. Rashid II., "Abd-el-Wāhid."
1242. 'Alī IV., "Es-Said el Mu'tadid." (Mequinez lost to Beni Marīn 1245.)
1248. 'Omar II., "El Mortada." (Fez lost to Beni Marīn, 1248.)
1266. Idrīs IV., "Abu Dabbūs el Wāthik." (Marrākesh lost to Beni Marīn, 1269.)

VI.—Beni Marīn Dynasty (Berber). (Capitals, Fez, Mequinez and Marrākesh.)

1213. 'Abd-el-Hakk.
1217. 'Othmān I., "Abu Said I."
1239. Mahomet IV., "Abu Marrāf."
1240. Abu Bakr.
1258. Yākūb II., "bin 'Abd-el-Hakk."
1286. Yūsef IV.
1307. 'Amr, "Abu Thābit."
1308. Sulaimān I., "Abu Rebi'a."
1310. 'Othmān II., "Abu Said II."
1320. 'Omar II. (at Sajilmāsa).
1331. 'Alī V., "Abu'l Hasan."
1351. Fāris I., "Abu'Anān."
1358. Sa'id I. (a child).
1359. Ibrāhīm III., "Abu Salem."
[Tashfin II., "Abu 'Omar."
1361. 'Abd-el-Halim (in Sajilmāsa).
[Mahomet V.
1366. 'Abd-el-'Aziz I.
1372. Mahomet VI., "Es-Said."
[Ahmed I., "Abu'l'Abbās" (in Fez).
1374. 'Abd-er-Rahman I. (in Marrākesh).
1384. Mūsa II. and Ahmed II. (in Marrākesh).
1386. Mahomet VII., "El Wāthik."
1387. Ahmed I. (2nd reign).
1393. 'Abd-el-'Aziz II., "Abu Fāris."
1396. Fāris II., "El Mutawaqqil."
1408. Abu Sa'id III.
1416. Sa'id II. and Yākūb III.
1425. 'Abd-Allah III. (after whom the record of this dynasty ceases).

VII.—Wattāsī Dynasty (Berber). (Capital, Fez.)

1471. Sa'id III., "Es-Sheikh el Wattās."
1500. Mahomet VIII., "The Portuguese."
1530. Ahmed III. (in Fez).
1548. Mahomet X. (Defeated by the Sharifs, 1550.)

VIII.—Sa'adi Dynasty (Arab). (Capitals, Fez, Mequinez and Marrākesh.)

- [Ahmed III. (in Marrākesh).
[Mahomet IX. (in Tarūdānt).
1557. 'Abd-Allah, "El Ghālib."
1574. Mahomet XI., "El Mutawaqqil."
1576. 'Abd-el-Mālek I., "El Muatāsīm."
1578. Ahmed IV., "El Mansur" or "Dhahebi."
1603. Mahomet XII., "Es-Sheikh."
[Abd-el-'Aziz III., "Abu Fāris."
1608. Zidān.
1628. 'Abd-el-Mālek II.
1631. El Walid.
1636. Mahomet XIII., "Es-Sheikh Es-Saghir." (Fez lost to the Filālis, 1649.)
1654. Ahmed V., "El Abbās."
1658. 'Abd-el-Karīm in Marrākesh. (Overthrown by Filālis, 1668.)

IX.—Filāli Dynasty (Arab). (Capitals, Fez, Mequinez and Marrākesh.)

1649. Mahomet XIV., "Es-Sharif."
1664. Rashid II.
1672. Ismā'il, "The Bloodthirsty."
1727. Ahmed VI., "Ed-Dhahebi II."
1728. 'Abd-el-Mālek III., "Abu Merwān."
1729. 'Abd-Allah V., "El Mortada."
1734. 'Alī VI.
1736. Mahomet XV., "Uld er-Riba."
1738. El Mustadi.
1745. Zin el 'Abdin.
1757. Mahomet XVI.
1790. El Yazid.
1792. El Hishām.
1795. Sulaimān II.
1822. 'Abd-er-Rahman II.
1859. Mahomet XVII.
1873. El Hasan III.
1894. 'Abd-el-'Aziz IV.
1908. Hafid.

NOTE.—The dates given are those in which the various rulers acquired sovereign power. Many had already secured the allegiance of certain provinces some time before, and many retained such allegiance long after the greater portion of the empire had accepted a successful rival. European nations in several instances treated with men who were not at the time actual sovereigns, and in some cases were never such.

BIBLIOGRAPHY.—*History*: Budgett Meakin, *The Moorish Empire*, an historical epitome (London, 1899; which contains critical notices of all important books on Morocco to date); Ernest Mercier, *Histoire de l'Afrique septentrionale* (3 vols., Paris, 1888-1891). Principal authorities: Native—Ibn'Abd el Hākim, embracing the period from A.D. 690 to 750 (trans. Jones; Göttingen, 1858); 'Abd el Wāhid el Marrākeshi (1149-1224), trans. E. Fagnan in the *Revue Africaine*, pp. 202-207 (1891), *Raḍ el Karīs* (788-1326), trans. Baumier (Paris, 1890); El Makkānī (710-1500), trans. Gayangos (London, 1840); El Ufrānī (1631-1812), trans. Houdas (Paris, 1889); and En Nāsiri (710-1804; Cairo, 1895). Foreign—Diego de Torres, *Relacion del Origen y suceso de los xarifes* (Seville, 1586); Faria y Sousa, *Africa Portuguesa* (Lisbon, 1681); Moutette, *Histoire des Conquestes de Mouley Archy*, &c. (Paris, 1683); De el Puerto, *Mission historique de marruecos* (Seville, 1708); Busnot, *Histoire du regne de Muley Isma'il* (Rouen, 1714); Louis S. de Chénier, *Récherches historiques sur les Mares* (3 vols., Paris, 1787); Mas Latrie, *Traité de paix*, &c. (3 vols., Paris, 1866-1872), and *Rélatons et commerce de l'Afrique septentrionale* (Paris, 1886).

Geography.—Budgett Meakin, *The Land of the Moors* (a general description, London, 1901); Ch. De Foucauld, *Reconnaissance au Maroc*, text and maps (Paris, 1888; by far the most extensive, detailed and original exploration up to that date undertaken in Morocco, admirably illustrated); J. D. Hooker and John Ball, *Morocco and the Great Atlas* (London, 1878; the trustworthy record of a serious and well-equipped scientific expedition, valuable chiefly for its botanical information); Gerhard Rohlfs, *Adventures in Morocco* (London, 1874; previous to De Foucauld's achievement, the most extensive journey recorded in modern times); Walter B. Harris, *Taflet* (London, 1895; recounts a plucky journey across the Atlas); Joseph Thomson, *Travels in the Atlas* (London, 1889; the narrative of a restricted excursion from Marrākesh); H. de la Martinière, *Journeys in the Kingdom of Fez* (London, 1889; chief value archaeological); Rafael Pezzi, *Los presidios menores de Africa* (Madrid, 1893; an account of the Spanish possessions in Morocco); Captain Jules Erckmann, *Le Maroc moderne* (Paris, 1885; includes parts not open to Europeans, visited by the author as an officer in the Moorish army); Capt. E. Bonelli, *El Imperio de Marruecos* (Madrid, 1882; a somewhat similar work, by a Spanish officer); F. de A. de Urre-tazu, *Viages por Marruecos* (Madrid, 1877; descriptions by a Spaniard born in the country and travelling as a native); G. D. Cowan and R. L. N. Johnston, *Moorish Lotos Leaves* (London, 1883; trustworthy papers dealing with south central Morocco); Emilien Renou, *Description géographique de l'empire du Maroc* (Paris, 1846; a compendium of information available at that date); J. Canal, *Géographie générale du Maroc* (Paris, 1902); *Mission de Segonzac, Voyages au Maroc 1890-1901* (Paris, 1903) and later publications of the Segonzac Mission; Ch. Tissot, *Récherches sur la géographie comparée de la Maurétanie Tigitane* (Paris, 1877; a valuable archaeological survey); M. Besnier, "Géographie ancienne du Maroc" and "Recueil des descriptions arabiques," both in No. III. of *Archives marocaines* (Paris, 1904); Leo Africanus, *Description of Africa*, 1526, trans. Pory, 1600; ed. Dr Robert Brown, for Hakluyt Society (3 vols., London, 1896; a wonderful work for its period, always of interest, but the source of many oft-repeated errors in books on Morocco).

Geology.—G. Maw, "Notes on the Geology of the Plain of Morocco and the Great Atlas," *Quart. Journ. Geol. Soc.* (1872), vol. xxviii.; J. Thomson, "Report of the Committee appointed to investigate the Geology and Geology of the Atlas Range in the Empire of Morocco," *Rep. Brit. Assoc.* 1889, Newcastle Meeting; P. Schnell

L'Atlas marocain (Paris, 1898); A. Brives, "Contribution à l'étude géologique de l'Atlas marocain," *Bull. Soc. Géol. France* (Oct. 1905).

Ethnology.—Budget Meakin, *The Moors* (London, 1902); a minute account of manners and customs; James G. Jackson, *An Account of the Empire of Morocco* (London, 1809); the authoritative description for a century; Georg Hóst, *Efterretninger om Marokos og Fes* (a work still of great value; Copenhagen, 1779); Thomas Fowell, *Capitivy and Adventures, 1730* (ed. Dr Robert Brown, London, 1829); one of the best and most intimate narratives of the European slaves; Count Sternburg, *The Barbarians of Morocco* (London, 1908).

Language.—Rev: José Lerchundi, *Rudimentos del árabe . . . demarrucos* (Tangier, 1891) and *Vocabulario español arábigo* (Tangier, 1892); Eng. trans. of the former by J. MacIver MacLeod (Tangier, 1900; most useful, but dealing chiefly with the corrupt colloquial speech of the Tangier-Tetuan district); Budget Meakin, *An Introduction to the Arabic of Morocco* (Tangier, 1900; vocabulary, grammar, notes, phrases, &c., for pocket use, in Roman characters); Miss C. W. Baldwin, *Morocco-Arabic Dialogues* (Tangier, 1892; uniform with the last-named, but in Arabic characters).

Maps.—The most trustworthy general maps are R. de Flotte de Roquevaire, *Carte du Maroc* (scale 1:1,000,000) 4 sheets, ed. 1908; the French War Office maps (scale 1:500,000, begun 1906, scale 1:100,000, begun 1909), and the British War Office map (scale 1:1,000,000) 4 sheets, 1904. There are numerous district maps. The Dyé Mission published fifteen. (B. M.; K. A. M.)

MORÓN DE LA FRONTERA, or MORÓN (anc. Arumi), a town of southern Spain, in the province of Seville; 32 m. S.E. of the city of Seville. Pop. (1900) 14,100. Morón occupies an irregular site upon broken chalk hillocks near the right bank of the Guadaira. It is connected by rail with Utrera on the Cadiz & Seville line. On the highest elevation to the eastward are the ruins of the ancient castle, of considerable importance during the Moorish period, when Morón, as its full name implies, was a frontier fortress; the castle was afterwards used as a palace by the counts of Ureña. In 1810-1811 it was fortified by the French, but blown up by them in the following year. The chief public building of Morón is the large parish church, which dates from the 16th century. Morón is also famous throughout Spain for its marble and its chalk (*cal de Morón*), from which the whitewash extensively used in the Peninsula is derived.

MORONE, GIOVANNI (1509-1580), Italian cardinal, was born on the 25th of January 1509 at Milan, where his father, Count Ieronimo Morone (d. 1529), was grand chancellor. His father, who had been imprisoned for opposing encroachments on the liberties of Milan by Charles V. (whom he afterwards cordially supported), removed to Modena, where his youngest son had most of his early education. Proceeding to Padua he studied jurisprudence with distinction. In return for important service rendered by his father, he was in 1527 nominated by Clement VIII. to the see of Modena, and consecrated in 1533 after a contest. From 1535 he was constantly entrusted by Paul III. with diplomatic missions; he was nuncio (1536) to Ferdinand, king of the Romans, and legate to the diet of Spire (1542) having successfully resisted the transfer of the diet to Hagenau on account of the plague (1540). On the 31st of May 1542 he was created cardinal, and was further nominated protector of England, Hungary, Austria, of several religious orders, and of the *santa casa* at Loreto. With the cardinals Paul Parisio and Reginald Pole he was deputed to open the Council of Trent (Nov. 1, 1542), the place of meeting having been a concession to his diplomacy. The legates arrived on the 22nd of November, but no council assembled. The death of Paul III. (1549) deprived him of a good friend. The views of the Reformers had spread in his diocese, and he was suspected of temporizing with them. He resigned his see (1550) in favour of the Dominican Egidio Foscherari, reserving to himself an annual pension and the patronage of livings. Julius III., at the instance of the duke of Milan, gave him (1553) the rich see of Novara (which he resigned in 1560 for the see of Albano) and sent him as nuncio to the diet of Augsburg (1555), from which he was immediately recalled by the death of Julius (March 23). In June 1557 Paul IV. imprisoned him in the castle of St Angelo (with others, including Pole, and Foscherari), on suspicion of Lutheran heresy. The prosecution entirely failed, and Morone might have had his liberty, but refused to

leave prison unless Paul IV. publicly acknowledged his innocence. He remained incarcerated till the pope's death (Aug. 18, 1559), and took part in the election of Pius IV. Ochino, in the twenty-eighth of his *Dialogi XXX.*, 1563 has a colloquy on the treatment of heretics, between Pius IV. and Morone, in which the latter maintains: "Errantes in viam revocandi, non occidendi." This really hits the position of Morone, a sincere Catholic, to whom persecution was abhorrent. He presided at the Tridentine Council from the 10th of April to the 4th of December 1563, and endeavoured to exercise a conciliatory influence. At the end of 1564 Foscherari died, and Morone was reinstated in the see of Modena. On the death of Pius IV. (1565) he came near to being elected pope. His last days were easy; he died at Rome on the 1st of December 1580, and was buried at S. Maria sopra Minerva. His writings comprise a few letters and orations. His career is that of a good man, struggling for the welfare of his Church against corruptions not essential to the system to which he was devoted.

See J. G. Frick, "De Joanne Morono," in J. G. Schelhorn's *Amenitates literarias*, vol. xii. (1730); G. Moroni, "Dizionario di erudizione (1847); N. Bernabei, *Vita del cardinale G. Moroni* (1885); M. Young, *Life and Times of Aonio Paleario* (1860); C. Bernath, in Hauck's *Realiencyklopädie* (1903). (A. Go.)

MORONI, GIAMBATTISTA (c. 1510-1578), Italian portrait-painter of the Venetian school, was born at Albino near Bergamo about 1510 (or perhaps a few years later), and became a pupil of Bonvicino named Il Moretto. Beyond the record of his works very few particulars regarding him have reached us. Titian, under whom also Moroni, while still very young, is said to have studied (but this appears hardly probable), had at any rate a high opinion of his powers; he said that Moroni made his portraits "living" or "actual" (*veri*). In truthful and animated portraiture Moroni ranks near Titian himself. His portraits do not indeed attain to a majestic monumental character; but they are full of straightforward life and individuality, with genuine unforced choice of attitude, and excellent texture and arrangement of draperies. There is a certain tendency to a violet-tint in the flesh, and the drawing and action of the hands are not first-rate. The earliest inscribed date discovered for any of his works is 1553. As leading samples may be mentioned—in the Uffizi Gallery, Florence the "Nobleman pointing to a Flame," inscribed "Et quid volo nisi ut ardeat?"; in the National Gallery, London, the portraits of a Tailor, a member of the Fenaroli family, Canon Ludovico de Terzi, and others; in the Berlin Gallery, his own portrait; and in Stafford House, the seated half-figure of the Jesuit Ercole Tasso, currently termed "Titian's Schoolmaster"—not as indicating any real connexion between the sitter and Titian, but only the consummate excellence of the work. Besides his portraits, Moroni painted, from youth to his latest days, the ordinary round of sacred compositions; but in these he falls below his master Il Moretto. One of the best is the "Coronation of the Virgin," in S. Alessandro della Croce, Bergamo; also in the cathedral of Verona, "SS Peter and Paul," and in the Brera of Milan, the "Assumption of the Virgin." Moroni was engaged upon a "Last Judgment," in the church of Corlago, when he died on the 5th of February 1578. (W. M. R.)

MOROSINI, a noble Venetian family, probably of Hungarian extraction, who gave many doges, statesmen, generals and admirals to the Venetian Republic, and cardinals to the Church. It first became prominent at the time of the emperor Otho II. owing to its rivalry with the Caloprini family, whom it subdued in subjugating by the end of the 10th century. Domenico Morosini (d. 1156), elected doge in 1148, waged war with success against the Dalmatian corsairs, recapturing Pola and other Istrian towns from them. Marino Morosini (d. 1252) was elected doge in 1249; Michele was doge from June 1382, until his death in October of the same year.

ANDREA MOROSINI (1538-1618) was a famous historian and was entrusted by the Venetian senate with the task of continuing Paolo Paruta's *Annali Veneti*, in Latin. His history of Venice was published by his brother in 1623 (Venice), and translated into

Italian by Senator Girolamo Molin (Venice, 1782). Among his other works are: *De Imprese ed spedizioni di terra santa, &c.* (Venice, 1627); *De iis quae vendita respublica ad Istriam oras gessit, &c.* (in the Corner-Duodo collection of MSS.); *De forma reipublicae venetae* in MS. in the Bibliothèque Nationale in Paris. His life has been written by Luigi Lollin (1623), by Niccolo Crasso (1621), and by Antonio Palazzoli (1620).

FRANCESCO MOROSINI (1618-1694) was one of the greatest captains of his time. As a young man he fought against the Turks and the pirates, and after signally distinguishing himself at the battle of Naxos in 1650 he was appointed commander-in-chief of the Venetian navy. He then conducted a series of successful campaigns against the Turks, but was recalled in consequence of the intrigues of his rival the Provveditore Antonio Barbaro (1661). But when Candia was attacked by a large force, under the terrible vizir Keuprili, Morosini was sent to relieve the fortress in 1667; the siege lasted eighteen months, but Morosini, in spite of his prodigies of valour, was forced to surrender to save the surviving inhabitants. He was tried, but acquitted of all blame, and on the renewal of the war with the Turkish Empire in 1684 he was again appointed commander-in-chief, and after several brilliant victories he reconquered the Peloponnese and Athens; on his return to Venice he was loaded with honours and given the title of "Peloponnesiaco." In 1688 he was elected doge, and in 1693 he took command of the Venetian forces against the Turks for the fourth time; the enemy which had been cruising in the archipelago withdrew at his approach, so great was the terror inspired by his name. While wintering at Napoli di Romania (Nauplia) he died on the 6th of January 1694.

BIBLIOGRAPHY.—Barbaro, *Genealogia delle famiglie patricie venete*, MS., clas. vii., cod. 927, in the Marcian Library, Venice; Cappellini, *Campidoglio veneto*, MS., clas. vii., cod. 17, ibid.; Romanin, *Storia documentata di Venezia*, also other general Venetian histories; G. Dalla Santa, *Due Lettere di umanisti veneziani a Paolo Morosini* (in *Nuovo archivio veneto*, xix. 92); G. Graziani's life of F. Morosini in Latin (Padua, 1698); A. Arrighi, *Vita di F. M.* (Padua, 1449). (See also VENICE.)

MORPETH, a market town and municipal and parliamentary borough of Northumberland, England, situated in a fine valley on the Wansbeck, 17½ m. N. of Newcastle by the North Eastern railway the junction of several branches with the main line. Pop. (1901), 6158. The Wansbeck winds round the town on the west, south and east, and a rivulet, the Cottingburn, bounds it on the north. The parish church of St Mary, a plain building of the 14th century, is situated on Kirk Hill, a short distance from the town. It has a good example of a Jesse window. Nothing remains of the old castle except the gateway. The valley of the Wansbeck above Morpeth is well wooded and very picturesque. By its side are fragments of Newminster Abbey, a wealthy foundation of the 12th century, occupied by monks from Fountains in Yorkshire; and Mitford, with its Norman and Early English church, and ruins of a Norman castle and a manor-house of the 17th century. To the north of Morpeth a good specimen of the peel tower of the 15th century is seen at Cockley Park. Industries of Morpeth include tanning, brewing, malting, iron and brass founding, and the manufacture of flannels, agricultural implements, and bricks and tiles. The parliamentary borough, within the Wansbeck division of the county, returns one member and extends 8 m. eastward to the coast, including the town of Blyth. Morpeth is governed by a mayor, 4 aldermen and 12 councillors. Area, 328 acres.

The manor of Morpeth is said to have been granted to William de Merlay soon after the Conquest and passed with the borough from his family to those of Graystock, Dacre and Howard, earls of Carlisle, with whom it remains. The town is a borough by prescription and grew up round the castle attributed to the above William de Merlay. About the end of the 12th century Roger de Merlay the younger granted the burgesses right to hold of him and his heirs "as freely as the charter of the king purposed which he held of the king by gift." Charles II. incorporated the town in 1662 under the government of two bailiffs who were chosen every year in the following manner: the bailiffs for the

time being chose two juries from whom the commonalty elected four burgesses, and from these four the steward of the lord of the manor appointed the bailiffs for the ensuing year. This was continued until the Municipal Reform Act of 1835. In 1200 a market on Wednesday and a fair on the Feast of St Mary Magdalene were granted to Roger de Merlay, and in 1285 the fair was extended for two days. The market rights still belong to the lord of the manor.

MORPHEUS, in Roman mythology, one of the sons of Somnus, the god of sleep. He was a personification, apparently invented by Ovid (*Metam.* xi. 635), of the power that calls up human shapes (*μορφαί*) of all kinds to the dreamer. His brothers Phobos and Phantasus assumed the forms of all kinds of animals and inanimate things.

MORPHINE, the chief alkaloid of opium (*q.v.*), to which the medicinal action of the former is mainly due. It is not used itself in medicine owing to its insolubility in water and ether. The preparations of morphine are incompatible with salts of iron, copper and mercury, also with lime water and alkaline earths and substances containing tannin. With ferric chloride it forms a deep red colour.

The preparations of morphine in the British Pharmacopoeia are as follow: from *Morphinae Hydrochloridum* are made five sub-preparations: (1) *Liquor Morphinæ Hydrochloridis*, strength 1% or about 4½ grs. of the hydrochloride to the fl. oz.; (2) *Suppositoria Morphinæ*, made with a basis of oil of theobroma, strength ¼ gr. of morphine hydrochloride in each; (3) *Tinctura Chloroformi et Morphinæ*, strength ¼ gr. in 10 minims; (4) *Trochiscus Morphinæ*, ¼ gr. in each; (5) *Trochiscus Morphinæ et Ipecacuanhæ*, strength ¼ gr. of morphine hydrochloride and ½ gr. ipecacuanha in each. From *Morphinae Acetas*, a white soluble amorphous powder, is made *Liquor Morphinæ Acetatis*, strength 1% or 4½ grs. of the acetate to 1 fl. oz. From *Morphinae Tartras*, a white crystalline powder, are prepared, *Injectio Morphinæ Hypodermica*, containing 5% of morphine tartrate, and *Liquor Morphinæ Tartratis*. *Morphinae Sulphatis* is not official in the British Pharmacopoeia but is official in the United States, the U.S.P. *Trochiscus Morphinæ et Ipecacuanhæ* and *Pulsis Morphinæ Compositus* (Tully's powder) being made from it. Hypodermic tablets of morphine sulphate either alone or combined with atropine are much in use. Various non-official preparations of morphine are in use, such as dionin, heroin, glycyphorm and peronin.

Therapeutics.—Morphine is an analgesic and hypnotic, relieving pain and producing deep sleep. As contrasted with opium it differs in being less astringing and constipating. Morphine is the greatest anodyne we possess, and no drug yet discovered equals it in pain-relieving power. The most frequent mode of administration is the hypodermic method, on account of the extreme rapidity with which it is absorbed. In pain due to violent sciatica relief and even permanent cure has been obtained by the injection of morphine directly into the muscle of the affected part, and in the treatment of renal and hepatic colic morphine given subcutaneously will relieve the acute pain consequent on the passage of biliary and urinary calculi. A violent paroxysm of asthma may be arrested by the administration of morphine subcutaneously, but the practice should not be continued, as there is great danger in a chronic disease that the patient may become the victim of morphinism. Morphine is recognized as one of the most useful drugs in the treatment of eclampsia, early injection often arresting the fits. In the cough of phthisis minute doses are of service, but in this particular disease morphine is frequently better replaced by codeine or by heroin, which checks irritable coughs without the narcotism following upon the administration of morphine. In bronchitis with profuse expectoration the use of morphine is particularly dangerous, as it is likely to check the cough so necessary for getting rid of the secretion, but in the converse condition it usefully allays the harassing cough by diminishing the excitability of the respiratory centre. In the dyspnoea of advanced valvular disease of the heart morphine relieves the distress and restlessness, and induces sleep. It should however be withheld if the heart has undergone fatty degeneration. Morphine is a sheet anchor in the later stages of cancer and other painful diseases, rendering the life of the patient one of comparative ease. If given in excess the drug is eliminated by way of the intestines and kidneys. It

is also excreted in the milk; hence the danger in the administration of large doses of morphine to nursing mothers.

Morphine-scolamine anaesthesia was introduced in 1902 by Steinbüchel. It has been used by some surgeons for the production of anaesthesia previous to the administration of ether or chloroform, but the use of the method is now more usually relegated to obstetric practice.

Morphinism (Morphinomania).—Chronic morphine poisoning is very common, as morphine taken constantly creates a habit. Once acquired the habit depends on the drug for a comfortable existence, and as the organism becomes quickly tolerant of the alkaloid the original dose no longer suffices. The total amount of morphine indulged in by the habitual morphinist may reach an astonishing figure; 15 grs. a day is said to be common, and some medical writers record quantities such as 60 to 70 grs. in the 24 hours in extreme cases. The early stages of morphinism are marked by moral degeneration; the patient seems to lose all sense of right and wrong, and will lie most plausibly and even thieve to obtain the drug; personal disorderliness, disregard of time, neglect of business and decline of family affection become soon evident. Physical symptoms also appear; the face assumes an earthy colour, the body wastes, constipation is usually present to an extreme degree, the secretions become arrested, loss of appetite and indigestion follow, and the mouth is parched. The nails become brittle and the skin dry, sterility shows itself in women and sexual impotence in men. While not directly causing death, morphinism so lowers the bodily powers that the patient is easily carried off by some intercurrent malady. The sudden withdrawal of the drug from a morphine habitué is followed by a train of alarming symptoms. As the time approaches for the usual dose there is marked restlessness, followed by excitement and later by chills, pallor, sinking, nausea, with perhaps vomiting and diarrhoea. Horrible mental depression and melancholia are present, and there may be hallucinations of vision and hearing passing into violent delirium. At this stage collapse may set in, the patient become faint, the limbs twitch, the radial pulse become imperceptible, and unconsciousness supervene. The condition may even go on to a fatal result should morphine be continuously withheld, but injection of even a small quantity of morphine causes these symptoms to cease abruptly. The sudden withdrawal of morphine should therefore never be practised with takers of large quantities of the drug, but gradually diminishing doses given by the physician should be substituted. For the successful treatment of morphinism, complete isolation of the patient is necessary in a place where he is supervised so that he can obtain no morphine. Isolation in a home is far the best, as friends may give way to entreaties and servants be bribed. The "tapering off" of the dose is the best method. Absence from home and strict supervision lasting over a long period, usually a year, are necessary to prevent relapse. The lowered bodily health requires to be built up, and a long sea voyage under adequate supervision is usually recommended.

MORPHOLOGY, (Gr. *μορφή*, form), a term introduced by Goethe to denote in biology the study of the unity of type in organic form (for which the Linnaean term "Metamorphosis" had formerly been employed). It now usually covers the entire science of organic form. There are numerous restricted senses of the term in various sciences, but here we shall deal with it as a substantive side of zoology and botany.

Historical Outline.—If we disregard such vague likenesses as those expressed in the popular classifications of plants by size into herbs, shrubs and trees, or of terrestrial animals by habit into beasts and creeping things, the history of morphology begins with Aristotle. Founder of comparative anatomy and taxonomy, he established eight great divisions (to which are appended certain minor groups)—*Viviparous Quadrupeds*, *Birds*, *Oviparous Quadrupeds* and *Apoda*, *Fishes*, *Malakia*, *Malacostraca*, *Entoma*, and *Ostracodermata*—distinguishing the first four groups as *Enaima* ("with blood") from the remaining four as *Anaima* ("bloodless"). In these two divisions we recognize the Vertebrata and Invertebrata of J. B. P. A. Lamarck, the first four groups corresponding with the Mammals, Birds, Reptiles, Fishes, whilst the others agree more loosely with the Cephalopods, Crustacea, Insecta, and Echinoderms with Mollusca other than the Cephalopods. Far from committing the mistake attributed to him of reckoning Bats as Birds, or Cetaceans as Fishes, he discerned the true affinities of both, and erected the latter into a special *γένος* beside the Viviparous Quadrupeds, more on account of their absence of limbs than of their aquatic habit. Not only is his method inductive, but his groups founded on the aggregate of known characters, and he foreshadows such generalizations as those of the correlation of organs, and of

the progress of development from a general to a special form afterwards established by G. L. Cuvier and K. E. von Baer respectively. In the correspondence he suggests between the scales of Fishes and the feathers of Birds, or in that hinted at between the fins of Fishes and the limbs of Quadrupeds, the idea of homology is nascent; and from the compilation of his disciple Nicolaus of Damascus, who regards leaves as imperfectly developed fruits, he seems almost to have anticipated the idea of the metamorphosis of plants. Even after the reappearance of Aristotle's works in the 13th century, little can be recorded but revivals of his conclusions. Monographs on groups of plants and animals frequently appeared, those of P. Belon on Birds and G. Rondelet on Fishes being among the earliest; and in the former of these (1555) we find a comparison of the skeletons of Bird and Man in the same posture and as nearly as possible bone for bone—an idea which, despite the contemporaneous renaissance of human anatomy initiated by Vesalius, disappeared for centuries, unappreciated save by the surgeon Ambroise Paré. B. Palissy, like Leonardo da Vinci before him, discerned the true nature of fossils; and such flashes of insight continued to appear from time to time during the 17th century. Thus, Joachim Jung recognized "the distinction between root and stem, the difference between leaves and foliaceous branches, the transition from the ordinary leaves to the *folia florifera*," and W. Harvey anticipated the generalizations of modern embryology by his researches on development and his theory of epigenesis.

The encyclopaedic period of which Gesner is the highest representative was continued by Aldrovandi and others in the 17th century; but, aided by the Baconian movement, then influencing all scientific minds, it developed into one of genuinely systematic aim. At this stage of progress the most important part was taken by John Ray, whose classificatory labours among plants and animals were crowned with success. He first expelled the fabulous monsters and prodigies of which the encyclopaedists had handed on the tradition from medieval times, and succeeded, particularly among plants, in distinguishing many natural groups, for which his own terms sometimes survive—*e.g.* Dicotyledons and Monocotyledons, Umbelliferae and Leguminosae. The true precursor of Linnaeus, he introduced the idea of *species* in natural history, and reformed the practice of definition and terminology. Of the works which followed up Ray's systematic labours, none can be even named until we come to those of his great successor Linnaeus, whose grasp of logical method and lucidity of thought and expression enabled him to reform and reorganize the whole labours of his predecessors into a compact and definite "systema naturae." The very genius of order, he established modern taxonomy, not only by the introduction of the binomial nomenclature and the renovation of descriptive terminology and method, but by the subordination of the species under the successive higher categories of genus, order and class, so reconciling the analytic and synthetic tendencies of his predecessors. Although the classification of plants by the number of their essential organs is highly artificial, it must be remembered that this artificiality is after all only a question of degree, and that he not only distinctly recognized its provisional character but collected and extended those fragments of the natural system with which A. de Jussieu soon afterwards began to build. His classification of animals, too, was largely natural, and, though on the whole he lent his authority to maintain the notion of three kingdoms of nature, he at least at one time discerned the fundamental unity of animals and vegetables, and united them in opposition to the non-living world as *Organisata*. At the same time he was still far more a scholastic naturalist than a modern investigator.

While the artificial system was at the zenith of its usefulness, Bernard de Jussieu was arranging his gardens on the lines afforded by the fragmentary natural system of Linnaeus. His ideas were elaborated by his nephew Antoine de Jussieu, who published diagnoses of the natural orders, so giving the system its modern character. Its subsequent elaboration and definite establishment are due mainly to the labours of Pyrame de

Candolle and Robert Brown. The former concentrated his own long life and that of his son upon a new "systema naturae," the colossal *Prodromus systematis naturalis* (20 vols., 1818-1873), in which 80,000 species were described and arranged. Meanwhile the penetrative genius of Brown enabled him to unravel such structural complexities as those of Conifers and Cycads, Orchids and Proteaceae, thus demonstrating the possibility of ascertaining the systematic position of even the most highly modified floral types. Both Candolle and Brown were thus no mere systematists, but genuine morphologists of the modern school.

The labours of Bernard and Antoine de Jussieu initiated a parallel advance in zoology, the joint memoir on the classification of mammals with which Cuvier and Geoffroy St-Hilaire almost began their career receiving its dominant impulse from the "genera" of Antoine. Cuvier's works correspond in zoology to those of the whole period from the Jussieus to Brown, and epitomize the results of that line of advance. Although in some respects preceded by A. von Haller and J. Hunter, who compared, though mainly with physiological aim, the same parts in different organisms, and much more distinctly by Vicq d'Azyr, the only real comparative anatomist of the 18th century, he opens the era of detailed anatomical research united with exact comparison and clear generalization. The *Règne animal* (1817) and the theory of types (vertebrate, molluscan, articulate, and radiate) are the results of this union of analysis and synthesis and mark the reconstitution of taxonomy on a new basis, henceforth to be no longer a matter of superficial description and nomenclature but a complete expression of structural resemblances and differences. In Germany, L. H. Bojanus, J. F. Meckel, C. T. E. von Siebold and Johannes Müller, with his many pupils, carried on the work; in France, too, a succession of brilliant anatomists, such as A. De Quatrefoiges, A. Milne-Edwards and H. de Lacaze-Duthiers, were his intellectual heirs; and in England he was being admirably represented by Sir R. Owen.

It is now necessary to return to Linnaeus, whose more speculative writings contain, though encumbered by fantastic hypotheses, the idea of floral metamorphosis. About the same time, and quite independently, C. F. Wolff, the embryologist, stated the same theory with greater clearness, for the first time distinctly reducing the plant to an axis bearing appendages—the vegetative leaves—which become metamorphosed into bud-scales or floral parts through diminution of vegetative force. Thirty years later the same view was again independently developed by Goethe in his now well-known pamphlet (*Versuch die Metamorphose der Pflansen zu erklären*, Gotha, 1790). In this brilliant essay the doctrine of the fundamental unity of floral and foliar parts is clearly enunciated, and supported by arguments from anatomy, development and teratology. All the organs of a plant are thus modifications of one fundamental organ—the leaf—and all plants are in like manner to be viewed as modifications of a common type—the *Urpflanze*. Whether, as some historians hold, his "Urpflanze" was a mere ideal archetype, bringing forth as its fruit the innumerable metaphysical abstractions of the Naturphilosophie, and leading his countrymen into all the extravagances of that system; or whether, as E. H. Haeckel maintains, it represented a concrete ancestral form, so anticipating the view of modern evolutionists, it is certain that to him F. W. S. von Schelling was indebted for the foundation upon which he erected his philosophic edifice, as also that Goethe shared the same ideas. It must be remembered that he lived and made progress for forty years after the publication of this essay, that he was familiar with the whole scientific movement, and warmly sympathized with the evolutionary views of Lamarck and Geoffroy St-Hilaire; it is not therefore to be wondered at that his writings should furnish evidence in favour of each and every interpretation of them. His other morphological labours must not be forgotten. Independently of Vicq d'Azyr, he discovered the human premaxillary bone; independently of L. Oken, he proposed the vertebral theory of the skull; and before S. C. Savigny, he discerned that the jaws of insects were the limbs of the head.

In 1813 A. P. de Candolle published his *Théorie élémentaire de la botanique*, which he developed into the classic *Organographie végétale* (1827). He established his theory of symmetry, reducing all flowers to "symmetrical" groupings of appendages on an axis and accounting for their various forms by cohesion and adhesion, by arrested or excessive development. The next advance was the investigation by W. P. Schimper and A. Braun of *phyllotaxis*—the ascending spiral arrangement of foliar and floral organs—thus further demonstrating their essential unity.

The term *morphologie* was first introduced by Goethe in 1817, in a subsequent essay (*Zur Naturwissenschaft überhaupt, besonders zur Morphologie*). It did not come into use in botany until its popularization by Auguste de St-Hilaire in his *Morphologie végétale* (1841), and in zoology until later, although De Blainville, who also first employed the term *type*, had treated the external forms of animals under "morphologie." Though the Naturphilosophie of Schelling and its countless modifications by his followers, its mystic theories of "polarization" and the like, its apparatus of assumption and abstraction, hypothesis and metaphor, cannot here be discussed, its undoubted services must not be forgotten, since it stimulated innumerable reflective minds to the earnest study of natural science, gave a powerful impulse to the study of comparative anatomy and vindicated the claims of philosophic synthesis over those of analytic empiricism. Among its many adherents, some are of more distinctly theological type; others metaphysical, others mystical or poetic, others, again, more especially scientific; but its most typical and picturesque figure is Lorenz Oken, who epitomizes alike the best and the worst features of the school, and among whose innumerable pseudo-morphological fruits there occasionally occurred suggestions of the greatest fruitfulness—notably, for instance, the independent statement of the vertebral theory of the skull.

By far the most distinguished anatomist of the transcendental school is Geoffroy St-Hilaire, who being comparatively free from the extravagances of Oken, and uniting a depth of morphological insight scarcely inferior to that of Goethe with greater knowledge of facts and far wider influence and reputation in the scientific world, had greater influence on the progress of science than either. He started from the same studies of anatomical detail as Cuvier, but, influenced by Buffon's view of unity of plan and by the evolutionary doctrines of Lamarck, diverged into new lines, and again reached that idea of serial homology of which we have so frequently noted the independent origin. His greatest work, the *Philosophie anatomique* (1818-1823), contains his principal doctrines. These are: (1) the theory of unity of organic composition, identical in spirit with that of Goethe; (2) the theory of analogues, according to which the same parts, differing only in form and in degree of development, should occur in all animals; (3) the "principe des connexions," by which similar parts occur everywhere in similar relative positions; and (4) the "principe du balancement des organes," upon which he founded the study of teratology, and according to which the high development of one organ is allied to diminution of another. The advance in morphological theory is here obvious; unfortunately, however, in eager pursuit of often deceptive homologies, he wandered into the transcendentalism of the Naturphilosophie, and seems utterly to have failed to appreciate either the type theory of Cuvier or the discoveries of Von Baer. He defended Buffon's and Bonnet's earlier view of unity of plan in nature; and the controversy reached its climax in 1830, when he maintained the unity of structure in Cephalopods and Vertebrates against Cuvier before the Academy of Sciences. On the point of fact he was of course utterly defeated; the type theory was thenceforward fully accepted and the Naturphilosophie received its death-blow. Such was the popular view; only a few, like the aged Goethe, whose last literary effort was a masterly critique of the controversy, discerned that the very reverse interpretation was the deeper and essential one, that a veritable "scientific revolution" was in progress, and that the supremacy of homological and synthetic over descriptive and analytic studies was

thenceforward assured. The irreconcilable feud between the two leaders really involved a reconciliation for their followers; theories of homological anatomy had thenceforward to be strictly subjected to anatomical and embryological verification, while anatomy and embryology acquired a homological aim. This union of the solid matter and rigorous method of Cuvier with the generalizing spirit and philosophic aims of Geoffroy is well illustrated in the works of Owen.

The further evolution of the idea of homology is sketched below, while the extent and rapidity of the subsequent progress of the knowledge of all the structural aspects of plants and animals alike make a historical survey impossible up to the appearance of the *Origin of Species* (1859). The needful solution was effected by Darwin. The "Urplanze" of Goethe, the types of Cuvier, and the like, at once became intelligible as schematic representations of ancestral organisms, which in various and varying environments, have undergone differentiation into the vast multitude of existing forms. All the enigmas of structure become resolved; "representative" and "aberrant," "progressive" and "degraded," "synthetic" and "isolated," "persistent" and "prophetic" types no longer baffle comprehension; conformity to type represented by differentiated or rudimentary organs in one organism is no longer contradicted by their entire disappearance in its near allies, while systematist and morphologist become related simply as specialist and generalizer, all through this escape from the Linnaean dogma of the fixity of species. The phenomena of individual development receive interpretation in terms of ancestral history; and embryology thus becomes divided into ontogeny and phylogeny—the latter, too, coming into intimate relation with palaeontology—while classification seeks henceforth the reconstruction of the genealogical tree. All these results were clearly developed in Haeckel's *Generelle Morphologie* (1866), while the valuable contemporaneous *Principles of Biology* of Herbert Spencer also gave special attention to the relation of morphology to physiology.

Individuality.—The problem no subject in the whole range of biology has been more extensively discussed than that of the nature of organic individuality. The history of the controversy is of interest, since it is leading up to solid results it serves, perhaps better than any other case, to illustrate the slow emergence of the natural sciences from the influence of scholastic thought. Starting from the obvious unity and indivisibility of Man and other higher animals, and adopting some definition such as that of C. F. B. Mirbel, "Tout être organisé, complet dans ses parties, distinct et séparé des autres êtres, est un individu," it was attempted times without number to discover the same conception elsewhere in nature, or rather to impose it upon all other beings, plants and animals alike. The results of different inquirers were of course utterly discrepant. It seemed easy and natural to identify a tree or herb corresponding to the individual animal, yet difficulties at once arose. Many apparently distinct plants may arise from a common root, or a single plant may be decomposed into branches, twigs, shoots, buds or even leaves, all often capable of separate existence. These, again, are decomposable into tissues and cells, the cells into nucleus, &c., and ultimately into protoplasmic molecules, these finally into atoms—the inquiry thus passing outside organic nature altogether and meeting the old dispute as to the ultimate divisibility of matter. In short, as Haeckel remarks, scarcely any part of the plant can be named which has not been taken by some one for the individual. It is necessary, therefore, briefly to notice some of the principal works on the subject, and these may conveniently be taken in descending order.

While H. Cassini practically agreed with Mirbel in attempting to regard separate plants as individuals, the widest interpretation of the individual is that of G. Gallesio (1816), who proposed to regard as an individual the entire product of a single seed, alike whether this developed into a uni-axial plant extended continuously like a banyan, or multiplied asexually by natural or artificial means like the weeping-willow or the Canadian pondweed, of each of which, on this view, there is only a single individual in Britain, happily discontinuous.

At once the oldest and most frequently maintained view is that which regards the bud or shoot consisting of a single axis with appendages as the plant-individual, of which the tree represents a colony, like a branched hydroid polyp. This conception, often attributed to Aristotle, but apparently without foundation, appears distinctly in the writings of Hippocrates and Theophrastus—the latter saying, "The bud grows on the tree like a plant in the ground." The aphorism of Linnaeus, "Gemmae totidem herbae," is well known; and in this view C. F. Wolf and Humboldt concurred, while Erasmus Darwin supported it by an appeal to the facts of anatomy

and development. The most influential advocate of the bud theory during the first half of the 19th century was, however, Du Petit-Thouars, who, although starting much as usual with a "principe unique d'existence," supported his theory on extensive though largely incorrect observations on stem structure and growth. For him the tree is a colony of *phytons*, each being a bud with its axillary leaf and fraction of the stem and root. Passing over numerous minor authors, we come to the central work of Alex. Braun (1853), in which, as Sachs has clearly pointed out, the illegitimate combination of Naturphilosophie with inductive morphology reaches its extreme. He views, however, all preceding theories, admits the difficulty of fixing upon any one, and, in all respects, as far as possible considered, is rather a *didandum* than an *individuum*, and proposed as a compromise, or indeed as a partial cutting of the knot, the adoption of the shoot, as the morphological individual, comparable to an animal, especially because, unlike the cell, leaf, &c., it includes all the representative characters of the species. Darwin and Spencer on the whole also accept the bud or shoot as at any rate the most definite individual.

The theory of metamorphosis naturally led Goethe, Oken and others to regard the leaf as the individual, while Johannes Müller, J. J. S. Streenstrup and others adopted the same view on various physiological grounds. C. Gausichaud elaborated a theory intermediate between this view and that of Du Petit-Thouars, according to which the plant was built up of individuals, each consisting of a leaf with its subjacent internode of stem, which was regarded as the leaf-base, and this was supported by Edward Forbes and others, while the nominally converse view—that of the leaf as a mere outward expansion of the stem-segment—was proposed by C. F. Hochstetter.

Though sundry attempts at identifying various tissues, such as the fibro-vascular bundles, as the constituent individuals may be passed over, those associated with the cell theory are of great importance. Schwann decided in favour of the cell and regarded the plant as cell-community, that of whom the elements were like the bees of a swarm—a view virtually concurred in by all substantial respects by M. Schleiden, R. Virchow and other founders of the cell theory. Yet, although the structure and functions of the plant are ultimately and specially cellular, it is impossible to ignore the fact that, save in the very lowest organisms, these are subordinated and differentiated into larger aggregates, and form virtually but the bricks of a building, and hence the later theories outlined above. Of attempts to find the individual in the nucleus or the protoplasm granules it is unnecessary to speak further.

So far the theories of absolute individuality. The conception of relative individuality was clearly expressed by Alphonse de Candolle and Schleiden, both of whom, in the first instance, regarded the multi-axial plant as forming three successive and subordinated categories. K. W. von Nägeli too recognized not only the necessity of establishing such a series (cell, organ, bud, leafy axis, multi-axial plant) but the distinction between morphological and physiological individualities afterwards enunciated by Haeckel.

Passing over the difficulties which arise even among the Protozoa we find that a similar controversy (fully chronicled in Haeckel's *Kalkschwämme*) has raged over the individuality of sponges. While the older observers were content to regard each sponge-mass as an individual, a view in which J. N. Lieberkühn and other monographers substantially concurred, the application of the microscope led to the view suggested by James Clark, and stoutly supported by Sillie Kent, that the sponge is a city of amoeboid or infusorian individuals. H. J. Carter looked upon the separate ampullaceous sacs as the true individuals, while others, defining the individual by the possession of a single exhalant aperture, distinguish sponges into solitary and social.

For the higher animals the problem, though perhaps really even more difficult, is less prominent. As Haeckel points out, the earlier discussions and even the comparatively late essay of Johannes Müller take an almost purely psychological or at least a physiological point of view; and the morphological aspect of the inquiry only came forward when the study of much lower forms, such as *Cestoid worms* (see *PLATELMA*) or *Siphonophores* (see *HYDROZOA*), had raised the difficulties with which botanists had so long been familiar. With the rapid progress of embryology, too, arose new problems; and in 1842 Streenstrup introduced the conception of an "alternation of generations" as a mode of origin of distinct individuals by two methods, for him fundamentally similar, the sexual from impregnated females and the asexual from unimpregnated "nurses"—a view adopted by Edward Forbes and many other naturalists, but keenly criticized by W. B. Carpenter and T. H. Huxley. In R. Leuckart's remarkable essay on polymorphism (1853) the Siphonophora were analysed into colonies, and their varied organs shown to be morphologically equivalent, while the alternate generations of Streenstrup were reduced to a case of polymorphism in development. Leuckart further partly distinguished individuals of different orders, as well as between morphological and physiological individuals.

In 1852 Huxley, starting from such an undoubted homology as that of the egg-producing process of *Hydra* with a free-swimming *Medusoid*, pointed out that the title of individual, if applied to the latter, must logically be due to the former also, and avoided this confusion between organ and individual by defining the individual

animal, as Gallesio had done the plant, as the entire product of an impregnated ovum—the swarm of Aphides or free Medusae which in this way might belong to a single individual being termed *Zooids*.

In Carus's *System of Animal Morphology* (1853) another theory was propounded, but the problem then seems to have fallen into abeyance until 1865, when it formed the subject of a prolonged and fruitful discussion in the *Principles of Biology*. Adopting the cell (defined as an aggregate of the lowest order, itself formed of physiological units) as the morphological unit, H. Spencer points out that these may either exist independently, or gradually exhibit unions into aggregates of the second order, like the lower Algae, of which the individuality may be more or less pronounced. The union of such secondary aggregates or compound units into individuals of a yet higher order is then traced through such intermediate forms as are represented by the higher seaweeds or the liverworts, from the thallus of which the axes and appendages of Monocotyledons and Dicotyledons are ingeniously derived. The shoot of a flowering plant is thus an aggregate of the third order; it branches into an aggregate of the fourth or higher order, and finally as a tree "acquires a degree of composition too complex to be any longer defined." Proceeding to animals, the same method is applied. The Protozoa are aggregates of the first order. These, like plants, exhibit transitions, of which Radiolarians, Foraminifera and sponges are taken as examples, to such definite compound wholes as *Hydra*; and such secondary aggregates multiply by gemmation into permanent aggregates of the third order, which may exhibit all degrees of integration up to that of the Siphonophora into individuals of a yet higher order, which are almost lost in that of the aggregate form. The whole series of articulated animals are now interpreted as more or less integrated aggregates of the third order, of which the lower Annelids are the less developed forms, the Arthropods the more highly integrated and individualized. Molluscs and vertebrates are regarded as aggregates of the second order.

In 1866 appeared a morphological classic, the *Generelle Morphologie* of Haeckel. Here pure morphology is distinguished into two sub-science—the first purely structural, *tectology*, which regards the organism as composed of organic individuals of different orders; the second essentially stereometric, *promorphology*. To tectology, defined as the science of organic individuality, a large section of the work is devoted. Dismissing the theory of absolute individuality as a metaphysical figment, and starting from the view of Schlegel, De Candolle and others, he divides several successive categories of relative individuals, he distinguishes more clearly than heretofore the physiological individual (or *bion*), characterized by definiteness and independence of function, from the morphological individual (or *morphon*), characterized similarly by definiteness of form; of the latter he establishes six categories, as follows:—

1. *Plastides* (cytodes and cells), or elementary organisms.
2. *Organs* (cell-stocks or cell-fusions), simple or homoplastic organs (tissues), or heteroplastic organs. Organ-systems, organ-apparatuses.
3. *Antimeres* (opposite or symmetrical or homotypic parts), e.g. rays of radiate animals, "halves of bilaterally symmetrical animals."
4. *Metameres* (successive or homodynamous parts), e.g. stem-segments of Phanerogams, segments or zoonites of Annelids or vertebrates.
5. *Personae*, shoots or buds of plants, polyps of Coelenterates, &c., "individuals" in the narrowest sense among the higher animals.
6. *Corms* (stocks or colonies), e.g. trees, chains of Salpae, polyp-stocks, &c.

In his subsequent monograph on calcareous sponges, and in a final paper, he somewhat modifies these categories by substituting one category of extreme comprehensiveness, that of the *idorgan*, in place of the three separate orders of organs, antimeres and metameres. The *idorgan* (of course clearly distinguished from the physiological organ or *biorgan*) is finally defined as a morphological unit consisting of two or more plastids, which does not possess the positive character of the person or stock. These are distinguished into *homoplasts* or *homoo-organs* and *aloplasts* or *alloe-organs*, the former including, as subdivisions, plastid-aggregates and plastid-fusions, the latter idomers, antimeres and metameres. The former definition of the term *antimere*, as denoting at once each separate ray of a radiate, or the right and left halves of a bilaterally symmetrical animal, is corrected by terming each ray a *paramere*, and its symmetrical halves the antimeres. Thus an ordinary Medusoid has four parameres and eight antimeres, a starfish five and ten. The conception of the *persona* is largely modified, not only by withdrawing the comparison of the animal with the vegetable shoot and by omitting the antimere and metamere as necessary constituents, but by taking of the central embryonic form of all the Metazoa—the gastrula (fig. 1) and its assumed ancestral representative, the gastraea—as the simplest and oldest form of *persona*. The different morphological stages to which it may attain are classified into three series: (1) Monaxial inarticulate *personae*, i.e. uniaxial and unsegmented without antimeres or metameres, as in sponges or lowest Hydroids; (2) Stauraxial inarticulate *personae* with antimeres, but without metameres, e.g. coral, medusa, tubellarian, trematode, bryozoan; (3) Stauraxial articulate *personae* with antimeres and

metameres, e.g. annelids, arthropods, vertebrates. The colonies of protozoa are mere *idorgans*. True *corms*, composed of united *personae*, occur only among sponges, hydroids, siphonophores, corals, bryozoa, tunicates

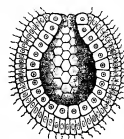

(After Haeckel.)

FIG. 1.—Gastrula in optical section, showing primitive opening and digestive cavity (blastopore and arch-enteron), as also outer and inner layers, ectoderm and endoderm.

reached the highest grade of morphological individuality proper to it as a representative of, e.g. its species; (2) the "virtual bion or potential physiological individual," including any incompletely developed form of the former from the ovum upwards; and (3) the "partial bion or apparent physiological individual," such fragments of the actual or virtual bion as may possess temporary independence without reproducing the species—this latter category having, however, inferior importance.

Haeckel's theory, indeed in its earlier form, has been adopted by C. Gegenbaur and other morphologists, also in its later form by G. Jäger, who, however, rejects the category of *idorgan* on the ground of the general morphological principle that every natural body which carries on any chemical changes with its environment becomes differentiated into more or less concentric layers; but the subject, especially as far as animals are concerned, was again discussed in a large work by E. Perrier. Starting from the cell or plastid, he terms a permanent colony a *méride*, and these may remain isolated like *Sagitta* or *Rotifer*, or may multiply by gemmation to form higher aggregates which he terms *zoïdes*. Such *zoïdes* may be irregular, radiate or linear aggregates, of which the two former classes especially are termed *demes*. The organ—Haeckel's *idorgan*—is excluded, since tissues and organs result from division of labour in the anatomical elements of the *mérides*, and so have only a secondary individuality, "carefully to be distinguished from the individuality of those parts whose direct grouping has formed the organism, and which live still, or have lived, isolated from one another." Perrier further points out that the most undifferentiated colonies are sessile, as sponges and corals, while a free state of existence is associated with the concentration and integration of the colony into an individual of a higher order.

So far the various theories of the subject; detailed criticism is impossible, but some synthesis and reconciliation must be attempted. Starting from the cell as the morphological unit, we find these forming homogeneous aggregates in some Protozoa and in the early development of the ovum. But integration into a whole, not merely aggregation into a mass, is essential to the idea of individuality; the earliest secondary unit, therefore, is the gastrula or *méride*. This stage is permanently represented by an unbranched hydroid or sponge or by a planarian. These secondary units may, however, form aggregates of position to which, in most sponges, indefinitely branched as in the hydroids and actinoids, or linear as in such planarians as *Caenocela*. Such aggregations, colonies or demes, not being aggregated, do not fully reach individuality of the third order. This is attained, however, for the branched series by such forms as Siphonophores among Hydrozoa, or *Renilla* or *Penantula* among Actinozoa; for linear aggregates again by the higher worms, and still more fully by arthropods and vertebrates. Aggregates of a yet higher order may occur, though rarely. A longitudinally dividing *Nais* or laterally branched *Syllis* are obviously aggregates of these tertiary units, which, on Haeckel's view, become integrated in the Echinoderm, which would thus reach a complete individuality of the fourth order. A chain of Salps or a colony of *Pyrosoma* exhibits an approximation to the same rank, which is more nearly obtained by a radiate group, *Beryllia*, or linear as their central cloaca, while the entire colony of such an ascidian would represent the individual of the fifth order in its incipient and unintegrated state—these and the preceding intermediate forms being, of course, readily intelligible, and indeed, as Spencer has shown, inevitable on the theory of evolution.

The exclusion of tissues and organs from rank in this series is thus seen to necessarily follow. Ectoderm and endoderm cannot exist alone; they and the organs into which they differentiate

the basal polygon is no longer regular but amphihcct (*ambipyrso* = double-edged). Such a polygon has an even number of sides, and can be divided into symmetrical halves by each of two planes intersecting at right angles in the middle point, and thus dividing the whole figure into four congruent polygons.



FIG. 5.—Starfish, an example of *Heteropla homostaura*. Ground-form a regular single pyramid of five sides.

The longer of these axes may be termed lateral, the shorter the equatorial or dorso-ventral; and these two axes, along with the main axes, always define the three dimensions of space. Ctenophores (fig. 6) furnish examples of eight-sided amphihcct pyramids, some Madreporic Corals of six-sided, Crucifers, some Medusae, and Cestodes of four-sided amphihcct pyramids.

In these forms the poles of the dorso-ventral and lateral axes are similar, and, as in the preceding Monaxonia and Stauraxonia, the centre of the body is defined by a line; and they are therefore termed *Centroxonia*, while the Protaxonia which are defined by their central point are called *Centrostigma*. There are, however, other forms, and these the most complicated, in which the poles of at

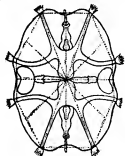

FIG. 6.—Ctenophore (*Eucharis*). Ground-form an eight-sided double amphihcct pyramid.

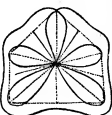

FIG. 7.—*Spatangus*. Ground form a five-sided half amphihcct pyramid.

least the dorso-ventral axis are unlike, and in which the body is thus defined not with reference to a line but to a median plane, and these have accordingly received the name of *Centropipeda*. Their ground-form is a polygon with an even number of sides, which can only be divided into two symmetrical halves by the one median plane. It can be obtained by halving an amphihcct pyramid of double the number of sides, and is consequently termed a half amphihcct pyramid (fig. 7). The whole amphihcct pyramid may be most conveniently obtained by the reduplication of the ground-form as if in a mirror. Of half amphihcct pyramids there are again two forms, termed by Haeckel *Ambipileura* and *Zygo-pleura*, the former including the "bilaterally symmetrical" or irregularly radiate forms of previous authors, such as *Spatangus*, *Viola*, *Orchis*, while the *Zygo-pleura* include forms bilaterally symmetrical in the strictest sense, in which not more than two radial planes, and these at right angles to each other, are present. The stereometric ground-form is a half rhombic pyramid. Haeckel again divides these, according to the number of antimeres, into *Tetrapleura* and *Dipleura*.

Promorphology has thus shown that the reigning dogma of the fundamental difference of organic and mineral forms is false, and that a crystallography of organic forms is possible—the form of the cell or the cell-aggregate differing from the crystal merely by its more or less viscous state of aggregation, its inherited peculiarities, and its greater adaptability to the environment. The classification into *bilateral* and *radiate* forms which usually does duty for more precise promorphological conceptions must be abandoned, as hopelessly confusing essentially different forms, or at least must be rigidly restricted—the term radial to regular and double pyramids, the term bilateral to the *Centropipeda* if not indeed to diplear forms. Similarly the topographical and relative terms, anterior and posterior, upper and under, horizontal and vertical, must be superseded by the terms above applied to the axes and their poles, oral and aboral, dorsal and ventral, right and left.

Nature of Morphological Changes.—The main forms of organic structure being analysed and classified and their stage of individuality being ascertained, the question next arises, by what morphological changes have they arisen, and into what categories can these modes of differentiation be grouped? They at first sight seem innumerable, yet in reality are few. Going somewhat vaguely generalized them for the flower as ascending and descending metamorphosis, expansion and contraction of organs, &c.; but the first attempt at careful enumeration seems to be that of Auguste de St Hilaire, who recognized degrees of development, adherences, excesses of production or "dédoublements," metamorphosis and displacement of organs. Subsequent authors have variously treated the subject; thus Asa Gray enumerates as modifications of the

flower—coalescence, adnation, irregularity, abortion, non-alteration or anteposition, multiplication, enation, unusual development of the axis, and other morphological modifications connected with fertilization. These are obviously too numerous, as may be best shown by a single comparison with the view of an animal morphologist. Thus Huxley, in discussing the arrangement of the Vertebrata, recognizes only three processes of modification, not only in the ancestral evolution of the *Equidae*, but in the individual development of animals generally; these are (1) excess of development of some parts in relation to others, (2) partial or complete suppression of certain parts, (3) coalescence of parts originally distinct." The particular form of excess of development which results in the repetition of parts, and the morphological changes due to partial or complete fusion of such repeated parts receive special treatment in the article METAMERISM.

Nature of Morphological Correspondence.—Categories of Homology.

—To indicate all the steps by which the idea of morphological resemblance has been distinguished from that of physiological would be to examine the whole history of morphology; it must suffice to discuss the terminology of the subject which has, as ever, served not only as an index but as an engine of progress. For these two distinct forms of resemblance the terms *homology* and *analogy* gradually became specialized, and were finally established and clearly defined by Owen in 1843—the former as the same organ in different animals under every variety of form and function (e.g. fore-limbs of *Draco volans* and wings of Bird); the second as a part or organ in one animal which has the same function as another part or organ in a different animal (e.g. parachute of *Draco* and wings of Bird)." He further distinguishes three kinds of homology: (1) *special*, being "that above defined, namely, the correspondence of a part or organ determined by its relative position and connections with a part or organ in a different animal, the determination of which homology indicates that such animals are constituted on a common type," e.g. basilar process of human occipital with basi-occipital of fish; (2) *general*, that "higher relation in which a part or series of parts stands to the fundamental or general type, involving a knowledge of the type on which the group in question is constituted," e.g. the same human bone and centrum of the last cranial vertebra; (3) *serial* homology, "representative or repetitive relation in the segments of the same skeleton" (demonstrated when general and special homologies have been determined); thus usually the basi-occipital and basi-sphenoid are "homotypes." These terms were henceforth accepted by naturalists; but the criterion of analogy and homology became for L. Agassiz and other embryologists developmental as well as comparative, reference to the ideal archetype becoming less and less frequent.

Passing to the discussion of L. Agassiz and Bronn, of which the latter is criticized and partly superseded by Haeckel, we find the last-named (1) placing serial under general homology; (2) erecting categories of homology partially corresponding to those of individuality—(a) *homotypy* (of antimeres), hence distinct from that of Owen, (b) *homodynamy* (of metameres), (c) *homonomy* (of parts arranged on transverse axes); (3) defining special homology in terms of identity of embryonic origin. In 1870 this latter point was more fully insisted upon by Ray Lankester, who, decomposing it into two others, proposed to supersede the term homology by *homogeny*, being the correspondence of common descent, and *homoplasy*, denoting any superinduced correspondence of position and structure in parts embryonically distinct. Thus the fore-limb of a mammal is *homogeneous* with that of a bird, but the right and left ventricles of the heart in both are only *homoplastic*, these having arisen independently since the divergence of both groups from a uni-ventriculate ancestor in relation to similarity of physiological needs. St. G. Mivart next proposed to retain homology as a generic term, with homogeny and homoplasy as two species under it, and carried the analysis into great detail, distinguishing at first twenty-five, but later fifteen, kinds of correspondence: (1) parts similar in function only, e.g. legs of lizard and lobster; (2) parts similar both in function and relative position, wings of bat and bird; (3) parts of common descent, fore-limb of horse and rhinoceros; (4) parts of similar embryonic origin, whatever be their racial genetic relations, e.g. occipitals of panther and perch; (5) parts of dissimilar embryonic origin, whatever be their racial genetic relations, e.g. legs of Diptera; (6, 7, 8, 9, 10) laterally, vertically, serially, antero-posteriorly and radially homologous parts; (11) subordinate serial homologues, e.g. joints of antenna; (12 and 13) secondary and tertiary subordinate serial homologues; (14 and 15) serial and general homologues (in Owen's sense). In his *Kalkschwämme* Haeckel proposed to term *homophyly* the truly phylogenetic homology in opposition to *homomorphy*, to which genealogic basis is wanting; and finally Von Jhering has published a repetition of Lankester's view.

In this discussion, as in that of individuality, it is evident that we are dealing with numerous logical cross-divisions largely corresponding, no doubt, to the complex web of inter-relations presented by nature, yet remaining in need of disentangling. Though we must set aside analogies of functional activity, the resemblances in external shape or geometric ground-form which correspond to these, e.g. Hydrozoa and Bryozoa, Fishes and Cetaceans, mimetic

organisms, are nevertheless, as our historic survey showed, the first which attract attention; and these homoplastic or homomorphic forms, as Haeckel has shown, come as fairly within the province of the promorphologist as do isomorphic crystals within that of his an-organological colleague the crystallographer. Here, too, would be considered "radial," "vertical," "lateral" homology, "homotopy of antimeres," and all questions of symmetry, for which Haeckel's nomenclature of *homoplastic*, etc., is distinctly preferable. Entering the field of tectology or morphology in the ordinary sense, we may next consider whether two organisms compared are of the same category of individuality—are *homocategoric*; and under this serial homology, for instance, would come as a minor division, the correspondence between the units or parts of units of a linear dyad-deme or triad. From a third point of view, that of the embryologist, we trace the development of each multicellular organism (1) from the embryonic layers and systems into which the secondary unit (gastrula or plant embryo) differentiates, (2) from a unit-deme or unit of the inferior order or orders of individuality. The parts and units thus recognized by ontogenic research, respectively or successively *homodermic*, *homosystemic* and *homodemic*, may then conveniently be termed (indifferently save for considerations of priority) either "specially homologous," "homogenous," "homophylic," or "homogenetic," in the language of phylogenetic theory. These three great classes of morphological correspondence—promorphological, tectological and embryological—may or may not coincide. But the complete homology, in which all forms of resemblance unite and from which they differentiate, is that expressed in the cell theory, or rather in that ovum theory which underlies it, and which Agassiz therefore not unjustly regarded as "the greatest discovery in the natural sciences of modern times."

Orientation and Subdivisions of Morphology.—The position of morphology in the classification of the sciences and the proper mode of subdividing it cannot be discussed within these limits, although the latter is especially the subject of much disagreement. The position above assumed, that of including under morphology the whole statical aspects of the organic world, is that of Haeckel, Spencer, Huxley and most recent animal morphologists; botanists frequently, however, still use the term under its earlier and more limited significance (see PLANTS: *Morphology*).

(P. Gs.; P. C. M.)

MORPHY, PAUL CHARLES (1837-1884), American chess player, was born in New Orleans, Louisiana, on the 22nd of June 1837, the son of Alonzo Morphy (1798-1856) and his wife, whose maiden name was Le Carpentier. The father, the son of a well-to-do Spanish immigrant, was a prominent jurist and legislator and, like his brother Ernest, passionately fond of chess. Learning the moves from his father at the age of ten, Paul gave evidence of such extraordinary precocity that in less than two years he was able to defeat all the amateurs of his native city. While still at school he competed successfully with such strong players as Eugène Rousseau and the Hungarian master J. Löwenthal. He attended the Jesuit college of St Joseph at Spring Hill, Alabama, and applied himself to the study of the law, being admitted to the bar of Louisiana in 1858. During the autumn of 1857 he took part in the first American chess congress at New York, winning the first prize from sixteen competitors, including the well-known L. Paulsen. Morphy went to Europe in the spring of 1858 and entered upon a series of triumphs, both in regular matches and in blindfold play, that proved him to be one of the best players of the time. The winter of 1858-1859 was passed in Paris, where he was destined to gain his greatest triumphs, practically winning the championship of the world by beating Adolf Anderssen, champion of Germany, by a score of 7-2, with two games drawn. Another feat was his simultaneous blindfold match against eight strong French players, six of whom he defeated. At this time he was in his twenty-second year. Returning to the United States in 1859, he intended to establish himself in the practice of the law at New Orleans, but the outbreak of the Civil War frustrated these plans. His devotion to chess had already begun to affect his health. He spent the year 1863 in Paris, returning to New Orleans in 1864, but his health was now permanently impaired. He became insane, and at last he died in New Orleans in 1884.

See *Exploits and Triumphs of Paul Morphy*, by F. M. Edge (New York, 1859); *Morphy's Games*, edited by J. Löwenthal (New York, 1860); *Paul Morphy*, by Max Lange (Leipzig, 1881).

MORRILL, JUSTIN SMITH (1810-1898), American political leader and financier, was born at Strafford, Vermont, on the 14th of April 1810. He was a clerk in a store at Strafford in 1825-

1828, and at Portland, Maine, in 1828-1831, and was a merchant and then a farmer in his native town in 1831-1855. He was elected to the national house of representatives as an anti-slavery Whig in 1854, soon afterwards joining the new Republican party, and served in the house from 1855 until 1867. From 1867 until his death in Washington on the 28th of December 1898 he represented Vermont in the Senate. In the house he was continuously a member of the ways and means committee (of which he was chairman in 1865-1867), and in the Senate of the finance committee (of which he was chairman in 1877-1879, 1881-1893 and 1893-1898). Soon after entering Congress he became the acknowledged leader of the protectionists, and at the request of John Sherman, then chairman of the ways and means committee, he prepared a new tariff bill, which was introduced in the house in March 1860. To this relatively conservative bill, which substituted in many instances *ad valorem* for specific duties, and was intended by its author to be a revenue as well as a protective measure, were added many amendments which made the bill more strongly protectionist, and in some cases were vigorously opposed by Morrill. The bill was finally passed by the Senate on the 20th of February 1861, and was signed by President Buchanan on the 2nd of March following. Morrill is probably best known as the author of the Land Grant Act of 1862, which led to the development of the highly important system of state educational institutions, aided by the Federal government. On the 14th of December 1857, Morrill introduced in the house a bill "donating public lands to the several states and Territories which may provide colleges for the benefit of agriculture and the mechanic arts." This bill passed both houses, but was vetoed in February 1859 by President Buchanan on the ground that it would cause friction between the states, that it would be uneconomical, that it might encourage fraudulent speculation, that it would injure existing institutions, and that it was unconstitutional. A similar bill was introduced by Morrill on the 16th of December 1861, and five months afterwards was presented to the Senate by Benjamin Wade of Ohio. The measure had a negative report from committee in the house, and was strongly opposed in the Senate; but it passed both branches, and on the 2nd of July 1862 was signed by President Lincoln. This measure provided for the foundation and maintenance of colleges "where the leading object shall be, without excluding other scientific and classical studies, and including military tactics [which had not been included in the original bill], to teach such branches of learning as are related to agriculture and the mechanic arts. . . in order to promote the liberal and practical education of the industrial classes in the several pursuits and professions in life." In 1890 Morrill introduced in the Senate the so-called "Second Morrill Act," under which \$25,000 is given annually by the Federal government to each of the "land-grant" colleges.

MORRIS (MORRISON), CLARA (1849-), American actress, was born in Toronto, Ontario, and at the age of seventeen joined a stock company in Cleveland, Ohio. Her first New York appearance (1870) was under Augustin Daly in an adaptation of Wilkie Collins's *Man and Wife*; and she won considerable success as Cora in *L'Article 47*, Camille, Miss Multon and similar emotional parts. In 1874 she married Frederick C. Harriott, and soon afterwards began to write novels and to contribute to magazines. She published her *Life on the Stage* in 1901, and *Life of a Star* in 1906.

MORRIS, GOUVERNEUR (1752-1816), American statesman, was born in the old Morrisania manor house, in what is now the city of New York, on the 31st of January 1752. He graduated at King's College (now Columbia University) in 1768, studied law, and was admitted to the bar in 1771. New York, then in the midst of the political disturbances which preceded the outbreak of the War of American Independence, offered a good opportunity for a public career, and Morris had the aristocratic connexions which tradition required.¹ An extreme aristocrat

¹ His great grandfather, RICHARD MORRIS, having fought in Cromwell's army, emigrated to America on the restoration of Charles II., and founded the manor of Morrisania, in what was then New Netherland. His grandfather, LEWIS MORRIS (1671-1746), inherited this

in his political views, he distrusted the democratic tendencies of the Whigs, but a firm belief in the justice of the American cause led him to join their ranks. His half-brother, Staats Long Morris (1728-1800), was a Tory, fought in the British army, and became a major-General. Gouverneur served in the New York Provincial Congress in 1776-1777, was perhaps the leading advocate in that body of a declaration of independence, and after the Congress had become (July 1776) the "Convention of the Representatives of the state of New York," he served on the committee of that body which prepared the first draft of the state constitution. He served in the Continental Congress in 1777-1779, and was enthusiastic in his support of Washington. In 1778 he was selected chairman of the committee to treat with Lord North's conciliation commissioners, and as such presented the famous report, adopted by a unanimous vote of Congress, which declared that the recognition of independence must precede any negotiations for peace. He settled in Philadelphia as a lawyer, and in February 1780 he published in Philadelphia a series of essays on finance, in which he criticized the issue of legal-tenders, denounced laws passed for the benefit of the debtor class, and urged the people to tax themselves for the common good. From 1781 to 1785 he was assistant to Robert Morris (*q.v.*), superintendent of finance. In 1782 he prepared an elaborate report on the coinage, suggesting the use of the decimal system and of the terms *dollar* and *cent*. With some modifications introduced by Jefferson, notably the adoption of a higher unit of value (the dollar instead of one-tenth of a cent), this plan constitutes the basis of the present American system. Morris was one of Pennsylvania's representatives in the constitutional convention of 1787, and took an active part in the debates. His influence was weakened, however, by his cynicism and by his ultra-aristocratic views. He favoured a strong executive holding during good behaviour, an aristocratic senate appointed by the president for life, and the restriction of the suffrage to freeholders. The struggle which the frontier settlers of Pennsylvania had made in the state legislature to secure unlimited issues of paper money and the enactment of laws favourable to the debtor class prejudiced him against the West, and he tried to introduce into the constitution a clause guaranteeing forever the political supremacy of the states east of the Alleghenies. He was instrumental in securing the executive veto and in defeating the proposal that the legislature should elect the president. He also gave able support to the nationalistic and anti-slavery factions in the convention. He was the member of the committee of revision selected to draft the constitution in its final form, and that document is a monument to the vigour and simplicity of his literary style. In 1787 he bought Morrisania from Staats Long Morris, and returned to New York to live.

He went to France in February 1789 on private business, and remained abroad for nine years, passing most of the time in Paris, London, and the German capitals. In 1792 he acted as financial agent in a daring attempt to secure the escape of the king and queen from Paris. He was appointed United States minister to France in 1792, and was the only representative of a foreign country who remained at his post throughout the Reign of Terror; but his ill-concealed attitude of hostility to the Revolution and also a large estate from his uncle in Monmouth county, East Jersey. He was an influential advocate of the surrender of the proprietary government of the Jerseys to the Crown (1702), became a member of the New Jersey Council in 1703, was suspended by Governor Cornbury in 1704, was elected a member of the Assembly in 1707 and led that body in opposition to Cornbury, was reappointed to the Council under Governor Lovelace in 1708, was again suspended in 1709 by Lieut.-Governor Ingoldsby, was made President of the Council in 1710 under Governor Hunter, and in 1711, during Hunter's administration (1710-1719), of which he was a staunch supporter, was made a justice of the supreme court of New Jersey. He was chief justice of New York from about 1720 until 1733, was sent to England by the popular party late in 1734 to present their grievances to the king, and was governor of New Jersey from 1738 until his death on the 21st of May 1746. Gouverneur Morris's father, LEWIS MORRIS (1698-1762), closed a long public career as judge of the vice-admiralty court of New York; his mother was descended from a French Protestant refugee, who had come to America to escape the persecution of Louis XIV.

tion gave offence, and in return for the recall of Genet, at the request of the United States, the French government, in 1794, asked for the recall of Morris. Business and pleasure, however, still detained him in Europe for four years longer. He returned to New York in 1798, resumed the practice of his profession, re-entered politics, and sat in the United States Senate as a Federalist from 1800 to 1803. As early as 1801 Morris became interested in projects for improving the communication between the Hudson river and Lake Erie, and from 1810 to 1816 he was chairman of the board of canal commissioners, which after exploring the country prepared plans for the Erie Canal. He was bitterly opposed to the war of 1812, and openly advocated the formation of a northern confederacy to escape the rule of the "Virginia dynasty." He died at Morrisania on the 6th of November 1816.

His half-brother, LEWIS MORRIS (1726-1798), a signer of the Declaration of Independence, was educated at Yale, served in the Continental Congress from 1775 until early in 1777, and went on a mission to the western frontier in 1775 to win over the Indians from the British to the American side. He joined the army as brigadier-general of militia in June 1778, and served in the New York Senate in 1777-1781 and 1784-1790.

See *The Diary and Letters of Gouverneur Morris* (2 vols., New York, 1888), edited by Anne Cary Morris; *Jared Sparks, Life of Gouverneur Morris* (3 vols., Boston, 1832), the first volume being a biography and the second and third containing Morris's miscellaneous writings and addresses; and Theodore Roosevelt, *Gouverneur Morris* (Boston, 1888), in the "American Statesmen" series.

MORRIS, JOHN (1810-1886), English geologist and palaeontologist, was born at Homerton, London, on the 19th of February 1810. He was brought up to the business of a pharmaceutical chemist. Early in life he published observations on the Tertiary and Post-Tertiary deposits in the Thames valley, and on fossil plants and various invertebrata, in the *Magazine of Natural History*, the *Annals of Nat. Hist.* and other journals. In 1845 he issued his *Catalogue of British Fossils* (2nd ed., 1854), a work of essential service to geology. He was also author (with John Lyell) of *A Monograph of the Mollusca from the Great Oolite* (Palaeontological Soc., 1850-1853). In 1855 he became professor of Geology in University College, London, a post which he held until 1877. In 1868-1870 and 1877-1878 he was president of the Geologists' Association. He was awarded the Lyell medal by the Geological Society in 1876, and was made Hon. M.A. of Cambridge in 1878 in acknowledgment of his services as deputy Woodwardian professor during the final illness of Sedgwick. He died in London on the 7th of January 1886.

MORRIS, SIR LEWIS (1833-1907), British poet, eldest son of Lewis Edward William Morris and Sophia, daughter of John Hughes of Carmarthen, was born at Penbryn in 1833. His great grandfather, Lewis Morris (1700-1765), had been a well-known Welsh poet and antiquary. He was educated at Sherborne School and Jesus College, Oxford, where he took first prizes in classics (1853 and 1855). He won the chancellor's prize for an English essay in 1858, was called to the bar in 1861, and elected hon. fellow of his old college in 1877. He practised for twenty years as a conveyancing counsel, retiring from active legal work in 1881. He was energetic on behalf of educational movements in Wales, and contested Welsh constituencies in the Liberal interest, but without success. He was knighted in 1896, and became also a Jubilee-medallist and Knight of the Redeemer of Greece. Comparatively late in life Sir Lewis Morris made his appearance as a writer of verse with three series of miscellaneous poems, called *Songs of Two Worlds*, published respectively in 1872, 1874 and 1875. These little volumes proved him to have a refined taste and a gentle metrical fluidity, which soon won for his work considerable popularity. In 1876 and 1877 he made a more important venture with *The Epic of Hades*, an attempt to re-tell the stories of Hellenic mythology with a certain modern and allegorical setting. This work, though it is somewhat strained in sentiment and is not free from artistic infelicities, contains his best verse and has passages of undeniable force and effect. His later work follows too closely upon the influence of Tennyson, from which he is never altogether free; but his earnest

didacticism, genial optimism and evident sincerity have given his work a thoroughly wholesome moral influence. Among his other books were *Gwen* (1880), *Songs Unsung* (1883), *Gycia* (1886), *A Vision of Saints* (1890), *Idylls and Lyrics* (1896) and *The New Rambler* (1906). He died at Carmarthen on the 13th of November 1907.

MORRIS, RICHARD (1833-1894), English philologist, was born in London on the 8th of September 1833. In 1871 he was ordained in the Church of England, and from 1875-1888 was head master of the Royal Masonic Institution for Boys, near London. His first published work was *The Etymology of Local Names* (1857). Between 1862 and 1880 he prepared twelve volumes for the Early English Text Society, edited Chaucer (1866) and Spenser (1866) from the original manuscripts, and published *Specimens of Early English* (1867). His educational works, *Historical Outlines of English Accidence* (1872), *Elementary Lessons in Historical English Grammar* (1874) and *English Grammar* (1874), had a large sale and exercised a real influence. The rest of his life he devoted to the study of Pali, on which he became a recognized authority. He died at Harold Wood, Essex, on the 12th of May 1894.

MORRIS, ROBERT (1734-1806), American financier, a signer of the Declaration of Independence, was born in Liverpool, England, on the 31st of January 1734. He emigrated to America in 1747, entered a mercantile house, and in 1754 became a member of a prosperous firm, which was known successively as Willing, Morris & Co., Willing, Morris & Inglis and Willing, Morris & Swanwick. In the conflict with the mother country Morris took the side of the colonists, but associated himself with the conservative group of Pennsylvania Whigs who followed the lead of John Dickinson and James Wilson, rather than with the more radical faction represented by Thomas Paine. He was vice-president of the Pennsylvania Committee of Safety (1775-1776), and a member of the Continental Congress (1775-1778). At first he disapproved of the Declaration of Independence, but he joined the other members in signing it on the 2nd of August. He retired from Congress in 1778, and was at once sent to the legislature, serving in 1778-1779 and in 1780-1781. His greatest public service was the financing of the War of Independence. As chairman or member of various committees he practically controlled the financial operations of Congress from 1776 to 1778, and when the board system was superseded in 1781 by single-headed executive departments he was chosen superintendent of finance. With the able co-operation of his assistant, Gouverneur Morris—who was in no way related to him—he filled this position with great efficiency during the trying years from 1781 to 1784. For the same period he was also agent of marine, and hence head of the navy department. Through requisitions on the states and loans from the French, and in large measure through money advanced out of his own pocket or borrowed on his private credit, he furnished the means to transfer Washington's army from Dobbs Ferry to Yorktown (1781). In 1781 he established in Philadelphia the Bank of North America, chartered first by Congress and later by Pennsylvania, the oldest financial institution in the United States, and the first which had even partially a national character. A confusion of public and private accounts, due primarily to the fact that his own credit was superior to that of the United States, gave rise to charges of dishonesty, of which he was acquitted by a vote of Congress. He was a member of the Federal Convention of 1787, but took little part in its deliberations beyond making the speech which placed Washington in nomination for the presidency of the body. On the formation of the new government he was offered, but declined, the secretaryship of the treasury, and urged Hamilton's appointment in his stead. As United States senator, 1789-1795, he supported the Federalist policies and gave Hamilton considerable assistance in carrying out his financial plans, taking part, according to tradition, in arranging a bargain by which certain Virginia representatives were induced to vote for the funding of the state debts in return for the location of the Federal capital on the Potomac. After the war he gradually disposed of his mercantile and banking

interests and engaged extensively in western land speculation. At one time or another he owned wholly or in major part nearly the entire western half of New York state, two million acres in Georgia and about one million each in Pennsylvania, Virginia and South Carolina. The slow development of this property, the failure of a London bank in which he had funds invested, the erection of a palatial residence in Philadelphia, and the dishonesty of one of his partners, finally drove him into bankruptcy, and he was confined in a debtors' prison for more than three years (1798-1801). He died in Philadelphia on the 7th of May 1806.

The best biography is E. P. Oberholtzer's *Robert Morris, Patriot and Financier* (New York, 1903), based on the Robert Morris papers in the Library of Congress; see also W. G. Sumner's *The Financier and the Finances of the American Revolution* (New York, 1891).

MORRIS, WILLIAM (1834-1896), English poet and artist, third child and eldest son of William Morris and Emma Shelton, was born at Elm House, Walthamstow, on the 24th of March 1834. His grandfather was a respected tradesman in Worcester, and his father, who was born in that town in 1797, came up to London in 1820, and entered the office of a firm of discount brokers, in which he afterwards assumed a partnership. As a child the poet was delicate but studious. He learnt to read very early, and by the time he was four years old was familiar with most of the Waverley novels. When he was six the family moved to Woodford Hall, where new opportunities for an out-of-door life brought the boy health and vigour. He rode about Epping Forest, sometimes in a toy suit of armour, became a close observer of animal nature, and was able to recognize any bird upon the wing. At the same time he continued to read whatever came in his way, and was particularly attracted by the stories in the *Arabian Nights* and by the designs in Gerard's *Herbal*. He studied with his sisters' governess until he was nine, when he was sent to a school at Walthamstow. In his thirteenth year his father died, leaving the family well-to-do; the home at Woodford was broken up, as being unnecessarily large; and in 1848 William Morris went to Marlborough, where his father had bought him a nomination. Morris was at the school three years, but got very little good from it beyond a taste for architecture, fostered by the school library, and an attraction towards the Anglo-Catholic movement. He made but slow progress in school work, and at Christmas 1851 was removed and sent to a private tutor for a year. In June 1852 he matriculated at Exeter College, Oxford, but, as the college was full, he did not go into residence till January 1853. He at once made friends, who stood him in good stead all his life, foremost among whom were Edward Burne-Jones, who was a freshman of his year, and a little Birmingham girl at Pembroke. They were known among themselves as the "Brotherhood"; they read together theology, ecclesiastical history, medieval poetry, and, among moderns, Tennyson and Ruskin. They studied art, and fostered the study in the long vacations by tours among the English churches and the Continental cathedrals. Moreover, Morris began at this time to write poetry, and many of his first pieces, afterwards destroyed, were held by sound judges to be equal to anything he ever did. Both Morris and Burne-Jones had come to Oxford with the intention of taking holy orders, but as they felt their way they both came to the conclusion that there was more to be done in the direction of social reform than of ecclesiastical work, and that their energies would be best employed outside the priesthood. So Morris decided to become an architect, and for the better propagation of the views of the new brotherhood a magazine was at the same time projected, which was to make a speciality of social articles, besides poems and short stories.

At the beginning of 1856 the two schemes came to a head together. Morris, having passed his finals in the preceding term, was entered as a pupil at the office of George Edmund Street, the well-known architect; and on New Year's Day the first number of *The Oxford and Cambridge Magazine* appeared. The expenses of this very interesting venture were borne entirely

by Morris, but after the issue of No. 1 he resigned the formal editorship to his friend Fulford. Many distinguished compositions appeared in its pages, but it gradually languished, and was given up after a year's experiment. The chief immediate result was the friendship between Morris and Dante Gabriel Rossetti (*q.v.*), which sprang up from a successful attempt to secure Rossetti as a contributor. In the summer of 1856 Street removed to London, and Morris accompanied him, working very hard both in and out of office hours at architecture and painting. But Rossetti persuaded him that he was better suited for a painter, and after a while he devoted himself exclusively to that branch of art. It was in the summer that the two friends visited Oxford, and finding the new Union debating-hall in course of construction, offered to paint the bays. Seven artists volunteered help, and the work was hastily begun. Morris worked with feverish energy, and on finishing the portion assigned to him proceeded to decorate the roof. The work was done too soon and too fast, the colours began to fade at once, and are now barely decipherable; but the broken designs, so long as any vestige remains, will always be interesting as a relic of an important aesthetic movement and as the first attempt on Morris's part towards decorative art (see ROSSETTI). Early in 1858 Morris published *The Defence of Guenevere*, which was almost unnoticed by contemporary criticism, but is now recognized as one of the pearls of Victorian poetry.

On 26th April 1859 Morris married Jane Burden, a beautiful Oxford girl, who had sat to him as a model, and settled temporarily at 41 Great Ormond Street, London. Meanwhile he set about building for himself at Upton a house which was to be the embodiment of all his principles of decorative art. Furniture, decorations, household utensils and every article of daily use were specially designed, and in the summer of 1860 the house was ready for occupation. The furnishing of it had suggested a fresh activity; Morris now determined to embark upon decoration as a career. A small company was formed, consisting of D. G. Rossetti, Philip Webb, Burne-Jones, Madox Brown, Faulkner and Marshall, and in January 1862 started business under the title of Morris, Marshall, Faulkner & Co., with offices at 8 Red Lion Square. The prospectus set forth that the firm would undertake church decoration, carving, stained glass, metal-work, paper-hangings, chintzes and carpets. The business, after inevitable vicissitudes, flourished, but the "house beautiful" at Upton proved to be unhealthy situated. Serious illness obliged the family to remove to town, and in November 1865 they resettled at 26 Queen Square, Bloomsbury. Morris was now unceasingly busy, but he found time also for literature. In June 1867 he published *The Life and Death of Jason*, which was at once successful; and in April 1868 the first two parts of *The Earthly Paradise*. The rest of this wonderful storehouse of poetic romance appeared in two volumes in 1869 and 1870. In the following year he was again looking for a country house, and lighted upon Kelmscott manor house, in the Upper Thames valley, which he took at first in joint-tenancy with Rossetti and used principally as a holiday home. In 1872 appeared *Love is Enough*, structurally the most elaborate of his poems for its combination of the epic and dramatic spirits; and in the autumn he began to translate the shorter Icelandic sagas, to which his enthusiasm had been directed by two inspiring journeys to Iceland. Business worries, however, interrupted him; it was found necessary to reconstruct the company owing to its having grown out of proportion with the existing division of profit and labour. Long negotiations ensued, and in March 1875 the old firm was dissolved. Morris now became sole manager and proprietor, although the other members of the old firm continued, in varying degrees, to give him the advantage of their assistance and advice.

Meanwhile the epic mood had possessed Morris very strongly, and, in addition to his work upon the sagas, he had actually finished and (in 1875) published a verse translation of the *Aeneid*, which is interesting rather for its individuality than for any fidelity to the spirit of the original. In the following year appeared *Sigurd the Volsung*, a version full of heroic vigour,

and vitality, but somewhat too lengthy and incoherent in design to preserve the epic interest intact to the British taste. This splendid burst of poetic activity, however, had raised him to a place among the first poets of his time; and in 1877 an attempt was made to induce him to accept the professorship of poetry at Oxford. But he felt himself lacking in the academic spirit, and wisely declined. At this time a fresh outlet for his energy was furnished by his foundation in 1877 of the Society for the Protection of Ancient Buildings, which sprang into being as a practical protest against a scheme for restoring and reviving Tewkesbury Abbey. He began, too, to take an active interest in politics over the Eastern Question, but his enthusiasm was at the moment a flash in the pan. Finding that events were going against his judgment, Morris, as was so often the case with him, shrugged his shoulders and broke free from the movement.

Still, although he found it hard to sit close to a definite party, Morris continued to be spasmodically interested in political movements. During the next few years, indeed, the interest gained ground with him steadily. He became treasurer of the National Liberal League in 1879, but after the Irish coercive measures of 1881 he finally abandoned the Liberal party, and drifted further and further into Socialism. For ten or twelve years this movement had been gaining ground in England, and the Social Democratic Federation was formed in 1881. In January 1883, within a week of his election to an honorary fellowship at Exeter, Morris was enrolled among its members. Thenceforward for two years his advocacy of the cause of Socialism absorbed not only his spare time, but the thought and energy of all his working hours. For it he even neglected literature and art. In March 1883 he gave an address at Manchester on "Art, Wealth and Riches"; in May he was elected upon the executive of the federation. In September he wrote the first of his *Chants for Socialists*. About the same time he shocked the authorities by pleading in University Hall for the wholesale support of Socialism among the undergraduates at Oxford. Nevertheless, the federation began to weaken. At the franchise meeting in Hyde Park in 1884 it was unable to get a hearing. Morris, however, had not yet lost heart. Internal dissensions in 1884 led to the foundation of the Socialist League, and in February 1885 a new organ, *Commonweal*, began to print Morris's splendid rallying-songs. Still, differences of opinion and degree prevented concerted action; and when, after the Trafalgar Square riots in February 1886, Morris remonstrated with the anarchic section he was denounced by the advanced party and ever afterwards was regarded with suspicion. In 1880 he was deposed from the management of *Commonweal*, and gradually lost all confidence in the movement as an active force.

Long before that time, however, Morris had returned to the paramount interests of his life—to art and literature. When his business was enlarged in 1881 by the establishment of a tapestry industry at Merton, in Surrey, Morris found yet another means for expressing the medievalism that inspired all his work, whether on paper or at the loom. In 1887 he published his translation of the *Odyssey*, which had many of the qualities and defects of his *Aeneid*, and is much more interesting as an experiment than valuable as a "Homeric echo." In the *Commonweal* appeared *News from Nowhere*, published in book form in 1801, describing an England in which the principles of communism have been realized. He then added another to his many activities; he assumed a direct interest in typography. In the early seventies he had devoted much attention to the arts of illumination and calligraphy. He himself wrote several manuscripts, with illuminations of his own devising. From this to attempts to beautify the art of modern printing was but a short step. *The House of the Wolfings*, printed in 1880 at the Chiswick Press, was the first essay in this direction; and in the same year, in *The Roots of the Mountains*, he carried his theory a step further. Some fifteen months later he added a private printing-press to his multifarious occupations, and started upon the first volume issued from the Kelmscott Press, his own *Glittering Plain*. For the last few years of his life this new interest remained "the

absorbing one. A series of exquisite books, which gain in value every year, witnesses to the thorough and whole-hearted fashion in which he invariably threw himself into the exigencies of his life-work.

The last years of his life were peacefully occupied. He was sounded as to whether he would accept the laureateship upon the death of Tennyson, but declined, feeling that his tastes and his record were too remote from the requirements of a court appointment. His last piece of work, the crowning glory of his printing-press, was the *Kelmscott Chaucer*, which had taken nearly two years to print, and fully five to plan and mature. It was finished in June 1896, and before it was in his hands he already knew that his working day was over. His vigour had been slowly declining for some time, and he sank gradually during the autumn, dying on the 3rd of October 1896. He was buried in Kelmscott churchyard, followed to the grave by the workmen whom he had inspired, the members of the league which he had supported, the students of the art guild he had founded, and the villagers who had learnt to love him.

Essentially the child of the Gothic revival, he had put an ineffaceable stamp on Victorian ornament and design, his place being that of a follower of Ruskin and Pugin, but with a greater practical influence than either. In house decoration of all kinds—furniture, wall-papers and hangings (which he preferred to paper), carpet-weaving, and the painting of glass and tiles, needlework, tapestry—he formed a school which was dominated by his protest against commercialism and his assertion of the necessity for natural decoration and pure colour, produced by hand work and inspired by a passion for beauty irrespective of cheapness or quickness of manufacture (see ARTS AND CRAFTS).

The truest criticism of William Morris is that attributed to his friend, the poet Swinburne, who said that he was always more truly inspired by literature than by life. His Socialism, though it made a brave show at times, was at heart a passionate enthusiasm for an inaccessible artistic ideal. Morris, indeed, was not primarily interested in men at all, but in objects. His poetry deals, it is true, with the human passions, but the emotion is always seen as in a picture; he is more concerned with the attitude of the group than with the realization of a character. He had very little adaptability in dealing with his fellows; the crowd, as a crowd, fired his enthusiasm, but he was unable to cope with the individuals that composed it. Many of his colleagues bear witness to his generosity and magnanimity, but as a general principle he certainly lacked the wider humanity. This is the one failing of his art: it is also the shortcoming of his poetry. Granted this, there is left an immense amount that will always command admiration. The spirit of beauty breathes in every line; a sense of music and of colour is everywhere abundant; the reader moves, as it were, under a canopy of apple-blossom, over a flower-starred turf, to the faint harmony of virginals. Nor does the poet lack power and vigour when an adventurous story is to be told. The clash of arms breaks upon his pagan paradise with no uncertain sound; he is swift in narrative, breathless in escapade. And over all hangs the faint atmosphere of medievalism, of an England of green gardens and grey towers, of a London "small and white and clean," of chivalry and adventure in every brace. The critic has also to remember the historical value of Morris's literary influence, following upon the prim domesticities of early Victorian verse, and breaking in upon Tennyson's least happy phase of natural homeliness.

See the *Life and Letters*, in 2 vols. (Longmans), by J. W. Mackail. An article on "William Morris and his Decorative Art," by Lewis F. Day, appeared in the *Contemporary Review* for June 1903. (A. WA.)

MORRIS, a city and the county-seat of Grundy county, Illinois, U.S.A., on the north bank of the Illinois river, about 62 m. S.W. of Chicago. Pop. (1900), 4273; (1910) 4563. Morris is served by the Chicago, Rock Island & Pacific railway, and by the Illinois & Michigan canal. Electric power is derived from the Illinois river at Marseilles, Ill. (pop. in 1910, 3291), about 15 m. west. Morris (named in honour of Isaac P. Morris, a commissioner of the Illinois & Michigan canal) was settled in 1834, and was chartered as a city in 1857.

MORRIS-DANCE, or MORRICE-DANCE (Span. *Morisco*, Moorish), an old English dance, which is said by various authorities to have been introduced by John of Gaunt from Spain or borrowed from the French or Flemings. That it was a development of the morisco-dance or Spanish fandango is not invalidated by the fact that the morisco was for one person only, for, although latterly the morris-dance was represented by various characters, uniformity in this respect was not always observed. There are few references to it earlier than the reign of Henry VII., but it would appear that in the reign of Henry VIII. it was an almost essential part of the principal village festivities. In earlier times it was usually danced by five men and a boy dressed in a girl's habit, who was called Maid Marian. There were also two musicians; and, at least sometimes, one of the dancers, more gaily and richly dressed than the others, acted as "foreman of the morris." The garments of the dancers were ornamented with bells tuned to different notes so as to sound in harmony. Robin Hood, Friar Tuck and Little John were characters extraneous to the original dance, and were introduced when it came to be associated with the May-games. At Betley, in Staffordshire, there is a painted window, of the time of Henry VIII. or earlier, portraying the morris—the characters including Maid Marian, Friar Tuck, the hobby-horse, the piper, the tabourer, the fool and five other persons apparently representing various ranks or callings. The hobby-horse, which, latterly at least, was one of the principal characters of the dance, consisted of a wooden figure attached to the person of the actor, who was covered with trappings reaching to the ground, so as to conceal his feet. The morris-dance was abolished along with the May-games and other festivities by the Puritans, and, although revived at the Restoration, the pageant gradually degenerated in character and declined in importance. Maid Marian latterly was personated by a clown, who was called Malkin or Marykin. The interest of the subject has revived in recent years in connexion with the new movements associated with folk-music generally.

See *The Morris Book*, by Cecil J. Sharp and H. C. MacLlaine. Among older authorities see Douce, "Dissertations on the Ancient Morris Dance," in his *Illustrations of Shakespeare* (1839); Strutt, *Sports and Pastimes of the People of England*; Brand, *Popular Antiquities* (1849).

MORRISON, ARTHUR (1863—), English novelist, was born in Kent on the 1st of November 1863. He was for a short time a clerk in the civil service, and in 1890 took to journalism. He had already published scattered tales and sketches of low life in London when W. E. Henley, with whom he was connected as a contributor to the *National Observer*, suggested their publication in volume form. *Tales of Mean Streets* (1894) immediately attracted attention, and this was followed by *A Child of the Jago* (1896), the scene of which is laid between High Street, Shoreditch, and Bethnal Green Road. *Cunning Murrell* (1900), *The Hole in the Wall* (1902), and the detective stories, *Martin Hewitt, Investigator* (1894), which had sequels in 1894 and 1896, and *The Green Eye of Gorma*, are among his other works.

MORRISON, RICHARD JAMES (1795—1874), English astrologer, commonly known by his pseudonym "Zadkiel," was born on the 15th of June 1795. He served in the Royal Navy, but resigned with the rank of lieutenant in 1820. He then devoted himself to the study of astrology, and in 1831 issued *The Herald of Astrology*, subsequently known as *Zadkiel's Almanac*. In this annual pamphlet Morrison, over the signature of "Zadkiel Tao-Sze," published predictions of the chief events of the coming year. In 1863 Morrison brought a libel action against Admiral Sir Edward Belcher, who had accused him of obtaining money by charlatanism in the form of crystal-gazing. He was awarded twenty shillings damages, but was deprived of his costs. Morrison died on the 5th of April 1874.

MORRISON, ROBERT (1782—1834), the first Protestant missionary to China, was born of Scottish parents at Buller's Green, near Morpeth, on the 5th of January 1782. After receiving an elementary education in Newcastle, he was apprenticed to a lastmaker, but his spare hours were given to theology, and in 1803 he was received into the Independent Academy at

Hoxton. In the following year he offered his services to the London Missionary Society, and after he had attended David Bogue's college at Gosport and studied Chinese under a native teacher, he was appointed to Canton in 1807. After a year of much hardship he became translator to the East India Company's factory there in 1809, and worked at a *Chinese Grammar* and a translation of the New Testament, both published in 1814. In 1817 he published *A View of China for Philological Purposes*, and his translation of the Old Testament (in which William Milne collaborated) was completed in the following year. His next enterprise was the establishment (1820) of an Anglo-Chinese college at Malacca for "the reciprocal cultivation of Chinese and European literature." Here too were trained native Chinese evangelists who could proceed to the mainland and carry on Christian work with comparative immunity. In 1821 Morrison's *Chinese Dictionary*, in six 4to volumes, a monumental work, was published by the East India Company, at a cost of £12,000. Leaving China at the close of 1823, Morrison spent two years in England, where he was elected a fellow of the Royal Society. Returning to China in 1826, he set himself to promote education and to prepare a Chinese commentary on the Bible and other Christian literature. He died at Canton on the 1st of August 1834. Morrison was admirably fitted for the pioneering work accomplished by his grammar and dictionary; and his establishment of a dispensary, manned by a native who had learned the main principles of European treatment, marks him out as the forerunner of modern medical missions.

His *Memoirs*, compiled by his widow, were published in 1839. See also R. Lovett, *History of the London Missionary Society*, vol. ii, ch. xix.; C. S. Horne, *The Story of the L. M. S. ch. v.*; Townsend, *Robert Morrison* (1888).

MORRISTOWN, a town and the county-seat of Morris county, New Jersey, U.S.A., on the Whippany river, 31 m. (by rail) W. of New York City. Pop. (1890) 8156; (1900) 11,267; (1910 census) 12,507. It is served by the Delaware, Lackawanna & Western, the New Jersey & Pennsylvania and the Morristown & Erie railways. Morristown is situated on a table-land surrounded by picturesque hills. It is primarily a residential suburb of New York, and has many handsome residences and a number of large estates. Near its centre is a public park, in which is a soldiers' monument (59 ft. in height). At Morris Plains, about 4 m. to the north, is a state hospital for the insane (1876).

Morristown, officially named in 1740 in honour of Lewis Morris (1671-1746), then governor of New Jersey, and grandfather of Gouverneur Morris, was settled about 1710, under the name of West Hanover, by Puritans, who were attracted here by the presence of iron ore. From January to May 1777, and again from December 1779 to June 1780, Morristown was occupied by the American army under Washington. Behind the court-house is the site of Fort Mifflin, built at Washington's orders, largely to keep his soldiers employed. In December 1779-January 1780 General Benedict Arnold was tried before a court martial presided over by General Robert Howe (1732-1785) in the Dickerson tavern here, still standing. In Morristown, at the old Speedwell ironworks (almost completely destroyed by fire in 1909), was made a part of the machinery of the "Savannah," the first steamboat that crossed the Atlantic, and here Samuel F. B. Morse and Alfred Vail completed the invention of the electric telegraph. Morristown was incorporated as a town in 1865.

See A. M. Sherman, *Historic Morristown, New Jersey; The Story of its First Century* (Morristown, 1905) and Julia K. Colles, *Authors and Writers Associated with Morristown* (Morristown, 1893).

MORSE, SAMUEL FINLEY BREESE (1791-1872), American artist and inventor, was born at Charlestown, Massachusetts, on the 27th of April 1791, son of Jedidiah Morse (1761-1826), Congregational minister there and a writer on geography, and a grandson of Samuel Finley, president of the college of New Jersey. At the age of fourteen he entered Yale College, where he graduated in 1810 and where under the instruction of Jeremiah Day and Benjamin Silliman he received the first impulse towards electrical studies. In 1811 Morse, whose tastes during his early

years led him more strongly towards art than towards science, became the pupil of Washington Allston, and accompanied his master to England, where he remained four years. His success at this period as a painter was considerable. In 1825 he was one of the founders of the National Academy of Design, and was its first president, from 1826 until 1845. The year 1827 marks the revival of Morse's interest in electricity. It was at that time that he learned from J. F. Dana of Columbia College the elementary facts of electromagnetism. As yet, however, he was devoted to his art, and in 1829 he again went to Europe to study the old masters.

The year of his return, 1832, may be said to close the period of his artistic and to open that of his scientific life. On board the packet-ship "Sully," while discussing one day with his fellow-passengers the properties of the electromagnet, he was led to remark: "If the presence of electricity can be made visible in any part of the circuit, I see no reason why intelligence may not be transmitted by electricity." In a few days he had completed rough drafts of the necessary apparatus, which he displayed to his fellow-passengers.¹ During the twelve years that followed Morse was engaged in a painful struggle to perfect his invention and secure for it a proper presentation to the public. In poverty he pursued his new enterprise, making his own models, moulds and castings, denying himself the common necessities of life. It was not until 1836 that he completed any apparatus that would work, and finally, on the 2nd of September 1837, the instrument was exhibited to a few friends in the building of the university of the City of New York, where a circuit of 1700 ft. of copper wire had been set up, with such satisfactory results as to awaken the practical interest of the Messrs Vail, iron and brass workers in New Jersey, who thenceforth became associated with Morse in his undertaking. Morse's petition for a patent was soon followed by a petition to Congress for an appropriation to defray the expense of subjecting the telegraph to actual experiment over a length sufficient to establish its feasibility and demonstrate its value. The committee on commerce, to whom the petition was referred, reported favourably. Congress, however, adjourned without making the appropriation, and meanwhile Morse sailed for Europe to take out patents there. The trip was not a success. In England his application was refused, and, while he obtained a patent in France, it was subsequently appropriated by the French government without compensation to himself. His negotiations also with Russia proved futile, and after a year's absence he returned to New York. In 1843 Congress passed the long-delayed appropriation, steps were at once taken to construct a telegraph from Baltimore to Washington, and on the 24th of May 1844 it was used for the first time. In 1847 Morse was compelled to defend his invention in the courts, and successfully vindicated his claim to be called the original inventor of the electromagnetic recording telegraph. In 1858 the representatives of Austria, Belgium, France, the Netherlands, Piedmont, Russia, the Holy See, Sweden, Tuscany and Turkey appropriated the sum of 400,000 francs in recognition of the use of his instruments in those countries. He died on the 2nd of April 1872, at New York, where his statue in bronze now stands in the Central Park. (See TELEGRAPH.) He introduced into America Daguerre's process of photography, patented a marble-cutting machine in 1823, and in 1842 made experiments with telegraphy by a submarine cable.

See S. Irenaeus Prime, *Life of S. F. B. Morse* (New York, 1875).

MORSE, the ornamented brooch by which a cope is fastened. The usual form is a large circular clasp made of gold or silver and studded with jewels. A 14th-century "morse" ornamented with translucent enamel is in the British Museum. The word comes through the O. Fr. *mors*, from the Lat. *morsus*, the catch of a buckle, from *mordere*, to bite.

MORSHANSK, a town of Russia, in the government of Tambov, 50 m. N. of the city of Tambov, on the Tsna river. Pop. (1900), 25,013. The village of Morsha was founded in the middle of

¹ Five years later the captain of the ship identified under oath Morse's completed instrument with that which Morse had explained on board the "Sully" in 1832.

the 17th century, and received municipal institutions in 1779; but within a very few years it became a wealthy town, owing to its situation in a very fertile district. Since it was brought into railway communication with Ryazhsk (81 m. west on the railway between Moscow and Ryazan) it has become the chief centre for the trade in wheat raised in the governments of Tambov, Penza, Saratov and in the eastern districts of the government of Ryazan. There are also extensive dealings in flour, hemp-seed, tallow and potash.

MORTAGNE, a town of northern France, capital of an arrondissement in the department of Orne, 24 m. E.N.E. of Alençon by rail. Pop. (1906), 3383. A vaulted entrance (15th century), relic of an old stronghold, and the church of Notre-Dame (15th and 16th centuries) with a fine northern portal are of interest. The town is the seat of a sub-prefecture and of a tribunal of first instance, and is a celebrated market for horses of the Perche breed. Mortagne, once capital of the Perche, dates from the 10th century.

MORTAIN, a small town in the department of La Manche, France, the chief town of an arrondissement and seat of a sub-prefecture. It is beautifully situated on a rocky hill rising above the gorge of the Cance, a tributary of the Sélune. The parish church of St Evroult is a magnificent example of the transitional style of the early 13th century, with a massive tower of the 14th and a Norman doorway dating from the original collegiate church (1058). Close to the town is the Abbaye-Blanche, founded as a Benedictine convent in 1105 and soon afterwards affiliated to Cîteaux. The church is a perfect example of a Cistercian monastic church of the late 12th century, and portions of the 12th-century cloisters also survive. The population is between 2000 and 3000.

Mortain was, in the middle ages, the head of an important *comté*, reserved for the reigning house of Normandy. In or about 1049 Duke William took it from his cousin William, "the warling," and bestowed it on his half-brother, Robert, thenceforth known as "count of Mortain," whose vast possessions in England after the Conquest (1066) gave name to "the small fees of Mortain," which owed less (knight) service than others. Robert was succeeded as count by his son William, who rebelled against Henry I., was captured at the battle of Tinchebrai (1106) and forfeited his possessions. Some years later, Henry bestowed the *comté* on his nephew Stephen, who became king in 1135. On Stephen's death (1154) his surviving son William became count of Mortain, but when he died childless in 1159 the *comté* was resumed by Henry II. On the accession of Richard I. (1189) he granted it to his brother John, who was thenceforth known as count of Mortain till he ascended the throne (1199). With his loss of Normandy the *comté* was lost, but after the recapture of the province by the House of Lancaster, Edmund Beaufort, a grandson of John of Gaunt, was created count of Mortain and so styled till 1441, when he was made earl of Dorset.

As the counts are often described as "earls" of Mortain (or even of "Moreton") the title is sometimes mistaken for an English one. It has also, through erroneous spelling, been sometimes wrongly derived from Mortagne-en-Perche. (J. H. R.)

MORTAR, the name (1) of a vessel in which any material may be crushed or pounded, and (2) given to various compositions used in building and consisting of lime and cement with sand or other fine aggregate, well mixed by manual labour or machinery with a proper quantity of clean water (see below, and also BRICKWORK). The Latin name both for such a vessel and for the material as mixed in it, is *mortarium*. The earlier English form *morter*, from Fr. *mortier*, has been in modern English more closely adapted to the spelling of the Latin original. As applied to a vessel, the name is chiefly used for one employed in the preparation of drugs, which are pounded or triturated in the "mortar" by means of a pestle (Lat. *pistillum*; *pisnere*, to pound). The name has also been given, from a resemblance in shape to the vessel, to a short thick piece of ordnance, resting on a "bed" formerly used for high-angle fire. The barrel was always very short, normally even shorter than it was wide, and

sometimes even resembled a bowl in shape. The place of the mortar in artillery is now taken by the howitzer. In modern times the name "mortar" is occasionally used for a particularly short howitzer. (See ORDNANCE.)

Building Mortar.—The sand forming the aggregate is placed on the mixing platform and formed into a ring within which lime in the required proportion is placed; it is then gently but thoroughly sprinkled with clean water through the rose of a watering-can or hose-pipe. The lime is covered with the sand and left undisturbed for a day or two to slake, and the whole mass is then turned over and well mixed with the larry. The mortar is often used immediately the materials are thoroughly incorporated, but it should rather be kept covered over with sacks until well tempered. For large works a mortar mill working by hand, steam, or other power effects a considerable economy. Stone chippings, clear hard, broken bricks or furnace clinkers may take the place of sand when the mill is employed, as the action of grinding reduces any large pieces to small sandlike particles.

The remarks above apply to ordinary lime mortar. Mortar of hydraulic lime, cement mortar, or mortar gauged with cement, must be mixed up in quantities sufficient only for immediate use. Any material not used at the time, or at least the same day, will be wasted; cement cannot be reworked after it has begun to set as its setting properties are destroyed.

Slaking is a most important part in the process of making mortar. There are three methods of slaking lump lime—the first by immersion, the second by sprinkling with water, and the third by *Slaking* exposing the lime to the atmosphere and leaving it to absorb moisture. Different qualities of lime require varying amounts of water, but the average quantity is about a gallon and a half to every bushel of lime. It should be all added at one time and the mass then left to slake undisturbed. Hot limes are often used for mortar. These are unsuitable for plastering unless slaked for a long period. It will at once be seen that when mortars composed of these limes are used immediately after mixing, slaking must continue for a long time, drying up the mortar and making it necessary and causing the mortar to crumble to dust in the joints of the brickwork. This fact gives us the reason for the old Roman enactment which set forth that lime should be slaked for three years before using. In the south of Europe it is the custom to slake lime the season before it is used.

The practical application of mortar to building work, and the methods of pointing the joints of brickwork and stonework, are described and fully illustrated in the article on BRICKWORK.

The results of many careful tests and experiments serve to show that the hardening of mortar is due to several causes acting collectively. With ordinary lime mortars the chief causes of hardening are the absorption of carbonic acid from the air and the combination of part of the water with the lime, which unites with some of the silica of which the sand is composed and forms silicate of lime. The initial setting is due to the evaporation of the excess of water and to the production of minute crystals of hydrate of lime which slowly absorbs carbonic acid gas from the air. With mortar of rich lime an outer crust is thus formed on the exposed parts which prevents ready access of air to the interior and retards setting. In illustration of this peculiar property of lime to remain soft, some remarkable cases may be mentioned. One of the bastions erected by Vauban in 1666 was removed by General Treissart, in 1822, a hundred and fifty six years after erection. The lime in the interior of the masonry, where it was inaccessible to the action of the atmosphere, was found to be quite soft. Dr John of Berlin mentions that in removing a pillar 9 ft. in diameter in the church of St Peter, Berlin, eighty years after erection, the mortar in the interior was found to be quite soft. Sir C. W. Pasley, in removing the old wharf wall at Chatham dockyard in 1834, found that the work executed in lime mortar was easily removable, the mortar being in a state of pulp. The brickwork, built with Roman cement, it was found necessary to blast.

The Romans were convinced that it was owing to prolonged and thorough slaking that their works in plaster became so hard and were not defaced by cracks. L. B. Alberti mentions in his writings that he once discovered in an old trough some lime which had been left there five hundred years and that it was quite soft and fit for use.

The setting and hardening of hydraulic limes and cements are due mainly to crystallization brought about by the action of water on the silicate of lime, and not by mere absorption of carbonic acid gas from the atmosphere. As a consequence we find that this variety of limes and cements has the valuable property of setting hard when immersed in water, and in many cases growing increasingly hard with the lapse of time.

Opinions differ very widely on the question of the suitability for building purposes of limes or cements which contain an appreciable proportion of magnesia, many experts holding the view that the expansion which often occurs in floors and other works of concrete from one to four years after laying may be justly attributed to the presence of this substance. For mortars, however, it may be assumed that the presence of magnesia is not detrimental to the value of the matrix, but on the contrary may be a source of strength, for experiments show that it reduces the energy of

Hardening of Mortar.

Magnesia in Mortar.

slaking and increases that of the setting processes. Cements containing magnesia are pronounced both by Vicat and Chatothey to resist the dissolving action of sea-water better than those in which no magnesia is present, and it is pretty well established by experience that cements derived from argillio-magnesian limestones furnish a durable cement for construction in the sea.

The old mortar of the Romans, which proves its great property of endurance by many of their works still remaining, was in all probability composed of lime mixed with pozzolana or "trass." These materials are similar in character and are obtained from extinct volcanoes—in the case of the Romans from the Italian volcanoes, but also from extinct volcanoes in the valleys of the Rhine and in Holland. Good as these mortars undoubtedly were, it may be safely asserted that no cement or mortar has been discovered to excel in strength, or in durability in all climates, the Portland cement of the present day. The best varieties of this material are made in England, the country of its origin, much of the continental and American product being deficient in the qualities which combine to make a good cement. (For the properties of Portland cement and the method of its manufacture see CEMENT.)

The comparative strengths under tensile stress of grey-lime mortar, Portland-cement mortar, and Portland-cement mortar with the addition of lime, are given in the following table, which is the result of a series of tests by G. R. Redgrave.

Proportions by Measure.				Breaking Weight per sq. in. in lb.
Sand.	Cement.	Lime.	Water.	
2	—	1	1.33	36.89 (average of three tests)
6	1	—	1.25	103.79 "
10	1	—	2.00	15.16 "
10	1	0.50	1.50	73.47 "
10	1	0.83	2.50	42.34 "

It is a good plan, where the question of cost precludes the use of mortar made entirely of cement, to add to lime mortar mixed in the usual proportions a small quantity of Portland cement. This is termed "gauged" lime mortar. By this addition the strength is greatly increased and the extra cost is slight.

The following table shows the force required to tear apart common stock bricks bedded in mortar, mixed in proportions commonly used, and left to set and harden for four weeks.

Adhesive Strengths of Lime and Cement Mortars.		
	Proportions.	
White chalk, lime and sand	1 to 3	4½ lb. per sq. in.
Barrow lias do.	1 to 3	9 " "
Do. do.	1 to 4	6½ " "
Portland cement	1 to 4	23 " "
Do.	1 to 6	15½ " "

These results show clearly that the adhesive strength of mortar varies according to the proportion of sand used, the power of resistance of the mortar to the force brought to bear upon it decreasing as the proportion of sand is increased. The cement made with the primary cause of the premature decay which sometimes takes place in mortars and like material is due to the presence of mud and decayed vegetable and animal matter in the sand, or possibly in the lime or cement itself. It is therefore of great importance to use a perfectly clean sand for the aggregate, and to select a lime or cement of good quality for the matrix, care being taken that no foreign matters detrimental to the mortar be introduced during the processes of preparation.

The effect of salt in mortars as a preventive of the destructive effects of frost has not as yet been thoroughly determined, and the few experiments that have been carried out show varying results. In some German experiments, cubes of stone were joined together with cement mixed with water of different characters, ranging from pure rain-water to water containing from 2 to 8% of salt. Before the cement was set the blocks were exposed in air at a temperature varying from 20° F. to freezing-point, after which they were kept for seven days in a warm room. The samples were then examined with these results: The cement mixed with pure water was quite crumbled, having lost all its tenacity. The cement made with water containing 2% of salt was in rather better condition, while that containing 8% of salt had not suffered from its exposure to frost. The use of salt causes much efflorescence on the face of the work, and should therefore not be used where this would be undesirable. Nor should salt be employed for work that is to be subsequently painted. The mortar for the brick facing of the Forth Bridge below water was composed of one part of Portland cement and one part of sand mixed with salt water in a mill. Briquettes made from this compound withstood a tensile stress of an average of 305 lb per square inch when a week old, and of 510 lb at five

weeks after mixing. Salt has no effect upon the strength of a mortar, although it retards the setting process somewhat.

Cement mixed with a percentage of sugar (usually 2% and under) has been used with varying success. In India sugar is a frequent ingredient in mortar, probably because it has the effect of preventing too rapid setting; it also retards the drying of the material. The sugar must be dissolved in the water used for gauging, as the results obtained when the sugar is mixed with the other ingredients in a dry state are not good. The addition of sugar to water enables it to take up about fourteen times more lime than pure water. It is supposed by many writers who have studied the methods of the ancients that old Roman mortars contained strong ale, wort or other saccharine matter, and it is probable that the use of sugar with lime passed from India to Egypt and Rome. The following is an extract from the *Roorkee Treatise on Engineering*, a work of reference published in India: "It is common in this country to mix a small quantity of the coarsest sugar, 'goor' or 'jaghery', as it is termed, with the water used for mixing up mortar. Experiments were made with bricks joined together by mortar consisting of one part of common shell lime to one and a half parts of sand, one pound of 'jaghery' being mixed with each gallon of water. The bricks were left for thirteen hours and after that time the average breaking weight of the joints in twenty trials was 6½ lb per square inch. In twenty-one specimens joined with the same mortar without the 'jaghery' the breaking weight was 4½ lb per square inch."

Of the saccharine matters used in mortar treacle seems to give the best results, rough cane sugar being next in effectiveness; beetroot sugar is not a good material to use.

The by-laws made by the London County Council in 1891 under sec. 16 of the Metropolitan Management and Buildings Act Amendment Act 1878 require that "the mortar to be used in the construction of walls must be composed of freshly burned lime and clean, sharp sand or grit without earthy matter, in the proportions of one lime to three of sand or grit." The cement to be used must be Portland cement or other cement of equal quality to be approved by the district surveyor, mixed with clean, sharp sand or grit in proportions of one of cement to four of sand or grit. Burnt ballast or broken brick may be substituted for sand or grit, provided such material be properly mixed with lime in a mortar mill.

The varieties of lime and cement chiefly used for mortar in the British Isles are set forth below:—
Pure or fat limes should not be used for mortar. Grey stone lime, feebly hydraulic, makes a good mortar, but should not be employed for work below ground or in other damp situations. It is obtained chiefly at Dorking, Halling, Lewes and Merstham. It is used in the proportion of one part to two or three parts of sand. An analysis of the lime from Castle Bytham gives the following composition:—

Silica	14.00
Iron oxide and alumina	4.25
Lime	77.00
Magnesia	1.25
Carbon dioxide	0.90
Water and loss	2.00
	100.00

Blue lias lime is eminently hydraulic and should be used in good class work. Its use is a necessity for foundations and work in damp situations where Portland cement is not employed. It is used in the proportions of one part to one or two parts of sand. The best-known varieties are obtained from Watchet in Somersetshire, Barrow-on-Soar in Leicestershire, Rugby in Warwickshire, and Lyme Regis in Dorsetshire. A typical lias lime shows on analysis the following composition:—

Silica	17.53
Iron oxide	2.87
Alumina	6.83
Lime	65.84
Magnesia	1.00
Sulphuric anhydride	1.36
Water and carbon dioxide	3.85
Insoluble matter and loss	0.72
	100.00

Portland cement is the best matrix known, since it is the most powerful and the most durable. It is used for mortar wherever great strength, hard-wearing properties, and resistance to damp are required. It should weigh 112 lb per struck bushel and be ground fine enough to pass through a sieve having 2500 meshes to the square inch and leave not more than 10% residue. Test briquettes after setting under water for seven days should stand a tensile strain of 350 lb on a square inch. It is used in the proportions of one part of cement to one from one to five parts of sand.

Portland cement of a similar character to the English cement, but somewhat less powerful, is largely made in America. The principal seat of manufacture is Copley, Pa., where the first

American Portland cement was manufactured in 1874 by Mr. David O. Saylor.

The chief works of reference on this subject are G. R. Burnell, *Limes, Cements, Mortars*; Rivington, *Notes on Building Construction*; F. W. Taylor and S. E. Thompson, *A Treatise on Concrete, Plain and Reinforced*. (J. Br.)

MORTARA, EDGAR, an Italian Jew, of a Bologna family, whose abduction in early childhood (1858) by the Inquisition occupied for several years the attention of European diplomacy. Edgar Mortara, when between five and six years of age, fell ill. His nurse, a Catholic, arranged with her priest for his baptism in that faith, unknown to his parents, on the 24th of June 1858. She had acted in the same way with his elder brother, who had been ill a year or two previously, but on his recovery the boy continued to be educated as a Jew. This time she determined to make sure of her convert. Everything was concerted in advance with the ecclesiastical authorities, and immediately after the baptism both child and nurse disappeared. The story became public property, and protest was aroused in nearly every European country. The English and French governments made representations to the Vatican, but Pius IX., through the medium of the *Civiltà Cattolica*, maintained that the question at issue was a spiritual one, outside his temporal jurisdiction. He accordingly declined to take any action, meanwhile indicating the direction of his sympathies by making Mortara his ward. In 1861 the Mortara family induced the Italian government to demand the prosecution of the nurse. The Vatican replied that she had entered a nunnery, and subsequently, on the threat of intervention by Prussia, induced the Mortara family to withdraw their plaint. After the capture of Rome by the Italian troops in 1870 Edgar Mortara had the opportunity of reverting to Judaism, but he refused to do so, and not long afterwards became an Augustinian.

MORTARA, a town of Lombardy, Italy, in the province of Pavia, 354 ft. above sea-level, a railway junction situated between the Ticino and the Po, 32 m. by rail S.W. of Milan. Pop. (1901), 7298 (town); 8697 (commune). Lines run to Milan, Pavia, Alessandria, Casale Monferrato and Vercelli. The church of San Lorenzo is in the Gothic style of the 14th century with a brick façade. Outside the town is the Lombard Romanesque church of S. Albino. Mortara has iron-works and manufactures of hats and cheese. Here the Austrians defeated the Piedmontese in 1849.

MORTGAGE (an old French legal word, meaning "dead pledge," translated in medieval Latin *mortuum vadium*),¹ the securing "money or money's worth" by making it a charge upon property, real or personal, so that if the debt be not paid by a time agreed upon by the parties, the creditor may foreclose or sell the property and pay himself out of the proceeds. In English law this is done by an actual or executory conveyance of the property to the creditor, subject only to its being defeated if the debt should be paid at the time fixed—an arrangement to which the law has attached peculiar incidents designed to carry out its real object.

The history of mortgage transactions in Roman law shows three well-marked stages. In the beginning the estate was conveyed absolutely to the creditor, who made a covenant (*fiducia*) to reconvey it when the debt should be paid. All the interest, however, in the meantime passed from the debtor to the creditor, and should the latter refuse to reconvey there was no remedy to the original owner except a personal action. In the second stage (that of *pignus*) the property did not pass to the creditor; he merely received possession of the thing pledged, together with certain rights of sale, &c., in the event of payment not being made at the time appointed. Lastly, without parting with the possession even of the pledge the debtor could create a lien or charge (*hypotheca*) over it in favour of the creditor, who

¹ Coke on Littleton gives the following explanation of the meaning: "It seemeth that the cause why it is called mortgage is, for that it is doubtful whether the feoffor will pay at the day limited such summe or not, and if he doth not pay, then the land which is put in pledge upon condition for the payment of the money is taken from him for ever, and so dead to him upon condition, &c. And if he doth pay the money, then the pledge is dead as to the tenant, &c."

acquired thereby a right on failure of payment to follow the thing by real action against the possessor, whosoever he might be, and to repay himself from the proceeds of his sale.

The mortgage of English law is the result of two distinct influences. Its origin and form belong to the common law; the restrictions by which it is made to serve the purpose of a security only, and nothing more, belong to the courts of equity. In the eye of the common law the mortgagee was the owner of the estate conveyed in the mortgage; in equity the mortgagor remains the real owner, and the mortgagee is merely an encumbrancer. A, the owner of land in freehold, conveys to B and his heirs, with a proviso that on repayment of money lent by B to A, on a future day, with interest until payment, B or his heirs will reconvey the estate to A and his heirs, and that, until default be made in payment, A and his heirs may hold without interruption from B and his heirs. This is a common mortgage of land, and at law, after failure of payment, the land belonged absolutely to the mortgagee, while in the meantime, before payment, the legal estate was considered to be vested in him, subject only to being defeated by payment at the proper time. The court of chancery first interfered in the reign of James I. to decree a redemption after forfeiture, and a case in the reign of Charles I. decides that payment after forfeiture has the same effect as payment before. The right of the mortgagor to redeem his estate after it has been forfeited, according to the terms of the deed, is called his *equity of redemption*. No agreement between the parties was suffered to oust the jurisdiction of the court, or to deprive the debtor of his equity of redemption. And this equity, at first regarded as a mere right of the debtor, became established in course of time as an estate in land which descended to the heirs of the mortgagor. On the other hand, the interest of the mortgagee is part of his personal estate, and passes to his executor and not to his heir. In spite of the terms of the mortgage, the owner of the land is still the owner, and the mortgagee is a creditor for the money he advanced and the interest thereon. It may be a question whether a given deed is a conveyance or a mortgage, and the court, in deciding, will look at all the circumstances of the case, and will treat it as a mortgage when it was the real intention of the parties that it should operate as a security only. Thus, if the price was grossly inadequate, if the purchaser was not let into immediate possession, if he accounted for the rents to the grantor, retaining an amount equivalent to interest, if the expense of the deed was borne by the grantor, there would be reason to believe that the conveyance was only meant to be a mortgage. And "once a mortgage, always a mortgage"; no subsequent agreements can change its character.

A mortgagee may, however, on default of payment file a bill of foreclosure requiring the mortgagor to pay the amount of the debt with interests or costs by an appointed day, or submit to be deprived of his equity of redemption. The effect of failure to pay by the time appointed would be to make the mortgagee absolute owner of the estate; but the court in any foreclosure suit may, at the request of either side, order a sale instead of a foreclosure. And a power of sale is now implied as one of the incidents of the mortgage, unless forbidden or varied by express destination. The mortgagee is entitled to retain out of the proceeds of the sale the amount of his principal, interest and costs, the surplus belonging to the mortgagor. A mortgagor cannot require the creditor to receive payment before the time appointed in the deed; and, on default of payment at the appointed time, he must give the creditor six months' notice of his intention to pay off the mortgage, so that the creditor may have time "to look out for a fresh security for his money."

When the same land is successively mortgaged to different persons, their rights take priority according to their chronological order. But the operation of equitable doctrines in the formation of the law of mortgage leads to an important modification of this rule. Of the successive mortgagees, the first only takes the legal estate, and this, according to the maxim

of the court of chancery, will turn the scale when there is an equality of equitable rights between two contracting parties. Thus, if the third mortgagee had no notice at the time of making his advance of the existence of the second mortgagee, the equities of the two claimants are supposed to be equal, and if nothing else intervened priority of time would decide the order of their rights. But if the third mortgagee gets an assignment of the first mortgage, he can *take* his third mortgage to the first, and so postpone the second mortgage. And if the first mortgagee himself makes an additional advance after the date of the second mortgage, but without notice of it, his whole debt will take precedence of the second mortgage. A similar result of equitable rules is seen in the consolidation of securities. Two separate estates, mortgaged at different times and for different sums of money by the same mortgagor to the same mortgagee, are regarded as consolidated, so that the whole of the land becomes security for the whole of the money, and the owner cannot redeem either mortgage without redeeming the other. If the mortgagor should have mortgaged another estate for more than its value, the holder of the deficient security may buy in the first mortgage, consolidate it with his own, and exclude the second mortgagee.

An equitable mortgage is constituted simply by the deposit of title-deeds in security for money advanced. The enactment of the Statute of Frauds that no action shall be brought on "any contract or sale of lands," &c., or any interests in or concerning them unless the agreement be in writing and signed by the party to be charged, has been cited as incompatible with the recognition of equitable mortgages, but it is argued by Lord Abinger that the act was never meant to affect such a transaction. The deeds which are the evidence of title could not be recovered in an action at law, and, if they were claimed in equity, the court would require the claimant to do equity by repaying the money borrowed on the deposit. Any subsequent legal mortgage, having notice of the deposit, will be postponed to the equitable mortgagee, and when the legal mortgagee has not inquired as to the title-deeds the court will impute to him such knowledge as he would have acquired if he had made inquiry. A Welsh mortgage is one in which an estate is conveyed to a creditor, who takes the rents and profits in lieu of interest and without account, the estate being redeemable at any time on payment of the principal. Any form of property, with few exceptions, may be mortgaged.

United States.—In the United States there has been express legislation dealing with mortgages of land in most of the states. For the most part legislation has followed the lines of the English law, but there is a great variation in the extent to which the principles of equity have been substituted for the rules of common law. In some states, the mortgage deed is held to create a seizure of and an estate in the premises, with all its common law incidents, to be enforced if need be by ejectment. In others, the mortgagee's rights are limited to such as the rules of equity prescribe, and may not be enforced by a suit at law. In yet others, the mortgagee's interest is not deemed an estate at all, but is here only to be enforced by the sale of the premises as a means of paying the debt.

See Fisher on *Mortgages*; Coote on *Mortgages*; Ashburner on *Mortgages*; L. A. Jones, *Treatise on the Law of Corporate Bonds and Mortgages* (Indianapolis, 1907).

MORTIER, EDOUARD ADOLPHE CASIMIR JOSEPH, DUKE OF TREVISO (1768—1835), marshal of France, was born at Cateau Cambresis on the 13th of February 1768, and entered the army as a sub-lieutenant in 1791. He served in the campaigns of 1792 and 1793 on the north-eastern frontier and in the Netherlands, and subsequently on the Meuse and the Rhine. In the war against the second coalition in 1799 he was promoted successively general of brigade and general of division. His conduct of the French occupation of Hanover led Napoleon to include Mortier in the first list of marshals created in 1804. He commanded a corps of the *grande armée* in the Ulm campaign in which he distinguished himself particularly by his brilliant action of Dürrenstein; in 1806 he was again in Hanover and

north-western Germany, and in 1807 he served with the *grande armée* in the Friedland campaign. In 1808 he was created duke of Treviso, and shortly afterwards he commanded an army corps in Napoleon's campaign for the recapture of Madrid. He remained in Spain for two campaigns, winning the victory of Ocaña in November 1809. In 1812 and 1813 he commanded the Young Guard, and in the "defensive" campaign of 1814 he rendered brilliant services in command of rearguards and covering detachments. In 1815, after the flight of Louis XVIII., he rejoined Napoleon and was given a high command, but at the opening of the Waterloo campaign he fell ill. After the second restoration he was for a time in disgrace, but in 1819 he was readmitted to the Chamber of Peers and in 1825 received the Order of the Saint Esprit. In 1830—1831 he was ambassador of France at St Petersburg, and in 1834—1835 minister of war and president of the council of ministers. In 1835, while accompanying Louis Philippe to a review, the marshal with eleven other persons was killed by the bomb aimed at the king by Fieschi (July 28, 1835).

MORTIFICATION, a term used in pathology and surgery, signifying a local death (*Lat. mors*) in the animal body. A portion of the body may die in consequence of the disturbance of its nutrition by inflammation, or of a cutting off of the blood-supply, as by pressure upon, or injury to, the blood-vessels. A comparatively slight injury affecting a portion of the body imperfectly supplied with blood may give rise to an inflammatory condition which in a healthy part might pass unnoticed, but which, in consequence of imperfect nutrition, may end in mortification. If the flow of arterial blood only is arrested, the part depending upon it for nutrition becomes numb, cold and shrivelled, and the form of mortification known as *dry gangrene* occurs. This is apt to be met with in oldish persons with diseased vessels and feeble heart-action, especially if the blood is rendered less nutritious by the presence of diabetes or of kidney disease. The rule of treatment in all cases of threatened mortification is to keep the part warm by flannel or cotton-wool, but to avoid all methods which unduly hurry the returning circulation. Such increase would give rise to excessive reaction, which, in tissues already weakened, might actually produce mortification. When the part is dead it should be wrapped up in dry antiseptic dressings to prevent putrefaction. The surgeon should then wait until the "line of demarcation," a linear ulceration, between the living and the dead part is evident, and then, if the case permits, should amputate at a higher level. In *spreading gangrene*, in which acute sepsis is present, and in which no line of demarcation forms, the best chance for the patient is promptly to amputate high up in sound tissues. In these cases the blood is generally poisoned, and if the patient recovers from the primary shock of the operation, the disease may reappear in the stump, and lead to a fatal result.

Frost-bite.—Under the influence of cold, the blood-vessels contract, and less blood is conveyed to the tissues. Frost-bite is particularly apt to attack the feet, the hands, and the tips of the ears. The condition is unassociated with pain, for the reason that the nerves are benumbed. As no blood is passing into the skin, the parts look like tallow, and thus attract the attention of the companions of the frost-bitten man, who perhaps has no thought of there being anything amiss. But because the tissues are frost-bitten it does not follow that they will not recover. The great danger is that, as the blood in the vessels becomes thawed, there will be so much reactionary flow through the tissues that acute inflammation will follow. And this inflammation of the damaged tissues is very likely to cause mortification. The re-establishment of the circulation, therefore, should be undertaken with the greatest possible care. The frost-bitten individual must not be brought near a fire nor even into a warm room. Nothing warm should come in contact with the affected parts. The best thing to do is to rub them with snow or with cold water. The thawing is associated with much pain, and in the case of the hand or foot this may be diminished by raising the part, so as to help the return of the venous blood to the heart. If mortification follows, the parts

become black, and care should be taken to prevent their becoming invaded by the germs of putrefaction. (E. O.)*

MORTILLET, LOUIS LAURENT GABRIEL DE (1821-1898), French anthropologist, was born at Meylau, Isère, on the 29th of August 1821. He was educated at the Jesuit college of Chambéry and at the Paris Conservatoire. Becoming in 1847 proprietor of *La Revue indépendante*, he was implicated in the Revolution of 1848 and sentenced to two years' imprisonment. He fled the country and during the next fifteen years lived abroad, chiefly in Italy. In 1858 he turned his attention to ethnological research, making a special study of the Swiss lake-dwellings. He returned to Paris in 1864, and soon afterwards was appointed curator of the museum at St. Germain. He became mayor of the town, and in 1885 he was elected deputy for Seine-et-Oise. He had meantime founded a review, *Mémoires pour l'histoire positive et philosophique de l'homme*, and in conjunction with Broca assisted to found the French School of Anthropology. He died at St Germain-en-Laye on the 25th of September 1898. Of his published works the best known are *Le Préhistorique* (1882); *Origines de la chasse, de la pêche et de l'agriculture* (1890); *Les Nègres et la civilisation égyptienne* (1884).

MORTIMER (Family). The Mortimers of Wigmore, earls of March and Ulster, were of a stock akin to the dukes of Normandy and to many great houses of the duchy. Their ancestor Hugh, bishop of Coutances in 990, had at least three sons by a niece of Herfast the Dane, forefather of the Norman earls of Hereford, and brother-in-law of Duke Richard I. The eldest of these sons was Ralph, father of William of Warenne, earl of Surrey. The second was Roger of Mortemer-en-Brai, in the Pays de Caux, who, like his elder brother, is called *filiius episcopi*. If we assume that Roger was born before his father's consecration, he must have lived to a great age. In the battle fought within his own village of Mortemer, Roger was a leader of the force which defeated the French, but, releasing an enemy of his duke, he was punished by the loss of his castle, which was given to his nephew, William of Warenne. The chronicle of Orderic Vitalis makes the Conqueror relate in a long death-bed speech how he had thrust Roger out of Normandy, and, though reconciled to him, had not restored the castle "in which he saved my enemy." It is somewhat remarkable that the Mortimers, thus early deprived of the castle at the source of the Eaulne, yet handed down a surname derived from it. Here also it may be noted that although Mortimer and Warenne branch off from their common stock before the beginnings of armorial bearings, the two houses assumed arms, which speak plainly enough of their common origin. The Mortimers' chief seat in Normandy became St Victor-en-Caux, where in 1074, by the last recorded act of Roger and his wife Hawise, the priory became an abbey. Roger's age would have forbidden him to be with the duke at Hastings, but, according to Wace, his son Hugh was in the fight, and Ralph the third son was probably among the knights.

By the deaths of his elder brothers, Ralph de Mortemer became heir to his father's lands. He followed his kinsman, William Fitz-Osbern, the earl of Hereford, to the marches of Wales, and the Domesday book for Hereford and Shropshire marks the growth of the Mortimer power in those countries. He remained loyal during the rising of the 2nd earl of Hereford, and was enriched by grants of many of the earl's forfeited estates, among them the castle town of Wigmore, which became the chief seat of Mortimer and Cleobury, thereafter called Cleobury Mortimer. His Domesday lands lie in eleven counties, but the most important are found in North Hereford and South Shropshire. Although keeping apart from the treason of Earl Roger, Ralph rose in 1188 with the other barons of the March, but was reconciled to William II, whom he afterwards supported in Normandy. He was living in 1104 a partisan of Henry I., and must have died soon afterwards. Hugh de Mortimer, who is found as his successor, a great Herefordshire baron in 1140, may have been either the son of Ralph's old age, or a grandson, the son of another Ralph. During the reign of Stephen, Hugh

occupied himself with local feuds, but seized the royal castle of Bridgnorth. So great was his power in the marches, that he alone, deserted by the earl of Hereford, armed and held his three castles against Henry II. Although forced at last to submit, he was allowed to keep Wigmore and the ruins of Cleobury. This proud baron died at Cleobury (c. 1181) in the habit of a canon of the abbey which he had founded at Wigmore.

Ralph de Mortimer, the 5th baron of Wigmore (d. 1246), married Gwladys the Swart, daughter of Llewelyn the Great, prince of Wales, and by her was father of Roger, whose bride, Maude de Breuse, daughter and co-heir of that William de Breuse whom Llewelyn had hanged, brought in a third of the honour of Breuse of Brecknock, and a share of the honour of the earls marshal. So came the lordship of Radnor with other lands, and, as Eyton justly remarks, the history of the Mortimers ceases to be a provincial record. The last-named Roger stood steadfast for the Crown during Henry III.'s struggle with his barons. He found the fleet horse that carried Edward from his captivity. He led the rear-guard at Evesham, where his marchers hacked the head from Earl Simon, and sent it to their lady at Wigmore. "After that victory," says Eyton, "no privilege, reward or honour was too great for Mortimer to ask." Dying in 1282, he was succeeded by Edmund, the eldest surviving son (d. 1304), Roger, a third son, founding the line of Mortimer of Chirk.

By Margaret de Fiennes, a kinswoman of Queen Eleanor of Castile, Edmund Mortimer had, with other issue, a son and heir, Roger (b. 1287), whose great inheritance was increased on his marriage with Joan, daughter and heir of Peter de Geneville, her grandmother being a co-heir of Lacy. The whole of the Geneville lands, with the half of the Lacy fief in England and Ireland, came through her to the Mortimers, who now added the castle town of Ludlow and half Meath to their estates. As the king's lieutenant in Ireland during Edward Bruce's invasion of 1316, Roger Mortimer defeated the Lacys, his wife's jealous kinsfolk, and made her inheritance secure. With the aid of his uncle Roger Mortimer of Chirk, he assured the Mortimer power on the Welsh marches. During the war with the Despensers, the force of the Mortimers was cast against the king and his favourites, but after Bridgnorth Castle had been taken and fired, uncle and nephew submitted and suffered a harsh captivity for two years in the Tower of London. The uncle died in his prison, whence the nephew made a famous escape to France. At the court of Charles IV. the exile met Isabel, the queen of England, and early in 1326 the scandal of her close friendship with the lord of Wigmore had reached England. When the queen and her mercenaries from Germany and Hainaut landed at an English port in September, Mortimer was with her, and he followed the flight of the king to Wales. He was among the judges of the elder Despenser at Bristol, and of the younger, his chief enemy, at Hereford. After the parliament had deposed Edward II. and made the young Edward king in his stead, Roger, as the queen's paramour, ruled England. Enriched by the lands of the Despensers, and by those of the earl of Arundel, beheaded at his command, Mortimer, who was created earl of March in 1328, never ceased to add greedily to his possessions and offices. When he held a Round Table, he summoned to it, with the young king and the queen-mother, almost all the nobles of the kingdom, and was, says Robert of Avesbury, "as it were, king over them all." But his fate followed suddenly upon these doings. Lancaster turned in vain upon the aggrandized march-lord, but the young king, impatient of his own puppet-like place in Mortimer's polity, worked secretly and surely for his fall. Montague's men-at-arms entered Nottingham Castle by night, and joining the king, seized the favourite in his chamber next the queen. Mortimer, with the courage of his race, turned to bay and struck dead a knight who was the king's steward. But he was hurried to London and condemned by the peers; his death followed suddenly. Like any foot-pad, he was drawn at the horse-tail to the elms of Tyburn, where his body hung two days upon the common gallows.

The earl's son and heir, Edmund Mortimer, had been married to Elizabeth of Badlesmere, heir of her brother Giles. He died the year after his father's fall, and his young son Roger, as he grew up, was restored to a great part of their forfeited inheritance. This Roger fought at Crécy in "the king's battle." A founder of the Order of the Garter, he was summoned as a baron and obtained a reversal of his grandfather's attainder. In 1355 he was summoned as earl of March. On the death of his grandmother, Ludlow Castle became the chief seat of his house. But following his king in the invasion of Burgundy, he died suddenly at Rouvray in 1360. His wife, a grand-daughter of that William Montague, earl of Salisbury, who had captured his grandfather at Nottingham, survived him two-and-twenty years.

His only son, Edmund, a boy nine years old, succeeded him as 3rd earl of March (1351-1381). A bride was found for him in the royal house. His marriage with Philippa, daughter of Lionel of Antwerp, duke of Clarence, by Elizabeth de Burgh, the heir of Ulster, added the earldom of Ulster to his style, and brought his issue into the direct succession of the Crown. Like so many of his race, he died young, of a chill caught in fording a Munster river on a winter's day, and his countess was dead before him. Elizabeth, their eldest child, became the wife of the famous Harry Percy, called Hotspur. Their second was Roger, who succeeded to his father's two earldoms as a boy of seven, and was at once appointed lieutenant of Ireland. His marriage was given to the earl of Kent, who married him to his daughter, Eleanor Holand, the niece of King Richard. In the parliament of 1385 the king named him as heir-presumptive to the throne. The panegyrists of his family are loud in their praise of his knightly doings and his great beauty, but they speak also of his lion-like ferocity, of his lasciviousness, and of his neglect of divine things. When in Ireland he defied the statute of Kilkenny, and ordered his garments and horse-harness after the fashion of an Irish chieftain. He wore the Irish mantle on the day in 1398 when, in one of his petty wars with the Leinster men, he was struck down at Kells as he charged far before his horsemen. The body, mangled by Irish skenes and axes, was brought home to be laid by his fathers in their abbey of Wigmore.

Once more a child succeeded to the earldoms. Edmund, 4th earl of March, was six years old at his father's death, and was, for the king's party, the heir-presumptive of the kingdom. But in 1399 the boy's fate was changed by the coming to power of the Lancastrian party, and Henry IV.'s first parliament recognized Henry's son as heir-apparent. Although Edmund and his brother Roger were brought up honourably with the new king's younger children, they were in strict custody until the king's death, broken only by the attempt of their uncle, Sir Edmund Mortimer, and his father-in-law, Owen Glyndwr, to carry them off from Windsor to Wales, where the young earl would have been proclaimed king. Henry V., however, released the earl and restored his lands, and absolved March from any share in the plot of the earl of Cambridge, who had married Anne, sister of the earl. March served the king in his French wars, although a dysentery caught in the camp at Harfleur seems to have kept him from his share in the glory of Agincourt. On the accession of Henry VI. the earl was appointed to the lieutenancy of Ireland which had been held by his father and grandfather, and in Ireland, on the 19th of January 1425, he died suddenly of the plague. His wife, Anne, daughter of Edmund, earl of Stafford, had borne him no child, and thus, his brother being dead before him, the illustrious house of the Mortimers, earls of March and Ulster, became extinct. Their lands and earldoms passed to Richard, duke of York, son of Richard of Cambridge, by the last earl's sister, and the great name of Mortimer disappeared from the English baronage.

AUTHORITIES.—*Victoria History of the Counties of England*—Introductions to Domesday book for Hereford and Shropshire; Eytton's *Antiquities of Shropshire*; *Dictionary of National Biography*; Dugdale's *Monasticon*; Stapleton's *Rotuli Scaccarii Normannie*; G. E. C.'s *Complete Peerage*; Rymer's *Foedera*; *Journal of the British Archaeological Association*, vol. xxiv. Inquests, post mortem, close, patent and charter rolls, &c. (O. Ba.)

MORTISE, or **MORTICE** (adapted from the Fr. *mortaise*; cf. Ital. *mortise* and Spanish *mortaja*; the origin is unknown; Celtic equivalents, such as Gaelic *mortais*, are of French origin), a term for a socket or cavity cut in a piece of wood, or other material, into which a corresponding projecting end, a "tenon," fits, the two when fitted together forming a "mortise-joint," for fastening two beams or other pieces of timber together.

MORTLAKE, a village in the Kingston parliamentary division of Surrey, England, on the Thames, 6½ m. W. of London. Pop. of parish, which includes East Eesh (1901), 7774. It has been associated with the Oxford and Cambridge boat-race since 1845, the race finishing here. The village appears in Domesday, and the manor belonged to the Archbishops of Canterbury until the time of Henry VIII., when it passed by exchange to the Crown. From the early part of the 17th century until after the civil wars Mortlake was celebrated for a manufacture of tapestry.

MORTMAIN (O. Fr. *mortmain*; med. Lat. *mortua manus*, dead hand), the state or condition of lands or tenements when held by a corporation in perpetual or inalienable tenure. Alienation in mortmain having the effect of depriving the lord of the incidents of seignory, which arose through the death or felony of the tenant or failure of his heirs, many English statutes were passed directed against such alienation. The earliest is that of Henry III. 36 (Magna Carta); others being 7 Edward I. 13 (De Viris Religiosis); 13 Edward I. 32; 15 Richard II. 5; and 23 Henry VIII. 10. The present law is regulated by the Mortmain and Charitable Uses Act 1888, as amended by the act of 1891.

MORTON, JAMES DOUGLAS, 4TH EARL OF (c. 1525-1581), Scottish statesman, was the second son of Sir George Douglas of Pittendreich. Before 1543 he married Elizabeth (d. 1574), daughter of James Douglas, 3rd earl of Morton, a grandson of James Douglas (d. c. 1500), who was created earl of Morton in 1458. The 3rd earl's wife was Catherine, an illegitimate daughter of James IV. In 1553 James Douglas succeeded to the title and estates of his father-in-law, and in 1563 he became lord high chancellor of Scotland. Though his sympathies were with the reformers, he took no part in the combination of Protestant barons in 1565, but he headed the armed force which took possession of Holyrood palace in March 1566 to effect the assassination of Rizzio, and it was to his house that the leading conspirators adjourned while a messenger was sent to obtain Mary's signature to the "bond of security." The queen, before complying with the request, escaped to Dunbar, and Morton and the other leaders fled to England. Having been pardoned, Morton returned to Scotland early in 1567, and with 600 men appeared before Borthwick Castle, where the queen after her marriage with Bothwell had taken refuge. He was present at the remarkable conference at Carberry Hill, and he also took an active part in obtaining the consent of the queen at Lochleven to an abdication. He led the army which defeated the queen's forces at Langside in 1568, and he was the most valued counsellor of the earl of Murray during the latter's brief term of office as regent. On the death of the earl of Mar (Oct. 28, 1572), Morton, who had been the most powerful noble during this regency, and also during that of the earl of Lennox, at last reached the object of his ambition by being elected regent. In many respects Morton was an energetic and capable ruler. He effected at Perth, in February 1573, with the aid of Elizabeth's envoy, a pacification with Huntly, the Hamiltons, and the Catholic nobles who supported Mary. Only the castle of Edinburgh held out, and this, aided by English artillery, he succeeded in taking after a brave resistance by Kirkcaldy of Grange and Maitland of Lethington.

The ensuing execution of these men, the bravest and the ablest Scotsmen of that age, put an end to the last chance of Mary's restoration by native support. But while all seemed to favour Morton, there were under-currents which combined to procure his fall. The Presbyterian clergy were alienated by his leaning to Episcopacy, and all parties in the divided Church by his seizure of its estates. Andrew Melville, who had succeeded to the leadership of Knox, was more decided than Knox against any departure from the Presbyterian model, and refused to be

won by a place in his household. The powerful earl of Argyll and Atholl, a Stuart and Roman Catholic, united with Alexander Erskine, governor of Stirling, who now had the custody of the young king, and others in a league which received so much support that Morton bent before the storm and offered to resign. He surrendered the castle of Edinburgh, the palace of Holyrood, and the royal treasures, retiring to Lochleven, where he busied himself in laying out gardens. But his ambition could not deny itself another stroke for power. Aided by the young earl of Mar, he got possession of Stirling Castle and the person of the king. Civil war was avoided only by the influence of Sir Robert Bowes, the English ambassador. A nominal reconciliation was effected, and a parliament at Stirling introduced a new government. Morton, who secured an indemnity, was president of the council, but Atholl remained a privy councillor in an enlarged council with the representatives of both parties. Shortly afterwards Atholl died of poison, it was said, and suspicion pointed to Morton. His return to power was brief, and the only important event was the prosecution of the two Hamiltons, who still supported Mary and saved their lives by flight to England. The final fall of Morton came from an opposite quarter. In September 1579 Esmé Stuart, the king's cousin, came to Scotland from France, gained the favour of James by his courtly manners, and received the lands and earldom of Lennox, the custody of Dumbarton Castle, and the office of chamberlain. One of his dependants, Captain James Stuart, son of Lord Ochiltree and brother-in-law of Knox, had the daring to accuse Morton at a meeting of the council in Holyrood of complicity in the murder of Darnley, and he was at once committed to custody. Some months later Morton was condemned by an assize for having taken part in that crime, and the verdict was justified by his confession that Bothwell had revealed to him the design, although he denied participation in its execution. He was executed by the maiden—a guillotine he had himself brought from England—on the 2nd of June 1581.

The attained earldom of Morton passed by charter at his death to a grandson of the 3rd earl, John, 7th Lord Maxwell (1553-1593), who had previously claimed the title. In 1586, however, the attainder was rescinded in favour of Archibald Douglas, 8th earl of Angus (*q.v.*), a nephew of the 4th earl. Various earls of Morton have now to be distinguished.

Sir William Douglas (d. 1606), who ranks as 6th or 7th earl of Morton, was the 4th earl's near kinsman, being the son of Sir Robert Douglas of Lochleven (d. 1547), and was closely associated with him in his career, the two men being occasionally confused in the histories. He was the custodian at Lochleven Castle of Queen Mary. By the 4th earl's will he succeeded in 1588 to the earldom of Morton, on the death of Archibald, 8th earl of Angus; but Lord Maxwell's title of Morton, which had been revoked in 1585, was revived in 1587 and 1592, so that both men were in possession, and a conflict arose. Sir William Douglas was succeeded by his grandson William (1582-1649), known as 7th or 8th earl of Morton, lord high treasurer of Scotland, a zealous Royalist, who on the outbreak of the Great Rebellion provided £100,000 for the cause by selling his Dalkeith estates to the Buccleuch family; and though John, 8th Lord Maxwell (*q.v.*, 1586-1613), also claimed the earldom, he was attainted in 1609 and his rights then failed, his titles and estates being restored in 1618 to his brother Robert, with the title of earl of Nithsdale (1620) in lieu of Morton. Among later earls of Morton mention may be made of James (1702-1768), 14th earl (*or*, as sometimes numbered, 16th), who became president of the Royal Society (1764), and was distinguished patron of science, and particularly of astronomy. In 1746 he visited France, and was imprisoned in the Bastille, probably as a Jacobite. The present earl of Morton is his descendant.

MORTON, JOHN (c. 1420-1500), archbishop of Canterbury, cardinal and statesman, belonged to a family which had migrated from Nottinghamshire into Dorset, and was born either at Bere Regis or Milborne St Andrew. Educated at the neighbouring Benedictine abbey of Cerne and at Balliol College, Oxford, he graduated in law, and followed that profession in the ecclesiastical courts in London, where he attracted the notice of Archbishop Bouchier. He is said (*Dict. Nat. Biog.*) to have been "at once admitted to the privy council"; but probably this is a mistake for the ordinary council, of which Morton might well have been made a member when he was appointed master in chancery and chancellor of the duchy of Cornwall. He received a good deal of ecclesiastical preferment

from the Lancastrian party, was present, if he did not fight on the losing side, at the battle of Towton in 1461, and was subsequently attainted by the victorious Yorkists. He lived with the exiled court of Margaret of Anjou at Bar until 1470, and took an active part in the diplomacy which led to the coalition of Warwick and Clarence with the Lancastrians and Louis XI., and indirectly to Edward IV.'s expulsion from the throne. Morton landed with Warwick at Dartmouth on the 13th of September 1470, but the battle of Tewkesbury finally shattered the Lancastrian hopes, and Morton made his peace with Edward IV., probably through the mediation of Archbishop Bouchier.

In March 1473 Morton was made master of the rolls, and Edward found employment for his diplomatic talents; and he was sent on a mission to Hungary in 1474, and was one of the negotiators of the Treaty of Pecquigny in 1475. In 1479, after receiving a number of minor ecclesiastical promotions, he was elected bishop of Ely. He was one of the executors of Edward IV.'s will in 1483, and the story of the future Richard III., while preparing Morton's arrest, joking with him about the strawberries the bishop grew in his garden at Holborn is well known and apparently authentic. Oxford University in vain petitioned for Morton's release, and after some weeks in the Tower he was entrusted to the duke of Buckingham's charge at Brecknock. Here Morton encouraged Buckingham's designs against Richard, and put him into communication with the queen dowager, Elizabeth Woodville, and with Henry Tudor, earl of Richmond. He escaped from Brecknock Castle to Flanders, avoided Buckingham's fate, and devoted his energies during the next two years to creating a party in England and abroad in the interests of the earl of Richmond.

When Richmond secured the crown as Henry VII. Morton became his principal adviser. He succeeded Bouchier as archbishop of Canterbury in 1486 and Alcock as lord chancellor in 1487; and he was responsible for much of the diplomatic, if not also of the financial, work of the reign, though the ingenious method of extortion popularly known as "Morton's fork" seems really to have been the invention of Richard Fox (*q.v.*), who succeeded to a large part of Morton's influence. Morton no doubt impressed Lancastrian traditions upon Henry VII., but he cannot be credited with any great originality as a statesman, and Henry's policy was as much Yorkist as Lancastrian. The fact that parliament continued to meet fairly often so long as Morton lived, and was only summoned once by Henry VII. after the archbishop's death, may have some significance; but more probably it was simply due to the circumstance that Morton's death synchronized with Henry's achievement of a security in which he thought he could almost dispense with parliamentary support and supplies. As an ecclesiastic Morton followed orthodox Lancastrian lines: in 1489 he obtained a papal bull enabling him to visit and reform the monasteries, and he proceeded with some vigour against the abuses in the abbey of St Albans. In 1493 he was created a cardinal, and in 1495 was elected chancellor of the university of Oxford. He encouraged learning to the extent of admitting Sir Thomas More into his household, and writing a Latin history of Richard III., which More translated into English. He constructed "Morton's Dyke" across the fens from Wisbech to Peterborough, repaired the episcopal palace at Hatfield and the school of canon law and St Mary's Church at Oxford. He died at Knole on the 12th of October 1500, and was buried in the crypt of Canterbury Cathedral.

Besides the authorities cited in the *Dict. Nat. Biog.*, see the recently published calendar of Patent Rolls, 1461-1485, *passim*; W. Busch, *England under the Tudors* (1892); J. Gairdner, *Henry VII.* (1889) and *Lollardy and the Reformation* (1908), and *Political History of England*, vols. iv. and v. (Longmans). (A. F. P.)

MORTON, JOHN MADDISON (1811-1891), English playwright, was born at Pangbourne, on the 3rd of January 1811. He was the author of *Box and Cox* (1847) and a number of other farces. In later life, however, he failed to maintain his success, and eventually became a Charterhouse pensioner, dying on the 10th of December 1891.

His father, Thomas Morton (1764?-1838), also a well-known

dramatist, was the author of *Columbus, or a World Discovered* (1792); *Speed the Plough* (1798); *The School of Reform, or How to Rule a Husband* (1805); *A Roland for an Oliver* (1819); and other pieces.

MORTON, LEVI PARSONS (1824—), American banker and politician, was born at Shoreham, Vermont, on the 16th of May 1824.¹ He was in business at Hanover, New Hampshire, in 1843-1849 and in Boston in 1849-1854. He then became a partner in a New York dry-goods house. He established in 1863 the banking house of L. P. Morton & Company (dissolved 1899), with a London branch which had Sir John Rose (1820-1888) as its principal member. The American firm assisted in funding the national debt at the time of the resumption of specie payments, and the London house were fiscal agents of the United States government in 1873-1884, and as such received the \$15,500,000 awarded by the Geneva Arbitration Court in settlement of the "Alabama Claims" against Great Britain. In 1890 Morton became president of the Morton Trust Company in New York City. He was a Republican representative in Congress in 1879-1881, United States minister to France in 1881-1885, vice-president of the United States during the presidency of Benjamin Harrison in 1889-1893, and in 1895-1896 was governor of New York, signing as such the "Greater New York" bill and the liquor-tax measure known as the "Raines law." In 1896 he was a candidate for the presidential nomination in the Republican national convention.

MORTON, OLIVER PERRY (1823-1877), American political leader, "war governor" of Indiana, was born in Salisbury, Wayne county, Indiana, on the 4th of August 1823. After studying for two years (1843-1845) at Miami University, he practised law at Centerville, Indiana, and in 1852 was judge of the sixth judicial circuit of Indiana. In February 1856 he was a member of the Pittsburg convention which led to the organization of the national Republican party, and in the same year he was a candidate for governor of Indiana; he was defeated, but his campaign resulted in the effective organization of the new party in his state. He was elected lieutenant-governor in 1860, and when Henry S. Lane (1811-1881), the governor, resigned, on the 16th of January 1861, Morton became governor. In 1864 he was re-elected. In meeting all the extraordinary demands resulting from the Civil War he displayed great energy and resourcefulness, and was active in thwarting the schemes of the secessionists in the neighbouring state of Kentucky, and of the Knights of the Golden Circle, the Order of American Knights, and the Sons of Liberty (secret societies of Southern sympathizers and other opponents of the war) in Indiana. In 1863 a hostile legislature sought to deprive him of all control over the militia, and failing in this, adjourned without making the appropriations necessary for carrying on the state government. In this predicament Morton appointed a bureau of finance, and appealed for financial aid to private individuals, bankers, the counties, and even the Federal government. The response was so prompt that he was able to conduct affairs practically single-handed until 1865, when a legislature more favourable to his policies assembled. In 1865, when Morton had a paralytic stroke and went to Europe for treatment, the president entrusted him with a confidential mission to Napoleon III. concerning the withdrawal of the French troops from Mexico. Morton resigned as governor in January 1867 to accept a seat in the United States Senate, in which he served during the rest of his life. He was recognized as one of the leaders of the Radical wing of his party, voting in favour of Johnson's impeachment, and being especially active on behalf of negro suffrage. In 1870 Grant offered to appoint him minister to Great Britain, but he declined the honour on perceiving that a Democrat would succeed him in the Senate.

¹ His earliest ancestor in America was George Mourt, or Morton (d. 1624), a merchant of York, England, who seems to have been in London in 1621-1622 as financial agent for the Plymouth colonists. He published *Mourt's Relation, or Journal of the Beginning and Proceedings of the English Plantation at Plymouth* (1622), apparently written by William Bradford and Edward Winslow, and went to Plymouth, Mass., in the "Anne" in 1623.

He was a candidate for the Republican nomination for the presidency in 1876, and at the national convention of his party received 124 votes on the first ballot; the nomination, however, finally went to Rutherford B. Hayes. He died at Indianapolis on the 1st of November 1877.

See William D. Foulke, *Life of Oliver P. Morton* (2 vols., Indianapolis, 1899).

MORTON, THOMAS (1564-1650), English bishop, was born at York, and was educated at York and Halifax grammar-schools and St John's College, Cambridge, where he became fellow on taking his degree. He was ordained in 1592, and held the office of university lecturer in logic till in 1598 he was presented to the living of Long Marston, Yorkshire. He gained a considerable reputation as a Protestant controversialist, and published numerous works against Roman Catholicism, chief among them being the *Apologia catholica* (1605) and *A Catholice Appelle* (1609). He held successively the deaneries of Gloucester (1606), Winchester (1609), and a canonry at York (1610). In 1616 he became bishop of Chester, in 1618 bishop of Lichfield and Coventry, and in 1632 bishop of Durham. On the abolition of the episcopate in 1646 he was assigned a pension, but it was never paid, and the remainder of his life was passed in retirement.

MORTON, THOMAS (c. 1590-1646), usually called Thomas Morton of Merrymount, English adventurer in America, was a lawyer of Clifford's Inn, London, and seems to have practised in the west of England. He spent three months in America in 1622; returned in 1625, and settled at Mount Wollaston, in what is now Quincy, Massachusetts; and in 1626, when most of the settlers removed to Virginia, he assumed command of the settlement, and renamed it Merrymount.² Morton, a Royalist rake, soon became a thorn in the flesh of the sober colonists at Plymouth. On May-Day in 1627 his companions erected a May-pole, and, assisted by Indians, indulged in all the revelry and licence then customary in England. "The setting up of this May-pole was a lamentable spectacle to the precise Separatists that lived at New Plimmoth," says Morton. "They termed it an Idoll; yea, they called it the Calf of Horeb, and stood at defiance with the place, . . . threatening to make it a woeful mount and not a merry mount." In disregard of a royal proclamation, Morton sold run and fire-arms to the natives, not only injuring the trade of Plymouth, but also endangering the safety of the colonists. Morton was therefore arrested and sent to England; and when John Endecott, with a patent from the council for New England, arrived soon afterward he visited Merrymount, which lay within his jurisdiction, rebuked the inhabitants, cut down the May-pole, and renamed the place Mount Dagon. In 1629 Morton returned to America, but was arrested on trivial charges by the Massachusetts authorities, and was confined in the stocks. Later his house was burned and he was sent to England, where he spent a term in the Essex gaol. After his release he wrote his *New English Cannaen* (1637), in which he describes the Indians and the natural features of the country, and heaps ridicule upon the New England colonists. In 1643 Morton returned to America. He was imprisoned in Boston in the following year, and was tried before the general court for complaining against the colony before the Privy Council; he was recommitted to gaol pending the gathering of further evidence, and after a year's confinement was fined £100 and released. He retired to Agamenticus (now York), Maine, and in 1646 died poverty-stricken.

See the *New English Cannaen*, edited by Charles Francis Adams (Publications of the Prince Society, vol. ix., Boston, 1883); C. F. Adams, *Three Episodes of Massachusetts History* (Boston, 1896); and, for a more favourable view of Morton, *A Few Observations on the Prince Society's Edition of the New English Cannaen*, revised and reprinted from the *Churchman* (New York, 1883). Morton's adventures have furnished material for Nathaniel Hawthorne's short story, *The Maypole of Merrymount*, and for John Lotthrop Motley's novels, *Morton's Hope* (1839) and *Merry Mount* (1849).

MORTUARY (Med. Lat. *mortuarium*, from *mortuus*, dead), of or belonging to the dead, or, in particular, to the burial ² In his book Morton indulges his fondness for punning and display of Latinity by calling the place Mare-Mount (Hill by the sea).

of the dead. The chief modern use of the word is for a building in which dead bodies awaiting burial may be temporarily kept, for the purpose of inquiry, identification, post-mortem examination, &c. But it has also been applied to many subjects connected with death and burial. In monastic institutions it was the duty of the almoner to send round to other monastic houses notice of the death of a member, asking for prayers for the soul of the dead. This notice was often beautifully illuminated. On being returned with the endorsement of the monastery to which it had been sent, it would be copied into the roll. Both the notice and the roll were known as a *mortuarium*, or mortuary (see Abbot F. H. Gasquet's *English Monastic Life*, 1904). In the English Church a "mortuary" was in certain places a customary oblation or offering paid out of the estate of a deceased person to the church to which he belonged. An act of 1520 (21 Hen. VIII. c. 6) limited the amount to be paid in mortuaries, the highest being of the value of 10s. in estates above £40. Mortuaries, where customary, can only be enforced in the ecclesiastical courts. The custom has entirely died out, though claims have been made from time to time.

MORVAN, an elevated region forming the northern continuation of the central plateau of France, and extending over a large part of the department of Nièvre, and over portions of those of Yonne, Côte-d'Or and Saône-et-Loire. Its area is a little over 1000 sq. m. The average elevation is about 1600 ft., the culminating point the Bois-du-Roi, attaining 2950 ft. It is traversed by the Yonne, which has its source on Mt. Prénelay (2789 ft.), by the Cure and by several affluents of the Arroux. Geologically it consists chiefly of gneiss and granite. It contains much good pasture and is abundantly wooded, the exploitation of its forests affording employment to large numbers of the inhabitants.

MORVI, a native state of India, in Kathiawar, within the Gujarat division of Bombay. Area, 822 sq. m.; pop. (1901), 87,496, showing a decrease of 17% in the decade, due to famine; estimated revenue, £48,000; tribute, £4,000. The chief, whose title is Thakur sahib, is a Jadeja rajput, of the same clan as the rao of Cutch. The chief products are cotton and grain. The town of Morvi is situated on the river Machhu, 22 m. from the sea and 35 from Rajkot; pop. (1901) 17,820.

MORVILLE, HUGH DE, one of the four English knights who perpetrated the murder of Becket. He appears in the service of Henry II. from 1158. His principal estate was at Burgh-on-Sands. After the archbishop's murder Hugh and his associates at first took refuge in Knaresborough Castle; afterwards the king sent them to obtain absolution from the pope. The story runs that all four were enjoined to go on pilgrimage to the Holy Land, but it is not known whether Hugh made his expiation in this way. The date of his death is unknown, but it was in or before 1202/3, when we find his English lands in the hands of his two daughters as co-heiresses.

See Eytton's *Itinerary of Henry II.*; Ramsay, *Angevin England*.

MORYSON, FYNES (1566–1630), English traveller and writer, was the son of a Lincolnshire gentleman, Thomas Moryson, member of parliament for Grimsby. After being educated at Cambridge, where he gained a fellowship at Peterhouse, Fynes Moryson spent many years in travel on the continent of Europe, in Palestine, and in Asia Minor. In 1600 he became secretary to Sir Charles Blount, lord-deputy of Ireland, in which country his brother, Sir Richard Moryson, held an important government appointment. In 1617 Moryson published an account of his travels and of his experiences in Ireland, where he witnessed O'Neill's rebellion, in a voluminous work entitled *An Itinerary*. He died on the 12th of February 1630. The *Itinerary* was originally intended to consist of five parts; but only three were printed, a fourth being preserved in manuscript in the library of Corpus Christi College, Oxford (partially printed in 1903 in Charles Hughes's *Shakespeare's Europe*). Another part of the *Itinerary* was republished in 1735 with the title *History of Ireland 1599–1603, with a short Narrative of the State of the Kingdom from*

1169; and in 1800 Henry Morley included in the "Carisbrooke Library" a volume, *Ireland under Elizabeth and James I., described by Spenser, Sir John Davies and Fynes Moryson*. The *Itinerary* is a work of great value to the historian as a truthful picture of the social conditions prevailing in Europe at the beginning of the 17th century.

MOSAIC (corresponding to Lat. *opus musivum*, from Gr. *μουσαϊον*, an artificial grotto often decorated with mosaics; the word is only found in the sense of mosaic in late Greek, which generally uses *ψηφολόγημα*), the fitting together of many, generally small, pieces of marble, opaque glass, coloured clays, or other substances, so as to form a pattern.

Ancient Mosaic.—The earliest existing specimens of mosaic belong to one of the less important branches of the art—namely, the ornamentation on a small scale of jewellery, ivory thrones, and other furniture, or more rarely of some elaborate architectural ornament. Most of this sort of mosaic resembles in execution what are called cloisonné enamels. In the Louvre and in the British Museum are preserved some very beautiful ivory carvings in low relief, some from Nineveh and others from Egypt, in which figures of deities, ornaments formed of the lotus and papyrus plants and royal cartouches are enriched by small pieces of glass, or lapis-lazuli and other gem-like stones, which are let into holes made in the ivory. Each minute piece is separated from the next by a thin wall or cloison of ivory, about as thick as cardboard, which thus forms a white outline and sets off the brilliance of the coloured stones.

Excavations at Tel-el-Yehudia in Lower Egypt have brought to light some mosaics on a larger scale, but treated in the same way. These are caps of columns, wall tiles, and other objects, either of white limestone or earthenware, in which designs, chiefly some forms of the papyrus, are formed by bits of glass or enamelled earthenware, let into a sinking in the tile or column. This form of mosaic was employed by the Greeks: the Erechtheum at Athens, built in the middle of the 5th century B.C., had the bases of some of its white marble columns ornamented with a plait-like design, in which pieces of coloured glass were inserted to emphasize the main lines of the pattern.

Another, quite different, sort of mosaic was known to the Egyptians of the Ptolemaic and Roman periods. This is made entirely of glass and is extremely minute. The finest known specimen is in the British Museum: it is a small tablet about $\frac{3}{4}$ in. square, apparently the bezel of a ring, on which is represented the sacred hawk—every feather on the bird's wing being produced with a great number of colours and tints, each quite distinct, and so minute that a strong magnifying glass is required to distinguish its details.

The way in which this mosaic was produced is extremely ingenious. Numbers of long sticks of various-coloured glass were arranged in such a way that their ends produced the figure of the hawk; other sticks of blue glass were placed all round so as to form the ground. The whole bundle of sticks of glass when looked at endwise now presented the figure of the hawk with a blue background, immensely larger than it afterwards became. The bundle was then heated till the sticks melted together, and the whole thick rod, softened by fire, was drawn out to a greatly diminished thickness. A slice of the rod was then cut off and its faces polished—the design, much reduced in size, of course being equally visible at both sides of the slice; and thus the microscopic minuteness of the mosaic was produced with astonishing delicacy and refinement; many slices, each showing the same mosaic, could be cut from the same rod.

Far more important was the use of mosaic on a large scale, either for pavements or for walls and vaulted ceilings. We are told by Pliny (*H. N.* xxxvi. 184) that the practice of decorating pavements "after the fashion of painting" was due to the Greeks, and there is no reason to doubt the truth of this statement, although no mosaic pavement discovered in Greece can be dated with certainty to a period preceding the Roman occupation. This is true even of the pavement in the temple of Zeus at Olympia (fig. 1; *Olympia, Baudenkmal*, vol. ii. pl. cv.).

The simplest classification of mosaics is that of Gauckler (Daremberg and Saglio, *Dictionnaire des antiquités*, s.v. "Musivum Opus"), who distinguishes the following:—

a. *Opus tessellatum*, consisting of cubes of marble or stone, regularly disposed in simple patterns. This was largely used for pavements, especially in Roman times.

b. *Opus vermiculatum*, consisting of cubes (not always regularly shaped) generally of coloured marble¹ or more precious



FIG. 1.—Greek Pavement from the Temple of Zeus at Olympia.

materials, when these were obtainable, disposed so as to obtain a pictorial effect. The art of mosaic is mainly concerned with this branch of work.

c. *Opus musivum*, properly applied to the mosaic decoration of walls and vaulted ceilings (*cameræ*), in which cubes of glass or enamel were used. The glass was rendered opaque by the addition of oxide of tin, and coloured with other metallic oxides; when melted it was cast into flat slabs, generally about $\frac{1}{2}$ in. thick, and then broken into small cubes.

d. *Opus sectile*, a species of marqueterie in marble or other coloured materials used to produce pictures and patterns. Under the later empire a particular variety of this, called *opus alexandrinum*² mainly composed of porphyry, red and green,³ was much in use.

Judging from the description given by Vitruvius (vii. 1), and an examination of numerous specimens of Roman tessellated mosaics, the process of manufacture was the following. The earth was first carefully rammed down to a firm and even surface; on this was laid a thick bed of stones, dry rubbish, and lime, called "rudus," from 6 to 9 in. deep, and above this another layer, 4 to 6 in. thick, called "nucleus," of one part of lime to three of pounded brick, mixed with water; on this, while still soft, the pattern could be sketched out with a wooden or metal point, and the tesserae or small bits of marble stuck into it, with their smoothest side uppermost. Lime, pounded white marble, and water were then mixed to the consistency of cream, forming a very hard-setting cement, called *marmoratum*. This cement, while fluid, was poured over the marble surface, and well brushed into all the interstices between the tesserae. When the concrete and cement were both set, the surface of the pavement was rubbed down and polished.

The usual Roman pavement was made of pieces of marble, averaging from half to a quarter of an inch square, but rather

¹ In the less prosperous provinces of the empire, such as Britain, these costly materials could not be obtained, and native sandstone, &c., was used.

² The biographer of Severus Alexander (*Hist. Aug.*, c. 25, 7) attributes the invention of *opus alexandrinum* to that emperor; but this is clearly a false derivation. This technique was doubtless invented at Alexandria.

³ This latter is often, but wrongly, called serpentine.

irregular in shape. A few other, but quite exceptional, kinds of mosaic pavements have been found, such as that at the Isola Farnese, 9 m. from Rome, made of tile-like slabs of green glass, and a fine "sectile" pavement on the Palatine Hill, made of various-shaped pieces of glass, in black, white, and deep yellow. In some cases—e.g. in the "House of the Faun" at Pompeii—glass tesserae in small quantities have been mixed with the marble ones, for the sake of greater brilliance of colour.

Few countries are richer than England in remains of Roman mosaics; the great pavements of York, Woodchester, Cirencester, and many other places are as elaborate in design and as skillfully executed as any that now exist even in Rome itself. In whatever country these mosaics are found, their style and method of treatment are always much the same; the materials only of which the tesserae are made vary according to the stone or marble supplied by each country. In England, for instance, limestone or chalk often takes the place of the white marble so common in Italian and North African mosaics; while, instead of red marble, a fine sort of burnt clay or red sandstone is generally used; other makeshifts had to be resorted to, and many of the Romano-British mosaics are made entirely without marble. It is perhaps partly owing to the great wealth of Northern Africa in marbles of many colours and of varying shades that the finest of all Roman mosaics have been found in Algeria and Tunis, especially those from Carthage, some of which have been brought to the British Museum. See *Archæologia*, xxxviii. 202.

The range of colour in the marble tesserae is very great, and is made use of with wonderful taste and skill: there are three or four different shades of red, and an equal number of yellows and greens, the last colour in all its tints being almost peculiar to this part of Africa, and one of the most pleasant and harmonious in almost any combination. Deep black, browns and



FIG. 2.—Part of a Persian's Head from the Battle of Issus.

bluish-greys are also abundant. The mosaics from Carthage are no less excellent in design than in the richness and beauty of their materials. Large spaces are filled by grand sweeping curves of acanthus and other leaves, drawn with wonderful boldness and freedom of hand, and varied with great wealth of invention. Without the use of very small tesserae, much richness of effect is given by gradations of tints, suggesting light and

shade, without a painful attempt to represent actual relief. The colours of the marbles used here and elsewhere by the Romans are so quiet and harmonious that it would have been almost impossible to produce with them a harsh or glaring design, and when used with the skill and strong artistic feeling of the mosaic workers at Carthage the result is a real masterpiece of decorative design.

The finest of the later examples in Rome is that which decorates the vault of the ambulatory of the circular church of S. Costanza, built by Constantine the Great, outside the walls of Rome. This very interesting mosaic might from its style and materials have been executed in the 1st century, and is equal in beauty to any work of the kind in Italy. It shows no trace whatever of the Byzantine influence which, in the next century, introduced into Italy a novel style of mosaic, in materials of the most glittering splendour. Survivals of this classical style of mosaic are found in North Africa and the East. At Kabr-Hiram, near Tyre, Renan discovered among the ruins of a small three-apsed Christian church of the 4th century A.D. a fine mosaic pavement, covering the nave and aisles, thoroughly classical in style. A very similar mosaic, of about the same date, was discovered at Nebi Yûnas, near Sidon.

Medieval Mosaics.—These may be divided into four principal classes: (1) those used to decorate walls and vaults, made of glass cubes; (2) those for pavements, made of marble, partly in large shaped pieces, and partly in small tesserae; (3) glass in small pieces, either rectangular or triangular, used to enrich marble pulpits, columns, and other architectural features; (4) wood mosaics.

1. In the Byzantine period the glass cube mosaic was exclusively employed in mural decoration. At first natural colouring was used, and backgrounds, if not in local colour, were generally blue; but the use of gold, both for backgrounds and for the high lights on drapery, &c., gradually prevailed. Owing to the intense conservatism of Byzantine art, no regular stages of progression can be traced in this class of mosaic. Some of the 5th-century mosaics at Ravenna are, in every way, as fine as those of the 12th, and it was not till the end of the 13th century that any important change in style took place. The mosaics of the 9th century are inferior in drawing and general treatment to those both of the earlier and later time, while in Italy at least this art was almost entirely extinct during the 10th and 11th centuries. Extreme splendour of colour and jewel-like brilliance combined with the most stately grandeur of form are the main characteristics of this sort of decoration.

A "majesty," or colossal central figure of Christ with saints standing on each side, is the most frequent motive. In many cases, especially in the 5th and 6th centuries, Christ was represented as a lamb, to whom the twelve apostles, in the form of sheep, are paying adoration. Christ, the Good Shepherd, is sometimes depicted as a beardless youth, seated among a circle of sheep—the treatment of the motive being obviously taken from Pagan representations of Orpheus playing to the beasts. The tomb of Galla Placidia has a good example of this subject, with much of the old Roman grace in the drawing and composition. Frequently the Virgin Mary, or the patron saint of the church, occupies the central space in the apse, with ranges of other saints on each side.

The "Doom," or Last Judgment, is a favourite subject for domes and sanctuary arches; the Florence baptistery has one of the grandest mosaic pictures of this subject, executed in the 13th century. The earlier baptisteries usually have the scene of Christ's baptism—the river Jordan being sometimes personified in a very classical manner, as an old man with flowing beard, holding an urn from which a stream pours forth. S. Vitale at Ravenna has in the sanctuary a very interesting representation of Justinian and his empress Theodora (see fig. 3), attended by a numerous suite of courtiers and ladies; these mosaics are certainly of the 6th century, and may be contemporary with Justinian, though the fact that he and Theodora are each represented with a circular nimbus appears to indicate that they were not then alive.

In mosaics of the best periods the treatment of the forms and draperies is broad and simple, a just amount of relief being expressed by delicate gradations of tints. In mosaics of the 9th century the drawing is very awkward, and the folds of the robes are rudely expressed in outline, with no suggestion of light and shade.

A further application of this work was to the decoration of broad bands over the columns of the nave, as at S. Maria Maggiore in Rome, 4th century, and in the two churches of S. Apollinare at Ravenna, 6th century. In some cases almost the whole

interior of the church was encrusted in this magnificent way; as at Monreale Cathedral, the Capella Palatina of Palermo, and S. Mark's at Venice.

In these churches the mosaics cover soffits and angles entirely, and give the effect of a mass of solid gold and colour producing the utmost conceivable splendour of decoration.¹ In many cases vaulted ceilings were covered with these mosaics, as the tomb of Galla Placidia, A.D. 450, and the two baptisteries at Ravenna, 5th and 6th centuries. For exteriors, the large use of mosaic was usually confined to the west façade, as at S. Miniato, Florence; S. Maria Maggiore, Rome; and S. Mark's,



FIG. 3.—Mosaic of Theodora and Attendants, from S. Vitale, Ravenna; over life size.

Venice. In almost all cases the figures are represented on a gold ground, and gold is freely used in the dresses and ornaments—rich jewels and embroidery being represented in gold, silver, sparkling reds, blues and other colours, so as to give the utmost splendour of effect to the figures and their drapery.

The revival of the art of painting in Italy and the introduction of fresco work in the 14th century gave the deathblow to the

¹ Unfortunately the world-wide fame of S. Mark's and the other great churches of Italy has subjected these extraordinary works to the fatal process of "restoration," and wherever any sign of decay in the cement backing (the tesserae themselves are quite indestructible) has given the least excuse the "restorers" have destroyed whole masses of ancient work, and supplied its place with worthless modern copies. The mosaics of the S. Mark's baptistery, and of the apses at S. Miniato, at Pisa, and many other places have in this way been wantonly renewed in recent times.

true art or wall-mosaics. Though at first the simple and archaic style of Cimabue and his pupils Jacopo da Turruta, Giotto, and Taddeo Gaddi was equally applicable to painting or mosaic, yet soon the development of art into greater realism and complexity required a method of expression unfettered by the necessities and canons of mosaic work. Pietro Cavallini, a Roman artist, was one of the last who worked according to the old traditions. His mosaic of the birth of the Virgin in S. Maria in Cosmedin, Rome, executed about the middle of the 14th century, is not without merit, though his superior knowledge of form has only caused his composition to be somewhat feeble and insipid compared with the works of the earlier artists. Even in the 13th century a few good mosaics were produced at Venice and elsewhere. The mosaics from Titian's pictures on the west end of S. Mark's at Venice, Raphael's in the Chigi Chapel in S. Maria del Popolo, and many large pictures in S. Peter's in Rome are the most striking examples of these.

The following list, in chronological order, comprises a selection from among the most important glass wall-mosaics during the period when mosaic-working was a real art.¹

- 4th Century.**
- Rome.** S. Costanza.
S. Maria Maggiore—square panels over the columns of the nave.
S. Pudenziana.
S. Giovanni in Laterano—chapel of SS. Rufina e Seconda.
- Naples.** S. Restituta—baptistry.
- Ravenna.** Orthodox Baptistry—vault.
Tomb of Galla Placidia—vault, 450.
Archbishop's Chapel—vault.
- Rome.** S. Paolo fuori le mura—triumphal arch.
S. Maria Maggiore—square pictures over nave columns, and triumphal arch (?).
S. Sabina—figures on west wall.
S. Ambrogio, Chapel of S. Satiro—vault.
Cathedral—apse.
Cathedral—apse.
- 6th Century.**
- Ravenna.** Arian Baptistry—vault.
S. Apollinare Nuovo—apse and nave, with 9th-century additions.
S. Vitale—apse and whole sanctuary, c. 547.
S. Apollinare in Classe—apse and nave, 549.
SS. Cosmas and Damian—apse.
- Rome.** S. Lorenzo, Chapel of S. Aguilinus—vault.
S. Sophia—walls and vault, c. 550.
Church of St George—apse, &c., and S. Sophia—dome and apse.
- Trebisond.** S. Sophia—apse.
- 7th Century.**
- Rome.** S. Agnese fuori le mura—apse, 626.
S. Teodoro.
S. Stefano Rotondo.
S. Venanzio, baptistry of Lateran.
"Dome of the Rock"—arches of ambulatory, 688.
- 8th Century.**
- Rome.** Baptistry of S. Giovanni in Laterano.
SS. Nereus and Achilles.
Mosque of Al-Aksa—on dome.
Chapel of the Transfiguration.
- 9th Century.**
- Rome.** S. Cecilia in Trastevere—apse.
S. Marco—apse.
S. Maria della Navicella—apse, and "Chapel of the Column."
- Milan.** S. Prassede—triumphal arch.
S. Ambrogio—apse, 832.
- 10th Century.**
- Cordova.** Mihrab (sanctuary) of Mosque.
- 11th Century.**
- Jerusalem.** "Dome of the Rock"—base of cupola, 1027.
Constantinople. Church of S. Saviour—walls and domes.
- 12th Century.**
- Venice.** S. Mark's—narthex, apse and walls of nave and aisles.

- Capua.** Cathedral—apse.
Torcello. Cathedral—apse.
Murano. Cathedral—apse.
Salerno. Cathedral—apse.
Palermo. Capella Palatina, begun 1132—the whole walls.
Church of La Martorana—vault.
Monreale. Cathedral—the whole walls, 1170-1190.
Cefalù. Church of the Nativity, 1169.
Bethlehem. Cathedral—apse, 1148.
Rome. S. Clemente—apse.
S. Francesca Romana—apse.
S. Maria in Trastevere—apse.

- 13th Century.**
- Florence.** Baptistry vault, begun c. 1225 by Fra Jacopo.
S. Miniato—apse and west front.
Rome. S. Paolo fuori le mura—apse.
S. Clemente—triumphal arch, 1297.
S. Giovanni in Laterano—apse by Jacopo da Turruta, 1290.
S. Maria Maggiore—apse and west end by Jacopo da Turruta and Taddeo Gaddi.
S. Maria in Trastevere—apse by Pietro Cavallini, 1291.

- 14th Century.**
- Florence.** Baptistry, finished by Andrea Tafi.
Pisa. Cathedral—east apse by Cimabue, 1302, north and south apses by his pupils.

- Rome.** S. Peter's—navicella, in atrium by Giotto.
S. Maria in Cosmedin—on walls by Pietro Cavallini, c. 1340.
Venice. SS. Giovanni e Paolo—in arch over effigy of Doge Morosini.

The Byzantine origin of these great wall-mosaics, wherever they are found, is amply proved both by internal and documentary evidence. The gorgeous mosaics of S. Sophia and S. Saviour's in Constantinople, 6th century, and the later ones in the monasteries of Mount Athos, at Salonica and at Daphne near Athens, are identical in style with those of Italy of the same date. Moreover, the even more beautiful mosaic work in the "Dome of the Rock" at Jerusalem, 7th and 11th centuries, and that in the sanctuary of the great mosque of Cordova, of the 10th century, are known to be the work of Byzantine artists, in spite of their thoroughly Oriental design. The same is the case with the rarer mosaics of Germany, such as those in S. Gereon at Cologne and at Porenzo.

A very remarkable, almost unique, specimen of Byzantine mosaic is now preserved in the "Opera del Duomo," Florence. This is a diptych of the 11th century, of extremely minute, almost microscopic work, in tesserae of glass and metal, perhaps the only example of tesserae made of solid metal. It has figures of saints and inscriptions, each tessera being scarcely larger than a pin's head. This beautiful diptych originally belonged to the imperial chapel in Constantinople, and was brought to Florence in the 14th century.

2. The second medieval class, mosaic pavements, though of great beauty, are of less artistic importance. This so-called *opus alexandrinum* is very common throughout Italy and in the East, and came to greatest perfection in the 13th century. It is made partly of small marble tesserae forming the main lines of the pattern, and partly of large pieces used as a ground

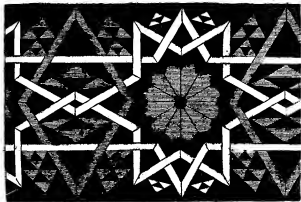

FIG. 4.—Marble Mosaic at Monreale Cathedral.

or matrix. It is generally designed in large flowing bands which interlace and enclose circles, often of one stone sliced from a column. The finest example is that at S. Mark's, Venice, of the 12th century. The materials are mainly white marble, with green and red porphyry, and sometimes glass.

¹ It must be remembered that the earlier mosaics have in most cases suffered much from restoration.

Besides the countless churches in Italy possessing these beautiful pavements, such as S. Lorenzo, S. Marco, S. Maria Maggiore, and S. Maria in Trastevere, in Rome, there are in England, in the Chapel of the Confessor, and in front of the high altar at Westminster, very fine specimens of this work, executed about 1268 by a Roman artist called Odericus, who was brought to England by Abbot Ware, on the occasion of a visit made by the latter to Rome. Another English example is the mosaic pavement in front of the shrine of Becket at Canterbury; this is probably the work of an Englishman, though the materials are foreign, as it is partly inlaid with bronze, a peculiarity never found in Italy. Palermo and Monreale are especially rich in examples of sectile mosaic, used both for pavements and walls—in the latter case generally for the lower part of the walls the upper part being covered with the glass mosaics. Fig. 4 gives a specimen of this mosaic from Monreale cathedral. Its chief characteristic is the absence of curved lines, so largely used in the splendid opus Alexandrinum of Italy, arising from the fact that this class of Oriental design was mainly used for the delicate panelling in wood on their pulpits, doors, &c.—wood being a material quite unsuited for the production of large curves.

3. Glass mosaic, used to ornament ambones, pulpits, tombs, bishops' thrones, baldacchini columns, architraves, and other marble objects, is chiefly Italian. The designs, when it is used to enrich flat surfaces, such as panels or architraves, are very similar to those of the pavements last described. The white marble is used as a matrix, in which sinkings are made to hold the glass tesserae; twisted columns are frequently ornamented with a spiral band of this glass mosaic, or flutings are suggested by parallel bands on straight columns. The cloisters of S. Giovanni in Laterano and S. Paolo fuori le mura have splendid examples of these enriched shafts and architraves.

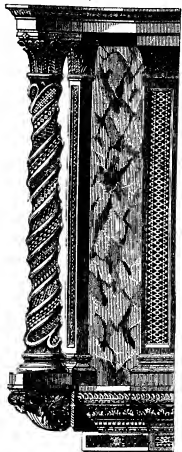

FIG. 5.—Part of Marble Pulpit with glass mosaic, church of Ara Coeli, Rome.

Westminster are the only examples of this work in England. They were executed by "Petrus civis Romanus," probably a pupil of the Cosmati.

In India, especially during the 17th century, many Mahomedan buildings were decorated with fine marble inlay of the class now called "Florentine." This is sectile mosaic, formed by shaped pieces of various coloured marbles let into a marble matrix. A great deal of the Indian mosaic of this sort was executed by Italian workmen; the finest examples are at Agra, such as the Taj Mahal.

4. Mosaics in wood are largely used in Mahomedan buildings, especially from the 14th to the 17th centuries. The finest

specimens of this work are at Cairo and Damascus, and are used chiefly to decorate the magnificent pulpits and other woodwork in the mosques. The patterns are very delicate and complicated, worked in inlay of small pieces of various coloured woods, often further enriched by bits of mother-of-pearl and minutely carved ivory. This art was also practised largely by the Copts of Egypt, and much used by them to ornament the magnificent iconostases and other screens in their churches.

Another application of wood to mosaic work, called "intarsiatura," was very common in Italy, especially in Tuscany and Lombardy, during the 15th and early 16th centuries. Its chief use was for the decoration of the stalls and lecterns in the church choirs. Very small bits of various coloured woods were used to produce geometrical patterns, while figure subjects, views of buildings with strong perspective effects, and even landscapes, were very skillfully produced by an inlay of larger pieces. Ambrogio Borgognone, Raphael, and other great painters, often drew the designs for this sort of work. The mosaic figures in the panels of the stalls at the Certosa near Pavia were by Borgognone, and are extremely beautiful. The stalls in Siena cathedral and in S. Pietro de' Casinetti at Perugia, the latter from Raphael's designs, are among the finest works of this sort, which are very numerous in Italy. It has also been used on a smaller scale to ornament furniture, and especially the "Cassoni," or large trousseau coffers, on which the most costly and elaborate decorations were often lavished.

AUTHORITIES.—*Classical.* An excellent account of the subject, with full references, is given by Gauckler in Daremberg and Saglio, *Dictionnaire des antiquités*, s.v. "Musivum opus"; the translations there given of the *poeci* following are important; G. Ciampini, *Vetera monumenta* (1690-1699); A. Furietti, *De musivis* (1752); S. Lysons, *Roman Antiquities of Woodchester* (1797) and *Reliquiae britannico-romanae* (1813); F. Mazois, *Ruines de Pompéi* (1812-1838); *Real museo borbonico* (1824-1857); F. Artaud, *Histoire de la peinture en mosaïque* (1835); *Monumentos arquitectonicos de España* (1850-1883); Wilimowsky, *Römische Mosaiken aus Trier und dessen Umgegend* (1888).

Christian. Theophilus, *Diversarum artium schedula*, li. 15; *S. Kensington Museum Art Inventory*, pt. 1. (1870); Renan, *Mission de Phénicie* (1875); Garrucci, *Architettura cristiana* (1879-1882), vol. iv.; De Rossi, *Mosaici cristiani di Roma* (1876-1884); Parker, *Archaeology of Rome, and Mosaic Pictures in Rome and Ravenna* (1866); Barbier de Jouy, *Les Mosaïques chrétiennes de Rome* (1857); Gravina, *Duomo di Monreale, Palermo* (1859 seq.); Serradifalco, *Monreale ed altre chiese siculo-normanne* (1838); Salazar, *Mon. dell' arte merid. d'Italia* (1882); M. D. Wyatt, *Geometrical Mosaics of the Middle Ages* (1849); Salzenberg, *All-christliche Baudenkmale von Constantinopel* (1854); Pulgher, *Eglises byzantines de Constantinopel* (1883); Texier and Pullan, *Byzantine Architecture* (1864); Quast, *All-christliche Bauwerke von Ravenna* (1842); J. P. Richter, *Die Mosaiken von Ravenna* (1878); M. de Vogüé, *Église de la terre sainte* (1860); Milanese, *Del Arte del vetro pul musaico* (16th century, reprinted at Bologna in 1864); Rohault de Fleury, *Monuments de l'Art* (1866); J. Kreutz, *Basilica di S. Marco, Venezia* (1843); Gally Knight, *Ecclesiastical Architecture of Italy* (1842-1844); C. G. Fossati, *Aya Sophia* (1852); A. N. Didron, "La peinture en mosaïque," *Gaz. des B. Arts*, xi. 442; Gerspach, *La Mosaïque* (1883); A. L. Frothingham, "Les mosaïques de Grottaferrata," *Gaz. arch.* (1883); E. Müntz, *La Mosaïque chrétienne pendant les premiers siècles* (1893); G. Clausse, *Basiliques et mosaïques chrétiennes* (1893); Ainalov, *Mosaïken des IV. u. V. Jahrhunderts* (1805); P. Saccardi, *Iconografia de la cappella palatina* (1895); Di Marzo, *Delle Belle arti in Sicilia*; Sangiorgi, *Il Battistero della basilica Ursiana di Ravenna* (1900); J. Kurth, *Die Mosaiken der christlichen Aera*, I. *Die Mosaiken von Ravenna* (1902); J. P. Richter and A. C. Taylor, *The Golden Age of Classic Christian Art* (1904); on the mosaics of S. Maria Maggiore, which the authors assign to the 2nd or 3rd century A.D.; some excellent reproductions are given; Schmitt and Kluge, "Kachrie Djamii" (*Bulletin de l'institut impériale russe à Constantinople*, xi., 1906; text in Russian).

Moslem.—Hessner, *Arabische und all-italienische Bauwerke* (1880); Prangey, *Mosquée de Cordoue* (1830); Owen Jones, *Alhambra* (1842); De Vogüé, *Temple de Jérusalem* (1864); Texier, *Asie Mineure* (1862) and *L'Arménie et la Perse* (1842-1852); Bourgoin, *Les Arts arabes* (1868); Coste, *Monuments modernes de la Perse* (1867); Flindin and Coste, *Voyage en Perse* (1843-1854); Gayet, *L'Art arabe* (1893).

Wood Mosaic-Tarsia.—Omali del coro di S. Pietro Cassinese di Perugia (1830); Caffi, various works on Raffaello de Brescia and other intarsiatori (1851); *Tarsie ed intagli di S. Lorenzo in Genova* (1878); and Scherer, *Technik und Geschichte der Intarsia* (1891).
(J. H. M.; H. S. J.)

Modern Mosaic.—The art of mosaic for mural decoration has never been deeply implanted in the artistic sensibilities of the north of Europe, nor has it been employed much either in France, or Germany, or England. It ceased to be generally adopted in Italy when fresco, oil and tempera painting came into vogue. Gothic architecture is ill-suited to its robust claims as a decorative art; and the incoming fashion for the latest and least interesting development of classical architecture, "Palladian," divorced not only it, but mural painting also, from all architectural schemes. To be properly consequent and effective, buildings, ecclesiastical or public, should be constructed with the intention of being covered almost entirely by mosaics, which demand rich environment, marble or other colour; mosaic is essentially a colour medium. It is therefore scarcely surprising that when mural decoration became pre-eminently pictorial, and gestures and expression grew complicated, elaborate, and naturalistic, an art limited in its powers of presenting such manifestation of realistic design was relegated into the limbo of obscurity.

There are no instances of the use of mosaic in England after the Roman occupation. The Normans, who derived it from the Greeks and Saracens, and adopted it in Sicily, did not import it either to France or England. Although English churches, and French also, were highly decorated with polychromy from early times up to the 16th century, there is no evidence of mosaic ever having been used. The revival of a school of mosaicists in Rome during the 17th century, employed in the decoration of St Peter's, and here and there sparsely engaged in other churches, led to the idea which Wren would have carried into effect, namely, making use of mosaic for the cathedral of St Paul's in London; but his scheme, if it was ever really entertained, was not carried out, as we all know; and the art, which might have become the fashion in England, remained an exotic. Even late into the years of the 19th century mosaic decoration was regarded by classical purists as a barbarous art, and the glorious decorations in that material to be seen in Sicily, Italy, Greece, Asia Minor and Russia were disregarded as works of high art. They were in many cases cut out to provide room for extravagant and vulgar designs in fresco or tempera, unmeaning, undecorative, and wholly abominable as decoration. Those Roman mosaics over the altars in St Peter's, being copies of celebrated oil pictures, while they cannot be denied excellence as such and marvellous dexterity, reveal the worst possible taste, for they attempt to represent adequately, in cubes, touches of the brush which were spontaneous, fluid, thick and thin, and as sensitive and spontaneous as the finger pressure on the violin string, so accurate that the least deviation from absolute position produces discord.

The restrictions on mosaic are many, and some are obvious. In the first place, mosaic is not suited for a small scale of design. It is true that in the Opera del Duomo in Florence there is a miniature mosaic (executed in the 12th century) of extraordinary beauty, which must have taken a lifetime to execute; but still this remains a curiosity, a bit of craftsmanship rather than a great work of art. There is also a copy of Mr Holman Hunt's "Finding the Saviour in the Temple," executed for Clifton College by assistants in Messrs Powell's establishment in Whitefriars, London; it is admirably done, no doubt, but it is a long way behind the original, which is a design wholly ill adapted to mosaic. There are several other instances, notably one by Mr H. Holiday of "The Last Supper," where mosaic has been employed to translate a beautiful design which would have been more satisfactorily executed either in oil or water colours. The primal and most obvious limitation is in matters of detail—detail as regards a multiplicity of forms, many gradations either of colour or tone and naturalistic accidents. In this respect good mosaic is like good *basso relieve*; it is accomplished by firmly pronounced outlines, unconfused masses, large planes unbroken up by small adjuncts, and generalized and conventionalized forms and simple colour. So all small curves, as well as small tints, should be eliminated, because it is not in the nature of the material to do them justice. One can scarcely conceive

a choice less happy for mosaic than the centre group taken out of the upper portion of the Disputa fresco in the Vatican by Raphael, yet this florid piece of work, so facile in creation, was chosen to be executed on the eastern wall of the morning chapel in St Paul's.

It is useless to illustrate the many similar mistakes that have been made. They were made in some of the earlier work in the choir of St Paul's. The best example of mosaic on a small scale is in Ravenna, the tomb of Galla Placidia; the best upon a large scale is the great Christ at the east end of the cathedral at Monreale. These two works absolutely justify the means to the end. Interesting are the designs made by Sir Edward Burne-Jones for the mosaics for the American church in Rome, but the execution and colour are alike monotonous. The cathedral of Chester contains a series of mosaic pictures designed by Mr Clayton. The Guards' chapel in St James's is adorned likewise by the same artist, under the direction of the late Sir Arthur Blomfield. In the chapel for the school at Giggleswick are mosaics designed by T. G. Jackson, R.A., admirably and broadly treated in true mosaic character; these were executed *in situ*, and not, according to the modern habit, upon paper, away from their environment and by a foreign firm. Those mosaic pictures which are placed in niches in the great gallery of South Kensington Museum are failures *quod* mosaic, though the designs in many instances are fine, notably those by Lord Leighton and Val Prinsep; but their execution is uninteresting, because the cubes are laid so flatly and so evenly that they suggest an oil picture *appliqué* upon a flat ground.

Messrs Powell have been employed on several occasions to decorate churches with mosaic. This firm has adopted the old style, and rejected the new one initiated by Dr Salvati of Venice. If we observe the surface of a fine Greek mosaic, such as that of Andrea Tafi in the Baptistery of Florence, or the few remains of unrestored mosaic in St Mark's, Venice, or indeed other works scattered over Italy, we shall see that it is rough, not smooth; that the cubes are irregular in shape; that there is always a space of the ground colour left, red or white, and visible between each cube. In modern mosaic, with rare exceptions, restoration or other, the cubes have been jammed up closely together, and the surface is as smooth as a piece of paper; thereby is engendered a mechanical and uninteresting surface, over which light plays with monotony, and hence that brilliant and scintillating effect so essentially the character of true mosaic is absent. This defect—and it is a grave one—is evident in the works in mosaic more or less recently set up in Paris, notably in the apse of the Pantheon, the east end of the Madeleine, and the vaulting of the great staircase of the Louvre. Those in the apse are finely designed, but scarcely look like mosaic, those in the Madeleine still less so, and the last not at all.

The artist who designs for this material must set aside all the principles he has learned to estimate in paint, either of oil or tempera. As an instance of a painter, pre-eminently delicate in his colour and tone, failing as a mosaic designer we may quote Cimabue, whose beautiful designs in the cathedral at Pisa would have been far more effective had the artist painted them upon the wall with the medium in the requirements of which he was so great a master. The same criticism may apply to the mosaics in recent years set up on the west front of Santa Maria del Fiore in Florence. The very first principles which go to make a fine picture are just those which should be avoided in mosaic—elaborate modelling, delicate transitions of light and shade and picturesque effects of dark and light, materialistic resemblance indeed. The designer for mosaic should ever bear in mind his material, and in his designs for it he should accentuate those characteristics which belong essentially and specifically to mosaic and to *no other technique*. If he is a painter, he must forget his lessons in that art and take up with new ones—those which teach broad masses of colour obtained in lines. He will find that effects gained by a technique employed in oil colour look bald and ridiculous when translated into mosaic. Water-colour and pastel are by far the best media for cartoons to be copied in mosaic. We do not know how these were executed

in ancient days; probably the design was drawn on the wall, and there were no cartoons. The master not only invented, but he was the master-workman also, and that is how it should be. The probability is that the custom of drawing the design upon the wall practised by the early frescanti was the survival of a method adopted by the mosaicists, just as their method repeated that of Roman and Greek wall-painters. Of course this direct method leads to a large style, a style harmonizing with environment, scale, &c.; and tendency is to draw large in a large building, to draw small in a small one. Anyhow, this is quite certain, that all the fine Byzantine and 13th century mosaics, as well as wall paintings, were executed *in situ* and not away, as was the usual custom in England and elsewhere until recently.

Mr Harry Powell has permitted the writer to make use of some of his reflections upon the mosaicist's art in the following notes. The mosaicist should not separate the artistic from the technical details of his craft. He must study not only the decorative effect, form, colour and spacing of his design, but the surface to be covered as well as the materials with which he builds.

Surface.—Good brick-work, the mortar joints slightly cut back, affords the best foundation for mosaic. The hollow and sharp-edged joints provide a key for the cement into which the cubes will be set, and they diminish the risk of sagging, a not uncommon event if the cement is not welded to the wall by being well pressed into the joints. If the mosaic is to be applied on stone, the stone must be notched and well roughened to provide support. Whether the surface is brick or stone, it must be well saturated with boiled oil to prevent suction, because if too much suction takes place the powder only of the cement will remain and the cubes will drop out.

Cement.—A cement suitable for mosaic is one which retains its tenacity, which can be applied in layers, which sets slowly, and which is not liable to change colour after long exposure. These conditions are best met by an oil cement. One consisting of equal weights of white oxide of zinc and carbonate of zinc, mixed with double boiled oil and containing small proportions of wax, gold size and slacked lime gives good results. A cement can either be white or red, white being greyer, one is desirable, red where a richer effect is desirable. It is generally mixed with a small portion of oxide of iron or oxide of manganese, which prevents the whiteness of the joints from rendering adjacent tints grey from a distance.

Atmospheric Corrosion.—As the atmosphere of modern towns is more corrosive than that of medieval Venice or mediæval Rome, it is important that, in choosing the cement and the materials to be imbedded in it, the mosaicist should be certain that they are impervious to atmospheric impurities.

Glass.—Although marble, mother of pearl, and other substances have been, and are still, occasionally used, the predominant material in ancient as well as modern mosaics is glass. When prepared with due regard to the continuing proportions of its ingredients, glass is impervious to the action of ordinary acids, and is practically indestructible. It can be made to assume almost every shade and tint of colour (see GLASS). There are many kinds of glass, but for mosaic work either a potash-lead or a soda-lime glass is usually employed. Both of these glasses can be rendered opaque by mixing with the ingredients either oxide of tin or a mixture of felspar and fluorspar. Glass rendered opaque by the admixture of felspar and fluorspar has a bright, vitreous, easily cleaned surface, and readily develops brilliant colours.

Production of Colours.—Colours are obtained by mixing and melting with the ingredients of the opaque glass small proportions of certain metallic oxides. Oxide of chalk gives a purple blue; and when copper gives a peacock blue; oxide of copper with oxide of iron gives a green; oxide of copper mixed with oxide of iron and a strong reducing agent gives a red; oxide of chromium a green; oxide of nickel a purple; oxide of uranium a yellow; and oxide of manganese a violet—or a black if a larger quantity of oxide is used.

Manufacture of Glass Slabs.—The mixtures, in a state of powder, are shovelled into crucibles standing round the grate of a furnace, and when fusing is complete the viscous glass can be coiled upon the heated end of an iron rod. The tesserae for use, vary much in the way that thick treacle may be coiled round the bowl of a spoon. A mass of molten glass, thus collected, is allowed to fall upon a flat iron table, and is pressed into a slab about 6 in. square and $\frac{1}{2}$ in. thick. The slabs are removed to an oven, where they are allowed to cool slowly, and when cool are removed and broken by a hammer or a miniature guillotine into tesserae or cubes. The fractured edges of the tesserae is used for the surface of the mosaic.

Gold and Silver Slabs.—The tesserae containing gold or silver leaf are as impervious to surface corrosion from the effects of atmosphere as the solid colours. The process of manufacturing a gold or silver slab for mosaic work is to spread the metallic leaf on a very thin tray of transparent glass, about 5 in. in diameter,

and after it has been heated to press upon the surface of the leaf a mass of molten glass, so as to create cohesion between the molten glass and the glass tray through the pores of the metallic leaf. The slabs thus formed contain gold, silver or platinum leaf hermetically imprisoned between two layers of glass. The slabs are cut up into tesserae or cubes by means of a diamond or glass-cutter's wheel. Only one surface can be used for mosaic work.

Tinted Metals.—By using coloured glass for the thin glass trays which form the surface of the metallic slabs a variety of tinted metallic effects are obtained. Moreover, if the glass which is to form the background is coloured, and if the slab after it has been cooled is strongly reheated, the leaf becomes sufficiently disintegrated to allow the colour of the background to show through, with the result that the colour effect of the metallic leaf is modified.

Palette and Tools.—The palette of the mosaic worker is a shallow box with many partitions, each division containing different coloured tesserae. The only tools required are clippers, for shaping the tesserae, and a pointed awl for pricking through the cartoon into the cement the outlines of the design. Although the process and tools are simple, it requires prolonged training of mind, hand, eye and fingers to enable a workman to create in mosaic a living representation as distinguished from a lifeless copy of the master craftsman's design.

Drawing directly on the Wall. Curved Surfaces.—If the mosaicist desires to draw his cartoon directly upon the wall, a necessary procedure where curved surfaces are presented, he goes to work in the following manner. He causes a model to be made to scale of a dome, semi-dome or spandrel and upon it he draws his design with a brush in strong red pigment, having previously squared up the whole surface to scale. This done, he causes the dome, semi-dome or spandrel to be covered over with thick brown paper. This being attached to the wall with white lead sufficient only to give temporary adhesion, the brown paper is squared up to the scale of the small sketch; each square being relatively numbered. The master then sets his pupils to work to draw mechanically and copy accurately from the small design on to the full-sized dome, semi-dome or spandrel. This done, the master follows on, correcting with charcoal or brush until the whole design is developed in strong outline. Having made a slightly coloured sketch, the master with the aid of his pupils proceeds to mix all the tints in water-colour, adding *colla di pesce* or fish glue, and a little honey to prevent cracking. He then applies every tint separately, keeping each distinct, and above all minding that the local colours of all half-tints are different from the colour of all shadows. This done, he dips his brush in black and draws all the outlines, the thickness of which depends upon the distance which will intervene between his work and the spectator; in order that the black may not appear cold from a distance, he will add to one side of the line, a red line, thicker or thinner than the black, according to the effect he wishes to produce. It is sometimes effective to add upon the other side of the black line a green line, so that the purple effect of the black and red shall be modified.

Colour.—We now come to the great question of colour and how to obtain it simply, and so that from a distance a blurred and woolly effect is not obtained. There should be a marked and sharp definition between all tints; they should not be fused; they should look sharply defined, as the squares upon a chess-board, and appear crude and brutal. The work which looks least refined near at hand looks more finished at a distance. Red and blue lines alternately laid, either more red or more blue as the purple is intended to tend towards red or blue, make the best purple. Green is best made with yellow and blue lines, the masses being separated by red lines, and the shadows of green should be red or blue; if red, they should be outlined with blue; if blue, with red. Red should be treated flatly, shaded with a deeper red, which should be of a warmer tone than the lights. Blue should be shaded with blue or red; and it is well to mix green tesserae with the blue in the lights, and again green tesserae with the blue or red shades to modify crudity. Pure white should be very sparingly used; it expands greatly at a distance. The best white is that which is of the tone of Naples yellow. Whenever it is necessary to use pure white, either a yellow or pink line should be set on one side of it.

It is impossible to keep the *flesh* too simple. The local colour, i.e. a red orange, is the staple colour. Features should be drawn

in strong red or burnt sienna, or a rich brown. The outlines of limbs or the contours of faces should be made first with a green line, a little darker than the local tints, then a red line darker still, then a black or brown line. *White draperies* are capable of being treated with endless variety. Their shadows may be green, red, blue, grey or yellow. If the white drapery is to take a neutral tone when seen from a distance, all these tints should be employed, because when mixed those positive colours appear neutral when seen from afar.

Gold drapery has a fine effect. Bright gold expands to four times the width of the line, so that the lines of gold should be thin. It may be that the gold drapery is to appear greenish; when that is desirable the folds should be drawn in green outlined with red. All deep shades should be treated with red and hot browns. As gold expands so considerably, a larger interval should be left between the tesserae than between any other colour, even white. Each tessera should have a thin space of the ground colour round it. The tesserae should never be jammed: it is that which causes so many modern mosaics to look like oil-cloth or chromo-lithographs.

The Finished Cartoon.—The finished cartoon, having been coloured in lines, should look exactly like the finished mosaic as regards effect; and the master, in making his cartoon, should always bear in mind that he is designing for mosaic, and not making a finished picture. The cartoon, when complete, is taken off the wall and cut up in pieces. Each piece is then carefully traced. The space upon the wall corresponding to each section is then covered with cement, but only upon that portion of the space which can be worked in mosaic in a day. The mosaic worker then applies the portion of the tracing upon the wet cement, and with a sharp point he pricks through the paper upon the lines thereon drawn; on removing the tracing he will find indents within the surface of the cement, which give him his cue to all the forms. Setting up the coloured design by his side, he takes the tesserae, which exactly correspond in colour and tone with those on the drawing, and begins his work, commencing from the outline and working inwards towards the centre, the lightest portion being left to the last. Here comes in the real test whether the craftsman is capable or the reverse. This is soon judged by the master, who will put the work in and out until he is satisfied with the result. Unless the master has himself gone through the drudgery of laying the cubes he can be no teacher. He must be a craftsman as well as a designer, and must know by experience and practice in a very difficult craft what the material can do with ease and what it is not called upon to do by reason of its inherent limitations. If he has not so trained himself he is certain to pictorialize what he should conventionalize; and, moreover, he will set technical difficulties in the way which are impossible to overcome. He must aim at the greatest simplicity without dullness, at producing the greatest effect by the simplest means, and to do that he must know his material or fail. (W. B. Rt.)

MOSBY, JOHN SINGLETON (1833–), American soldier, was born in Edgemont, Powhatan county, Virginia, on the 6th of December 1833. He graduated at the university of Virginia in 1852, was admitted to the bar in 1855, and practised law in Bristol, Washington county, Virginia, until the beginning of the Civil War, when he joined the cause of the South. He enlisted as a private in the Washington Mounted Rifles, which became a part of General J. E. B. Stuart's 1st Virginia Cavalry, and of which he was adjutant for a time. In June 1862, after having gone over the ground alone on scouting duty, he accompanied Stuart in his ride round McClellan's entire army. Early in 1863 he secured Stuart's permission to undertake a quasi-independent command. In Fairfax county and then in Fauquier and Loudoun counties (known as Mosby's Confederacy), within the Federal lines, he raised, mounted, armed and equipped a force of irregulars. On the night of the 8th of March 1863, with about 30 men, he penetrated the Federal lines at Fairfax Court-House and took 33 prisoners, including Brigadier-General Edwin H. Stoughton, commanding the 2nd Vermont brigade; and he became famous for other such exploits. In the North

he was regarded as a guerrilla who disregarded the rules of war, and in the autumn of 1864, Sheridan, acting under orders from Grant, shot and hanged seven of Mosby's men without trial; in November Mosby retaliated by hanging seven of Custer's cavalrymen. Eventually, on the 21st of April 1865, twelve days after the surrender of General Lee, he disbanded his men and surrendered; and through the influence of General Grant, who later became his personal friend, he was paroled. He returned to his legal practice, joined the Republican party, canvassed Virginia in 1874 for General Grant, in 1878–1885 was United States consul at Hong-Kong, and after practising law in San Francisco, was assistant attorney in the Federal Department of Justice from 1904 to 1910. He wrote *Mosby's Reminiscences and Stuart's Cavalry Campaigns* (Boston, 1887), and—a defence of Stuart and of Lee—*Stuart's Cavalry in the Gettysburg Campaign* (New York, 1908).

See J. Marshall Crawford, *Mosby and his Men* (New York, 1867); A. Monteiro, *War Reminiscences by the Surgeon of Mosby's Command* (Richmond, Virginia, 1890); James J. Williamson, *Mosby's Rangers* (New York, 1909); John W. Munson, *Reminiscences of a Mosby Guerrilla* (New York, 1906); John H. Alexander, *Mosby's Men* (New York, 1907); and *Partisan Life with Mosby* (New York, 1867), by John Scott, who drafted the Partisan Ranger Law, under which Mosby's command operated.

MOSCHELES, IGNAZ (1794–1870), Bohemian pianist, was born at Prague on the 30th of May 1794, and studied music at the Conservatorium under the direction of Dionys Weber. At the age of fourteen he made his first appearance before the public in a pianoforte concerto of his own composition with marked success. In 1814 he prepared, with Beethoven's consent, the pianoforte arrangement of *Fidelio*, afterwards published by Messrs Artaria. In the following year he published his celebrated *Variationen über den Alexandermarsch*, a concert piece of great difficulty, which he played with so great effect that he was at once recognized as the most brilliant performer of the day. He then started on a tour, during the course of which he visited most of the great capitals of Europe, making his first appearance in London in 1822, and there securing the friendship of Muzio Clementi and John Cramer. For a concert given by the latter he wrote his famous *Hommage à Händel*, a duet for two pianofortes, which afterwards became a lasting favourite with the public. During a visit to Berlin in 1824 he first became acquainted with Mendelssohn, then a boy of fifteen; and a friendship sprang up between them which was severed only by Mendelssohn's early death (see *Briefe von Mendelssohn-Bartholdy an Ignaz und Charlotte Moscheles*, 1888). In 1826 Moscheles married Charlotte Emden at Hamburg, and settled permanently in London. He was undoubtedly for some considerable time the greatest executant of his age; but, using his brilliant touch as a means and not as an end, he consistently devoted himself to the further development of the true classical school, interpreting the works of the great masters with conscientious fidelity, and in his extempore performances, which were of quite exceptional excellence, exhibiting a fertility of invention which never failed to please the most fastidious taste. In 1837 Moscheles conducted Beethoven's Ninth Symphony at the Philharmonic Society's concerts with extraordinary success, and by his skilful use of the baton contributed to the prosperity of this association. During the course of his long residence in London he laboured incessantly in the cause of art, until the year 1846, when, at Mendelssohn's earnest solicitation, he removed to Leipzig to carry on a similar work at the Conservatorium, then recently founded. In this new sphere he worked with unabated zeal for many years, dying on the 10th of March 1870. Moscheles' numbered works extend to 142, apart from minor pieces; his most important compositions are his Pianoforte Concertos, Sonatas and Studies (*Études*, op. 70; and *Characteristische Studien*, op. 95); *Hommage à Händel*; and his three *Allegri di bravura*.

See *The Life of Moscheles* (1873), a translation by A. D. Coleridge of Mme Moscheles' *Aus Moscheles Leben* (1872).

MOSCHEROSCH, JOHANN MICHAEL (1601–1669), German satirist, was born at Willstädt, near Strassburg, on the 5th of March 1601. He received a careful early education at the

Latin School at Strassburg, and in 1620 began his academic career as a student of jurisprudence. After being for some years tutor in the family of the Graf von Leiningen-Dachsburg, he finally became privy councillor to the landgrave of Hesse-Cassel. He died at Worms on the 4th of April 1669. Under the name of "Der Träumende," Moscherosch was a member of the *Fruchtbringende Gesellschaft*, a society founded by Prince Ludwig of Anhalt-Cöthen, in 1617, for the purification of the German language and the fostering of German literature. His most famous work is the *Wunderliche und wahrhaftige Geschichte Philanders von Sittewald* (anagram of Willstädt) (1642-1643), for which he took as his model the *Sueños* (visions) of the famous Spaniard Francisco Gomez de Quevedo y Villegas (1580-1645). Hardly inferior to the "visions" is the *Insomnis cura parentum, Christliches Vermächtnis eines Vaters*, which was published at Strassburg in 1643 and again in 1647. Noteworthy is also *Die Patientia*, discovered in 1897 in MS. in the municipal library at Hamburg.

Selections from Moscherosch's writings have been published by W. Dittmar (1830), F. Bobertag (in Kürschner's *Deutsche National-Literatur*, xxxii., 1884), and K. Müller (in Reclam's *Universalschulbibliothek*). Reprints of the *Insomnis cura parentum* and *Patientia* have been published by L. Parisier (1893 and 1897), who is also the author of *Beiträge zu einer Biographie von Moscherosch* (1891). See also M. Nickels, *Moscherosch als Pädagog* (1883); J. Wirth, *Moscherosch's Geschichte* (1888).

MOSCHOPULUS ("little calf," also a nickname), **MANUEL**, Byzantine commentator and grammarian, lived during the end of the 13th and the beginning of the 14th century. His chief work is *Ἐρωτήματα γραμματικὰ*, in the form of question and answer, based upon an anonymous epitome of grammar, and supplemented by a lexicon (*συλλογή*) of Attic nouns. He was also the author of *scholia* on the first and second books of the *Iliad*, on Hesiod, Theocritus, Pindar and other classical and later authors; of riddles, letters, and a treatise on the magic squares. His grammatical treatises formed the foundation of the labours of such promoters of classical studies as Manuel Chrysoloras, Theodoros Gaza, Guarini, and Constantine Lascaris.

A selection from his works under the title of *Manuelis Moschopuli opuscula grammatica* was published by F. N. Titzel (Leipzig, 1822); see also C. Krumbacher, *Geschichte der byzantinischen Literatur* (1897) and M. Treu, *Maximi monachi Planudis epistulae* (1890), p. 208.

MOSCHUS, Greek bucolic poet and friend of the Alexandrian grammarian Aristarchus, was born at Syracuse and flourished about 150 B.C. He was the author of a short epic poem, *Europa*, and a pretty little epigram, *Love, the Runaway*, imitated by Torquato Tasso and Ben Jonson. The epitaph on Bion of Smyrna, wrongly supposed to have been his tutor, was in all probability written about the time of Sulla (see F. Bücheler in *Rheinisches Museum*, xxx., 1875). The poem on *Megara* (the wife of Heracles) is probably not his, but a few other pieces, undoubtedly genuine, have been preserved. His poems are nearly all in hexameters. They are usually printed in editions of Bion and Theocritus, and have been translated into many European languages.

The text has been edited by U. von Wilamowitz-Möllendorf, in the *Oxford Scriptorum classicorum bibliotheca* (1905); there are English translations by J. Banks in Bohn's *Classical Library* (1853), and by Andrew Lang (1889), together with Bion and Theocritus. See F. Susemihl, *Geschichte der griechischen Literatur in der Alexandrinerzeit*, i. 231 (1891), and article BION.

MOSCOW (Russian *Moskva*), a government of Central Russia, bounded by the governments of Tver on the N.W., Vladimir and Ryazan on the E., Tula and Kaluga on the S., and Smolensk on the W., and having an area of 12,855 sq. m. The surface is undulating, with broad depressions occupied by the rivers, and varies in elevation from 500 to 850 ft. The government is situated in the centre of the Moscow coal-basin, which extends into the neighbouring governments. Its geology has been carefully studied, and it appears that in the Tertiary period the surface of this province was already continental; but during the Cretaceous period it was to some extent overflowed by the sea. Jurassic deposits are represented by their upper divisions

only; the lower ones, as well as Triassic and Permian deposits, are wanting. The Carboniferous deposits are of a deep-sea origin, and are only represented by the upper division which lies upon Devonian deposits, discovered in an artesian well at Moscow at a depth of 1508 ft. The pendulum anomaly, mentioned by Kaspar Gottfried Schweitzer (1816-1873), has been investigated. It appears in a zone 10 m. wide and about 95 m. long from west to east, and is positive (+10.6') to the north of Moscow and negative (-2.7') to the south.

The government is drained by the Volga, which skirts it for a few miles on its northern boundary, by the navigable Sestra, which brings it into communication with the canals leading to St Petersburg, by the Oka, and by the Moskva. The Oka and Moskva from a remote period have been important channels of trade, and continue to be so notwithstanding the development of the railways. The Oka brings the government into water communication with the Volga. Extensive forests (39% of the entire area) still exist. The soil is somewhat unproductive; agriculture is carried on everywhere, but only two districts export corn, all the others being more or less dependent on extraneous supplies. The principal crops are rye, oats, barley, potatoes, with some flax, hemp and hops.

The population, 1,013,700 in 1873, numbered 2,430,549 in 1897, and 2,733,300 in 1906. They are nearly all Great-Russians and belong to the Greek Church (4% Nonconformists). The importance of the Moscow government as a manufacturing centre is steadily increasing, and it now stands first in Russia. The chief factories are for cottons, woollens, silks, clothing, chemicals, sugar refineries, distilleries, iron-works. There is besides a very great variety of minor industries—such as those concerned with gold thread and gold brocades, gold and silver jewelry, bronze, perfumery, sweets, tobacco, tanneries, gutta-percha, furniture, carriages, wall-paper, toys, baskets, lace, and papier-mâché. The government is divided into 13 districts.

The prehistoric archaeology of Moscow has been carefully studied. This district has been inhabited since the Stone Age. Bronze implements are rare, and there are places where instruments of stone, bone and iron are found together. The inhabitants who constructed the burial mounds in the 10th to 12th centuries seem to have been of Finnish origin, and were poorer, as a rule, than their contemporaries on the Volga.

MOSCOW, (Russian *Moskva*), the second capital of the Russian empire, and chief town of the government of the same name, in 55° 45' N. and 37° 37' E., on both banks of the river Moskva, a tributary of the Oka. It is by rail 400 m. from St Petersburg, 1017 from Odessa, and 814 from Warsaw. It lies to the north of the most densely peopled parts of Russia (the "black-earth region"), whilst the country to the north of it is rather thinly peopled as far as the Volga, and very sparsely beyond that. The space between the middle Oka and the Volga, however, was the cradle of the Great-Russian nationality (Novgorod and Pskov excluded); and four or five centuries ago Moscow had a quite central position with regard to that region.

The present city covers an area of 32 sq. m. (about 40 when the suburbs are included). In the centre, on the left bank of the Moskva, stands the *Kreml* or Kremlin, occupying the Borovitsky hill. To the east of the Kremlin is the Kitay-Gorod, formerly the Great Posad, the chief centre of trade. The Byelyi-Gorod, which was formerly enclosed by a stone wall (whence the name), surrounds the Kremlin and the Kitay-Gorod on the west, north, and north-east. A line of boulevards now occupies the place of its wall (destroyed in the 18th century), and forms a first circle of streets round the centre of Moscow. The Zemlyanoy-Gorod (earthen enclosure) surrounds the Byelyi-Gorod, including the Zamoskoryechnie on the right bank of the Moskva. The earthen wall and palisade that formerly enclosed it no longer exist, their place being taken by a series of broad streets with gardens on both sides—the Sadovaya, or Gardens Street. The fourth enclosure (the Kamer College earthen wall) was made during the reign of Catherine II.; it is of irregular shape, and encloses the outer parts of Moscow,

whilst the suburbs and the villages which have sprung up on the highways extend some miles beyond.

The Kremlin is an old fort of pentagonal (nearly triangular) shape, about 100 acres in extent, occupying a hill 130 ft. above the level of the Moskva. It is enclosed by a high stone battlemented wall 2430 yds. in length, restored during the 19th century, and having nineteen towers. Its five gates are surmounted by towers and are all noteworthy. The Spasskiya (Saviour's) Gate was erected in 1401 by a Milanese architect; the Gothic tower (203 ft.) that surmounts it was added in 1626 by the English architect, Holloway. A sacred picture of the Saviour ("the palladium of Moscow") was placed upon it in 1647, and all who pass through the gate uncover. The towers surmounting the other four gates were erected by order of Ivan III. Of the sacred buildings of the Kremlin the most venerated is the Uspenskiy cathedral. The former church of this name was erected in 1326 by the tsar, Ivan Kalita, but, on its falling into disrepair, a new one was built on the same place in 1475-1479, by the Bolognese architect, Fioraventi, in the Lombardo-Byzantine style, with Indian cupolas. It was restored each time after being pillaged or burnt in 1493, 1547, 1682 and 1812. It contains the oldest and most venerated holy pictures in Russia, one of which is attributed to the metropolitan Peter, another to St. Luke. The cathedral possesses also the throne of Vladimir I., and numerous relics of saints, some of which date from the 14th century. The Russian metropolitans and patriarchs were consecrated in this cathedral, as well as the tsars after Ivan IV. The Arkhangel cathedral, on the opposite side of the square, was originally built in 1333, and a new one was erected in its place in 1505-1508. It contains the tombs of the tsars from Ivan Kalita (1340) to Ivan Alexeievich (1696), and possesses vast wealth. The Blagovyeshchensk cathedral, recalling the churches of Mount Athos (in Turkey), was first built in 1397, rebuilt in 1484-1489, and restored in 1883-1896; the remarkable pictures of Rublev (1405) are still preserved. It was the private chapel of the tsars, and in it they are baptized and married. Vestiges of a very old church, that of the Saviour in the Wood, contemporaneous with the foundation of Moscow, still exist in the yard of the palace. A stone church took the place of the old wooden structure in 1330, and was rebuilt in 1527. The Voznesensky convent, erected in 1389-1393, and restored in the end of the 19th century, is the burial-place of wives and sisters of the tsars. The Chudov monastery, erected in 1358-1365 and rebuilt in 1771, was the residence of the metropolitans of Moscow and a state prison. Close by, the great campanile of Ivan Veliky, erected in the Lombardo-Byzantine style by Boris Godunov, in 1600, rises to the height of 271 ft. (318 ft. including the cross), and contains many bells, one of which weighs 64½ tons. Close by is the well-known Tsar-Kokolok (king of the bells), 65 ft. in circumference round the rim, 10 ft. high, and weighing 198½ tons. It was cast in 1735, and broken during the fire of 1737 before being hung. The treasury of the patriarchs in the campanile of Ivan Veliky contains not only such articles of value as the *sakkos* (episcopal robes) of the metropolitans with 70,000 pearls, but also very remarkable monuments of Russian archaeology. The library has 500 Greek and 1000 very rare Russian MSS., including a Gospel of the 8th century.

The great palace of the tsars, erected in 1838-1840, is a fine building in white stone with a gilded cupola. It contains the *terems*, or rooms erected by Tsar Michael Feodorovich for the young princes his sons in 1636 (restored in 1836-1849, their former character being maintained), a remarkable memorial of the domestic life of the tsars in the 17th century. In the treasury of the tsars, in the Orujeynaya Palata, now public museums, the richest stores connected with old Russian archaeology are preserved—crowns, thrones, dresses, various articles of household furniture belonging to the tsars, Russian and Mongolian arms, carriages, &c. The Granovitaya Palata, another wing of the great palace, consists of a single-vaulted apartment built in 1473-1490, and is used as a state banqueting hall.

The four sides of the Senate Square are occupied by buildings

of various dates, from the 15th century onwards. Among them is the imposing senate, now the law courts, erected by Catherine II. (1771-1785). Facing it is the arsenal (1701-1736). The temple of the Saviour, begun in 1817 in commemoration of the events of the French campaign of 1812, was abandoned in 1827, and a new one was built during 1838-1883 on a hill on the bank of the Moskva, at a short distance from the Kremlin. Its style is Lombardo-Byzantine, with modifications suggested by the military taste of Nicholas I.

The Kitay-Gorod, which covers 121 acres, is the chief commercial quarter of Moscow. It contains the new bazaars, a triple block of buildings erected in 1888-1893 in sandstone, at a cost of over £1,630,800, and the Gostinyy Dvor, consisting of several stone buildings divided into 1200 shops. The Red Square, 900 yds. long, with a stone tribunal in the middle, which was formerly the forum, market cross and place of execution separates the bazaar from the Kremlin. At its lower end stands the fantastic Pokrovsky Cathedral (usually known as Vasilii Blazhennyi), one of the wonders of Moscow, on account of its towers, all differing from each other and representing, in their variety of colours, pine-apples, melons and the like. It was begun by Ivan the Terrible in 1554 to commemorate the conquest of Kazan, but not completed until 1679. It was plundered and desecrated by the French in 1812, but restored in 1830-1845. The exchange, built in 1838 and restored in 1873, is very lively, and its "exchange *ariels*" (associations of nearly 2000 brokers) are worthy of remark. Banks, houses of great commercial firms, streets full of old book-shops carrying on a very large trade, and finally the *Tolkuchy rynok*, the market of the poorest dealers in old clothes, occupy the Kitay-Gorod, side by side with restaurants of the highest class. In this quarter are also situated the house of the Romanovs, the reigning dynasty of Russia, rebuilt and refurbished in 1850 in exact conformity with its former shape; and the printing-office of the synod of the Orthodox Greek Church, founded in 1563 and containing about 600 MSS. and 10,000 very old printed books, together with a typographical museum. At the entrance to the Kitay-Gorod stands the chapel of the highly venerated Virgin of Iberia, a copy made in 1648, of a holy picture placed on the chief gate of the monastery of Mt Athos.

The northern parts of the Byelyi-Gorod are also the centre of a lively trade. Here are situated the Okhotnyi Ryad (poultry and game market) and the streets Tverskaya, Petrovka and Kuznetsky-Most the rendezvous of the world of fashion. Here also are the theatres, the industrial art museum, imperial bank (1894), and Rozhdestvensky convent (founded in 1386). In the south-west of the Byelyi-Gorod, opposite the Alexander Garden on the west side of the Kremlin, stand the university (see below), museum of domestic industries, Rumyantsev Museum and church of the Redeemer. This last, built in the form of a Greek cross in 1837-1883 at a cost of nearly £1,600,000, is dominated by five gilded domes and faced externally with marble. The interior is harmoniously decorated with gold and marble, and adorned with pictures by Verestchagin and other Russian artists. In the east of the city are three monasteries all dating from the 14th century.

The Zemlyanoy-Gorod, which has arisen from villages that surrounded Moscow, exhibits varied characteristics. In the neighbourhood of the railway stations it has busy centres of traffic; other parts are manufacturing quarters, whilst others—for instance, the small quiet streets on the west of the boulevard Prechistenka, called the old Konushennaya, with their wooden houses and spacious courtyards—are the true abodes of the families of the old, for the most part decayed, but still proud, nobility. The Zamoskvoryechnie, on the right bank of the Moskva, is the abode of the patriarchal merchant families.

The climate of Moscow is cold and continental, but healthy. The average annual temperature is 40° F. (Jan., 14°; July, 66°). The summer is warm (64°), and the winter cold and dry (15°-8°), great masses of snow lying in the streets. The spring, as is usually the case in cold continental climates, is beautiful. The prevailing winds are south-west and south.

The river Moskva is frozen, on the average, for 153 days (from Nov. 12 to April 13).

The Moskva is crossed by five bridges; a branch of it, or rather a channel, makes an elongated island in the middle of the city. Water of excellent quality, principally from the Mytishchi springs and ponds, 11 m. distant, has since 1893 been led to fountains in different parts of the city, whence it is distributed by watermen.

The population was estimated at only 150,000 in the middle of the 18th century, and at 250,000 in 1812. Since 1870 it has been growing at the rate of about $2\frac{1}{2}$ % per annum; (1872), 601,069; (1882), 753,469; (1902), 1,092,360, or including the suburbs 1,173,427; (est. 1907), 1,359,254. The housing problem is of great importance in Moscow, as it appears that over 10 % of the domiciles are underground. And while the average for the city is two occupants to each room, there are more than 10,000 domiciles which have more than four occupants to each room, representing one-fourth of the population. The average mortality is consequently high, namely 28 per 1000 (33 per 1000 if the children inmates of the Foundling House be included). Fires occur very frequently. The inhabitants are mostly Great-Russians. They belong chiefly to the Orthodox Greek Church, or are Nonconformists; the Lutherans number 2 % and the Roman Catholics 1 %.

Since the 14th century Moscow has been an important commercial city. About the end of the 15th century its princes transported to Moscow, Vladimir, and other Russian towns no fewer than 18,000 of the richest Novgorod merchant families, and took over the entire trade of that city, entering into direct relations with Narva and Livonia. The annexation of Kazan (1552) and the conquest of Siberia (1580-1600) gave a new importance to Moscow, bringing it into direct commercial relations with Khiva, Bokhara and China, and supplying it with Siberian furs. The fur-trade had a great fascination for all European merchants in the 16th century, and an English company, having received the monopoly of the Archangel trade, caused their merchandise to be sent by the White Sea instead of by the Baltic. Moscow thus became the centre for nearly the entire trade of Russia, and the tsar himself engaged in large commercial operations. Situated at the intersection of six important highways, Moscow was the storehouse and exchange-mart for the merchandise of Europe and Asia. The opening of the port at St Petersburg affected its commercial interest unfavourably at first; but the Asiatic trade and internal trade of Moscow have since then enormously increased. Here are concentrated the traffic in grain, in hemp and in oils sent to the Baltic ports; in tea, brought both by way of Siberia and of St Petersburg; in sugar, refined here in large quantities; in grocery wares for the supply of more than half Russia and all Siberia; in tallow, skins, wool, metals, timber, wooden wares, iron and steel goods, wine, drugs, raw cotton, silk and all other produce of the manufactures of middle Russia. As a railway centre the city plays so predominant a part that $\frac{1}{2}$ to $\frac{1}{3}$ of all the goods carried by the railways of European Russia are loaded or unloaded at Moscow. The banks, including the mortgage banks, are the most important in Russia.

From the 15th century onwards the villages around Moscow were renowned for the variety of small industries which they carried on; the first large manufactures in cottons, woollen fabrics, silk, china and glass in Great-Russia were established at Moscow in the 17th and 18th centuries. After 1850, in consequence of protection tariffs, the manufactures in the government of Moscow rapidly increased in number; but two-thirds of them are now concentrated in the capital. Moscow is in fact the principal manufacturing city in the empire, employing about 100,000 operatives in her mills and factories. Nearly one-half of them are engaged in the textile industries, especially calico-printing. Next in importance comes the preparation of food-stuffs, followed by the metal and metallurgical industries and the chemical works.

Moscow has many educational institutions and scientific societies. The university, founded in 1755, exercised a powerful

influence on the intellectual life of Russia during the years 1830-1848; and it still continues to be the most frequented Russian university. In 1904 it had over 5000 students, who are mostly poor. The library contains some 286,000 volumes, and has rich collections in mineralogy, geology and zoology. Among the museums the Rumyantsev, now connected with the so-called public museum, occupies the first rank. It contains a library of 700,000 volumes and 2300 MSS., remarkable collections of old pictures, sculptures and prints, as well as an extensive mineralogical collection, and an ethnographical collection representing very accurately the various races of Russia. The private museum of Prince Goltshui contains a good collection of paintings and MSS. The Shchukin Museum contains Russian antiquities, pictures and objects of industrial art. A number of excellent free libraries have been opened, two of them containing valuable collections of books and MSS. The remarkable Tretyakov gallery of pictures, chiefly of the Russian school, has been presented (1892) by its owner to the city. The philanthropic institutions include the vast foundling hospital (1764). The municipal relief of the poor was entirely reorganized in 1804, partly on the Elberfeld system and partly on quite new and original lines.

Moscow is surrounded by beautiful parks and picturesque suburbs. Of the former one of the most frequented is the Petrovsky Park, to the north-west, with a castle built in 1776, burnt by the French in 1812, but rebuilt in 1840. A little farther out is the Petrovskoye Kazumovskoye estate, with an agricultural academy (1865) and its dependencies (botanical garden, experimental farm, &c.). Another large park and wood surround an imperial palace (1796) in the village of Ostankino. The private estates of Kuzminski, Kuskovo and Kuntsevo are also surrounded by parks; the last has remains of a very old graveyard, supposed to belong to the pagan period. In the south-west, on the right bank of the Moskva, which here makes a great loop to the south, are the Vorobyevy hills, which are accessible by steamer from Moscow, and afford one of the best views of the capital. In the loop of the Moskva is situated the Novo-Dyevichy or Virgins' convent, erected in 1524 and connected with Sophia, sister of Peter the Great, and many events of Russian history. In the south, on the road to Serpukhov, is the village of Kolomenskoye, founded in 1237, a favourite residence of Ivan the Terrible and Peter the Great, with a church built in 1537, a striking monument of Russian architecture, restored in 1880. The monastery Nikolo-Ugryeshkiy, 12 m. from the city, between the Kursk and Ryazan railways, occupies a beautiful site and is much visited by Moscow merchants, to venerate a holy picture by which Dmitry Donskoi is said to have been blessed before going to fight (1380) the Mongols. In the north, the forest of Sokolniki, covering $4\frac{1}{2}$ sq. m., with its radial avenues and numerous summer residences, is the part of Moscow most frequented by the middle classes.

History.—The Russian annals first mention Moscow in 1147 as a place where Yuri Dolgoruki, prince of Suzdal, met Svyatoslav of Svyersk and his allies. The site was inhabited from a very remote antiquity by the Merya and Mordvinians, whose remains are numerous in the neighbourhood, and it was well peopled by Great-Russians in the 12th century. To the end of the 13th century Moscow remained a dependency of the princes of Vladimir, and suffered from the raids of the Mongols, who burned and plundered it in 1237 and 1293. Under Daniel, son of Alexander Nevsky (1261-1302), the prince of Moscow first acquired importance for the part he took in the wars against the Lithuanians. He annexed to his principality Kolomna, situated at the confluence of the Moskva with the Oka. His son in 1302 annexed Pereyaslavl Zalesky, and in the following year Mozhaisk (thus taking possession of the Moskva from its source to its mouth), and so inaugurated a policy which lasted for centuries, and consisted in the annexation by purchase and other means of the neighbouring towns and villages. In 1300 the Kremlin, or fort, was enclosed by a strong wall of earth and timber, offering a protection to numerous emigrants from the

Tver and Ryazan principalities. Under Ivan Kalita (1325-1341) the principality of Vladimir—where the princes of Kiev and the metropolitan of Russia had taken refuge after the wars that desolated south-western Russia—became united with Moscow; and in 1325 the metropolitan Peter established his seat at Moscow, thus giving new importance and powerful support to the young principality. In 1367 the Kremlin was enclosed within stone walls, which proved strong enough to resist the Lithuanians under Olgiard (1368 and 1371). Kalita's grandson, Dmitry Donskoi, annexed the dominions of Starodub and Rostov, and took part in the renowned battle of Kulikovo (1380), on the Don in the government of Tula, where the Russians ventured for the first time to oppose the Mongols in a great pitched battle. Two years after the battle of Kulikovo Moscow was taken and plundered (for the last time) by Toktamish, khan of the Golden Horde of the Mongols.

The increase of the principality continued during the first half of the 15th century, and at the death of Vasilii (or Basil) the Blind, in 1462, it included not only the whole of what is now the government of Moscow, but also large parts of the present governments of Kaluga, Tula, Vladimir, Nijniy-Novgorod, Kostroma, Vyatka, Vologda, Yaroslavl and Tver. It was not however until the reign (1462-1505) of Ivan III. that the prince of Moscow set up claims to other parts of Russia, and called himself "Ruler of all Russia." In 1520 Moscow was said to contain 45,000 houses and 100,000 inhabitants. Ivan IV. annexed Novgorod and Pskov to Moscow, and subdued Kazan and Astrakhan. But after his reign Moscow suffered from a long series of misfortunes. In 1547 two conflagrations destroyed nearly the whole of the city, and a few days later the Tatar khan of the Crimea advanced against it with 100,000 men. He was compelled to retire from the banks of the Oka, but in 1571, taking advantage of the state into which Russia was brought by the extravagances of Ivan, he took Moscow and burned all the city outside the Kremlin. The gates of the Kremlin having been shut, thousands of people perished in the flames, and the annual record that of the 200,000 who then formed the population of Moscow, only 30,000 remained. In 1591 the Tatars of the Crimea were again in Moscow and avenged their repulse from the Kremlin on the inhabitants of the unfortified town. Meanwhile the political influence of the boyars had gradually increased. The peasants, who settled on their lands, or on the estates which the prince bestowed upon his boyars, had become serfs; and the political tendency of the boyars, supported by the wealthier middle classes (which had also a rapid development in the same century), was to become rulers of Russia, like the noblesse of Poland. During the reign of Feodor or Theodore (1584-1598), Boris Godunov, the regent, ordered the murder of the heir to the throne, Demetrius, son of Ivan IV., and himself became tsar of Russia. Moscow suffered severely in the struggle which ensued, especially when the populace rose and exterminated the Polish garrison, on which occasion the whole of the city outside the Kremlin was again burned and plundered. But in compensation it acquired in the eyes of the nation a greatly increased importance, as a stronghold against foreign invasions. The Novo-dyevichy or Virgins' nunnery, which the Poles besieged (1610) without taking, was invested with a higher sanctity. The city also by-and-by recovered its commercial importance, and this the more as other commercial cities were ruined, or fell into the hands of foreigners; and thirty years later Moscow was again a wealthy city. Owing, however, to the ever-increasing concentration of power in the hands of the tsar, and the steady development of autocracy, it lost much of its political importance, and assumed more and more, especially under Alexis Mikhailovich (1645-1676), the character of a private estate of the tsar, its suburbs becoming mere dependencies of his vast household.

During the whole of the 17th century Moscow continued to be the scene of many troubles and internal struggles. The people several times revolted against the favourites of the tsar, and were subdued only by cruel executions, in which the *streltzy*—a class of citizens and merchants rendering hereditary military

service—supported the tsar. Afterwards appeared the *raskol* or nonconformist movement, and in 1648, when the news spread that Stenka Razin was advancing on Moscow "to settle his accounts with the boyars," the populace was kept from rising only by severe repressive measures and by the defeat of the invader. Later on, the *streltzy* themselves engaged in a series of rebellions, which led the youthful Peter the Great to suppress them (1698) amid streams of blood. The opposition encountered at Moscow to his plans of reforming Russia according to his ideal of military autocracy, the conspiracies of the boyars and merchants, the distrust of the mass of the people, all compelled him afterwards to leave (1703) the city, and to seek, as his ancestors had done, a new capital. This he founded at St Petersburg on the very confines of the military empire he was trying to establish.

In the course of the 18th century Moscow became the seat of a passive and discontented opposition to the St Petersburg government. Peter the Great, wishing to see Moscow like other capitals of western Europe, ordered that only stone houses should be built within the walls of the town, that the streets should be paved, and so on; but his orders were only partially executed. In 1722 the Kremlin was restored. In 1739 the city became once more the prey of a great conflagration; two others followed in 1748 and 1753, and gave an opportunity for enlarging some streets and squares. Catherine II. tried to conciliate the nobility, and applied herself to benefit the capital with new and useful buildings, such as the senate house, the foundlings' and several other hospitals, salt stores, &c.

The last public disaster was experienced by Moscow in 1812. On the 13th of September, six days after the battle of Borodino, the Russians troops evacuated Moscow, and the next day the French occupied the Kremlin. The same night, while Napoleon was waiting for a deputation of Moscow notables, and received only a deputation of the rich *raskolnik* merchants, the capital was set on fire through the carelessness of its own inhabitants (it was no heroic deed of Roztopchin's), the bazaar, with its stores of wine, spirits and chemical stuffs, becoming the prey of the flames. The inhabitants abandoned the city, and it was pillaged by the French troops, as well as by Russians themselves, and the burning of Moscow became the signal of a general rising of the peasants against the French. The want of supplies and the impossibility of wintering in a ruined city, continually attacked by cossacks and peasants, compelled Napoleon to leave Moscow on the 19th of October, after he had unsuccessfully attempted to blow up certain parts of the Kremlin.

(P. A. K.; J. T. Br.)

MOSEL (Fr. *Moselle*), a river of France and Germany, a left-bank tributary of the Rhine. It rises at an altitude of 2411 ft. on the west flank of the Vosges, close to the Franco-German frontier, and a little N. of the Ballon d'Alsace. It flows first N.W. through the French department of Vosges, bends towards N. through that of Meurthe-et-Moselle, forms the Franco-German frontier for a short distance below Pagny, and enters Lorraine. From Sierck to Wasserbillig it forms the frontier between the Rhine Province and Luxemburg, then, turning N.E., it follows a sinuous course and reaches the Rhine at Coblenz. The principal towns on the banks of the Mosel are, in France: Remiremont, Épinal, Toul and Pont-à-Mousson; in Germany: Metz, Diedenhofen, Trier (Trèves) and Coblenz. The Mosel receives the waters of the Moselotte, Meurthe, Seille and Saar (its principal tributary) on the right, and the Madon, Orne and Sauer on the left. Navigation for small vessels extends downwards from Fronard, a little below Nancy, the Mosel canal affording communication from a point above Metz to the frontier. In the lower part of the valley are the vineyards from which the well-known Mosel wines are produced. The valley of the Mosel, especially the part between Trier and Kochem, is noted both for picturesque scenery and for many sites of antiquarian interest. The length of the river is 314 m.

MOSELLE-LINE, the designation of a line of French barrier forts (*forts d'arrêt*) on the upper Moselle between the fortresses

of Épinal and Belfort (see these articles, also *MUSEE LINE* and articles referred to therein). The purpose of this line, the separate forts of which command the relatively few lines of advance from upper Alsace through the Vosges, is to deflect a possible German invasion from Alsace either towards Belfort or towards the open gap between Épinal and Toul called the *Trouée d'Épinal*.

MOSEN, JULIUS (1803-1867), German poet and author, was born at Marieney in the Saxon Vogtland on the 8th of July, 1803. He studied law at Jena, and, after two years in Italy, at Leipzig. In 1834 he settled in Dresden as an advocate. He had meanwhile shown great literary promise by his *Lied vom Ritter Wahl* (1831). This was followed by the more philosophical *Ahasver* (1838), and by a volume of poems, *Gedichte* (1836, 2nd ed., 1843), among which *Andreas Hofer* and *Die letzten Zehn vom vierten Regiment* have become popular. He wrote the historical plays *Heinrich der Finkler* (Leipzig, 1836), *Cola Rienzi*, *Die Braute von Florenz*, *Wendin und Helene* and *Kaiser Otto III.* (the four last being published in his *Theater* 1842), and a politico-historical novel, *Der Kongress von Verona* (1842), which was followed by a charming collection of short stories (*Bilder im Moose*, 1846). In 1844 Mosen accepted the appointment of dramaturge at the Court Theatre in Oldenburg, but he was soon afterwards stricken with paralysis, and after remaining an invalid for many years, died at Oldenburg on the 10th of October 1867. Of his later works may be mentioned *Die Dresdner Gemäldegalerie* (1844), and the tragedies *Herzog Bernhard* (1855) and *Der Sohn des Fürsten* (1858).

A collection of his works, *Sämtliche Werke*, appeared in 8 vols. (1863; new ed., by his son, with a biography; 6 vols., 1880).

MOSEER, JOHANN JAKOB (1701-1785), German jurist, was born at Stuttgart on the 18th of January 1701. He studied at the university of Tübingen, where, at the early age of nineteen, he was appointed extraordinary professor of law. In 1720 he became ordinary professor, and in 1736 he accepted a chair and directorship in the university of Frankfurt-on-the-Oder. On account, however, of differences with King Frederick William I. of Prussia, he resigned these offices in 1739 and retired to Ebersdorf, a village in the principality of Reuss, where for several years he devoted himself wholly to study, and especially to the production of his *Deutsches Staatsrecht*. In 1751 he was recalled to Württemberg as district councillor, and in 1759 was imprisoned at Hohentwiel on account of the steps he had taken in connexion with this office against certain tyrannical proceedings of the duke. In 1764 he received his liberty and was restored to office. He died on the 30th of September 1785. Moser was the first to discuss in an adequate form the subject of European international law. He wrote more than 500 volumes, his principal works being *Deutsches Staatsrecht* (1737-1754), *Neues deutsches Staatsrecht* (1766-1775), *Deutsches Staatsarchiv* (1751-1757), *Grundriss der heutigen Staatsverfassung von Deutschland* (1754).

See Schmid, *Das Leben J. J. Mosers* (1868); Schulze, *J. J. Moser, der Vater des deutschen Staatsrechts* (1869).

MÖSER, JUSTUS (1720-1794), German publicist and statesman, was born at Osnabrück on the 14th of December, 1720. Having studied jurisprudence at the universities of Jena and Göttingen, he settled in his native town as a lawyer. The confidence he inspired among his fellow citizens soon led to his being appointed *advocatus patriæ* (state attorney). On the appointment of the duke of York (son of George III. of England) to the lay Protestant bishopric of Osnabrück, he was attached to the person of the new ruler as legal adviser, and continued in this office for twenty years. From 1762 to 1768 he was *justiciarius* (chief justice) of the criminal court in Osnabrück; and in 1768 was made *Geheimer Referendar* (privy councillor of justice). He died at Osnabrück on the 8th of January 1794. Not only as a statesman and administrator, but also as a publicist, Möser occupied a leading position among the men of his time. His history of Osnabrück (1768; 2nd ed. 1780; 3rd ed. 1810) is a masterly work. In his *Patriotische Phantasien* (1775-1786; 2nd ed. by his daughter, I. W. J. von Voigts, 1804;

new ed. by R. Zöllner, 1871) he shows himself in advance of his times, pleading as he does for a national organic development of a state in the place of arbitrary laws imposed by the sovereign. His *Vermischte Schriften* (published by F. Nicolai with a biography, 1797-1798) also display a deep insight into human nature and sparkle with humour and witty sallies. Möser was also a poet of some repute and wrote a tragedy, *Arminius* (1749). A statue of him by Drake was unveiled in Osnabrück in 1836.

His collected works, *Sämtliche Werke*, were published by B. R. Abeken (10 vols., 1842-1844). See J. Kreyssig, *Justus Moser* (1857); L. Rupprecht, *Justus Möser's soziale und volkswirtschaftliche Anschauungen* (1892); K. Mollenhauer, *Mösers Anteil an der Wiederbelebung des deutschen Geistes* (1896).

MOSES (Gr. *Μωσῆς*, *Maōsēs*), the great Jewish lawgiver, prophet and mediator, and leader of the Israelites from Egypt to the eastern borders of the promised land. The records of his life and work are noticed in the articles *EXODUS*, *NUMBERS*, *DEUTERONOMY*, where the several sources of the narratives are described. He appears in Midian at the "Mount of God" (Horeb) dwelling with his priest Jethro (*g.u.*), one of whose seven daughters he married, thus becoming the father of Gershom and Eliezer. Of his earlier life it was said that he was born in Egypt of Levite parents, and when the Pharaoh commanded that every new-born male child of the Hebrews should be killed, he was put into a chest and cast upon the Nile. He was found by Pharaoh's daughter, and his (step-)sister Miriam contrived that he should be nursed by his mother; on growing up he killed an Egyptian who was oppressing an Israelite, and this becoming known, he sought refuge in flight.

The story of the youth of Moses is, as is commonly the case with great heroes, of secondary origin; moreover, the circumstances of his birth as related in Exod. ii. find numerous parallels in legend elsewhere, e.g. in the story of the historical Sargon (L. W. King, *Early Bab. Kings*, ii. 87 sqq.), in the myths of Osiris and many others (see, at length, A. Jeremias, *Das Alte Test. im Lichte des alten Orients*, 1006, pp. 408 sqq.; *Bab. im N. Test.* p. 30 seq.). The story of the adoption of Moses by the Egyptian princess appealed to later imagination (Josephus, *Ant.* ii. 9, 10; Acts vii. 20-22), and many fanciful fables grew up about it and the other biblical statements. The name *Mōsheh*, explained by the fact that the princess "drew him" (*māshāk*) out of the waters, means properly "one who draws"; a derivation from Eg. *mes(u)*, "child," finds more favour, but is not certain.

At the holy mount, Moses received the divine revelation and was commissioned to bring the people a three-days' journey out of Egypt to sacrifice at this spot (Exod. iiii. 12, 18; v. 3; viii. 27). The deity revealed himself in a new name, *Yahweh*, and with signs and wonders fortified Moses for his task. On his return he experienced a remarkable incident which is obscurely associated with the rite of circumcision.¹ The plagues with which the reluctant Pharaoh was coerced culminated in the destruction of all the first-born, and Israel escaped to the Red Sea. The pursuing Egyptians were drowned, and the miraculous preservation of the chosen people at the critical moment marks the first stage in the national history.² (See *EXODUS*, *THEE*.)

The other events need not be detailed. *Kadesh* (holy) was¹ Exod. iv. 24-26; it possibly explains the transference of the rite from the bridegroom to the new-born son. For a recent discussion, see H. P. Smith, *Journ. Bib. Lit.* (1906), pp. 14-24; and the article *CIRCUMCISION* (with J. G. Frazer's essay in the *Independent Review* 1904, pp. 204-218).

² The plagues appear to have been amplified. In Exod. iv. three signs are given: the hand of Moses is stricken with leprosy and restored (the sign for Moses); his rod becomes a serpent (cf. vii. 8-13, the sign for Pharaoh); and the water is turned into blood (cf. vii. 17 sqq.). If Pharaoh still remains obdurate his first-born is threatened (iv. 21 sqq.). As regards the crossing of the Red Sea, a perfectly rational explanation can be found: with a strong east wind its waters could temporarily recede and permit a passage (see *Journ. Nat. Inst.* xvi. 28; xviii. 268, 277). To the Israelites, however, it was a miracle, an unexpected intervention on the part of *Yahweh*, and the first of many marvels which he performed on behalf of the people of his choice. To rationalize this or any of the series misses the whole point of the religious history.

the chief centre. This was the scene of the "strife" at Meribah (striving) where Yahweh "shewed himself holy" (Num. xx. 1-13); a parallel account joins the name with Massah (trial, proof) where Yahweh "proved" the people (Exod. xvii. 1-7). These two names (Deut. ix. 22, xxxii. 51) with their significant meanings recur with varying nuances (Ps. lxxxi. 7, xcv. 8 sq.). Here also in the wilderness of Shur, and possibly at En-mishpat (well of judgment, i.e. Kadesh, Gen. xiv. 7), Yahweh made for Israel "statute and judgment" and "proved them." This is apparently viewed as the goal of the three-days' journey (Exod. xv. 22-25). In this district the defeat of the Amalekites is more naturally located (Exod. xvii; cf. 1 Sam. xxvii. 8) and here, finally, for some cause, now obscured, Moses and his brother Aaron (g.v.) incurred Yahweh's displeasure (Num. xx. 12, xxvii. 14; Deut. xxxii. 51; Ps. cvi. 3). Pisgah or Mt Nebo (the name suggests a foreign god), to the north-east of the Dead Sea became the scene of the death of Moses; his burial-place was never known (Deut. xxxiv.).

In estimating the work of one who stands at the head of the religious and legal institutions of Israel, it is necessary to refrain from interpreting the traditions from a modern legal standpoint or in the light of subsequent ideas and beliefs for which the sources themselves give no authority. Much confusion has been caused by attributing to Moses more than the Pentateuch itself claims, and by misunderstanding the meaning of later references (Mat. xix. 8; Mark vii. 10, x. 5; xii. 26; Luke xx. 37; John vii. 22). Moreover, it is necessary to allow that the traditions relating to both Moses and Aaron underwent change. The priesthoods of Shiloh and Dan could boast of an illustrious origin (1 Sam. ii. 27 sq.; Judges xviii. 30), but the religious practices associated with the former especially were not those of the purest type. When Aaron himself is connected with the worship of the golden calf, and when to Moses is attributed a brazen serpent which the reforming king Hezekiah was the first to destroy, it is evident that religious conceptions developed in the course of ages. Although Moses was venerated as a prophet (Hos. xii. 13), a mediator (Jer. xv. 1) and a leader (Mic. vi. 4; Isa. lxiii. 11), much of the legal procedure ascribed to him came into internal grounds (religious, ethical and sociological evidence) to a post-Mosaic age. Many of the Mosaic laws find parallels and analogies in all ages outside the sphere of Israelite influence, notably in the laws codified several centuries previously by the Babylonian king Khammurabi (see BABYLONIAN LAW). The practice of finding in ancient authority a precedent for institutions new and old (cf. the law of booty, 1 Sam. xxx. 25, with that ascribed to Moses in Num. xxxi. 25 sqq.) is quite in accordance with Oriental custom and explains the growth of the present extremely complex sources. But this very development of Mosaism implies the existence of an original nucleus or substratum, although the recovery of its precise extent is very difficult. The legislation on Mt Sinai (Horeb) which apparently occupies a very important place in tradition (Exod. xx. sqq.) is really secondary (cf. W. R. Smith, *Prophets of Israel*, p. 111); more prominence is evidently to be ascribed to the influence of the half-Arabian Jethro or Hobab, and this must be taken into consideration with what is known of Kenite and kindred clans (Exod. xviii.; Num. x. 29-33; see JETHRO; KENITES).¹ Yahweh appears to have been known to them before he revealed himself to Moses, and the ancestors of the Israelites are recognized as worshippers of Yahweh, but are on another level (Exod. vi. 3). The traditions would seem to point to the institution of new principles in the religion of Yahweh, and would associate with it not merely Moses but those foreign elements which are subsequently found in Israel and Judah. See JEWS, §§ 5, 14, 20.

BIBLIOGRAPHY.—See further articles, AARON; DECALOGUE; HEBREW RELIGION; LEVITES. For the introductory questions, W. Robertson Smith's *Old Test. in Jewish Church and Prophets of Israel* are most helpful; see also J.-M. Lagrange, *Hist. Crit. and the Old Testament* (Eng., E. Myers, 1905), pp. 148-179; Wellhausen's

¹ See K. Budde, *Religion of Israel to the Exile*, ch. i. According to Gen. v. 30, so far from the name Yahweh having been made known to Israel by Moses (Exod. iii. 13 sqq., vi. 2 sqq.), the worship goes back to the earliest ages.

Prolegomena is a conclusive elaboration of the initial stages of criticism. All subsequent studies vary according to the writer's standpoint; W. R. Harper, *Amos and Hosea* (*Internat. Critical Commentary*), pp. 84 sqq., gives a convenient summary. Among particular discussions may be named Cheyne, *Ency. Bib. s.v.*, E. Meyer, *Israeliten*, pp. 1-103; and the mythological treatment by H. Winckler, *Gesch. Isr.*, ii. 86-95; A. Jeremias, *Alle Test. loc. cit.*; and Ed. Staeken, *Aströmischen d. Hebräer*, &c., pp. 431 sqq.; For Jewish and other legends (to which Judeo-alludes, see Boer, *Leben Moses* (1863), M. Grünbaum, *Neue Beiträge z. sem. Sagenkunde* (1893), pp. 152 sqq.; the *Assumption of Moses*, ed. R. H. Charles (1897); W. Tisdall, *Sources of the Qur'an* (1905); and *Ency. Bib. col. 3218, § 21* (with references). For the stories of Manetho, &c., Ewald, *Hist. Isr.*, ii. 76 sqq.; Kittel, *Hist. i.* 26 sqq., may be supplemented by Willrich, *Juden u. Griechen vor d. makkab. Erhebung* (1895), pp. 53 sqq.; G. Maspero, *Rec. de travaux* (1905), xviii. 13 sqq., 22 sqq. (S. A. C.)

MOSES, ASSUMPTION OF, an extra-canonical apocryphical work of the Old Testament. The *Assumption or Ascension of Moses* (Ἀνάληψις Μωϋσέως) is a prophecy of the future relating to Israel, put into the mouth of Moses, and addressed to Joshua just before the great lawgiver died. Founded upon the book of Deuteronomy, it is brief and unpoetical. But it seems to have been large at first, for according to Nicephorus it consisted of 1400 stichs. It contains a brief history of Israel from Moses to the Messianic age. The most striking feature in this work is the writer's scathing condemnation of the priesthood before, during, and after the Maccabean period, and an unsparring depreciation of the Temple services.

This book was lost for many centuries till a large fragment of it was discovered and published by Ceriani in 1861 (*Monumenta sacra* I. i. 55-64) from a palimpsest of the 6th century. Very little was known about the contents of this book prior to this discovery. One passage found in this fragment is quoted in the *Acta synodi Nicaenae*, ii. 18. Most of the other references relate to the strife of Michael and Satan about the body of Moses, and ascribe it to the Ascensio Mosis, i.e. Ἀνάληψις Μωϋσέως.

Various other works have been attributed to Moses, such as the *Petrarch Moshe*, the *βιβλος λόγων ηρωτικῶν Μωϋσέως*, the *Exodus of Moses* (in Slavonic), &c. See Charles, *Assumption of Moses*, pp. xiv-xvii.; Schröter, *Gesch. des jüd. Volkes*, iii. 220-221.

Date.—The book has been assigned to most dates between the death of Herod the Great and that of Bar-Cochba. But this text precludes any date after A.D. 70. The true date appears to lie between 4 B.C. and A.D. 30. Herod is already dead (vi. 6), hence it is after 4 B.C.; and Herod's sons are to rule for shorter periods than their father, hence it must have been composed before these princes had reigned thirty-four years—i.e. before A.D. 30. But there are grounds for assuming that A.D. 7 is probably the earlier limit (see Charles, *op. cit.* lv-ii.).

Author.—The author was not an Essene, for he recognizes animal sacrifices and cherishes the Messianic hope. He was not a Sadducee, for he looks forward to the establishment of the Messianic Kingdom (x.). Nor yet was he a Zealot, for the quietistic ideal is upheld (ix.), and the kingdom is established by God Himself (x.). He was clearly a Pharisaic Quietist, a Pharisee of a fast disappearing type, recalling in all respects the Chasid of the early Maccabean times, and upholding the old traditions of quietude and resignation. His object is to protest against the growing secularization of the Pharisaic party through its adoption of popular Messianic beliefs and political ideals. But his appeal was in vain, and so the secularization of the Pharisaic movement culminated in due course in the fall of Jerusalem.

The Latin Version a Translation from the Greek.—That our Latin text is derived from the Greek there can be no question. Thus Greek words are transliterated, as "chedrio" from *καθάρω*, "heremus" from *ἄρημος*; Greek idioms are reproduced, as "usque nos ducti captivi," = *εως του ἡμᾶς αἰχμαλωτισθῆναι*, and retranslation into Greek is frequently necessary in order to correct the misrenderings of the translator or the corruptions already inherent in the Greek. Finally, fragments of the Greek version are still preserved.

The Greek a Translation from the Hebrew.—That the Greek was in turn derived from a Semitic original was denied by Hilgenfeld, Volkmar and others. But Ewald, Schmidt-Mercz, Colani, Carrière, Hausrath, Dalman, Rosenthal and Burkitt decide in favour of a Semitic, R. H. Charles (*op. cit.* xxxviii.-xlv.) is of opinion that it is possible to prove that the Greek goes back not to an Aramaic but to a Hebrew original, on the following grounds: (1) Hebrew

idiomatic phrases survive in the text. Thus *circumibo* (ii. 7) = "I will protect," i. e., אֲבָרֵךְ (cf. Deut. xxxiii, 10), and in *sacerdotes vocabuntur* = *dis tepes* ἀρχιερεῖς, אֲרִיִּים מִקִּיִּים (cf. I Chron. xxiii, 14, and Isa. xlviii, 2) = "they will call themselves priests." (2) Frequently it is only through retranslation that we can understand the source of corruptions in the text. (3) In some cases we must translate not the Latin but the Hebrew presupposed by it. Thus in i. 7, *successor* = *ἀδελφός* = אָדָם, must be rendered "minister."

The Book may be the last Testament of Moses.—The present book is possibly the long lost *Διαθήκη Μωϋσῆως* mentioned in some of the ancient lists, for it never speaks of the assumption of Moses, but always of his natural death (i. 15, 13, x. 14). About a half of the original Testament is preserved in the Latin Version. The latter half probably dealt with questions about the Creation (see Fabric. *Cod. pseud. V. T.* ii. 844; *Acta synodi Nicaenae*, ii. 20). With this "Testament" of the "Assumption," which almost all the patristic references and that of Jude are made, was subsequently edited.

Some views of Author.—Our author's views on Moses are remarkable. He writes that Moses was prepared from before the foundation of the world to be the mediator of God's covenant with his people (i. 14, iii. 12). During his life he was Israel's intercessor with God (xi. 17, 17). Praying on their behalf as a "great angel" (xi. 17), "a sacred spirit who was worthy of the Lord manifold and incomprehensible" (xi. 16). Apparently his relation to Israel did not cease with death, as he was to be their intercessor in the spiritual world (xii. 6). His death was an ordinary one (i. 15, iii. 13, x. 12, 14), but no single place was worthy to mark the place of his burial, for his sepulchre was from the rising to the setting sun, and from the south to the confines of the north—*yea*, the whole world was his sepulchre (xi. 8). On the doctrine of good works our author's views are allied to Old Testament conceptions rather than to the rabbinic doctrine of man's righteousness, which bulks so largely in Jewish literature from A. D. 50 onwards. So far from representing man's righteousness as involving merit over against God, our author represents the greatest hero of Israel as declaring "Not for any virtue or strength of mine, but in His compassion and long-suffering was He pleased to call me" (xii. 7.)

LITERATURE.—Editions of the Latin text: Ceriani *Monumenta sacra et profana*, l. i. 55-64 (1861); Hilgenfeld, *Nov. test. extra canonem receptum*, 107-135 (1876); Volkmar, *Mose Propheten und Himmelfahrt* (1867); Schmidt and Merx, *Die Assumptio Moysis* (Merx, *Archiv. f. wissenschaft. Erf. des A. Ts.* i. ii. 111-152; 1868); Charles, *The Assumption of Moses* (translation, with notes and introduction, 1897); Cllemen, in *Katzenel's Apocr. and Pseph.* (i. 317-33). *Critical inquiries*.—For a full account of these see Schlierer iii. 222; Charles *op. cit.* xxi-xxxviii. (R. H. C.)

MOSES OF CHORENE, Armenian historian, was a native of Khor'ni in Tarōn, a district of the Armenian province of Turuberan. According to the *History of Armenia* which bears his name he was a pupil of the two fathers of Armenian literature, the patriarch or catholicos Sahak the Great and the vartabed Mesrōb. Shortly after 431 he was sent by these men to Alexandria to study the Greek language and literature, and thus prepare himself for the task of translating Greek writings into Armenian. Moses took his journey by Edessa and the sacred places of Palestine. After finishing his studies in the Egyptian capital he set sail for Greece; but the ship was driven by contrary winds to Italy, and he seized the opportunity of paying a flying visit to Rome. He then visited Athens, and towards the end of winter (440) arrived in Constantinople, whence he set out on his homeward journey. On his arrival in Armenia he found that his patrons were both dead. The *History of Armenia* speaks of its author as an old, infirm man, constantly engaged in the work of translating. In the later Armenian tradition we find other notices of this celebrated man¹—such as, that he was the nephew of Mesrōb, that he was publicly complimented by the emperor Marcian, that he had been ordained bishop of Bagrewand by the patriarch Giut, and that he was buried in the church of the Apostolic Cloister at Mush in the district of Tarōn; but these accounts must be received with great caution. This remark applies especially to the statement of Thomas Ardsruni² that Moses, like his Hebrew prototype, lived to the age of 120 years, and recorded his own death in a fourth book of his great work. The same caution must be extended to another tradition, based on an arbitrary construction of a passage in Samuel of Ani, which places his death in the year 480.

The *History of Armenia*,³ or, as the more exact title runs, the

Genealogical Account of Great Armenia, consists of three books, and reaches down to the death of Saint Mesrōb, in the second year of Yazdegerd II. (Feb. 17, 440).⁴ It is dedicated to Sahak Bagratuni (who was afterwards chosen to lead the revolted Armenians in the year 481), as the man under whose auspices the work had been undertaken. This work, which in course of time acquired canonical authority among the Armenians, is partly compiled from sources which we yet possess, viz. the *Life of Saint Gregory* by Agathangelos, the Armenian translation of the Syriac *Doctrine of the Apostle Addai*, the *Antiquities and the Jewish War* of Josephus, and above all the *History of Mar Abas Kaina* (still preserved in the extract from the book of Sebeos),⁵ who, however, did not write, as Moses alleges, in Syriac and Greek, at Nisibis, about 131 B.C., but was a native of Medsurch, and wrote in Syriac alone about A.D. 383, or shortly thereafter. Besides these, Moses refers to a whole array of Greek authorities, which were known to him from his constant use of Eusebius, but which cannot possibly have related all that he makes them relate.⁶ Although Moses assures us that he is going to rely entirely upon Greek authors, the contents of his work show that it is mainly drawn from native sources. He is chiefly indebted to the popular ballads and legends of Armenia, and it is to the use of such materials that the work owes its permanent value. Its importance for the history of religion and mythology is, in truth, very considerable, a fact which it is the great merit of Emin⁷ and Dulaurier⁸ to have first pointed out. For political history, on the other hand, it is of much less value than was formerly assumed. In particular, it is not a history of the people or of the country, but a history of the Armenian aristocracy, and, in opposition to the Mamikonian tendency which pervades the rest of the older Armenian historical literature, it is written in the interest of the rival Bagratunians. Down to the 3rd century it is proved by the contemporary Graeco-Roman annals to be utterly untrustworthy—but even for the times of Armenian Christianity it must be used far more cautiously than has been done, for example, by Gibbon. The worst feature is the confusion in the chronology, which, strange to say, is most hopeless in treating of the contemporaries of Moses himself. What can be thought of a writer who assigns to Yazdegerd I. (309-420) the eleven years of his predecessor Bahrām IV., and the twenty-one years of Yazdegerd I. to his successor Bahrām V. (420-430)? A. von Gutschmid⁹ at one time attempted to explain this unhistorical character of the narrative from a tendency arising out of the peculiar ecclesiastical and political circumstances of Armenia, situated as it was between the eastern Roman and the Persian empires, circumstances which were substantially the same in the 5th as they were in the two following centuries. In the course of further investigations, however, he came to the conclusion that, besides the many false statements which Moses of Khor'ni makes about his authorities, he gives a false account of himself. That is to say, the author of the *History of Armenia* is not the venerable translator of the 5th century, but some Armenian writing under his name during the years between 634 and 642. The proof is furnished on the one hand by the geographical and ethnographical nomenclature of a later period of MSS. of Etchmiadzin and Jerusalem are given by Agop Garinian, Tiflis (1858), 4to. The book has been edited and translated by Whiston (London, 1736, 4 vols.; and by Le Valliant de Florival (Venice and Paris, s.a., 1841), 2 vols. 8vo.

¹ The commencement of this king's reign has been fixed by Noldeke (*Geschichte der Sassaniden aus Tabari*, p. 423) as 4th August 438; and this date has subsequently been established by documentary evidence from the fact of the martyrdom of Pethion (see Hoffmann, *Auszüge aus syrischen Akten persischer Märtyrer*, p. 67).

² Translated in Langlois, i. 195 seq.

³ For the following statements, the evidence may be found in the article "Ueber die Glaubwürdigkeit der Armenischen Geschichte des Moses von Khoren," by Alfred von Gutschmid, in the *Berichte der phil. histor. Classe der königl. sächs. Gesellschaft der Wissenschaften* (1876), p. 1 seq.

⁴ *The Epic Songs of Ancient Armenia* (Arm.) (Moscow, 1850).

⁵ Études sur les chants historiques et les traditions populaires de l'ancienne Arménie," in the *Journ. asiat.*, iv, sér. 19 (1852), p. 5, seq.

⁶ Ueber die Glaubwürdigkeit," &c., p. 8 seq.

¹ Collected by Langlois, *Collection des historiens de l'Arménie*, ii. 47, seq.

² In Brosset, *Collection d'historiens arméniens*, i. 68.

³ The oldest MS. is that of S. Lazaro of the 12th century. Colla-

and similar anachronisms,¹ which run through the whole book and are often closely incorporated with the narrative itself, and on the other hand by the identity of the author of the *History* with that of *Geography*, a point on which all doubt is excluded by a number of individual affinities; not to speak of the similarity in geographical terminology. The critical decision as to the authorship of the *Geography* must settle the question for the *History* also.

The *Geography* is a meagre sketch, based mainly on the *Chorography* of Pappus of Alexandria (in the end of the 4th century), and indirectly on the work of Ptolemy. Only Armenia, the Persian Empire, and the neighbouring regions of the East are independently described from local information, and on these sections the value of the little work depends. Since the first published text² contains names like "Russians" and "Crimea," Saint Martin in his edition³ denied that it was written by Moses, and assigned its origin to the 10th century. It was shown, however, by L. Indjjean⁴ that these are interpolations, which are not found in better manuscripts. And in fact it is quite evident that a book which gives the division of the Sassanid Empire into four sabbeshships in pure old Persian names cannot possibly have been composed at a long interval after the time of the Sassanidae. But of course it is equally clear that such a book cannot be a genuine work of Moses of Khor'ni; for that division of the empire dates from the early part of the reign of King Chosroes I. (531-579).⁵ Accordingly K. P. Patkanov,⁶ to whom we are indebted for the best text of the *Geography*, is of opinion that we have in it a writing of the 7th century. If the limits within which the *Geography* was composed are to be more nearly defined, we may say that, from isolated traces of Arab rule⁷ (which in Armenia dates from 651), it must have been written certainly after that year, and perhaps about the year 657.⁸

Another extant work of Moses is a *Manual of Rhetoric*, in ten books, dedicated to his pupil Theodoros. It is drawn up after Greek models, in the taste of the rhetoric and sophistry of the later imperial period. The examples are taken from Hermogenes, Theon, Aphthonius, and Libanius; although the author is also acquainted with lost writings—e.g. the *Pelides* of Euripides. On account of the divergence of its style from that of the *History of Armenia*, Armenian scholars have hesitated to ascribe the *Rhetoric* to Moses of Khor'ni; but, from what has been said above, this is rather to be regarded as a proof of its authenticity.

Smaller works bearing the same honoured name are—the *Letter to Sahak Arderuni*; the *History of the Holy Mother of God*

¹ Instances of these may be found in I. 14, where the arrangement of Armenian provinces, I. 11, III. IV. introduced in the year 536, is carried back to Aram, an older contemporary of Ninus; and in the passage iii. 18, according to which Šapūr II. penetrated to Bithynia, although the Persians did not reach that till 608.

² See the confusion, common to both books, between Cappadocia I. and Armenia I, in consequence of which Mazaca and Mt Argæus are transferred to the latter locality (*Hist.* I. 14; *Geogr.* Saint Martin's ed. ii. 354); also the passages which treat of China and Deheubarok (*Hist.* II. 81; *Geogr.* II. 376). See also note 1.

³ Edition with translation by Whiston (*London*, 1736, 4to).

⁴ In the *Mémoires historiques et géographiques sur l'Arménie* (Paris, 1819, 8vo), ii. 310 seq.

⁵ *Antiquités of Armenia* (Arm.), iii. 303 seq.

⁶ See Nöldeke's *Tabari*, p. 155, seq.

⁷ *Armjanskaja geographija vst. vaka por. Ch.* (pripisivi avschazjasja Moiseju Chorenokomu) (St Petersburg, 1877, 8vo). Before him Kiepert (in the *Monatsb. d. Berliner Akad.* 1873, p. 599 seq.) had substantially arrived at the right conclusion when he assigned the portions of the *Geography* referring to Armenia to the time between Justinian and Maurice. (See also *Abhandlungen der königlichen Gesellschaft der Wissenschaften zu Göttingen*, philol. hist. Klasse, Neue Folge, Band iii. No. 2, 1901) (in which Dr J. Marquart edits with commentary under the title *Brännsähr* the sections of the *geography* relating to Persia).

⁸ The passage about the trade of Basra, which was founded in 635, is decisive on this point (Saint Martin's edition, ii. 368).

⁹ The peculiar interest which the author (Saint Martin, ii. 340) takes in the origin of the Slavs in Thrace is best explained by the war against them which called the emperor Constans II. away from the East in the year 657. In other respects the writer displays the most complete indifference, and even ignorance, with regard to the state of affairs in the West.

and her *Image* (in the cloister of Hogotsvanch in the district Andzevatsi of the province of Vaspurakan), which is also addressed to Sahak; and the *Panegyric on Saint Rhipsime*. Of the sacred poems attributed to him, there is only one short prayer, contained in the hymnal of Sharakan, which can really claim him as its author.

Of works passing under the name of Moses of Khor'ni, the following are regarded by the historians of Armenian literature as spurious: a *History* (distinct from the *Panegyric*) of the wanderings of Saint Rhipsime and her Companions; a *Homily on the Transfiguration of Christ*; a *Discourse on Wisdom* (i.e., the science of grammar); the *Commentaries on grammar* (an exposition of Dionysius Thrax). In the case of the grammatical writings, it has been suggested that there may have been some confusion between Moses of Khor'ni and a Moses of Siunich, who lived in the 7th century.

Literature.—The date of the *History* of Moses has been discussed in many monographs. See especially the brochure of A. Carrière, *Nouvelles sources de Moïse de Khoren* (Vienna, 1893), who sets it in the 8th century. A Russian critic, J. Khalateants, arrives at a similar conclusion in his *Armenianskije Epos* (Moscow, 1896). F. C. Conybeare, in an article on "The date of Moses of Khoren," in the *Byzantinische Zeitschrift*, vol. x., and in a second in vol. ii. entitled "The Relation of the Paschal Chronicle to Malalas," challenges Professor Carrière's arguments, and contends that the *History* of Moses is a late 5th-century work, much interpolated in the immediately succeeding centuries. (A. v. G.; F. C.)

MOSHEIM, JOHANN LORENZ VON (c. 1694-1755). German Lutheran divine and Church historian, was born at Lübeck on the 9th of October, 1694 or 1695. After studying at the gymnasium of his native place, he entered the university of Kiel (1716), where he took his master's degree in 1718. In 1719 he became *assessor* in the philosophical faculty at Kiel. His first appearance in the field of literature was in a polemical tract against John Toland, *Vindiciae antiquae christianorum disciplinae* (1720), which was soon followed by a volume of *Observationes sacrae* (1721). These works, along with the reputation he had acquired as a lecturer and preacher, secured for him a call to Helmstädt as professor ordinarius in 1723. The *Institutionum historiae ecclesiasticae libri IV.* appeared in 1726, and in the same year he was appointed by the duke of Brunswick abbot of Marienthal, to which dignity and emolument the abbacy of Michaelstein was added in the following year. Mosheim was much consulted by the authorities when the new university of Göttingen was being formed; especially in the framing of the statutes of the theological faculty, and the provisions for making the theologians independent of the ecclesiastical courts. In 1747 he was made chancellor of the university. He died at Göttingen on the 9th of September. Among his other works were *De rebus christianorum ante Constantinum commentarii* (1753), *Ketzer-Geschichte* (2nd ed. 1748), and *Sittenlehre der heiligen Schrift* (1735-53). His exegetical writings, characterized by learning and good sense, include *Cogitationes in N. T. loc. select.* (1726), and expositions of 1 Cor. (1741) and the two Epistles to Timothy (1755). In his sermons (*Heilige Reden*) considerable eloquence is shown, and a mastery of style which justifies the position he held as president of the German Society.

There are two English versions of the *Institutes*, that of Archibald Maclaine, published in 1764, and that of James Murdock (1832), which is the more correct. Murdock's translation was revised and re-edited by James Seaton Reid in 1848, and by H. L. Hastings in 1892 (Boston). An English translation of the *De rebus christianorum* was published by Murdock in 1851.

MOSLER, HENRY (1841-), American artist, was born at New York, on the 6th of June 1841, the family removing to Cincinnati when he was about ten years old. Studying drawing by himself, he became a draughtsman for a comic paper, the *Omnibus* (Cincinnati), in 1855; in 1859-1861 he studied under James H. Beard, and in 1862-63, during the Civil War, was an art correspondent of *Harper's Weekly*. In 1863 he went to Düsseldorf, where for almost three years he was at the Royal Academy schools; he subsequently went to Paris, where he studied for a short time under Ernest Hébert. His "Le Retour,"

from the Paris Salon of 1879, was the first American picture ever bought for the Luxembourg. He received a silver medal in Paris 1889, and gold medals at Paris, 1888, and Vienna, 1893. Examples of his work are in the Sydney Art Museum, N.S.W., and the art museums of Springfield, Mass., Cincinnati, Ohio and New York. His son, GUSTAVE HENRY MOSLER (1875-1906), a pupil of his father and of Léon Bonnat, exhibited at the Salon in Paris, receiving a medal for his "De Profundis" in 1891; his portrait of Governor J. W. Stewart is in the State House, Montpelier, Vermont, and his "Empty Cradle" is in the Toledo Art Club.

MOSQUE (through Fr. *mosquée*; Span. *mezquita*, from Arab. *masjid*, *sajada*, to adore), the house of prayer in the

The earliest mosque erected was that at Mecca, which consisted of a great court, in the centre of which was the Ka'ba or Holy Stone. The court was surrounded with arcades, all of which constituted the prayer chamber, so that its plan is necessarily different to the normal type; the existing buildings date only from the first half of the 17th century, as the whole mosque was destroyed by a torrent in 1626.

The normal type referred to is best represented in the mosque of 'Amr (see 'AMR-IBN-EL-ASS) at Fostat, Cairo; built in A.D. 643 it still retains its original arrangement, though partly rebuilt and increased in its dimensions. The mosque (see fig. 1), now in a somewhat ruined condition, covers an area of about 130,000 sq. ft. with an open court, 240 ft. sq., and a sanctuary or prayer chamber, 106 ft. deep, there being a central avenue and ten aisles on either side. The columns and capitals were all taken from ancient buildings, Egyptian, Roman and Byzantine, and they carry arches of different forms, semicircular, pointed and horseshoe.

The columns and other materials of the mosque of el-Aksa at Jerusalem were taken by Abdalmalik (A.D. 690) from the ruins of Justinian's church of St Mary on Mount Sion, and the central avenue or nave built with them presents the appearance of a Christian church; it however runs north and south, the Mecca niche being at the south end; originally there were seven aisles on each side, now reduced to three. The Kubbet-es-Sakhra, or Dome of the Rock, at Jerusalem, is only a shrine erected over the sacred rock, so that the title often ascribed to it as "the mosque of Omar" is misleading.

The mosque of the Omayyads in Damascus was built by the Caliph Walid in A.D. 705 on the foundations of the basilican church of St John: its plan differs therefore from the normal type in that its arcades run east and west, and the transept in the centre becomes the prayer chamber. The Mecca niche is sunk in the doorway of a Roman temple which formerly occupied the same site, and the substructure of the minaret at the south-west angle is of still more ancient date. The great court on the north side has a lofty cloister round it, so that in many respects it follows the normal type.

The mosque of Ahmad Ibn Tulun, in Cairo (A.D. 879), is the first mosque erected in which the materials were not taken from ancient buildings; it has therefore a special interest as being the earliest genuine example of the Mahomedan style (see ARCHITECTURE: *Mahomedan*). The walls, piers and arches, are all built in brick, covered with stucco, a great portion of which is preserved down to the present day. The plan is of the normal type, with a great court in the centre, a prayer chamber four aisles deep on the Mecca side (south-east), and a double aisle on the other three sides. All the arches are pointed and slightly horseshoe, preceding therefore by about two and a half centuries the introduction of the pointed arch into Europe. The piers carrying the arches have shafts at their angles, the earliest examples known, and the decoration of the walls consists of friezes, borders, and impost-bands, all enriched with conventional patterns interwoven with cufic characters and modelled in stucco. The windows in the outer walls are filled with pierced stone screens of geometrical design. The architect is said to have been a Coptic Christian who deprecated the destruction of ancient buildings to obtain columns and blocks of stone, and who undertook to design a mosque which should be built entirely in brick, which when coated with stucco and appropriate decorative designs would rival its predecessors.

The next important mosque is that of Kairawan in Tunisia, which was founded by Sidi Okba in A.D. 675, but was partly rebuilt and added to in the following two centuries. Its court covers an area of 38,000 sq. ft., and its prayer chamber is 150 ft. deep, having a central avenue and eight aisles on each side.

The chief interest of the mosque at Kairawan lies in its being the prototype of the great mosque at Cordova, which was built by Abdarrahman in A.D. 780; the earliest portion of the mosque is the prayer chamber (135 ft. wide by 220 ft. deep), which is in front of the entrance gateway to the great court, and consists of a central avenue with five aisles on each side. In A.D. 961 this

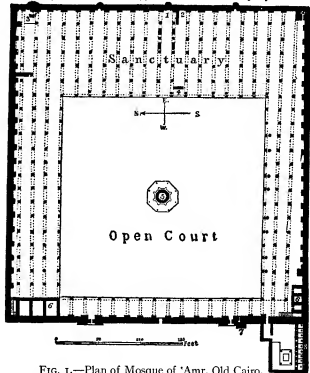

FIG. 1.—Plan of Mosque of 'Amr, Old Cairo.

- | | |
|------------------|---------------------------|
| 1, Kiblah. | 5, Fountain for ablution. |
| 2, Minbar. | 6, Rooms built later. |
| 3, Tomb of 'Amr. | 7, Minaret. |
| 4, Dikka. | 8, Latrines. |

Mahomedan religion, consisting generally of a large open court (*sahn*) surrounded by arcades (*iwān*), with a fountain (*mida'a*) in the centre of the court, for the ablutions necessary before prayer. The principal feature in the mosque is the niche (*mihrab*), which is sunk in a wall built at right angles to a line drawn from Mecca, and indicates the direction towards which the Moslem should turn when engaged in prayer. The arcades in front of the Mecca niche were sometimes of considerable depth, and constituted the prayer chamber (*makṣura*), portions of which were occasionally enclosed with lattice work. By the side of the niche was the pulpit (*minbar*), and sometimes in front of the latter a platform (*dikka*) raised on columns, from which chapters from the Koran were read to the people.

Most mosques have endowed property, which is administered by a warden (*naṣir*), who also appoints the imams and other officials. The larger mosques have two imams: one is called (in Arabia and Egypt) the *khatib*, and he preaches the sermon on Fridays (the Moslem Sabbath); the other, the *raṣib*, reads the Koran, and recites the five daily prayers, standing close to the *mihrab*, and leading the congregation, who repeat the prayers with him, and closely follow his postures. The imams do not form a priestly sect; they generally have other occupations, such as teaching in a school or keeping a shop, and may at any time be dismissed by the warden, in which case they lose the title of imam. Moslem women, as a rule, are expected to say their prayers at home, but in some few mosques they are admitted to one part specially screened off for them.

portion was extended 150 ft. in the rear by Hakim II., the mihrab and Mecca wall being rebuilt; about 20 years later a further enlargement was made, and eight more aisles were added along the whole eastern side, so that the prayer chamber covered an area of over 148,000 sq. ft. In the 13th century a portion of Hakim's addition was pulled down to make way for the first cathedral, which was dedicated to the Virgin. The most beautiful portion of the mosque, however, still exists in the prayer chamber of Hakim, where are to be found the earliest examples of the cusped arch and the origin of many of the geometrical patterns in stucco at the Alhambra.

The mosque of el Azhar, "the splendid," was begun about A.D. 970 by Jaubhar, the general of the Fatimite Caliph Moizz,

who captured Fostat and founded el Kahira, the present town of Cairo. It was based, therefore, on the great mosque at Kairawan, and although more or less rebuilt, it still preserves its original plan. It has a special interest in being the chief university of the Moslem world, containing some thousands of students (*mujawirin*), for whom certain parts of the mosque (*riwaq*) are screened off, according to the country from which they come. Thus special parts are reserved for natives of the various provinces of Egypt, of Morocco, Syria, Arabia, India, Turkey, &c. Each student can, if he is too poor to hire lodgings, live, eat and sleep in the mosque. Each has a large chest in which to keep his clothes and books; these are piled against the walls to a height of seven or eight feet. The students pay no fees, but the richer ones give presents to the lecturers, who sit on the matting in various parts of the sanctuary or cloister, while the students sit round each lecturer in a circle. The usual course of study lasts for three years, though some students remain for much longer. The chief of the lecturers, called the *Sheik el-Azhar*, receives about £100 a year, the others little or nothing, as regular pay. The Koran, sacred and secular law, logic, poetry, arithmetic, with some medicine and geography, are the chief subjects of study.

Of other mosques in Cairo, the finest is that of Sultan Hasan (fig. 2), completed in A.D. 1360. It differs from the normal type in many respects, as it includes residences for various sects, so that portions of it, with the several storeys externally, resemble an immense mansion or warehouse, and this would seem to have led to an important change inside, as instead of a cloister of two or more aisles there are four immense halls all covered with pointed barrel vaults. Beyond the Mecca wall is the tomb of the founder, covered with an immense dome.

The entrance doorway on the north-east side is over 80 ft. in height, its summit being decorated with stalactite vaults, one of the grandest features in Mahomedan architecture, only equalled by the magnificent portals of the mosques in India. The central square court, of moderate dimensions, with halls and great recesses, is followed in other examples in Cairo, among which the Tomb Mosque of Kait-Bey (c. A.D. 1470) is the most graceful (fig. 3). In this case the central court is roofed over, and has an octagon lantern in the centre; the recesses are covered with horizontal ceilings carried on great beams, the whole being elaborately carved, coloured and gilded; the tomb is covered with the later type of dome, built in stone, and elaborately carved outside with delicate conventional patterns in relief.

Although the conquest of Persia by the Arabs took place in A.D. 641 there are no remains of mosques there earlier than the 13th century, and the oldest example at Tabriz is evidently, as far as its plan is concerned, a copy of a Byzantine church, departing entirely therefrom from the normal plans.¹ The great mosque at Isfahan, built by Shah Abbas the Great (1585-1629), has one great court (225 ft. by 170 ft.) and two smaller ones, all with fountains in them. The prayer chamber is a lofty structure, quite unlike those of Egypt and Kairawan, with a dome 75 ft. in diameter and halls on each side divided into two aisles, each compartment being covered with a dome, in this respect also not following the early normal type, in which domes were only found over tombs.

The mosques of Constantinople are all copies more or less of S. Sophia: they have courts in front with a range of arcades round, and the centre portion forms the prayer chamber, the side aisles serving as passages. The central dome has but a slight elevation outside, but with the numerous cupolas round, and the minarets, it forms a picturesque group which is wanting in the mosques of Kairawan, Cordova, and other examples in North Africa.

In India as in other countries the Mahomedans took possession of the ancient buildings and adapted them to their religious requirements. The materials of the native styles of India, however, did not lend themselves to their utilization as in Syria, Egypt and North Africa, where the columns and capitals formed the substructure of the arcades which surrounded their courts. In the earliest mosque at old Delhi, they adopted the piers and bracketed capitals of the Jaina builders, whom they probably employed to build their mosque. They, however, had no confidence in the arch, which, as the Hindu says, "never sleeps but is always tending to its own destruction," so that the pointed arch, which had almost become the emblem of the Mahomedan religion, had to be dispensed with for the covered aisles which surrounded the great court, and in the triple entrance gateway the form of an arch only was retained, as it was constructed with horizontal courses of masonry for the haunches, and with long slabs of stone resting one against the other at the top. A similar construction was employed in the great mosque at Ajmere, built A.D. 1200-1211 at the same time as the Delhi mosque. The objection to the arch is more clearly shown

¹ It is very generally held that this "Blue Mosque" dates only from the 15th century (see TABRIZ).

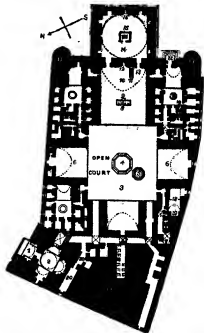

FIG. 2.—Plan of Mosque of Sultan Hasan, Cairo.

- 1, 2, Main entrance.
- 3, Court open to sky.
- 4, 5, Fountains.
- 6, 6, North and south vaulted transepts (the dotted lines show the curve of the vault).
- 8, 9, Dikka.
- 10, Sanctuary.
- 11, Minbar.
- 12, Kibleh.
- 13, Door to tomb.
- 14, Domed tomb-chamber.
- 15, Tomb within screen.
- 16, Kibleh.
- 17, 17, Minarets.
- 18, 19, 20, Various entrances to mosque.
- 21, Small rooms connected with service of the mosque.
- 22, Sultan's private entrance.

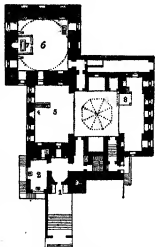

FIG. 3.—Mosque-tomb of Sultan Kait-Bey, Cairo.

- 1, Main entrance.
 - 2, Lobby and cisterns for ablution.
 - 3, Great minaret.
 - 4, Kibleh.
 - 5, Minbar.
 - 6, Sultan's tomb-chamber.
 - 7, The tomb within a screen.
 - 8, Dikka.
- (For views of interior and exterior, see ARCHITECTURE.)

in the entrance gateway of the Lal Darwaza or Red Gate mosque at Jaunpur, where an arch (of two rings of ogee shape) is carried by a solid wall, built under it, which is pierced with three doorways with bracket-capitals and architraves, returning therefore to trabecated construction. The covered aisles of the court of the Jumma Masjid at Jaunpur are in three storeys with piers, bracket-capitals and architraves, bearing therefore no resemblance to the arcades of Kairawan and Cordova, and constituting a different style. There is however one feature which throughout the Mahomedan mosques in India is always found, viz. the dome. But this also in India is built in horizontal courses, so that the form only and not the construction of the Cairene domes is followed. The chief peculiarity of the mosques at Ahmedabad is that, as the style progressed, it became more Indian; in the Jumma Masjid (A.D. 1420) and the Queen's mosque at Mirzapur, the pointed arch exists only in the façades of the prayer chambers; in the mosques built 30 to 40 years later the whole is constructed without a single arch, all the pillars have bracket-capitals, and the domes, which are of very slight elevation, are all built in the trabecated style. As a contrast to the Ahmedabad mosques, the Kadam Rasul mosque at Gaur in Bengal possesses some characteristics which resemble those of the mosque of Tulun in Cairo, possibly due to the fact that it is entirely built in brick, with massive piers carrying pointed arches.

The climax of Mahomedan work in India is reached in that of the Mogul emperors at Agra, Delhi and Fatehpur-Sikri, in which there is a very close resemblance in design to the mosques of Syria, Egypt, and Persia; the four-centred arch, which is in the Mogul style, finds general acceptance, and was probably derived from Persian sources. The mosque at Fatehpur-Sikri possesses in its great southern gateway, built by Akbar in the second half of the 16th century, the masterpiece of Indo-Saracenic architecture. As a rule, the mosques of India followed the normal plan, with a great central court and aisles round and a prayer chamber in front of the Mecca wall, which in India is always at the west end.

(R. P. S.)

MOSQUITO (Span. *mosquito*, a gnat, diminutive of *mosca*, a fly), a term originally applied to many species of small blood-

sucking insects in India, and of Grassi and others in Italy, directed the attention of the whole civilized world to mosquitoes as the exclusive agents in the dissemination of malarial fever. The result has been that in subsequent years mosquitoes have been collected, studied and described by naturalists and medical men in all parts of the globe. Nearly 100 genera and about 700 species of mosquitoes are now recognized, but in all probability the total number of species is not less than 1000.

In general appearance mosquitoes resemble many harmless midges (*Chironomidae*), but may be distinguished by the following characters. (1) The prolongation of the lower lip or labium into a prominent proboscis, which in the female sex contains the full complement of piercing organs found in blood-sucking Diptera, namely paired mandibles, paired maxillae, a tubular hypopharynx (the common outlet of the salivary glands), and an upper lip or labrum. (2) The presence of variously formed scales on the body and its appendages: the head is clothed with scales, the thorax with hairs or scales, and the abdomen with either hairs or scales, or both; the legs and veins of the wings are always covered with scales, and the palpi are often (as in some *Anophelineae*) conspicuously scaly. (3) The fact that the costal or marginal vein runs completely round the wing. The wings exhibit six longitudinal veins (seven in *Heptaphlebotomyia*), two of which are characteristically forked. The antennae, usually bottle-brush shaped (plumose) in the male sex, are less hairy in the female. The palpi vary in form and in the number of their component segments, and the proboscis, though usually straight, may be curved (as in *Megarhinus*) or otherwise modified in shape.

In dividing the *Culicidae* into genera reliance is placed chiefly upon characters derived from the scales on the three divisions of the body and on the wings. A fairly satisfactory attempt at grouping the genera has been made by Lutz (1904), who divides the family in the first place into the *Euculicidae*, with a piercing proboscis (i.e. all ordinary mosquitoes), and the *Culicimorphae* or forms without a piercing proboscis (*Mochlonyx*, *Corethra*, &c.). It has since been proposed to treat the *Culicimorphae* as a distinct family under the title *Corethridae*, and it is probable that with this modification Lutz's scheme will meet with general acceptance. The *Euculicidae* are divided into the *Asiphonatae* (= *Anophelineae*), the larvae of which have no respiratory siphon, and the *Siphonatae*, or forms in which a respiratory siphon is present in the larval state. The divisions of the *Siphonatae* are the *Ankylosternychae* (genera with curved proboscis, e.g. *Megarhinus* and *Toxorhynchites*) and *Orthorhynchae* (genera with straight proboscis). The latter again are divided into *Metanopsitae* (in which the metanotum or posterior region of the thorax is bare) and *Metanotrichae* (in which the metanotum is clothed with bristles or scales). The *Metanopsitae* are made up of the *Heteropalpae* (palpi long in the male, short in the female; sub-families *Culicinae* (*Culex*, &c.) and *Heptaphlebotomyinae* (*Heptaphlebotomyia*)) and *Micropalpae* (palpi short in both sexes; sub-families *Aedinae* (*Aedes*, &c.) and *Haemagoginae* (*Haemagogus*, *Uranotaenia*, &c.)). The *Metanotrichae* are similarly divided on the basis of the palpal characters into two groups, the *Heteropalpae* or *Hylconopinae* (*Johllia*, *Rhynchomyia*, &c.) and *Micropalpae* or *Dendromyinae* (*Wyeomyia*, *Sabethes*, *Limatux*, &c.).

The old genus *Anopheles* (characterized by the palpi being long in both sexes) is now divided into a number of genera according to the character and shape of the scales on the different regions of the body and on the wings. These genera make up the sub-family *Anophelinae*, and together include over 100 species. The genus *Culex*, from which the family takes its name, though it has been similarly split up, is still in its restricted sense larger than any other, and some 200 species are comprised in it alone.

Mosquitoes are found in all parts of the world. Even within the Arctic Circle they are in many localities abundant and excessively bloodthirsty during the short summer. Under such conditions the deeply-rooted nature of the blood-sucking instinct is most remarkable; for insects whose ancestors for many generations may not have tasted blood will seek for it with the utmost keenness and pertinacity so soon as an opportunity presents itself. Some species are normally phytophagous, and the vast majority, at any rate, appear to be capable of continuing to exist and reproducing their kind upon a purely vegetarian diet. As a rule the blood-sucking habit is confined to the females, but in the case of a few species it is said to be common to both sexes. The thirst for blood is stimulated by heat, and in temperate climates it is only during hot weather that mosquitoes are troublesome. Some species of mosquitoes, such

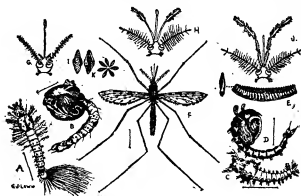

FIG. 1.

- A, Larva of *Anopheles*.
 B, Pupa of *Anopheles*.
 C, Larva of *Stegomyia*.
 D, Head of *Culex*.
 E, Head of *Aedes* and further enlarged detached egg of *Culex*.
 F, Female *Anopheles costalis*, Loew.
 G, Head of ♀ *Culex*.
 H, Head of ♂ *Culex*.
 I, Head of ♂ *Culex*.
 J, Head of ♂ *Culex*.
 K, Eggs of *Anopheles*.

sucking DIPTERA (*q.v.*), belonging to various families, but now by common consent restricted to those known to naturalists as *Culicidae*, or gnats. Before the year 1809 mosquitoes had never been collected systematically, and had received little notice from entomologists, so that but few genera and comparatively few species were known. Although it had long been suspected that these insects were in some way connected with malaria and other diseases, while that the species now called *Stegomyia calopus* was the carrier of yellow fever had been asserted by Finlay as early as 1881, it was not until the closing years of the 19th century that the brilliant researches of Ross in

as the common gnat (*Culex pipiens*), are rarely found away from human habitations; others seldom or never enter houses, but are met with either in more or less open country, or in the recesses of forests and woods. In Europe and North America the continued existence of species is ensured by the hibernation of impregnated females, or else the winter is passed in the egg or occasionally in the larval state. In tropical climates with a well-marked dry season mosquitoes pass into a semi-dormant condition during the period when there is little water in which to deposit their eggs. *Culicidae* are by no means confined to low-lying districts, and have even been met with in the Himalayas at an altitude of 13,000 feet. The wide distribution of certain species is undoubtedly attributable to the agency of ships and trains; under natural conditions mosquitoes seldom travel far from their breeding grounds, although the powers of flight of some species are greater than has been supposed.

The preliminary stages of all mosquitoes are passed in water, either fresh or salt, stagnant or slightly moving. The nature of the breeding-place varies greatly according to the species, and while many of the mosquitoes that infest houses will breed even in the smallest accidental accumulation of water such as may have collected in a discarded bottle or tin, the larvae of other species less closely associated with man are found in natural pools or ditches, at the margins of slow-moving streams, in collections of water in hollow trees and bamboo-stumps, or even in the water-receptacles of certain plants. The eggs are usually deposited on the water itself, and while in the case of certain species, such as *Culex pipiens* or the widely distributed *C. fatigans*, they are agglutinated together in masses known as "boats" or "rafts" containing from 50 to 400 ova, those of others, such as the *Anopheleinae* and many *Culicinae* (e.g. *Stegomyia calopus*), are laid separately. The larvae are active and voracious little grub-like creatures (known in the United States as "wrigglers"), with large heads and jaws provided with a pair of brushes, which sweep food-particles into the mouth. Their food consists of minute animal and vegetable organisms,

and lie almost horizontally at the surface; they frequently appear as though anchored by the tail to a weed or other object, and possess the curious faculty of completely rotating the head so as to browse on the surface film. Mosquito pupae are comma-shaped (see fig. 1), and breathe by means of a pair of respiratory trumpets on the thorax.

The majority of mosquitoes are dull in hue, but certain species are brilliantly coloured or conspicuously banded or spotted with white. The *Anopheleinae* have narrow bodies, and generally spotted wings, and when at rest keep body and proboscis in a straight line, often at a considerable angle with the supporting surface; in this way they can be distinguished from *Culicinae*, which have a humped-up thorax with which the proboscis forms an angle, and in the resting position keep the body parallel to the support.

The disseminators of malaria are exclusively *Anopheleinae*, but even among these it is only certain species that are dangerous, since the others appear to be incapable of acting as hosts of the parasites. *Stegomyia calopus*, on the other hand, a very widely distributed species and the almost certain carrier of yellow fever, belongs to the *Culicinae*. In the case of filariasis due to *Filaria bancrofti*, which is common throughout the Tropics, the embryos of the parasite are disseminated by various *Culicinae* and *Anopheleinae* (*Culex pipiens* in Queensland; *C. fatigans* in the West Indies; *Myzomyia rossii* in India; *Pyretophorus costalis* in a large portion of tropical Africa; &c.). Six or seven species of mosquitoes are also the intermediate hosts of *Filaria immitis*, which infests the right auricle and pulmonary artery of the dog, and occurs throughout the tropics, in southern Europe, the United States of America, and elsewhere. There is reason to believe that malaria, yellow fever and filariasis are not the only diseases disseminated by mosquitoes. (E. E. A.)

MOSQUITO COAST AND RESERVE (MOSQUITIA or RESERVA MOSQUITIA), a division of the republic of Nicaragua, officially styled the department of Zelaya. Pop. (1905), about 15,000. Although its name is sometimes applied to the whole eastern seaboard of Nicaragua—and even to Mosquitia in Honduras, i.e. the coast region as far west as the Rio Negro or Tinto—the Mosquito Coast is more accurately defined as a narrow strip of territory, fronting the Caribbean Sea, and extending from about 11° 45' to 14° 10' N. It stretches inland for an average distance of 40 m., and measures about 225 m. from north to south. In the north, its boundary skirts the river Wawa; in the west, it corresponds with the eastern limit of the Nicaraguan highlands; in the south, it is drawn along the river Rama. The chief towns are Bluefields or Blewfields, Magdala on Pearl Cay, Prinzapolca on the river of that name, Vounta near the mouth of the Cuculaia, and Carata near the mouth of the Wawa. Bluefields (pop. about 2000) is the capital and the largest town. It is the seat of a Moravian mission, and has a good harbour, with regular steamship services to Greytown in Nicaragua, and to New Orleans. It exports bananas and other fruit.

The Mosquito Coast is so called from its principal inhabitants, the Misskito Indians, whose name was corrupted into Mosquito by European settlers and has been entirely superseded by that form except in the native dialects. The Mosquito Indians, of whom there are several tribes, are an unusually intelligent people, short of stature and very dark-skinned. Their colour is said to be due to intermarriage with shipwrecked slaves.

The first white settlement in the Mosquito country was made in 1630, when the agents of an English chartered company—of which the earl of Warwick was chairman and John Pym treasurer—occupied two small cays, and established friendly relations with the Indians. From 1655 to 1850 Great Britain claimed a protectorate over the Mosquito Indians; but little success attended the various endeavours to plant colonies, and the protectorate was disputed by Spain, the Central American republics, and the United States. The opposition of the United States was due very largely to the fear that Great Britain would acquire a privileged position in regard to the proposed interoceanic canal. In 1848, the seizure of Greytown (San Juan del Norte)

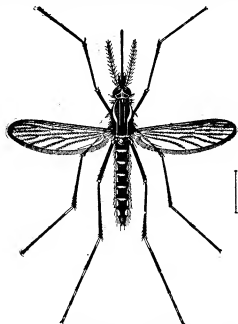

(Redrawn by permission from Farmers Bulletin 155, Bureau of Ent., U.S. Dept. of Agriculture.)

FIG. 2.—*Stegomyia calopus* (*Culex fasciatus*, *Stegomyia fasciata*).

algae, and probably decaying vegetable matter; they are often cannibals, and feed on their own species. The larvae of species belonging to the *Culicinae* have a prominent breathing tube, or respiratory siphon, on the penultimate (eighth) abdominal segment, and when taking in air hang head downwards (often nearly vertically) from the surface film. Larvae of *Anopheleinae*, on the other hand—which are grey, green or brown in colour, and often extremely difficult to see—have no respiratory siphon

by the Mosquito Indians, with British support, aroused great excitement in the United States, and even involved the risk of war. But by the Clayton-Bulwer Treaty of 1850 both powers pledged themselves not to fortify, colonize or exercise dominion over any part of Central America; and in November 1859 Great Britain delegated its protectorate to Honduras. This caused great dissatisfaction among the Indians, who shortly afterwards revolted; and on the 28th of January 1860 Great Britain and Nicaragua concluded the treaty of Managua, which transferred to Nicaragua the suzerainty over the entire Caribbean coast from Cape Gracias a Dios to Greytown, but granted autonomy to the Indians in the more limited Mosquito Reserve (the area described above). The local chief accepted this change on condition that he should retain his local authority, and receive a yearly subvention of £1000 until 1870. But on his death in 1864 Nicaragua refused to recognize his successor. The reserve nevertheless continued to be governed by an elected chief, aided by an administrative council, which met in Bluefields; and the Indians denied that the suzerainty of Nicaragua connoted any right of interference with their internal affairs. The question was referred for arbitration to the emperor of Austria, whose award published in 1880, upheld the contention of the Indians, and affirmed that the suzerainty of Nicaragua was limited by their right of self-government. After enjoying almost complete autonomy for fourteen years, the Indians voluntarily surrendered their privileged position, and on the 20th of November 1894 their territory was formally incorporated in that of the republic of Nicaragua, as the department of Zelaya.

BIBLIOGRAPHY.—See "A Bibliography of the Mosquito Coast of Nicaragua," by Courtney de Kall, in *Bulletin of the American Geog. Soc.*, vol. xxvi. (1894); and "Studies of the Mosquito Shore in 1892," by the same author, and in the same publication, vol. xxv. (1893). "A Forgotten Puritan Colony," in No. 165 of *Blackwood's Magazine* (Edinburgh, 1898), described the attempt at colonization made in 1630. See also "Die Streit um die Mosquito-Küste," by J. Richter, in *Zeitschr. f. Gesellschaft u. Erdkunde*, No. 30 (Berlin, 1895).

MOSS, a seaport of Norway, in Smaalenene amt (county), on the east shore of Christiania Fjord, 37 m. S. of Christiania by the Gothenburg railway. Pop. (1900), 8041. Here was signed, on the 14th of August 1814, the convention which united Norway to Sweden. Timber and wood pulp are chief exports, grain and coal are imported. The port affords 13 to 22 ft. of water beside the quays.

MOSSAMEDES, a town of Portuguese West Africa, capital of the district of Mossamedes, on the south side of Little Fish Bay (Bay of Mossamedes or Angra do Negro). Pop. about 5000. The harbour affords excellent anchorage. A railway (over 100 m. long) starts from the harbour and crosses the semi-desert coast region to the fertile Chella plateau. Mossamedes is the headquarters of an important fishing industry (see *La Géographie*, March 1908).

MOSSSEL BAY, the name of a bay, town and division of the Cape province, South Africa. The bay lies midway between Table Bay (Cape Town) and Port Elizabeth roadstead. Like most of the South African bays it does not afford good anchorage. Westward, however, it is sheltered by Cape St Blaize, on which is a lighthouse. The town lies on the west side of the bay, Cape St Blaize stretching beyond to the S.E. Mossel Bay is 250 m. by sea and 312 m. by rail E. by S. of Cape Town. Pop. (1904), 4500. The port ranks fourth in importance among the seaports of the Cape and does a large forwarding trade. Vessels load and discharge by means of lighters. Mossel Bay is a station on the direct Cape Town-Port Elizabeth railway. The Mossel Bay division of the province has an area of 707 sq. m., and a population (1904) of 10,700, of whom 49% were whites.

MOSSLEY, a market town and municipal borough in the Prestwich parliamentary division of Lancashire, England, 10½ m. E.N.E. from Manchester, by the London & North-Western railway. Pop. (1901), 13,452. It lies in the valley of the Tame, close to the junction of the boundaries of Lancashire, Cheshire and Yorkshire, and is surrounded by sharply-rising high ground, especially eastward. The Huddersfield canal passes it. Across the river from the town ancient earthworks (Bucton Castle), of

British origin, are seen, and a Roman road passing them, and running north and south is also traceable. Mossley has foundries, mill-works, woollen factories, and large cotton-spinning mills. It was incorporated in 1885, and the corporation consists of a mayor, 6 aldermen, and 16 councillors. Area, 3622 acres.

MOSSOP, HENRY (1729-1774), Irish actor, was born in Dublin, and made his first stage appearance there, at the Smock Alley Theatre, as Zanga in Young's tragedy, *The Revenge*, in 1740. His first London appearance was made in 1751 under Garrick's management, as Richard III. He returned to Ireland in 1759, and, playing with Barry, added to his laurels, but when he attempted management on his own account, he ruined Barry and went bankrupt himself, dying in poverty on the 27th of December 1774.

MOST, JOHN [JOSEPH] (1846-1906), German-American anarchist, was born in Augsburg, Bavaria, on the 5th of February 1846. He was apprenticed to a bookbinder, worked at this trade in Germany, Austria, Italy and Switzerland in 1863-1868, and then became a writer of Socialist pamphlets and paragraphs, and editor of Socialist sheets in Chemnitz and Vienna, both suppressed by the authorities, and of the *Freie Presse* in Berlin, being repeatedly arrested for his violent and cynical attacks on patriotism and conventional religion and ethics, and for his gospel of terrorism, preached in prose and in many songs such as those in his *Proletarier-Liederbuch* (5th ed., 1875). Some of his experiences in gaol were recounted in *Die Bastille am Plötzensee: Blätter aus meinem Gefängnis-Tagebuch* (1876). In 1874-1878 he was a member of the German Reichstag, but he failed to be re-elected, was expelled by the Socialist organization, went to France but was forced to leave in 1879, and then settled in London. There he founded the "red" organ—it was printed in red—*Die Freiheit*, in which he expressed his delight in June 1881 over the assassination of Alexander II. of Russia and for this was imprisoned for a year and a half. He then resumed the publication of *Die Freiheit* in New York. He was imprisoned in 1886, again in 1887, and in 1902, the last time for two months for publishing after the assassination of President McKinley an editorial in which he argued that it was no crime to kill a ruler. He died in Cincinnati on the 17th of April 1906. See his *Memoires* (New York, 1903).

MOSTAGANEM, chief town of an arrondissement in the department of Oran, Algeria, 44 m. E.N.E. of Oran, on a plateau 278 ft. high, half a mile from the Mediterranean coast. The town is separated into European and native quarters by a deep ravine, the Ain Sefra, through which passes a considerable stream. The native quarter, called Tijit, occupies the eastern slopes of the ravine and the level ground above, and is dominated by the kubbas of two marabouts. A railway line, completed in 1889, 122 m. long, connects Mostaganem with Tiaret, the most convenient place for visiting the Jedars monuments. (See ALGERIA.)

Mostaganem occupies the site of a Roman town. The ancient harbour was destroyed by earthquake in the reign of the emperor Gallien. The present port is entirely artificial. The existing town appears to date from the time of the Almoravides, who built the citadel, now turned into a prison. It passed into the possession of the rulers of Tlemçen and was captured by Arouj Barbossa in 1516, and became part of his brother Khair-ed-Din's kingdom. In the 16th century the town enjoyed a period of great commercial prosperity, and its population rose to 40,000. The re-awakening of the town dates from the French occupation in 1833. Pop. (1906) of the town, 19,528, of the commune 22,011, of the arrondissement, comprising 27 communes, 332,684.

In the vicinity of Mostaganem are the Dahra mountains, honey-combed with caves. In 1845, in one of these caves, a French force, commanded by Colonel Pellissier, afterwards commander-in-chief of the French army in the Crimea, destroyed over 800 Arab men, women and children—by suffocation, by filling the mouths of the cave with faggots and then setting them on fire.

MOSTAR, the capital of Herzegovina, situated 81 m. S.W. of Sarajevo, on the river Neretna, and on the railway from Sarajevo

to Ragusa. Pop. (1900), about 14,500 including the garrison. Mostar is the seat of Roman Catholic and Orthodox bishops, a district court, and an Austrian garrison. Half Turkish, half Italian in character, it commands the gateway through which all heavy traffic must pass on the seaward road. A single arch of great beauty, 89½ ft. in span, and 61 ft. high, leads to the Roman Catholic quarter, on the right bank of the river. This bridge has been the theme of many legends, and its origin has been much debated. Probably it was built by the Turks, in the 15th or 16th century, after Italian designs; but some antiquaries ascribe its foundation to the Romans. Since 1881, when an iron bridge was opened, its use has been confined to foot passengers. Mostar possesses a gymnasium, a school of viticulture, and a massive Orthodox cathedral.

The present name of the city has been derived from the Serbo-Croatian *most*, a bridge, and *star*, old. Its earlier Slavonic name was *Virinicha*. Whether it may be identified with *Pons Velus*, *Andretium*, *Bistuae*, *Saloniana*, or *Sarsenterum*, it certainly dates from Roman times. Mostar was enlarged in 1440 by Radivoi Gost, mayor of the palace to Stephen, first duke of St Sava. Immediately on their conquest of Herzegovina it was chosen by the Turks as their headquarters. The environs of the city are interesting. Within a few miles are the sources of the Buna, a small affluent of the Narenta, which issues from a cavern at the foot of Podvelež, amid scenery celebrated for its wild grandeur.

See Sir G. Wilkinson, *Dalmatia and Montenegro* (London, 1848), vol. ii. (view and plan at pp. 59, 60); J. Asboth, *An Official Tour through Bosnia and Herzegovina* (London, 1890), pp. 255-262; and R. Munro, *Bosnia and Herzegovina* (Edinburgh, 1900), pp. 179-188.

MOSUL, a town of Mesopotamia, capital of a Turkish vilayet and sanjak of the same name, on the right bank of the Tigris, in 36° 35' N., 43° 3' E. Pop. 40,000 (Moslems 31,500, Christians 7000, Jews 150). In Mosul, as in Bagdad, only part of the space within the walls is covered with buildings and the rest is occupied by cemeteries; even the solid limestone walls of the ancient town are half in ruins, being serviceable only in the direction of the river, where they check inundations. Of the town gates at present in use, five are on the south, two on the west, two on the north, and the great bridge gate on the east. Leaving Mosul by the last named, the traveller first crosses a stone bridge, 157 ft. long; then a kind of island (140 ft.), which is overlaid only in spring and summer by the Tigris; next a stretch of the river which, at such times as it is not fordable, is spanned by a bridge of boats, the bridge proper covering only one-sixth of the full width of the stream. During the season of low water excellent vegetables, particularly water-melons, are grown upon the islands and dry portions of the river-bed.

The interior of Mosul has an insignificant appearance, only a few of the older buildings being left, among which may be mentioned the Great Mosque, with its leaning minaret, formerly a church dedicated to St Paul. The streets are for the most part badly paved and very narrow, a small square in the marketplace, overlooked by airy coffee-booths, being almost the only open space. The shops are few and poor. The industry in comparison with former times, when the town had so considerable a manufacture in muslin as to give its name to that fabric, is very unimportant; trade also, which is almost exclusively in the hands of native merchants, has fallen off greatly, although the town remains the collecting and distributing centre for the north Mesopotamian desert and Kurdistan. The exports and most of the imports pass through Bagdad. Mosul is the meeting-point of roads from Aleppo, Diarbekir, Bitlis, north and west Persia and Bagdad; and it is on the projected line of railway from Constantinople to the Persian Gulf. Gall nuts, gathered on the neighbouring Kurdish mountain slopes, are mostly exported, but are also made use of by native dyers; and hides, wax, cotton and gum are sold. Christians and Moslems have lived together on better terms here than elsewhere. Both are animated by an active local patriotism, and both honour the same patron saints, Jirjis (St George) and Jonah; the grave of the latter is pointed out on an artificial mound on the left bank of the Tigris.

The language of the people of Mosul is a dialect of Arabic, partly influenced by Kurdish and Syriac. The Moslems call themselves either Arabs or Kurds, but the prevalent type, very different from the true Arabian of Bagdad, proves the Aramaean origin of many of their number. Of the Christians the community of the Chaldaeans, *i.e.* those who have gone over from Nestorianism to Catholicism, seems to be the most important; there are also Syrian Catholics and Jacobites. Mosul has for several centuries been a centre of Catholic missionary activity, the Dominicans especially, by the foundation of schools and printing-offices, having made a marked impression upon an intelligent and teachable population. There are very few Protestants. The town is the seat of British, French and Russian consulates.

Mosul shares the severe alternations of temperature experienced by upper Mesopotamia. The summer heat is extreme, and in winter frost is not unknown. Nevertheless the climate is considered healthy and agreeable; copious rains fall in general in winter. The drinking water is got from the muddy Tigris. At the north-east corner of the town is a sulphur spring, and 4 leagues to the south there is a hot sulphur spring (Hammâm 'Ali), much frequented by invalids.

Mosul probably occupies the site of a southern suburb of ancient Nineveh (*q.v.*) but it is very doubtful whether the older name of Mespila can be traced in the modern Al-Mauşil (Arab., "the place of connexion"); it is, however, certain that a town with the Arabic name Al-Mauşil stood here at the time of the Moslem conquest (636 A.D.). The town reached its greatest prosperity towards the beginning of the decline of the caliphate, when it was for a time an independent capital. The dynasty of the Hamdanids reigned in Mosul from 934, but the town was conquered by the Syrian Oukulids in 990. In the 11th century it belonged to the Seljuks, and in the 12th, under the sway of the Atabegs, particularly of Zenki, it had a short period of splendour. Saladin besieged it unsuccessfully in 1182. The Persians occupied Mosul for a short time in 1623, until it was, soon afterwards, recovered by sultan Murad IV. The governorship of the pashalik was long hereditary in the originally Christian family of the 'Abd-al-Jalil, until the Porte, during the course of the 19th century, succeeded after a long and severe contest in establishing a more centralized system of government.

The VILAYET OF MOSUL lies mainly east of the Tigris. It is divided into three sanjaks, Mosul, Shehrizor and Suleimanieh, and has an area of 29,000 sq. m. Pop. 295,000 (Moslems 245,000, Yezidis 15,000, Christians 30,000 and Jews 5000).

See Karl Ritter, "Asien," vol. ii. in *Die Erdkunde* (Berlin, 1844). A map of the town accompanies J. Cernik's paper, "Studienexpedition durch die Gebiete des Euphrat und Tigris," in *Ergänzungsheft No. 45 of Petermanns Mitteilungen* (Gotha, 1876); Parry, *Six Months in a Syrian Monastery* (1895); E. Sachau, *Am Euphrat und Tigris* (Berlin, 1899); Baron von Oppenheim, *Vom Mittelmeer zum Persischen Golf* (Berlin, 1900).

MOSZKOWSKI, MORITZ (1854-), Polish musical composer, was born at Breslau, and studied at Dresden and Berlin. He started as a pianist, and had a great success at the chief European centres. He was made a member of the Berlin Academy in 1899. In 1897 he settled in Paris. He became a prolific composer both for pianoforte and for orchestra, but is best known by his Spanish dances, written for four hands on the piano, and his waltzes. His opera *Boabdil* was performed at Berlin in 1892.

MOTALA, a town of Sweden, in the district (*län*) of Östergötland, on the east side of Lake Vetter at the outflow of the river Motala, 175 m. S.W. by W. of Stockholm by rail. Pop. (1900), 3047. It is on the Göta canal route (*q.v.*). The town was founded in 1880, but the Motala mechanical works, 2 m. east, were founded in 1823 by the Göta Canal Company under the direction of Daniel Frazer, an Englishman. Iron war-ships, railway locomotives, iron bridges, machinery, &c., are built; the company has branches in Norrköping, Gothenburg, and elsewhere.

MOTANABBI, strictly AL MUTANABBI¹ (أَبُو تَائِبِ يَحْيَى أَحْمَدُ بْنُ أَحْسَانَ بْنِ كُتَيْبَةَ) (d. 5/6-965), was the most famous representative of the "he who plays the prophet."

tative of the last period of Arabic poetry, was the son of a water-carrier, and is said to have picked up much of the literary knowledge for which he was afterwards famous by haunting the book-stalls of his native city. He spent too, some years of his youth among the nomads of the Syro-Arabian desert, learning their purer dialect, and becoming imbued with their self-reliant spirit. Thus he grew up a brave proud man, a gallant warrior as well as a poet, not easily satisfied either with wealth or honours, indifferent to the Koran and to the fasts and prayers of Islām, but untainted by the looseness of morals common to the poets of those days. At first he essayed a perilous road to distinction, appearing in the character of a prophet in the desert between the Euphrates and Syria, where he formed a considerable party, but was arrested by the governor of Emesa (Homs). A prison cooled his enthusiasm. The name of *al-Mutanabbi* clung to him, however, and is that by which he is still commonly known. Regaining his liberty, he had to struggle for a time with poverty and neglect. But his poetical talents at length found him patrons, and in 948 he became attached to the court of the famous warrior and patron of letters, Saif ad-daulā, prince of Aleppo, to whom many of the best fruits of his muse were dedicated, and by whose side he approved his valour in the field. But he had rivals who knew how to inspire jealousy between him and the prince, and an angry scene with the grammarian Khālawaih, in which the latter closed a philological dispute by striking Motanabbi, in the very presence of the prince and without rebuke from him, led the poet to leave the court and seek a new career in the realm of the Ikshīds (957). He now took as his patron and the object of his eulogies Kāfir, the regent of Egypt—a black eunuch who knew how to open the poet's lips by great gifts and honours. Motanabbi, however, sought a higher reward, the government of Sidon, and at length broke with Kāfir, wrote satires against him, and had to fly for his life to Kufa (961). His next great patron was 'Aḍad ad-daulā of Shirāz, and on a journey from Shirāz to Kufa he was waylaid and slain by a chieftain of the Asad, whose kinsfolk he had satirized (September 965).

The poetry of Motanabbi is to European taste much less attractive than the verses of the ancient Arab poets, being essentially artificial and generally unreal, though it has great technical merits and displays lively fancy and considerable inventive power.

Oriental taste places him on a very high pedestal, as may be judged from the fact that more than forty commentaries were written on his *Diwān* (H. Khal., iii. 306). Dieterici's edition of the poet (Berlin, 1858–1861), gives the commentary of Wāhidi (d. 1075); the Egyptian edition of 1870 has the commentary of 'Ukbari (d. 1219). A convenient edition is that published with a commentary of Naṣīf ul-Yazīji at Beirut (1882). See R. A. Nicholson, *A Literary History of the Arabs* (London, 1907), pp. 304–313.

MOTET, a musical art-form of paramount importance in the 16th century. The word is of doubtful etymology, and probably its various uses and forms in the 13th and 14th centuries connect with more than one origin. Thus *motulus* suggests *modulus* or melody; and probably represents the notion underlying the use of the term *motetus* or *motellus* to designate one of the middle parts in a vocal combination. On the other hand the obvious connexion between the Italian word *motetto* (diminutive of *motto*) with the French *mot* (in the sense of *bon mot*) is in conformity with the use of a profane art-form contemporary with the *conductus* and *rondel* of these early epochs of music.

The only really definite and mature art-form denoted by the word motet is that of the 16th-century pieces of ecclesiastical music in one or two (rarely more) continuous movements, for the most part on Biblical or other ecclesiastical prose texts. The word is, however, used for any single Latin-text composition in continuous form, not set sectionally verse by verse, and not forming a permanent part of the mass. Thus Palestrina's *Stabat mater* is included among his motets; though the text is metrical and rhymed, and the style, though continuous, is far from being that of the typical polyphonic motet. The title of motet is also occasionally loosely used for non-ecclesiastical

works, such as many of the numbers in the *Magnum opus musicum* of Orlando di Lasso and the dedicatory motet at the beginning of Palestrina's fifth book. And in this way it is sometimes applied to compositions not to Latin text; as in Josquin's *Déploration de Jehan Okenheim*, where all except the *canto fermo* is in French.

The most important kind of motet is that which is intimately connected with the solemn mass for a particular holy day. Such motets are sung between the *Credo* and the *Sanctus* of the mass. They are, in typical cases, founded on the Gregorian tones of their texts, and the mass is founded on the same themes, thus giving the whole service a musical unity which has never since been approached in any church music even under Bach. When a motet was not founded on Gregorian tones it was still possible for the composer to design a mass on the same themes, and most of the titles of 16th-century masses, when they do not indicate a secular origin, indicate either the motet or the Gregorian tones on which they are founded. Thus Palestrina's masses *Assumpta est Maria*; *O admirabile commercium*; *Dum compleretur*; *Hodie Christus natus est*; *Dies sanctificatus*; *Veni sponsa Christi*, and the second *Missa Tu es Petrus*, are magnificent examples selected almost at random from the masses which the composer has founded on his own motets of the same name. When such masses are performed, whether in a concert-room or church, it is indisputable that the motet ought always to be included. Sometimes one composer founded a mass on another composer's motet; thus Soriano's fine *Missa, Nos autem gloriari*, is based upon a motet by Palestrina. When a motet was in two movements the second movement almost always ended with the last clauses of the first, both in text and in music, thereby sometimes producing a distinctly modern impression of *da capo* form.

In later times the term motet is little more than a name for any choral composition of clearly single design; and the fact that such compositions have often been sung, like the 16th-century motet, between the *Credo* and *Sanctus* of High Mass, has nothing to do with their character as an art-form. Bach's motets are great German choral works in several movements, with no written accompaniment, though there is internal and external evidence that they were accompanied from score by the organ. Handel's motets belong to his Italian period and are simply Latin cantatas of various kinds, with instrumental accompaniment. The later meanings attached to the word are quite indefinite, and have no common idea, except that the motet is nowadays the shortest kind of sacred choral music.

(D. F. T.)

MOTH, in entomology, any lepidopterous insect belonging to the division *Heterocera*, as distinguished from the *Rhopalocera*, or butterflies; formerly confined to the small nocturnal insect (belonging to the genus *Tinea*), which breeds in fur, clothes, &c. (see *LEPIDOPTERA*). The word in O Eng. is *moþe*, and corresponds to Ger. *Motte*.

MOTHER, the term for the female parent of a child. The word, like father, is common to Indo-European languages, cf. in Teutonic languages, Ger. *Mutter*, Du. *moeder*, Swed. and Dan. *moder*; Gothic is the exception in Teutonic languages, the word being *aīthei*, cf. *atta*, father; from Lat. *mater* come, in Rumanic, Fr. *mère*, Ital., *madre* and Port., *madre*. Greek has *μήτηρ*, (Attic and Ionic), *μᾶτηρ* (Doric). The Russian word is *mat*. The Sansk. *matā* points to an original derivation from a stem *ma*, to measure, or make. Of the many transferred applications of "mother" may be mentioned those to the church, to nature, to the earth, and to a city or nation, as the parent of other cities, nations, colonies, &c. As a title "mother" is particularly applied to the head of a religious community of women. For "mother-of-pearl" see PEARL. There is a particular application of "mother" to the scum which rises to the surface of a liquor during the process of fermentation, and also to a mass of gummy stringy consistency formed in vinegar in the process of acetous fermentation, hence known as "mother of vinegar" (see *VINEGAR*). This is usually, however, taken to be another word altogether, and connected with Du. *modder*, mud, mire.

MOTHERWELL, WILLIAM (1797-1835), Scottish poet, antiquary and journalist, was born at Glasgow on the 13th of October 1797, the son of an ironmonger. At the age of fifteen he was apprenticed in the office of the sheriff-clerk at Paisley, and appointed sheriff-clerk depute there in 1819. He spent his leisure in collecting materials for a volume of local ballads which he published in 1819 under the title of *The Harp of Renfrewshire*. In 1827 he published a further instalment in *Minstrelsy Ancient and Modern*, prefaced by an excellent historical introduction. He contributed verses to newspapers and magazines, *Jeannie Morrison*, *My Heid is like to rend, Willie*, and *Wearie's Cauld Well* being his best-known poems. He became editor of the *Paisley Advertiser* in 1828, and of the *Glasgow Courier* in 1830.

A small volume of his poems was published in 1832, and a larger volume with a memoir in 1846, reissued, with additions, in 1848.

MOTHERWELL, a municipal and police burgh of Lanarkshire, Scotland. Pop. (1851, 900; 1901, 30,418). It is situated near the right bank of the Clyde, 13 m. S.E. of Glasgow by the Caledonian railway. It takes its name from an old well dedicated to the Virgin, and owes its rapid increase to the coal and iron mines in the neighbourhood. It has large iron and steel works, bridge-building being a distinctive industry. Boilers, steam-cranes and ironmongers' ware are also made, and there are brick, tile and fireclay works. The public buildings include the town-hall, theatre and hospital; the park was presented in commemoration of Queen Victoria's Jubilee.

MOTION (Lat. *motio*, from *moveo*, to move), in English law, an application made to a court during the progress of an action, and either before or after judgment has been pronounced. The object of a motion is to invoke the assistance of the court in matters that are of a pressing character, and require to be speedily dealt with. A motion differs from a petition in that it is made *in vivo* in open court and is founded on a written statement. Motions are either motions of course or special motions. A motion of course is made *ex parte* without notice, and is not mentioned in court, the party being entitled as of right. Motions of course are confined to the chancery division of the High Court. A special motion is made in open court, and must be supported by proper evidence. Special motions are made either *ex parte* or on notice. On all *ex parte* applications the utmost good faith must be observed. *Ex parte* motions, in the king's bench division, are usually made to a divisional court. A motion for judgment is a proceeding whereby a party to an action moves for judgment of the court in his favour. See *Rules of the Supreme Court*, Ors. xl., lii.

MOTION, LAWS OF. Before the time of Galileo (1564-1642) hardly any attention had been paid to a scientific study of the motions of terrestrial bodies. With regard to celestial bodies, however, the case was different. The regularity of their diurnal revolutions could not escape notice, and a good deal was known 2000 years ago about the motions of the sun and moon and planets among the stars. For the statement of the motions of these bodies uniform motion in a circle was employed as a fundamental type, combinations of motions of this type being constructed to fit the observations. This procedure—which was first employed by the great Greek astronomer Hipparchus (2nd century B.C.), and developed by Ptolemy three centuries later—did not afford any law connecting the motions of different bodies. Copernicus (1473-1543) employed the same system, and greatly simplified the application of it, especially by regarding the earth as rotating and the sun as the centre of the solar system. Kepler (1571-1630) was led by his study of the planetary motions to reject this method of statement as inadequate, and it is in fact incapable of giving a complete representation of the motions in question. In 1609 and 1619 Kepler published his new laws of planetary motion, which were subsequently shown by Newton to agree with the results obtained by experiment for the motion of terrestrial bodies.

The earliest recorded systematic experiments as to the motion of falling bodies were made by Galileo at Pisa in the latter years of the 16th century. Bodies of different substances were

employed, and slight differences in their behaviour accounted for by the resistance of the air. The result obtained was that any body allowed to fall from rest would, in a vacuum, move relatively to the earth with constant acceleration; that is to say, would move in a straight

line, in such a manner that its velocity would increase by equal amounts in any two equal times. This result is very nearly correct, the deviations being so small as to be almost beyond the reach of direct measurement. It has since been discovered, however, that the magnitude of the acceleration in question is not exactly the same at different places on the earth, the range of variation amounting to about $\frac{1}{2}$ %. Galileo proceeded to measure the motion of a body on a smooth, fixed, inclined plane, and found that the law of constant acceleration along the line of slope of the plane still held, the acceleration decreasing in magnitude as the angle of inclination was reduced; and he inferred that a body, moving on a smooth horizontal plane, would move with uniform velocity in a straight line if the resistance of the air, and friction due to contact with the plane, could be eliminated. He went on to deal with the case of projectiles, and was led to the conclusion that the motion in this case could be regarded as the result of superposing a horizontal motion with uniform velocity and a vertical motion with constant acceleration, the latter identical with that of a merely falling body; the inference being that the path of a projectile would be a parabola except for deviations attributed to contact with the air, and that in a vacuum this path would be accurately followed. The method of superposition of two motions may be illustrated by such examples as that of a body dropped from the mast of a ship moving at uniform speed. In this case it is found that the body falls relatively to the ship as if the latter were at rest, and alights at the foot of the mast, having consequently pursued a parabolic path relatively to the earth.

The importance of these results, limited though their scope was, can hardly be overrated. They had practically the effect of suggesting an entirely new view of the subject, namely, that a body uninfluenced by other matter might be expected to move, relatively to some base or other, with uniform velocity in a straight line; and that, when it does not move in this way, its acceleration is the feature of its motion which the surrounding conditions determine. The acceleration of a falling body is naturally attributed to the presence of the earth; and, though the body approaches the earth in the course of its fall, it is easily recognized that the conditions under which it moves are only very slightly affected by this approach. Moreover, Galileo recognized, to some extent at any rate, the principle of simple superposition of velocities and accelerations due to different sets of circumstances, when these are combined (see MECHANICS). The results thus obtained apply to the motion of a small body, the rotation of which is disregarded. When this case has been sufficiently studied, the motion of any system can be dealt with by regarding it as built up of small portions. Such portions, small enough for the position and motion of each to be sufficiently specified by those of a point, are called "particles."

Descartes helped to generalize and establish the notion of the fundamental character of uniform motion in a straight line, but otherwise his speculations did not point in the direction of sound progress in dynamics; and the next

Centrifugal Force.

substantial advance that was made in the principles of the subject was due to Huygens (1629-1695). He attained correct views as to the character of centrifugal force in connexion with Galileo's theory; and, when the fact of the variation of gravity (Galileo's acceleration) in different latitudes first became known from the results of pendulum experiments, he at once perceived the possibility of connecting such a variation with the fact of the earth's diurnal rotation relatively to the stars. He made experiments, simultaneously with Wallis and Wren, on the collision of hard spherical bodies, and his statement of the results (1666) included a clear enunciation of the conservation of linear momentum, as demonstrated for these cases of collision, and apparently correct in certain other cases, mass being estimated by weight. But Huygens's most important contribution to the

subject was his investigation, published in 1673, of the motion of a rigid pendulum of any form. This is the earliest example of a theoretical investigation of the rotation of rigid bodies. It involved the adoption of a point of view as to the relation between the motions of bodies of different forms, which practically amounted to a perception of the principle of energy as applied to the case in question.

We owe to Newton (1642-1727) the consolidation of the views which were current in his time into one coherent and universal system, sometimes called the Galileo-Newton theory, but commonly known as the "laws of motion"; and the demonstration of the fact that the motions of the celestial bodies could be included in this theory by means of the law of universal gravitation. A full account of his results was first published in the *Principia* in 1687.

Such statements as that a body moves in a straight line, and that it has a certain velocity, have no meaning unless the base, relative to which the motion is to be reckoned, is defined. Accordingly, in the extension of Galileo's results for the purpose of a universal theory, the establishment of a suitable base of reference is the first step to be taken. Newton assumed the possibility of choosing a base such that, relatively to it, the motion of any particle would have only such divergence from uniform velocity in a straight line as could be expressed by laws of acceleration dependent on its relation to other bodies. He used the term "absolute motion" for motion relative to such a base. Many writers on the subject distinguish such a base as "fixed." The name "Newtonian base" will be used in this article. Assuming such a base to exist, Newton admitted at the outset the difficulty of identifying it, but pointed out that the key to the situation might be found in the identification of forces; that is to say, in the mutual character of laws of acceleration as applied to any given body and any other by whose presence its motion is influenced. In this connexion he took an important step by distinguishing clearly the character of "mass" as a universal property of bodies distinct from weight.

There can be no doubt that the development of correct views as to mass was closely connected with the results of experiments with regard to the collision of hard bodies. Suppose two small smooth spherical bodies which can be regarded as particles to be brought into collision, so that the velocity of each, relative to any base which is unaffected by the collision, is suddenly changed. The additions of velocity which the two bodies receive respectively, relative to such a base, are in opposite directions, and if the bodies are alike their magnitudes are equal. If the bodies though of the same substance are of different sizes, the magnitudes of the additions of velocity are found to be inversely proportional to the volumes of the bodies. But if the bodies are of different substances, say one of iron and the other of gold, the ratio of these magnitudes is found to depend upon something else besides bulk. A given volume of gold is found to count for this purpose for about two and a half times as much as the same volume of iron. This is expressed by saying that the density of gold is about two and a half times that of iron. In fact, experiments upon the changes of velocity of bodies, due to a mutual influence between them, bring to light a property of bodies which may be specified by a quantity proportional to their volumes in the case of bodies which are perceived by other tests to be of one homogeneous substance, but otherwise involving also another factor.

The product of the volume and density of a body measures what is called its "mass." The mass of a body is often loosely defined as the measure of the quantity of matter in it. This definition correctly indicates that the mass of any portion of matter is equal to the sum of the masses of its parts, and that the masses of bodies alike in other respects are equal, but gives no test for comparison of the masses of bodies of different substances; this test is supplied only by a comparison of motions. When, as in the case of contact, a mutual relation is perceived between the motions of two particles, the changes of velocity are in opposite directions, and the ratio of their magnitudes determines the ratio of the masses of the particles; the motion being reckoned

relative to any base which is unaffected by the change. It is found that this gives a consistent result; that is to say, if by an experiment with two particles A and B we get the ratio of their masses, and by an experiment with B and a third particle C we get the ratio of the masses of B and C, and thus the ratio of the masses of A and C, we should get the same ratio by a direct experiment with A and C. For the numerical measure of mass that of some standard body is chosen as a unit, and the masses of other bodies are obtained by comparison with this. Masses of terrestrial bodies are generally compared by weighing; this is found by experiment to give a correct result, but it is applicable only in the neighbourhood of the earth. Familiar cases can readily be found of the perception of the mass of bodies, independently of their tendency to fall towards the earth. The mass of any portion of matter is found to be permanent under chemical and other changes, and this fact adds to its importance as a physical quantity. The study of the structure of atoms has suggested a connexion of mass with electrical phenomena which implies its dependence on motion; but this is not inconsistent with the observed fact of its practical constancy, to a high degree of accuracy, for bodies composed of atoms.

The Galileo-Newton theory of motion is that, relative to a suitably chosen base, and with suitable assignments of mass, all accelerations of particles are made up of mutual (so-called) actions between pairs of particles, whereby the two particles forming a pair have accelerations in opposite directions in the line joining them, of magnitudes inversely proportional to their masses. The total acceleration of any particle is that obtained by the superposition of the component accelerations derived from its association with the other particles of the system severally in accordance with this law. The mutual action between two particles is specified by means of a directed quantity to which the term "force" is appropriated. A force is said to act upon each of two particles forming a pair, its magnitude being the product of mass and component acceleration of the particle on which it acts, and its direction that of this component acceleration. Thus each mutual action is associated with a pair of equal forces in opposite directions. Instead of the operation of superposing accelerations, we may compound the several forces acting on a particle by the parallelogram law (see MECHANICS) into what may be called the resultant force, the total acceleration of the particle being the same as if this alone acted. The theory depends for its verification and application upon the fact that forces can be identified and classified. They can be recognized by their reciprocal character, and it is found to be possible to connect them by permanent laws with the recognizable physical characteristics of the systems in which they occur. A generalization of Galileo's results takes the form that under constant conditions of this kind, force (defined in terms of motion) is constant, and that the superposition of two sets of conditions, if their independence can be secured, results in superposition of the forces associated with them separately. Particular laws of force may be suggested by a study of the simplest cases in which they are manifested, and from them results may be obtained by calculation as to the motions of systems of any given structure. Such results may be tested by direct observation.

It should be noted that, within a limited range of application to terrestrial mechanics, the most convenient way of attacking the question of the relations of forces to the physical conditions of their occurrence may be by the branch *Statics*, their several effects in producing motion; thus avoiding in the first instance both the choice of a base and the consideration of mass. This procedure is useful as a preliminary step in the study of the subject. It does not, however, afford a convenient starting-point for a general theory, because it is apt to involve some confusion of phenomena which, from the point of view of the Galileo-Newton theory, are distinct in character.

Newton's law of gravitation affords the most notable example of the process of verification of a law of force, and incidentally of the Galileo-Newton theory. As a law of acceleration of the planets relatively to the sun, its approximate agreement with

Kepler's third law of planetary motion follows readily from a consideration of the character of the acceleration of a point moving uniformly in a circle. Newton tells us that this agreement led him to adopt the law of the inverse square of the distance about 1665-1666, before Huygens's results as to circular motion had been published. At the same time he thought of the possibility of terrestrial gravity extending to the moon, and made a calculation with regard to it. Some years later he succeeded in showing that Kepler's elliptic orbit for planetary motion agreed with the assumed law of attraction; he also completed the co-ordination with terrestrial gravity by his investigation of the attractions of homogeneous spherical bodies. Finally, he made substantial progress with more exact calculations of the motions of the solar system, especially for the case of the moon. The work of translating the law of gravitation into the form of astronomical tables, and the comparison of these with observations, has been in progress ever since. The discovery of Neptune (1846), due to the influence of this planet on the motion of Uranus, may be mentioned as its most dramatic achievement. The verification is sufficiently exact to establish the law of gravitation, as providing a statement of the motions of the bodies composing the solar system which is correct to a high degree of accuracy. In the meantime some confirmation of the law has been obtained from terrestrial experiments, and observations of double stars tend to indicate for it a wider if not universal range. It should be noticed that the verification was begun without any data as to the masses of the celestial bodies, these being selected and adjusted to fit the observations.

The case of electro-magnetic forces between two conductors carrying electric currents affords an example of a statement of motion in terms of force of a highly artificial kind. It can only be contrived by means of complicated mathematical analysis. In this connexion a statement in terms of force is apt to be displaced by more direct and more comprehensive methods, and the attention of physicists is directed to the intervention of the ether. The study of such cases suggests that the statement in terms of force of the relations between the motions of bodies may be only a provisional one, which, though it may summarize the effect of the actual connexions between them sufficiently for some practical purposes, is not to be regarded as representing them completely. There are indications of this having been Newton's own view.

The Newtonian base deserves some further consideration. It is defined by the property that relative to it all accelerations of particles correspond to forces. This test involves only changes of velocity, and so does not distinguish between two bases, each of which moves relatively to the other with uniform velocity without rotation. The establishment of a true Newtonian base presumes knowledge of the motions of all bodies. But practically we are always dealing with limited systems, so any actual determination must always be regarded as to some extent provisional. In the treatment of the relative motions of a limited system, we may use a confessedly provisional base, though it may be necessary to introduce corrections, either exact or approximate, to take account either of the existence of bodies outside the system, or of the rotation of the base employed relative to a more correct one. Such corrections may be made by the device of applying additional unpaired, or what we may call external, forces to particles of the system. These are needed only so far as they introduce differences of accelerations of the several particles. The earth, which is commonly employed as a base for terrestrial motions, is not a very close approximation to being a Newtonian base. Differences of acceleration due to the attractions of the sun and moon are not important for terrestrial systems on a small scale, and can usually be ignored, but their effect (in combination with the rotation of the earth) is very apparent in the case of the ocean tides. A more considerable defect is due to the earth having a diurnal rotation relative to a Newtonian base, and this is never wholly ignored. Take a base attached to the centre of the earth, but without this diurnal rotation. A small body hanging by a string, at rest relatively to the earth, moves relatively to this

base uniformly in a circle; that is to say, with constant acceleration directed towards the earth's axis. What is done is to divide the resultant force due to gravitation into two components, one of which corresponds to this acceleration, while the other one is what is called the "weight" of the body. Weight is in fact not purely a combination of forces, in the sense in which that term is defined in connexion with the laws of motion, but corresponds to the Galileo acceleration with which the body would begin to move relatively to the earth if the string were cut. Another way of stating the same thing is to say that we introduce, as a correction for the earth's rotation, a force called "centrifugal force," which combined with gravitation gives the weight of the body. It is not, however, a true force in the sense of corresponding to any mutual relation between two portions of matter. The effect of centrifugal force at the equator is to make the weight of a body there about 35% less than the value it would have if due to gravitation alone. This represents about two-thirds of the total variation of Galileo's acceleration between the equator and the poles, the balance being due to the ellipticity of the figure of the earth. In the case of a body moving relatively to the earth, the introduction of centrifugal force only partially corrects the effect of the earth's rotation. Newton called attention to the fact that a falling body moves in a curve, diverging slightly from the plumb-line vertical. The divergence in a fall of 100 ft. in the latitude of Greenwich is about $\frac{1}{4}$ in. Foucault's pendulum is another example of motion relative to the earth which exhibits the fact that the earth is not a Newtonian base.

For the study of the relative motions of the solar system, a provisional base established for that system by itself, bodies outside it being disregarded, is a very good one. No correction for any defect in it has been found necessary; moreover, no rotation of the base relative to the directions of the stars without proper motion has been detected. This is not inconsistent with the law of gravitation, for such estimates as have been made of planetary perturbations due to stars give results which are insignificant in comparison with quantities at present measurable.

For the measurement of motion it must be presumed that we have a method of measuring time. The question of the standard to be employed for the scientific measurement of **Measurement of Time.** time accordingly demands attention. A definition of the measurement dependent on dynamical theory has been a characteristic of the subject as presented by some writers, and may possibly be justifiable; but it is neither necessary nor in accordance with the historical development of science. Galileo measured time for the purpose of his experiments by the flow of water through a small hole under approximately constant conditions, which was of course a very old method. He had, however, some years before, when he was a medical student, noticed the apparent regularity of successive swings of a pendulum, and devised an instrument for measuring, by means of a pendulum, such short periods of time as sufficed for testing the pulse of a patient. The use of the pendulum clock in its present form appears to date from the construction of such a clock by Huygens in 1657. Newton dealt with the question at the beginning of the *Principia*, distinguishing what he called "absolute time" from such measures of time as would be afforded by any particular examples of motion; but he did not give any clear definition. The selection of a standard may be regarded as a matter of arbitrary choice; that is to say, it would be possible to use any continuous time-measurer, and to adapt all scientific results to it. It is of the utmost importance, however, to make, if possible, such a choice of a standard as shall render it unnecessary to date all results which have any relation to time. Such a choice is practically made. It can be put into the form of a definition by saying that two periods of time are equal in which two physical operations, of whatever character, take place, which are identical in all respects except as regards lapse of time. The validity of this definition depends on the assumption that operations of different kinds all agree in giving the same measure of time, such allowances as experience dictates being made for changing conditions. This assumption has successfully stood all

tests to which it has been subjected. All clocks are constructed on the basis of this method of measurement; that is to say, on the plan of counting the repetitions of some operation, adopted solely on the ground of its being capable of continual repetition with a certain degree of accuracy, and possibly also of automatic compensation for changing conditions. Practically clocks are regulated by reference to the diurnal rotation of the earth relatively to the stars, which affords a measurement on the repetition principle agreeing with other methods, but more accurate than that given by any existing clock. We have, however, good reasons for regarding it as not absolutely perfect, and there are some astronomical data the tendency of which is to confirm this view.

The most important extension of the principles of the subject since Newton's time is to be found in the development of the theory of energy, the chief value of which lies in the fact that it has supplied a measurable link connecting the motions of systems, the structure of which can be directly observed, with physical and chemical phenomena having to do with motions which cannot be similarly traced in detail. The importance of a study of the changes of the *vis viva* depending on squares of velocities, or what is now called the "kinetic energy" of a system, was recognized in Newton's time, especially by Leibnitz; and it was perceived (at any rate for special cases) that an increase in this quantity in the course of any motion of the system was otherwise expressible by what we now call the "work" done by the forces. The mathematical treatment of the subject from this point of view by Lagrange (1736-1813) and others has afforded the most important forms of statement of the theory of the motion of a system that are available for practical use. But it is to the physicists of the 19th century, and especially to Joule, whose experimental results were published in 1843-1849, that we practically owe the most notable advance that has been made in the development of the subject—namely, the establishment of the principle of the conservation of energy (see ENERGETICS and ENERGY). The energy of a system is the measure of its capacity for doing work, on the assumption of suitable connexions with other systems. When the motion of a body is checked by a spring, its kinetic energy being destroyed, the spring, if perfectly elastic, is capable of restoring the motion; but if it is checked by friction no such restoration can be immediately effected. It has, however, been shown that, just as the compressed spring has a capacity for doing work by virtue of its configuration, so in the case of the friction there is a physical effect produced—namely, the raising of the temperature of the bodies in contact, which is the mark of a capacity for doing the same amount of work. Electrical and chemical effects afford similar examples. Here we get the link with physics and chemistry alluded to above, which is obtained by the recognition of new forms of energy, interchangeable with what may be called mechanical energy, or that associated with sensible motions and changes of configuration.

Such general statements of the theory of motion as that of Lagrange, while releasing us from the rather narrow and strained view of the subject presented by detailed analysis of motion in terms of force, have also suggested a search for other forms which a statement of elementary principles might equally take as the foundation of a logical scheme. In this connexion the interesting scheme formulated by Hertz (1894) deserves notice. It is important as an addition to the logic of the subject rather than on account of any practical advantages which it affords for purposes of calculation.

AUTHORITIES.—Galileo, *Dialogues* (translations: "The System of the World" and "Mechanics and Local Motion," in T. Salusbury's *Mathematical Collections and Translations* (1661-1665); *Mechanics and Local Motion*, by T. Weston (1730); Huygens, *Horologium Oscillatorium* (1673); Newton, *Philosophiæ naturalis principia mathematica* (1687; translation by A. Motte, 1729); W. W. Rouse Ball, *An Essay on Newton's Principia* (1893); Whewell, *History of the Inductive Sciences* (1837); J. Clerk Maxwell, *Matter and Motion* (1882); H. Streintz, *Die physikalischen Grundlagen der Mechanik* (1883); E. Mach, *Die Mechanik in ihrer Entwicklung historisch-kritisch dargestellt* (1883; 2d edition (1889 translation) by T. J. McCormack, 1893); K. Pearson, *The Grammar of Science* (1892);

A. E. H. Love, *Theoretical Mechanics* (1897). H. Hertz, *Die Prinzipien der Mechanik* (1894, translation by Jones and Walley 1909). (W. H. M.)

MOTIVE (from Lat. *movere*, to move), in psychology, a general term signifying any element of consciousness which prompts an agent to a decision. The older psychology usually regarded motives as strictly analogous to mechanical forces exerting pressure or tension, and explained human action as necessarily determined by the resultant of various, possibly conflicting, motives. Contemporary psychological research tends to show with increasing clearness that we must recognize a power of decision in the self, and that the analogy of mechanical forces is inadequate to explain the facts. On this view motives will be regarded as solicitations to act in a certain direction, while the self decides by throwing its volitional weight on the side of the motive which it regards as preferable. The solicitations may come from the most diverse sources: they may be mere desires to avoid some pain or to gratify some appetite; or they may be of higher origin, such as the motive of patriotism, or the desire to advance knowledge. Purposes or ends are often termed motives. "Conflict of motives" means sometimes a conflict of purposes, when the agent has adopted two different lines of action and has difficulty in combining them; or it may mean a conflict of solicitations. It is better to call purposes or ends by those names when they have been definitely adopted by the agent: while they are still under deliberation the term "motive" may be used.

MOTLEY, JOHN LOTHROP (1814-1877), American historian, son of Thomas Motley, was born on the 15th of April 1814 at Dorchester (now a part of Boston), Massachusetts, and graduated at Harvard in 1831. He then studied at Göttingen and Berlin, becoming a friend of Bismarck at Göttingen, and after a period of European travel returned in 1834 to America, where he continued his legal studies. In 1837 he married Mary Benjamin (d. 1874), a sister of Park Benjamin, and in 1839 he published anonymously a novel entitled *Morton's Hope, or the Memoirs of a Provincial*. In 1841 he entered the diplomatic service as secretary of legation in Russia, but resigned his post within three months. Returning to America, he soon entered definitely upon a literary career. Besides contributing various historical and critical essays to the *North American Review*, including a remarkable essay on the *Polity of the Puritans*, he published in 1849, again anonymously, a second novel, entitled *Merry Mount, a Romance of the Massachusetts Colony*. About 1846 the project of writing a history of Holland had begun to take shape in his mind, and he had already done a large amount of work on this subject when, finding the materials at his disposal in the United States inadequate, he went to Europe in 1851. The next five years were spent at Dresden, Brussels and the Hague in investigation of the archives, which resulted in 1856 in the publication of *The Rise of the Dutch Republic*, which became very popular. It speedily passed through many editions, was translated into French, and also into Dutch, German and Russian. In 1860 Motley published the first two volumes of its continuation, *The United Netherlands*. This work was on a larger scale, and embodied the results of a still greater amount of original research. It was brought down to the truce of 1609 by two additional volumes, published in 1867. In 1861, just after the Civil War had broken out in America, Motley wrote two letters to *The Times* defending the Federal position, and these letters, afterwards reprinted as a pamphlet entitled *Causes of the Civil War in America*, made a favourable impression on President Lincoln. Partly owing to this essay, Motley was appointed United States minister to Austria in 1861, a position which he filled with great success until his resignation in 1867. Two years later he was sent to represent his country in London, but in November 1870 he was recalled by President Grant. After a short visit to Holland, he again took up his residence in England, where the *Life and Death of John Barneveld* appeared in two volumes in 1874. Ill health now began to interfere with his literary work, and he died at Frampton Court, near Dorchester, Dorset, on the 29th of May 1877, leaving three daughters. The merits of Motley as an historian are undeniably great. He has

told the story of a stirring period in the history of the world with full attention to the character of the actors and strict fidelity to the vivid details of the action. But it may safely be said that his tale is best where most unvarnished, and probably no writer of the same rank has owed less to the mere sparkle of highly polished literary style.

An excellent edition of his historical works was published in nine volumes in London in 1903-1904. See the *Correspondence of John Lathrop Motley*, edited by G. W. Curtis (New York, 1889); O. W. Holmes, *John Lathrop Motley, a Memoir* (Boston, 1878); M. D. Conway, *Biographical Introduction to The Rise of the Dutch Republic* (London, 1896); and *John Lathrop Motley and his Family: Further Letters and Records* (1910), edited by his daughter, Mrs Susan St John Mildmay.

MOTLEY, *i.e.* of many colours, a term particularly used of the parti-coloured dress of the professional "fool" (*q.v.*) of the middle and later ages. The origin of the word is probably to be found in "mote" (O. Eng. *mot*), a particle of dust, &c., hence a spot or patch. "Mottle," a blotch or spot, is probably a back formation of motley.

MOTMOT. According to Hernandez in his *Historia avium Novae Hispaniae* (p. 52), published at Rome in 1651, this is the Mexican name of a bird which he described well enough to leave no doubt as to what he meant; but the word being soon after printed *Momot* by Nieremberg and others gave rise to the Latinized *Momotus*, invented by M. J. Brisson as a generic term, which has since been generally adopted by ornithologists, though motmot has been retained as the English form. Linnaeus knew of only one species of motmot, and referred it to his genus *Ramphastos* (properly *Rhamphastos*) under the name of *R. momota*. This is the *Momotus brasiliensis* of modern ornithologists, and from its geographical range cannot be the original *Momot* of Hernandez, but is most likely the "*Gaira guainumbi*" of Margrave.

The motmots form the sub-family *Momotidae*, which with the *Todinae* (see *TODY*) form the family *Momotidae* of Coraciiform birds, the nearest allies being rollers (*q.v.*) and kingfishers (*q.v.*). In outward appearance the motmots have an undoubted resemblance to bee-eaters, but, though beautiful birds, various shades of blue and green predominating in their plumage, they do not exhibit such decided and brilliant colours; and, while the bee-eaters are only found in the Old World, the motmots are a purely Neotropical form, extending from southern Mexico to Paraguay, and the majority of species inhabit Central America. Their ordinary food is small reptiles and fruits, and insects caught on the wing. The nest of one species, as observed by Robert Owen, is at the end of a hole bored in the bank of a watercourse, and the eggs are pure white and glossy (*Ibis*, 1861, p. 65). Little else has been recorded of their ways.

The *Momotidae* form but a small group, containing about six genera, of which the best known are: *Momotus*, *Baryphthengus*, *Hylomanes*, *Eumomota*, *Aspatha* and *Prionorhynchus*, and the number of species is very small. While all have a general resemblance in the serrated edges of the bill and many other characters, *Momotus* has the normal number of twelve rectrices, while the rest have only ten, which in *Hylomanes* have the ordinary configuration, but in adult examples of all the others the shaft of the median pair is devoid of barbs for the space of about an inch a little above the extremity, so as to produce a spatulate appearance, such as is afforded by certain humming-birds known as "raquet-tails" (see *HUMMING-BIRD*), kingfishers of the genus *Tonyisiptera* (see *KINGFISHER*), and parrots of the group *Prioniturus*. C. Waterton (*Wanderings*, Journey 2, chap. iii.), mentioning the species *M. brasiliensis* by its native name "houtou," long ago asserted that this peculiarity was produced by the motmot itself nibbling off the barbs, and this extraordinary statement, though for a while doubted, has since been shown by O. Salvin (*Proc. Zool. Society*, 1873, pp. 429-433), on A. Bartlett's authority, to be perfectly true. (A. N.)

MOTORS, ELECTRIC. Fundamentally, electric motors are electric generators reversed in function: they convert into mechanical energy the continued stresses between two electro-

magnetic fields relatively movable, just as generators convert into electromagnetic stresses the mechanical energy applied to them. Since no transformation of energy is ever absolutely quantitative, the conversions just considered are not accomplished without loss of energy to about the same extent in both cases. The sources of this loss are ohmic loss in the conductors, hysteresis, friction of bearings and brushes, air friction and eddy currents; the sum of these losses in large modern machines does not exceed 5 or 6%. The torque of the motor is the dynamical result of the electromagnetic stresses between the magnetic field of the motor and that due to the armature currents, the latter field being proportional to the strength of the current sheet due to the numerical strength of the current and the number of its effective convolutions. This applies to all types of motors, if one remembers that whenever either of these two stress factors is a periodic variable, as in the case of alternating motors, the torque is proportional to their geometrical co-directed product and not merely to their numerical product. At this point it will be convenient to distinguish between the various types of motors. The first broad distinction is between continuous-current and alternating-current motors, a distinction rather of convenience than of necessity, for in point of fact the two depend upon the same broad principles and can be considered on precisely the same lines.

Electric motors may be conveniently divided as follows:—

(A) *Continuous Current.*

1. Separately excited.
2. Series-wound constant current.
3. Series-wound constant potential.
4. Series-wound interdependent current and potential.
5. Shunt-wound constant potential.

(B) *Alternating Current.*

1. Synchronous constant potential.
2. Induction-polyphase constant potential.
3. Induction-monophasic constant potential.
4. Repulsion-commutating.
5. Series-commutating.

Of these, the series-wound constant current, shunt-wound constant potential, and polyphase induction motors do a very large proportion of the active work of power transmission: the first mentioned furnish power for electric railways; the second chiefly power distribution from public electric supply stations; while the third are mainly relied upon in long-distance transmission systems. The fourth and fifth groups of class (B) are old in principle but have been slow in practical development. They include many modifications and transition forms not involving radical changes in the principles or properties of the machines. Their chief use has been for electrical traction, with reference to which they have, in the main, been developed, and their performance is best at low frequency, 15 to 25 cycles per second.

In class (A) in general, for a certain value of the torque current must be forced through the armature against the motor electromotive force which results from the rotation of the armature in a given field. This demands a certain greater applied electromotive force to produce the current required, which is determined by the effective electromotive force, equal to the geometrical difference between the applied and motor electromotive forces, and by the impedance of the armature. For steady currents this last is of course the same as the ohmic resistance, just as for steady electromotive force the geometrical and the numerical difference of the applied and motor electromotive forces are coincident. The torque depends, as heretofore noted, on the field strength and the strength of the current sheet due to the current thus determined. For small values of the torque the speed practically depends upon the applied electromotive force and the field, so that if the former and the latter be constant the speed is also sensibly constant. This is likewise the case if the armature resistance be very small; and in general the variations of speed at constant potential are determined by the product of this resistance and the torque, while the absolute speed depends essentially upon the field strength. Motors for low speed or high

electromotive force must have both a strong field and many turns upon the armature, so that both the fundamental stresses may be large. As the field is generally strong—to secure economy of iron—low-voltage and high-voltage machines differ principally in the number of armature turns. For variable speed, this latter factor being fixed, field strength and applied electromotive force are the factors easily altered, and most of the speed variation is accomplished by changing one or both of them. Torque, neglecting field distortion, is at a maximum when the current is the greatest possible at the given applied voltage—that is, when the motor is at rest. With a small armature resistance this current is generally far too great for convenience; hence the motors are usually started with a rheostat in series with the winding if the current is not limited by the generator itself. The torque then depends on the sum of the resistances in circuit, and can be made just sufficient to start the motor under the required load. By the same device the motor can run at reduced speed, although with a considerable loss of energy in the rheostat; it is indeed, as a rule, difficult to get effective speed variation in motors of any kind without serious loss of energy. The field can be changed within wide limits only by a considerable increase of the iron in the magnetic circuit, the applied electromotive force cannot usually be varied except by increasing the resistances in circuit, and the number of armature turns cannot be varied without complication, although the effective number can be modified by shifting the brushes, probably at the expense of sparking. Altogether, if the speed variation demanded be more than 15 or 20%, it causes, in one way or another, considerable expense and trouble, particularly if each speed must be closely held irrespective of load. No large change in absolute speed can readily be made without considerable change in the percentage variation of speeds at various loads. Practically, the best results are obtained from motors of very low armature resistance, in which the field or the applied electromotive force, or both, are varied. The whole problem is nearly identical with the production of constant potential or constant current from generators driven at constant speed, and is solved by similar means. For any one absolute speed a generator can be made to give constant potential, nearly irrespective of load, by compound winding. Similarly, a motor may give a very nearly constant speed at constant potential by a differential winding in series with the armature, weakening the field as the armature current rises. This device, however, obviously increases the energy required for magnetization, and decreases the effective torque at starting. Practically, the best continuous-current motors can be made to hold their speed to within 1 or 2% from no load to full load. Commercial machines, however, generally vary from 5 to 10% in speed. With respect to the direction or rotation of a motor, the torque changes sign with a change of sign in either field or armature current, but not with a change of sign in both. The input of the motor is numerically equal to the product of the current and the applied electromotive force, while the output is determined by the product of the current and motor electromotive force; hence the efficiency of the motor as a transformer of energy is the ratio between these two quantities. The output is a maximum when the applied electromotive force is double the motor electromotive force, and the efficiency is a maximum when the motor and applied electromotive forces are substantially equal. At the point of maximum output the speed is that sufficient to reduce the current to one-half its static value. No motor is worked at or near this point, except momentarily, on account of the low efficiency and severe heating in the armature. These theoretical values are slightly modified in practical machines by the small miscellaneous losses subject to independent variations.

The practical output of electric motors is limited in machines of normal design by the temperature they can safely endure. As a rule the working temperature, which is commonly reached only after six hours or more of continuous running, should not rise more than 40° to 50° F. above the temperature of the surrounding air. In case of traction motors and others subjected to occasional severe overloads, separated by periods of rest or of subnormal load, the temporary rise of temperature tolerated may be much

higher, say 60° to 75° F., after a run of an hour or so. The temperature of the air is assumed at 70° F. in most cases, and the temperature of the motor-windings is preferably ascertained by the rise in electrical resistance due to the heating. Thermometers can seldom be so applied as to measure the full heating effect.

The actual output obtainable from a motor structure of given dimensions under these conditions with respect to heating depends chiefly upon the practicable rotative speed of the armature, since the chief losses are proportional to the torque, while the mechanical output at given torque is approximately proportional to the speed. Most makers utilize a single structure for several standard motors varying in speed and output, a 15 h.p. machine at, say, 1200 r.p.m. becoming a 10 h.p. at 800 r.p.m. or a 20 h.p. at 1600 r.p.m. There is no practically fixed relation between the rating and the speed, although it is approximately linear, for in winding the same carcass for different speeds the ratings are settled rather by commercial convenience than by exact determinations. Motors generally have approximately the same efficiencies as the corresponding sizes of generators. Small motors, say from 1 to 5 h.p., are commonly of 70–80% efficiency at full load, medium sized machines of 5 to 50 h.p. about 80 to 90%, and the larger sizes run up to 95% or thereabouts. In the effort to get low-speed motors without immoderately increasing the cost they are generally dropped a little in efficiency and allowed to run hotter than if wound for higher speeds.

The weight of motors per h.p. of output is therefore very variable. In machines of medium size and speed it is likely to be 50 to 75 lb per h.p., falling to 30 or 40 in large or specially high speed machines, and rising to 80 or 100 lb in small or very low speed motors. High-voltage motors, particularly if small, lose somewhat in relative output on account of the space taken up by the necessary insulation.

In all ordinary motors the magnetization of the iron is, for economy of material, pushed high; and hence the field, even at heavy loads, is fairly stable and the conditions of commutation remain good. When, however, motors are designed to stand severe overloads, or to admit of a wide range of speed regulation by varying the field strength, the commutation is likely to be unstable, and severe sparking may result. To meet this condition the commutating-pole motor—really a recrudescence of an old idea—has been introduced on a considerable scale. In this construction auxiliary pole pieces, excited by series coils from the motor circuit, are set midway between the ordinary field poles. The office of these poles is to neutralize the magnetomotive force due to the armature winding, thus checking field distortion, and also to ensure the proper reversal of the current in the armature coil directly under the brush. Of the total magneto-motive force due to the windings of the commutating pole, the major part, perhaps three-fourths, is devoted to the former work and the remainder to the latter, the proportion varying widely according to the design of the motor. The result of this construction is excellent, sparkless commutation being ensured over a wide range of load and field strength. The commutating-pole motor is intrinsically more expensive and slightly less efficient than the ordinary type, but for the particular kind of service it is designed to perform is extremely effective. It gives promise of special value in high-voltage traction motors.

(A) 1. *Separately excited Motors* are interesting principally on account of the very efficient method of speed regulation possible by their use. In this method the field of the motor is excited from the supply mains, and the armature current is furnished by a motor-generator running at constant speed. A rheostat in the shunt field of the latter element enables the applied electromotive force to be varied to any desired extent, and hence the working motor can be given full torque at any speed up to that assigned by the maximum value of the electromotive force which can be applied to the armature. Moreover, if the armature resistance be small, the motor is fairly self-regulating at all speeds. The effect is rather startling, since the motor may be giving a very great torque when it is merely turning over at a few revolutions per minute; and although the process is complicated, it leads to excellent results, and is widely used where delicate speed regulation is required.

(A) 2. *Series-wound Constant-current Motors* were early worked to a considerable extent on arc-lights circuits, but have now passed out of use save in a small number of constant-current power-transmission systems on the continent of Europe. In these motors the motor electromotive force is directly proportional to the output, the torque being constant. They will not start with more than a certain definite load, but once started the speed will increase until the work (in fact, the external) balances the torque. They are, intrinsically bad in speed regulation, and must be treated by the same methods as are adopted to secure constant current in arc machines. The most successful device in most cases is to vary the field strength by shunting the field coils or to vary the number of effective armature conductors by shifting the brushes. Both methods are carried out mechanically rather than by purely electrical means—in the first case by an automatic rheostat, and in the second by an automatic brush shifter, but neither is wholly satisfactory. Nevertheless, such motors have proved capable of excellent commercial service in some of the European plants, especially in the larger sizes.

(A) 3. *Series-wound Constant-potential Motors* comprise nearly all motors used for electric traction—aggregating not less, probably, than one and a half million horse-power; hence they are of great practical importance. These traction motors are usually highly specialized machines with very powerful armatures and fields strongly saturated at all working values of the current. The brushes have an invariable position. Such motors behave much like separately-excited motors, having a rather large armature resistance. Speed regulation has to be obtained by varying the applied electromotive force in the armature circuit, by means of a rheostat. The use of an inserting rheostat; in modern practice it is customary to employ two, or even four, identical motors on each car, operated in series for low speeds and in parallel for full speed. In practice, however, resistances are inserted when necessary, to prevent too sudden changes of speed and to secure intermediate steps between those obtained by the series-parallel connexions. In rare instances a still further variation is secured by the use of a field only partially saturated at ordinary loads.

(A) 4. *Series-wound Motors with Interdependent Current and Potential* are used only in connection with generators of this design, motor and generator forming a dynamical unit. This system is occasionally used with good results in power transmission. Assuming the motor field to be saturated, if the speed is to be constant the applied electromotive force must rise with the load to an amount depending on the resistances in circuit. If the corresponding generator has a field less fully saturated, the increase in current demanded by the increment of torque in the motor can be made not only to raise the applied electromotive force enough to compensate for armature resistance, but for the total resistances in circuit, including the line. With this condition in operation, the motor will naturally maintain constant speed. The fields of the machines need not be designed for a given saturation, since shunting them with a suitable resistance will give the same result.

(A) 5. *Shunt-wound Motors at Constant Potential* are the mainstay of continuous-current distributions for industrial purposes. At constant potential the field remains sensibly constant and the torque is directly proportional to the current. The motor then behaves much like a separately-excited motor, and the armature resistance being generally very small, the speed is very nearly constant, varying less than 1% from no load to full load in the best commercial machines. Operating on a compound-wound generator, a single motor of this type can be made to regulate with great precision, as in the previous case. If the motor field be only moderately saturated, its strength, and hence the motor electromotive force, rises and falls with the applied electromotive force; and therefore at constant load these motors run at a very nearly constant speed, in spite of small variations of voltage. If speed variation be required, it can be obtained to a moderate extent by a rheostat in the field circuit. At starting a rheostat is necessary in the armature circuit. The differentially wound modification is now seldom used.

(B) 1. *Synchronous Alternating-current Motors*.—The simplest starting point in the consideration of this class is the continuous-current generator. This machine actually generates within the armature alternating currents; and if the commutator be replaced by two or more slip-rings connected symmetrically to two or more points on the armature winding, alternating currents, monophasic or polyphasic, according to the number of connexions and the points touched, can be withdrawn therefrom. The simplest case involves only two slip-rings, from no load to the winding diametrically opposite poles. Consider two such modified machines as motor and generator. The condition of complete reversibility is that the instantaneous values of the currents, and the instantaneous values of the angular displacements between poles and armature coils, shall be equal throughout. This evidently requires that the rotation of the motor should be synchronous, pole for pole, with that of the generator. Here, as before, the torque depends on the two fundamental stresses, but the torque has no determinate sign in the absence of an initial rotation. The instantaneous value of the torque depends on the instantaneous value of the current and on its angular displacement. The speed of the motor being invariably its motor electromotive force depends only on the effective excitation, including

the armature reactions, and it may or may not, according to the conditions of load, be in phase with the impressed electromotive force. In the case of the continuous-current motor, the motor output is numerically equal to the product of current and motor electromotive force; and since, in the alternating circuit, these quantities are usually not in phase, in alternating motors the activity is determined by the co-directed part of their product. The torque, therefore, does not depend merely on the ohmic resistance alone, but upon the impedance and upon the geometrical difference between the applied and motor electromotive forces. At a given applied electromotive force, and an armature impedance assumed constant, the fundamental variables in the motor are the output, motor electromotive force, and motor current. The two last factors are interdependent, so that the current may have a wide range of values, according to the excitation, while the output remains constant, or, itself remaining constant, may cover a variety of values of the power corresponding to different excitations. These changes involve changes in the phase angle when the motor electromotive force and the current, so that at given output the power-factor of the motor—that is, the ratio between the numerical and geometrical products of current and electromotive force—may be given various values at will by changing the field excitation of the motor, a most unique and valuable property. If the motor electromotive force be fixed and the output varied, the phase angle between current and motor electromotive force varies by reason of the armature taking up a new angular position with respect to the field, backward for increasing load, forward for decreasing load. The position of the armature with respect to the field is reached when the excitation is such that the applied electromotive force and current are in phase, at which point the real and the apparent energy in the circuit coincide. The input can then be accurately measured by voltmeter and ammeter readings, and the motor is working at its best efficiency for the given load. For greater values of the motor electromotive force the current leads in phase with respect to the applied electromotive force; for less values it lags. The former condition is accompanied by the rising of the electromotive force at the motor terminals, the latter by its fall. It therefore becomes possible to use a synchronous motor as the necessary current due to the load be not too great, as a voltage and phase regulator in an alternating circuit, a function very valuable in power-transmission work. If the excitation be set to produce leading phase at small loads, the phase angle will gradually diminish as the load rises, and then, passing through zero, increase again with the lagging current, thus holding the power-factor near to unity at all working loads. In a well-designed synchronous motor, by proper initial adjustment of the field, the power-factor can easily be kept between 0.95 and 1.0 from quarter load to full load, and very close to unity at no load. The main advantage of this system is that the motor, independently, the synchronous motor is a highly desirable addition to a transmission system. Starting is generally accomplished by the help of an induction motor or other auxiliary power, and the motor is treated exactly like an alternator, to be thrown in parallel with the supply circuit. A synchronous motor will pull itself up to synchronism if brought near to its synchronous speed, but this requires a very large amount of current. Operating from a generator of its own, it can be brought to speed by giving it a small initial rotation and raising the generator speed very carefully and gradually until the two machines will accelerate to synchronism. Polyphasic synchronous motors obey these same general laws; they, however, be started as quasi-induction motors with an open field circuit, the pole faces serving as secondary conductors, but require so large currents in thus starting themselves that it is better practice to bring them to speed by extraneous means.

Synchronous motors sometimes cause serious trouble by "pumping," a phenomenon closely allied to the surging of current between alternators in parallel, and due to similar causes. If not due to defective winding of the prime mover, it usually starts with a change of load or of phase, producing fluctuating motor electromotive force in the system great enough to interfere seriously with incandescent lighting, and continuing with nearly uniform amplitude and frequency for hours if unchecked. The amplitude varies with the conditions, but in the same machine the frequency is nearly constant. The fluctuation affects both the armature and the field circuits, the latter inductively by changes in the armature magnetomotive force, but it can as a rule be controlled by varying the excitation until a neutral point is found, usually when the phase angle is near to zero. Motors with solid pole pieces give little trouble of this sort, the oscillations being rapidly damped by the eddy currents. In motors with laminated fields the most effective remedy is chattering away the edges of the pole pieces so as to admit heavy copper shoes running along and under the edges, and even bridging the spaces between the pole pieces. The eddy currents in these shoes completely check the "pumping."

Synchronous and other Converters.—It seems here appropriate to refer to these converting devices, not in their general functions, but merely in so far as they are directly related to motor practice. The synchronous converter proper is in effect a synchronous motor, in spite of its commutating armature winding, and the direction of its current is dependent on the alternating current voltage of supply, the converter cannot advantageously be used to control

the power factor by variation of the field strength, but the field can be adjusted once for all to hold the power factor reasonably near unity, provided independent means are available for so adjusting the applied alternating voltage as to give the required result at the commutator. If close regulation of the direct-current voltage is not demanded the converter field can be used more freely. As a matter of fact the synchronous converter finds its chief use in electric traction, where close regulation of the current and voltage of the generators in one form or another have been found more suitable for electric-lighting work. The synchronous converters have the liability to "pumping" or "hunting," to which reference has already been made, sometimes even of sufficient amplitude to throw the machine out of step, and are often provided with the shoes or bridges found useful with ordinary synchronous motors.

Synchronous motor-generators, so far as the motor function is concerned, present no peculiarities at all. Synchronous commutators, "permutators," and the like, usually have motor-parts of very moderate capacity, and must be kept rigorously free of hunting in order to preserve the conditions of commutation.

In many instances, particularly in American practice, motor generators with induction motors have been used for ease of starting and to secure immunity from hunting. A modification of interest from the motor standpoint is found in the "cascade converter." In this machine the rotor of an induction motor is directly coupled to the armature of a commutating converter of equal output, the windings of the two being in series and approximately equivalent.

In this case the primary current is for approximately half synchronous speed, and half the energy is delivered to the output end of the machine by the rotor acting as frequency changer, the rest by torque on the shaft. Commutation takes place therefore at half the initial frequency, which is often a great advantage.

(B) 2. *Polyphase Induction Motors.*—Speaking broadly, an induction motor is one in which the armature current is introduced into the armature windings by electromagnetic induction instead of by brushes. It is at once an alternating-current transformer and an alternating-current motor, operating in the latter function by virtue of the current received from the former. In the commonest form the alternating currents are of two or more phases interacting in carrying on these duplicate functions. Induction motors consist of two concentric masses of laminated iron taking the form of short hollow cylinders, of which the outer is fixed and the inner fitted to revolve. The outer surface of the inner drum and the inner surface of the outer drum are slotted or perforated to receive the primary and secondary windings of the apparatus. The outer winding is usually the primary, and the inner (or armature) winding the secondary. The primary winding is almost universally a multipolar drum in character; the secondary is, in the most highly developed motors, of the same character, but very often consists merely of numerous insulated armature bars united at each end of the drum by a common end-plate or end-ring, forming the structure usually known as a "squirrel-cage" winding. In polyphase motors of the usual type the primary drum winding is in duplicate or triplicate, resembling very closely the armature winding in a two- or three-phase generator. The actions which go on in these motors have been the subject of much debate; most of the theoretical discussions of the matter have been based upon the concept of a rotary magnetization produced by two simple sinusoidal magnetisms superimposed in quadrature upon the same core, or, in the case of a three-phase motor, three superimposed in a similar symmetrical manner. This hypothesis is often most convenient, being merely an application of the general physical thesis that two equal simple harmonic motions in quadrature produce circular motion, as in the case of the circle pendulum. All the results which may be followed, however, from the introduction of two alternating magnetizations acting in quadrature in time but independently; and one or the other view of the matter is convenient according as, in the structure considered, the effective magnetizations do or do not produce a definite physical resultant. There is no discrepancy between the two hypotheses; they are merely two points of view of the same phenomena. In the general case, one need make no supposition as to the existence or non-existence of the physical resultant rotary magnetization; it is merely necessary to note that if one phase-winding predominately produces a magnetic field in one direction, the other winding member fitted to react with that field, torque will result, whether the two phase-windings act upon the same magnetic structure or upon two entirely separate magnetic structures merely connected by the leads which deliver current from one to the other.

Induction motors having both these forms of structure are in successful use. If one considers the latter case, the two-phase windings have exchanged functions every 90° in the two-phase structure, each phase-winding serving to produce a magnetic field and to deliver current, while merely a pair of brushes, carrying current to react with this field alternately, and the two halves of the motor structure exchange functions every 90° . Considering the motor in which the two-phase-windings are superimposed on the same core, there is a virtual magnetic resultant rotating at a speed determined by the frequency of the current and the number of poles, and setting up induced currents in the secondary member, which currents are so disposed as to react with the field to produce

rotary motion. At rest, the secondary electromotive force produced by the machine as a transformer is a maximum; when the motor is running at speed, unloaded, it is a minimum, and an increment of load causes the secondary member merely to slip behind synchronous speed far enough to receive an increment of transformed energy sufficient to carry the new load. If the secondary member is of very low resistance, the slip behind synchronism is very small, even at full load, less than 2% in motors developed for this purpose.

An increase of secondary resistance produces increased falling behind from synchronous speed; and if resistance be added to the secondary member by interpolating rheostats in its circuits, the motor can be made to produce uniform torque over a very wide range of speed, as is the case with continuous-current motors. The percentage of slip is the percentage of energy lost in the secondary member, as likewise in continuous-current motors if one regards their synchronous speed as that at which the motor electromotive force would equal that impressed. Polyphase induction motors start, when properly designed, with a very powerful torque, even up to three or four times the full load running torque of the same motor. With a very low-resistance secondary member this torque demands an immensely large current, the structure acting almost like a short-circuited transformer, and the lag in the secondary circuit is considerable. In motors in which this large starting current is objectionable, it may be reduced very greatly by interpolating resistances in the secondary circuits at starting, the effect of these being to diminish the lag in the secondary circuit and to decrease the demand for maximum torque. At certain intermediate values of resistance gives a maximum torque per ampere in the primary circuit with a given motor, being approximately that total secondary resistance which equals the secondary reactance. For maximum torque obviously both resistance and reactance should be equal and as small as possible. Where a small primary current in starting is of considerable importance, this extra resistance is frequently introduced at starting and cut out afterwards, particularly in cases where large torque is necessary. If great starting torque is not necessary, the primary electromotive force is often diminished by inductive resistances, or a change in the connections of the transformer from which the motor is fed. Both methods of starting are in commercial use on a very large scale.

In efficiency and closeness of speed regulation and good general running properties polyphase induction motors approximate very closely to the best continuous-current practice. They produce, however, a certain amount of lag between primary electromotive force and current, which causes the apparent input to be larger than the real input, as generally happens in alternating-current work. This lag is usually the result of the reactance of the transformer, the power factor of the motor. In well-designed modern machines this is usually from 85 to 90% at rated load; it should seldom fall below the former figure, and rarely rises more than 1 or 2% above the latter, though in rare instances power-factors as high as 94 or 95% have been obtained. Condensers have sometimes been employed in connexion with such motors to increase the power-factor, and with considerable success, particularly in maintaining the power-factor at low and moderate loads; but their use is generally unnecessary, and of sufficient capacity at any reasonable value of the voltage have proved troublesome to build and maintain. The weakest point in these polyphase induction motors is the importance of employing a very small clearance between armature and field, in order to increase the power-factor by making the structure more efficient, considered merely as a transformer. The clearances in ordinary use are seldom greater than $\frac{1}{16}$ in., even in motors as large as 100 h.p., and in smaller machines are frequently not more than $\frac{1}{32}$ in. Induction motors, however, possess many valuable properties, and are the mainstay of long-distance power-transmission work at the present time.

(B) 3. *Monophase Induction Motors* closely resemble the polyphase motor in construction, but have only a single-phase winding in the primary. The theories of their action are very similar to those of polyphase motors. The essential point of difference is that the stable angular displacement between the field magnetization and the armature currents which co-act with it is obtained in the polyphase motor by the time-displacements in the several phase windings, while in the single-phase motor it is obtained by the slight displacement of the armature, which has to be set up by an initial rotation. Single-phase motors are therefore not inherently self-starting, and run in either direction equally well when once started. The torque is always in the direction of the initial rotation. This rotation is sometimes given by hand and sometimes by auxiliary phase-windings supplied by derived current from the main circuit, or merely short-circuited on themselves and receiving induced currents from the main winding. Both these devices give a small initial torque in a definite direction, setting up a so-called elliptical rotary field, i.e. one produced by the composition of two unequal magnetizations, in this case at the same indeterminate angle, which seldom largely exceeds the slip speed, the single-phase motors act much like the polyphase. They are conspicuously weak in the matter of power-factor, however, as well as in that of starting-torque, and have as yet not come into very extensive commercial use, although under special conditions they have been and are successfully employed. A theoretically interesting form of induction

motor is a modification which runs at absolutely synchronous speed, receiving the necessary energy in the secondary not in virtue of slip behind synchronous speed, but from great difference in wave form between the primary and secondary circuits, so that energy due to harmonics of the fundamental frequency is periodically received by the armature in spite of synchronism in speed. Such motors are not employed commercially, but sometimes find a field for usefulness in the laboratory.

(B) 4. *Repulsion-Commutating Motors* constitute a class of single-phase alternating-current motors which has risen to considerable commercial importance. They are fundamentally induction motors in the sense that the armature currents are supplied by the inductive action of the field. The armature winding is, however, provided with a commutator and (for a two-pole motor) two diametrically opposite brushes, which are short-circuited on each other and placed at an angle with the line of field magnetization. By this device the magnetic axis of the armature is held at a fixed angle with the field flux, so that the condition for steady torque is always fulfilled, its amount depending on the position of the brushes. Were these either in line with, or exactly at right angles to, the field poles, the torque would be zero—in the first case from lack of angular displacement, in the second from lack of secondary current. The brushes being skewed, however, the secondary current is maintained at a suitable value, and the motor runs in a definite direction. The general principle is merely that of a transformer with a movable secondary under magnetic thrust. During reversal of the current the torque relation remains fixed, since the primary and secondary currents both change sign, preserving the magnetic relations as in a series-wound continuous-current machine.

Such a motor is of moderate reactance, the currents are large and the torque very considerable. The repulsion-commutating connexion is considerably used as a starting device for single-phase induction motors, the commutator being short-circuited as a whole when the armature reaches synchronous speed. Thereafter the machine operates as a pure induction motor of the sort just described. The advantage of this change is that the commutator is eliminated, save at starting, and the motor becomes practically a constant speed machine like any other properly-designed simple induction motor. Such motors can be made to start if necessary with several poles, the number being limited only by the reactance and frequency of current. The short-circuiting of the commutator is generally performed automatically by a centrifugal governor. When at speed, efficiency and power factor are those of the typical motor of class(B)3.

The pure repulsion-commutating motor, worked as such, on the other hand, resembles a series-wound motor in its characteristics, having no fixed speed and being capable of running far above nominal synchronism. This results from the fixed angular relation maintained by the brushes between the armature and field magnetizations, whereby the torque conditions are preserved. Above the nominal synchronous speed, however, difficulties of commutation set in, so that some modifications of this simple type are desirable for wide ranges of speed. The power factors of these motors compare well, both in starting and in running, with those of the best pure induction motors, and their efficiencies are similar. These machines are reversible, serving as alternating generators when driven mechanically at "negative" speed.

Instead of simply skewing the brush line in the repulsion motor, an entirely analogous effect may be produced by dividing the field coils into pairs placed in quadrature, the brush line being parallel to one pair and at right angles to the other. This may be effected by dividing the function of the original field physically into its components, a change which sometimes tends to improve the stability of the running conditions.

A more radical departure is found in the group of so-called "compensated-repulsion" motors, of which there are several members, due to various inventors, all material improvements on the pure repulsion type just described. Their common characteristic is that while possessing like simple commutator-repulsion motors, a transformer field acting upon the armature as secondary, and a pair of short-circuiting brushes holding the resulting armature magnetization in definite alignment, they also send the primary current in series through the armature via a second pair of brushes in quadrature with the first. The substantial effect of this series connexion is to cut down the virtual reactance of the armature as the speed rises, practically annulling it at synchronous speed. In alternating motors the motor-electromotive force is not merely that due to the motion of the armature conductors but the geometrical resultant of this and the reactance E.M.F.'s. In the motor here considered and analogous machines an auxiliary E.M.F. is applied either as here, conductively or inductively, in such direction as to compensate practically for less than the armature reactance E.M.F. The result is to secure, at least for a certain speed, a power factor near unity, as in the motor under discussion, although the starting conditions are not particularly good and the performance deteriorates above synchronism. In some motors of this type the compensating E.M.F. is introduced by an auxiliary winding in series and in quadrature with the main field, instead of by supplementary brushes. The modifications of the general scheme are rather numerous, and out of them have come some excellent single-phase motors now widely used for traction purposes.

(B) 5. *Series Commutating Motors*.—This important and interesting type is derived directly from the ordinary series motor for continuous current. The torque in these does not change sign with reversal of the current in both field and armature, and consequently alternating current can still produce in them unidirectional torque. Practically the first step toward an alternating current series motor is lamination of the field to reduce parasitic currents; the second is to keep down the reactance. A laminated field motor performs fairly well at frequency of periods or the half-cycle, so that it is useful at ordinary frequencies requires modification in design. The motor E.M.F. being as before the geometrical sum of the reactance E.M.F. and that due to motion of the armature conductors, the first improvement can be made by making the latter dominant, i.e. by making the armature relatively very powerful. The plain series commutating motor has then a relatively weak laminated field and a powerful armature. To check trouble with commutation due to short-circuiting coils under a brush, it usually has high resistance commutator leads, and thus equipped is capable of very fair performance, having the same general characteristics as the continuous-current series motor. Even so the armature reactance is somewhat excessive, so that with this simple construction the power factor is apt to be bad. Practically the plain series commutating motor is hardly used at all, but rather modifications of it corresponding very closely to those mentioned in connexion with the repulsion motor. In other words, an auxiliary electromotive force tending to annul the reactance E.M.F. of the armature is imposed upon the armature circuit. This is accomplished generally by a "compensating coil" in series and in space-quadrature with the field. In another modification the compensating coil is closed upon itself forming a short-circuit secondary, to which the armature itself acts as primary. The end to be attained is the addition of an E.M.F. such that the vector sum of the E.M.F.'s in the armature shall reduce as nearly as may be to the E.M.F. due to the motion of the armature conductors, as in a continuous-current motor. Obviously it is difficult to secure full compensation for all loads and speeds, but it can be made nearly complete for some particular load and speed.

These "series-compensated" motors behave much like continuous-current series motors, and, when properly designed, run well on continuous current. They have been developed in part especially for heavy traction purposes, to which they are well adapted, owing to their ability to work well at all speeds. They give a very high maximum power factor and a reasonably good one over a considerable range of speed and load. Obviously both the field proper and the compensating field can be made subject to regulation to increase the range of successful action. Motors of this type have already come into successful use for fast and heavy railway service. Commutation appears to be reasonably good, although it is a far more difficult problem than with continuous-current machines.

The efficiency and output for unit weight in all alternating-current motors is a little less favourable than with continuous-current motors. In the last resort the supply of energy to a single-phase motor is essentially discontinuous, and there is inevitable extra loss from hysteresis and parasitic currents, whether the motor is single phase or polyphase. The result is that an alternating-current motor requires, other things being similar, more or better material, and loses a little more energy than a continuous-current motor of equal output. Motor design is a compromise, and while any one property can be exaggerated, it will be at the expense of others. One could probably build, for instance, a series-compensated motor of as high efficiency or as large output per unit weight as any commercial motor, but there would be sacrifice somewhere, in cost if not conspicuously elsewhere. As a matter of fact, the difference in efficiency usually amounts only to a very few per cents., and the difference in output per unit weight to a few more. The gain in the use of alternating-current motors is in facility and economy of distribution, which in many cases is far more than enough to outweigh any inherent disabilities in the machines themselves. Hence they are coming steadily into extended use. (L. BL.)

MOTOR VEHICLES. The term "motor-car" is one which was primarily employed in America to denote the car or carriage containing the electro-motor used for propelling an electric tramcar or train of carriages on rails, but of late years it has been more usually applied in Great Britain to light automobile or mechanically-propelled carriages running on common roads. On the continent of Europe and in the United States the usual expression for these vehicles is "automobile"; the term "auto-car" has also been employed. We shall deal here first with the history of mechanically propelled carriages, and with the evolution of the lighter type used for conveying people for pleasure and sport; and secondly with the heavier type used for the carriage of goods.

Light Vehicles.—The first practical steam carriage was made by Richard Trevethick in 1802 (fig. 1), though Cugnot had produced a rudimentary one in France in 1769; but very little was done in

this direction until 1824, from which date a number of these vehicles were constructed and used with considerable success, taking the form of stage coaches propelled by steam, and weighing some 3 or 4 tons unloaded. Some of these ran regular passenger services, notably between Cheltenham and Gloucester, attaining average speeds of 10 to 14 m. per hour; but great

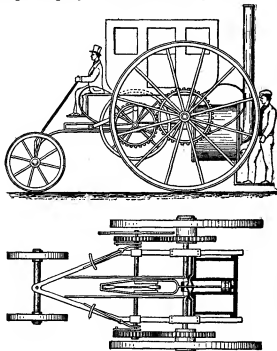

FIG. 1.—Trevehick's Steam Carriage of 1802: side view and plan.

opposition was met with owing to the narrow prejudice of those whose interests related to horse-haulage, and every obstruction was offered in the shape of prohibitive tolls and legislative enactments. The result was that steam carriages were driven off the roads in favour of railways, although the select committee of the House of Commons appointed in 1831 to inquire into the subject reported completely in favour of their adoption (as did also that of 1873). In 1861 the first Locomotives on Highways Act was passed, but the crushing blow came in 1865, when the legislature prescribed (1) that the number of persons required to drive the locomotive should be increased to three; (2) that a man should precede with a red flag; (3) that the maximum limit of speed should be reduced to 4 m. per hour; and (4) that they should be forbidden ever to blow off steam, &c. These restrictions were confirmed rather than relieved by the 1878 act. Although these acts were created to deal with heavy traction, the famous 1881 appeal in the court of queen's bench placed every type of self-propelled vehicle, from a traction engine down to Bateman's steam tricycle, under their narrow limitations. This resulted in the development of the heavy traction engine, and light motor vehicles were little more heard of in Great Britain. There were a few exceptions, however, notably the steam vehicles of Rickett (1860), Carrett (1861), Tangey (1862), Yarrow (1862), Holt (1866), Todd (1870), Perkins (1870), Mackenzie (1875) and Blackburn (1878), and some electrical carriages made by Elwell (1884), Ward (1886) and Volk (1888). An important departure was that of Butler, who constructed in 1885 what is believed to be the first vehicle (a tricycle) propelled by an internal combustion engine in England (fig. 2); he used the vapour of benzoline exploded electrically. Later, Rootes successfully employed heavy oil, as did Knight. The chief prohibitory clauses of the acts were repealed in 1896, when the development of the internal-combustion engine had opened up entirely new prospects and suggested new possibilities.

Gottlieb Daimler's invention in 1885 of the internal-combustion motor using petroleum spirit was the first step towards the production of the modern self-propelled road vehicle, the next

step being the recognition in 1887 of the advantages of Daimler's system by M. Levassor and his application of that system to the propulsion of a carriage. In the nine years that immediately followed French manufacturers spent large sums of money in experimenting with and developing the motor-car, and by 1896, when the Enabling Act was passed, there were a few practical

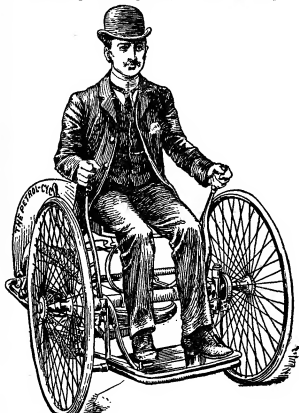

FIG. 2.—Butler's Motor Tricycle of 1885.

vehicles in England but, perhaps, fewer probable buyers. British makers, starting as they did in the wake of the French manufacturers, were able to profit by the experience gained by the latter, and thus to avoid many otherwise inevitable mistakes; they may not be able to claim to have originated many of the fundamental details of the modern motor-car, but their experience was gained at a comparatively small cost.

Gottlieb Daimler's engine marked a great advance in the production of a source of motive power, for its efficiency was large as compared with its total weight, whilst the simplicity of its fuel system brought it within the scope of the person of average mechanical instincts and intelligence, for, even in its early days, the internal-combustion motor did not demand that its user should possess an intimate knowledge of engineering. Daimler fitted one of his motors to a bicycle in 1885, and afterwards applied the system to the propulsion of boats, one or more of which were running on the river Seine in connexion with the Paris Exhibition of 1887. It was this fact that brought the invention to the notice of M. Levassor, of the firm of Panhard & Levassor, makers of wood-working machinery, who saw the possibilities of its application to the propulsion of a road carriage. M. Panhard & Levassor secured the French patents from Daimler, and M. Levassor devised the transmission system which, as far as its general scheme is concerned, is unaltered to-day, despite many efforts on the part of skilful inventors and designers to secure something better. M. Levassor placed the engine in front, the axis of the crank-shaft being parallel with the side members of the frame of the vehicle. The drive was taken through a clutch to a set of reduction gears and thence to a differential gear on a countershaft from which the road wheels were driven by chains. With all the modifications of details, the combination of clutch, gear-box and transmission remains

unaltered, so that to France, in the person of M. Levassor, must be given the honour of having led in the development of the motor-car.

Progress in the improvement of design was slow until the year 1894, when a great impetus was given to the French industry by the organization, by the *Petit Journal*, of a trial run of motor vehicles from Paris to Rouen. The measure of success attained by the cars caused considerable surprise, and in the year 1895 a race was organized from Paris to Bordeaux and back, a distance of 744 m., when the winning vehicle covered the journey at a mean speed of 15 m. per hour. From that date onward, until 1908, racing played an important part in the development of the motor-car; in fact, it is not going too far to say that, up to 1904, it played a vitally important part therein. The effect was a rapid development in speed, efficiency and reliability, and others besides the sportsman and the individual seeking for new sensations were attracted towards the new vehicle. Racing was not indulged in in England or Scotland, the authorities having no power to close the roads for the purpose.

radical changes in previously-existing designs. So far as British makers were concerned, the Mercédès fashion was allowed to predominate, but some of the older French makers were less willing to follow the lead of the great German house. This fact assisted the British makers to forge ahead in their competition with the French. But the great factor in the triumph of British motor engineering arose from the fact that, in England, there was a great wealth of knowledge concerning the properties of steels and steel alloys, and that knowledge, which was advancing all the time, was turned to such good use that it is safe to say that, in only the very best of French cars is the same strength and efficiency obtained from the same weight of metal as would be used in the construction of quite a number of British cars. Lightness of moving parts has led to increased engine efficiency and to economy of fuel, whilst the inert parts of the mechanism—the frame and other fixed details—by being lighter, call for a smaller expenditure of power to overcome their inertia. Apart from the employment of special steels for motor-car construction, in which England took a leading part, many improvements

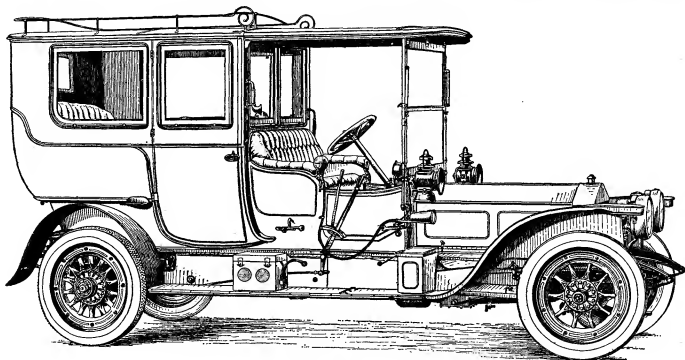

FIG. 3.—The 40-50 h.p. Six-cylinder Rolls-Royce Pullman-Limousine.

In July 1902, Mr S. F. Edge, driving a 50 h.p. Napier car, won the Gordon-Bennett Cup in the course of the open race from Paris to Vienna. This trophy has played an important part in the history of the motor-car. It was offered for competition among cars, entered by recognized National Automobile Clubs, no more than three cars being permitted to represent a country, and every car had to be built entirely in the country of its origin. The length of the race had to be not less than 500 kilometres (310½ m.). The first two races in 1900 and 1901 had been won by French cars and, as these contests had been run concurrently with the big city-to-city races, the importance of the Gordon-Bennett race was overshadowed. But it stood out in bold relief when an English car wrested the international trophy from its French rivals in 1902. The Automobile Club of Great Britain and Ireland (now the Royal Automobile Club) at once secured parliamentary sanction for the use of certain roads in Ireland for a limited period, and proceeded to organize a race worthy of the issue at stake. The race was won by the Mercédès car, the latest production of the famous house of Daimler.

The Mercédès car set quite a new fashion, for it showed advancement in a large number of its mechanical details, and many of these details were either copied or used as the basis for

improvements in design and method have originated in Great Britain. For instance, the multiple-disk clutch, which permits a car to be started without shock, is an English invention, as are the detachable wheel, the spare wheel and the six-cylindered engine. The latter, introduced by the Napier Company and employed extensively by them, by Rolls-Royce and others, has exerted a great influence upon British tastes, because it created a growing dislike to noise, one of the consequences being the rapid development of the silent car.

The representatives of Great Britain in the Gordon-Bennett race of 1903 were selected by means of a series of eliminating trials, and in 1904 and 1905 races were held annually in the Isle of Man for the same purpose. In the years 1906, 1907 and 1908 races were held in that island with such limitations on fuel or on the diameter of the cylinders as were calculated to encourage the development of small but efficient transmissions, and it has been conceded generally that these races served an extremely useful purpose.

Concurrently with its development into a reliable, silent, odourless and smokeless power-propelled vehicle, the motor-car gradually came into more general use. It no longer appealed only to a few but gained converts daily, and its final triumph came when it began seriously to displace the horsed vehicle.

becoming the private carriage of the wealthier classes to be used on all occasions.

If the motor-car in the guise of a private carriage has developed at an astonishing rate, its adaptation to the needs of the community, as a public service vehicle, has been even more rapid. The first cabs placed on the streets of London in 1903 were by no means a success, but the cabs constructed by the French house of Renault and first introduced in London in 1906 rapidly effected a revolutionary change in the means of individual transport. Apart from the improved speed of the motor-cabs, they gained popularity because of the use, on each one of them, of the taximeter, showing at a glance the amount of the fare, thus preventing overcharge on the part of the driver. One effect of the employment of motor-cabs and motor-omnibuses has been to reduce slightly the total number of vehicles, and to quicken a large volume of the traffic; it is now being recognized that to increase the speed of the whole of the traffic of London by about 5 m. an hour is practically equivalent to doubling the width of the whole of the main streets.

The new British act of 1903, which was enacted for three years only, was, during the parliamentary session of 1906 and subsequent sessions, continued from year to year because of the difficulty that was experienced in reconciling conflicting views about the control of motor-cars. The 1903 act raised the speed limit to 20 m. per hour and gave the local government board power to close to motor traffic such roads as, on inquiry, might be deemed unsuited therefor, and to impose a speed limit of 10 m. an hour or less in dangerous places, such as narrow streets in a town or through a village. A few serious accidents in England, and many abroad, have kept alive the fear that the motor-car is a dangerous vehicle that should be restrained or held in check by stringent legislation. Thus from 1904 onwards, the motorist was under continuous police supervision. Police traps, or measured distances, over which the motor-car is timed by the police, were established in most of the counties of England, and, whilst, without a doubt, many real offenders were caught, it is equally true that many an innocent driver was unfairly accused, whilst motorists guilty merely of technical infringements of the law were summoned.

The attitude of the police in showing little or no leniency in the application of the law probably, however, did good in other directions, although these were not contemplated either by the law-givers or the police themselves. It considerably limited the use of excessively powerful cars (for example, a 60 or 90 h.p. car that could easily attain 60 m. an hour), and experience has demonstrated the fact that, intersected as England is with a network of narrow roads carrying considerable traffic, there is little opportunity for the full power of such a car to be used. The result has been that the comparatively low-powered vehicle has been developed in efficiency, bringing with it the advantages of economy in running, simplicity of mechanical details, cheapness of maintenance and ease of control and management.

The principle of the internal-combustion engine has not been altered since Daimler's day, but the mechanical details of the engine have undergone constant revision and improvement, until in 1910 it was safe to say that a four-cylindered engine, with a cylinder bore of 4 in., constructed, we will presume, in 1899, might have developed 20 h.p. or less, whereas engines of the same cylinder bore made in 1908 and 1909 actually developed 60 h.p. and more, and the attainment of even greater efficiency was in sight in 1910. Experience showed that the saving of weight meant greater economy in fuel and also in tires, the two principal items in the upkeep of the motor-car. Engine design has undergone unceasing improvement, and constructional methods have been continuously advanced, with the end in view of attaining lightness, not only in the moving parts, but in the inert parts. Lightness in reciprocating parts, such as the pistons, connecting rods and valves, has enormously improved crank-shaft speed. Cylinder castings are now made far lighter, whilst the water jacketing, for dissipating the excess of heat from the cylinder walls, is now

of sufficiently ample proportions and, in consequence, better lubrication of the cylinder walls can be maintained. This again conduces to piston speed. The induction valves of engines of the earlier types were opened under atmospheric pressure, the reduced pressure in the cylinder, caused by the downward movement of the piston, enabling the pressure of the outer atmosphere to open the valve against its light spring, and to carry in a charge of the carburetted air that constituted the explosive mixture. But it was found that the automatic or atmospheric inlet valve opened late on the induction stroke and closed early, so that the engine only received an attenuated charge. One of the earliest improvements in engine design, therefore, was the employment of the mechanically-operated inlet valve operated by a cam exactly as the exhaust valve is operated. This valve could be fully opened as soon as the piston had begun its downward or induction stroke, and could be held open during the momentary period when the piston was at rest at the bottom of the stroke, thus ensuring a full charge of explosive mixture. The method of exploding the charge in the cylinder has undergone revolutionary changes. The first method, that of heating the exterior of a closed tube connected with the cylinder, quickly gave way to electric ignition because it was found that the charges could not be exploded by the hot tube until the piston had reached the top of its stroke, and, at the comparatively high piston speed of these engines, the piston had moved some distance on its downward stroke before the exploded gas had begun to expand. Electric ignition was an improvement because it enabled a "lead" to be given to the explosion, a low voltage current (from four to six volts of about one ampere being sufficient for the purpose) being automatically switched on to the primary circuit of a coil, the induced current in the secondary circuit being of a voltage sufficiently high (calculated at from 5000 to 10,000 volts of a very small amperage) to jump across a gap left in a sparking plug inserted in the cylinder. By rotating the body of the switch (called the contact breaker) the ignition could be timed to suit exactly the speed of the pistons and, in this way, greater piston speed was obtainable. The great development of this system was the introduction by Mr F. R. Simms, in conjunction with Herr Bosch, of the magneto machine, known as the Simms-Bosch magneto, the prototype for many such appliances. This machine, in its simplest elements, produces a low voltage current (assumed to be of about eight or ten volts) by the rotation of an armature in the magnetic field of a set of magnets, the rotation being effected through the timing-gear wheels of the engine. The low tension current is conveyed through a primary circuit inducing the secondary current which is employed for igniting the charges. The advantages of the magneto are, firstly, that the primary current is created by the engine, and that the need for an accumulator as a source of that current is avoided and, secondly, that the spark is more efficient because the faster the armature is revolved the more intense is the primary current and the induced current, consequently, the charge is ignited more rapidly. The magneto machine has almost entirely displaced the accumulator system for ordinary running, although, as the latter makes for easier starting, it is often fitted as an addition.

Great gain in power has been secured from improvements in the lubrication of the internal-combustion engine. It is now recognized that a small supply of oil to the journals and bearings of such an engine is insufficient, but in the early days it was found difficult to give the journals and bearings more oil without too much getting on to the cylinder walls, because the latter were lubricated by the oil that was thrown on to them by the spinning action of the webs of the crank-shaft and by the connecting-rod ends, these latter dipping into a well of oil in the lower part of the crank-case. The modern method has overcome this difficulty. The cranks and connecting-rod ends no longer dip into the oil, for the latter drains away into a sump or reservoir below the base of the crank chamber. Thence it is passed through a filter and pumped to ducts which convey the oil under pressure to the crank-shaft journals. Sometimes it is conducted thence along ducts bored in the crank-shaft and

through the webs and crank-pins, whence it feeds the connecting-rod bearings, enough squirting out to splash on to the cylinder walls. Sometimes, a shallow trough is placed under each connecting-rod end, to hold oil to a certain depth and no more, and a scoop on the big end collects enough oil to effect the lubrication of the connecting-rod bearings and cylinder walls. The aim has been to secure definite lubrication of all moving parts, and, at the same time, to prevent oil being present on the cylinder walls in such quantities as will permit the piston to carry it up into the combustion chamber. Any oil present in the combustion chamber is burnt during the explosion, but, its combustion being imperfect, smokiness of the exhaust is the result. By reducing the oil on the cylinder walls to the minimum necessary for lubrication, smoking has been abolished, whilst clogging, or carbonizing, of the valves has been materially reduced.

Methods of carburation have also undergone improvement, so that the carburation shall not materially vary with varying engine speed. The only other feature in the engine that calls for mention is the method of cooling. With the introduction

of the honeycomb type of radiator, by which the water is made to flow through canals an eighth or a sixteenth of an inch wide, the efficiency of the cooling system has been doubled because of the large amount of surface, in a given size of radiator, for dissipating the heat. A fan is generally employed, either situated behind the radiator and driven by the engine, or the flywheel is vanned so as to induce a current of air through the radiator.

To deal now with the transmission mechanism, the drive is taken through a clutch and gear-box as in the earliest days, but, for the final drive, chain transmission to the road wheels running on a fixed axle has largely given place to propeller drive on to a live axle. The leather-faced conical clutch, although still employed, has in many cases given way to the multiple-disk clutch in which a number of disks bearing against each other, either flat in section, or (as in the Hele-Shaw clutch) having annular tapered grooves, are contained in an oil-tight box. These plates are capable of being separated laterally from each other when "out of gear," or brought into frictional contact with each other when it is desired to start the car. Metal-to-metal cone clutches, expanding metal shoe clutches, single metal plate clutches and coil spring clutches have all at some time found favour with designers wishing to avoid a leather clutch. Hydraulic and electro-magnetic clutches have also been tried, but these have not gained any vogue. In the matter of the gear-box, the sliding into mesh of the gear-wheels as employed by Levasor is still the standard practice, although that pioneer himself regarded the method as barbarous, and looked upon it as a mere temporary expedient. But details of the gear-box have materially improved. A single lever is usually employed for engaging any of the forward gears or the reverse, so that the mistake of simultaneously engaging a reverse and a forward gear is not possible. The spur-wheels are generally mounted in pairs on two sleeves, so that, by means of a selector mechanism that compels one sleeve to be brought to the neutral position before the other can be moved, no two gears can ever be engaged together. By means of "dog clutches," the clutch shaft can generally be coupled direct with the bevel-wheel driving the back axle, the "drive" on the highest gear being thus transmitted without passing through any spur-wheels. This reduces noise and frictional losses. Except for cars of great weight, chain transmission is fast dying out, the power being generally transmitted through a propeller shaft (with universal joints at one or both ends) to a bevel-drive on the back axle; such axle being divided into two revolving or "live" axles carrying the differential gear between them. The bevel-wheels, differential gear and live axles are enclosed and run in a lubricant.

Wire suspension wheels are growing considerably in favour, a saving in weight being thus effected. The liability of the pneumatic tire to deflation, through a puncture or burst,

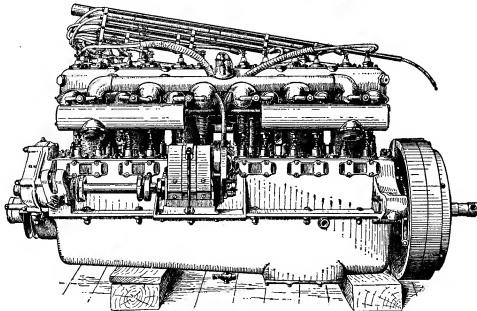

The 40-50 h.p. Six-cylinder Rolls-Royce Engine (valve side, showing also position of magneto).

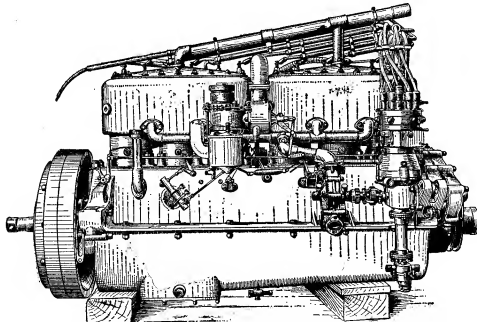

FIG. 4.—The 40-50 h.p. Six-cylinder Rolls-Royce Engine (carburettor side, showing also high-tension distributor, and position of centrifugal water pump).

has led to the introduction of detachable rims and detachable wheels. The detachable rim is borne on the periphery of the wheel (which is bonded) and secured in position by various methods. When the tire is punctured or damaged the rim and tire are removed bodily and replaced by a spare rim with its tire already in position and inflated, a change capable of being effected in five minutes or less. The detachable wheel is mounted upon a shell which fits over and is secured to a sleeve,

four cylinders (according to the choice of the riders) developing some 3 to 8 h.p. with magneto ignition and belt drive. The engine was usually started by the rider running alongside the machine, and causing the machine to rotate the crank-shaft through the belt and pulley until the initial explosion was obtained, when he would jump into the seat. Trailers were employed at first for carrying passengers, but, the length of the combined vehicle being between nine and ten feet, a side-car,

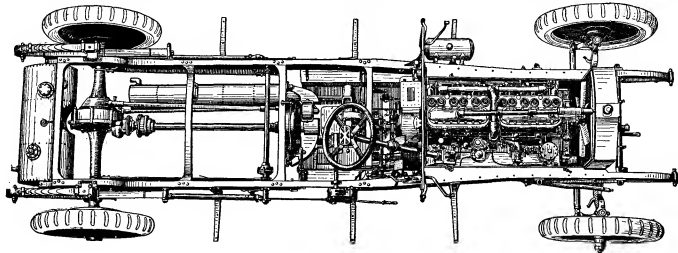

FIG. 5.—Plan View of the 40-50 h.p. Six-Cylinder Rolls-Royce Chassis (1910 type).

which latter turns and is secured upon the fixed axle. In the case of tire trouble, the wheel intact is removed from the sleeve (which in the case of a driving-wheel carries the driving fittings, the brake-drums, &c.) and a duplicate wheel is substituted. The pneumatic tire has undergone continuous improvement, particularly in the matters of the selection of the material and the proportioning of the strength of the "body" to the work which the tire is to be called upon to perform. Various methods have been devised for the prevention of skidding or "side-slip" on greasy surfaces, and, whilst certain mouldings on the rubber treads have proved advantageous, the method most adopted is that in which a large number of steel studs stand about a quarter of an inch above the surface of the tire.

It will be seen that the general lines of the car of 1889 have not required to be radically altered. Every detail has been improved so that the cars are more efficient, easier to control and manage, and infinitely more comfortable, but, in essence, Levassor's scheme is as good to-day as it was when planned by him.

The steam car is made by five or six British manufacturers at the most, whereas the actual manufacturers of petrol cars in Great Britain numbered at the end of the year 1909 about seventy, whilst some four hundred other firms were actively engaged in the construction of cars and their parts, accessories and sundries. But the steam car appeals to those men who are or have been steam engineers, and to them the management of the steam generator and the burners constitutes no difficulty. The limitations under which the early steam car laboured have, in the main, disappeared, for the modern steamer can travel nearly as far without requiring to refill the boiler as a petrol car can travel without replenishment of the fuel tank. The electric car is still the luxury to be employed in towns and in covering short distances, for the weight of the accumulators has not been greatly reduced, despite sensational announcements made from time to time.

An interesting feature of the motor movement has been the steady growth in popularity of the motor cycle. The motor tricycle was developed up to the year 1903, and then gradually became displaced by the motor bicycle, which had been introduced in 1901. Motor bicycles gradually increased in popularity, until in numbers they were in excess of cars. The standard machines of 1909 had an air-cooled motor of one, two or even

placed at the side of the cycle and secured thereto by detachable fittings, largely displaced the trailer and also the "fore-car," in which the passenger was carried in a body placed in front of three- and four-wheeled cycles.

The rapid growth of the motor movement in Great Britain may be judged from the fact that by the 30th of September 1905 the number of motor vehicles of all kinds registered had totalled to 74,038, and by the 30th of September 1908, three years afterwards, to no less than 154,415. Of these, 137,323 were registered in England and Wales, 10,907 in Scotland, and 6185 in Ireland. 71,405 were private motor-cars; 12,104 were trade motor-cars; 5880 were public service vehicles and 65,026 were motor cycles.

A year later (Sept. 30, 1909) the figures showed a further remarkable increase, the total number of vehicles registered in the United Kingdom being 183,773, giving an increase of 29,358 in the year. Of these, private motor-cars numbered 84,840; trade motor-cars 15,181; public service vehicles 8752; and motor cycles 75,000. The numbers registered in England and Wales were: 74,748 private motor-cars; 13,961 trade motor-cars; 8131 public service vehicles and 66,341 motor cycles, or 163,181 in all. The figures for Scotland were: 6157 private motor-cars; 1056 trade motor-cars; 584 public service vehicles and 5296 motor cycles or 13,093 in all. The figures for Ireland were: 3935 private motor-cars; 164 trade motor-cars; 37 public service vehicles and 3363 motor cycles, or 7499 in all. In the year private motor-cars in the United Kingdom increased by 18.8%; trade motor-cars by 25.4%; public service vehicles by 48.8%; and motor-cycles by 15.3%.

It is possible to obtain a better idea of the number of motor vehicles in use from the returns of the commissioners of inland revenue. The total number of privately-owned cars for which licences were issued in 1908 was 48,019, of motor cycles 35,784, and of motor-driven hackney carriages 17,300. These figures may be compared with the registration figures already given for the year ending the 30th of September 1908. As accounting partly for the difference, a certain proportion of the registered vehicles (seeing that the figures include all vehicles in use on and after the 1st of January 1904, less those in respect of which the registrations have been cancelled) must have fallen into disuse and some vehicles will have been sold out of the country, whilst others will have been sold and re-registered with different authorities. But the life of the mechanism of a car, in one form or another, is of considerable length (there were, for instance, in use in 1910, as commercial vehicles, motor chassis that were put on the road in 1896), and it is considered that many registered but unlicensed cars remain for years capable of rendering useful service in emergencies or on special occasions, such as at election periods.

In 1906 an act of parliament authorized a census of production, which was taken in 1908, the statistics relating to 1907. These figures show that the output of complete motor vehicles in the United Kingdom in that year was 11,700 completed cars and chassis, and 3600 motor cycles, the total value of the productive work

done in the motor trade being £6,327,000 inclusive of repair work and the production of parts and accessories.

The number of cars and chassis imported into and retained in the country (those imported and afterwards re-exported being excluded from the statistics) in 1909 was 7747 as compared with 6530 in 1908. The absence of a classification, in 1907 and previous years, for chassis prevents further comparison in the matter of numbers, but taking the value of the motor-cars, parts and accessories imported into and retained in the United Kingdom, there is a total of £4,170,121 in 1907, £3,752,140 in 1908, and £3,922,781 in 1909; the average value per car falling from £432 in 1907 to £333 in 1909. The value of the motor cycles and their parts imported into and retained in the country was £71,101 in 1907, £52,206 in 1908, and £48,327 in 1909.

The number of British made cars and chassis exported in 1909 was 2802 as compared with 2441 in 1908, and of British made motor cycles 1893 in 1909 as compared with 1048 in 1908 and 800 in 1907; the total value of the exports of cars, parts, chassis and motor cycles in 1909 being £1,669,361 as compared with £1,315,913 in 1908 and £1,378,180 in 1907.

With the growth of the motor-car movement there have, naturally, been great developments in the outside industries catering for the motorist. Most affected by that movement has been the oil trade, considerable changes having taken place. In the distillation of crude petroleum for the production of lamp oils, &c., quantities of volatile spirit were obtained, the outlet for which, formerly, was small, as the spirit was mainly used for cleaning purposes. With the introduction of the petrol motor this spirit came into demand, and, as the demand increased, the situation changed and the crude petroleum had to be distilled mainly for spirit, thus leaving a surplus of the heavier oils. The situation was largely met by a gradual conversion of the petrol-consumers from spirit of .680 specific gravity to a spirit of .715 specific gravity, whilst for commercial motors even heavier grades were employed. The quantity of .715 spirit obtainable from a given quantity of crude oil is considerably greater than the quantity of .680 that could be produced, so that a better balance between the demand for motor spirit and that for lamp oil has been effected. The total quantity of motor spirit used in the United Kingdom in 1909 was 60,000,000 gallons, of which about one-half came from the Dutch East Indies, whilst a third came from America. Rumania supplied about 6,000,000 gallons and Russia about 3,000,000 gallons. Large quantities of lubricating oil were obtained from America, whilst the remainder (about one-tenth of the total) came from Russia.

France is the centre of the motor-car industry in Europe, and up to the year 1906 it undoubtedly led in the production of motor vehicles, but in that year the United States of America, as we shall have occasion to note, took the lead. The number of private cars in use in France had risen from 1438 in 1899 to about 23,000 in the year 1909, whilst industrial vehicles have increased even more rapidly in number. The following figures are obtained from the taxation schedules:—

Year.	Number of Vehicles in use.		Total.
	Pleasure Cars.	Industrial Cars.	
1899	1,438	234	1,672
1900	2,354	543	2,897
1901	4,427	959	5,386
1902	7,358	1,849	9,207
1903	9,922	3,062	12,984
1904	12,519	4,588	17,107
1905	15,011	5,332	20,343
1906	17,358	8,904	26,262
1907	19,601	11,685	31,286
1908	22,252	15,334	37,586
1909	26,000	20,000	46,000

The figures for the year, in the absence of the official return, are estimated.

The average h.p. per car (pleasure vehicles) has steadily risen from 5.06 in 1901 to 13.28 in 1908, the number of cars seating more than two persons having increased in greater proportion than those seating one or two persons.

The export of French motor vehicles had risen in value from 4,259,000 francs in 1899 to 144,352,000 francs in 1907. In 1908 the exports fell to 127,300,000 francs, and in 1909 an improvement to about 145,594,000 francs had taken place. The imports of foreign motor vehicles to France rose from 473,000 francs in 1899 to 8,676,000 francs in 1907, and since that period there has been an annual decrease.

In Germany the number of motor vehicles of all kinds in use on the first of January in each year is shown in the following table:—

Year.	Number of motor vehicles.
1907	27,026
1908	36,022
1909	41,729
1910	41,941

In 1910 45% of the total consisted of motor cycles, 49.3% consisted of pleasure vehicles and 5.7% consisted of commercial vehicles, the proportion of pleasure vehicles having consistently risen in the four years.

The development of motoring and of the motor industry in the United States has been exceedingly rapid. As good roads multiply and extend the use of cars must still further develop. The American farmer has discovered that he can make considerable use of the motor-car in connexion with his industry, and this fact largely accounts for the demand for high-wheeled buggies, and for vehicles having ample clearance between the machinery and the road level.

In the early days of the movement the American taste inclined towards steam cars, and the mistaken view that the vehicle driven by an internal-combustion engine could never be made to run as silently as a steam car was generally held. But in Europe the petrol engine became refined so rapidly that its equality with the steam engine in the matter of silence, together with its superiority in the matter of simplicity and suitability for the man who is not an engineer, soon created for it a popularity that prevented any material expansion of the business in steam cars. The makers of steam cars in America are able to cope with the major portion of the world's demand for this particular type of vehicle.

The introduction of the Dingley tariff, assessing an import duty of 45% *ad valorem* on motor-cars (in the classification of "manufactured metal"), added to a further charge of about 5% for freight, encouraged American capitalists to embark upon the manufacture of motor-cars, and in 1899 thirty manufacturers produced 600 cars. In 1909 the number produced by 200 concerns was 114,891. Set out in tabular form such figures as are obtainable are very striking:—

Year.	Cars Produced.	
	Number.	Value.
		\$
1899	600	1,290,000
1903	10,376	16,000,000
1904	13,766	24,500,000
1905	20,787	42,000,000
1906	23,000	50,000,000
1907	42,694	105,000,000
1908	49,952	83,000,000
1909	114,891	135,000,000
1910	200,000	225,000,000

The number of cars for 1906 is approximated and the number of cars and their value for the year 1910 are based upon the estimated output of the various manufacturers. In 1908, whilst the number of cars constructed showed an increase over the number for 1907, the total value had decreased owing to the commercial crisis of that year. In 1909 those manufacturers who had formed the Association of Licensed Automobile Manufacturers, and who agreed to recognize the validity of the Selden patents, paid licence fees upon 94,891 cars, the remaining 20,000 cars being estimated as the output of the concerns that did not belong to the association.

Of the 200,000 motor vehicles estimated to be constructed in 1910, 165,000 were to be petrol-driven pleasure cars, 30,000 were to be petrol-driven high-wheeled buggies, and 5000 steam and electric carriages and commercial vehicles.

The history of the Selden patent may be given briefly. A patent was applied for on the 8th of May 1879 by George B. Selden, of Rochester, New York, for a gas compression engine for propelling road vehicles. A patent was granted to him on the 5th of November 1880 for an improvement in road engines, and he claimed that any vehicle propelled by an internal-combustion engine, manufactured since that time, was an infringement of his rights under the patent. At the commencement of the year 1910, 71 manufacturers admitted this claim and paid to the Association of Licensed Automobile Manufacturers 14% of the catalogue price of their products as licence fees.

The imports of motor vehicles into the United States of America are not numerous, as will be seen from the following figures:—

1902	265	cars imported	1906	1433	cars imported
1903	267	" "	1907	1017	" "
1904	605	" "	1908	1387	" "
1905	1054	" "			

The exports rose from \$599,927 in value in the year 1902 to \$5,502,241 in 1907 with a falling off of \$5,277,847 in 1908.

—Beader, *Die Unmöglichkeit Dampfmaschinen auf gewöhnlichen Straßen mit Vorteil einzuführen* (Nuremberg, 1835); Badminton Library, *Motors and Motor Driving* (London, 1902); Beaumont, *Motor Vehicles and Motors* (London, 1900), and "Mechanical Road Carriages" (Cantor Lectures, London, 1895); Brander, *L'Automobile de 1822 à 1835* (Brussels, 1898); Farman, *Les Automobiles* (Paris, 1896), and *Autocars, Cars, &c.* (London, 1896); Fletcher, *Steam Locomotion on Common Roads* (London, 1891);

Gordon, *A Treatise on Elementary Locomotion by Means of Steam Carriages on Common Roads* (London, 1832, 1834 and 1836); Gore, *Propulsion of Carriages on Common Roads by Power other than Animal Power* (London, 1893); Graffigny, *Manuel pratique du constructeur et du conducteur de cycles et d'automobiles* (Paris, 1900); Grand Cartaret, *Le Voiture de demain* (Paris, 1898); Gray and others, *The Motor Year Book* (London, 1905 and 1906); Guerdon, *Manuel pratique du conducteur d'automobiles* (Paris, 1897); Gurney, *Steam Carriages on Turnpike Roads* (London, 1832); Hancock, *Steam Carriages on Common Roads* (London, 1838); Jenkins, *Power Locomotion on the Highway* (a guide to the literature; London, 1896); E. H. Knight, *American Mechanical Dictionary*, "Road Locomotives," vol. iii. (New York, 1876); J. H. Knight, *Notes on Motor Carriages* (London, 1896); Lardner, *The Steam Engine* (7th ed., pp. 419-440; London, 1840); Laverge, *Manuel théorique et pratique de l'automobile sur route* (Paris, 1900); Laverge and Hasluck, *Die Automobile* (London, 1902); Lieckfeld, *Die Petroleum- und Benzinmotoren* (Munich and Leipzig, 1894); Little, *Automotor and Horseless Vehicle Journal* (London, 1898); Lockert, *Traité des véhicules automobiles* (4 vols., Paris, 1896-1897); *Petroleum Motor Cars* (London, 1898); Maceroni, *Facts concerning Elementary Locomotion* (2nd ed., London, 1834); *Powers and Qualities of Maceroni's Steam Carriage Demonstrated* (London, 1835); *Steam Power on Roads, &c.* (London, 1835); Mann, *New Method of Propelling Locomotive Machines* (compressed air) (London, 1830); Merdurst, *A New System of Inland Conveyance for Goods and Passengers* (compressed air) (London, 1827); Milandre and Bouquet, *Traité de la construction, de la conduite et de l'entretien de voitures automobiles* (4 vols., Paris, 1898-1899); O'Gorman, *Motor Pocket Book* (London, 1904); Perissé and Godfrenaux, *Traction mécanique sur rails et sur routes* (Paris, 1900); Rose, *A Record of Motor Racing* (London, 1909); Salomons, *The Horseless Carriage* (London, 1895); Saunier, *L'Automobile théorique et pratique* (2 vols., Paris, 1899-1900); Sennett, *Horseless Road Locomotion* (London, 1900); Smith, *History of English Carriages and Motor Cars* (Tunbridge Wells, 1876); S.P.T.A. (Self-Propelled Traffic Association), *Trials of Motor Vehicles for Heavy Traffic* (Liverpool, 1898, 1899, and 1901); Sir H. Thompson, *The Motor Car: its Nature, Use, Management* (London, 1902); Wallis-Taylor, *Motor Cars or Power Carriages for Common Roads* (London, 1897); R. B. Whitman, *Motor-car Principles* (New York, 1909); Witz, *Moteurs à gaz et à pétrole*, vol. iii. (Paris, 1899); Yarrow, "On Steam Carriages," *Proc. Soc. of Eng.* (London, 1863); Young, *The Economy of Steam Power* (London, 1860); Filson Young, *The Complete Motorist* (London, 1904); vol. xxvii. of "Steam Locomotion on Common Roads," *Proc. Inst. C.E.* (London, 1873); Reports of Select Committees of the House of Commons (London, 1831, 1834, 1835, 1836, 1859, 1873, 1881). (C. S. R.)

HEAVY COMMERCIAL VEHICLES

Heavy types of motor-cars are now widely employed for commercial purposes. The earliest British-built type was the steam-propelled wagon, and its evolution was largely encouraged and hastened by important competitive trials, at Liverpool, in the years 1898, 1899 and 1901, which were conducted by the Self-Propelled Traffic Association. Other series of trials were held by the Royal Agricultural Society of England and the Royal Automobile Club.

From the end of 1896 to early in 1905 no commercial motor vehicle was legal in England if its unladen weight exceeded 3 tons, and this limitation caused much financial loss to purchasers who overloaded them. The Heavy Motor Car Order of 1904, which came into force on the 1st of March 1905, increased the maximum unladen weight to 5 tons, whilst limiting the gross weight to 12 tons; by the same order, the combined unladen weight of a motor wagon and the single trailer which it is allowed to draw was fixed at 6½ tons. In effect, the gross weight of a trailer and its load may not exceed 8 tons, thus yielding a total gross weight, for loaded wagon and loaded trailer, of 20 tons. Excesses in any particular cause a commercial motor to be treated as a "heavy locomotive," or traction engine, when its freedom of movement, speed, &c., are restricted more severely.

Miniature traction engines, constructed to comply with the requirements of the Motor Car Acts and Orders, have progressed since 1905; they are chiefly used where it is a convenience to separate the power and carrying units, as by furniture-removal and other contractors.

The working cost of a steam wagon with a 5-ton load, in Great Britain, inclusive of provision for interest on capital, depreciation and maintenance, varies from 7½d. to 9d. per mile

run, on an average basis of 180 m. a week; with a trailer carrying another 3 tons the corresponding figures vary from 9d. to 1s. per mile run, according to nature of roads, gradients and fuel available. The inclusive working cost of a tractor, on macadamized roads, is generally about 15% less than for a 5-ton wagon, but a standard tractor cannot haul more than a gross load of 8 tons behind the drawbar—except on dry and level roads. On granite sets the extra vibration often causes undue wear and tear, unless the suspension of the tractor be very good.

Vehicles in which the power is derived from internal-combustion engines are commonly known as "petrol" vehicles. Petroleum spirit of 0.70 specific gravity is usually the fuel, but many are now supplied with spirit of 0.760 specific gravity; the range of boiling points is the criterion of satisfactory use—not the density. Petrol vehicles are, practically, stoutly-built motor-cars, and some of the models now in use have been developed from accepted designs of lighter types. There are, however, numerous manufacturers who construct solely for utility purposes. Below net loads of 2 tons, the petrol-propelled vehicle

Summary of Working Costs for Petrol-driven Vehicles (Exclusive of Management) in England.

Particulars.	Net loads carried: Costs in pence per vehicle-mile.				
	10 cwt.	1 ton	2 tons	3 tons	5 tons
(Petrol at 10d. per gall.) Average weekly mileage	400	400	390	350	300
Driver's wages	0.84	0.84	1.00	1.09	1.60
Fuel (petroleum spirit)	0.55	0.77	0.95	1.25	1.67
Oils and grease	0.12	0.12	0.14	0.16	0.24
Rubber tires	0.50	0.75	1.15	1.50	2.60
Repairs (material and wages)	0.55	0.85	1.03	1.17	1.55
Rent, rates and lighting	0.12	0.15	0.25	0.40	0.50
Insurance and claims	0.12	0.24	0.35	0.42	0.65
Depreciation	0.65	0.90	1.06	1.36	1.60
Interest on capital	0.15	0.25	0.33	0.47	0.64
Totals	3.60	4.87	6.26	7.82	11.05

has a virtual monopoly of use in England; above that, it shares the trade with steam. A tabular statement of current working costs of approved petrol vehicles is published herewith.

Before proceeding to describe and illustrate representative types of vehicles, tractors and special machines, a brief summary of the outstanding points in the English statutes and orders which apply to heavy motor-cars may well be given. Any motor-car with an unladen weight in excess of 2 tons is held to be a "heavy motor-car," and a "trailer" means a vehicle drawn by a heavy motor-car. The expression "axle weight" means the aggregate weight transmitted to the surface of the road or other base whereon the heavy motor-car or the trailer moves or rests by the several wheels attached to that axle when the heavy motor-car or trailer is loaded. The expression "weight," in relation to a heavy motor-car or trailer when unladen, means the weight exclusive of the weight of any water, fuel or accumulators used for the purpose of propulsion. All heavy motor-cars have to be registered with a county council, county borough, or other registering authority, and owners have to declare, on suitable forms, the unladen weight, the axle weight of each axle, and the diameter of each wheel. When a registration certificate is issued it bears these data, in addition to a statement of the width and the material of the tyre on each wheel, and the highest rate of speed at which the heavy motor-car may be driven. The owner, after registration, must cause to be painted, or otherwise plainly marked, upon some conspicuous part of the offside of the heavy motor-car, the registered weight unladen, and the registered axle weight of each axle, whilst, upon the near side of the heavy motor-car, he must similarly cause to be painted the highest rate of speed at which it may travel. Width of tyres, which in no case may be less than 5 in., varies in relation to imposed load and wheel diameter, and a table of these is issued by the local government board. It is specified that "the width shall not be less than that

number of half-inches which is equal to the number of units of registered axle weight of the axle to which the wheel is attached." Taking a wheel 3 ft. in diameter as a basis, the unit of registered axle weight is $7\frac{1}{2}$ cwt.; this unit increases in the proportion of 1 cwt. per 12 in. increase of diameter, and decreases at the rate of 1 cwt. for every 6 in. reduction in diameter below 3 ft. The speeds at which heavy motor-cars may travel vary from 5 m. an hour to 12 m. an hour. Heavy motor-cars fitted with tires of a soft or elastic material may travel at higher rates of speed than if they were not so fitted.

Any motor-car used for trade purposes, but whose unladen weight does not exceed 2 tons, is allowed to travel as fast as 20 m. an hour, and is regarded as an ordinary motor-car.

Motor-buses.—The first double-deck motor-bus, of the type of which upwards of 1000 are in regular service in London, was licensed by the police authorities in September of 1904. The type of chassis employed is practically identical with those used for loads of 3 tons in the goods-haulage branches of the industry, and the accompanying chart, which is prepared from

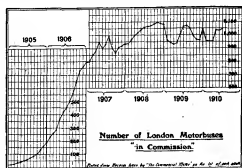

data exclusively collected by the *Commercial Motor* (London), indicates the growth in the totals since the inception of this departure in the public conveyance of passengers. The growth of motor-bus traffic has resulted in the displacement of some 25,000 horses and 2200 horse omnibuses, during the five years ending the 30th of June 1910, and it is estimated that there will be practically no horse omnibuses in London, except upon a few suburban routes, by the end of 1911. The inclusive working cost of a London motor-bus, with good management, varies

between 9d. and 10d. per mile, which figures cover interest, depreciation and administration.

Successful provincial motor-bus undertakings, in the United Kingdom, are numerous, and those at Eastbourne, Keighley and Hull may be particularly mentioned of municipal undertakings, whilst the Great Western Railway Company alone has 130 such vehicles at work.

Motor-cabs.—Spasmodic efforts to introduce motor-cabs in London were made during the years 1905 and 1906. It was, however, only in the month of March 1907 that the General Motor-cab Company put the first 100 vehicles of its present large fleet into regular service. The growth of motor-cabs is indicated by the following numbers, for which the author is indebted to the *Commercial Motor* (London), and these are of vehicles licensed at the dates given: December 31, 1905, 19; December 31, 1906, 96; December 31, 1907, 723; December 31, 1908, 2805; April 30, 1909, 3203; April 30, 1910, 4941. It is estimated that, at the 30th of June 1910, there are only 1200 horse-drawn hansoms in regular use, and not more than 2500 horse-drawn four-wheelers, in London. In 1904 London had a total of 11,055 horse-drawn hackney carriages, and two self-propelled hackney carriages. The London hiring rate for motor-cabs fitted with taximeters is: for the first mile or part thereof, 8d., subject to an additional charge at the rate of 2d. per $2\frac{1}{2}$ minutes for any waiting time or travelling below the rate of 6 m. per hour; 2d. per additional 440 yds., or $2\frac{1}{2}$ minutes of waiting or of travelling below 6 m. an hour; with the addition of 2d. per package for any package carried outside, and 6d. for a bicycle and 6d. each for each passenger above two, for any distance. The horse-drawn hansom-cab is 1s. for the first 2 m., with 6d. for each additional mile or part of a mile, and with a charge of 8d. per 15 minutes of waiting, after the first 15 minutes completed. Taximeter cabs cannot be engaged by time in London, but horse-drawn cabs may be so engaged at 2s. 6d. per hour for a hansom, and at 2s. per hour for a four-wheeler. The taxicab rates apply throughout the Metropolitan Police area, which in some directions extends as far as 20 m. from Charing Cross, but horse-vehicle rates (except those of time) are doubled for any distance beyond a four-mile radius.

Steam Vehicles.—Steam wagons may, generally speaking, now be divided into three distinct types, and these are distinguished chiefly by the particular form of final drive adopted by the designer. There are in general use by the well-known

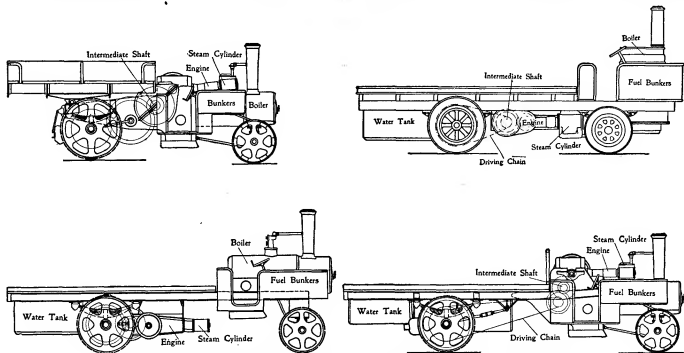

FIGS. 6-a.—Standard and Representative Types of Present-day Steam-wagon Construction.

makers, at the present day, only three methods of effecting such a drive: (1) by means of spur or double-helical gear to a live back axle, as illustrated in figs. 6 and 7; (2) with two side chains transmitting the drive from a differential intermediate countershaft to the wheels on a fixed back axle, as shown in fig. 8; and (3) by means of a single chain transmitting the drive from an intermediate shaft to a differential gear on a live back axle, as depicted in fig. 9.

The transmission on the first type of vehicle (figs. 6 and 7) is by means of gearing throughout, and is completely enclosed, thus ensuring protection from dust, and more perfect lubrication. Change gears to give two speeds are provided. This form of drive necessitates a special disposition of the spring mounting, in order to ensure that there shall be no sliding motion taking place between the teeth of the reducing gear, due to the distance between the centres of the countershaft and the back axle varying with the changes in the spring deflexion. The gear drive offers advantages which, for heavy loads, are not offered by any other form of drive.

The features which are common to all steam wagons of the second of these types are: vertical fire-tube or water-tube boiler; horizontal compound engine; two-speed gear; differential countershaft; and two sprockets which transmit the final drive, through chains, to the rear road wheels. The exact form which the boiler takes is a point which has considerably exercised the ingenuity of individual designers, in order to arrive at one that can be cheaply produced,

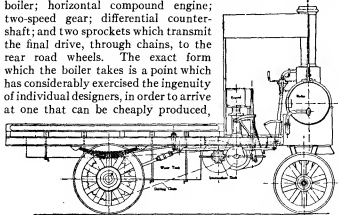

FIG. 10.—The Unique Type of Steam Wagon made by the Yorkshire Patent Steam Wagon Co.

efficient, simple of construction, easy to clean and repair, strong and reliable, and one which will not prime. The vertical type of boiler lends itself admirably to the general design of a steam wagon, because it takes up so little of the total length of the vehicle, whilst the fittings can be mounted in much more accessible positions than are possible with the majority of loco-type boilers. The efficiency is not, however, so high as is the case with the latter type. It may be generally stated that boilers of the vertical class, as used on 5-ton or 6-ton steam wagons, have a total heating surface of about 90 to 95 sq. ft., with about 4 sq. ft. of grate area, and the working pressure is from 200 lb to 225 lb per square inch. The usual and necessary fittings include: pressure-gauge; two safety-valves, two check-valves, and a blow-off cock. The feed water is normally supplied to the boiler by a plunger pump driven from the crank-shaft. The compound engine has all the valve motion completely enclosed and running in an oil-bath, and is provided with means whereby high-pressure steam can be supplied to the low-pressure cylinder, in order that extra power may momentarily be obtained. The change-speed gear pinions, cut from solid steel, are most often mounted on an extension of the crank-shaft, and mesh with machine-cut gear wheels which are mounted on the intermediate shaft, on which the differential gear is also mounted. The gears provide for two ratios of reduction from engine to road wheels; the higher one is for all ordinary running, and the lower one is for steep hills or for very bad roads. The outer ends of the differential shafts are fitted with chain sprockets, from which the drive is taken to the back wheels by means of chains.

The third type (fig. 9) of steam wagon is particularly business-like in appearance, and sound in construction and design. It

is the outcome of many years' experience in the design of road locomotives, on the lines of which it is constructed. The loco-type of boiler is very economical in fuel consumption, and is a very efficient steamer. Comparing this type of boiler with the vertical type, the former can be made of a much lighter construction for a given rate of evaporation, and the smoke-box door at the forward end offers a most simple and easy means of access to the smoke tubes for cleaning purposes. No vertical boiler offers such ready means of effecting this operation. The engine, which is mounted over the boiler in this type, is in full view of the driver, and, should it become necessary to make any repair or adjustment when on the road, this can easily be effected without grovelling under the wagon or removing any of the load. Objection may be raised to the position of the engine, on the score of its necessitating such a long chain drive to the back axle; this objection has not been sustained in practice, as many wagons employing this form of drive have been running for lengthy periods without giving any trouble on that score. The engine, which is a compound one, is close up to the source from whence it is supplied with steam, and consequently receives the steam in a much drier condition; there is less condensation in the main steam-pipe, because the length of this is reduced to a minimum. The short steam-pipes should tend to lessen the risk of their being broken from the sagging or twisting of the frame, a fault which is not unknown with vehicles having the engine a considerable distance from the boiler. This type, like types 1 and 2, also has two change-speed pinions, mounted on an intermediate shaft. These pinions may be of the sliding type, or may be operated by means of dog-clutches. The pinions mesh with two wheels that are mounted on a countershaft, on which is also fixed a chain-sprocket, from which the drive is transmitted, through a long chain, to a chain-wheel surrounding the differential gear mounted on the back axle. Traction-engine type of steering gear, with revolving fore-carriage, is most generally adopted, and is rendered sufficiently rapid in its movement by suitable gear, operated by a diagonal shaft and wheel, from the driver's footplate.

Fig. 10 shows the general disposition of the main parts of a "Yorkshire" steam wagon. This machine follows the general lines of those of type 3, so far as transmission gearing is concerned, but its boiler is of very distinctive construction, as may be seen from the sectional view in fig. 11; its engine is one of the vertical compound type, and is mounted directly behind the driver.

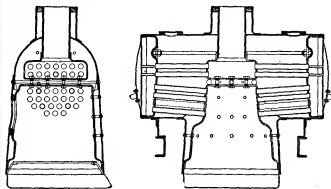

FIG. 11.—The Yorkshire Steam Wagon Co.'s ingenious Loco-type Transverse Boiler.

The Sheppey steam-wagon, or "steam-gas" vehicle as it is sometimes termed, on account of the high degree of superheat to which the steam is raised, and which superheat gives to the steam many of the characteristics of gas, is shown in fig. 24, and, it may be seen, this wagon is entirely dissimilar to any other machine with which this article deals. The generator and paraffin burner are housed within a "bonnet," and the temperature of the steam is controlled by a very simple form of thermostat. After leaving the engine, some of the heat in the exhaust steam is utilized to heat up the feed water before it is passed into the generator; the steam then passes in series through two condensers—one in front and one underneath the vehicle.

Another vehicle which embodies many novel and practical features is the new Leyland steamer, the construction of which includes one of the well-known Leyland fire-tube boilers, as shown

in fig. 18, a three-cylinder, single-acting, vertical engine, and an all-gear drive to the rear wheels.

Boilers.—The locomotive type of boiler is shown diagrammatically in figs. 12-15. The first of these four diagrams illustrates the

of heat is provided in the mass of the heated tubes, and the rapidity of flame application by the burner, and not in a mass of heated water. The steam, too, is very highly superheated, and necessitates the use of a specially-designed engine with mushroom valves.

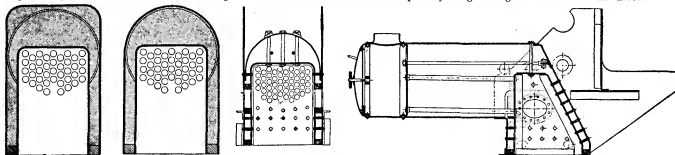

FIGS. 12-15.—Fig. 12 shows the Belpaire type of fire-box construction as compared with the more usual type shown in fig. 13. Fig. 14 and fig. 15 show the form of locomotive boiler fitted by Sidney Straker & Squire, Ltd. The back of the fire-box is sloped so as to accommodate the gear shafts without unduly lengthening the frame.

Belpaire type of fire-box outer shell, and, by its side fig. 13 shows the older form of construction. The Belpaire fire-box is a development of recent years, and its undoubted superiority over the older type is meeting with increasing recognition amongst boiler makers. The sloping back plates of the fire-box, as shown in fig. 15, are intended to give plenty of room for the housing of the change-speed gearing without undue lengthening of the vehicle or reduction of the area of the fire-grate.

Fig. 19 shows one form of paraffin burner, which type is used in conjunction with semi-flash boilers. The fuel is first vaporized, by being passed through a heated coil.

Steam Engines for Vehicles and Tractors.—The Bentley superheated steam engine, which is fitted to Colonel Crompton's tractor, is shown in fig. 20.

It has four high-pressure cylinders, and four in which low-pressure steam is operative. In a number of tests which were made

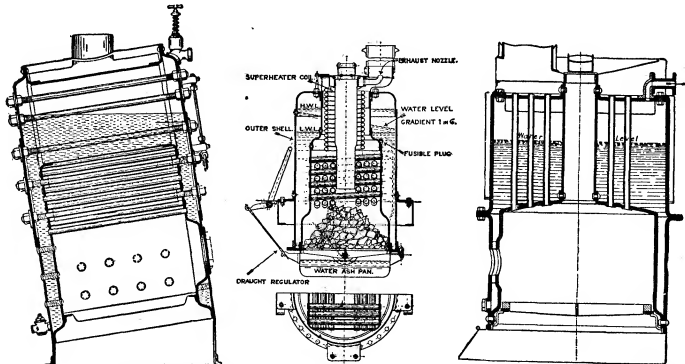

FIGS. 16, 17, 18.—Fig. 16 shows the Toward Vertical Boiler, fig. 17 Alley & MacLellan's Sentinel Water-tube Boiler, and fig. 18 the Vertical Smoke-tube Boiler fitted on Leyland Steam Wagons. The smoke tubes in the last-named boiler are provided with copper sleeves to prevent corrosion.

FIGS. 16, 17 and 18 show vertical boilers made, respectively, by Toward, of Newcastle, Alley & MacLellan, of Glasgow, and the Leyland Co., of Leyland. The smoke tubes of the last-named boiler are provided with copper sleeves, the object of which is the prevention of corrosion of the outer surfaces of the tubes. All-copper tubes have been tried, but they are too soft to withstand the abrasive action of the fine particles of coke which are ejected from the fire.

In flash or semi-flash boilers, or steam generators, such as are fitted by the Darracq-Serpolllet Co., the Sheppee Motor Co., of York, and to the tractor made to the designs of Colonel Crompton, C.B. (fig. 26), only a very small volume of water is at any time in the tubes. The tubes are exceptionally strong and thick, and they are made of cold-drawn steel; the water is only forced into them stroke by stroke of the engine. The essential difference between this class of generator and any ordinary motor-wagon boiler, whether of the water-tube or fire-tube patterns, is that the reserve

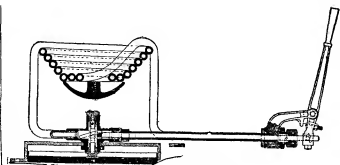

FIG. 19.—The Lune Valley Paraffin Burner.

with an engine of this type it was found possible to work it on an expenditure of 13 lb of water per brake-horse-power hour. Another interesting superheated steam engine is the two-

type does not necessitate the fitting of eccentrics; the second system entails the use of one eccentric for each cylinder; whilst Stephenson's system necessitates the provision of two eccentrics per cylinder.

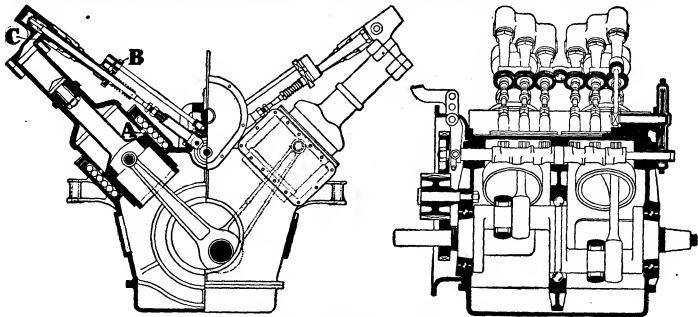

FIG. 20.—The Bentley Eight-cylinder Diagonal Tandem-compound Superheated-Steam Engine.

cylinder, double-acting engine made by the Sheppee Co., and illustrated in fig. 21. In this engine the cam-shaft by which the steam and exhaust valves are operated is situated midway of the cylinders' length, and is driven by bevel gearing from the crank-shaft. Fig. 22 shows a combined steam and hand-operated water pump, for use in conjunction with either of the engines mentioned.

Steam Tractors.—The great popularity which the light steam tractor enjoys is undoubtedly due to its extreme usefulness in cases where the employment of steam wagons could not prove remunerative. For brickmakers, builders, market gardeners and a host of others whose business demands that separate loads of heavy material must be moved from place to place without involving terminal delays, the tractor offers a simple and ready means of attaining the desired end. The first cost is comparatively low, and such a "steam horse" can be kept constantly at work if there is sufficient demand. A steam tractor is economical and efficient; it can be used on roads where a steam wagon would be impracticable on account of its

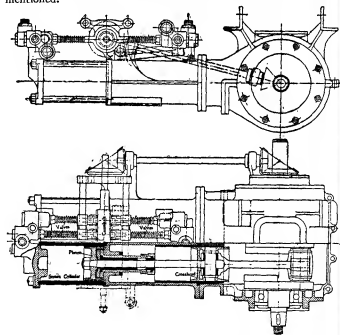

FIG. 21.—The Sheppee Motor Co.'s compact Double-acting Superheated "Steam-gas" Engine.

The Sentinel wagon, built by Alley & MacLellan, Ltd., is perhaps the only heavy steam wagon with a two-cylinder, simple, double-acting engine controlled by cam-actuated poppet valves; this engine is shown in section in fig. 23, and, in some respects, it greatly resembles the Sheppee engine.

The four special engines already named—those by Leyland, Bentley, Sheppee and Alley & MacLellan—differ totally from the type which is fitted most usually on steam-propelled commercial motors, yet they are very practical examples of special practice. The majority of steam vehicles are provided with two-cylinder compound engines, in which the steam distribution is effected and controlled by one or other of the proved link motions, such as the Joy, the Solms or the Stephenson. The first-named

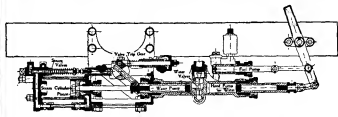

FIG. 22.—The Sheppee Combined Steam-driven or Hand-operated Water-pump.

great axle weight, and, when not used for hauling, it can be put to other work such as driving pumps or builders' machinery, or for a host of other purposes requiring a portable power installation. The fact that the motor is separate from the wagon, or trailer, which conveys the load, and can haul a loaded trailer to its destination, leave it, and return with, or for, another loaded trailer, without waiting for the first load to be unshipped, not only makes this class of motor extremely useful to agriculturists and others, but it makes for greater efficiency, in a large number of cases, because the power unit is not allowed to stand idle during the loading or unloading operations. Another vital point is the low annual cost of maintenance.

Since the passing of the 1903 Motor Car Act, and the coming into force of the 1904 Heavy Motor Car Order, many of the well-known makers of road locomotives have turned their attention to the production of a machine which would come within the prescribed constructional limits, and would meet popular demand. These machines are built on proved traction-engine lines, but with all the parts of suitably reduced size so far as is consistent with strength and the work which the machines are

called upon to perform. The locomotive type of boiler, with large fire-box, a heating surface of about 65 sq. ft., and a grate area of some 3 sq. ft., is used by the leading makers.

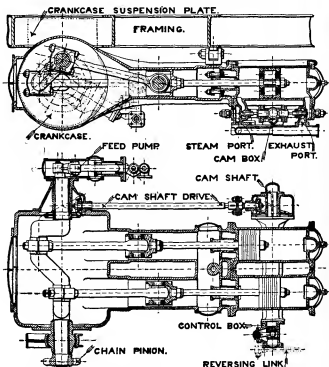

FIG. 23.—Alley & MacLellan's Twin-cylinder Steam-engine as fitted to the Sentinel wagons. The steam and exhaust ports are operated by a cam-shaft.

Some of the early tractors were fitted with single-cylinder engines, but, although this type is still supplied by several makers, the more general practice is to provide a compound engine, with a multiplying valve which admits high-pressure steam into the low-pressure cylinder, thus enabling the engine to develop considerably more than its normal power for short periods. The engine is mounted over the boiler, with its crank-shaft at right angles to the axis of the barrel. Two changes of gear ratio are usually provided; one for normal running, and a lower one for very soft ground or steep hills. The driving axle is of the differential or live type, and provided with means for locking the compensating gear and rendering it inoperative

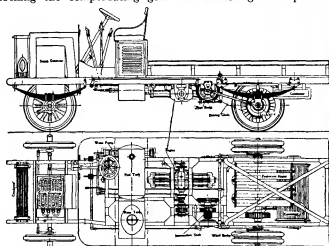

FIG. 24.—The Sheppey "Steam-gas" or Superheated Steam Vehicle.

when necessary, as would be the case if one driving-wheel were on hard ground and the other one on soft or greasy ground. A winding-drum is fitted, and this may be driven by the engine without, at the same time, driving the tractor: this result is

attained by making the drum free on the axle but providing means of securely locking it thereto when desired. A flywheel generally fitted to one end of the crank-shaft, and this may be used for driving external machinery.

Many makers have recently given much attention to the improvement of the spring-suspension systems of their respective machines, and chief amongst these is William Foster & Co., Ltd., of Lincoln, in which company's "Wellington" tractors the effective spring base has been so vastly increased that it may safely be termed the most stable of steam tractors. The life of all the working parts of a tractor may be considerably lengthened by the elimination of road shocks, or the prevention of their transmission, through the gearing, to the engine and the boiler plates. Foster's tractor is illustrated, in diagrammatic form, in fig. 25.

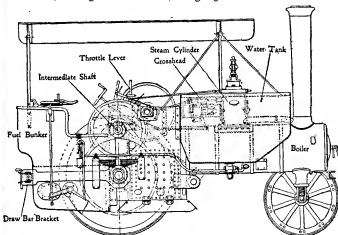

FIG. 25.—Foster's "Wellington" Compound Steam Tractor with outside spring suspension.

An ingenious machine of the tractor class is that built to the designs of Colonel Crompton, and shown in fig. 26. This machine is intended for military purposes, or for operation in undeveloped countries. Steam generated in a "semi-flash" boiler, and is used expansively in a four-pair, diagonal-compound engine of the type shown in fig. 20. A two-speed epicyclic gear is enclosed by the flywheel casing, and the power is then transmitted, by worm gearing, to a differential countershaft, and from sprockets on the ends of this shaft the drive is finally transmitted to the 7 ft. diameter road wheels by means of side chains. In this tractor, very long bearing springs are employed, and these are situated below the axle, so that, instead of the springs resting on the axle boxes, the whole frame and the power plant is suspended from the axle boxes. When hauling a load, the winding cable is permanently secured to the drawbar, and when the machine becomes "bogged" or is otherwise unable to haul its trailer directly by the drawbar, a single bolt may readily be removed from the drawbar, and the winding cable may then be paid out as the tractor proceeds alone. The trailer may then be hauled up by means of the cable. The average of a number of tests with this machine, made while hauling a gross load of 8 tons, showed that its burners consumed from .65 to .85 of a gallon of shale oil for each mile travelled, and that the consumption of water was at the rate of 5 gallon per mile. The gross weight of the machine, with sufficient fuel and water for well over 100 m. of running, is about 7 tons.

Vehicles Driven by Internal-Combustion Engines.—The general principles of the working of a steam engine are better understood than are those of the gas or oil engine, owing to the wide use of the former class of prime mover since the early part of last century, but it is beginning to dawn upon the public at large that the internal-combustion engine, or the "petrol" motor, as it is more popularly termed by those who talk or write about motor vehicles, is even more simple than the steam engine.

The fundamental reason for the use of the words "internal combustion" is that the fuel, in the case of the petrol engine, is burnt (or fired) inside the working cylinder, whereas it is burnt externally in the case of a steam engine, i.e. underneath the boiler or generator. The number of units of heat which can be turned into useful work is very much greater in the case of internal combustion than of external combustion, the efficiency of the petrol engine in this respect being, on the average, about three times as great in practice as is found to be the case with typical steam engines other than those where highly superheated

steam is used, and where the whole of the parts are maintained in the best condition. The amount of petroleum spirit, or of paraffin, required to propel a steam vehicle 1 m. would, other conditions being equal, propel a vehicle fitted with an internal-combustion engine over a distance of 3 m.

The essential parts of any internal-combustion system are: the carburetter; the engine; the radiator; the clutch; the change-speed gears and the final transmission. The carburetter is a vessel in which the liquid fuel is converted into a combustible gas or vapour, for, as there is no connexion to any gas main, the ordinary petrol engine has to make its gas "on the premises." The production of the gas is automatic, and calls for practically no attention from the driver, because, once the engine is started, the necessary aspiration to draw through the correct quantities of air and fuel is provided by the action of the valves and pistons.

A smart turn of the starting handle is required to set the pistons and crankshaft in motion, so that an initial supply of the combustible mixture may reach one of the cylinders. This first charge of gas is automatically ignited by an electric spark, the current for which is furnished and controlled without the necessity for any hand regulation, and there is then nothing

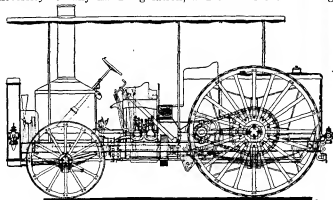

FIG. 26.—Colonel Crompton's Superheated Steam Tractor.

further for the driver to do, as regards power, except to move a convenient lever which opens or closes a "throttle" valve between the cylinders and the carburetter.

An internal-combustion engine would get very hot if no precautions were taken to cool it, and it is usual to surround the cylinder with water spaces. These spaces are called jackets, and the water is forced through them, either by a pump or by thermo-siphon (natural circulation) action. It is expedient to keep down the weight of water, and for that reason pipes, tubes or small boxes are built up in such a manner that a large cooling surface is exposed to the air. A fan, which is driven from the crankshaft of the engine by gear or a belt, is employed to aid this cooling by reason of the increased volume of air that passes round the outside of the components of the radiator members. The general scheme is the same, both for heavy and light motor-cars.

It is very important that the driver should have a convenient means of separating the engine from the driving mechanism, and of putting the two in connexion again, whenever it becomes necessary, without jar or shock. The common practice is to use a leather-faced, circular member with a coned face, and to control the amount of "grip" between this member and a corresponding enclosing member attached to the engine fly-wheel by means of a pedal and springs. When the driver wishes to disengage the two members, he has merely to depress the foot lever. It will be clear that a clutch of this description can be made to engage without any difficulty, there being no fixed positions or steps such as one associates with the ordinary jaw-clutch, and this gradual application of the load can only be accomplished by the aid of two or more surfaces in frictional contact, and by the holding together of these surfaces by the pressure of one or more strong springs. The Hele-Shaw multiple-disk clutch gives very good results, and is easy for drivers to use in traffic.

An internal-combustion engine cannot develop power unless

the crank-shaft can rotate at a relatively high number of revolutions, and the rate of doing work is lowest when the angular velocity is at its minimum. It is, therefore, necessary to introduce a system of levers between the engine and the road wheels, in order to permit the number of revolutions of the crankshaft to be maintained when hill climbing, or when the vehicle is carrying a heavy load, and the common practice is to introduce

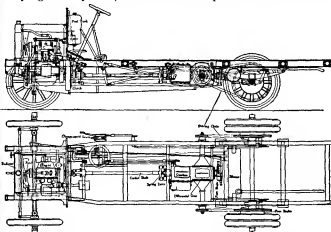

FIG. 27.—The well-known 16 h.p. Two-ton Albion Chassis.

three or four sets of different sizes of toothed wheels, any pair of which can be put into engagement by the movement of a single lever, which lever is placed near the driver's right hand as a rule. The lowest of these gear ratios, *i.e.* the one which allows the crankshaft to make the greatest number of revolutions to one revolution of the road wheels, is required for starting purposes, and the highest gear ratio, *i.e.* the one which allows the road wheels to make the greatest number of revolutions in relation to those of the crankshaft, is employed for high-speed travelling on the road. From the last change-speed shaft the power must be transmitted to the road wheels through a differential gear and through one or other of the types of final drive which are now employed by representative makers. The great distinction from the axle of a horse-drawn vehicle is that there must be both a mechanical connexion, yet a differential action, between the two back wheels. The wheels on horse vehicles revolve loosely on the axle, and one can overrun the other at curves, but the special device known as the "differential gear" has to be introduced into all motor vehicles between the

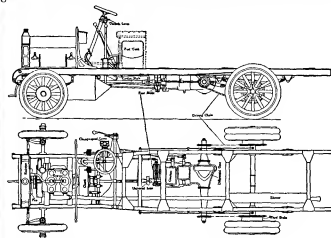

FIG. 28.—Halley's Van or Lorry Chassis with 20 h.p. Engine.

change-speed gears and the driven road wheels. Such a device permits one of the two driving wheels to be driven round at a quicker angular speed than the other, the difference being determined by the radius of the curve around which the vehicle is turning.

The most common form of final drive is, perhaps, that in which two "roller" or "silent" chains transmit the power from

sprockets on the ends of the differential shaft to chain rings which are bolted to the rear road wheels. Figs. 27, 28 and 29 show typical vehicles, ranging in load capacity from 30 cwt. to 6 tons, on which the side-chain method of final drive is adopted. One of the chief advantages of the side-chain drive lies in the fact that there is, with it, less weight below the springs than with any other form of final drive. The only parts below the springs are: the fixed back axle; the chain rings (bolted to the road wheels); the road wheels themselves; the road-wheel brakes and part of the weight of the chains. The differential gear and chain sprockets are carried in a countershaft casing, which is securely bolted to the main frame.

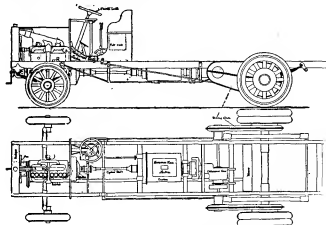

FIG. 29.—A typical Six-ton Petrol Wagon Chassis, by Commercial Cars, Ltd., Luton.

In a number of very successful vehicles the final drive is transmitted by means of spur pinions. These are mounted on the ends of bevel-driven differential shaft, and mesh with internally toothed or externally-toothed gear rings on the road wheels. Milnes-Daimler and De Dion commercial vehicles are amongst the machines on which the internally-toothed form of gear is employed, whilst Ryknield is the most representative vehicle embodying the externally-toothed form of final drive.

The direct drive, from the ends of the differential shaft, as is shown in fig. 30, is another type of final transmission that has met with a considerable amount of success, particularly on the Leyland machines of five-ton and six-ton capacity. The differential gear and the bevel-drive reducing gear are both enclosed within a casing that is bolted to a fixed back axle; the ends of the driving shaft pass through tunnels in the axle body; and claw pieces on the outer ends of the differential shaft engage with similar claws on the road-wheel hubs. The two last-named forms of gear are highly efficient, provided the pitch and shape of the teeth are carefully considered and the designs provide for the encasing of all the pinions and gear rings.

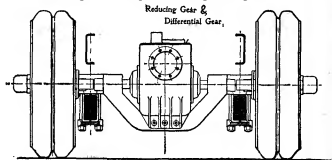

FIG. 30.—The Back Axle of the Leyland Six-ton Petrol Wagon.

The only other type of final drive which is used to any great extent for commercial motors is that which employs a hardened and ground steel worm meshing with a machine-cut phosphor-bronze worm wheel which is bolted to the differential-gear cage of a live back axle. The employment of this type of gear for the final transmission on commercial motors generally leads to

increased efficiency, on account of the ease with which all the parts can be enclosed in an oil-tight casing. It also gives silence of running. The strongest advocate of the worm drive for heavy vehicles is the Guildford manufacturer, Dennis Bros., Ltd., one of which company's machines is illustrated in fig. 31. Although there are many difficulties in the matter of the manufacture of worm gearing, they are not insurmountable, and, given proper attention at the hands of the designer, followed by

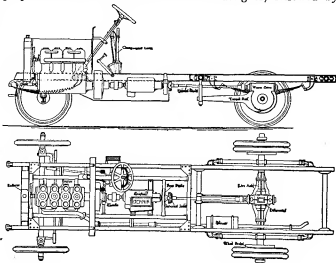

FIG. 31.—A typical Worm-driven Live-axle Chassis, by Dennis Bros., Ltd., of Guildford.

accurate workmanship, probably no other mechanical means of transmitting power can approach it for smooth and silent operation. Both thrust bearings on the worm shaft should be on one side of the worm, to avoid lack of truth in meshing if any heating occurs between the worm and the wheel. There are many examples of the worm drive to be found in London on public-service passenger vehicles, and also on delivery vans. One of the great charms of this type of transmission is that a very large gear reduction may be obtained without making the worm wheel unduly large in diameter; this is an important factor in the design of a back axle, as every inch of road clearance is of value for operating on rough country roads. As a large gear reduction is thus rendered possible on the back axle, it will readily be understood that the change-speed gear-box may be made considerably smaller than would be necessary for a bevel-driven live axle, where a large gear reduction is not permissible, both on account of its size and because such a gear would be very noisy in its working.

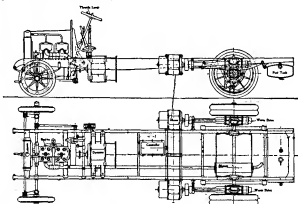

FIG. 32.—The Hallford-Stevens Petrol-electric Chassis.

Although the use of tooth wheels is still the only practical method of obtaining variable transmission for motor vehicles, the fundamental defects of transmission in this way are inherent to the system and must always be present; they are now less apparent, thanks to the remarkable improvement which has taken place in the use of suitable materials and improved design.

It is still the hope of some manufacturers that a form of infinitely variable change-speed device will be produced, which will

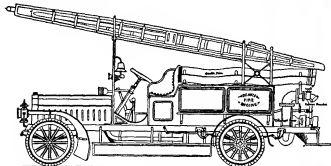

FIG. 33.—70 h.p. Six-cylinder Dennis Fire-engine with Gwynne Centrifugal Pump.

replace the step-by-step movement of toothed gearing; the two chief directions in which this has been attempted are electrical and hydraulic. Of these two, electrical devices are really

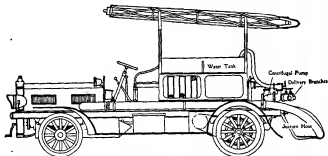

FIG. 34.—60 h.p. Six-cylinder Halley Fire-engine with Centrifugal Pump.

step by step, and the hydraulic method is apparently the only one that permits of infinite variation. Enormous sums of money have been spent in the search for an effective hydraulic

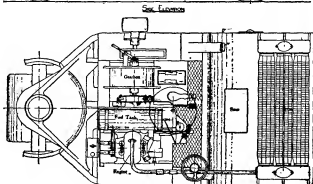
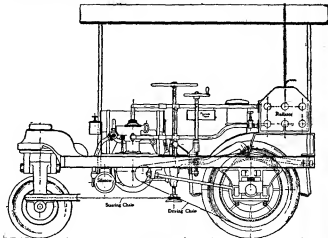

FIG. 35.—One of Barford & Perkins's Water-ballast Rollers. XVIII. 30

gear; the work of Hall, Pittler, Jannay, Hele-Shaw, Renault and others is, perhaps, the best known. It must be confessed, however, that in 1910 none of these gears could be said to be on the market for motor vehicles, although hydraulic gears were being successfully applied in connexion with other problems, such as the steering of ships, the movement of turrets, &c.

Electrical transmission systems, too, have been tried, and appear to have been attended with more success than those of the hydraulic type. Such systems include vehicles which carry heavy batteries of accumulators, the current from which is utilized for the driving of the vehicle by means of electric motors. Other variations include the Hallford-Stevens system, shown in fig. 32, in which it may be seen the petrol engine drives a dynamo, and the current is then caused to drive an electric motor at each side of the chassis. Each motor drives one of the

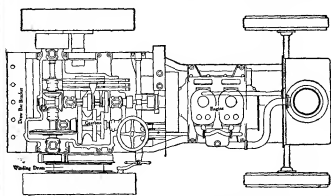
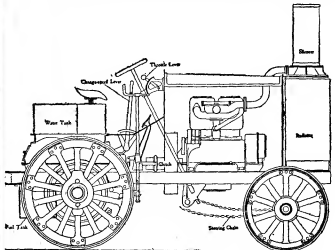

FIG. 36.—Marshall's 30 h.p. Agricultural Tractor.

back road wheels, through a worm and worm gear. The changes of vehicle speed are effected by altering the method of grouping the electrical windings of the dynamo and motor field-magnets and armatures. This system of control is known as the series-parallel, and is effected by a single lever, which actuates a mechanical switch, or "controller."

In one of the most-recently-introduced petrol-electric systems—the "K.P.L." system, as worked by the Daimler Co., of Coventry—each of the rear road wheels is provided with a separate power unit, consisting of a four-cylinder petrol engine, which is direct coupled to a dynamo, the armature of the latter being coupled to a worm which meshes with a worm wheel attached to the road wheel. A small electrical storage battery forms part of the system, and this receives the excess of current from the dynamo when the whole power of the engine is not required for the propulsion of the vehicle. When the machine is being driven up a steep incline, or when it is required to travel in a reverse direction, the battery may be called upon to supply current to the dynamo, and, in this manner, the power of the engine is augmented by the dynamo's working as electric motors.

Still another petrol-electric system is that invented by Mr Thomas. In this system, which is at the same time the simplest and most practical form of petrol-electric transmission, two dynamotors and an epicyclic gear are employed so that the electrical load is at no time greater than one half of the total load; consequently, the risk of a "burn out" of the windings, as the result of sudden and unforeseen periods of overload, is materially minimized.

Special Applications.—Amongst the special applications of the petrol-engined commercial vehicle is the motor fire-engine, which has brought to the front in this branch several enterprising motor manufacturers, amongst whom Dennis Bros., of Guildford, Halley, of Glasgow, and Leyland, of Preston, are prominent. The general construction of the chassis closely follows the lines of other petrol vehicles of equal load capacity, but the gear-box tail-shaft is prolonged to the after-end of the machine, and is direct-coupled to the rotary member of a multi-stage centrifugal pump. In the Dennis fire-engine, the vacuum which is necessary in order to lift the water in the suction hose is obtained by means of priming the pump chamber, further assisted by a water ejector and a small water tank which is carried on the machine. This machine is shown in fig. 33, whilst fig. 34 shows the successful motor fire-engine built by Halley's Industrial Motors, Ltd., of Yoker, Glasgow. In the latter machine, as also in the Leyland and other fire-engines which employ centrifugal pumps, the vacuum is created by means of reciprocating air pumps. These machines have given very satisfactory results in the hands of practical firemen, in various parts of the United Kingdom and abroad. Merryweather and Shand-Mason, who were formerly builders of steam fire-engines, now also build petrol-engined machines, these makers favouring reciprocating water pumps.

Other special applications of the internal-combustion motor are for grass mowing and rolling, and for road mending and rolling gravel paths, &c. One of the latter type of machines is shown in fig. 35. In this machine a petrol or paraffin engine

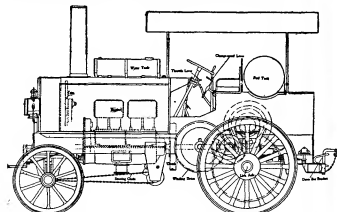

FIG. 37.—45 h.p. Thornycroft Military Oil Tractor.

drives a water-ballast roller through the medium of a clutch, a simple form of change-speed gear-box, and a single roller chain. The leading roller, by which steering is effected, is also filled with water, in order to obtain the dead weight necessary for rolling. Marshall, Sons & Co., Ltd., of Gainsborough, Thornycroft, of Basingstoke, and Broom & Wade, of High Wycombe, have also produced special machines for agricultural and military purposes, and one of the smallest tractors built by the first-named maker is shown in fig. 36. The engine is one of the two-cylinder type, consuming paraffin fuel, and driving the live back axle through a substantial gear-box and a final drive of the externally-toothed type. Such a machine is well below the weight limit for heavy motor-cars. Fig. 37 shows a more powerful oil tractor by Thornycroft. This machine is the same type which was so successful in the tractor trials promoted by the British War Department in March 1909. It is capable of hauling a gross load of seven tons practically

anywhere, and even of lifting that load vertically by means of its winding cable. The engine has four cylinders, and the fuel may be paraffin, alcohol or crude oil. (E. S. S.)

MOTRIL, a town of southern Spain in the province of Granada, at the foot of an offshoot of the Sierra Nevada and on the edge of a rich alluvial plain, about 1 m. from the Mediterranean and 40 m. S.S.E. of Granada, with which it is connected by a good carriage road. Pop. (1900), 18,528. The climate is semi-tropical, and the *regia* or plain of Motril has been found peculiarly adapted for the culture of sugar-cane and sugar-beet. In the district, and especially at Salobreña, 3 m. west, there are numerous sugar-factories; cotton is also grown and manufactured, and alcohol, flour, soap, iron goods and cotton stuffs are among the other industrial products. The neighbourhood is rich in zinc and lead; and copper is also found. Motril itself is a port of the second class, but the anchorage at Calahonda, $\frac{1}{2}$ m. south-east, is much better. Grapes, barley, esparto grass, dry figs, almonds and zinc are exported.

MOTT, LUCRETIA [COFFIN] (1793—1880), American reformer, was born at Nantucket, Massachusetts, on the 3rd of January 1793. She was descended on her mother's side from Peter Folger, one of the first settlers of Nantucket, and the grandfather of Benjamin Franklin; her father's ancestors, also, were among the first settlers of Nantucket. At thirteen she was sent to a Friends' boarding school, at Nine Partners, near Poughkeepsie, New York, where James Mott (1788—1868), who like her was of old Quaker stock and whom she married in 1811, was then a teacher. In 1810 James Mott entered the employ of Lucretia's father in Philadelphia, but the business was not successful and in 1817 Lucretia opened a small school under the care of the Pine Street Monthly Meeting, but gave it up a year afterwards and in the same year was recognized by the Friends as an "acknowledged minister." Her husband had as early as 1822 espoused the cause of Elias Hicks against the "Orthodox" Friends, and in 1827, when the Society divided, Lucretia joined the Hicksites. Hicks's teachings on slavery had impressed both James and Lucretia; in 1830 James gave up a lucrative cotton commission business that he might not profit from the products of slave labour; and both took an active part in the campaign against slavery. About 1840 Mrs Mott also took up the cause of woman's rights. On lecturing tours she and her husband travelled as far west as Indiana and into Maryland and Virginia. In 1848 she addressed the Anti-Sabbath Convention in Boston, and with Elizabeth Cady Stanton, whom she had first met in London in 1840, called a convention "to discuss the social, civil and religious condition and rights of women," which met at Seneca Falls and passed a "Declaration of Sentiments," modelled on the Declaration of Independence. Her husband, who was prominent among the founders of Swarthmore College (1864), died in Brooklyn, New York, on the 26th of January 1868; and Mrs Mott died on the 11th of November 1880 near Philadelphia.

See *James and Lucretia Mott: Life and Letters* (Boston, 1884), edited by their granddaughter, Mrs Anna Davis Hollowell.

MOTT, VALENTINE (1785—1865), American surgeon, was born at Glen Cove, New York, on the 20th of August 1785. He graduated at Columbia College, studied under Sir Astley Cooper in London, and also spent a winter in Edinburgh. After acting as demonstrator of anatomy he was appointed professor of surgery in Columbia College in 1809. From 1811 to 1834 he was in very extensive practice as a surgeon, and most successful as a teacher and operator. He tied the innominate artery in 1818; the patient lived twenty-six days. He performed a similar operation on the carotid forty-six times with good results; and in 1827 he was also successful in the case of the common iliac. He is said to have performed one thousand amputations and one hundred and sixty-five lithotomies. After spending seven years in Europe (1834—1841) Mott returned to New York and founded the university medical college of that city. He translated A. A. L. M. Vepeau's *Operative Surgery*, and was foreign associate of the Imperial Academy of Medicine of Paris. He died on the 26th of April 1865.

MOTTEUX, PIERRE ANTOINE (1663–1718), English translator and dramatist, of French parentage, was born at Rouen on the 25th of February 1663. After the revocation of the Edict of Nantes he settled in London with his kinsman and godfather, Paul Dominique Motteux. He acted as an auctioneer of pictures, and in 1706 he had a shop in Leadenhall Street for the sale of lace, stuffs, Chinese and Japanese commodities, duly advertised in the *Spectator* by his friend Richard Steele. He had not been six years in England when he obtained sufficient mastery of the language to edit the monthly *The Gentleman's Journal*, which contained verses by himself and by the chief wits of the day. In 1693 he edited the third book, hitherto unpublished, of Sir Thomas Urquhart's translation of Rabelais, and in the next year printed the first and second books of Urquhart's translation. In 1694 he completed Urquhart's work by a translation of the fourth and fifth books, which, although not to be compared with the racy, nervous writing of Urquhart, shows a perfect mastery of colloquial English and an intimate and adequate sense of Rabelais's meaning. The complete translation appeared in five volumes in 1693–1694, and was reprinted as *The Whole Works of Francis Rabelais, M.D.* (2 vols., 1708), described as the work of "Sir T. Urquhart, Knight, Mr Motteux and others." His first play, a comedy in five acts entitled *Love's Jest*, was produced at Lincoln's Inn Fields in 1696, and next year followed *The Loves of Mars and Venus*. He wrote other works for the stage of no great consequence. More important than his dramatic work is his *History of the Renowned Don Quixote de la Mancha* (4 vols., 1701; 2nd ed., 1712), "translated from the original by many hands and published by Peter Motteux," one of the most masterly and spirited translations in English. His later years appear to have been given to the shop in Leadenhall Street. He was murdered on the 18th of February 1718 at a house of ill fame in Star Court, near St Clement's Church, London, under circumstances which have never come to light. The manner of his death was no criterion of his life, which appears to have been sober and decent.

An excellent life of Henri van Laun is prefixed to the 1880 reprint (4 vols.) of J. G. Lockhart's edition of Motteux's *Don Quixote*. See also a prefatory note by Charles Whibley in vol. iii. of Sir T. Urquhart's *Rabelais* (Tudor Translations, 1900), reprinted from a rare 1693–1694 edition.

MOTTEVILLE, FRANÇOISE BERTAUT DE (c. 1621–1689), French memoir writer, was the daughter of Pierre Bertaut, a gentleman of the king's chamber, and niece of the bishop-poet Jean Bertaut. Her mother, a Spaniard, was the friend and private secretary of Anne of Austria, wife of Louis XIII. At the age of seven Françoise was also made a member of the queen's household and given a pension. The influence of Richelieu, however, who wished to separate the queen from her Spanish connexions, exiled mother and daughter to Normandy, where in 1639 the young girl was married to Nicolas Langlois, seigneur de Motteville, president of the Chambre des Comptes of Rouen. He died two years later at the age of eighty-two, and in 1642 the queen summoned Mme de Motteville to court, being now her own mistress by the death of Richelieu and Louis XIII. Through all the intrigues and troubles of the Fronde Mme de Motteville preserved the honourable reputation of being devoted to her mistress without any party ties or interests. Some letters of hers are preserved—especially a curious correspondence with "La Grande Mademoiselle" on marriage, but her chief work is her *Mémoires*, which are in effect a history of Anne of Austria, written briefly till the date of Mme de Motteville's return to court, and then with fullness. They give a faithful picture of the life of the court at that time.

The best edition of her *Mémoires* is that of M. F. Riaux (2nd ed., Paris, 1891, 4 vols.), containing an essay by Sainte-Beuve from vol. v. of his *Œuvres de lundi*. The *Mémoires* were translated into English in 1726 and again by K. P. Wormeley in 3 vols., 1902. For details concerning her family see *Recherches sur Madame de Motteville et sur sa famille*, by Charles de Beaurepaire (Rouen, 1900).

MOTTL, FELIX (1856–), German conductor and composer, was born near Vienna, and had a successful career at the Vienna Conservatoire. He became known as a gifted conductor

of Wagner's music, and in 1876 was engaged for the *Ring des Nibelungen* at Bayreuth. From 1881 to 1903 he was conductor at the Carlruhe Opera, and made a wide reputation for his activity there, particularly in producing the works of Wagner and Berlioz. In 1886 he directed the performance of *Tristan und Isolde* at Bayreuth. In later years he visited London and New York, and became known as one of the most brilliant conductors of his day; and in 1904 he was made a director of the Academy of Music at Berlin. He composed some operas, of which *Agnes Bernauer* (Weimar, 1880) was the most successful, and numerous songs and other music.

MOTTO (an Italian word, from Late Lat. *muttum*, a low sound, a mutter or murmur, cf. *mutere*, to mutter; the Latin word also gives Fr. *mot*, word), a "legend" consisting of a significant phrase or sentence, sometimes even of a single word attached to an emblem or device, and, in heraldry, placed on a scroll below the achievement or above the crest. Mottoes express sometimes a sentiment, a favourite principle, emphasize the meaning or symbolism of the emblem or device, and, in heraldry, often allude to one or more of the "charges" in the coat of arms, &c.

There are many publications which give lists of some of the best-known mottoes, such as Fairbairn, *Book of Family Crests*, 1856; Washbourne, *Book of Family Crests* (2 vols., 1882); Chassant and Tansin, *Dictionnaire des devises historiques et héraldiques*, &c. (1878); Dieltz, *Die Wahl- und Denksprüche, Feldgeschreie, Losungen, Schlächt- und Volkssprüche, besonders des Mittelalters und der Neuzeit* (4 vols., 1888). *Garfield's Guide to Printed Books and MSS. relating to Heraldry* (1892) contains a bibliography.

MOTYA, an ancient Phoenician settlement in Sicily, on a low island [mod. S. *Pantaleo*], 5 m. north of Lilybaeum [mod. *Marsala*]. It was the centre of the Phoenician trade in Sicily. It was accessible from the mainland by a mole, which is still used as a track for wagons. The line of the city wall, of rough rectangular blocks of stone without mortar, may still be traced all round the coast, with two gates, one on the north towards the mole, which is still in part preserved, and one on the south. The date of its foundation is uncertain. In 398 B.C. it was taken after a desperate struggle (which, owing to the height and strength of the houses, continued even after a breach had been made in the city wall) by Dionysius of Syracuse, but recovered in the next year: it was, however, abandoned by the Carthaginians, and its place taken by Lilybaeum on the mainland. (T. As.)

MOUCHEZ, AMÉDÉE ERNEST BARTHÉLÉMY (1821–1892), French astronomer, was born at Madrid of French parents on the 24th of August 1821. At the age of sixteen he entered the naval school at Brest, and after serving with distinction in various ships, was appointed in 1856 to the command of the "Bisson." Towards the close of the Franco-Prussian War he made an admirable defence of Brest, and his organization of the French expedition to the island of St Paul to observe the transit of Venus in 1874 obtained his election to the Academy of Sciences and his promotion as commander of the Legion of Honour. On the 27th of June 1878 he succeeded Urbain Leverrier as director of the National Observatory of Paris, and was raised to the rank of rear-admiral. The fourteen years of his directorship were marked by a great increase in the activity of the institution. The observatory grounds were enlarged; two powerful instruments of the novel kind known as *coude* equatorials were installed; a spectroscopic department was established, and the gigantic task of re-observing all Lalande's stars was completed. He published twenty-one volumes of *Annales*, as well as the first two volumes of the great *Catalogue de l'Observatoire de Paris*; founded the *Bulletin astronomique*, and set on foot two schools of practical astronomy, one at Paris, the other at Montsouris, for the special instruction of naval and military officers, explorers and surveyors. His most memorable work, however, was the inauguration of international operations for charting the heavens. The advances in stellar photography made by Paul and Prosper Henry and others suggested to him the magnificent idea of obtaining, through the collaboration of astronomers in all parts of the world, an

astrophotographic picture of the entire sphere containing more than fifty million stars, which should faithfully record in future ages the state of the sky at the end of the 19th century. Although he did not live to see its completion, he had the satisfaction of knowing that the ultimate success of this vast scheme was assured. He died suddenly at his country seat at Wissous, near Antony, on the 25th of June 1892.

See *Month. Notices Roy. Astr. Society*, liii. 226; *Observatory*, xv. 305 (D. Klumpke); *Nature*, xlv. 253; *Rapport annuel sur l'Observatoire de Paris pour l'année 1892*. (A. M. C.)

MOUFLON, or **MUFLON**, the wild sheep (*Ovis musimon*) of Corsica and Sardinia, where it is now very local. The ewes are either hornless or provided with quite small horns, the hornless form being probably characteristic of one island and the horned of the other. The rams carry good horns, and in summer show a conspicuous light saddle-shaped mark on the otherwise dark-coloured coat. The Armenian mouflon (*O. orientalis*), of Persia, Armenia, and the Tróodos range of Cyprus, is typically a larger and redder sheep, with the horns curving in the reverse direction; but the Cyprian race is small. (See **SHEEP**.)

MOULD. (1) (O. Eng. *molde*, from a Teutonic root meaning to grind, reduce to powder, cf. "meal"), loose fine earth, rich in organic matter, on the surface of cultivated ground, especially the made garden soil suitable for the growth of plants. In the sense of a furry growth, consisting of minute fungi found on animal or vegetable substances exposed to damp, the word may be either an extension of "mould," earth, or an adaptation of an early "moul," with an additional *d* due to "mould." "Moul" is a Scandinavian word, cf. Swed. *mögla*, to grow musty, and the Eng. colloquial "muggy." (2) A form or pattern, particularly one by means of which plastic materials may be made into shapes, whence "moulding," the form which the material so shaped takes. The word comes through the O. Fr. *modle*, *molle*, from Lat. *modulus*, a measure, or standard. The English "model" is another derivative of the same word.

MOULDINGS, the term in architecture for the decorative treatment given to projecting or receding features in stone, wood and other materials, by means of curved forms, whereby those features are accentuated and varied owing to the play of light and shade on the surfaces. The principal characteristics of all the European styles are to be found in the mouldings employed in them and in their ornamental decoration. In some of the earlier styles, such as the Assyrian and the Persian, there are no mouldings: coloured bands in brick, enamelled tiles or beton, were deemed sufficient to mark the divisions of their storeys or to decorate their buildings. The Egyptians employed two mouldings only, the *cavetto* (fig. 1), a deep moulding sometimes of great dimensions which crowned their pylons, temples and decorative shrines, and the *torus*, a semicircular projecting moulding which was carried above the architrave and down the quoins of their buildings. The Greeks were the first to recognize, in their temples, the special value possessed by mouldings which, occupying an intermediate position between

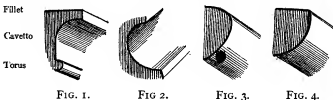

FIG. 1.

FIG. 2.

FIG. 3.

FIG. 4.

the ornamental sculptures and the simple architectural lines of the main structure, gave a richly decorative effect to the latter without interference with the beauty of the former.

The classic mouldings may be divided into two classes, simple and compound; to the former belong the *cavetto* (of small dimensions when compared with the Egyptian *cavetto*) and the *Scotia* (fig. 2), employed for the bases of columns, which are seen below the eye, both concave mouldings, whilst the *ovolo* or *echinus*—Fr. *ovc* or *quart de rond*—(figs. 3 and 4)

and the *torus* are convex mouldings. The compound mouldings are those composed of curves of contrary flexure, such as the *cyma-recta* or *cymatium* (fig. 5), of which the upper part is concave and the lower convex, a moulding constantly employed for the upper member of the cornice, and the *cyma-reversa* or *ogee* (fig. 6)—Fr. *talon*—in which the upper portion is convex.



FIG. 5.

FIG. 6.

FIG. 7.

The Greeks sometimes varied the ogee moulding, the upper portion of which is turned back and the lower portion brought forward, and to this the term *quirked ogee* (fig. 7) is given. Another Greek moulding of compound form is the bird's beak (fig. 8), employed as a drip moulding above the corona. Of smaller dimensions is the *astragal* (fig. 9), a moulding invariably carved with the bead and reel, which in Greek work is constantly used in conjunction with the enriched echinus and *cyma-reversa* mouldings (figs. 18, 20) and below the necking of Ionic capitals; and the *listel* or *fillet*, employed chiefly in the separation of curved mouldings one from the other; in the *cymatium* constituting its upper termination (fig. 5), and in the *Scotia* (fig. 2) its upper and lower border. In Classic work generally the *cavetto* is only employed for the apophyte under the capital and over the base, but in Roman work, as in the theatre of Marcellus, it sometimes took the place of the *cymatium* of the cornice. Although extremely simple in its form, the finest Greek moulding, and the one to which the Greeks apparently attached the greatest value, was the echinus under the abacus of the Doric capital. The earliest archaic example exists in the capital of the shafts flanking the tomb of Agamemnon at Mycenae (a, fig. 10), where it consisted of a large torus decorated

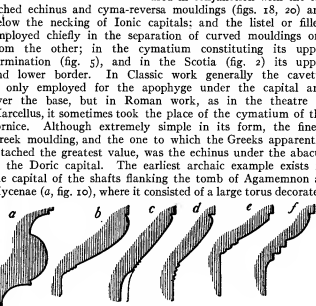

FIG. 10.

with the chevron (see **CAPITALS**), and an apophyte carved with the petals of a flower; a similar decoration of the apophyte is found in two or three early Doric capitals, as at Paestum and Metapontum, but this is the only example known in which the echinus of the Doric capital was carved, though traces of painting and gilding have been found on them. Other examples showing the gradual development of the echinus are shown in fig. 10; *b* being from the temple at Corinth, *c* from the Parthenon at Athens, *d* from the portico at Delos, *e* an early Roman example (c. 60 B.C.) of the temple at Cori, and *f* from the theatre of Marcellus, where it nearly approaches the quarter round always employed in late Roman work and in the Renaissance.

There is one other important decorative feature which forms the most characteristic feature of the bedmould of the Ionic cornice, viz. the dentil cornice (fig. 11), derived originally from the ends of the squared timbers which carried the cornice of the primitive Ionic temple, and in the earlier stone examples copied more or less literally; it subsequently in the 4th century was introduced as a part of the bedmould of the cornice of the Ionic Order, the temple of Minerva Polias at Priene in Asia Minor being one of the best examples. It consists of a series of projecting blocks with intervals between them equal to half

the width of the block. In the Greek Corinthian Order it was first introduced into the Choragic monument of Lysicrates. It was constantly employed by the Romans in their temples of the Ionic and Corinthian Orders, the finest example being in the bedmould of the temple of Castor in Rome, where it is twice the height of the other mouldings.

In the Romanesque style the mouldings consist almost entirely of rounds and hollows, the former known as the bowtel,

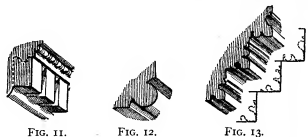

and in England, France, Spain and Germany employed to decorate or soften the angle of an arch mould. As the Romanesque arch frequently consisted of two or more rings of arches, projecting one in front of the other, to which rings the term "order" is sometimes given, the repetition of this simple moulding constituted an ample decoration by itself, but in the Norman work in England and the north of France there is found the constant recurrence of mouldings broken into zigzag lines and other decorations coming under the head of ornamental mouldings described below. The simple bowtel (fig. 12) was retained in France far into the Gothic period, but in the Early English style the mouldings (fig. 13) became lighter, being more boldly cut than in the Romanesque styles. Here again, as in the earlier style, each ring or order is enriched with a succession of alternate rounds and hollows, the latter very deeply cut, and a few small fillets. The bowtel also is brought out to an angle which is sometimes emphasized by a small fillet; this is sometimes called the keel moulding from its resemblance in section to the bottom of a ship. Sometimes the angle of the ring is splayed, and the mouldings are worked on the splay, and this is very often found in the mouldings of the ribs of a vault (fig. 13a), giving greater lightness to the rib. The mouldings of the Decorated period (fig. 14) are more diversi-

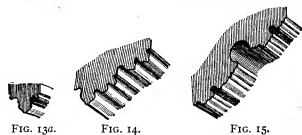

fied than those of the Early English, and the hollows towards the end of the period become shallower and broader, ogees being frequently employed. One of the chief characteristics of the Perpendicular period (fig. 15) is the prevalence of large shallow hollows and the employment of two ogees in close contact with the convex sides next each other.

The French mouldings of the Gothic period in Normandy and adjacent parts follow very much on the same lines as those in England, but in the south of France and in Germany they are very much simpler, and one rarely finds the deep hollow which forms the chief characteristic of English mouldings. In French flamboyant and late German Gothic work the mouldings run through, penetrating one another; these in Germany were sometimes cut off, having the appearance of the smaller stems of a tree from which some of the boughs have been lopped.

Ornamental Mouldings.—Although the mouldings in Greek and Roman architectural works are in general form much the

same, they vary materially in their profiles and also in the refinement of their enrichment with carving. It is probable that the earliest decoration of mouldings was confined to the painting only of their surfaces, and in one or two of the more archaic examples traces of painting only are found on them. The desire to accentuate the ornament would seem to have led the Greeks at a very early date to incise or raise in relief the decorative designs which originally were painted only; at first this was done very sparingly, and in the earlier buildings but few mouldings were employed; in course of time they increased in number, and in the Augustan period in Rome the carving extended to the flat surfaces of the corona, and the fascia and soffits of the architrave.

The four principal Classic mouldings, so far as their enrichment with carving is concerned, were the cyma-recta or cymatium; the cyma-reversa or ogee; the echinus or ovolo; and the torus. The cymatium was almost always decorated with a conventional treatment of the flower of the acanthus plant, known generally as the anthemion and sometimes as the honeysuckle; the finest example is that which is found in the cornice of the north doorway of the Erechtheum (fig. 16). Although in some cases the flower of the acanthus is repeated in the Roman cymatium, the rigidity of the other lines does not seem to have appealed to the Roman sculptor, who preferred more foliage, such as is shown in the cymatium



FIG. 16.

of the Forum of Nerva (fig. 17), there being endless variety of design in Roman examples. The ogee-moulding in Greek work was always carved (fig. 18) with the Lesbian leaf (Fr. *rais-de-cœur*; Ger. *Herslaub*), which in Roman work received a peculiar interpretation of the original design; not understanding the



FIG. 17.

of the Forum of Nerva (fig. 17), there being endless variety of design in Roman examples. The ogee-moulding in Greek work was always carved (fig. 18) with the Lesbian leaf (Fr. *rais-de-cœur*; Ger. *Herslaub*), which in Roman work received a peculiar interpretation of the original design; not understanding the



FIG. 18.



FIG. 19.

modelling of the leaf and requiring a deeper shadow, the Roman drilled holes in it and evolved another composition of two leaves, so that the outer edge of the Lesbian leaf formed a trefoil cusp (Fr. *alon triflé*), constituting a new description of border, as shown in fig. 19, from the temple of Castor at Rome.

The ovolo moulding, whether employed in the bedmould of a cornice, on the capital of an anta, or in the Ionic capital, was always carved (fig. 20) with the egg and dart enrichment (Fr. *œve et dard*; Ger. *Eierstab*), which was spread out wider by the



FIG. 20.



FIG. 21.

Roman carver, while holes pierced on each side of the tongue changed its design into that of the egg and tongue (fig. 21). In both the enriched ogee and the carved ovolo the design was never complete without the bead and reel underneath (figs. 20 and 21), there being always two beads and four reels to each leaf or egg. When employed as the crowning moulding of an architrave, the ogee is always capped by a fillet; and the same applies to the cymatium of the cornice. When the ogee moulding was of small size and employed in a subordinate position, as is constantly done in Roman work, crowning the modillion

or subdividing the fascia of the architrave, a simpler leaf pattern was employed.

Though not a moulding, the modillion, which was invented by the Romans to give additional support to the corona, forms part of the bedmould of the cornice, and may therefore be described here. It consists of a small bracket (fig. 22), the



FIG. 22.

design of which was probably derived from the vertical console bracket which carried the cornice of the Greek doorways, but which in the Roman cornice was employed horizontally. The design of the outer side is that of an Ionic volute with its cushion; on the inner side the volute is reversed and is of greater size, the soffit being masked by a leaf.

The torus moulding of the base in early examples was fluted but not carved, and the earliest example so treated is that found in the base of the columns of the Erechtheum, where it was enriched with the triple guilloche. In the temple of Apollo Branchidae, near Miletus in Asia Minor, where they would seem to have attempted to rival the figure decoration of the temple of Diana at Ephesus, the torus mouldings were elaborately carved with the acanthus plant and the laurel leaf; but it was in the Augustan age in Rome that the greatest elaboration was given to the torus of the base; in the Ara Pacis, set up in A.D. 13, it was carved with the double guilloche; the finest Roman example of an enriched torus being that of the base of the Trajan column in Rome, which is carved with laurel leaves tied at intervals with bands.

The principal enriched Byzantine moulding is that known as the Venetian dentil (fig. 23), in consequence of its constant



FIG. 23.

employment in Venice and the towns in its vicinity. Its earliest appearance, however, is in Sta Sophia at Constantinople (A.D. 537). The other carved Byzantine mouldings are those which throughout Syria form richly carved string-courses, taking the place of the Classic cornice, and the hood moulds of arches. The Byzantine string-course, which is found in St Mark's, Venice, and in most of the towns bordering on the Adriatic, is a cyma-recta carved with the acanthus leaf.



FIG. 24.

There are many varieties; then follow the single and double billet (fig. 26), the double cube, the indented, the beakhead (fig. 27), &c. In the transition period in England, flowers and foliage begin to be introduced, and the rosette (fig. 28), the dog-tooth (fig. 29), which develops into a four-leaf flower, and the ball flower (fig. 30) follow, these being all carved in the hollow



FIG. 25.



FIG. 26.



FIG. 27.

of cavetto mouldings. In the Decorated and Perpendicular styles, the flowers and foliage introduced in mouldings become more natural, till one reaches the Tudor rose (fig. 31), a precise copy of the flower, beyond which it was difficult to go.



FIG. 28.



FIG. 29.

In the 16th century the enrichment of mouldings passed through a transitional stage, being half Gothic and half Classic, and on the introduction of the purer Italian style Roman profiles and decoration were again employed. The Greek revival at



FIG. 30.



FIG. 31.

the commencement, and the Gothic revival in the middle, of the 19th century naturally brought about a reaction in favour either of purer Classic forms or of Gothic work, but the venacular types could not be displaced by the passing fashion, and the influence of Robert Adam is again paramount to-day. (R. P. S.)

MOULIN (Fr. *moulin*, a mill), in physical geography, the name given to the swirling cascades which are formed by glacier streams pouring into crevasses, and result in the formation of giant's kettles.

MOULIN QUIGNON, a quarry near Abbeville, France, celebrated for the discovery in 1863 by Boucher de Perthes of a human jaw-bone believed to be referable to the Quaternary period. By his collection of flints Boucher de Perthes had been the first to attempt to establish the existence of man in remote ages; but it had been objected that if the flints were indeed the work of man, human remains would have been found in association with them. Considerable excitement therefore was created both in England and France by the "find" of bones at Moulin Quignon, and a commission of inquiry was appointed. The report was favourable to the genuineness of the relics, but latterly doubts have arisen as to whether they can be regarded as earlier than the Neolithic age.

MOULINS, a town of central France, capital of the department of Allier, 121 m. by rail N.W. of Lyons. Pop. (1906), 18,997. The town is situated on the right bank of the Allier, which is here crossed by a remarkable bridge of the 18th century about 1000 ft. in length. Moulins did not attain any importance till the 14th century, before which it consisted chiefly of some mills belonging to the dukes of Bourbon. The mediaeval town occupied a small area, the boundaries of which are marked on the N.E. and S. by the central boulevards occupying the site of the old moats. The modern town, expanding from this nucleus, is limited on the east and south by the railway, the southern portion being traversed by agreeable promenades. To the north is the spacious avenue known as the Cours de Bercy, close by the hospital and the lycée. The more interesting buildings lie within the old enceinte. The chief of these is the cathedral, which consists of a huge choir of the 15th and 16th centuries, and a nave in the early Gothic style but modern in construction and terminated by two towers with stone spires rising to a height of 312 ft. The church possesses a fine triptych attributed to Domenico Ghirlandajo (d. 1494), and fine windows of the 15th and 16th centuries. Among the oldest buildings in the town are the square tower of the 14th century (used as a prison) which is the chief relic of the château of the dukes of Bourbon, and a belfry of the 15th century. Part of an old Jesuit college serves as the court-house, which contains an archaeological museum. The library, which possesses a valuable Bible of 1115, is part of the hôtel-de-ville. Numerous mansions of the 15th and 16th centuries border the streets of the

old quarter of the town. There is a statue of the poet Théodore de Banville, born at Moulins in 1823. The town is the seat of a prefect, a bishop, and a court of assizes, and has tribunals of first instance and commerce, and a branch of the Bank of France. Yzeure, $1\frac{1}{2}$ m. E. of Moulins, has an interesting Romanesque church (12th century); $7\frac{1}{2}$ m. W.S.W. of Moulins is Souvigny, formerly famous for its Cluniac priory. Its church, a fine building of the 11th and 12th centuries, restored in the 15th century, contains the splendid tombs of Louis II. and Charles I., dukes of Bourbon in the 15th century, and other tombs of the Bourbon family, now in ruins.

Moulins became the residence of the dukes of Bourbon about the middle of the 14th century, and capital of the duchy towards the end of the 15th century. In 1566, under Charles IX., an important assembly of notables was held in the town, at which the judicial system of France was reorganized.

MOULMEIN (or MAULMEIN), the port and headquarters of Amherst district and Tenasserim division of Lower Burma. The population in 1901 was 58,346, and the increase in the last quarter of a century has been very slight. Ship-building, which formerly was an important industry, has now been given up, but there is still a considerable export of teak and rice, and there are several steam rice- and saw-mills. The total exports average more than a million sterling. Three steamers run weekly to Rangoon. Germany and Siam are represented by consuls; Persia, Denmark, and Norway and Sweden by vice-consuls; and Italy and the United States of America by consular agents. The garrison of Madras native infantry, formerly stationed in the town, was withdrawn in 1898. The town, which has the appearance of being on a river, the Salween, is really on the sea, with the island of Bilugyun in front. It is one of the most picturesque ports in the East. There is a branch of the Bank of Bengal, and two newspapers are published—one in English and one in Burmese.

MOULT, a term for the shedding of feathers at the periodic renewal of the plumage by birds, and so transferred to the periodic shedding of the old skin, shell, &c., by other animals. The word is seen in O. Eng. in the verb *mūltian*, to exchange; from Lat. *mutare*, to change; cf. mod. Ger. *maussen*, *mausern*; the earlier forms in English are *mout*, *mute*; the insertion of the *l*, as in "fault," dates from the 16th century.

MOULTON, LOUISE CHANDLER (1835-1908), American poet, story-writer and critic, daughter of Lucius L. Chandler, was born in Pomfret, Connecticut, in 1835. In 1855 she married a Boston publisher, William U. Moulton (d. 1898), under whose auspices her earliest literary work had appeared in *The True Flag*. Her first volume of collected verse and prose, *This, That and the Other* (1854), was followed by a story, *Juno Clifford* (1855), and by *My Third Book* (1859); her literary output was then interrupted until 1873 when she resumed activity with *Bed-time Stories*, the first of a series of volumes, including *Firelight Stories* (1883) and *Stories told at Twilight* (1890). Meanwhile she had taken an important place in American literary society, writing regular critiques for the *New York Tribune* from 1870 to 1876 and a weekly literary letter for the Sunday issue of the *Boston Herald* from 1886 to 1892. In 1876 she published a volume of notable *Poems* (renamed *Swallow-flights* in the English edition of 1877) and visited Europe, where she began close and lasting friendships with leading men and women of letters. Thenceforward she spent the summers in London and the rest of the year in Boston, where her salon was one of the principal resorts of literary talent. In 1889 another volume of verse, *In the Garden of Dreams*, confirmed her reputation as a poet. She also wrote several volumes of prose fiction, including *Miss Eyre from Boston and Other Stories*, and some descriptions of travel, including *Lazy Tours in Spain* (1896). She was well known for the extent of her literary influence, the result of a sympathetic personality combined with fine critical taste. She died in Boston on the 10th of August 1908.

See Lilian Whiting, *Louise Chandler Moulton* (Boston, 1910).

MOULTRIE, JOHN (1709-1874), English poet, was born in London on the 30th of December 1709. He was educated at

Eton, and many of his best verses were contributed to the *Elonian*. He entered Trinity College, Cambridge, in 1819, and in 1822 began to reside at the Middle Temple. Three years later he was ordained, and was presented to the living of Rugby by Lord Craven. At Rugby he became intimate with Thomas Arnold, to whom two of his best sonnets are addressed. He died at Rugby on the 26th of December 1874. He published several volumes of verse during his lifetime, and a complete edition of his poems was published (2 vols., 1876) with a memoir by Derwent Coleridge. They include, amongst such that is dull, some popular pieces, "Godiva," "Three Minstrels," an account of meetings with Wordsworth, Coleridge and Tennyson, "My Brother's Grave," and some excellent hymns.

MOULTRIE, WILLIAM (1730-1805), American soldier, was born in Charleston, South Carolina, on the 23rd of November 1730. His father, a physician, and a graduate of the University of Edinburgh, migrated to Charleston before 1729. The son was elected to the Commons House of the Assembly in 1754, 1769 and 1772; and in 1766 he was captain of a provincial regiment in the expedition under Governor William H. Lyttelton against the Cherokees. Although he was connected by many ties to the British, he espoused the American cause on the outbreak of the War of Independence, and was a member of the first provincial congress (1775) of South Carolina, which in June made him a colonel of the Second South Carolina regiment; and he was a member of the second provincial congress (1775-1776). On Fort Johnson, on James Island in Charleston harbour, he raised what is said to have been the first American battle-flag—blue, with a white crescent in the dexter corner, inscribed with the word "Liberty"; the flag was devised by him in September 1775. In March 1776 he took command of a palmetto fort which he had built on Sullivan's Island, off Charleston, which he held against the attack of Admiral Sir Peter Parker on the 28th of June, and which soon after the battle was renamed Fort Moultrie by the General Assembly. He was thanked by Congress, was made a brigadier-general in the continental army in September 1776, and was placed in command of the department of Georgia and South Carolina. He dislodged the British from Beaufort, South Carolina, in February 1779, and in April made it possible for the city of Charleston to put itself into a state of defence by delaying the advance of General Augustine Prevost. He was one of those who advised against the surrender of Charleston, where he commanded the garrison until the arrival of General Benjamin Lincoln. His imprisonment after the surrender of Charleston (May 1780) lasted until his exchange with others for General Burgoyne in February 1782. In October 1782 he was made a major-general. He was governor of South Carolina in 1785-1787 and in 1792-1794. He died in Charleston on the 27th of September 1805.

He wrote *Memoirs of the Revolution so far as it related to the States of North and South Carolina* (2 vols., 1802).

MOUND, now used in the sense of a pile or heap of earth, artificial or natural, especially such a pile raised over a grave or burial-place, a tumulus, or as a means of defence, and so used to translate Lat. *agger*. The earliest use in English is for a hedge or other boundary between adjoining lands; this only survives dialectically. The word is obscure in origin, but was early influenced by "mount," *i.e.* hill; Lat. *mons*, *montis*. A connexion with O. Eng. *mund*, guardianship, hand, has been suggested. The "orb," *i.e.* a globe of gold surmounted by a cross, as forming part of the regalia (*q.v.*), is often known as a "mound"; this is a translation of Fr. *monde*; Lat. *mundus*, world.

MOUND-BUILDERS, in North America, the name given to the prehistoric inhabitants who chiefly centred in the valleys of the Mississippi and Ohio, and who seem to have possessed a measure of civilization far in excess of that of the North American Indians when first met by the whites. The remarkable mounds, which have given occasion for the name, are fortified enclosures and tumuli of the most varied appearance, round, conical, or in the shape of animals. They are scattered

over an immense tract of country from the great lakes to the Gulf of Mexico, and from the Rockies to the Atlantic, but are specially frequent in the valley of the Mississippi, along its left tributaries, in Arkansas, Kansas and the basin of the Ohio. But the old theory that the mound-builders were a distinct race of highly civilized agriculturists, who had lived from remote antiquity in the regions of the mounds and were eventually exterminated by the nomadic hordes coming from the northward, represented to-day by the present Indians, is no longer supported by the principal American ethnologists, who hold that the Indians are their descendants.

In Ohio there are thousands of mounds, some in the form of circles, others four-sided, and in a few cases eight-sided. Sometimes a square and a circle are united. Altar-mounds, small rounded heaps of earth, are found in Ohio. At their centre is a basin-shaped mass of hard clay showing effects of fire. These basins are 3 or 4 ft. across, and contain ashes and charcoal. Upon these altars are found many objects.

The most famous mound in Ohio is the "Great-Serpent," in Adams county. It lies upon a narrow ridge between three streams which unite. It is a gigantic serpent made in earth. Across the widely-opened jaws it measures 75 ft.; the body just behind the head measures 30 ft. across and is 5 ft. high; and, following the curves, the length is 1348 ft. The tail is in a triple coil. In front of the monster is an elliptical enclosure with a heap of stones at its centre. Beyond this is a form somewhat indistinct, thought by some to be a frog.

In Wisconsin the most interesting mounds are the effigy mounds—earthen forms of mammals, birds and reptiles—usually in groups and of gigantic size. Among them are buffalo, moose, elk, deer, fox, wolf, panther and lynx. Some panthers have tails 350 ft. long, and some eagles measure 1000 ft. from tip to tip of outspread wings. Occasionally the figures are cut or sunk in the earth, and near them are hundreds of simple burial mounds. It seems most probable that the purpose of these effigy mounds are totemic, and that they were objects of worship as guardians of the villages.

Further south in west Tennessee another class of mound is found. This contains graves made of slabs of stone set on edge. The simplest have six stones, two at the sides, two at the ends, one at the top and one at the bottom. Sometimes there is one of these graves in a mound, sometimes many. In one, 12 m. from Nashville, 45 ft. across and 12 ft. high, were found a hundred skeletons, mostly in stone graves ranged one above the other. The skeletons in the upper graves had been buried stretched at full length. The lower graves were short and square, and the bones in them had been cleaned and piled in little heaps.

The mound-builders were Stone-Age men, and made many beautiful objects of stone, shell, bone and beaten metals, but they had no knowledge of smelting. That they were not one race is proved by a study of the skulls from the mounds.

AUTHORITIES.—E. G. Squier and E. H. Davis, *Ancient Monuments of the Mississippi Valley* (1847); I. A. Lapham, *Antiquities of Wisconsin* (1855); Stephen D. Peet, *Emblematic Mounds*; Cyrus Thomas, "Burial Mounds of the Northern Sections of the United States," in the *Fifth Report* (Washington, 1887), and "Mound Explorations" in the *Twelfth Report* (1894) of the Bureau of American Ethnology.

MOUNDSVILLE, a city and the county-seat of Marshall county, West Virginia, U.S.A., on the Ohio river, 12 m. S. of Wheeling. Pop. (1900) 5632; (1910) 8018. It is served by the Baltimore & Ohio railroad, by an electric line to Wheeling, and by boats to Pittsburg, Cincinnati and intermediate ports. Near Moundsville, at the mouth of Grave Creek, is Grave Creek Mound, one of the largest relics of the "American mound-builders"; it is in the form of a regular cone, and is about 320 ft. in diameter at the base and 70 ft. in height. Two sepulchral chambers were discovered in it in 1838. In the upper chamber, about half-way between the centre of the base and the apex, was a single skeleton, adorned with beads, copper bracelets and plates of mica; in the lower chamber, directly under the upper and partly in the natural earth, were two

skeletons, one adorned with beads and the other without ornament. On the sides and top of the lower chamber was a framework of timbers, which seems to indicate that the mound is of comparatively recent date. The city of Moundsville was formed in 1866 by the consolidation of the town of Moundsville (laid out on the Ohio river in 1831, and incorporated in 1832), and the town of Elizabethtown (laid out, about $\frac{1}{2}$ m. from the river, in 1798, and incorporated in 1830).

MOUNET-SULLY, JEAN (1841—), French actor, was born at Bergerac, on the 28th of February, 1841. He entered the Conservatoire at the age of twenty-one, and took the first prize for tragedy. In 1868 he made his debut at the Odéon without attracting much attention. His career was interrupted by the Franco-Prussian War, and the liking he developed for soldiering had almost decided him to give up the stage, when he was offered the opportunity of playing the part of Oreste in Racine's *Andromaque* at the Comédie Française in 1872. His striking presence and voice and the passionate vigour of his acting made an immediate impression, and the eventual result was his election as *sociétaire* in 1874. He became one of the mainstays of the Comédie Française, and distinguished himself in a great variety of tragic and romantic parts. Perhaps his most famous impersonation was that of Oedipus in *L'Oedipe roi*, a French version by Jules Croix of Sophocles's drama. This was first performed in the old Roman amphitheatre at Orange in 1888. Other prominent parts in Mounet-Sully's *répertoire* were Achille in Racine's *Iphigénie en Aulide*, Hippolyte in *Phèdre*, Hamlet, the title parts in Victor Hugo's *Hernani* and *Ruy Blas*, Francis I. in *Le Roi s'amuse*, and Didier in *Marion Delorme*. He was created chevalier of the Legion of Honour in 1889. He also wrote a play, *La Buveuse de larmes*, and in 1906, in collaboration with Pierre Barbier, *La Vieillesse de Don Juan* in verse.

MOUNIER, JEAN JOSEPH (1758—1806), French politician, was born at Grenoble (Isère) on the 12th of November 1758. He studied law, and in 1783 obtained a judgeship at Grenoble. He took part in the struggle between the *parlements* and the court in 1788, and promoted the meeting of the estates of Dauphiné at Vizille (July 20, 1788), which on the eve of the Revolution created an immense stir. He was secretary of this assembly, and drafted the *cahiers* of grievances and remonstrances presented by it to the king. Thus brought into prominence, Mounier was unanimously elected deputy of the third estate to the states general of 1789. There, and in the Constituent Assembly, he was at first an upholder of the new ideas, pronouncing himself in favour of the union of the Third Estate with the two privileged orders, proposing the famous oath of the Tennis Court, assisting in the preparation of the new constitution, and demanding the return of Necker. On the 28th of September 1789 he was elected president of the Constituent Assembly. Being unable, however, to approve the proceedings which followed, Mounier withdrew to Dauphiné, gave in his resignation as deputy, and, becoming suspect, took refuge in Switzerland in 1790. He returned to France in 1801, was named by Bonaparte prefect of the department of Illet-Vilaine, which he reorganized, and in 1805 was appointed councillor of state. He died in Paris on the 28th of January 1806. His principal writings are *Considérations sur les gouvernements* (1789); *Recherches sur les causes qui ont empêché les Français de devenir libres* (1792), and *De l'influence attribuée aux philosophes, aux francs-maçons et aux illuminés sur la révolution de la France* (1801).

See F. A. Aulard, *Les Orateurs de l'assemblée constituante* (2nd ed., Paris, 1905); De Lanzac de Laborie, *Un Royaliste libéral en 1789*; J. J. Mounier (Paris, 1887); A. Rochas, *Biographie du Dauphiné* (Paris, 1886); Berriat St Prix, *Eloge historique de M. Mounier* (1806); F. Bojanowski, "Quelques lettres inédites de J. J. Mounier," in the *Revue historique* (1898).

MOUNT, WILLIAM SIDNEY (1807—1868), American artist, was born at Setauket, Long Island, New York, on the 26th of November 1807. He studied in the schools of the National Academy of Design, New York, and in 1832 was made a full Academician. Among his better-known works are "Turning

the Grindstone" and "Farmer's Nooning," Jonathan Sturgis collection; "Turn of the Leaf," Lenox Library, New York; "Bargaining for a Horse," New York Historical Society; "Raffling for a Goose," M. O. Robert's collection; "Long Story," Corcoran Art Gallery, Washington; and "War News," Metropolitan Museum of Art, New York. He died at Setauket, Long Island, on the 10th of November 1868. His brother, Shepard Alonzo Mount (1804-1868), also an artist, best known as a portrait painter, became a National Academician in 1842.

MOUNTAIN (O. Fr. *montaigne*; popular Lat. *montanea*, an adjectival form from the classical *mons, montis*, whence Eng. "mount," a form usually used along with the name of an individual mountain, e.g. Mt Everest), a natural elevation of the earth's surface. The term properly connotes height superior to that of a hill (O. Eng. *hyll*, cognate with Lat. *collis*); but the distinction depends on the prominence of a given elevation in relation to its surroundings, and in some degree to the bold or gentle character of its outline.

For the classification of mountains according to the various processes of their formation, see GEOGRAPHY, § Principles of Geography; and for further details GEOLOGY, § viii.

MOUNTAIN, THE (*La Montagne*), the name applied during the French Revolution to a political group, whose members, called *Montagnards*, sat on the highest benches in the Assembly. The term, which was first used during the session of the Legislative Assembly, did not come into general use until 1793. At the opening of the Convention the Montagnard group comprised men of very diverse shades of opinion, and such cohesion as it subsequently acquired was due rather to the opposition of its leaders to the Girondist leaders than to any fundamental hostility between the two groups. The chief point of distinction was that the Girondists were mainly theorists and thinkers, whereas the Mountain was composed almost entirely of uncompromising men of action. During their struggle with the Girondists, the Montagnards gained the upper hand in the Jacobin Club, and for a time Jacobin and Montagnard were synonymous terms. The Mountain was successively under the sway of such men as Marat, Danton, and Robespierre, and the group finally disappeared after Robespierre's death and the successes of the French arms.

See also the articles JACOBINS, GIRONDISTS and FRENCH REVOLUTION.

MOUNTAIN ASH, an urban district of Glamorganshire, south Wales, in the Aberdare valley on the Cynon, a west bank tributary of the Taff, with stations on the Taff Vale and Great Western railways, 18 m. N.E. of Cardiff. Pop. (1901), 31,093. A branch of the Glamorganshire canal passes through the place. At the beginning of the 19th century Mountain Ash was a small village known only by its Welsh name of Aberpenar, but from 1850, with the development of its collieries, the population rapidly increased. The district has an area of 10,504 acres and comprises; besides Mountain Ash proper, a string of villages, the chief being Cwmpenar, Penrhiwceiber, Abercynon or Aberdare Junction (at the confluence of the Cynon with the Taff) and Ynysybwl, 3 m. to the west on the Clydach. The public buildings include St Margaret's (1862) and St Winifred's (1883); the parish churches of Mountain Ash and Penrhiwceiber respectively; old and new town halls (1864 and 1904), cottage hospital (1896), and a library institute and public hall erected in 1899, at a cost of £8000, by the workmen of Nixon's Navigation collieries. There is a park of 7 acres given in 1897, by Lord Aberdare, whose residence, Duffryn, is in the district. There are also a workmen's institute and a public hall at Penrhiwceiber. The older part of the urban district is included in the parliamentary borough of Merthyr Tydfil, and also shares with Merthyr and Aberdare the services of a stipendiary magistrate.

MOUNTAINEERING, the art of moving about safely in mountain regions, avoiding the dangers incidental to them, and attaining high points difficult of access. It consists of two main divisions, rock-craft and snow-craft. Rock-craft consists in the intelligent selection of a line of route and in gymnastic

skill to follow the line chosen. In snow-craft the choice of route is the result of a full understanding of the behaviour of snow under a multitude of varying conditions; it depends largely upon experience, and much less upon gymnastic skill. The dangers which the craft of climbing has been developed to avoid are of two main kinds: the danger of things falling on the traveller and the danger of his falling himself. The things that may fall are rocks, ice and snow; the traveller may fall from rocks, ice or snow, or into crevasses in ice or snow. There are also dangers from weather. Thus in all there are eight chief dangers: falling rocks, falling ice, snow-avalanches, falls from difficult rocks, falls from ice slopes, falls down snow slopes, falls into crevasses, dangers from weather. To select and follow a route avoiding these dangers is to exercise the climber's craft.

Falling Rocks.—Every rock mountain is falling to pieces, the process being specially rapid above the snow-line. Rock-faces are constantly swept by falling stones, which it is generally possible to dodge. Falling rocks tend to form furrows in a mountain face, and these furrows (*coulouirs*) have to be ascended with caution, their sides being often safe when the middle is stone-swept. Stones fall more frequently on some days than on others, according to the recent weather. Local experience is a valuable help on such a question. The direction of the dip of rock strata often determines whether a particular face is safe or dangerous; the character of the rock must also be considered. Where stones fall frequently debris will be found below, whilst on snow slopes falling stones cut furrows visible from a great distance. In planning an ascent of a new peak such traces must be looked for. When falling stones get mixed in considerable quantity with slushy snow or water a mud avalanche is formed (common in the Himalaya). It is necessary to avoid camping in their possible line of fall.

Falling Ice.—The places where ice may fall can always be determined beforehand. It falls in the broken parts of glaciers (*seracs*) and from overhanging cornices formed on the crests of narrow ridges. Large icicles are often formed on steep rock-faces, and these fall frequently in fine weather following cold and stormy days. They have to be avoided like falling stones. Seracs are slow in formation, and slow in arriving (by glacier motion) at a condition of unstable equilibrium. They generally fall in or just after the hottest part of the day, and their debris seldom goes far. A skilful and experienced ice-man will usually devise a safe route through a most intricate ice-fall, but such places should be avoided in the afternoon of a hot day. Hanging glaciers (*i.e.* glaciers perched on steep slopes) often discharge themselves over steep rock-faces, the snout breaking off at intervals. They can always be detected by their debris below. Their track should be avoided.

Snow Avalanches.—These mainly occur on steep slopes when the snow is in bad condition, early in the year, or after a recent fresh fall. Days when snow is in bad condition are easily recognized; on such days it may be inadvisable to traverse snow-slopes which at another time may be as safe as a high-road. Beds of snow collected on rock-ledges in bad weather fall off when a thaw comes, and are dangerous to rock-climbers. Snow that has recently fallen upon ice slopes is always liable to slip off bodily. Such falling masses generally make the lower part of their descent by couloirs. Snow avalanches never fall in unexpected places, but have their easily recognizable routes, which can be avoided in times of danger by experienced mountaineers.

Falls from Rocks.—The skill of a rock-climber is shown by his choice of handhold and foothold, and his adhesion to those he has chosen. Much depends on a correct estimate of the firmness of the rock where weight is to be thrown upon it. Many loose rocks are quite firm enough to bear a man's weight, but experience is needed to know which can be trusted, and skill is required in transferring the weight to them without jerking. On all difficult rocks the rope is the greatest safeguard for all except the first man in the ascent, the last in the descent. In such places a party of three or four men roped together, with a distance of 15 to 20 ft. between one and another, will be

able to hold up one of their number (except the top man) if one only moves at a time and the others are firmly placed and keep the rope tight between them, so that a falling individual may be arrested before his velocity has been accelerated. In very difficult places help may be obtained by throwing a loose rope round a projection above and pulling on it; this method is specially valuable in a difficult descent. The rope usually employed is a strong Manila cord called Alpine Club rope, but some prefer a thinner rope used double. On rotten rocks the rope must be handled with special care, lest it should start loose stones on to the heads of those below. Similar care must be given to handholds and footholds, for the same reason. When a horizontal traverse has to be made across very difficult rocks, a dangerous situation may arise unless at both ends of the traverse there be firm positions. Even then the end men gain little from the rope. Mutual assistance on hard rocks takes all manner of forms: two, or even three, men climbing on one another's shoulders, or using for foothold an ice-axe propped up by others. The great principle is that of co-operation, all the members of the party climbing with reference to the others, and not as independent units; each when moving must know what the man in front and the man behind are doing. After bad weather steep rocks are often found covered with a veneer of ice (*berglus*), which may even render them inaccessible. Climbing-irons (crampens, *steigeisen*) are useful on such occasions.

Ice Slopes.—Climbing-irons are also most useful on ice or hard snow, as by them step-cutting can sometimes be avoided, and the footing at all times rendered more secure. True ice slopes are rare in Europe, though common in tropical mountains, where newly-fallen snow quickly thaws on the surface and becomes sodden below, so that the next night's frost turns the whole into a mass of solid ice. An ice slope can only be surmounted by step-cutting. For this an ice-axe is needed, the common form being a small pick-axe on the end of a pole as long as from the elbow of a man to the ground. This pole is used also as a walking-stick, and is furnished with a spike at the foot.

Snow Slopes are very common, and usually easy to ascend. At the foot of a snow or ice slope is generally a big crevasse, called a *bergschrund*, where the final slope of the mountain rises from a snow-field or glacier. Such *bergschrunds* are generally too wide to be strided, and must be crossed by a snow bridge, which needs careful testing and a painstaking use of the rope. A steep snow slope in bad condition may be dangerous, as the whole body of snow may start as an avalanche. Such slopes are less dangerous if ascended directly than obliquely, for an oblique or horizontal track cuts them across and facilitates movement of the mass. New snow lying on ice is specially dangerous. Experience is needful for deciding on the advisability of advancing over snow in doubtful condition. Snow on rocks is usually rotten unless it be thick; snow on snow is likely to be sound. A day or two of fine weather will usually bring new snow into sound condition. Snow cannot lie at a very steep angle, though it often deceives the eye as to its slope. Snow slopes seldom exceed 40°. Ice slopes may be much steeper. Snow slopes in early morning are usually hard and safe, but the same in the afternoon are quite soft and possibly dangerous; hence the advantage of an early start.

Crevasse.—These are the slits or deep chasms formed in the substance of a glacier as it passes over an uneven bed. They may be open or hidden. In the lower part of a glacier the crevasses are open. Above the snow-line they are frequently hidden by arched-over accumulations of winter snow. The detection of hidden crevasses requires care and experience. After a fresh fall of snow they can only be detected by sounding with the pole of the ice-axe, or by looking to right and left where the open extension of a partially hidden crevasse may be obvious. The safeguard against accident is the rope, and no one should ever cross a snow-covered glacier unless roped to one, or better to two, companions.

Weather.—The main group of dangers caused by bad weather centre round the change it effects in the condition of snow and

rock, making ascents suddenly perilous which before were easy, and so altering the aspect of things as to make it hard to find the way or retrace a route. In storm the man who is wont to rely on a compass has great advantage over a merely empirical follower of his eyes. In large snow-fields it is, of course, easier to go wrong than on rocks, but a trained intelligence is the best companion and the surest guide.

History.—The first recorded mountain ascent after Old Testament times is Trajan's ascent of Etna to see the sun rise. The Roche Melon (11,600 ft.) was climbed in 1358. Peter III. of Aragon climbed Canigou in the Pyrenees in the last quarter of the 13th century. In 1339 Petrarch climbed Mt Ventoux near Vacluse. In 1402 the ascent of Mt Aiguille was made by order of Charles VIII. of France. The Humanists of the 16th century adopted a new attitude towards mountains, but the disturbed state of Europe nipped in the bud the nascent mountaineering of the Zürich school. Leonardo da Vinci climbed to a snow-field in the neighbourhood of the Val Sesia and made scientific observations. Konrad Gesner and Josias Simler of Zürich visited and described mountains, and made regular ascents. The use of axe and rope were locally invented at this time. No mountain expeditions of note are recorded in the 17th century. In 1744 the Titlis was climbed—the first true snow-mountain. Pococke and Windham's historic visit to Chamonix was made in 1741, and set the fashion of visiting the glaciers. The first attempt to ascend Mont Blanc was made in 1775 by a party of natives. In 1786 Dr Michel Paccard and Jacques Balmat gained the summit for the first time. De Saussure followed next year. The Jungfrau was climbed in 1811, the Finsteraarhorn in 1812, and the Zermatt Breithorn in 1813. Thenceforward tourists showed a tendency to climb, and the body of Alpine guides began to come into existence in consequence. Systematic mountaineering, as a sport, is usually dated from Sir Alfred Wills's ascent of the Wetterhorn in 1854. The first ascent of Monte Rosa was made in 1855. The Alpine Club was founded in London in 1857, and soon imitated in most European countries. Edward Whymper's ascent of the Matterhorn in 1865 marks the close of the main period of Alpine conquest, during which the craft of climbing was invented and perfected, the body of professional guides formed and their traditions fixed. Passing to other ranges, the exploration of the Pyrenees was concurrent with that of the Alps. The Caucasus followed, mainly owing to the initiative of D. W. Freshfield; it was first visited by exploring climbers in 1868, and most of its great peaks were climbed by 1888. Trained climbers turned their attention to the mountains of North America in 1888, when the Rev. W. S. Green made an expedition to the Selkirks. From that time exploration has gone on apace, and many English and American climbing parties have surveyed most of the highest groups of snow-peaks; Pike's Peak (14,147 ft.) having been climbed by Mr E. James and party in 1820, and Mt Saint Elias (18,024 ft.) by the duke of the Abruzzi and party in 1897. The exploration of the highest Andes was begun in 1879-1880, when Whymper climbed Chimborazo and explored the mountains of Ecuador. The Cordillera between Chile and Argentina was attacked by Dr Güssfeldt in 1883, who ascended Maipo (17,752 ft.) and attempted Acconagua (23,393 ft.). That peak was first climbed by the Fitzgerald expedition in 1897. The Andes of Bolivia were explored by Sir Martin Conway in 1898. Chilean and Argentine expeditions revealed the structure of the southern Cordillera in the years 1885-1898. Sir Martin Conway visited the mountains of Tierra del Fuego in 1898. The Alps of New Zealand were first attacked in 1882 by the Rev. W. S. Green, and shortly afterwards a New Zealand Alpine Club was founded, and by their activities the exploration of the range was pushed forward. In 1895 Mr E. A. Fitzgerald made an important journey in this range. Of the high African peaks, Kilimanjaro was climbed in 1889 by Dr Hans Meyer, Mt Kenya in 1889 by J. E. S. Mackinder, and a peak of Ruwenzori by H. J. Moore in 1900. The Asiatic mountains have as yet been little climbed, though those that lie within the British Empire have been surveyed. In 1892 Sir Martin

Conway explored the Karakoram Himalayas, and climbed a peak of 23,000 ft. In 1895 A. F. Mummary made a fatal attempt to ascend Nanga Parbat, whilst in 1890 D. W. Freshfield took an expedition to the snowy regions of Sikkim. In 1899, 1903, 1906 and 1908 Mrs Fannie Bullock Workman made ascents in the Himalayas, including one of the Nun Kun peaks (23,300 ft.). A body of Gurkha sepoy were trained as expert mountaineers by Major the Hon. C. G. Bruce, and a good deal of exploration has been accomplished by them. The only mountains of the northern polar region that have been explored are those of Spitzbergen by Sir Martin Conway's expeditions in 1896 and 1897, and the peaks in the north of Norway and the Lofotens by various Alpine Club and Norwegian parties. (W. M. C.)

BIBLIOGRAPHY.—J. D. Forbes, *Travels through the Alps* (1843, new ed., 1900); J. Ball and E. S. Kennedy, *Peaks, Passes and Glaciers* (1859-1862); E. Whymper, *Sherlock Among the Alps* (1871); C. King, *Mountaineering in the Sierra Nevada* (1886, new ed., 1903); Sir W. M. Conway, *Climbing in the Karakoram, Himalayas* (1894); Sir W. M. Conway, *The Alps from End to End* (last ed., 1900); Sir W. M. Conway, *The Alps* (1904); Francis Gribble, *The Story of Alpine Climbing* (1904); Sir W. M. Conway, *The Bolivian Andes* (1901); A. F. Mummary, *My Climbs in the Alps and Caucasus* (1895); E. A. Fitzerald, *Climbs in the New Zealand Alps* (1896); F. de Filippi, *The Ascent of Mount Saint Elias* (1900); W. D. Wilcox, *Camping in the Canadian Rockies* (1900); H. C. M. Stutfield and J. N. Collic, *Climbs and Exploration in the Canadian Rockies* (1903); *Mountaineering*, in the Badminton Library (1900).

MOUNT BARKER, a town of Hindmarsh county, South Australia, at the foot of the mountain of the same name, 34½ m. by rail E. of Adelaide. It has an extremely fine climate and is much frequented as a health resort in summer. It is the centre of a populous and fertile district producing quantities of fruit, wheat and dairy produce; important cattle sales are held weekly, and there are several engineering works, flour mills and tanneries in the town, which also is the seat of a wattle-bark industry. Pop. about 2000; but the inhabitants of the Mount Barker district number over 34,000.

MOUNT CARMEL, a borough of Northumberland county, Pennsylvania, U.S.A., at the head of Shamokin Creek, about 50 m. N.N.E. of Harrisburg. Pop. (1890), 8254; (1900), 13,179, of whom 3772 were foreign-born; (1910 census) 17,532. It is served by the Lehigh Valley, the Philadelphia & Reading, and the Shamokin Division of the Northern Central (Pennsylvania system) railways. Anthracite coal abounds here, and the mining and shipping of it, together with the manufacture of mining machinery and miners' supplies are the borough's principal industries. This locality was settled late in the 18th century. About 1848 Mount Carmel was laid out as a town, and in 1862 was chartered as a borough.

MOUNT CLEMENS, a city and the county seat of Macomb county, Michigan, U.S.A., on Clinton river, about 5 m. (about 2m. in direct line) from its entrance into Lake Saint Clair, and 20 m. N. by E. of Detroit. Pop. (1890) 4748; (1900) 6576 (1104 foreign-born); (1904, state census) 7108; (1910) 7707. It is served by the Grand Trunk railway and by two electric lines to Detroit. The mineral waters of Mount Clemens are beneficial to patients suffering from rheumatism, blood diseases and nervous disorders. The city's principal manufactures are beet sugar, barrels and other coopers' products, wagons, carriages, sleighs and agricultural implements. Mount Clemens was settled in 1802, was incorporated as a village in 1837, and was chartered as a city in 1879.

MOUNT DESERT, an island in Hancock county, Maine, U.S.A. It is about 16 m. long and 10 m. wide in its widest part, with an approximate area of 100 sq. m. and a population (1910) of 804. The Maine Central railroad runs a ferry from its nearest station on the mainland (Mount Desert Ferry), and the island is also accessible during the warmer months by steamship lines from New York, Boston, Portland, and several other ports. On the north across Mount Desert Narrows, a bridge connects the island with the mainland. Eagle Lake, at the north-east base of Green Mountain, is a beautiful sheet of water about 2½ m. long, and ½ m. wide, and Great Pond, 4 m. long, lies near Somesville between Beech Hill and Western Mountain. There are numerous

outlying rocky islets. The surface of Mount Desert is generally so rocky that the greater part of it has never been inhabited or cultivated, but wherever there is a thin soil the hills are wooded with spruce, alder, birch, maple and mountain ash. The hilly scenery, the cool summer climate, and the facilities for boating and fishing attract many thousands of visitors each summer, and the maintenance of the permanent population is derived very largely from the summer residents. The Penobscot and Passamaquoddy Indians come here in the season to sell their basket-work, toy canoes, moccasins, bows and arrows, &c. The villages most frequented by summer visitors are Bar Harbor (q.v.) on the north-east coast; Northeast Harbor, Southwest Harbor and Seal Harbor on the south coast; and Somesville, at the head of Somes Sound. Along the western shore are several quaint old hamlets.

Mount Desert Island was discovered and named by Samuel de Champlain on the 5th of September 1604. French Jesuits established a settlement, St Sauveur, at the entrance to Somes Sound in 1609, but this was destroyed four years later by Samuel Argall. In 1688 the island was granted by Louis XIV. to Sieur de la Mothe Cadillac, but no permanent settlement was established until 1762, when the general court of Massachusetts granted one-half of the island to Governor Francis Bernard and under his encouragement a settlement was begun at Southwest Harbor. During the War of Independence all the American estates of Bernard were confiscated, but in 1785 his former interest in Mount Desert was conveyed to his son, John, and two years later heirs of Cadillac, among them his granddaughter, Mme de Gregoire, who had come to Maine in 1786, received from the general court a grant for the remaining portion. Until the summer visitors came, the settlers gained only a scanty livelihood, chiefly by fishing, lumbering, boat building and farming. Practically all of them lived along the shore; they had boats, but few horses, and the roads were only rough trails. There is no record of any mail service until 1820, and as late as 1870 the only means of reaching the island was by stage from Bangor or by steamboat twice a week from Portland.

See George E. Street, *Mount Desert, a History* (Boston, 1905).

MOUNTBANK (Ital. *montabanco, montimbanco*, from *montare*, to climb up on, mount, and *banco*, bench, cf. *saltimbanco*, an acrobat or dancer, one who dances or leaps on a bench), a wandering juggler, story-teller, seller of quack medicines, &c., who performs his entertainment on a platform or raised bench, hence any charlatan or quack.

MOUNTED INFANTRY, infantry soldiers who ride instead of marching on foot from one place to another. As combatants they are infantry pure and simple, being neither armed nor trained to fight on horseback, and their special characteristic is the power to move from one point to another with great rapidity. They are therefore useful (a) in wars, such as colonial wars, in which cavalry proper finds no scope for its activity, and (b) in performing duties for which mounted troops, but not necessarily troops that can fight mounted, are required. In these two rôles mounted infantry is obviously a substitute for cavalry. As cavalry is both a most expensive arm and one which cannot be improvised, there is an ever-recurring tendency in all armies to consider it as being more ornamental than useful, and in consequence to substitute mounted infantry under one name or another (the original dragoons for example were mounted infantry) for "shock action" cavalry. In recent times, owing to the development of the long-ranging magazine rifle, this tendency has been intensified to such a degree that Russia, for example, converted the whole of her cavalry into dragoons—the term being used in its old sense—and trained it to act dismounted in large bodies. It is however significant of the failure of this wholesale conversion that after the Russo-Japanese War the regiments that were formerly hussars and lancers were reorganized as such and ceased to be styled and trained as dragoons.

It is difficult, but at the same time important, to differentiate between dragoons or "mounted rifles," as they are often called to-day, and mounted infantry in a narrower sense of the word.

Mounted rifles are half cavalry, mounted infantry merely specially mobile infantry. The American cavalry in the Civil War, the Boers in the South African War, the Russians in the Manchurian campaign, were mounted rifles, and the question of their advantages and disadvantages, as compared with what is generally called "regular" cavalry, is purely a cavalry one. The main question as regards mounted infantry is whether its existence as a special arm is justified by the kind and degree of assistance which it is peculiarly qualified to give to the other arms in war. If this be answered in the affirmative for a particular army, then that army, having raised mounted infantry, may require of it such additional services as it would be more or less uneconomical to assign to regular cavalry. Mounted infantry in this case may and in fact does assume the rôle of mounted rifles; for example, in the British regular army the duties of divisional mounted troops are performed by mounted infantry, while in the territorial army the same duties are performed by yeomanry mounted rifles.

In the British mounted infantry, which is the only force in any army specially trained as such,¹ the course of instruction lasts four months and is based on the assumption that officers and men under instruction are already fully trained as infantry (*M.I. Training*, 1909). All words of command, bugle sounds, formations, &c., are similar to those used in the infantry, and as a rule spurs are forbidden. The mounted infantry horse is a handy cob (14.2 to 15). The organization adopted is by battalions and companies, each company having 6 officers and 153 men, and the battalion consisting of three such companies and a machine-gun section. Mounted infantry battalions and companies do not exist in peace, but are formed on mobilization from the qualified men available who can be spared from the infantry. Since many more men are trained than would be required for the 24 or 26 companies forming part of the expeditionary force, the arm is capable of considerable expansion, while the men first selected for the service are in every way picked men. As already mentioned its duties are (a) with respect to the cavalry, first to assist and secondly to supplement or replace it—by the judicious use of the rifle, and (b) with respect to the infantry to relieve the unmounted man as far as possible of reconnoitring and orderly duties, and above all of the necessity of hurried and exhausting movements to seize points of support.

Cyclists.—The application of the bicycle to military purposes was first suggested in Great Britain, and military cycling became the special and almost exclusive property of the volunteer force, in which, when cycling became universally popular and the machines cheap, practically all battalions had sections and most of them companies of cyclists. In those days, however, the want of a common organization separated the yeomanry from the volunteers, and the latter, possessing no mounted troops of its own, employed its numerous cyclists in reconnoitring, protective and orderly work indifferently. Reconnoitring battalions were frequently formed, and in spite of their heterogeneous composition and inadequate staff they proved capable of manœuvring as units. Movements in brigade were practised at Aldershot in 1901, the brigade composed of 3 battalions of about 650 rifles each, drawn from some forty volunteer infantry units under training at the time, being trained in combined movements by parallel roads and night marching, as well as in field operations. When the fusion of the yeomanry and volunteers in the territorial force (1907-1908) released cyclists from the duties of mounted troops which had hitherto been imposed on them, the cyclist companies in the infantry battalions were disbanded, and their place taken by 10 cyclist battalions specially trained for protective work in large tactical bodies. The regular army, which is generally employed in almost roadless countries, only maintains a few cyclists for orderly work.

Amongst the regular armies that of France was certainly

¹ The infantry "mounted scouts" of the Russian and French armies are simply auxiliaries and have no existence apart from their regiments.

the pioneer in the matter of cycling. Infantry support for cavalry is a fundamental principle of the French doctrine of tactics, and this infantry support in so well-roaded a country as France naturally takes the form of strong cyclist groups. The French military cyclists are equipped with a folding bicycle, which allows of cross-country movement being undertaken without leaving the bicycles unguarded. In Germany very few military cyclists are maintained—one small section in each infantry or cavalry regiment. The field service regulations permit the grouping of these sections for united action as a company, but only under special circumstances. In Italy, however, whole battalions of the fast-moving light troops, *Bersaglieri*, have been within recent years provided with the cycle.

Cyclists are mounted infantry in the strictest possible sense of the phrase. They possess over all horsemen the incalculable advantages of being able to make longer marches; for they can cover 80 or 90 m. a day for several days;² of exemption from forage anxieties; of freedom from the necessity in action of leaving one-third or one-quarter of the men to hold the horses; and of actual speed, an ordinary cyclist being able to move faster along a good road than a staff officer mounted on a thoroughbred. On the other hand cyclist troops can never be as free to move across country as horsemen; a cyclist column, owing to its speed and great length in proportion to its numbers, is peculiarly liable to surprise; and the condition of the roads or a strong head wind materially reduces its rate of marching.

MOUNTFORT, WILLIAM (c. 1664-1692), English actor and dramatic writer, was the son of a Staffordshire gentleman. His first stage appearance was with the Dorset Garden company about 1678, and by 1682 he was taking important parts, usually those of the fine gentleman. Mountfort wrote a number of plays, wholly or in part, and many prologues and epilogues. He married, in 1686, Susanna Percival (see *VERBRUGEN*, MRS), the actress. Owing to jealousy of Mrs Bracegirdle's supposed interest in Mountfort, Captain Richard Hill, an adventurer, who had annoyed her with persistent attentions, accompanied by Charles, fifth Baron Mohun, murdered Mountfort in Howard Street, Strand, on the 9th of December 1692. Hill made his escape. Lord Mohun was tried by his peers and acquitted by a vote of 69 to 14.

MOUNT GAMBIER, a town of Grey county, South Australia, 305 m. by rail S.E. of Adelaide. It stands on the northern base of the mountain of the same name, an extinct volcano. It is a handsome town with many fine buildings of white limestone and grey and red dolomite, which abound in the neighbourhood, the church of St Paul being the finest edifice of its kind outside Adelaide. The agricultural society has a good showground where two shows are held annually. Two splendid lakes lie near the town—Blue Lake, 160 acres in extent, and Valley Lake, 97 acres, from the first of which the water-supply of the town is derived. Mount Gambier is the centre of one of the richest grain-growing districts in Australia. Pop. (1901), 3162; and including the suburbs, about 8000.

MOUNT HOLYOKE COLLEGE, the pioneer institution in America for the higher education of women, situated in the village of South Hadley, Massachusetts, near Mount Holyoke. It was founded by Mary Lyon (*q.v.*), and was chartered as Mount Holyoke Female Seminary in 1836 (opened in 1837), but the name was changed to Mount Holyoke College in 1803. Besides the recitation halls and laboratories there are the Dwight Memorial art building (1901), a library building (1905), the John Payson Williston observatory, botanical gardens (1901), a gymnasium, a hospital, and seven residence halls. For undergraduates the college offers two years of work in prescribed courses in Latin, Greek, French, German, English, history, Biblical literature, profane literature, physics, and chemistry, and two years of work in elective courses; for graduates it offers one year of advanced work, including courses in education designed for those preparing to teach. To make college expenses

² The loss of men by accidents to the machines, punctures, &c., has been shown in manœuvres to be nearly negligible.

lighter and to "promote a spirit of democracy and of consideration for others" every student helps either in housework or in the academic departments. In 1908-1909 the college had 110 instructors and 748 students.

MOUNTJOY (or **MONTJOY**), **BARONS AND VISCOUNTS**. Sir Walter Blount (d. 1474), of Elvaston, Derbyshire, grandson of Sir Walter Blount, who was an adherent of John of Gaunt, succeeded his father, Sir Thomas Blount, as treasurer of Calais in 1460, becoming governor a year later as a reward for service rendered to King Edward IV. at the battle of Towton. Edward conferred on him rich estates forfeited by the earl of Devon; and in 1465 Blount was made lord high treasurer and created Baron Mountjoy. This creation is noteworthy as one of the earliest examples of a baronial title not being of a territorial character; nor the title of a dignity already existing. Blount's great-grandfather had married Isolda, daughter and heiress of Sir Thomas de Mountjoy, and the title was probably chosen to commemorate this alliance.

WILLIAM BLOUNT, 4th Baron Mountjoy (c. 1478-1534), was famous as a scholar and patron of learning. He was a pupil of Erasmus, who called him *inter nobiles doctissimus*. His friends included Colet, More and Grocyon. He held a command in the force sent to suppress Perkin Warbeck's rebellion in 1497. In 1513 he was appointed governor of Tournai, and his letters to Wolsey and Henry VIII. describing his vigorous government of the town are preserved in the British Museum. He was present with Henry VIII. at the Field of the Cloth of Gold in 1520, and at the meeting with Charles V. in 1522. He had been master of the mint since 1509, and chamberlain to Catherine of Aragon since 1512. It fell to him in this office to announce to the queen Henry's intention to divorce her; he also signed the letter to the pope conveying the king's threat to repudiate the papal supremacy unless the divorce were granted. Mountjoy, who was one of the wealthiest English nobles of his time, died in 1534. His son Charles, 5th Baron Mountjoy (1516-1544), was also a patron of learning.

CHARLES BLOUNT, earl of Devonshire and 8th Baron Mountjoy (1563-1606), lord-lieutenant of Ireland, grandson of the preceding, was the most notable of the later holders of the title. The favour which his youthful good looks procured for him from Queen Elizabeth excited the jealousy of the earl of Essex, and led to a duel between the two courtiers, who, however, soon became close friends. Between 1586 and 1598 he was much on the continent, serving in the Netherlands and in Brittany. He joined Essex and Sir Walter Raleigh in their expedition to the Azores in 1597, his brother, Sir Christopher Blount (1565-1601), who was afterwards executed for complicity in Essex's treason, being also of the party. In 1600 Mountjoy went to Ireland as lord deputy in succession to Essex, where he succeeded in suppressing the rebellion of Hugh O'Neill, earl of Tyrone, whom Essex had failed to subdue. In July 1601 Mountjoy made himself master of Lough Foyle, and in the following December he defeated O'Neill's Spanish auxiliaries at Kinsale, and drove them out of the country. In 1602 the earl of Tyrone made his submission to Mountjoy in Dublin (see O'NEILL); and on the accession of James I. Mountjoy was continued in his office with the more distinguished title of lord-lieutenant. Returning to England, he was one of Sir Walter Raleigh's judges in 1603; and in the same year he was made master of the ordnance and created earl of Devonshire, extensive estates being also granted to him. He died in London on the 3rd of April 1606. About 1500 Mountjoy took as his mistress Penelope, wife of Lord Rich and sister of the earl of Essex. After the death of her brother in 1601, Lady Rich was divorced from her husband in the ecclesiastical courts. Mountjoy, by whom she had already had several children, was married to the lady in 1605 by his chaplain, William Laud, afterwards archbishop of Canterbury. As he left no legitimate children the earl's titles became extinct at his death.

His eldest natural son by Lady Rich, **MOUNTJOY BLOUNT** (c. 1597-1666), inherited a large property by his father's will, and was a favourite with James I. The family title was revived

in his favour in 1618, when he was created Baron Mountjoy, of Mountjoy Fort, Co. Tyrone, in the peerage of Ireland; and Baron Mountjoy of Thurveston, Derbyshire, in the peerage of England. In 1628 he was further created earl of Newport in the Isle of Wight. In the same year he was appointed to command, with the rank of rear-admiral, the expedition for the relief of Rochelle; in 1634 he was made master of the ordnance. He took the popular side at the beginning of the trouble between Charles I. and the parliament, and was an eager opponent of Strafford. When the Civil War broke out, however, Newport served in the royalist army, and took part in the second battle of Newbury in 1644. In January 1646 he was taken prisoner and confined in London on parole. He died at Oxford on the 12th of February 1666, leaving two surviving sons, who in turn succeeded to the earldom of Newport and barony of Mountjoy. Both titles became extinct on the death of Henry, the younger of these sons, in 1681.

In 1683 **SIR WILLIAM STEWART** (1653-1692), who owned large property in the counties of Donegal and Tyrone, and whose grandfather was created a baronet in 1623, was raised to the peerage of Ireland as Baron Stewart of Ramelton, Co. Donegal, and Viscount Mountjoy. Having served abroad, Mountjoy returned to Ireland in 1687, where he became brigadier-general. At the revolution he remained loyal to James II.; but being a Protestant he was distrusted by Tyrconnel, the viceroys, and was removed with his troops from Londonderry to Dublin. When the gates of Londonderry were closed against James's representative, Tyrconnel sent Mountjoy and Robert Lundy with a force to the north. After negotiations which resulted in Lundy being admitted as governor to the city, Mountjoy was sent with Sir Stephen Rice to Paris to report on the state of affairs to James II. On their arrival, Rice acting on secret instructions, denounced Mountjoy as a traitor, and the latter was thrown into the Bastille, where he remained till 1692. He then went over to William III., and was killed at Steinkirk on the 3rd of August 1692.

WILLIAM, 3rd Viscount Mountjoy (1709-1769), was in 1745 created earl of Blessington, his mother having been sister and sole heiress of Charles, 2nd and last Viscount Blessington. On his death without issue in 1769 all his titles became extinct. Anne Stewart, daughter and heiress of Alexander Stewart, second son of the above-mentioned William, 1st Viscount Mountjoy, married Luke Gardiner, vice-treasurer of Ireland; and her grandson, Luke Gardiner (1745-1798), who inherited a large portion of the Mountjoy family estates, was created Baron Mountjoy of Mountjoy, Co. Tyrone (1789), and Viscount Mountjoy (1795), both in the peerage of Ireland; but on the death without male issue in 1829 of his son Charles John, who in 1816 was created earl of Blessington, all these titles again became extinct.

THOMAS WINDSOR, or **HICKMAN-WINDSOR** (c. 1670-1738), second son of Thomas, Lord Windsor de Stanwell, 1st earl of Plymouth, was in 1699 created Viscount Windsor of Blackcastle, in the peerage of Ireland. In 1712 he was created a peer of Great Britain with the title of Baron Mountjoy of the Isle of Wight, being descended in the female line from Sir Andrew Windsor (c. 1475-1543), 1st Baron Windsor de Stanwell, who married Elizabeth Blount, sister and co-heir of Edward, 2nd Baron Mountjoy of the first creation, who died an infant in 1475. On the death of Thomas's son Herbert in 1758 the title of Mountjoy again became extinct; but it was revived in favour of John Stuart, earl of Bute, who married Charlotte Jane Hickman-Windsor, Herbert's daughter and sole heiress, and who in 1796 was created Viscount Mountjoy of the Isle of Wight, earl of Windsor, and marquess of the county of Bute, all of which titles are held by his descendant, the present marquess of Bute.

See Sir Alexander Croke, *The Genealogical History of the Croke family, originally named Le Blount* (2 vols., Oxford, 1823). For the Irish lord deputy, see also W. B. Devereux, *Lives and Letters of the Devereux, Earls of Essex* (2 vols., London, 1853); Fynes Morison, *Itinerary* (London, 1617). Also, G. E. C., *The Complete Peerage* (London, 1889).

MOUNTMELICK, a market town of Queen's county, Ireland, pleasantly situated on the Owenass (an affluent of the Barrow) which nearly encircles it. Pop. (1901), 2407. It is the terminus of a branch of the Great Southern & Western railway, $\frac{7}{8}$ m. N. of Maryborough and 5 $\frac{1}{2}$ W.S.W. of Dublin. A branch of the Grand Canal also reaches the town, providing water communication with Dublin, and with Waterford by the river Barrow. There are industries of malting, tanning, woollen and salt manufactures, and iron-founding. A settlement of Quakers has contributed largely to the prosperity of the town. A provincial school of the Leinster Society of Friends was founded here in 1796.

MOUNT MORGAN, a municipality of Raglan county, Queensland, Australia, 28 m. by rail S.S.W. of Rockhampton. Pop. (1901), 6280. Railway communication was opened in 1898. The town has been considered to stand on the richest gold site in Australia, the gold being very fine and pure.

MOUNT SORREL, a market town in the Loughborough (Mid) parliamentary division of Leicestershire, on the river Soar, 7 m. N. of Leicester. Pop. (1901), 2417. The Sibley station on the Midland main line lies $\frac{1}{2}$ m. E. The position is beautiful, a steep hill, once crowned by a castle, rising above the well-wooded valley. At BARROW-UPON-SOAR, $\frac{2}{3}$ m. N. (pop. 2409; Barrow and Quorn railway station), lime is worked extensively. The village of QUORNDON or QUORN, $\frac{1}{2}$ m. N.W., is the headquarters of the well-known Quorn hunt. Quorndon is an urban district (pop. 2173).

MOUNTSTEPHEN, GEORGE STEPHEN, BARON (1829—), Canadian financier, was born on the 5th of June 1829 at Dufftown, Banffshire, Scotland, the son of William Stephen and Elspeth Smith. He was educated at the parish school, after which he was for a time a herd boy. In 1850 he went to Canada and soon became a prominent business man in Montreal. In 1878 he joined with his cousin, Donald Smith (afterwards Lord Strathcona), in the purchase of the St Paul & Pacific railway. This led to his interest in the development of western Canada, and from 1881 onwards he was associated with his cousin in the construction of the Canadian Pacific railway, for his services in connexion with which he was in 1886 made a baronet, in 1891 raised to the peerage; and in 1905 made G.C.V.O. In 1888 he left Canada, and thereafter lived in England and Scotland. He gave lavishly to charity and education, and with Lord Strathcona built and endowed the Royal Victoria hospital at Montreal.

MOUNT-TEMPLE, WILLIAM FRANCIS COWPER-TEMPLE, BARON (1811-1888), English politician, second son of the 5th Earl Cowper, was born at Bocket Hall, Hertfordshire, on the 13th of December 1811. He was educated at Eton, and entered the Royal Horse Guards, attaining the rank of brevet-major in 1852. His mother, Emily Mary, was sister to the prime minister, Lord Melbourne, whose secretary William Cowper became in 1835; in this year he entered parliament as member for Hertford, which he continued to represent until 1863. As commissioner of works (1860-1866) he carried the bills for the Thames Embankment (1862), and for the new law courts (1863); but he is best known for the amendment, known as the "Cowper-Temple clause," which he introduced into the second reading of the Education Bill of 1870, that no catechism nor denominational teaching of any kind should be included in the religious instruction given in rate-aided schools. His mother, who married Lord Palmerston as her second husband, died in 1869, and under his stepfather's will William Cowper succeeded to some of the Palmerston estates in Ireland and Hampshire, and assumed the additional name of Temple. He was M.P. for South Hampshire from 1868 until 1880 when he was raised to the peerage as Baron Mount-Temple of Mount-Temple, Sligo. He died at Broadlands, near Romsey, on the 16th of October 1888. He was twice married, but left no children, the Palmerston estates descending to the Right Hon. Evelyn Ashley (1836-1907), who was under-secretary of state for the colonies from 1882 to 1885.

MOUNT VERNON, a city and the county-seat of Jefferson county, Illinois, U.S.A., about 75 m. E. by S. of St Louis. Pop. (1890), 3233; (1900), 5216 (111 foreign-born); (1910), 8007. It is served by the Chicago & Eastern Illinois, the Louisville & Nashville, the Wabash, Chester & Western, and the Southern railways. It is the headquarters of the fourth appellate court district of the state. Mount Vernon was settled in 1819, incorporated as a village in 1837 and chartered as a city in 1872. Many of its buildings were destroyed by a cyclone on the 19th of February 1888.

MOUNT VERNON, a city and the county-seat of Posey county, Indiana, U.S.A., on the Ohio river, in the extreme south-west corner of the state. Pop. (1890) 4705; (1900), 5132, including 892 negroes and 262 foreign-born; (1910), 5563. It is served by the Evansville & Terre Haute, the Louisville & Nashville, and the Evansville & Mount Vernon (electric) railways. The city is a trading centre for the surrounding farming region. It has a valuable river trade, and various manufactures. The first settlement here was made in 1803, and in 1819 a town was laid out and named Mount Vernon. It became the county-seat in 1825, and was incorporated as a town in 1846 and chartered as a city in 1865.

MOUNT VERNON, a town of Linn county, Iowa, U.S.A., 16 m. E. of Cedar Rapids. Pop. (1900), 1629; (1910, U.S. census), 1532. Mount Vernon is served by the Chicago & North Western railway. It is the seat of Cornell College (Methodist Episcopal; coeducational), which was opened as the Iowa Conference Seminary in 1853, and was chartered in 1857 under its present name, adopted in honour of William W. Cornell (1823-1870), an iron manufacturer of New York City and a benefactor of the institution. Cornell College includes a collegiate department, an academy, a conservatory of music, a school of art, a school of oratory and a summer school; in 1907-1908 it had 40 instructors and 755 students. Mount Vernon was settled in 1842, was laid out in 1847, and was incorporated as a town in 1869.

MOUNT VERNON, a city of Westchester county, in south-eastern New York, U.S.A., on the Bronx river and Eastchester Creek, 13 m. from the Grand Central station, New York City. Pop. (1890), 10,850; (1900), 20,346, of whom 5265 were foreign-born (many being Italians) and 516 negroes; (1910, census), 30,919. It is served by the New York Central & Hudson River and the New York, New Haven & Hartford railways, and by electric lines to New York City, Yonkers, New Rochelle, &c. The city has various manufactures, but in the main is a residential suburb of New York; the finest residences are in the eastern, central and north-eastern sections, the last being known as Chester Hill; the foreign-born element is largely concentrated in the western part. Mount Vernon is in the township of Eastchester, which was settled from Connecticut in 1664, possibly in the hope of pushing Connecticut's boundary nearer the Hudson. It was called "Ten Farms" or East Chester. A parish of the same name was established in 1693, but was disallowed in England. About 1682 the "Ten Farmers" established a free school. In 1764 the foundations were laid of the present St Paul's (Protestant Episcopal), which was used through a part of the American War of Independence as a British military hospital. St Paul's churchyard dates back to the close of the 17th century. Along the White Plains road (now Lincoln Avenue) Washington retreated, pursued by General Henry Clinton, before the battle of White Plains in 1776. The city of Mount Vernon was founded in 1851 by several realty companies. The postal authorities objected to the name Monticello, originally used, and Mount Vernon was adopted instead. Mount Vernon was incorporated as a village in 1853 and was first chartered as a city in 1892. West Mount Vernon was founded by the Teutonic Homestead Association and was annexed to Mount Vernon in 1860.

See William S. Coffey, "East Chester," pp. 720-764 of vol. ii. of J. T. Scharf's *History of Westchester County, N. Y.* (2 vols., Philadelphia, 1886).

MOUNT VERNON, a city and the county-seat of Knox county, Ohio, U.S.A., on the Kokosing river, about 45 m. N.E. of Columbus. Pop. (1890), 6027; (1900), 6633, including 359 foreign-born and 239 negroes; (1910), 9087. Mount Vernon is served by the Baltimore & Ohio and the Cleveland, Akron & Columbus, railways. The city is the seat of the state hospital for tuberculosis, has a fine court-house, a public library, and various manufacturing establishments. Natural gas is found in the vicinity. Mount Vernon was laid out in 1805; it became the county-seat in 1807, was incorporated as a town in 1845, and became a city in 1853.

MOUNT VERNON, the former home of George Washington, in Fairfax county, Virginia, U.S.A., on the Potomac river, 15 m. below Washington, D.C., reached by steamer from Washington and by electric railway from Alexandria, Virginia. The mansion-house, which is the centre of interest, stands on a bluff overlooking the river. The house is built of wood, but the siding is of wide thick boards so panelled as to give the appearance of cut and dressed stonework. The rooms contain much of the furniture which was in them when they were occupied by General Washington and his family; and the furniture that had been lost has been in part replaced by other furniture of historic interest and of the style in use in Washington's day. In the main hall hangs a glass casket containing the key to the Bastille which Washington received from Lafayette in 1790. From each end of the house a curved colonnade and a pavement lead westerly to a row of out-buildings which partially enclose a bowling green and spacious lawn with shaded drives and walks, and beautiful gardens (with trees planted by Washington, Franklin, Jefferson, Lafayette and others). A short distance south-west of the mansion-house and between it and the wharf is a plain brick tomb, which was built by Washington's direction on a site chosen by himself, and contains the remains of Washington and Mrs Washington (removed to this tomb from the old family vault in 1831), and of about thirty relatives—members of the Washington, Blackburn, Corbin, Bushrod, Lewis and Custis families.

The estate, originally called "Little Hunting Creek Plantation," was devised in 1676 by John Washington (the first of the family in America) to his son, Lawrence, who in turn devised it to his daughter, Mildred, by whom (and her husband Roger Gregory) it was deeded in 1726 to her brother Augustine (George Washington's father). On Augustine's death (1743) it passed to Lawrence (George's half-brother), who built in 1743 the villa which forms the middle portion of the present mansion-house and named the estate Mount Vernon, in honour of his former commander, Admiral Edward Vernon (1684-1757). Lawrence left it (1752) to his widow Anne Fairfax (who in the same year married George Lee) with the proviso that it should pass at her death to George Washington, who meanwhile rented the estate, gaining full possession at her death in 1761. In 1784-1785 he enlarged the villa into the mansion-house with its present dimensions by building an addition at each end, erected several of the out-buildings, and adorned the grounds, all according to his own plans and specifications. At General Washington's death (1799) Mount Vernon passed to his widow; at her death (1802) it passed to his nephew, Bushrod Washington, and at Bushrod Washington's death (1829) to his nephew John Augustine Washington, who devised it in 1832 to his widow, by whom it was devised in 1835 to their son John A. Washington. This last was authorized by his father's will to sell the estate to the United States government, and in 1847 offered the property for \$100,000, but the offer was refused. In 1860 the mansion-house and 200 acres of the original estate, fast falling into decay, were bought for \$200,000 (much of which had been raised through the efforts of Edward Everett) by the Mount Vernon Ladies' Association of the Union. This association under its charter (1856) bound itself to restore the estate as far as possible to the condition in which it was in the lifetime of Washington and to keep it sacred to his memory, and Virginia agreed to exempt it from taxation as long as these terms were fulfilled.

See B. J. Lossing, *The Home of Washington: or Mount Vernon and its Associations* (Hartford, 1870).

MOURNING (from the verb "to mourn," to be sorrowful, O. Eng. *murnan*; cf. O.H.G. *mornēn*, Goth. *mairnan*, to be anxious, O.N. *morna*, to pine away; by some referred to root seen in Gr. *μῆρνα*, sorrow, by others to root *mer-*, to die), the expression of grief or sorrow particularly for the dead; more specifically the outward or conventional signs of such grief. The public exhibition of this grief for the dead has taken various forms among different races and in different ages, from shaving of the head, or allowing the beard and hair to grow, from disfiguring the face and uttering loud wailing cries, to the wearing of clothes of a particular colour, now among Western races usually black, and to the purely conventional custom of using black-edged note-paper, cards, &c. (See further FUNERAL RITES.)

MOUSE, in its original sense probably the name of the semi-domesticated house-mouse (*Mus musculus*), the type of the genus *Mus* and of the family *Muridae*. Zoologically, there is no distinction between mice and rats; these names being employed respectively for most or all of the smaller and larger "mouse-like" and "rat-like" representatives of the *Muridae*, whether they belong to the genus *Mus* or not. It is true indeed that in zoological nomenclature some of these are distinguished as "voles" (see *VOLE*), but this is not in accord with popular usage, where such creatures come under the designation either of water-rats or field-mice. The distinctive characters of the typical mice (and rats), i.e. those included in the genus *Mus*, are dealt with in the article *RODENTIA*. With the exception of Madagascar, the genus *Mus* ranges over practically the whole of the Old World, having indigenous representatives even in Australasia; while the house-mouse, with man's involuntary aid, has succeeded in establishing itself throughout the civilized world. The following is a brief notice of the species of true mice (that is to say, those generally included in the genus *Mus*) inhabiting the British Isles. These are three in number. *M. musculus*, the house-mouse, originally a native of Central Asia, has spread to all the inhabited parts of the globe. *M. sylvaticus*, the wood or long-tailed field-mouse, is a species common in many parts of England, often taking to barns and out-houses for shelter during the winter. It is of about the same size and proportions as *M. musculus*, but of a bright reddish-grey colour, with a pure white belly. *M. minutus*, the harvest-mouse, is the smallest of the European mice, seldom exceeding 2½ or 3 in. in length; and of a yellowish-red colour, with comparatively short ears and tail. It lives entirely away from houses, commonly taking up its abode in wheat or hay fields, where it builds a round grass nest about the size of a cricket-ball, in which it brings up its young. Its range extends from England to Japan. In regard to the first it is noteworthy that house-mice isolated on a small sandbank near Dublin have developed a special colouring of their own; also that distinct local varieties, *M. musculus muralis* and *M. m. foerensis*, inhabit respectively St Kilda and the Faeroes. In Central Asia there exists a wild mouse (*M. bactrianus*), and likewise a second species (*M. wagneri*), with the habits of a house-mouse, both of which are closely allied to *M. musculus*; while there is a third kind (*M. gentilis*), also nearly related, in the deserts of North Africa. According to Major G. E. H. Barrett-Hamilton it is probable that *M. bactrianus* and *M. musculus* are respectively desert and house modifications descended from some Central Asian ancestor more or less nearly allied to *M. wagneri*. As regards the other two British species, it must suffice to say that there are several local races of each; *Mus sylvaticus* being represented by several in the British Isles, although there is but one British representative of *M. minutus*. It may be added that by some naturalists both *M. sylvaticus* and *M. minutus* are separated from *Mus* as *Micromys*.

See G. E. H. Barrett-Hamilton, "Note on the Harvest-Mice of the Palaearctic Region," *Annals and Magazine of Nat. History* (April 1899); "On the Species of the genus *Mus* inhabiting St Kilda," *Proc. Zool. Soc. (London, 1899)*; "On Geographical and Individual Variation in *Mus sylvaticus* and its Allies," *op. cit.* (1900); W. E. Clarke, "On Forms of *Mus musculus*, with Description of a New Subspecies from the Faeroe Islands," *Proc. Roy. Phys. Soc. (Edinburgh, 1904)*, vol. xv. (R. L.)*

MOUSE-BIRD (Du. *Muistogel*), the name by which in Cape Colony and Natal the members of the genus *Colius* of M. J. Brisson are known—probably from their singular habit of creeping along the boughs of trees with the whole tarsus applied to the branch. By the earlier systematists, *Colius* was placed among the *Fringillidae*; but the investigations of J. Murie and A. H. Garrod on its internal structure showed that it was not a true Passerine, and it is now placed in a separate family, *Coliidae*, amongst Coraciiform birds, near the trogons and swifts (*q.v.*). The *Coliidae* are small birds, with a rather

of Man of the Olom type, that is, nearly as dolichocephalous as the Neanderthal type, but with superciliary ridges flat, and frontal bones high, and by the occurrence of the musk-ox, the horse, the cave-bear, *Rhinoceros tichorhinus* and the mammoth. The typical implements are flint points or spear-heads, left smooth and flat on one side, as struck from the cave, pointed and edged from the other side; a scraper treated in the same way, but with edge rather upon the side than at the end, as in the succeeding Solutrian and Madelenian epochs. Relics of the Mousterian age have been also found in Belgium, southern Germany, Bohemia and southern England, some of the "finds" including human remains.

MOUTH AND SALIVARY GLANDS. The mouth (A.S. *mās*), in anatomy, is an oval cavity at the beginning of the alimentary canal in which the food is masticated. The opening is situated between the lips, and at rest its width reaches to the first premolar tooth on each side.

The lips (A.S. *lippa*) are fleshy folds, surrounding the opening of the mouth, and are formed, from without inward, by skin, superficial fascia, orbicularis oris muscle, submucous tissue, containing numerous labial glands about the size of a small pea, and mucous membrane. In the deeper part of each lip lies the coronary artery, while in the mid-line is a reflection of the mucous membrane on to the gum forming the *fraenum labii*.

The cheeks (A.S. *clace*) form the sides of the mouth and are continuous with the lips, with which their structure is almost identical save that the buccinator muscle replaces the orbicularis oris and the buccal glands the labial. In the subcutaneous fascia is a distinct mass of fat, specially large in the infant, which is known as the sucking pad. On the buccal surface of the cheek, opposite the second upper molar tooth, is the papilla which marks the opening of the parotid duct, while, just behind, are four or five molar glands, larger than the buccal, the ducts of which open opposite the last molar tooth. The mucous membrane of the cheek, like that of the rest of the mouth, is of the stratified squamous variety (see EPITHELIAL TISSUES) and is reflected on to the gums.

The gums (A.S. *gōma*) consist of mucous membrane connected by thick fibrous tissue to the periosteum of the jaws. Round the base of the crown of each tooth the membrane rises up into a little collar.

The vestibule of the mouth is the space between the lips and cheeks superficially and the gums and teeth deeply. It communicates with the true cavity of the mouth by the clefts between the teeth and by the space behind the last molar teeth.

The roof of the mouth is concave transversely and antero-posteriorly, and is formed by the *hard* and *soft palate*. The hard palate consists of mucous membrane continuous with that of the gums and bound to the periosteum of the palatine processes of the maxillae and palate bones by firm fibrous tissue. In the mid-line is a slight ridge, the palatine raphe, which ends in front in a little eminence called the palatine papilla, marking the position of the anterior palatine canal. From the anterior part of the raphe five or six transverse ridges or rugae of the mucous membrane run outward. (For a description of the soft palate see PHARYNX.)

The floor of the mouth can only be seen when the tongue is raised, then the reflection of the mucous membrane from the gums to it is exposed. In the mid-line is a prominent fold called the *fraenum linguae*, and on each side of this a *sublingual papilla*, on to the summit of which the duct of the submaxillary gland opens. Running outward and backward from this is a ridge called the *plica sublingualis*, which marks the upper edge of the sublingual gland, and on to which most of the ducts of that gland open. (For a description of the TONGUE and the TEETH see special articles on those structures.)

The salivary glands are the *parotid*, *submaxillary* and *sublingual*, though the small scattered glands such as the labial, buccal, molar, lingual, &c., probably have a similar function.

The parotid gland (Gr. *parōtē* beside, *ōtēar*), is the largest of these glands, and is situated between the ear and the ramus of the mandible. In a transverse section through the head about the level of



Mouse-Bird.

finch-like bill, a more or less crested head, a very long tail, and generally of a dun or slate-coloured plumage that sometimes brightens into blue or is pleasingly diversified with white or chestnut. They feed almost wholly on fruits, but occasionally take insects, in quest of which they pass in bands of fifteen or twenty from tree to tree. Seven species are believed to exist, all belonging to the Ethiopian region (of which the Family is one of the most characteristic), and ranging from Abyssinia southwards. Three species inhabit Cape Colony. (A. N.)

MOUSSORGSKY, MODESTE PETROVICH (1835-1881), Russian composer, was born at Karevo, government of Pskov, in March 1835, and entered the army at an early age. He came of a musical family, and was himself a talented amateur, and an acquaintance with Balakirev and Dargomijsky led him to more serious study of composition, so that in 1857 he left the army and devoted himself to music, though this step entailed his earning his living as a government clerk and a prolonged period of poverty. His greatest opera, *Boris Godounov*, based on Pushkin's drama, was produced in St Petersburg in 1874, and on it his reputation stands as one of the finest creative composers in the ranks of the modern Russian school. He also wrote a number of songs and orchestral works, of a realistic national type. In later life he suffered much from ill-health, and died in St Petersburg on the 16th (28th) of March 1881.

MOUSTACHE, or MUSTACHIO, the hair worn unshaven on the upper lip (see BEARD). The spelling "moustache," now the most common in English usage, is the French form of Ital. *mustachio*, an adaptation of a Doric dialectical *μύστραξ*, upper lip, also hair on the lip; this is generally taken to be a variant of *μύστραξ*, jaws, mouth, connected with *μύστροβα*, to chew; cf. "mastic" chewing-gum, and "masticate," to chew.

MOUSTERIAN, the name given by the French anthropologist G. de Mortillet to the second epoch of the Quaternary Age, and to the earliest in his system of cave-chronology. It is so named from a cave (Le Moustier), on the right bank of the Vézère, an affluent of the Dordogne, above Les Eyzies and Tayac, which has yielded typical palaeolithic implements. The epoch was characterized by cold wet climate, by the supposed existence

the mouth the gland looks more or less triangular, its outer wall or base being bounded by the parotid fascia, its anterior by the jaw, and its posterior by the mastoid process and sterno-mastoid muscle. Where the anterior and posterior walls meet to form the apex is the styloid process. Above the gland reaches to the zygoma, and below to the level of the angle of the jaw, where a strong process of the deep cervical fascia, called the *styo-mandibular ligament*, separates it from the submaxillary gland; indeed the parotid is often described as lying in a bag formed by deep cervical fascia. The outline of the gland is obscured by several processes, one of which, the *facial lobe*, runs forward, superficial to the masseter muscle, accompanying the duct. A separate part of this is called the *socia parotidis*; another, known as the *pterygoid lobe*, passes forward, deep to the ramus of the jaw, to the space between the two pterygoid muscles. A third wraps round the front of the styloid process and may be

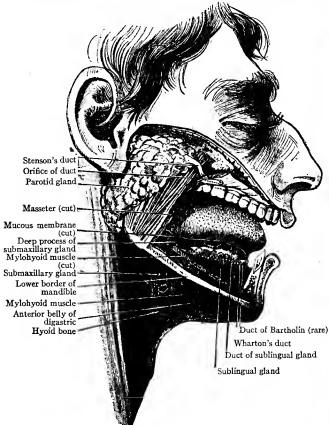

From A. Birmingham Cunningham's *Text Book of Anatomy*.

FIG. 1.—THE SALIVARY GLANDS AND THEIR DUCTS.

The greater portion of the body of the mandible has been removed to expose the sublingual and the deeper parts of the submaxillary glands. Four ducts of the sublingual gland are shown opening on the floor of the mouth over the gland, a fifth is shown opening into the anterior end of Wharton's duct. The course of Wharton's duct is shown by a dotted line.

termed the *pre-styloid lobe*, while a fourth, the *post-styloid*, insinuates itself behind that process. The upper part of the prestyloid lobe sometimes reaches the back part of the glenoid cavity, and is then called the *glenoid lobe*. All these processes, however, are very variable, and depend a good deal on the position of the head and neck. The facial nerve, the tempo-maxillary vein, and the termination of the external carotid artery, among other structures, are embedded in the gland. The *parotid duct* (Stensen's duct) crosses the upper part of the masseter and then pierces the buccinator on its way to the mouth; it is about 2 in. long. Its position is described in the article on ANATOMY (*Superficial and Artistic*), and its opening in the earlier part of this article.

The *submaxillary gland* lies deep to the posterior half of the body of the lower jaw; it is about the size of a walnut, and has an external, internal and inferior surface. The external surface rests against the submaxillary fossa in the jaw, the internal is in contact with the mylohyoid and hyoglossus muscles, while the inferior is subcutaneous. The whole gland is enclosed in a sac of deep cervical fascia, while a process, from which the duct arises, passes deep to the mylohyoid. The facial artery is embedded in the upper part of the gland. The *submaxillary duct* (Wharton's duct) runs forward to the sublingual papilla already mentioned.

The *sublingual gland* is placed further forward than the submaxillary; it is like an almond in shape though larger; its outer

flattened surface rests against the sublingual fossa in the lower jaw, while the inner one is in contact with the genio-hyoglossus muscle, the submaxillary duct and the lingual nerve. Its upper edge forms the sublingual fold (*plica sublingualis*) in the mucous membrane of the mouth, and along this its ducts, which are small and numerous, open; these are sometimes called the *ducts of Rivini*, but the term "sublingual ducts" is simpler and more expressive. Occasionally an *anterior sublingual duct* (*duct of Bartholin's*) opens with or into the submaxillary duct.

Embryology.

The fore-gut (see ALIMENTARY CANAL) at first ends blindly, ventral to the region of the hind brain, while in front of it is the overhanging fore-brain. When the heart develops, ventral to the fore-gut, it also projects forward toward the fore-brain, so that a transverse cleft, without any lateral boundaries and lined by ectoderm, is left between these two structures. This is the *stomatodaeum* or primitive mouth, the ectoderm of which rests against the entoderm of the fore-gut to form the *bucco-pharyngeal membrane*, and so separates the two chambers. The position of this membrane does not correspond to the fauces or hinder limits of the adult mouth, but is much more oblique, so that the front part of the roof of the pharynx is formed by stomatodaeum while the greater part of the floor of the permanent mouth is fore-gut. During the third week the membrane disappears, and it is probable that to its early atrophy is due the fact that no traces of it can be seen in the adult. Growing down from the region of the fore-brain is the fronto-nasal process, which forms the nose and the middle piece of the upper lip, while the lateral parts of the mouth are closed in by two processes, on each side of which the lower or mandibular process rapidly meets its fellow in the mid-line to form the lower jaw and lip, thus separating the heart from the mouth cavity. The upper or maxillary process grows inward more slowly, but at last joins with the fronto-nasal process, and in the adult the lines of union are seen on each side as ridges of skin which run down from the nostril to the margin of the lip, and enclose that slightly depressed vertical gutter to which the term *philtrum* is given. Besides forming the philtrum, the fronto-nasal process is responsible for that part of the roof of the mouth which corresponds to the premaxillary bones, an area marked out by lines drawn on each side from between the lateral incisor and canine teeth to the palatine papilla. At first the cavities of the mouth and nose are one, but they are later divided by the *palatal processes*, which grow in like shelves from the maxillary processes and meet in the mid-line. The submaxillary and sublingual salivary glands develop as solid outgrowths of the buccal epithelium which are canalized later, while the parotid according to Hammar (*Archiv. f. mikr. Anat. LXI. 1892*) is formed first as a groove. The parotid is ectodermal in origin, all the others entodermal.

For further details and literature see *Quain's Anat. vol. i.* (London, 1908); J. P. McMurrich *Development of the Human Body* (London, 1907); O. Hertwig, *Handbuch der Entwicklungslehre Th. II.*, (Jena).

Comparative Anatomy.

In the acrania (amphioxus) the mouth is developed on the left side and gradually shifts to the mid-line; later an extra chamber, the *oral hood*, is formed in front of it, the external opening of which is provided with bristle-like cirrhi, so that in the adult the mouth is merely an aperture in the velum or membrane which separates the oral hood from the pharynx.

In the cyclostomata (lampreys and hags) the mouth is a suctorial organ, and resembles a funnel, the narrow end of which opens into the pharynx. It is always open and is provided with horny teeth and a tongue. At this low stage of the vertebrate scale no jaws have yet appeared, but in the larval lamprey (ammocoetes) an oral hood, resembling that of amphioxus, is present. In the fishes jaws are present and the mouth can be closed at will. In the elasmobranchs (sharks and rays) the opening is crescentic and situated well on the ventral surface of the head, but in other fishes it is at the anterior end of the body. Until the dipnoi (mud fish) are reached there is no communication between the mouth and the nose but in these fishes the internal or posterior nares open into the front part of the roof of the mouth, thus adapting them to air-breathing. In the Amphibia the mouth has usually an enormous gape, and the position of the posterior nares resembles that of the dipnoi. It will be noticed that at this stage of phylogeny the condition resembles that of the ontogeny of man before the palatal processes appear. The premaxillary part of the fronto-nasal process separates the nasal cavity from the mouth in front, but behind that the cavity is the rudiment of the mouth and nose which no palate has yet appeared to separate. In Reptiles the hard palate appears, and henceforward the digestive and respiratory tracts only form one passage in the pharynx. In mammals definite lips provide, with its muscles first appear, that is, the Monotremes have such specialized mouths that they are not outside that order. Many monkeys have the vestibule enlarged to form the cheek pouches. (F. G. P.)

Surgery of the Mouth.

In surgical operations upon the interior of the mouth which are likely to be accompanied with much bleeding, it is much the

custom now to have the patient lying upon his back, with the head hanging over the end of the table, so that the blood may sink into the dome of the pharynx and escape by the nostrils, instead of running the risk of finding its way into the windpipe and lungs. (See CLEFT PALATE.)

Mumps.—Inflammation of the parotid gland is apt to occur as an epidemic, children being chiefly attacked. The disease, which is highly infectious, is called mumps, and is associated with much swelling below and in front of the ear, or ears. There is stiffness of the jaw and there is a difficulty in swallowing. There is slight local tenderness, and the temperature may, perhaps, run up a degree or two. For the sake of others, the child should be kept away from school for three or four weeks.

Salivary Calculus.—Sometimes a deposit of phosphate and carbonate of lime slowly takes place from the saliva, and gives rise to the formation of a small concretion in the duct of one of the salivary glands. When the concretion blocks the duct, so that the saliva is unable to find its way into the mouth, a fluid swelling forms behind the blockage, giving rise to inconvenience and unsightliness. The swelling is at its greatest during a meal, when the secretion of the saliva is necessarily rapid; subsequently it disappears, recurring, however, at the next meal-time. In many cases the patient is conscious of the fact of there being a hard, movable "kernel," the size, perhaps, of a barleycorn, a cherry-stone or even of a small almond, in the course of the duct. In the removal of the calculus every endeavour should be made to effect its escape into the mouth, as, if the skin were incised for its extraction, the wound might refuse to heal, a *salivary fistula* resulting. (E. O.*)

MOUTHPIECE (Fr. *embouchure*; Ger. *Mundstück*; Ital. *bochino*), in music, that part of a wind instrument into which the performer directs his breath in order to induce the regular series of vibrations to which musical sounds are due. The mouthpiece is either taken into the mouth or held to the lips; by an extension of the meaning of the word, mouthpiece is also applied to the corresponding part of an organ-pipe through which the compressed wind is blown, and containing the sharp edge known as "lip," or the reed necessary for the production of sound. The quality of a musical tone is due primarily to the form or method of vibration by means of which sound-waves of a distinctive character are generated, each consisting of a pulse or half-wave of compression and of a pulse of rarefaction; the variety in the quality of tone, or "timbre," obtainable in various wind instruments is in a great measure due to the form and construction of the mouthpiece, taken in combination with the form of the column of air within the tube and consequently of the bore of the latter. The principal functions of the mouthpiece are (1) to facilitate the production of the natural harmonic scale of the instrument; (2) to assist in correcting errors in pitch as the ear directs; (3) to enable the performer to obtain the dynamic variations whereby he translates his emotional interpretation of the music into sound. Mouthpieces, therefore, serve as a means of classifying wind instruments. They fall into the following divisions:—

1. The *syrinx* or *pan-pipe* mouthpiece consists merely of the open end of the tube *across* (not *into*) which the player directs his breath in a current which impinges obliquely against the sharp edge of the pipe, producing the series of shocks or pulses required in the air stream from his lips; this in turn, when in a state of vibration, serves to generate the sound-waves within the pipe. This principle was embodied in the *nay*, or long oblique flute of the ancient Egyptians, which was probably the first mouthpiece discovered and put into practical use by prehistoric man. A modification of this principle has been applied to the transverse flute (*q.v.*), in which the air stream or exciting current is directed across a lateral hole in the head joint of the instrument.

2. The *whistle* mouthpiece is based on that of the flute with this modification, that the air current, instead of being compressed by the lips of the performer and then directed through ambient air to break against the sharp edge of the lateral hole, is compressed mechanically in passing through a narrow channel

so constructed within the mouthpiece that the stream of air impinges with force against the sharp edge of a lip cut into the pipe below the channel. The principle of the whistle mouthpiece has been applied with slight modifications to a variety of instruments such as the recorder (*q.v.*) family in England (Fr. *flûte à bec*, *flûte douce*, *flûte anglaise*; Ger. *Schnabelflöte*, *Plöckflöte*; Ital. *flauto dolce*, in which the channel assumes the form of a beak, the flageolet (*q.v.*), the penny whistle, &c. All these whistle or fipple pipes have at all times enjoyed great popularity owing to the ease with which they can be played.¹

The flute or flue-work of an organ is the result of the adaptation of the same principle to both open and stopped pipes (fig. 1). Compressed air is fed in at an even pressure through the foot AB, and passing through the slit or channel EC, impinges with force against the lip D, producing the requisite series of pulsations in the pipe FF. By this elimination of the human element in the organ, all possibility of communicating the emotion of the performer becomes impossible. With a rigid mouthpiece any increase in wind pressure would affect the pitch, causing the note to become unsteady or to jump to the harmonics; the result could in no case be a crescendo.

3. **Reed Mouthpieces.**—There are three kinds of reed mouthpieces: the double, the single or beating, and the free reed. The function of the reed, a term originally applied to part of a stalk of the *Arundo donax* or *saliva*, but now extended to any vibrating tongue of wood or metal, is to break up an exciting current of air, otherwise flowing in an uninterrupted even stream, into regular beats or pulses, corresponding with the beats or vibrations of the reed. Reeds proper or wooden vibrators, being flexible, are compelled to vibrate synchronously with the column of air within the tube and to accommodate their frequency of vibration to the length of the tube as it varies according to the lateral holes which remain open.²

A. The double reed is the most primitive and probably the oldest of the reed mouthpieces; it was used by the ancient Egyptians.³ A straw flattened at one end and inserted into a pipe having at the mouthpiece end the same diameter as the straw contains all the rudimentary features of the double-reed mouthpiece common to the members of the oboe family, i.e. cor anglais, bassoon, contra-fagotto, to the sarrusophone, and to the chanter of the bagpipe. The earliest Greek aulos (*q.v.*) was probably played by means of a double reed, since the mouthpiece was known as *σείρος*, signifying a pair of like things. The oboe reed (fig. 2) is made from two pieces of reed stalk, flattened and thinned at the end and bound together with waxed thread, thus forming a tube with a constriction in the middle, above which the section is oval and below circular.

A double-reed mouthpiece may be enclosed in an air-chamber or reservoir, as in the 16th-century cromorne (*q.v.*), in the chanter of the bagpipe (*q.v.*), in the reeds of organ-pipes and in certain instruments popular in France during the 17th century known as "hautbois de Poitou." In all of these the air-chamber is supplied with compressed air by the mouth of the performer, whose lips do not come into contact with the reed, a method which makes the production of harmonics impossible, and thus restricts the natural scale. As soon as the practice of over-blowing, i.e. the production of harmonics by increased pressure of breath accompanied by a proportional tension of the lips, became known, the air-chamber

¹ See Rev. F. W. Galpin, "The Whistles and Reed Instruments of the American Indians of the North-West Coast," *Proc. Musical Assoc.* (1903-1904), p. 115, with illustrations.

² See Victor Mahillon, *Éléments d'acoustique musicale* (Paris, 1873), pp. 167 and 83.

³ A case excavated in Egypt was found to contain two pipes, and in addition five pieces of reed without bore or holes, and three pieces of straw suitable for making double-reed mouthpieces. See Victor Lorel, "Les Flûtes égyptiennes antiques," *Journal asiatique* (Paris, 1889), [8], xiv. pp. 119, 200, 201 (note), 207, 211 and 217.



From V. Mahillon, *Éléments d'acoustique*, by permission of C. Mahillon. FIG. 1.—Diagram of a flue-pipe.

of the oboe was discarded and the reed taken directly into the mouth. It is certain that the ancient Greeks obtained the full compass of the aulos by overblowing, since the process by which a modern performer on the oboe or clarinet obtains the harmonics is described by Aristotle¹ and others.²



Radall, Carte & Co.

FIG. 2.—Oboe double-reed mouthpiece.

The vibrating length of the reed is controlled by taking the latter more or less deeply into the mouth and by varying the pressure of the lips upon it; the shorter the free end the higher the pitch of the note or harmonic obtained. The action of the lips on the reed is imitated to some extent in reed organ-pipes by means of a tuning-wire, with the difference that, the lips being mobile, different notes can be obtained from the same pipe, whereas in the organ each reed is adapted to its own pipe and gives one note only.

B. The *beating- or single-reed* mouthpiece, also known as the clarinet mouthpiece, is likewise of great antiquity; the principle is the same as that of the modern Egyptian *arghoul* (*g.n.*), which has been traced only at least in the hieroglyphics and in a fresco from the tombs at Saqqara.³ The mouthpiece of the *arghoul* is the primitive form of beating-reed known popularly in rural districts as a "squeaker." A lateral slit is made in a piece of reed and a little tongue is detached by slitting the reed back from the slit towards a knot. The breath causes the reed-tongue to close and open the aperture at regular intervals, and the exciting agent here acts by means of a series of concussions. The metal vibrator known as the beating-reed of organ reed-pipes is similarly constructed, except that the tongue is a separate piece of metal fixed by means of nuts over an aperture, the vibrating length being regulated by means of a tuning-wire (see FREE REED VIBRATOR).

The clarinet mouthpiece (fig. 3) has the appearance of a beak with the point bevelled and thinned at the edge to correspond with the end of the reed, shaped like a spatula. The underpart of the mouthpiece is flattened in order to form a table for the support of the reed, which is adjusted thereon with great nicety by means of a ligature or metal band fastened by screws. A longitudinal aperture $\frac{1}{2}$ in. long and $\frac{1}{4}$ in. wide, communicating with the bore, is cut in the table and covered by the reed, so that the only opening is at the point, where for the distance of $\frac{1}{2}$ to $\frac{3}{4}$ in. the reed is thinned and the table curves backwards, leaving a gap of about 1 mm. between itself and the reed-tongue (for the B \flat clarinet). The curve of the table and the dimensions of the gap are therefore of considerable importance. The reed is set in vibration by the breath of the performer, and being flexible it beats against the table, alternately opening and closing the gap, and producing, as already mentioned above, a series of concussions in harmony with the vibrations of the air-column within the tube, according to the length determined by the opening of the lateral holes and keys.

C. The *free-reed*, illustrated under FREE REED VIBRATOR, is similar in construction to the beating-reed, but the metal vibrator is cut slightly smaller than the aperture, through which it passes freely, alternately opening and closing it without concussion and with complete elasticity. The main difference in practice between these two outwardly similar reeds is a very important one. The reed being free remains uncontrolled, and increased pressure of wind therefore produces not an harmonic overtone but a crescendo. The principal use of the free-reed is in the harmonium (*g.n.*) and in the reed-work of organs on the continent of Europe. In English organs the beating-reed is almost universal. The free-reed is further used in the Chinese *cheng* (*g.n.*), through which it became known in Europe in the 18th century, and in the accordion, concertina and mouth-organ, under which headings its acoustic properties are more fully discussed.

4. *Cup-Mouthpieces.*—Brass wind instruments are played by means of cup or funnel-shaped mouthpieces, generally made of

¹ See *De audib.* p. 804a.

² Porphyrius (ed. Wallis), pp. 240 and 252.

³ See Victor Loret, *L'Égypte au temps des Pharaons* (Paris, 1880), illustrated on pp. 139 and 143. The author gives no information as to this fresco except that it is in the Musée Guimet; it is probably identical with the second of the mural paintings described on p. 190 of the *Petit guide illustré du Musée Guimet* (Paris, 1890).

silver. The principal feature of the cup is the shape of the aperture in the bottom, where it communicates with the bore of the tube (known as the "grain" or "throat"), and its distance from the rim. The shallower the cup the more suitable it is for producing the higher harmonics. The lips of the performer rest lightly but firmly against the rim of the mouthpiece, vibrating like double reeds from the force of the breath and communicating these vibrations in the form of pulses to the breath as it issues from them in a stream. This stream or exciting current passes into the cup ready to generate sound-waves in the air column contained within the main tube. If, as in the trumpet and in a lesser degree in the trombone, the curve of the bottom of the cup terminates at the hole in an abrupt angle, the quality of the tone developed is brilliant and blaring, being broken up by the sharp edge of the throat. In the horn, which has a funnel-shaped mouthpiece, the timbre is in complete contrast when the instrument is properly played,⁴ being elastic, sonorous and very mellow, qualities which may be attributed to the absence of angle or bottom to the cup, the sides gradually sloping and converging insensibly into the bore of the tube. (K. S.)

MOVERS, FRANZ KARL (1806–1856), German Roman Catholic divine and Orientalist, was born at Koesfeld in Westphalia, on the 17th of July 1806. He studied theology and Oriental languages at Münster, was parish priest at Berkum near Bonn from 1833 to 1839, and professor of Old Testament theology in the Catholic faculty at Breslau from 1839 to his death on the 28th of September 1856. His elaborate works, *Die Phönizier* (1841–1850) and *Phönizische Texte, erklärt* (1845–1847), attained a high reputation. Of his other writings two biblical studies were of some importance, his *Kritische Untersuchungen über die alttestamentliche Chronik* (1834), and his Latin essay on the two recensions of the text of Jeremiah, *De utriusque recensionis vaticiniorum Jeremiae . . . indole et origine* (1837).

MOW. (1) To cut down standing hay or corn with a scythe or with machinery drawn by a horse or mechanical power (see REAPING). The word in O.Eng. is *mawan*, a verb common to the West German languages, cf. Du. *mawen*, Ger. *mähen*; the root is also seen in "meadow." Gr. *μαύω* and Lat. *metere*, to reap, cut, cf. *messis*, harvest. (2) A stack or rick of hay, corn, and sometimes also of beans, peas or other crops. The word in O.Eng. is *muga*, *maha*, and is cognate with Swedish and Norwegian *muga*, heap, cf. Swedish *almoge*, crowd of people, Danish *almuc*. "Mow" is chiefly dialectal in England, where it is a common name, e.g. the Barley Mow, on the sign-boards of country inns. From these two words must be distinguished (3) "mow," a grimace, now obsolete or purely literary, and generally found in combination with "mop," cf. "mopping and mowing" in *King Lear*, iv. 1. 64. This is the same word as the modern Fr. *moue*, pout, which is of obscure origin.

MOWAT, SIR OLIVER (1820–1903), Canadian judge and statesman (Q.C. 1856, LL.D. 1872, K.C.M.G. 1892, G.C.M.G. 1897), was the son of John Mowat, who fought in the Peninsular War under Sir Arthur Wellesley (afterwards duke of Wellington). Born at Kingston, Ontario, on the 22nd of July, 1820, he was educated by private tuition and in 1836 began the study of law under Mr. (afterwards the Rt. Hon. Sir) John A. Macdonald. Called to the bar in 1841, he soon became a leading Chancery counsel and in 1856 "took silk." He entered parliament in 1858 as a Liberal and in 1863 became postmaster-general. He took a prominent part in the proceedings of the Quebec Conference of 1864, which settled the terms of the Confederation of the British North American provinces, and in the same year was appointed vice-chancellor of Upper Canada. Eight years afterwards (1872) the Hon. Edward Blake resigned the premiership of the province of Ontario, and Mowat was called to fill the vacant post. He continued to be premier of Ontario until the 13th of July 1896. Assisted by able colleagues and holding always a strong majority in the house, he gave to Ontario a

⁴ The horn may be so played, by forcing the breath in a certain manner, that its timbre approximates to that of the trumpet.

body of laws many of which have been copied by other provinces of the dominion and by several states of the American Union. In eight important cases which he argued before the Judicial Committee of H.M. Privy Council, he established, as against the contention of Sir John A. Macdonald, the proposition that the provincial legislatures were co-ordinate with and not subordinate to the parliament of Canada. To weaken his influence the Conservatives at Ottawa attempted to extend the boundaries of Manitoba, thereby reducing the area of Ontario; but Mr Mowat again appealed to the Judicial Committee and was again successful. According to Sir John A. Macdonald, Ontario contained under the "Quebec Act" only 116,782 sq. m.; but Mr Mowat gave it an area of 260,862 sq. m. When he returned home after this great victory he received an ovation unparalleled in the history of any Canadian statesman. One of his prominent characteristics was his loyalty to Britain. Between 1886 and 1896 Canadian trade was depressed, and men were leaving the country in thousands for the United States. Dr Goldwin Smith and other prominent men advocated commercial union with the United States, viz. that the two countries should maintain a uniform tariff against the rest of the world, with free trade as between themselves. Sir Oliver Mowat saw in this "veiled annexation," and by letters, speeches and pamphlets he crushed the movement so completely as to make his party more imperialist than the Conservatives had ever been. In July 1896 he was called to the senate of Canada and made minister of justice. In November 1897 he was appointed lieutenant-governor of his native province, and this office he held until he died at Government House, Toronto, on the 19th of April 1903.

See C. R. W. Biggar, *Sir Oliver Mowat, a Biographical Sketch* (Toronto, 1905).

MOWBRAY, the name of an Anglo-Norman baronial house, derived from Montbray (Manche) in Normandy south of St. Lo. It was founded at the Conquest by Geoffrey (de Montbray), bishop of Coutances. His brother's son Robert, who rebelled with him against William Rufus on the Conqueror's death, was made, after their reconciliation, earl of Northumberland, as his uncle's heir but was forfeited and imprisoned for life on rebelling again in 1095. A sister of Bishop Geoffrey was mother by Roger d'Aubigny (of Aubigny in the Cotentin) of two sons, Nigel and William, who were ardent supporters of Henry I., and were rewarded by him with great estates in England. William was made king's butler, and was father of William d'Aubigny ("de Albini"), first earl of Arundel (see ARUNDEL); Nigel was rewarded with the escheated fief of Geoffrey de la Guerche, of which Melton (Mowbray) was the head, and with forfeited lands in Yorkshire. Nigel married, by dispensation, the wife of his cousin, the imprisoned earl, but afterwards divorced her, and by another wife was father of a son Roger, who took the name of Mowbray.

Roger, a great lord with a hundred knights' fees, was captured with King Stephen at the battle of Lincoln, joined the rebellion against Henry II. (1173), founded abbeys, and went on crusade. His grandson William, a leader in the rising against King John, was one of the 25 barons of the Great Charter, as was his brother Roger, and was captured fighting against Henry III. at the rout of Lincoln (1217). His grandson Roger (1266-1298), who was summoned to parliament by Edward I., was father of John (1286-1322), a warrior and warden of the Scottish March, who, joining in Thomas of Lancaster's revolt, was captured at Boroughbridge and hanged. His wife, a Braose heiress, added Gower in South Wales and the Bramber lordship in Sussex to the great possessions of his house. Their son John (d. 1361) was father, by a daughter of Henry earl of Lancaster, of John, Lord Mowbray (c. 1328-1368), whose fortunate alliance with the heiress of Lord Segrave, by the heiress of Edward I.'s son Thomas, earl of Norfolk and marshal of England, crowned the fortunes of his race. In addition to a vast accession to their lands, the earldom of Nottingham and the marshalship of England were bestowed on them by Richard II., and the dukedom of Norfolk followed (see NORFOLK, THOMAS MOWBRAY, 1st duke of).

The 1st duke left two sons, of whom Thomas the elder was only recognized as earl marshal. Beheaded for joining in Scrope's conspiracy against Henry IV. (1405), he was succeeded by his brother John, who was restored to the dukedom of Norfolk in 1424. His son John, the third duke, was father of John, 4th and last duke, who was created earl of Warrenne and Surrey in his father's lifetime (1451). At his death (1475) his vast inheritance devolved on his only child Anne, who was married as an infant to Edward IV.'s younger son Richard (created duke of Norfolk and earl of Nottingham and Warrenne), but died in 1481.

The next heirs of the Mowbrays were then the Howards and the Berkeleys, representing the two daughters of the first duke. Between them were divided the estates of the house, the Mowbray dukedom of Norfolk and earldom of Surrey being also revived for the Howards (1483), and the earldom of Nottingham (1483) and earl marshalship (1485) for the Berkeleys. Both families assumed the baronies of Mowbray and Segrave, but Henry Howard was summoned in his father's lifetime (1640) as Lord Mowbray, which was deemed a recognition of the Howards' right; their co-heirs, from 1777, were the Lords Stourton and the Lords Petre, and in 1878 Lord Stourton was summoned as Lord Mowbray and Segrave. The former dignity is claimed as the premier barony, though De Ros ranks before it. Lord Stourton's son claimed, but unsuccessfully, in 1901-1906 the earldom of Norfolk (1312), also through the Mowbrays. Of the Mowbray estates the castle and lordship of Bramber is still vested in the dukes of Norfolk. The heraldic badge of the house was a mulberry-tree.

MOWBRAY, HARRY SIDDONS (1858-), American artist, was born of English parents at Alexandria, Egypt, on the 5th of August 1858. Left an orphan, he was taken to America by an uncle, who settled at North Adams, Mass. After a year at the United States Military Academy at West Point, he went to Paris and entered the atelier of Léon Bonnat, his first picture, "Aladdin," bringing him to public notice. He was made a full member of the National Academy of Design in 1891. Subsequently he was best known for his decorative work, especially "The Transmission of the Law," Appellate Court House; ceiling for the residence of F. W. Vanderbilt; and the ceiling and walls of the library of the University Club—all in New York. This last was executed in Rome, where, in 1903, he was made director of the American Academy.

MOWBRAY, ROBERT (d. 1125), a Norman who was appointed earl of Northumberland between 1080 and 1082. In 1088 he and his uncle Geoffrey, bishop of Coutances, sided with Robert, duke of Normandy, against William Rufus, but they were pardoned at the close of the rebellion. In 1091 Mowbray defeated Malcolm Canmore of Scotland, who had invaded England, and in 1093 surprised and slew this king near Alnwick; soon after this event he succeeded to his uncle's vast estates. In 1095 he led a rebellion which had for its object the transference of the crown from the sons of the Conqueror to Stephen of Aumale. Rufus marched against the earl in person, and Mowbray shut himself up in Bamborough Castle, but he was captured by treachery, escaped, and was captured again. He was then deprived of his possessions and kept a prisoner for the rest of his life, nearly thirty years.

See E. A. Freeman, *William Rufus*, especially Appendices C. C. F. F. (Oxford, 1882).

MOXON, EDWARD (1801-1858), British poet and publisher, was born at Wakefield in 1801. In 1826 he published a volume of verse, entitled *The Prospect, and other Poems*, which was received with some favour. In 1830 Moxon was started by Samuel Rogers as a London publisher in New Bond Street. The first volume he issued was Charles Lamb's *Album Verses*. Removing to Dover Street, Piccadilly, Moxon published an illustrated edition of Rogers's *Italy*, £10,000 being spent upon the illustrations. Wordsworth entrusted him with the publication of his works from 1835 onwards, and in 1839 he issued the first complete edition of Shelley's poems. Some passages in *Queen Mab* were the cause of a charge of blasphemy being

made against Moxon in 1841. The case was tried before Lord Denman. Serjeant Talfourd defended Moxon, but the jury returned a verdict of guilty, and the offensive passages were for a time eliminated. In 1840 he published Browning's *Sordello*; and in succeeding years works by Lord Houghton, Tom Hood, Barry Cornwall, Lord Lytton, Browning and Tennyson appeared. Edward Moxon died on the 3rd of June 1858, his business being continued by Mr J. B. Payne and Mr Arthur Moxon, who in 1865 published Swinburne's *Atalanta in Calydon*; but in 1871 it was taken over by Messrs Ward, Lock & Tyler.

MOXOS, MOJOS, MOHOS, a tribe of South American Indians living around the head-waters of the Madeira river, northern Bolivia, particularly on both banks of the Mamoré. They submitted to Inca domination, but in 1564 gallantly repulsed the Spaniards. A century later, however, the Jesuits were welcomed, and the Moxos became devout Catholics. They number some 30,000.

MOZAMBIQUE [São Sebastião de Moçambique], a town of Portuguese East Africa, seat of a Roman Catholic bishopric in the province of Goa, in 15° 4' S., 40° 44' E. The town occupies the whole of a small coral island at the mouth of Mossoril Bay. The name Mozambique, used first to designate the island, was also given to the town and extended to the whole of the Portuguese possessions on the east coast of Africa. There are three forts, of which the principal, St Sebastian, at the northern extremity of the island was built in 1510 entirely of stone brought from Portugal. It is quadrangular, and has bastioned walls nearly 70 ft. high. In it are mounted some modern guns. The harbour is small, but deep enough to admit vessels drawing 25 feet.

The inhabitants, who number about 7000, consist chiefly of Mahomedan negroes of mixed descent speaking a dialect of the Makwa language. There are Parsee, Banyan, Goanese and Arab traders, and about 300 Europeans, besides half-caste Portuguese. The annual average value of the imports for the three years 1904-1906 was £97,035, of the exports £71,636. The import trade is chiefly with Great Britain and India, the articles in chief demand being cotton, coloured shawls and hardware. The exports are chiefly groundnuts, rubber of inferior quality, sesamum and other oil seeds, tortoise-shell and ebony. Germany has a large share of the exports.

Mozambique was discovered by Vasco da Gama in 1498. There was then a flourishing Arab town on the island, of which no trace exists. The history of the Portuguese town is closely identified with that of the province, for which see PORTUGUESE EAST AFRICA. The commercial and political importance of Mozambique has been eclipsed by Lourenço Marques.

MOZARAB [Spanish *Mozarabe*, a corruption of the Arabic *Musta'rib*, coll. *Musta'riba*], a general term for persons not Arab by race who have assimilated themselves to the Arabs. It was applied by the Moslems in Spain to the Christian communities existing among them, in Cordova, Seville, Toledo and other large cities, in the exercise of their own laws and religion. The ancient liturgy used by the Christians of Toledo is commonly known as Mozarabic.

MOZART, WOLFGANG AMADEUS¹ (1756-1791), German composer, was born at Salzburg on the 27th of January 1756. He was educated by his father, Leopold Mozart, a violinist of high repute in the service of the archbishop of Salzburg. When only three years old he shared the harpsichord lessons of his sister Maria, five years his senior. A year later he played minuets, and composed little pieces, some of which are still preserved in Maria's music-book. When five years old he performed in public for the first time, in the hall of the university. In 1762 Leopold Mozart took Wolfgang and Maria on a musical tour, during the course of which they played before most of the sovereigns of Germany. The little "Wolferl's"² charming appearance and disposition endeared him to every one; and so innocent and natural were his manners that at Vienna he sprang

upon the empress's lap and kissed her. The emperor Francis I. sat by his side while he played, and called him his "little magician." When he slipped one day on the polished floor the archduchess Marie Antoinette, afterwards queen of France, lifted him up, whereupon he said, "You are very kind; when I grow up I will marry you." Yet, in spite of the petting he received at court, he remained as gentle and docile as ever, and so amenable to parental authority that he used to say, "Next after God comes my father." In 1763 the whole family started again. Wolfel now sang, composed, and played on the harpsichord, the organ and the violin, winning golden opinions everywhere. At every court he visited he was loaded with caresses and presents; but the journeys were expensive, and the family terribly poor. In Paris they lodged at the Bavarian embassy, giving performances on a grand scale both there and at Versailles, where Wolfel's organ-playing was even more admired than his performance on the harpsichord. Here, also, he published his first compositions—two sets of sonatas for the harpsichord and violin.

On the 10th of April 1764 Leopold Mozart brought his family to England, engaging a lodging in Cecil Court, St Martin's Lane, whence he afterwards removed to Frith Street, Soho. On the 27th of April and the 19th of May Wolfel played before the royal family with immense success, accompanying the queen in a song and playing at sight anything that the king set before him. He now made his first attempt at the composition of a symphony; published a third set of sonatas, dedicated to the queen; and wrote an anthem for four voices entitled *God is our Refuge*, for presentation to the British Museum.³ On the 17th of September 1765 the family left England for the Hague, where they remained some time, and where in March 1766 the young composer made his first attempt at an oratorio, commanding in Holland a success as great as that he had already attained in London, and astonishing his hearers at Haarlem by performing on what was at that time the largest organ in the world. In September 1767 he paid a second visit to Vienna, and at the suggestion of the emperor Joseph II. composed an opera buffa, *La Finta semplice*, which, though acknowledged by the company for which it was written to be "an incomparable work," was suppressed by a miserable cabal. The archbishop of Salzburg hearing of this commanded a representation of the rejected work in his palace, and appointed the young composer his "maestro di capella." The office, however, was merely an honorary one, and, since it did not involve compulsory residence, Leopold Mozart determined to complete his son's education in Italy, to which country he himself accompanied him in December 1769.

Wolfgang, now nearly fourteen years old, was already an accomplished musician, needing experience rather than instruction, and gaining it every day. At Milan he received a commission to write an opera for the following Christmas. Arriving in Rome on the Wednesday in Holy Week, he went at once to the Sistine Chapel to hear the celebrated *Miserere* of Gregorio Allegri, which, on returning to his hotel, he wrote down from memory note for note—a feat which created an immense sensation, for at that time the singers were forbidden to transcribe the music on pain of excommunication. Returning to Rome towards the end of June, he was invested by the pope with the order of "The Golden Spur," of which he was made a cavalier,⁴ an honour which he prized the more highly because, not many years before, it had been conferred upon Gluck. In July he paid a second visit to Bologna, when the Accademia Filarmonica, after subjecting him to a severe examination, admitted him to the rank of "compositore," notwithstanding a statute restricting this preferment to candidates of at least twenty years old. The exercise which gained him this distinction is a four-part composition (Köchel's Catalogue, No. 86) in strict counterpoint on the antiphon *Quaerite primum*, written in the severe ecclesiastical style of the 16th century and abounding in points of ingenious imitation and device.

¹ In the baptismal register his name stands, *Joannes Chryssostomus Wolfgangus Theophilus* (Lat. *Amadeus*, Ger. *Gottlieb*).

² The German diminutive of Wolfgang.

³ The original autograph is numbered "Select Case C, 21. d."

⁴ *Auratae militiae eques*.

In October 1770 Wolfgang and his father returned to Milan for the completion and production of the new opera. The libretto, entitled *Mitridate, Re di Pontio*, was furnished by an obscure poet from Turin, to the great disappointment of the young maestro, who had hoped to set a drama by Metastasio. The progress of the work was interrupted from time to time by the miserable intrigues which seem inseparable from the lyric stage, exacerbated in this particular case by the jealousy of the resident professors, who refused to believe either that an Italian opera could be written by a native of Germany, or that a boy of fourteen could manage the orchestra of La Scala, at that time the largest in Europe. Fortunately the detractors were effectively silenced at the first full rehearsal; and on the 26th of December Wolfgang took his seat at the harpsichord and directed his work amidst a storm of genuine applause. The success of the piece was unprecedented. It had a continuous run of twenty nights, and delighted even the most captious critics.

Wolfgang's triumph was now complete. After playing with his usual success in Turin, Verona, Venice, Padua and other Italian cities, he returned with his father to Salzburg in March 1771, commissioned to compose a grand dramatic serenata for the approaching marriage of the archduke Ferdinand, and an opera for La Scala, to be performed during the season of 1773. The wedding took place at Milan on the 21st of October; and the serenata, *Ascanio in Alba*, was produced with an effect which completely eclipsed the new opera of Hasse, *Ruggiero*, composed for the same festivity. Hasse generously uttered the often-quoted prophecy, "This boy will cause us all to be forgotten."

During the absence of Wolfgang and his father the great archbishop of Salzburg died; and in the spring of the year 1772 Hieronymus, count of Colloredo, was elected in his stead, to the honor of all who were acquainted with his real character. The Mozart family did their best to propitiate their new lord, for whose installation Wolfgang, after his return from Milan, composed an opera, *Il Sogno di Scipione*; but the newly-elected prelate had no taste for it, and was utterly incapable of appreciating the charm of any intellectual pursuit whatever. For a time, however, things went on smoothly. In October the father and son once more visited Milan for the preparation and production of the new opera, *Lucio Silla*, which was produced at Christmas with a success quite equal to that of *Mitridate*, and ran between twenty and thirty nights.

In the meantime Wolfgang continued to produce new works with incredible rapidity. In 1775 he composed an opera for Munich, *La Finta giardiniera*, produced on the 13th of January. In the following March he set to music Metastasio's dramatic cantata, *Il Re pastore*. Concertos, masses, symphonies, sonatas and other important works, both vocal and instrumental, followed each other without a pause. And this fertility of invention, instead of exhausting his genius, seemed only to stimulate it to still more indefatigable exertions. But the pecuniary return was so inconsiderable that in 1777 Leopold Mozart asked the archbishop for leave of absence for the purpose of making a professional tour. This was refused on the ground of the prelate's dislike to "that system of begging." Wolfgang then requested permission to resign his appointment, which was only an honorary one, for the purpose of making the tour with his mother. The archbishop was furious; but the plan was carried out at last, and on the 23rd of September the mother and son started for Munich. The results were not encouraging. Leopold hoped that his son, now twenty-one years old, might obtain some profitable court appointment; but in this he was disappointed. And, worse still, poor Wolfgang fell in love at Mannheim with Aloysia Weber, a promising young vocalist, whose father, the prompter of the theatre (uncle of the great composer Weber), was very nearly penniless. On hearing of this Leopold ordered his wife and son to start instantly for Paris, where they arrived on the 23rd of March 1778. Wolfgang's usual success, however, seemed on this occasion to have deserted him. His reception was a cold one; and, to add to his misery, his mother fell seriously ill and died on the 3rd of July. Reduced

¹ "Questo ragazzo ci farà dimenticare tutti."

almost to despair by this new trouble, he left Paris in September, rested for a while on his way home in Mannheim and Munich, was received by Aloysia Weber with coldness almost amounting to contempt, and in June 1779 returned to Salzburg, hoping against hope that he might make some better terms with the archbishop, who relented so far as to attach a salary of 500 florins (about £50) to his "concertmeister's" appointment, with leave of absence in case he should be engaged to write an opera elsewhere.

Two years later the desired opportunity presented itself. He was engaged to compose an opera for Munich for the carnival of 1781. The libretto was furnished by the abbatte Varesco, court chaplain at Salzburg. On the 29th of January 1781 the work was produced under the title of *Idomeneo, re di Creta*, with triumphant success, and thenceforth Mozart's position as an artist was assured; for this was not only the finest work he had ever written but incontestably the finest opera that had ever yet been placed upon the stage in any age or country.

And now the archbishop's character exhibited itself in its true colours. Art for its own sake he utterly disdained; but it flattered his vanity to retain a famous artist in his service with the power of insulting him at will. On hearing of the success of *Idomeneo* he instantly summoned the composer to Vienna, where he was spending the season. Mozart lost not a moment in presenting himself, but he soon found his position intolerable. That he should be condemned to dine with his patron's servants was the fault of the age, but the open disrespect with which the lowest menials treated him was due to the archbishop's example. His salary was reduced from 500 to 400 florins, he was left to pay his own travelling expenses, and he was not permitted to add to his means by giving a concert on his own account or to play anywhere but at the archiepiscopal palace. Archbishop Hieronymus was hated at court, and most of all by the emperor Joseph, who, on retiring to Laxenburg for the summer, did not place his name on the list of invited guests. This offended him so deeply that he left Vienna in disgust. The household were sent on to Salzburg, but Mozart was left to find lodgings at his own expense. Thereupon he sent in his resignation; and for this act of contumacy was insulted by the archbishop in terms too vulgar for translation. He persevered, however, in his resolution, taking lodgings in a house rented by his old friends the Webers, and vainly hoping for pupils, since Vienna at this season was perfectly empty. Happily he had a sincere though not a generous well-wisher in the emperor, and a firm friend in the archduke Maximilian. By the emperor's command he wrote a German opera, *Die Entführung aus dem Serail*, which on the 16th of July 1782 was received with acclamation, and not long afterwards was performed with equal success at Prague. This great work raised the national "Singspiel" to a level commensurate with that which *Idomeneo* had already attained for the Italian "opera seria."

The next great event in Mozart's life was not what one would have wished for him. Though Aloysia Weber had long since rejected him, his renewed intimacy with the family led to an imprudent marriage with her younger sister, Constance, a woman neither his equal in intellect nor his superior in prudence. The wedding took place at St Stephen's on the 16th of August 1782. By the end of the year the thrifless pair were deeply in debt. Mozart composed incessantly, played at numberless concerts, and was in greater favour than ever at court and with the nobility; but to the last day of his life his purse was empty. He had, however, many kind friends, not the least affectionate of whom was the veteran Haydn, who was sincerely attached to him. With Gluck he was on terms of courteous intercourse only. Salieri detested him, and made no secret of his dislike.

Mozart's next dramatic venture was a German singspiel in one act, *Der Schauspieldirektor*, produced at Schönbrunn, on the 7th of February 1786. Not quite three months later, on the 1st of May, he produced his marvellous *Le Nozze di Figaro*, the libretto for which was adapted from Beaumarchais by the abbé da Ponte. The reception of this magnificent work was enthusiastic. But Vienna was a hotbed of intrigue. Everything that could

be done by jealous plotters to mar the composer's success was done, and that so effectively that Mozart declared he would never bring out another opera in the city which treated him so meanly. Fortunately, *Figaro*, like *Die Entführung*, was repeated with brilliant success at Prague. Mozart went there to hear it, and received a commission to write an opera for the next season, with a fee of 100 ducats. Da Ponte furnished a libretto, founded on Tirso de Molina's tale, *El Convidado de piedra*, and entitled *Il Don Giovanni*. By the 28th of October 1787 the whole was ready with the exception of the overture, not a note of which was written. This circumstance has led to the idea that it was composed in haste, but it is certain that Mozart knew it all by heart and transcribed it during the night from memory, while his wife told fairy tales to keep him awake.

The opera was produced on the 29th of October with extraordinary effect, and the overture, though played without rehearsal, was as successful as the rest of the music.¹ Yet, when reproduced in Vienna, *Don Giovanni* pleased less than Salieri's comparatively worthless *Tarare*.

On returning to Vienna Mozart was appointed kammer-compositor to the emperor, with a salary of 800 gulden (£80). In April 1789 he accompanied Prince Lichnowski to Berlin, where King Frederick William II. offered him the post of "kapellmeister" with a salary of 3000 thalers (£450). Though most unwilling to quit the emperor's service, he informed him of the offer and requested leave to resign his appointment in Vienna. "Are you going to desert me, then?" asked the emperor; and Mozart, wounded by the reproach, remained, to starve. The emperor now commissioned Mozart to compose another Italian opera, which was produced on the 26th of January 1790 under the title of *Così fan tutte*. Though the libretto by Da Ponte was too stupid for criticism, the music was delicious, and the opera would probably have had a long run but for the emperor's death on the 20th of February. In March 1791 Mozart consented to write a German opera upon an entirely new plan for Schikaneder, the manager of the little theatre in the Wieden suburb. The piece was to be addressed especially to the Freemasons, and to contain ceaseless allusions both in the words and music to the secrets of the brotherhood. Deeply interested in the affairs of a body of which he was himself a member, Mozart excelled himself in this new work, which took shape as *Die Zauberflöte*. He was rewarded for his labours by a brilliant artistic success, but Schikaneder alone reaped the financial benefit of the speculation.

Before the completion of *Die Zauberflöte* a stranger called on Mozart, requesting him to compose a *Requiem* and offering to pay for it in advance. He began the work under the influence of superstitious fear, believing that the messenger had been sent from the other world to forewarn him of his own approaching death. Meanwhile he received a commission to compose an opera, *La Clemenza di Tito*, for the coronation of the emperor Leopold II. at Prague. He worked incessantly and far beyond his strength. The coronation took place on the 6th of September, and its splendours threw the opera very much into the shade. *Die Zauberflöte* was produced on the 30th of September and had a splendid run. But the *Requiem* still remained unfinished; the stranger therefore made another appointment, paying a further sum in advance. Mozart worked at it unremittingly, hoping to make it his greatest work. In the *Requiem* he surpassed himself, but he was not permitted to finish it. When the stranger called the third time the composer was no more. The score of the *Requiem* was reverently completed by Süßmayer, whose task may have been simplified by instructions received from Mozart on his deathbed. It is now known that the work was commissioned by Count Walsegg, who wished to perform it as his own.

Mozart died on the 5th of December 1791, apparently from typhus fever, though he believed himself poisoned. His funeral was a disgrace to the court, the emperor, the public, society itself. On the afternoon of the 6th his body was hurried to a

¹ Michael Kelly, in his *Reminiscences*, has left a delightful account of the circumstances.

pauper's grave; and because it rained, Van Swieten, Süßmayer, and three other "friends" turned back and left him to be carried to his last long home alone. (W. S. R.)

Mozart's work falls conveniently into three periods, though O. Jahn makes out, more accurately, five. Our first period may be said, in sober seriousness, to begin at the age of five and to merge into the second somewhere about the age of sixteen or seventeen. It was fortunate that the infancy of the sonata-forms (*q.v.*) coincided with the infancy of Mozart; for while this coincidence gave his earliest attempts a marvellous resemblance to the work of the fully-grown masters of the time, it secured for his mental activity a healthy and normal relation to the musical world which infant prodigies can never attain in a modern artistic environment. The little pieces composed by Mozart in his fifth and sixth years are a fascinating study in the unswerving progress made by a child who masters every step, not by some miraculous intuition that enables him to dispense with learning, but by a hardly less miraculous directness of thought that prevents him from either making the same mistake twice or exactly repeating a form once mastered. The violin sonatas written in London and Paris at the age of seven in no way fall below the accepted standards of the period, while they already show that variety of invention and experiment which, by the time he was twelve, caused some sober-minded critics to regard him as a dangerous person. His studies in the severer contrapuntal forms speedily gave him the greatest technical mastery of choral music attained since Bach; and more than one stray piece of church music, or movement from a mass or litany, written before he was fifteen, deserves to take rank as a true masterpiece of which the date is immaterial. At the age of fifteen we see a loss of freshness, especially in the numerous operas which show at its worst that hopeless condition of operatic art from which only Gluck's most drastic reforms could rescue it. Fortunately, Mozart had at fifteen acquired more than enough technique to rest upon; and thus the growing boy could keep his spirits up, continuing his public successes and indulging his easy sense of mastery, without putting a strain upon his brain which nature need revenge then or afterwards.

Lucio Silla, though loaded with conventional bravura arias, nevertheless shows him approaching the age of seventeen with clear signs of a man's power, and in higher qualities than mere variety and fancy. Some of its recitatives and choruses strike a solemn dramatic note hitherto undreamt of in stage music, except by Gluck. *La Finta giardiniera* first gave Mozart scope for the exercise of his wonderful stage-craft and power of characterization. Though it has not kept the stage, yet it marks the beginning of Mozart's true operatic career, just as the Masses in F and D, written in the same year, mark the close of his first really representative period as a composer of church music. It is, however, difficult to draw such lines definitely; for there is no period of Mozart's career in which he did not practise all arts at once; and the difficulty of drawing inferences as to the relative importance of different forms in his intellectual development is increased by his invariable mastery, which seems to depend neither on method nor on inspiration. Most of the pianoforte sonatas and many of the best-known violin sonatas belong to his early manhood. To the same period also belong those unfortunate masses which, together with several spurious works, were at one time so popular, and have since been accepted as evidence that he had not the depth of feeling and earnestness necessary for church music. *Idomeneo* and *Die Entführung* are currently regarded as quite early works, but they are later than any of the masses except the great unfinished work in C minor, and there is some really great church music of his later period in the shape of sung pieces, litanies and vespers (*i.e.* collections of psalms sung at evening service) which is almost totally neglected, and which shows a consistent solemnity and richness of style no less in keeping with Mozart's new artistic developments than worthy of the glories of Handel and Bach.

Idomeneo is the only opera of Mozart which unmistakably shows the influence of Gluck; because, with the exception of *La Clemenza di Tito*, it is the only opera seria by which Mozart is

known; and only a serious opera on a classical subject could furnish occasion for Gluck's phraseology and range of feeling to appear at all. How profoundly and independently Mozart seizes Gluck's method and style may best be seen by comparing the oracle scenes in *Idomeneo* and *Alceste*. In the management of the chorus, however, Mozart has, as was to be expected, incomparably the advantage. He has all, or rather more than all, Gluck's power for portraying panic and managing, by the motion of his music, the flight of a crowd; but he also has an inexhaustible harmonic and contrapuntal invention which lay beyond Gluck's scope.

The problems of comic opera presented a far more fruitful field. In *Die Entführung* he speedily showed a dramatic grasp for which *opera seria*, in spite of all the influence of Gluck, gave him no scope. He had a wonderful feeling for character, and did not imagine, like many French and other disseminators of musical-dramatic ideas (including, in moments of weakness, even Gluck himself), that the expression of character in music was a mere matter of harping on special types of phrase. His melodic invention was clearly and subtly characteristic without mannerism. It is of hardly minor importance that his own literary sense was far higher than that of many a writer of ostensibly superior general culture; and that Osmin, the most living figure in *Die Entführung*, is Mozart's creation, words and all.

After *Die Entführung*, Mozart's record is a series of masterpieces, accompanied, but not interrupted, by a running commentary of *pièces d'occasion*. With rare exceptions, everything he writes illustrates the perfect solution of an art-problem, and he often achieves an artistic triumph with the most eccentric materials. The modern organist can find since Bach no grander piece in his repertory than the two fantasias which Mozart wrote for the barrel of a musical clock. Shortly before his death he wrote a beautiful adagio and rondo for the glass harmonica, to which he devised the curious but eminently natural accompaniment of flute, oboe, viola and violoncello. And when at an earlier period it occurred to him to write some processional music for two flutes, five trumpets and four drums, the result, although not artistically important, might well have seemed to indicate long experience in handling the combination. His work in the larger instrumental forms is further discussed in the articles SONATA FORMS and INSTRUMENTATION. While Mozart's treatment of form has often been attacked as conventional, and his range of thought despised as childish, his instrumentation and general sense of euphony are at the present day more unreservedly admired by the most progressive propagandists than anything else in classical art.

Mozart's later operas, from *Figaro* onwards, represent the nearest approach to a perfect art-form attainable in pre-Wagnerian opera. What he might have attained in serious opera had he been spared to see the solemn triumphs the French operatic stage realized in the austere sincerity of Cherubini and Méhul it is impossible to guess. But we cannot doubt that a Mozart of yet riper experience than we have known would have given tragic opera a history in which *Fidelio* did not stand in lonely splendour. For Mozart, however, serious opera was an Italian art form, only temporarily rescued from the tyranny of bravura singers by Gluck. After *Idomeneo* he handled it only once, at the very close of his career, and then, as if to seal its fate, in a *pièce d'occasion* with an impossibly dull and unsympathetic libretto (*La Clemenza di Tito*). For comedy, however, his harmonic and rhythmic range was perfectly adapted; and in *Figaro* he had the advantage of a libretto which was already a finished literary product of consummate stagecraft before it ever became an opera. The perpetual surprises of its absurdly complex intrigues impose no real strain, for no one attempts to follow them; but they keep every character on the stage in a state of excitement which is so heightened and differentiated by the music that, while Beaumarchais's *Mariage de Figaro* has its modest but definite place in literature, Mozart's *Figaro* is, with all its lightness of touch, one of the most ideal classics in all art. The subject is not edifying; but Mozart does not analyse it from that point of view. His characters are irresponsible, mischievous

and fairy-like. Theirs is the world described by Lamb—"the Utopia of gallantry, where pleasure is duty and the manners perfect freedom."

In *Don Giovanni* the matter is less clear. Mozart rose, not only in the music of the ghostly statue, but also in the music of Donna Anna and Donna Elvira, to heights that can only be called sublime; yet he never lost sight of the true methods of that comedy of gallantry to which *Don Giovanni* stands in some sense as a grotesque tragic finale. It is the business of an artistic intellect to grasp the artistic possibility of a world in which the "Utopia of gallantry" is at war with a full-blooded and incipiently moral humanity until the critical moment determines, not the breaking up of the artistic unity, but the right conclusion of the story. If it is absurd to treat Donna Anna and Donna Elvira as Wagnerian heroines, and so to complain of the inadequacy and conventionality of much of their utterances and attitudes; so, also, is it no less absurd to regard them as "secretly rather gratified than otherwise to be on Don Giovanni's list." Donna Elvira has suffered more cruelly from stolidly tragic singers and no less stolidly flippant critics than she ever suffered from Don Giovanni himself. She comes upon the stage expressing herself in thoroughly conventional music, and we are told that the formulas of Italian opera are inadequate for the expression of her sorrows. Look at the *sforzando* in the second violins at the words *Ah se ritorno l'empio*. Mozart is depicting a young girl facing a position she does not in the least understand; expressing herself in stereotyped phrases as much from inexperience of their meaning as from lack of anything that may better say what she really feels. What Mozart's music with exquisite humour and simplicity expresses is as yet nothing more serious than the wish to scratch Don Giovanni's eyes out; as soon as his character is revealed to her in Leporello's comic aria of the "catalogue," she determines that others at all events shall not suffer as she has suffered; and from that moment her character steadily develops in seriousness and dignity. She is not all strength, and Don Giovanni fools her to the top of her bent; but nevertheless Mozart realizes, on hints of which the librettist was hardly conscious, a consistent scheme of development as dramatic as it is in keeping with the most sublime possibilities of comic opera. Yet it is a common practice to insert Elvira's last confession of weakness, the aria *Mi tradi*, immediately after Leporello's catalogue aria! Perhaps the first place where an intelligent tradition of Mozart as a comic genius of the highest type has been restored is Munich, where the standard set under the conductorship of Richard Strauss will not soon be forgotten.

In *Così fan tutte* Mozart's struggles with an absurd libretto show even clearer evidence of the accuracy and power of his genius than when he is working under conditions where success is possible. Space forbids our dwelling further on this subject, nor can we do more than glance at his last great opera, *Die Zauberflöte*. Beethoven thought it his greatest work; for the simple literal-minded sincerity with which Beethoven regarded the question of operatic libretto made *Figaro* frivolous and *Don Giovanni* scandalous in his sight. Mozart's very serious interest in freemasonry, which in its solemn ritual furnished an edifying contrast to the frivolity and uncongeniality of the existing state of church music, inspired him with the most sublime ideas hitherto brought upon the operatic stage. He was further stimulated by the feeling that freemasonry was to some extent a persecuted institution; and the circumstance that his librettist was a skilful stage manager secured for him that variety of action and effectiveness of entry and exit, compared with which an intelligible plot is of almost negligible importance as a source of inspiration to the classical composer, or even as a means of retaining popular favour. Thus *Die Zauberflöte* is an achievement unique in opera; combining as it does the farcical gorgeousness of a pantomime with the solemnity of a ritual and the contemporary interest of a political satire.

From the solemnity of masonic ritual there is but one step to that most pathetic of unfinished monuments, Mozart's *Requiem*. The finished portions of this work contain the most sublime and perfect church music between Bach and the *Missa solennis* of

Bethoven. The unauthentic portions, supplied by Stüssmayer, are so well designed that even their comparative slightness of material hardly militates against the suggestion that he may have had some inkling of Mozart's intentions. In particular, the return of the first number at the words *Lux aeterna*, which enables Stüssmayer to end with ten pages of authentic Mozart, is splendidly placed (though Mozart is reported to have contemplated an independent final number); while the latter part of the *Lacrimosa*, though not in Mozart's handwriting, must surely have been dictated by him. The instrumentation of the incomplete numbers is based for the most part on highly authentic evidence, though there are doubtful points; but that of the supplied numbers, especially the *Benedictus*, is far below the intellectual level of their design. In this, his last work, as in many wonderful polyphonic experiments immediately before it, Mozart showed unmistakable signs of the growth of a new style, which would undoubtedly have had an influence even more powerful on the history of music as being embodied in works surpassing his ripest known achievements as these surpass the marvellous productions of his childhood. Nevertheless, what he has given us is unique, and the intelligent love of Mozart's work is a liberal education in the meaning of art.

Mozart's extant works (as catalogued by Köchel in 626 items, beginning with minuets written at the age of four and ending with the *Requiem*) comprise 26 masses (including the *Requiem* and the great unfinished Mass in C minor); 8 sets of vespers and litanies; 40 smaller Latin pieces of church music; 6 cantatas and oratorio works, of which the greatest, *Davidde penitente*, is adapted from the C minor Mass; 17 "organ sonatas" (i.e. little movements for organ and an organ-loft band, for use in church); 23 operas (including fragments and overtures); 66 arias and other pieces for insertion into operas or for concert use; 41 songs with pianoforte accompaniment; 23 canons (mostly 2 rounds); 17 pianoforte sonatas; 5 fantasias and a Handelian suite (unfinished); 22 smaller pianoforte pieces; 36 cadenzas to his own pianoforte concertos; 11 works for pianoforte à quatre mains; 45 sonatas, including fragments and variations, for pianoforte and violin; 8 pianoforte trios; 2 pianoforte quartets and 1 quintet for pianoforte and wind; 2 duets for violin and viola; 2 string trios; 29 string quartets; 2 quartets for flute and strings; 1 quartet for oboe and strings; 9 string quintets, of which 1 is for the singular combination of 1 violin, 2 violas, violoncello and horn, and another is the famous Clarinet quintet; 49 symphonies; 33 cassations, serenades and divertimenti, many for the oddest orchestral or solo combinations; 27 smaller orchestral and other pieces, also often for strange combinations of surprising beauty; 29 sets of orchestral dances; 6 violin concertos (the 6th is either quite spurious or extremely corrupt) and 4 single violin movements; 2 double concertos (one for 2 violins, the other for violin and viola); 10 concertos and concert pieces for various wind instruments (flute, horn, bassoon, clarinet, flute and harp); 27 pianoforte concertos (including one for 2 and one for 3 pianofortes) and a concert rondo. Then there is an enormous number of fragments, many of them peculiarly promising, as if Mozart was full of ideas that were in advance of even his mastery of form; there is, for example, a magnificent and comparatively early opening tutti for a double concerto for pianoforte and viola, and a very large string quartet movement in A (probably a finale), which breaks off at an exciting moment at the beginning of its development.

No composer's reputation has suffered more from forgeries and false attributions than Mozart's, and the tale begun during the lifetime of his widow is not yet ended at the present day. The concertante for 4 wind instruments which recently went triumphantly round the orchestral societies of Europe as a long-lost work written during Mozart's visit to Paris (though it is not for the same instruments) is not so bad as the notorious forged masses, but it is, to any one acquainted with Mozart's style at any period of his career, almost as obviously spurious. Mozart often wrote without thought, but never, even when he was six years old, without mastery; and there is no genuine work that is as dull as this concertante, but none that is so obviously constructed by a fool. A panegyric of the concertante has been inserted in the latest (posthumous) editions of Jahn's biography, which it is very difficult to believe would have met with that great scholar's approval.

On the other hand, twelve recently discovered divertimenti for 2 clarinets and bassoon are delightful little works which, with all their slightness, only Mozart, and Mozart in full maturity, could have written. A seventh violin concerto appeared in November 1907, and, though inferior to the earlier ones, is undoubtedly genuine, every detail and quality of its organization being exactly in keeping with Mozart's progress in 1777, its alleged date.

Many genuine works are known in spurious forms; thus the motet *Splendete deus* is an unauthorized arrangement of a chorus from *König Thamos*, and most of the flute-music mentioned in the

article *Flute in Grove's Dictionary* (new ed.) consists of spurious arrangements, while several important genuine works are ignored.

(D. F. T.)

MOZDOK, a town of Russia, in Caucasia, and in the province of Terek, on the left bank of the river Terek, 605 ft. above sea-level, in 43° 41' N. and 44° 39' E., 50 m. N. of Vladikavkaz. The population, 8760 in 1863, numbered 14,583 in 1897, and consisted of Kabardians, Chechens, Ossetes, Georgians and Armenians. Built in 1763 by the prince of Kabardia, Mozdok soon became an important point in the Russian advance towards the Caucasus, and was fortified. In 1840 it was attacked by the Circassian patriot Shamyil and 5000 mountaineers. The melons and water-melons of Mozdok are widely famed; and vine-growing and silk-worm breeding prosper.

MOZLEY, JAMES BOWLING (1813-1878), English theologian, was born at Gainsborough, Lincolnshire, on the 15th of September 1813, and was educated at Oriel College, Oxford. He was elected to a fellowship at Magdalen in 1840. He took an active part in the Oxford movement, but could no more follow Newman into the Roman communion "than fly." He was joint editor of the *Christian Remembrancer*, but withdrew from the position because of his substantial agreement with the famous Gorham decision. He was one of the earliest supporters of the *Guardian*. In 1856 he became vicar of Shoreham, in 1869 canon of Worcester, and in 1871 regius professor of divinity at Oxford. He died at Shoreham on the 4th of January 1878.

He wrote *A Treatise on the Augustinian Doctrine of Predestination* (1855); *The Primitive Doctrine of Baptismal Regeneration* (1856); *A Review of the Baptismal Controversy* (1862); *Subscription to the Articles: a Letter* (1863); *Lectures on Miracles*, being the Bampton Lectures for 1865; and *Waking Ideas in Early Ages and their relation to the Old Testament Faith* (1877). *Essays, Historical and Theological*, appeared in 1878 (2 vols.), with a biographical preface by his sister Anne, who also edited some of his *Letters* (1884).

MOZLEY, THOMAS (1806-1893), English divine and writer, was born at Gainsborough in 1806, the son of a bookseller and publisher in that town. From Charterhouse school he proceeded to Oriel College, Oxford, where he became the pupil, and subsequently the intimate friend, of John Henry Newman. In 1831 he was ordained, and became, in 1836, rector of Cholderton, Wiltshire. He was, from its beginning, a strong supporter of the Tractarian movement, and after contributing for some time to the *British Critic*, the chief organ of the movement, succeeded Newman as editor in 1841. In 1843 he was on the point of joining the Roman Catholic Church. Newman, however, strongly advised him to take two years to reflect, and long before that period had elapsed Mozley had determined to remain an Anglican. In 1844 he began to write leading articles for *The Times*, and continued to do so regularly for many years. In 1847 he resigned his country living and settled in London, but in 1868 accepted the living of Plymtree, Devonshire. From 1876-1880 he was rural dean of Ottery St Mary's, Devon. He resigned his living in 1880, and removed to Cheltenham, where he died on the 17th of June 1893.

He was the author of *Reminiscences, chiefly of Oriel, and the Oxford Movement*, published in 1882.

MPONGWE (PONGOS), a settled Bantu people of the Gabun, West Africa, constantly confused with the Mpongwe or Fang (*q.v.*). The Mpongwe, who call themselves Ayogo or "the Wise," have a rich collection of national songs, myths and traditions, and the tribal elders know the "Hidden Words," a kind of secret language of unknown origin. Their language, a Bantu dialect, has been the means of communication between the tribes of the interior and the Europeans. The family organization is intricate and very similar to the Roman *patria potestas*; wives, children and slaves being all subservient to the father, who alone is really free. They practise the poison ordeal, and reverence vague and malignant spirits who require propitiation by offerings and ceremonies. The ghosts of the dead are especially feared.

MTSENSK (popularly *Amchensk*), a town of Russia, in the government of Orel, on the navigable Zusha River, 17 m. from its confluence with the Oka, and on the Moscow & Kursk railway, 32 m. N.E. of the city of Orel. Pop. (1900), 9390. It is

mentioned in the Russian chronicles as early as 1147. From 1230 to 1530 it was under the rule of Lithuania; in the latter year it was taken by Russia, and became one of her chief strongholds against the raids of the Tatars. It is now an important centre for trade in grain, hemp, hemp-seed oil, tobacco and spirits.

MTSKHET, a decayed town of Russian Transcaucasia, in the government of Tiflis, 13 m. by rail N.N.W. of the city of Tiflis, at the confluence of the Aragva with the Kura, at an altitude of 1515 ft. Pop. (1897), 1221. One of the oldest places in Georgia, it was the capital of that country until supplanted by Tiflis in the last year of the 5th century A.D. The most ancient seat of the Georgian kings was the castle of Arma-tskikhe, Armasis, or Harmozica, crowning a hill opposite to Mtskhet. The most memorable relic of the latter is the cathedral, said to have been originally founded in the 4th century, though the existing building dates from the 15th century and was restored in the 18th. In the graveyard attached to this convent graves have been opened which yielded objects of the Iron and Stone ages, and others of the era of the Roman emperor Augustus.

MUBARRAD, or **MOBARRAD** [Abū-l-'Abbās Maḥmūd ibn Yazīd ul-Adzī] (c. 826–898), Arabian grammarian, was born in Basra, and became the leader of the Baḥrān grammarians against the Kufan school. His judgment, however, was independent, as is shown by his attack on some points in the grammar of Sibawaihi, the greatest writer of his own school. He died at Bagdad.

His main work is the grammatical one known as the *Kāmil* (*Perfect*), which has been edited by W. Wright (Leipzig, 1864 seq.) and published at Constantinople (1869) and Cairo (1891). Two or three other works exist in MS.: cf. C. Brockelmann, *Gesch. der arabischen Litteratur*, i. 109 (Weimar, 1898). (G. W. T.)

MUCH WENLOCK, a market town in the municipal borough of Wenlock (*q.v.*), and the Ludlow parliamentary division of Shropshire, England, 163 m. N.W. from London on the Great Western railway. It lies at the north end of Wenlock Edge, a range running south-west from the Severn valley. A priory was founded here as a nunnery by St Milburg, granddaughter of Penda, about 680, and after being destroyed by the Danes was refounded by Leofric in 1017. Afterwards it was remodelled by Roger de Montgomery for Cluniac monks. There are beautiful remains of the priory church, chiefly Early English; but there is a chapter-house of ornate Norman work. The priory's house, still inhabited, is a remarkable specimen of 15th-century work, adjoining and incorporating remains in earlier styles. The parish church of Holy Trinity, close to the ruins, is of mixed styles from Norman onwards. There is a picturesque half-timbered guildhall (1580). Trade is mainly agricultural, but there are limestone quarries in the neighbourhood. Wenlock received the grant of a market from Henry III. in 1224. It was incorporated by Edward IV. in 1448, when it also received the privilege of returning members to parliament, but in 1885 it ceased to have separate representation.

MUCIANUS, LICINIUS, Roman general and statesman, lived during the 1st century A.D. His name shows that he had passed by adoption from the Mucian to the Licinian gens. About A.D. 55 he was sent by Claudius, who had become suspicious of his intimacy with Messalina, to Armenia with Domitius Corbulo. Under Nero he regained the imperial favour. After the death of Galba (69), Mucianus and Vespasian (who was at the time in Judaea) both swore allegiance to Otho, but when the civil war broke out Mucianus persuaded Vespasian to take up arms against Vitellius, who had seized the throne. It was agreed that Vespasian should stay behind to settle affairs in the East, while Mucianus made his way through Asia Minor and Thrace to attack Vitellius. He reached Rome the day after the death of Vitellius, and found Domitian, Vespasian's son, at the head of affairs, but until the arrival of Vespasian the real master of Rome was Mucianus. But he never wavered in his allegiance to Vespasian, whose favour he retained in spite of his arrogance. As no mention is made of Mucianus during the reigns of Titus or Domitian, he probably died during the reign of Vespasian. He was a clever writer and historian. He made a collection of the speeches and letters of the Romans of the older republican period, probably

including a corpus of proceedings of the senate (*Acta senatus*), and was the author of a work, chiefly dealing with the natural history and geography of the East, which is often quoted by Pliny as an authority, especially for fabulous statements.

See monograph by L. Brunn (Leipzig, 1870).

MUCIC ACID, $C_6H_{10}O_8$ or $HOOC-(CHOH)_2-COOH$, is obtained by the oxidation of milk, sugar, dulcitol, galactose, quercitol and most varieties of gum by nitric acid. It forms a crystalline powder which melts at 213° C. It is insoluble in alcohol, and nearly insoluble in cold water. When heated with pyridine to 140° C., it is converted into *allomucic acid*. When digested with fuming hydrochloric acid for some time it is converted into *α*-furfurane dicarboxylic acid (see FURFURANE); while on heating with barium sulphide it is transformed into *α*-thiophene carboxylic acid (see THIOPHENE). The ammonium salt yields on dry distillation carbon dioxide, ammonia, pyrrol and other substances. The acid when fused with caustic alkalis yields oxalic acid.

MUCILAGE (from Late Lat. *mucilago*, a mouldy juice, from *mucere*, to be mouldy), a term which denotes a viscid or glutinous mixture of water and any gummy vegetable substance (see GUM). Mucilages are useful in medicine as vehicles for various insoluble and other drugs, and in the arts as thickeners (in calico-printing, dyeing, &c.). The British pharmacopoeia contains the mucilages of acacia and tragacanth.

MUCKERS (Ger. *Muckern*, *i.e.* canting bigots, hypocrites), the nickname given to the followers of the teaching of Johann Heinrich Schönherr (1770–1826) and Johann Wilhelm Ebel (1784–1861). Schönherr, the son of a non-commissioned officer at Memel in Prussia, was educated at the university of Königsberg, where at that time the theological faculty, under the influence of Kantian idealism, was strongly rationalist in tendency. The lad, who was miserably poor, was dissatisfied with a philosophy which stopped short of an explanation of the "thing in itself," and, having been reared in the strictest orthodoxy, he set to work to develop, with the aid of the Bible, a philosophy of his own. In the end he believed himself to have reached ultimate knowledge, and became the prophet of a dualistic theosophy¹ so closely analogous to Gnosticism that it might have been taken for a deliberate revival, had not Schönherr's lack of education precluded any such idea. Among his converts was Ebel, who from 1810 onwards gained a great reputation in Königsberg as an earnest preacher of the orthodox doctrines of sin, grace and redemption, and in 1816 was appointed "archdeacon," *i.e.* principal pastor, at the old church in Königsberg. In the pulpit he was orthodox; but he gathered about him a select circle of the initiated, to whom in private he taught Schönherr's doctrines. Schönherr himself sank into the background, and eventually died in 1826. But Ebel continued his teaching, and was joined in 1827 by Heinrich Diestel, also a Lutheran pastor of Königsberg. They became father confessors to a wide circle of silly fashionable people in the Prussian capital. In view of their peculiar teaching as to "the purification of the flesh," which involved the minute regulation of the intercourse of married people, scandal was

¹ Schönherr distinguished two primal powers or principles—one male and active, the other female and passive—having both personality and volition; he called them Light and Darkness, Fire and Water. They moved freely in the void, and from their ultimate contact God and the world sprang into being. Evil came into existence owing to the fall of Lucifer, a Light-being created by God, who in revenge lent his aid to the powers of Darkness. Sin came with the Fall of Man; and this infection, inherited with the blood, necessitated redemption in order to restore the harmony of the primal powers. This was the work of Christ, who descended into a world the inhabitants of which are divided into children of Light and children of Darkness. The power of the Holy Ghost, emanating from Christ, perfects the higher natures in whom Christ's "law of righteousness" is represented and who to a certain extent share in his being; it becomes their duty to obtain control over the lower natures so as to struggle against the powers of Darkness in them—powers which can be overcome by prayer, fasting and self-mortification generally. The end was near and the triumph of the Light assured. Anti-christ (Napoleon) had already appeared, and when Christ came he would find no faith on the earth (Luke xviii. 8) because faith would be swallowed up in knowledge.

inevitable. Matters came to a head in 1835, when Count Finckenstein, himself formerly an initiate, denounced the two pastors and accused them of immorality. Diestel wrote two violent tirades against the count, who brought an action for slander and won it. The evidence taken in the case was then laid before the consistory, and proceedings followed which became famous as the "Königsberger Religionsprozess" (1835-1841),¹ ending in sentences of deprivation on both Ebel and Diestel. The charges of actual immorality were dismissed; but there is no doubt that some of their followers established practices akin to those of the Agapemone and the Perfectionists. Some of them migrated to Brazil, where in 1874 at Porto Alegre a company of them came into collision with the military.

See J. I. Mombert, *Faith Victorious* (London, 1882); Hepworth Dixon, *Spiritual Wives* (1868); and, more especially, the article on Schönherr, by P. Tschackert, in Herzog-Hauck, *Realencyklopädie* (3rd. ed., Leipzig, 1906), xvii, 676.

MUCUNA, a genus of twining plants, belonging to the natural order Leguminosae, and natives of the tropics. *M. pruriens* is popularly known as cowhage or cowitch, a corruption of the Hindu *Kiwach*. It is a tall annual climber with large dark purple pea-like flowers, and golden-brown velvety pods recalling those of the sweet pea, the hairs or bristles on which often raise blisters on the skin. It is common in the tropical regions of India, Africa and America, and the hairs on the pod have long been used in medicine as a vermifuge.

MUDANIA (anc. *Apamea Myrlea*), a town of Asia Minor, on the south coast of the Sea of Marmora, and the port of Brusa. It is connected with Brusa by a railway and a carriage road, and with Constantinople by steamers. Olive oil is produced. Pop., 5900, of which two-thirds are Greeks.

MUDHOL, a native state of India in the southern division of Bombay. Area, 368 sq. m.; pop. (1901), 63,000; revenue, £20,000. It was a Mahratia principality dating from Mahomedan rule before the rise of Sivaji. The family name of the chief is Ghorpade. The town of Mudhol stands on the left bank of the Ghatprabha; pop. (1901), 8359.

MUDIE, CHARLES EDWARD (1818-1890), English publisher and founder of Mudie's Lending Library, was born at Chelsea on the 18th of October 1818, the son of a secondhand bookseller and newsagent. In 1840 he established a stationery and book-selling business in Bloomsbury, London. He was the first publisher of James Russell Lowell's poems in England, and of Emerson's *Man Thinking*. In 1842 he began to lend books. This department proved so successful that in 1852 he moved his "Select Library" to larger premises in New Oxford Street, London. In 1860 these premises were substantially enlarged, and branches of the business established, and in 1864 "Mudie's" was converted into a limited company. Mudie himself died on the 28th of October 1890.

MUFF, an article of outdoor apparel, open at either end, for holding the hands in and keeping them warm, generally made of fur, but also of velvet, silk, &c. Muffs are now only used in England by women, but in the 17th and 18th centuries were fashionable for men. In Roman times the place of the glove was taken by long sleeves (*manicae*) reaching to the hand, and in winter special sleeves of fur were worn (cf. Cic. *Phil.* ii. 11, 26). In Mediaeval Latin we find the word *muffulae*, defined by Du Cange (*Gloss.*, s.v.) as *chirothecae pellitae et hibernae*. He quotes from a cartulary of the year 817, of the issuing to monks of sheep-skin coverings to be used during the winter. These may have been, as the Roman certainly were, separate coverings for each hand, although the cartulary cited also distinguishes the glove for summer from the *muffulae* for winter wear. The O. Fr. *mouffe* meant a thick glove or mitten, and from this the Du. *mof*, Walloon *mouffe*, and thence Eng. "muff," are probably derived. From the Fr. *mouffe* have come the various uses, verbal and substantival, of "muffle," viz. to wrap round for protection, for deadening sound &c., and for a chamber or receptacle in a furnace to protect objects from contact with fire while exposed to heat. The slang use of "muff" for a clumsy, awkward person is of late origin. It appears in the middle of the 19th century.

¹ The contemptuous designation *Muckern* dates from this time.

MÜFFLING, FRIEDRICH KARL FERDINAND, FREIHERR von, called **WEISS** (1775-1851), Prussian general field marshal, was born on the 12th of June 1775, and entered the Prussian army in 1790. In 1799 he contributed to a military dictionary edited by Lieutenant W. von Leipzig, and in the winter of 1802-1803, being then a subaltern, he was appointed to the newly-formed general staff as "quartiermaster-lieutenant." He had already done survey work, and was now charged with survey duties under the astronomer F. X. von Zach (1754-1832). In 1805, when in view of a war with France the army was placed on a war footing, Müffling was promoted captain and assigned to the general staffs, successively, of General von Wartensleben, Prince Hohenlohe and Blücher. In 1806 he served under Hohenlohe, the duke of Saxe-Weimar, and Blücher, and was included in the capitulation of the latter's corps at Rattkau, after which he entered the civil service of the duke of Weimar. He rejoined the army on the outbreak of the War of Liberation in 1813, and was placed on the headquarters staff of the army of Silesia. His business qualities and common sense were greatly valued, though the temperamental differences between Müffling and Gneisenau often led to friction, especially as the former was in a measure the representative of the antiquated "topographical" school of strategists, to whom (rightly in the main) the disaster of Jena was attributed. In the interval between the first occupation of Paris and the Hundred Days, Müffling served as chief of the staff to the Russian general Barclay de Tolly and to General Kleist von Nollendorf. He was Prussian commissioner at the duke of Wellington's headquarters in the Waterloo campaign, and was involved in the various controversies which centred round the events of the 16th of June 1815. After the final fall of Napoleon he served on the staff of the army of occupation in France and was for some months military governor of Paris. He spent a part of his time on the Rhine in survey work, and was employed by Frederick William III. in various diplomatic missions. In 1821 he became chief of the general staff at Berlin, and though he has been accused of indulging his taste for topographical work at the expense of training for war, his work was not wasted, for he gave an excellent organization to the general staff, and executed elaborate and useful surveys. In 1829 he visited Constantinople and St Petersburg in connexion with negotiations for peace between Russia and Turkey. He took a prominent part in the military and civil history of Prussia, and from 1838-1847 was governor of Berlin. Failing health compelled his retirement in the latter year, and he died on the 16th of January 1851, at his estate of Ringhofen near Berlin.

Under the initials of C(arl) von Weiss, he wrote various important works on military art and history: *Operationsplan der preuss.-sächs. Armee 1806* (Weimar, 1807); *marginalia on the archduke Charles's Grandsée de röhären Kriegskunst für die Generale der oesterr. Armee*, and on *Höhren von Lilienstern's Bericht über die Vorgänge bei der Hohenloheschen Armee 1806; Die preussisch-russische Kampagne bis zum Waffenstillstande 1813* (Berlin, 1813); *Geschichte der Armee unter Wellington und Blücher 1815*; (Stuttgart, 1817); *Zur Armeegesch. der Jahre 1813-1814; die Feldzüge der schlesischen Krieges von der Beendigung des Waffenstillstandes bis zur Eroberung von Paris* (Berlin, 1824); *Betrachtungen über die grossen Operationen und Schlachten 1813-1815* (Berlin, 1825); *Napoleons Strategie 1813* (Berlin, 1827); and an essay on the Roman roads on the lower Rhine (Berlin, 1834). Müffling was also the inventor of a system of hachuring for maps. His reminiscences, *Aus meinem Leben*, were published at Berlin in 1851.

MUFTĪ, a consulting canon-lawyer in Islām, who, upon application, gives *fatwās* (*jetnas*) or legal opinions on points of canon law (see MAHOMMEDAN LAW). These are asked and given in strictly impersonal form, but the *cadi*, or judge, then applies them to the case and decides in accordance with them. In theory, any learned man whose opinion is respected and whose advice is sought can give *fatwās*. But generally in a Muslim state there are muftis specifically appointed by the government, one for each school of canon law in each place. Each of these renders opinions in accordance with the law-books of his school;

² The use of the word for plain or civilian clothes worn instead of uniform is originally Anglo-Indian. It may have been suggested by the loose flowing robes of the stage "mufti," and thus implied any easy dress worn by an officer when out of uniform.

he has noscope for free interpretation; everything is fixed there, and he must follow the precedents of the elders. In Turkey there is a chief mufti, called the Sheikh al-Islam, whose office was created by the Ottoman sultan, Mahommed II., in 1453, after the capture of Constantinople. He is, in a sense, the head of the ecclesiastical side of the state, that controlled by canon law; while the grand vizier is at the head of secular matters. Although his powers are delegated by the sultan-caliph, and he is appointed and can be dismissed by him, yet in his fatwā-issuing power he is independent. The sultan may dismiss him before he has a chance to issue a fatwā, but if he once issues it the result is legally automatic, even though it means the deposition of the sultan himself. Thus it was by a fatwā of the Sheikh al-Islam that the sultan Abdul Hamid was deposed.

See Juynboll, *De mohammedaansche Wet.*, 40 sqq.; De Slane's trans. of Ibn Khaldūn's *Prolegomenes*, l. lxxviii. 447 sq.; *Turkey in Europe*, by "Odysseus," 131 sq.; Young, *Corps de droit ottoman*, l. x., 285, 289. (D. B. MA.)

MUGGLETON, LODOWICKE (1609-1698), English sectarian, was born in Bishopsgate Street, London. His father was a farrier, but he himself was bred to be a tailor. In 1651 he began to have revelations, and to proclaim himself and his cousin John Reeve, whose journeyman he was, as the two witnesses mentioned in Rev. xi. 3. In 1652 they put out their "commission book" under the title *The Transcendent Spiritual Treatise*. An exposition of their doctrines was published in 1656 under the title *The Divine Looking-Glass*. Among other views (besides the doctrine of the divine mission of the authors) this work taught that the distinction of the three persons in the Trinity is merely nominal, that God has a real human body, and that He left Elijah as His vicegerent in heaven when He Himself descended to die on the cross. Muggleton's opinions gained some notable adherents, but also called forth much opposition. In 1653 he was imprisoned for blasphemy, and twice (1666 and 1670) his own followers temporarily repudiated him. His attack on the Quakers drew forth William Penn's book, *The New Witnesses proved old Heretics* (1672). In 1677 Muggleton was tried at the Old Bailey, convicted of blasphemy, and fined £500. Reeve died in 1658, but Muggleton survived till 1698.

His collected works, including the posthumous *Acts of the Witnesses*, were published in 1756; and in 1832 some sixty Muggletonians subscribed to bring out a new edition of *The Works of J. Reeve and L. Muggleton* (in 3 vols. 4to). Even as late as 1846 *The Divine Looking-Glass* was reprinted by members of the then almost extinct sect. See A. Jessopp, *The Coming of the Friars* (1888).

MUGWUMP, in American political slang, a name applied to any independent voter, and especially to those independents in the Republican party who refused to support James G. Blaine, when nominated by that party for the presidency in 1884; as since adopted in England it usually means one who stays neutral and votes for no party. Originally "mugwump" (*mogkiomp*) was a North American Indian word, in the Massachusetts dialect of the Algonquian, meaning "great man" (*mogki, great; omp, man*); and in New England it was used of self-conceited politicians.

MUHAMMERAH (MOHAMMERAH), a town of Persia, in the province of Arabistan, in 30° 26' N., 48° 11' E., on the Hafar canal, which joins the Karun with the Shatt el Arab, and flows into the latter 40 m. above its mouth at Fao and about 20 m. below Basra. It has post and telegraph offices, and a population of about 5000. With the opening of the Karun river, as far as Ahvaz, to international navigation in 1889, Muhamrah acquired greater importance, and its customs, which until then were leased to the governor for £1500 per annum, rose considerably, and paid £8000 until taken over by the central customs department under Belgian officials in 1902. It is estimated that the value of the imports and exports into and from Muhamrah, excluding specie, is about £300,000 per annum, paying customs amounting to about £18,000. Until 1847, when it definitely became Persian territory in accordance with art. ii. of the treaty of Erzerum, Muhamrah was alternately claimed and occupied by Persia and Turkey, its ruler, an Arab sheikh, helping either power as he found it convenient. Since then the governor of the town and

adjoining district has been a sheikh of the K'ab or Chaab Arabs, a powerful tribe of the Shi'ah branch of Islam. At the close of the Anglo-Persian campaign in 1857 Muhamrah was taken by a British force.

MÜHLBERG, a town of Germany, in Prussian Saxony, on the left bank of the Elbe, 8 m. below Riesa. Pop. (1905), 3380. It carries on a considerable trade by water in timber and corn. Mühlberg is famous for the victory gained here, on the 24th of April 1547, by the emperor Charles V. over the elector of Saxony, John Frederick.

See Lenz, *Die Schlacht bei Mühlberg* (Gotha, 1879); and Bertram, *Chronik der Stadt Mühlberg* (Torgau, 1864).

MUHLBERG, HENRY MELCHIOR (1711-1787), German-American Lutheran clergyman, was born in Einbeck, Hanover, on the 6th of September 1711. When he was twelve years old his father, a member of the city council, died. The son entered the university of Göttingen in 1735, and his work among the poor of Göttingen led to the establishment of the present orphan house there. In 1738 he went to Halle to finish his theological studies; he was a devoted worker in the Franckesche Stiftung, which later served as a partial model for his great-grandson's community at St Johnland, Long Island. He was deacon at Grosshennersdorf, in Upper Lusatia, in 1739-1741. In 1742, in reply to a call from the Lutheran churches of Pennsylvania, he went to Philadelphia, and was joined from time to time, especially in 1745, by students from Halle. Muhlenberg occupied himself more particularly with the congregation at New Providence (now Trappe), though he was practically overseer of all the Lutheran churches from New York to Maryland. In 1748 he organized the first Lutheran synod in America. Muhlenberg married in 1745 Anna Maria Weiser, daughter of J. Conrad Weiser, a well-known Indian interpreter, and herself said to have had Indian blood in her veins; by her he had eleven children. Throughout the War of Independence he and his sons (see below) were prominent patriots. He died at Trappe on the 7th of October 1787. The importance of his work in organizing and building up the American Lutheran Church, of which he has been called the Patriarch, can hardly be exaggerated; but his example in preaching in English as well as in German was, unfortunately for the growth of the Lutheran Church, not followed by his immediate successors. He had no sympathy with the Old Lutherans and their strict orthodoxy—on the contrary he was friendly with the Reformed congregations, and with George Whitefield and the Tennents.

See *Life and Times* by William J. Mann (Philadelphia, 1887).

MUHLBERG, JOHN PETER GABRIEL (1746-1807), American preacher and soldier, son of H. M. Muhlenberg (q.v.), was born at Trappe, Pennsylvania, on the 1st of October 1746. With his two brothers he was educated in Germany. He entered the Lutheran ministry, had charge of churches at New Germantown and Bedminster, New Jersey, and after 1772 of a church in Woodstock, Virginia, and there in 1775 raised the 8th Virginia (German) regiment, of which he was made colonel; in February 1777 he became a brigadier-general in the Continental Army; and in September 1783 was breveted major-general. He took part in the battles of Brandywine, Germantown and Monmouth, and at Yorktown commanded the first brigade of light infantry. After the war he removed to Pennsylvania. He was a member of the Virginia convention of 1776, was vice-president of the supreme-executive council of Pennsylvania in 1787-1788, and was a representative in Congress in 1789-1791, in 1793-1795, and in 1799-1801. In 1801 he was elected as a Democratic-Republican to the United States Senate, but immediately resigned to become supervisor of revenue for the district of Pennsylvania. He became collector of the port of Philadelphia in 1803. He was a friend of Thomas Jefferson and of James Monroe.

See *Life* by Henry A. Muhlenburg (Philadelphia, 1849).

His brother, **FREDERICK AUGUSTUS CONRAD MUHLENBERG** (1750-1801), became his father's assistant in Philadelphia in 1770; was pastor of the Christ (or Swamp) German Lutheran Church of New York City from 1773 to 1776; and in 1777-1779 was assistant to his father at New Hanover. In 1779-1780 he was

a member of the Continental Congress, in 1780-1783 of the Pennsylvania general assembly (then consisting of only one house), and in 1780-1790 of the state constitutional convention. He was president of the Pennsylvania convention which ratified the federal constitution, and was a member in 1789-1797 of the national House of Representatives, of which he was speaker in 1789-1791 and 1793-1795. On the 29th of April 1796, as chairman of the committee of the whole, he cast the deciding vote for the laws necessary to carry out Jay's treaty.

Another brother, GOTTLIF HENRY ERNEST MUHLENBERG (1753-1815), was a prominent Lutheran clergyman, and was pastor of a church in Lancaster, Pennsylvania, from 1779 to his death; but he is best known as a botanist, and published *Catalogus plantarum Americae septentrionalis* (1813) and *Descriptio uberior graminum et plantarum calamariorum Americae septentrionalis indigorum et circum* (1817).

See John M. Maisch, *G. H. E. Muhlenberg als Botaniker* (1886).

Gottlieb's son, HENRY AUGUSTUS MUHLENBERG (1782-1844), was pastor of a Lutheran Church in Reading, Pennsylvania, in 1802-1828, was a Democratic representative in Congress in 1829-1838, and was United States minister to Austria in 1838-1840.

MUHLENBERG, WILLIAM AUGUSTUS (1796-1877), American philanthropist and Protestant Episcopal clergyman, great-grandson of H. M. Muhlenberg and grandson of F. A. C. Muhlenberg, was born in Philadelphia, Pennsylvania, on the 16th of September 1796. He graduated at the university of Pennsylvania in 1815. In 1817 he was ordained a deacon in the Protestant Episcopal Church, and became assistant to Bishop William White (1748-1836) in the rectorship of Christ Church, St Peter's and St James's, Philadelphia. In 1820 he was ordained priest and until 1826 was rector of St James's Church, Lancaster, Pennsylvania. Largely owing to his efforts, Lancaster was the second public school district created in the state. His interest in church music and hymnody prompted his pamphlet of 1821, *A Plea for Christian Hymns*; he drew up for the use of his own parish a collection of *Church Poetry* (1823); and in 1823 he was appointed by the General Convention a member of the committee on psalms and hymns, whose collection, approved in 1826, contained several of Muhlenberg's own compositions, including "I would not live away," "Shout the glad tidings," and "Saviour, who thy flock art feeding." From 1826 to 1845 he was rector of St George's, Flushing, Long Island, where in 1827 he became head of the Flushing Institute, probably the first Protestant Episcopal "church school" in the United States. He founded a St Paul's College, to include the institute, but the panic of 1837 and the refusal of a charter by the state legislature brought it to an end; and the property was sold a few years after Muhlenberg left Flushing. The methods of this institute were however copied widely; church schools sprang up everywhere; and St Paul's School, Concord, New Hampshire, and the Groton School in Massachusetts were established in accordance with his ideas. In 1845 he removed to New York City, where in 1846 he became rector of the Church of the Holy Communion, a "free" church built by his sister, Mrs Mary A. Rogers. Here Muhlenberg founded the first American order of Protestant Episcopal deaconesses, the Sisterhood of the Church of the Holy Communion, begun in 1845 and formally organized in 1852. The work of the sisterhood led to Muhlenberg's establishment of St Luke's Hospital (opened in 1858), for which his congregation made offerings each St Luke's Day after 1846. In 1866 he founded on Long Island the Church Industrial Community of St Johnland. He bought 535 acres (mostly wooded), with a shore front of 13 m. on Long Island Sound, near King's Park, 45 m. from New York City, to be a home for the aged and for young children, especially cripples.¹ The plan was not reformatory nor purely

¹The Society of St Johnland, incorporated in 1870, has a chapel, the Church of the Testimony of Jesus (1869), St John's Inn, the home for old men (also built in 1869), Sunset Cottage, a home for twelve aged couples, Muhlenberg House for old women, the Fabbri Home, the Sunbeam Cottage (given by Mr and Mrs Cornelius Vanderbilt in 1881) Lawrence House, for babies, a library and village hall, a kindergarten, a school house, and the "mansion." Dr Muhlenberg's home at St Johnland and later the home of Sister Anne Ayres, his biographer, during her superintendence of the society.

charitable, and a moderate rent was charged for the cottages. In the St Johnland cemetery is the grave of Dr Muhlenberg, who died on the 8th of April 1877 in St Luke's Hospital, New York City. His ideal of the church was that it was missionary and evangelical as well as catholic with formal government and ritual; hence he called himself an "evangelical Catholic" and wrote the *Evangelical Catholic Papers*, which were collected and published by Anne Ayres in 1875-1877.

See Anne Ayres, *Life and Work of William Augustus Muhlenberg* (New York, 1880), and W. W. Newton, *Dr Muhlenberg* (Boston, 1890), in the "American Religious Leaders" series.

MÜHLHAUSEN, a town of Germany, in Prussian Thuringia, on the right bank of the Unstrut, 25 m. N.W. of Gotha by rail. Pop. (1905), 34,359. It consists of a new and an old town, surrounded by five suburbs, and has numerous old churches and towers. The most interesting churches are those of St Mary and of St Blasius, dating respectively from the 14th and the 12th century; the town-hall is also a fine medieval structure. The chief industries are the spinning and weaving of woollen and cotton. Other manufactures include needles, machinery, cigars soap, hosiery, furniture and shoes. There are also establishments for dyeing, tanning, lime-burning, iron-making, brewing and the preparation of liqueurs.

Mühlhausen is one of the oldest towns in Thuringia, and is said to have been fortified in 925. Its early importance is shown by the grant of privileges made to it by the German King Henry I., and by the diet held here in 1135. During the Reformation period Mühlhausen became notorious as one of the chief seats of the Anabaptists. Thomas Münzer, one of their leaders, was captured in the vicinity and executed in the town. Internal dissensions and injuries received during the Thirty Years' War and the Seven Years' War afterwards reduced Mühlhausen to unimportance. In 1802 it lost its independence and passed to Prussia, in 1807 it was attached to the kingdom of Westphalia, but in 1815 it again became Prussian. The Teutonic Order established itself at Mühlhausen in 1200.

See E. Heydenreich, *Aus der Geschichte der Reichsstadt Mühlhausen* (Halle, 1900); Nebelsieck, *Reformationgeschichte der Stadt Mühlhausen* (Mageburg, 1905); Herquet, *Urkundenbuch der ehemaligen freien Reichsstadt Mühlhausen* (Halle, 1874); F. Stephan, *Verfassungsgeschichte der Reichsstadt Mühlhausen* (Sondershausen, 1886); Jordan, *Chronik der Stadt Mühlhausen* (Mühlhausen, 1900-1906); and *Führer durch Mühlhausen und Umgegend* (1901).

MUIR, JOHN (1810-1882), Scottish Orientalist, was born on the 5th of February 1810 in Glasgow, where his father, William Muir (d. 1821), was a merchant. He was educated at the grammar school of Irvine, the university of Glasgow, and the East India Company's College at Haileybury. He went to India in 1829, and served with distinction in various offices, as assistant secretary to the board of revenue, Allahabad, as collector at Azimgarh, as principal of the Victoria College, Benares, and as civil and session judge at Fatehpur. He encouraged the study of Sanskrit, and furthered schemes for the enlightenment and amelioration of the Hindus. In 1853 he retired and settled in Edinburgh, where he continued his Indian labours. In 1862 he endowed the chair of Sanskrit in the university of Edinburgh, and was the main agent in founding the Shaw fellowship in moral philosophy. He was a D.C.L. of Oxford, LL.D. of Edinburgh and Ph.D. of Bonn, and was one of the first to receive the distinction of C.I.E. He died on the 7th of March 1882.

In 1858 appeared vol. i. of his *Original Sanskrit Texts* (2nd ed., 1868); it was on the origin of caste, an inquiry intended to show that it did not exist in the Vedic age. Vol. ii. (1st ed., 1860; 2nd, 1871) was concerned with the origin and racial affinities of the Hindus, exhibiting all the then available evidences of their connexion, their linguistic, social and political kinship, with the other branches of the Indo-European stock. Vol. iii. (1st ed., 1861; 2nd, 1868) was on the Vedas, a full inquiry as to the ideas of their origin, authority and inspiration held both by the Vedic and later Indian writers. Vol. iv. (1st ed., 1863; 2nd, 1873) was a comparison of the Vedic with the later representations of the principal Indian deities, an exhibition of the process by which three gods hardly known to the Vedic hymns became the deities of the former Hindu Trimurti. Vol. v. (1870) was on the Vedic mythology. Dr Muir was also the author of a volume of *Metrical Translations from the Sanskrit*, an anonymous work on *Inspiration*, several works in Sanskrit, and many essays in the *Journal of the Royal Asiatic Society* and elsewhere.

MUIR, SIR WILLIAM (1810-1905), Scottish Orientalist, brother of the preceding, was born at Glasgow on the 27th of April 1810. He was educated at Kilmarnock Academy, at Glasgow and Edinburgh Universities, and at Haileybury College, and in 1837 entered the Bengal Civil Service. He served as secretary to the governor of the North-West Provinces, and as a member of the Agra revenue board, and during the Mutiny he was in charge of the intelligence department there. In 1865 he was made foreign secretary to the Indian Government. In 1867 he was knighted (K.C.S.I.), and in 1868 he became lieutenant-governor of the North-West Provinces. In 1874 he was appointed financial member of the Council, and retired in 1876, when he became a member of the Council of India in London. He had always taken an interest in educational matters, and it was chiefly through his exertions that the central college at Allahabad, known as Muir's College, was built and endowed. In 1885 he was elected principal of Edinburgh University in succession to Sir Alexander Grant, and held the post till 1903, when he retired. Sir William Muir was a profound Arabic scholar, and made a careful study of the history of the time of Mahomet and the early caliphate. His chief books are a *Life of Mahomet and History of Islam to the Era of the Hegira*; *Annals of the Early Caliphate*; *The Caliphate*, an abridgment and continuation of the *Annals*, which brings the record down to the fall of the caliphate on the onset of the Mongols; *The Koran: its Composition and Teaching*; and *The Mohammedan Controversy*, a reprint of five essays published at intervals between 1885 and 1887. In 1881 he delivered the Rede lecture at Cambridge on *The Early Caliphate and Rise of Islam*. He married in 1840 Elizabeth Huntly Wemyss (d. 1897), and had five sons and six daughters; four of his sons served in India, and one of them, Colonel A. N. Muir (d. 1890), was acting resident in Nepal.

MUKADDASI¹ (the appellation of Shams ad Din Abu Abdallah Mahommed ibn Ahmad) (fl. 967-985), Arabian traveller, author of a *Description of the Lands of Islam* which is the most original and among the most important of Arabic geographies of the middle ages. His family name was Al Bashari. His paternal grandfather was an architect who constructed many public works in Palestine, especially at Acre, and his mother's family was opulent. His maternal grandfather, a man of artistic and literary tastes, migrated to Jerusalem from Jurjan province in Persia, near the frontier of Khorasan. His descriptions rest on extensive travels through a long series of years. His first pilgrimage was made at the age of twenty (in A.H. 356 = A.D. 967), but his book was not published till A.H. 375 (A.D. 985-86), when he was forty years old.

The two MSS. (at Berlin and Constantinople) represent a later recension (A.H. 378). The book became known in Europe through the copy brought from India by Sprenger, and was edited by Professor M. J. de Goeje as the third part of his *Bibliotheca Geographorum Arabicorum* (Leiden, 1877). See also the English translation (unpublished) by G. S. A. Ranking and R. F. Anon. in *Bibliotheca Indica*, New Series, Nos. 809, 952, 1001 (Bengal Asiatic Society, 1897-1901); Mukaddasi's Syrian chapter has been separately translated and edited in English by Guy le Strange (London, Palestine Pilgrims Text Society, 1886); in German by J. Gildemeister in *Zeitschrift des deutschen Palästina-Vereins*, vol. vii. (1884).

MUKDEN (Chinese *Shêngking*), the capital of Manchuria, on the Hun-ho, 110 m. N.E. of Niuchwang, in 41° 51' N., 123° 38' E., with a population of 250,000. It is a centre for trade and also for missionary enterprise. It was formerly the headquarters of the Manchu dynasty, and their tombs lie within its confines. Mukden is a fine town, with splendid walls, about a mile long each way. The suburbs extend a considerable distance from the city and are surrounded by mud walls. In the centre of the town stands a small palace surrounded by an inner wall and roofed with yellow tiles. The boots and pack of Nurhachu, the founder of the present Chinese dynasty, who was a pedlar, are preserved there. Nurhachu's son, the emperor T'ien-tsung (1627-1636), built temples to heaven and earth in the neighbourhood of the city in imitation of those at Peking. These are much dilapidated. Four or five miles to the east of the town stands the Fu-ling or "happy tomb," where the remains of Nurhachu rest, the outer

¹ Al Mukaddasi = "the Jerusalemite."

gates of which are adorned with a green majolica representation of an imperial dragon. The Emperor K'ien lung (1726-1796) wrote a poem on Mukden, which was translated into French by Père Amiot and attracted the attention of Voltaire. During the Russo-Japanese War in 1905 some of the heaviest fighting took place before Mukden, what is known as the "battle of Mukden" covering operations from the 10th of February till the Japanese occupied Mukden on the 10th of March and the Russians retreated northward on the 12th.

MUKDISHU (*Magadoxo*), a seaport of Italian Somaliland, East Africa, in 2° 1' N., 45° 24' E. It is built on the sandy coast which separates the Webi Shebeli from the sea. The harbour is open. Mukdishu, formerly extensive, is largely in ruins; it consists of two villages, Hamarwin to the south and Shingani to the north. There are some houses in the Moorish style and a mosque among the ruins bears date 636 A.H. (i.e. A.D. 1238). Between the two settlements is the governor's palace and north of the town is a massive square tower built by the Portuguese in the 16th century. The population, about 5000, is mainly composed of descendants of negro slaves known as Abesh. There are also Somali, Arab and Hindu settlers. Mukdishu is mentioned by Marco Polo and described by Ibn Batuta as an "immense" city. This was in the early part of the 14th century. It was a flourishing port and had many fine mosques when captured by the Portuguese (about 1510). Under Portugal the place fell into decay. It passed in the 17th century into the possession of the imams of Muscat, but in the 18th century became practically independent. It was reconquered by Seyyid Said c. 1830, and on the division of his dominions fell to Zanzibar. In 1892 it was transferred to Italy (see SOMALILAND, *Italian*). The name of the town is spelt in a great variety of ways, including Madeigascar, whence the name of the island of Madagascar. Alfred Grandidier points out that the Portuguese, misled by Marco Polo's description of Mukdishu as an island, fancied they had discovered the land of which he wrote when they touched at Madagascar.

MULA, a town of eastern Spain, in the province of Murcia; on the left bank of the Mula, a small right-hand tributary of the Segura, periodically liable to destructive floods. Pop. (1900), 12,731. The Sierra España rises on the south to a height of nearly 5200 ft. Mula has a small trade in agricultural produce, wine and olive oil. About 4 m. east are two groups of houses known as the Baños de Mula, with warm sulphurous springs of considerable local repute.

MULATTO (Span. and Port. *mulato*, diminutive of *mulo*, Lat. *mulus*, a mule, used as denoting a hybrid origin), a person one of whose parents is of a white race and the other a negro. In Latin America such half-breeds are sometimes called *mestizos*.

MULBERRY² (botanically *Morus*; nat. ord. *Moraceae*), a genus of about ten species growing in the temperate regions of the northern hemisphere and in the mountains of the tropics. They are deciduous trees or shrubs with alternate, toothed, often three-lobed leaves and unisexual flowers in catkin-like inflorescences.

The black mulberry (*Morus nigra*), a native of western Asia, spread westwards in cultivation at an early period; it was cultivated by the Greeks and Romans, and in northern Europe by the 9th and 10th centuries. Up to the 15th century it was extensively grown in Italy for rearing silkworms, but has since been superseded by *M. alba*. It is now mainly cultivated for its oblong purplish-black compound fruit—the so-called *sorosis*, formed from the whole female inflorescence in which the perianth leaves of the single flowers have become fleshy—which is wholesome and palatable if eaten fresh before acetous fermentation has set in. The mulberry succeeds as a standard in the warmer parts of England, especially in sheltered situations, but in the north of England and the less favoured parts of Scotland it requires the assistance of a wall. The standard trees require no other pruning or training than an occasional thinning out of the branches, and are generally planted on lawns, to prevent the fruit being damaged when it

² Mulberry stands for *murberry* or *morberrry*, i.e. *morus* and "berry," cf. Ger. *maulbeere*, O.H.G. *mülberi*, *mürberi*.

falls. The tree succeeds best in a rich, deep, and somewhat moist loam, but grows well in any good garden ground. It is usually propagated either by cuttings or layers, which latter, if made from the older branches of the tree, come sooner into bearing. Cuttings planted in the spring should consist of well-ripened shoots of the preceding year, with a joint of two-year-old wood at their base, or if planted in autumn should have the shoots well matured, and furnished with a heel of two-year-old wood. The branches and even stout limbs are sometimes employed as cuttings instead of the younger shoots, especially when the object is to obtain a bearing tree quickly.



Mulberry (*Morus nigra*) Shoot bearing Fruit.

- 1, Catkin of male flowers.
- 2, A male flower.
- 3, Cluster of female flowers.
- 4, Two female flowers.

The branch should be planted deeply in autumn in good soil, and if necessary supported in an upright position by a stake. The most common mode of propagation, however, is by layering the young branches. The mulberry may be grown in pots, and gently forwarded in an orchard house, and under these conditions the fruit acquires a richness of flavour unknown in the fruit ripened out of doors. If cultivated in this way it requires abundance of water while the fruit is swelling, and also frequent dressings of artificial fertilizers.

The white mulberry (*M. alba*), so called from its nearly white fruit, is the one mainly employed in sericulture. It is a native of China and has been cultivated from the earliest times in Asia and since the 12th century in Europe, especially in the Mediterranean region. There are many varieties, among which the Philippine mulberry (var. *multicaulis*) is perhaps most highly esteemed. The Indian species, *M. indica* (not to be confounded with *Morinda citrifolia*, a rubiaceaceous tree, sometimes also called Indian mulberry), is also cultivated for the same purpose.

M. rubra, the North American red mulberry, is the largest of the genus, often reaching a height of 70 ft. It produces dark red berries much inferior in flavour, however, to those of *M. nigra*.

Broussonetia papyrifera, a member of a closely allied genus, is the paper mulberry, a native of Burma, China and Polynesia, and widely cultivated in Japan, where the bark is used for paper-making. The Tapa-cloth of the South Sea Islands is also made from it. The plant is a shrub or small tree with large mulberry-like lobed or entire hairy leaves. Several forms are cultivated, differing chiefly in the shape of the leaves.

MULDE, a river of Germany, a left-bank tributary of the Elbe. It is formed by the confluence, just below Kolditz, of the Zwickauer Mulde, which rising in the Vogtland of Saxony passes Zwickau, Glauchau and Rochlitz, and the Freiberger Mulde, which, rising in the Bohemian Erzgebirge, touches

Freiberg, Döbeln and Leisnig. The united river flows north to Grimma and thence past Wurzen, Eilenburg and Bitterfeld to Dessau, where it joins the Elbe. The total length of the united river is 75 m.

MULE (Lat. *mulus*), a term not unfrequently applied to the produce of any two creatures of different species, and synonymous with hybrid, but in its ordinary acceptance employed to designate the offspring or "cross" between the equine and asinine species. There are two kinds of mule—the *Mule* proper (*Equus asinus*, var. γ ; *Mulus*; Fr. *Mulet* or *Grand mulet*; Ger. *Grosser Maulesel*), which is the hybrid produce of a male ass with a mare, and the *Hinny* (*Equus asinus*, var. δ ; *Hinnus*; Fr. *Bardot* or *Petit mulet*; Ger. *Kleiner Maulesel*), the offspring of the stallion and female ass. The mule is the more valuable of the two, and to its production the attention of breeders is entirely directed.

In its short thick head, long ears, thin limbs, small narrow hoofs, short mane, absence of chestnuts (horny growths) inside the hocks, and tail destitute of hair at the root the mule is asinine; while in height and body, shape of neck and croup, uniformity of coat, and in teeth it is equine. It has the voice neither of the ass nor of the horse, but emits a feeble hoarse noise. The most common colour of the mule is a brown or bay-brown—bay, or bright bay, or piebald being rare; a chestnut tint is sometimes noticed. It possesses the sobriety, patience, endurance and sure-footedness of the ass, and the vigour, strength and courage of the horse. As a beast of burden it is preferable to the horse, being less impatient under the pressure of heavy weights, while the skin being harder and less sensitive renders it more capable of resisting sun and rain.

The mule has been in use from early times; the inhabitants of Mysia and Paphlagonia are said to have been the first breeders. With the Greeks and Romans, the latter especially, the mule was valued, being employed to draw carriages and carry loads. In modern times it has been largely used for military transport.

The principal mule countries in Europe are the south of France, Spain, Portugal and Italy, where they are used for pack and draught. The French mules are most numerous on the borders of the Pyrenees, in Gascony, and in Poitou. In Spain mules are used in the Catalan provinces, in the mountainous districts of Andalusia, and in the province of Alicante. Good draught-mules are bred in La Mancha and in the districts on the slopes of the Pyrenees, where they are employed to carry loads. But in Spain, Italy, and some other countries they are also extensively used in carriages; in Spain particularly, where large, fine mules are bred for this purpose, a pair of these animals will often cost more than a pair of horses. The mules of Asia Minor, Syria, Cyprus, Egypt and Algeria, as well as those of the district between the Tigris and the Persian frontier and in North China, are good. In the Punjab provinces of British India many excellent mules are bred, breeding being promoted by the government. Good mules are reared in North and South America, the principal districts for breeding them in the United States being Texas, Missouri, Mississippi; Tennessee, Alabama, Georgia, Arkansas and Kentucky. The Kentucky mules are well shaped and showy, being derived from nearly thoroughbred mares known as Kentucky trotters, while those reared in Missouri are hardy. The Mexican mule, bred by a male ass out of a mustang mare, is also a hardy, strong and useful animal.

France is perhaps the most important mule-raising country in Europe, four centres being more particularly devoted to this kind of industry: Poitou, the mountainous districts of central France, the Pyrenees and Dauphiné. The mules of these different parts differ chiefly in height; those of Poitou are large, powerful, and long in the body, and are mainly exported to the departments of Languedoc and Provence, as well as to Spain, Italy and America; those of Dauphiné are of medium height, with a short, thick body; while those of the centre and the Pyrenees are lighter and smaller, but more active.

Mule-breeding in Poitou is supposed to date from the time of Philip V. of Spain, when the particular breeds of horses and

asses were imported into that region and Gascony. But there is evidence to show that as early as the 10th century the mules of Poutou were of excellent quality.

MULGRAVE, EARLDOM OF, a title dating from 1626, when Edmund Sheffield, 3rd Baron Sheffield of Butterwicke, was created earl of Mulgrave. He was succeeded by his grandson Edmund, the 2nd earl, who was one of the nine true peers who sat in Oliver Cromwell's House of Lords. Edmund's son John, 3rd earl, was created marquess of Normanby in 1694, and duke of Buckingham and Normanby in 1703; but on the death of his son, the 2nd duke, without heirs in 1735, the titles became extinct. The 2nd duke devised the estates of the Sheffield family to his mother Catherine, a natural daughter of James II., who had married as her first husband the 3rd earl of Annesley, by whom she had a daughter Catherine, who married William Phipps and had a son Constantine Phipps. The latter succeeded to the estate of Mulgrave in Yorkshire in 1743 on the death of his grandmother, and in 1767 he was created Baron Mulgrave of New Ross in the peerage of Ireland. His son was created a peer of Great Britain in 1790 with the title of Baron Mulgrave of Mulgrave; and the latter's brother Henry, the next in succession, who was secretary of state for foreign affairs in 1805 and held other high government offices, was created Viscount Normanby and earl of Mulgrave in 1812. The 2nd earl of this creation, who like his father held several high cabinet offices, was advanced in the peerage at the coronation of Queen Victoria, being created marquess of Normanby in 1838.

MULHAUSEN (Fr. *Mulhouse*), a town of Germany, in Upper Alsace, on the Ill, an affluent of the Rhine, and the Rhine-Rhone canal, about 56 m. S. of Strassburg and 21 m. N.W. of Basel by rail. The old town, surrounded by arms of the Ill, has narrow and irregular streets, while to the south, on the canal, lie the handsome villas and promenades of the new town. Most of the older buildings have made way for factories, so that the town-hall, dating from 1557, is an almost solitary witness to the town's medieval prosperity. The most important interest of Mülhausen centres in the making of cotton goods. This industry was introduced in 1746, and has since prospered in the hands of several wealthy families which are closely connected by intermarriage, and lend each other support. A large proportion of the inhabitants of the town and the neighbourhood is engaged in woollen and other textile manufactures, the products of which are exported to all parts of the world. The manufactures of machinery, especially locomotives and railway plant, chemicals, and hardware are also important. A noteworthy feature is the attention paid by the manufacturers to the well-being of their workpeople. In 1853, Johann Heinrich Dollfus (1800-1887), mayor of the town, founded the "artisans' town" (*cité ouvrière*) to the north-east of the old town, consisting of about 1200 model dwellings with public bath-, wash- and bake-houses, and library. The houses were let on a system by which the occupant became the owner after the payment of a certain number of instalments. Of recent years, however, the operatives have moved into the suburbs, leaving the model houses of the "artisans' town" to small tradesmen. A "société industrielle" for the encouragement of original discovery and invention among the workmen has existed since 1825, and there are various benevolent societies. Mülhausen carries on an active trade in grain, wine, colonial produce and timber, which is facilitated by its river harbour. After the annexation of Alsace to Germany in 1871 the French sympathies of the inhabitants were shown by the extraordinary decrease in their number. The population has since increased, amounting in 1905 to 94,514, of whom about two-thirds are Roman Catholics.

Mentioned as early as 717, Mülhausen was raised to the rank of a free town of the empire in 1198, and received very extensive privileges from Rudolph of Hapsburg in 1273. It suffered considerably in the various wars of the middle ages, but generally managed to maintain its independence. In 1466 it formed an alliance with the Swiss, and this became a permanent union in 1515. By the peace of Westphalia (1648) it was recognized as an independent ally of the Swiss League. In 1797 it sought

incorporation with France from motives of commercial policy, and in 1871 it passed to Germany.

See A. Metzger, *La République de Mulhouse 717-1798* (Basel, 1884); Schall, *Das Arbeiterquartier von Mülhausen* (Berlin, 1877); Herkner, *Die ober-elsässische Baumwollindustrie und ihre Arbeiter* (Strassburg, 1887); and E. Tourner, *Mülhausen im 16. Jahrhundert* (Illyach, 1894).

MÜLHEIM-AM-RHEIN, a town of Germany, in the Prussian Rhine province, on the right bank of the Rhine, 2 m. below Cologne, of which it is practically a suburb, and on the main lines of railway Cologne-Düsseldorf and Cologne-Elberfeld. Pop. (1905), 50,807. There are important manufactures of silk, ribbons, velvet, sailcloth, tobacco, vinegar, yarn and chemicals, in addition to rolling-mills, boiler works, telegraph works, breweries, tanneries and a ship-building yard. Mülheim also carries on a brisk trade by rail and river.

Of ancient foundation, Mülheim received municipal rights in 1322. Its industrial prosperity is in great part due to the influx of Protestants expelled from Cologne at the beginning of the 17th century. In 1784 the town suffered severely from an inundation caused by the rapid breaking-up of the ice on the Upper Rhine.

MÜLHEIM-AN-DER-RUHR, a town of Germany, in the Prussian Rhine province, on the Ruhr, an affluent of the Rhine, about 7 m. W. from Essen and at the intersection of several railways. Pop. (1905), 93,598. It has a parish church dating from the 12th century. Like most of the towns in this district, Mülheim finds its chief industry in iron-working, and contains numerous blast-furnaces, rolling-mills, foundries and engineering works; it also carries on manufactures of leather, wool, cotton, calico, tobacco, paper, beer, and other miscellaneous goods. An enormous traffic, by river and rail, is carried on in coal, and there is also a considerable trade in timber and colonial produce. In the neighbourhood are important sandstone quarries, glass-works, and a carpet manufactory. Mülheim was formerly included in the duchy of Berg, and became a town in 1508. In 1815 it passed to Prussia.

MULJI, KURSENDAS (1832-1875), Indian journalist and social reformer, was born on the 25th of July 1832, of a family belonging to the Bhatia or trading caste of western India. Being repudiated by his family on account of his views on widow remarriage, he became a vernacular schoolmaster, and started a weekly paper in Gujarati called *The Satya Prakash*. In this he attacked the immoralities of the Maharajas or hereditary high priests of the Vallabhacharya sect of Vaishnavism to which the Bhatias belong. In a suit for libel brought against him in the High Court at Bombay in 1862, he won a victory on the main issue. After a visit to England on business in connexion with the cotton trade, which was not successful and brought on him excommunication from his caste, he was appointed in 1874 to administer a native state in Kathiawar during the minority of the chief; and there he died in August 1875.

See *History of the Sect of Maharajas or Wallabhacharyas of Western India* (1865).

MULL, the largest island of the Inner Hebrides, Argyllshire, Scotland. Pop. (1901), 4334. It is bounded on the W. and S. by the Atlantic, on the N. and N.E. by the Sound of Mull, and on the E. and S.E. by the Firth of Lorne. It has an area of about 367 sq. m., its greatest length being 27 m. and its greatest breadth 20 m. The coast is much indented, the principal sea-lochs being Loch Mingary, Loch Uan, Loch Tua, Loch-na-Keal, Loch Scridain, Loch Buy, Loch Spelve and Loch Don. Among several freshwater lakes Loch Frisa, Loch Ba and Loch Uisg are the chief. The principal mountains are Ben More (3185 ft.), Ben Bu (2354 ft.) and Ben Creach (2280 ft.). In the basaltic cliffs near Carsaig are numerous arches and caverns. The prevailing rocks are igneous (generally basaltic, gabbro in the mountains in the south-east, granite in the Ross). The valleys are filled up with lava flows and volcanic ashes of Miocene age. At a few places there are gneissose rocks, chalk, sandstone lias and quartz porphyry. Sheep and cattle are raised, and barley, oats and potatoes grown. Owing to the damp climate the island is better suited for grazing than for cultivation.

Granite and freestone are quarried. Ben More deer forest and the excellent fishing and shooting attract many sportsmen. There are several ancient castles, the principal being those of Duart and Aros. Close to the former is a lighthouse erected in memory of William Black, the novelist (d. 1898). About midway between Mull and Lismore is the Lady Rock, visible at low water, on which, in 1523, Lachlan Maclean of Duart exposed his wife, a daughter of the second earl of Argyll, expecting that she would be drowned by the flowing tide. She was, however, saved by her clansfolk and her husband was afterwards slain by her brother. Joanna Baillie (1762-1851) made the incident the leading theme of her drama of *The Family Legend*. TOBERMORY ("the Well of Mary," so called from a spring of local celebrity) is the only town (pop. 1175). It is placed on a pretty bay, the houses standing on tree-clad heights. It was founded in 1788 as a station for fishing-boats, and the herring fishery is still of some consequence. It has regular communication by steamer with Stormovay, Oban and Glasgow. Off the north-western shore of Mull, separated by a narrow strait, lies the isle of ULVA, 4½ m. long and 2½ m. broad, whose inhabitants are mostly engaged in fishing and kelp-gathering. Close to Ulva, and practically one with it at low tide, is the isle of GOMETRA, about 1½ m. long and 2 m. broad, the people of which are chiefly occupied with fishing. LITTLE COLONSAY lies about 2 m. south of Ulva. Farther west is the small group of the TRESHNISH ISLES.

MULL. (1) A soft plain muslin exported largely from England to India, &c., and used also in some qualities for summer dresses in the home trade. The name is an abbreviation of the Hindu *mūlmul*. (2) A word, derived from the same root as seen in "meal" and "mill," meaning that which is ground or reduced in other ways to powder or small particles. Thus a snuff-box is in Scotland called a "mull," from the early machines in which the tobacco was ground. Large snuff-mills, which remained stationary on a table, as opposed to the small portable boxes, often took the form of a ram's head ornamented in silver. Possibly from the ground or grated spices with which ale or wine is flavoured when heated, comes the expression "mulled," as applied to such a beverage. The colloquial expression "to make a mull," i.e. to muddle or make a failure of something, also perhaps connected with "to mull," to reduce to powder. (3) The Scots word "mull," meaning a promontory or headland, as the Mull of Galloway, the Mull of Kintyre, represents the Gaelic *maol*, cf. Icelandic *máli* in the same sense; this may be the same as *mūli*, snout, cf. Ger. *Maul*.

MULLAH (Arabic *maula*, a term which originally expresses the legal bond connecting a former owner with his manumitted slave, both patron and client being called *maula*, and thus suggests the idea of patronage), in Mahomedan countries, a learned man, a teacher, a doctor of the law, in India the term is applied to the man who reads the Koran, and also to a Mussulman schoolmaster. In countries like Afghanistan the mullahs exert an influence over the populace which sometimes rivals that of the amir himself, and they have been responsible for many disturbances in Kabul. Among the democratic tribes of the north-west frontier of India they almost take the place of a secular chief. In the Indian frontier risings of 1807-98 the "mad mullah" of Swat led the attack upon the Malakand, while the Hadda mullah was largely responsible for the risings amongst the Mohmands, Afridis and Orakzais. The leader of the risings in Somaliland in 1899-1910 was similarly known as the "mad mullah."

MULLER, FERDINAND VON, BARON (1825-1896), German botanist and explorer, was born at Rostock on the 30th of June 1825, and was educated, after the early death of his parents, in Schleswig. He studied the flora of Schleswig and Holstein from 1840 to 1847, when he emigrated to South Australia and travelled through the colony from 1848 to 1852, discovering and describing a large number of plants previously unknown. In 1852 he was appointed government botanist for Victoria, and examined its flora, and especially the Alpine vegetation of Australia, which was previously unknown. Then, as phyto-

graphic naturalist, he joined the expedition sent out under Augustus Gregory by the duke of Newcastle, secretary of state for the colonies. He explored the river Victoria and other portions of North Australia, was one of the four who reached Termination Lake in 1856, and accompanied Gregory's expedition overland to Moreton Bay. From 1857 to 1873 he was director of the Botanical Gardens, Melbourne, and not only introduced many plants into Victoria, but made the excellent qualities of the blue gum tree (*Eucalyptus globulus*) known all over the world, and succeeded in introducing it into the south of Europe, North and South Africa, California, and the extra-tropical portions of South America. For these services he was decorated by many foreign countries, including France, Spain, Denmark and Portugal; was created K.C.M.G. in 1879, baron of the kingdom of Württemberg in 1871, and F.R.S. in 1861. He published eleven volumes of *Fragmenta phytographica Australiæ* (1862-1881), two volumes of the *Plants of Victoria* (1860-1865), and other books on the Eucalyptus, Myoporaceæ, Acaciæ, and Salsolaceæ, all profusely illustrated. He also co-operated in the production of G. Bentham's *Flora Australiensis*. He took a leading part in promoting Australian exploration, especially the Burke and Wills expedition, which was the first to cross the continent, and in the various attempts to unravel the mystery which attended the fate of his fellow-countryman Ludwig Leichhardt (1813-1848). He died at Melbourne on the 9th of October 1896.

MÜLLER, FRIEDRICH (1749-1825), German poet, dramatist and painter, usually known as Maler (i.e. painter) Müller, was born at Kreuznach on the 13th of January 1749. He studied painting at Zweibrücken, and in 1774-1775 settled in Mannheim, where in 1777 he was appointed court painter. In 1778 he was enabled by a public subscription to visit Italy, which remained his home for the rest of his life. In 1780 he became a Roman Catholic. He was unfavourably influenced by the study of Italian models, and gradually gave up painting and devoted himself to the study of the history of art; his services as cicerone were especially in demand among German visitors to Rome. Before he left Mannheim he had tried his hand at literature, under the influence of the *Sturm und Drang* movement. A lyric drama, *Niobe* (1778), attracted little attention; but *Fausts Leben dramatisirt* (1778) appealed to the turbulent spirit of the time, and *Golo und Genoveva* (begun in 1776, but not published till 1811) was an excellent imitation of Goethe's *Götz von Berlichingen*. He struck out a more independent path in his idylls, notably *Die Schafschur* (1775) and *Das Nusskorn* (1811), in which, emancipating himself from the artificiality of Gessner, he reproduced scenes—not without a touch of satire—from the German peasant life of his day. He died at Rome on the 23rd of April 1825.

Maler Müller's *Werke* appeared in 3 vols. (1811-1825); in 1868 H. Hettner published two volumes of *Dichtungen von Maler Müller*, which contain most of his writings. *Gedichte von Maler Friedrich Müller; eine Nachlese zu dessen Werken* appeared in 1873, and his *Fausts Leben* was reprinted by B. Seuffert in 1881. See A. Sauer, "Stürmer und Dränger," vol. iii. (Kurschner's *Deutsche National-Literatur*, vol. 81, 1883); and B. Seuffert, *Maler Müller* (1877).

MÜLLER, GEORGE (1805-1898), English preacher and philanthropist, was born near Halberstadt, Germany, on the 27th of September 1805, the son of an exciseman. He subsequently became a naturalized British subject. Educated in Germany, he resolved in 1826 to devote himself to missionary work, and in 1828 went to London to prepare for an appointment offered him by the Society for promoting Christianity among the Jews. In 1830 however he gave up the idea of missionary work, and became minister of a small congregation at Teignmouth, Devonshire. He contended that the temporal as well as the spiritual needs of life could be supplied by prayer, and on this principle abolished pew rents and refused to take a fixed salary. After two years at Teignmouth, Müller removed to Bristol, where he spent the rest of his life. He devoted himself particularly to the care of orphan children. He began by taking a few under his charge, but in course of time their number increased to 2000, settled in five large houses erected for the

purpose at Ashley Down, near Bristol. The money required for the carrying on of this work was voluntarily contributed, mainly as a result of the wide circulation of Müller's narrative *The Lord's Dealings with George Müller*. When he was over seventy he started on a preaching mission, which lasted nearly seventeen years and included Europe, America, India, Australia and China. He died at Bristol on the 10th of March 1898.

See A. T. Pierson, *George Müller of Bristol* (1899).

MÜLLER, JOHANNES PETER (1801–1858), German physiologist and comparative anatomist, was born at Coblenz on the 14th of July 1801. In 1819 he entered Bonn University, where he became privatdocent in 1824, extraordinary professor of physiology in 1826, and ordinary professor in 1830. In 1833 he removed to the university of Berlin, where he filled the chair of anatomy and physiology with great distinction until his death on the 28th of April 1858. Müller made numerous researches in various departments of physiology, and in particular he extended knowledge as to the mechanism of voice, speech and hearing, and as to the chemical and physical properties of lymph, chyle and blood. The appearance of his *Handbuch der Physiologie des Menschen* between 1833 and 1840 (translated into English by Dr William Baly, and published in London in 1842) marked the beginning of a new period in the study of physiology. In it, for the first time, the results of human and comparative anatomy, as well as of chemistry and other departments of physical science, were brought to bear on the investigation of physiological problems. The most important portion of the work was that dealing with nervous action and the mechanism of the senses. Here he stated the principle, not before recognized, that the kind of sensation following stimulation of a sensory nerve does not depend on the mode of stimulation but upon the nature of the sense-organ. Thus light, pressure, or mechanical stimulation acting on the retina and optic nerve invariably produces luminous impressions. This he termed the law of the specific energy of sense substances. In the later part of his life he chiefly devoted himself to comparative anatomy. Fishes and marine invertebrata were his favourite subjects. Müller numbered such distinguished physiologists as H. von Helmholtz, E. Du Bois Reymond and K. F. W. Ludwig among his pupils.

In addition to his *Handbuch der Physiologie*, his publications include *Zur vergleichenden Physiologie des Gesichtsinns* (1826); *Über die phantastischen Gesichtsercheinungen* (1826); *Bildungsgeschichte der Genitalien* (1830), in which he traced the development of the Müllerian duct; *De glandularum scenernium structura* (1830); *Vergleichende Anatomie der Myxinoïden* (1834–1843); *Systematische Beschreibung der Plagiostomen* (1841) with F. G. J. Henle; *System der Asteriden* (1842) with F. H. Troschel; and *Hornae ichthyologicae* (1845–1849) with the same. After the death of J. F. Meckel (1781–1833) he edited the *Archiv für Anatomie und Physiologie*.

MÜLLER, JOHANNES VON (1752–1809), Swiss historian, was born on the 3rd of January 1752 at Neunkirch, near Schaffhausen, where his father was pastor. In 1760 the family removed to Schaffhausen. In his youth his maternal grandfather, Schoop (d. 1757), roused in him an interest in the history of his country. At the age of eight he is said to have written a history of Schaffhausen, and at eleven he knew the names and dates of all the kings of the four great monarchies. His ardour for historical studies was further stimulated by Schlözer, when Müller went (1769) to the university of Göttingen, nominally to study theology. In July 1771 he undertook a sketch of Swiss history (no detailed history of Switzerland having so far been written) for a publisher of Halle, but his theological studies and the preparation of a Latin dissertation on the *Bellum cimbricum* (publ. in 1772) prevented much progress. In April 1773 he passed his theological examination, and soon after became professor of Greek at the Collegium Humanitatis. Early in 1774, on the advice of his friend Charles Victor de Bonstetten, he gave up this post and became tutor in the Tronchin family at Geneva. But in 1775 he resigned this position also, and passed his time with various friends in Geneva and Vaud, engaged in carrying his historical scheme into effect. Having accumulated much material, he began the actual composition

of his work in the spring of 1776, and the printing in the summer of 1777. But difficulties arose with the censor, and matters came to a standstill. In 1778–1779 Müller delivered a brilliant set of lectures on general history, which were not published till 1839 under the title of *Vierundzwanzig Bücher allgemeiner Geschichte*. In 1780 the first volume (extending to 1388) of his *Geschichten der Schweizer* appeared, nominally at Boston (to avoid the censor), though really at Bern; and it was well received. In 1781 he published at Berlin, in French, his *Essais historiques*. He was on his way back to Switzerland when the landgrave of Hesse Cassel named him professor of history. He stayed at Cassel till 1783, publishing in 1782 his *Reisen der Päpste*, a book wherein certain leanings towards Romanism are visible. On his return to Geneva (1783) he accepted the post of reader to the brother of his old patron, Tronchin, and occupied himself with remodelling his published work of 1780. In order to improve his financial position, he accepted early in 1786 the post of librarian to the elector-archbishop of Mainz, who bestowed many important offices upon him and obtained his elevation to nobility from the emperor in 1791. In June 1786 he issued vol. i. (reaching to 1412) and two years later vol. ii. (to 1436) of the definitive form of his Swiss history, which was received with great praise. In 1787 he issued an important political tract, *Zur Darstellung des Fürstenbundes*. But in October 1792 Mainz was taken by the French, so that Müller had to seek for another post. In February 1793 he entered the service of the emperor as an imperial aulic councillor. At Vienna he spent many years, becoming chief librarian of the imperial library in 1800, and in 1795 he issued vol. iii. (to 1443) of his Swiss history. In 1804 he became historiographer, war councillor, and member of the Academy at Berlin. In 1805 vol. iv. (to 1475) appeared. But in 1806 he became strongly inclined towards Napoleon, by whom he was received in audience (Nov. 1806), and from whom he accepted (end of 1807) the office of secretary of state for the kingdom of Westphalia, exchanging this position early in 1808 for the posts of privy councillor and general director of public instruction. At the end of 1808 he published vol. v. (to 1489) of his great work. He died at Cassel on the 29th of May 1809. His *Swiss History* now possesses a literary value only, but it was an excellent work in every way for the 18th century.

Müller's works were published under the care of his brother at Tübingen, in 27 vols. (1810–1819), and re-issued, in 40 vols., at Stuttgart (1831–1835). The *Swiss History* was re-issued at Leipzig and Zürich, in 15 vols. (1824–1853), with continuations by Glutz-Blotheim (to 1517), Hottinger (to 1531), Vulliamin (to 1712), and Monnard (to 1815). A French translation of the German edition (as above) appeared, in 18 vols., at Paris and Geneva (1837–1851).

See the biographies by Heeren (1809), Döring (1833) and Monnard (1839); also in G. v. Wyss's *Geschichte der Historiographie in der Schweiz* (Zürich, 1895), pp. 305–311, and in the *Festschrift der Stadt Schaffhausen* (Schaffhausen, 1891), pt. v. pp. 83–99. F. Schwarz's pamphlet, *J. von Müller und seine Schweizergeschichte* (Bäle, 1884), traces the genesis of the *History*. Müller's letters to Füsslin (1771–1807) were issued at Zürich (1812), and those to Ch. Bonnet, &c., at Stuttgart (1835). Those addressed to him by various friends were published by Maurer-Constant, in 6 vols. (Schaffhausen, 1839–1840); and those written to him (1789–1809) by his brother, J. G. Müller, appeared, under the editorship of E. Haug, at Frauenfeld, in 2 vols. (1891–1892). (W. A. B. C.)

MÜLLER, JULIUS (1801–1878), German Protestant theologian, was born at Brieg on the 10th of April 1801. He studied at Breslau, Göttingen and Berlin, first law, then theology; and in 1839 became professor ordinarius of theology at Halle (1839). In 1848 he helped to found the *Deutsch-evang. Kirchenlag*, and two years later founded and edited (1850–1861), with Neander and K. I. Nitzsch, the *Deutsche Zeitschrift für christliche Wissenschaft und christliches Leben*. He died at Halle on the 27th of September 1878. A disciple of Neander and friend of Richard Rothe, Müller bitterly opposed the philosophy of Hegel and the criticism of F. C. Baur. His book, *Über den Gegensatz des Protestantismus und des Catholicismus* (1833), called forth a reply from Baur, and he was one of those who attacked D. Strauss's *Life of Jesus*. In 1846 he had been deputed to attend the General Evangelical Synod at Berlin. Here he supported the Consensus-Union, and afterwards defended

himself in the pamphlets *Die erste Generalsynode der evang. Landeskirche Preussens* (1847) and *Die evangelische Union, ihr Wesen und göttliches Recht* (1854). His chief work, however, was *Die christliche Lehre der Sünde* (2 vols., 1830; 5th ed., 1867; Eng. trans. from 5th ed.), in which he carried scholasticism so far as "to revive the ancient Gnostic theory of the fall of man before all time, a theory which found no favour amongst his theological friends" (Otto Pfeleiderer).

Müller's other works include *Dogmat. Abhandlungen* (1870), and *Das christliche Leben* (3rd ed., 1847). See M. Kähler, *Julius Müller* (1878); L. Schultze, *Julius Müller* (1879) and *Julius Müller als Ethiker* (1895).

MÜLLER, KARL OTFRIED (1797-1840), German scholar, was born at Brieg in Silesia on the 28th of August 1797. He was educated partly in Breslau, partly in Berlin, where his enthusiasm for the study of Greek literature, art and history was fostered by the influence of Böckh. In 1817, after the publication of his first work, *Aegineticorum liber*, he received an appointment at the Magdaleneum in Breslau, and in 1819 he was made adjunct professor of ancient literature in the university of Göttingen, his subject being the archaeology and history of ancient art. His aim was to form a vivid conception of Greek life as a whole; and his books and lectures marked an epoch in the development of Hellenic studies. Müller's position at Göttingen being rendered unpleasant by the political troubles which followed the accession of Ernest Augustus (duke of Cumberland) to the throne of Hanover in 1837, he applied for permission to travel; and in 1839 he left Germany. In April of the following year he reached Greece, having spent the winter in Italy. He investigated the remains of ancient Athens, visited many places of interest in Peloponnesus, and finally went to Delphi, where he began excavations. He was attacked by intermittent fever, of which he died at Athens on the 1st of August 1840.

Among his historical works the foremost place belongs to his *Geschichten hellenischer Stämme und Städte: Orchomenos und die Mynier* (1820), and *Die Dorier* (1824; Eng. trans. by H. Tuftnell and Cornwall Lewis, 1830, including the essay *Über die Makedonier*, on the settlements, origin and early history of the Macedonians). He introduced a new standard of accuracy in the cartography of ancient Greece. In 1828 he published *Die Etrusker*, a treatise on Etruscan antiquities. His *Prolegomena zu einer wissenschaftlichen Mythologie* (1825; Eng. trans. by J. Leitch, 1844), in which he avoided the extreme views of G. F. Creuzer and C. A. Lobeck, prepared the way for the scientific investigation of myths; while the study of ancient art was promoted by his *Handbuch der Archäologie der Kunst* (1830; Eng. trans. by J. Leitch, 1847), and *Denkmäler der alten Kunst* (1832), which he wrote in association with C. Osterley. In 1840 appeared in England his *History of the Literature of Ancient Greece*; the original German work from which it had been translated being issued in Germany in 1841 (4th ed. by E. Heitz, 1882). Chapters i.-xxii. were translated by Sir George Cornewall Lewis; chapters xxiii.-xxxvi. by J. W. Donaldson, who carried the work down to the taking of Constantinople by the Turks. It is still one of the best books on the subject. Müller also published an admirable translation of the *Eumenides* of Aeschylus with introductory essays (1833), and new editions of *Varro* (1833) and *Festus* (1839).

See memoir of his life by his brother Eduard, prefixed to the posthumous edition of K. O. Müller's *Kleine deutsche Schriften* (1847); F. Lücke, *Erinnerungen an K. O. Müller* (Göttingen, 1841); F. Ranke, *K. O. Müller, ein Lebensbild* (Berlin, 1870); C. Bursian, *Geschichte der klassischen Philologie in Deutschland* (1883), ii. 1007-1028; C. Dilthey, *Otfried Müller* (Göttingen, 1898); E. Curtius, *Altertum und Gegenwart*; and J. W. Donaldson's essay *On the Life and Writings of Karl Otfried Müller* in vol. i. of the English translation of the history of Greek literature. A biography composed from his letters was published by O. and E. Kern, *K. O. Müller, Lebensbild in Briefen an seine Eltern* (1908); see also J. E. Sandys, *Hist. of Classical Scholarship*, iii. (1908), 213-216.

MÜLLER, LUCIAN (1836-1898), German scholar, was born at Merseburg in Prussian Saxony on the 17th of March 1836. Having studied at Berlin and Halle, he resided for five years in Holland, where he collected the materials for his *Geschichte*

der klassischen Philologie in den Niederlanden (1869). Unable to obtain a university appointment in Germany, he accepted (1870) the professorship of Latin at the Imperial Historico-Philological Institute in St Petersburg. There he died on the 24th of April 1898. Müller was a disciple of the methods of Bentley and Lachmann. His *De re metrica poetarum latinorum* (1861; 2nd ed., 1894) represents a landmark in the investigation of the metrical system of the Roman poets (the dramatists excepted), and his *Metrik der Griechen und Römer* (2nd ed., 1885) is an excellent treatise in a small compass (Eng. trans. by S. B. Platner, Boston, Mass., 1892).

His other chief publications were: *C. Lucii saturnarum reliquiae* (1872), including the fragments of Accius and Suetius; *Leben und Werke des Gaius Lucilius* (1876; Suppl. *Luciliana*, 1884); text of Horace (1869; 3rd ed., 1897); *Quintus Horatius Flaccus, eine literarhistorische Biographie* (1880); *Quintus Ennius* (1884), an introduction to the study of Roman poetry; *Q. Enni carminum reliquiae* (1884); *Livi Andronici et Cn. Novii fabularum reliquiae* (1885); *Der saturnische Vers und seine Denkmäler* (1885); *Noni Marcelli compendiosa doctrina* (1888); *De Pacuvii fabulis* (1889); *De Accii fabulis disputatio* (1890).

MÜLLER, WILHELM (1794-1827), German lyric poet, was born at Dessau on the 7th of October 1794, the son of a shoemaker. He was educated at the gymnasium of his native town and at the university of Berlin, where he devoted himself to philological and historical studies. In 1813-1814 he took part, as a volunteer, in the national rising against Napoleon. In 1817 he visited Italy, and in 1820 published his impressions in *Rom, Römer und Römerinnen*. In 1818 he was appointed teacher of classics in the Dessau school, and in 1820 librarian to the ducal library. He died at Dessau on the 30th of September 1827. Müller's earliest lyrics are contained in a volume of poems, *Bundesblüten*, by several friends, which was published in 1816. His literary reputation was made by the *Gedichte aus den hinterlassenen Papieren eines reisenden Waldhornisten* (2 vols., 1821-1824), and the *Lieder der Griechen* (1821-1824). The latter collection was Germany's chief tribute of sympathy to the Greeks in their struggle against the Turkish yoke, a theme which inspired many poets of the time. Two volumes of *Neugriechische Volkslieder*, and *Lyrische Reisen und epigrammatische Spaziergänge*, followed in 1825 and 1827. Müller also wrote a book on the *Homericische Vorschule* (1824; 2nd ed., 1836), translated Marlowe's *Faustus*, and edited a *Bibliothek der Dichtungen des 17. Jahrhunderts* (1822-1827; 10 vols.). His poetic genius was kindred to that of the composer Schubert, who set many of his lyrics to music.

Wilhelm Müller's *Gedichte* were first collected in 1837 (4th ed., 1858); edited by his son, F. Max Müller (1868); there are also numerous more recent editions, notably one in Reclam's *Universalbibliothek* (1894); critical edition by J. T. Hatfield (1906). Müller's *Vermischte Schriften* were edited with a biography by G. Schwab (3 vols., 1830). See F. Max Müller's article in the *Allgemeine deutsche Biographie*; O. Franck, "Zur Biographie des Dichters W. Müller" (*Mitteilungen des Vereins für anhaltische Geschichte*, 1887); J. T. Hatfield, "W. Müllers unveröffentlichte Tagebuch und seine ungedruckten Briefe" (*Deutsche Rundschau*, 1902).

MÜLLER, WILLIAM JAMES (1812-1845), English landscape and figure painter, was born at Bristol on the 28th of June 1812, his father, a Prussian, being curator of the museum. He first studied painting under J. B. Pyne. His early subjects deal mainly with the scenery of Gloucestershire and Wales, and he learned much from his study of Claude, Ruysdael, and earlier landscape-painters. In 1833 he figured for the first time in the Royal Academy with his "Destruction of Old London Bridge—Morning," and next year he made a tour through France, Switzerland and Italy. Four years later he visited Athens, extending his travels to Egypt, and in the sketches executed during this period and the paintings produced from them his power and individuality are apparent. Shortly after his return he left Bristol and settled in London, where he exhibited regularly. In 1840 he again visited France, where he executed a series of sketches of Renaissance architecture, twenty-five of which were lithographed and published in 1841, in a folio entitled *The Age of Francis I. of France*. In 1843 he accompanied, at his own request and his own charges, the government

expedition to Lycia, where he made a number of masterly sketches. He died at Bristol on the 8th of September 1845.

The print room of the British Museum possesses, through the bequest of Mr John Henderson, a rich collection of Müller's sketches. A biography by N. Neal Solly was published in 1875.

MULLET, the name of two different kinds of fishes, distinguished as red mullets and grey mullets.

Red mullets (genus *Mullus*, the name given by the ancient Romans) are marine fishes, with two short dorsal fins remote from each other: the first is composed of feeble spines, the second of branched rays; the anal fin is similar to the second dorsal. The body is covered with large thin scales. The form of the head is peculiar; its anterior profile slopes downwards to the small mouth, which has very small and feeble teeth, and from which two cylindrical barbels are suspended. These organs of touch are generally laid backwards and hidden in a groove between the branches of the lower jaw, but can be erected and called into action independently. About forty different species of red mullets are known, chiefly from the tropical and sub-tropical parts of the Indo-Pacific ocean. In European waters two forms are known which have received different specific names. *Mullus surmuletus* and *Mullus barbatus*. The former in addition to the general red colour has three to five bright yellow bands along the sides from head to tail; these are absent in the other form. It has been proved that this is not a sexual difference, the two forms are varieties or species. The striped form is usually found on the coasts of England, where the plain form is rare or absent. In the Mediterranean both kinds occur, but it is probable that the striped form, which is larger, is more common in the Atlantic and the plain form in Mediterranean and southern waters.

Red mullets do not attain any considerable size, the largest of the tropical species weighing only two or three pounds. They are ground-feeders, evidently using their barbels in discovering their food, which consists of crustacea, worms, and, in the larger species, of small fishes; that they feed on putrid flesh is not borne out by the evidence drawn from their feeble jaws and dentition, but it is probable that they are attracted to a decomposing body by the presence of the small crustaceans which feast upon it. Although the colours of these fishes are brilliant, they are simple and evanescent; only a few of the tropical species exhibit ornamentations in the form of black spots or bands. In many, as also in the European species, red colour prevails, and its preservation after death is considered to enhance the fitness of the fish for the table, and consequently its market value. To produce the intensity of this red colour, fishermen scale the red mullet immediately before its death, a process by which the red pigment cells or chromatophores are excited to expand; fishes which are allowed to die in the water show little red, and therefore red mullets caught by the trawl are less valuable than those obtained in a trammel-net, by which the majority are secured alive. All the species are esteemed as food; but none equals the European species, which was held in exaggerated esteem by the gourmands of Rome. They exhibited the living fish and allowed them to die at the table immediately before they were consigned to the cook; they kept them in large reservoirs until they were wanted, and paid fabulous prices for fishes somewhat above the average size. Little is known about the habits of red mullets; during winter they retire into deep water, late in spring and during summer they approach the coasts and enter even brackish water, but the state of their sexual organs shows that they do not come towards the shore to breed. At Naples they spawn from May to August, and their ova are buoyant and transparent. In June, July and August the young are about an inch long, and already furnished with the two barbels.

The grey mullets form a widely different and distinct family, *Mugilidae*. They are not exclusively marine, but enter brackish water, live always close to the shore, and some of the tropical forms inhabit the pure fresh water of streams and rivulets, without, however, penetrating far inland. Their body is elegantly formed, wedge-shaped, and covered with scales of

moderate size, firmly adherent to the skin. The two short dorsal fins are remote from each other, and the anterior is composed of four stiff spines. The anal fin is similar to the second dorsal; the caudal fin strong and bilobed. The form of the snout is peculiar; the mouth narrow, transverse in the true *Mugil*, and without, or with but feeble, teeth. About seventy different species are known, from almost every coast of the temperate and tropical zones; they swim in small schools and are abundant wherever they occur. Two species are found on the British coasts—*Mugil capito* and *Mugil chelo*, the first being the more common. Some of the fresh-water grey mullets of the tropics, especially those of the West Indian and Indo-Pacific islands, have the mouth more lateral or have distinct though minute teeth; they therefore have been formed into separate genera, *Agonostoma* and *Myxus*.

Grey mullets, at least some of the species, grow to a weight of 10 or 12 lb; but the fish which usually come into the market rarely exceed half that weight. Those in which distinct teeth are developed feed principally on small aquatic animals, whilst the diet of those without teeth consists of animalcules or minute organic substances mixed with the mud or sand which they swallow in large quantities; also coniferoid growths to which small shells adhere are freely taken. To prevent the gills from being clogged by sand or mud, a peculiar apparatus separates these organs from the pharynx. Each branchial arch is provided on each side, in its whole length, with a series of closely-set gill-rakers, each series fitting into the series of the adjoining arch; they constitute together a sieve permitting the passage of the water, while retaining other substances in the cavity destined for mastication. The structure of the intestinal tract is also adapted to the diet of these fishes. One portion of the stomach is globular and surrounded by a thick mass of muscles, the cavity being small and coated with a tough epithelium. This structure reminds us of the stomach of birds, in which it also serves for the trituration of hard substances. The intestine itself is six or seven times as long as the fish. Grey mullets are plainly coloured, generally greenish on the upper parts and more or less silvery on the side. They are wholesome food, well flavoured when taken out of clean water. In the fish-farms of western Italy grey mullets are among the principal fish cultivated. (J. T. C.)

MULLIGATAWNY, the name, derived from the Tamil *milagu-tannir* (i.e. pepper water), given to a favourite hot East Indian soup, made with curry-powder and otherwise highly seasoned, and served usually with rice.

MULLINGAR, a market-town, and the county town of county Westmeath, Ireland, near the river Brosna and on the Royal canal, 50 m. W. by N. of Dublin. Pop. (1901), 4500. It is a junction on the Midland Great Western railway where the branch for Longford, Sligo and Cavan leaves the main line. The principal churches are the parish church (1813) with tower and spire, and the Roman Catholic cathedral for the diocese of Meath. Tanning, brewing, and the manufacture of coarse woollens are carried on, and the town is the centre for the agricultural trade of the district. Mullingar was one of the ancient palatinate towns, but its present appearance is modern. It possessed an Augustine convent founded in 1227, and a Dominican convent founded in 1230, but both were dissolved by Elizabeth. The town was the headquarters of William III. before the siege of Athlone. It formerly returned two members to parliament, but was disfranchised at the Union in 1800. Mullingar is a centre for the trout-fishing in the Westmeath loughs, being in proximity to Loughs Ennell and Owl.

MULLION (corrupted from "munnion"; this is derived from Fr. *mignon*, stump), in architecture, the English term for the perpendicular pieces of stone, sometimes like columns, sometimes like slender piers, which divide the bays or lights of windows or screen work from each other; equivalents are Fr. *meneau*, Ital. *regolo*, Ger. *Fensterpfoste*. H. Wedgwood (*Dict. of Eng. Etym.*) points out that the mullion is "the stump of the division before it breaks out into the tracery of the window." In all styles, in less important work, the mullions are often

simply plain chamfered, and more commonly have a flat hollow on each side. In larger buildings there is often a bead or bowtel on the edge, and often a single small column with a capital; these are more frequent in foreign work than in English. Instead of the bowtel they often finish with a sort of double ogee. As tracery grew richer, the windows were divided by a larger order of mullion, between which came a lesser or subordinate set of mullions, which ran into each other.

MÜLLNER, AMANDUS GOTTFRIED ADOLF (1774-1829), German dramatic poet, nephew of Gottfried August Bürger, (q.v.), was born at Langendorf near Weissenfels on the 18th of October 1774. After studying law at Leipzig he established himself as advocate at Weissenfels and made his début as an author with the novel *Incest, oder der Schutzgeist von Aisnon* (1799). He next wrote a few comedies for an amateur theatre in Weissenfels; these were followed by more pretentious pieces: *Der angolische Kater* (1809) and *Der Blitz* (1814, publ. 1818), after French models. With his tragedies, however, *Der neun- und-zwanzigste Februar* (1812), and especially *Die Schuld* (1813; publ. 1816), Müllner became the representative of the so-called *Schicksalsdramatiker*, and for several years "fate-tragedies" on the model of *Die Schuld* dominated the German stage. His later plays, *König Yngurd* (1817) and *Die Albaneserin* (1820), were less important. Notwithstanding his literary success, Müllner did not neglect his profession, and was given the title of Hofrat; he also edited various journals, and had a reputation as a vigorous if somewhat acrimonious critic. He died at Weissenfels on the 11th of June 1829.

Müllner's *Vermischte Schriften* appeared in 2 vols. (1824-1826); his *Dramatische Werke* in 8 vols. (1828; 2nd ed., 1832). In 1830 four supplementary volumes were published containing mainly criticism. See F. K. J. Schütz, *Müllners Leben, Charakter und Geist* (1830); J. Minor, *Die Schicksalstragödie in ihren Hauptvertretern* (1883), and the same author's volume, "Das Schicksalsdrama" (1884), in Kürschner's *Deutsche Nationalliteratur*, vol. 151.

MULOCK, SIR WILLIAM (1843-), Canadian statesman and jurist, was born at Bond Head, Ontario, on the 19th of January 1843, the son of T. H. Mulock, M.D. From 1882 to 1905 he was a prominent member of the Liberal party in the Federal house; postmaster-general from 1896 to 1905, and minister of labour from 1900 to 1905. He introduced many improvements into the Canadian postal service, and in 1898 in face of much opposition induced the Inter-Imperial Postal Conference to adopt the principle of penny postage within the British Empire. In 1905 he resigned office, and was appointed chief justice of the exchequer division of the High Court of the province of Ontario. From 1881 to 1900 he was vice-chancellor of the university of Toronto, and was largely responsible for the success of the movement leading to the federation between that body and the Victoria University (Methodist).

MULREADY, WILLIAM (1786-1863), English subject painter, was born at Ennis, Co. Clare, on the 30th of April 1786. When he was about five years old his father, a leather-breeches maker by trade, removed to London, where the son received a tolerable education, chiefly under Catholic priests. He was fond of reading, and fonder still of drawing.¹ When eleven years old Mulready was employed by an artist named Graham as the model for a figure in his picture of "Solomon Blessed by his Father David." The painter's interest in the lad did much to confirm his artistic proclivities; and, having studied at home for two years, Mulready applied for advice to Banks the sculptor, who sent him to a drawing school and permitted him to work in his own studio. In 1800 he was admitted a student of the Academy, and two years later he gained the silver palette of the Society of Arts. About this time he was associated with John Varley, the eccentric water-colour painter and drawing-master, whom he assisted in the tuition of his pupils, who included Cox, Fielding, Linnell, William Hunt, and

¹ Some reproductions of his early attempts in this direction are given, along with details of his life, in a scarce volume for the young, entitled *The Looking-Glass*, written by William Godwin under the nom de plume of Theophilus Marcliffe, and published in 1805.

Turner of Oxford. At eighteen he married a sister of Varley's, and at twenty-four he was the father of four sons. The marriage was unhappy, and the pair separated before many years. He "tried his hand at everything," as he said, "from a miniature to a panorama." He painted portraits, taught drawing, and up till 1809 designed illustrations to a series of children's penny books. His first pictures were classical and religious subjects of no great merit, and the early works which he sent to the Academy were mainly landscapes; but he soon discovered his special aptitude for genre-painting, and in 1809 produced the "Carpenter's Shop," and in 1811 the "Barber's Shop," pictures influenced by the example of Wilkie and the Dutch painters. In 1813 he exhibited his "Punch," a more original and spontaneous work, which brought the artist into notice, and two years later his "Idle Boys" procured his election as associate. Next year he received full academic honours, and the election was justified by the "Fight Interrupted" which he then exhibited. It was followed by the "Wolf and the Lamb" (1820), the "Convalescent" (1822), "Interior of an English Cottage" (1828), "Dogs of Two Minds" (1830), the "Seven Ages" (1838), and in 1839 and 1840 by the "Sonnet and First Love," two of the most perfect and poetical of the artist's works. In 1840 he designed an allegorically covered postal envelope (the "Mulready envelope," soon discontinued²) for Rowland Hill, and a set of illustrations to *The Vicar of Wakefield*, which were succeeded by his paintings of the "Whistonian Controversy" (1844), "Choosing the Wedding Gown" (1846), and "Sophia and Burchell Haymaking" (1849). His later works, like the "Bathers" (1849), "Mother teaching her Children" (1859), and the "Toy Seller" (1862), show declining powers, mainly attributable to failing health. The last evening of his life was spent at a meeting of the Academy, of which, for nearly fifty years, he had been a most active and efficient member. He died of heart disease on the 7th of July 1863.

MULTAN, OR MOOLTAN, a city, district and division of British India, in the Punjab. The city is 4 m. from the left bank of the Chenab, near the ancient confluence of the Ravi with that river. It has a station on the North-Western railway. Pop. (1901), 87,394. The city is enclosed on three sides by a wall, but open towards the south, where the dry bed of the old Ravi intervenes between the houses and citadel. Large and irregular suburbs have grown up outside the wall since the annexation in 1849. Within the city proper, narrow and tortuous streets, often ending in *culs de sac*, fill almost the whole space; but one broad bazaar runs from end to end. The principal buildings include the shrines of two Mohammedan saints and the remains of an ancient Hindu temple. The cantonments form the headquarters of a brigade in the 3rd division of the northern army. Multan has manufactures of carpets, silk and cotton goods, shoes, glazed pottery and enamel work, and an annual horse fair. It is moreover one of the most important trade-centres in the Punjab. It is a station of the Church Missionary Society.

The DISTRICT OF MULTAN occupies the lower angle of the Bari Doab, or tract between the Sutlej and the Chenab, with an extension across the Ravi. Area, 6107 sq. m. The population in 1901 was 710,626, showing an increase of 11.7% in the preceding decade, due to the extension of irrigation. The principal crops are wheat, millets, pulse, oil-seeds, cotton and indigo. There are factories for ginning and pressing cotton. Indigo is made only by native processes. Irrigation is largely conducted by inundation channels from the boundary rivers, but the centre of the district is barren. The district is traversed by the main line of the North-Western railway from Lahore,

² "Considerable diversion was created in the city to-day [May 1, 1840] by the appearance of the new penny-post devices for envelopes, half-sheet letters, and bits of sticking-plaster for dabbing on to letters. . . . [The elephants on the Mulready cover] are symbolic of the lightness and rapidity with which Mr Rowland Hill's penny-post is to be carried on. . . . Withal the citizens are rude enough to believe that these graphic embellishments will not go down at the price of 1s. 3d. per dozen for the envelopes, . . . and of 1s. 1d. per dozen for the . . . sticking-plaster." This banter is from the money article of an eminent daily paper.

which crosses the Sutlej by the Empress Bridge opposite Bahawalpur. It is also entered by the branch from Lyallpur to Khanawal junction, crossing the Ravi.

The early Arab geographers mention Multan as forming part of the kingdom of Sind, which was conquered by the caliphate by Mahommed bin Kasim in the middle of the 8th century. On the dismemberment of the Mogul Empire in the middle of the 18th century, Multan fell to the Afghans, who held it with difficulty against the Sikhs. At length, in 1818, Ranjit Singh after a long siege carried the capital by storm; and in 1821 he made over the administration of Multan with five neighbouring districts to Sawan Mal, who raised the province to a state of prosperity by excavating canals and inducing new inhabitants to settle. After the establishment of the council of regency of Lahore, difficulties arose between Mulraj, son and successor of Sawan Mal, and the British officials, which led to his rebellion, and culminated in the second war and the annexation of the whole of the Punjab. The city of Multan, after a stubborn defence, was carried by storm in January 1849. The district at once passed under direct British rule, and order was not disturbed even during the Mutiny.

THE DIVISION OF MULTAN is the south-western division of the Punjab. It was abolished in 1884, but reconstituted in 1901. Its area is 29,516 sq. m. and its population in 1901 was 3,014,675. It includes the six districts of Mianwali, Jhang, Lyallpur, Multan, Muzaffargarh, and Dera Ghazi Khan.

MULTIPLEPOINDING, in Scots law, the technical term for a form of action by which conflicting claims to the same fund or property are determined. The action is brought either by the holder or by a claimant in his name. All who have any claims in the fund or property in question are ordered to appear and give in their claims; the court then prefers them according to their respective rights, and the holder of the fund or property in dispute on payment or delivery is absolved from any further claim in regard to it. It corresponds to the process of *inter-pleader* in English law.

MULTITUBERCULATA, a group of extinct mammals, mostly of small size, whose remains are met with in strata ranging from the Trias to the Eocene, both in Europe and in North America. They are mostly known by their lower jaws, and take their name from the fact that the grinding teeth (fig. 2, *m. 1* and 2 and fig. 3 *a, b, c*) bear two or three longitudinal rows of tubercles, or are provided with tubercles round the edges. From this feature these otherwise unknown animals are believed to be related to the existing egg-laying mammals (duck-billed platypus and spiny ant-eater), constituting the order Monotremata, and are therefore provisionally placed near that group. The largest representative of the Multituberculata is *Polyastodon* from the Lower Eocene of New Mexico; the same beds also yield the smaller *Platodus*; while from corresponding strata at Rheims, in France, has been obtained the nearly allied *Neoplagiaulax*. The latter takes its name from its resemblance to *Plagiaulax* (figs. 1 and 2) from the Purbeck



FIG. 1.—Lower Jaw of *Plagiaulax becclesi*, from the Purbeck Strata of Swanage.

strata of Swanage, Dorsetshire, which was one of the first-known members of the group. These have cutting teeth in front and multituberculate molars behind. *Allodon* and *Ctenacodon* represent the group in the Cretaceous of North America; and the English Purbeck genus *Bolodon*, in which all the cheek-teeth are multituberculate, also belongs here. *Stereognathus* (fig. 3) is another English Upper Oolitic type. Single teeth from the Rhaetic of England and Württemberg described as *Microlestes* apparently indicate the earliest member of the group. A skull

from the Upper Triassic Karoo beds of South Africa described as *Tritylodon longaeus*, which has multituberculate molar teeth, was also at first placed in this group, but has been subsequently regarded as a reptile, although Dr R. Broom considers that the



FIG. 2.—Lower Jaw of *Plagiaulax minor*, from Swanage. *p. 1-4* premolars; *m. 1* and 2 molars.



FIG. 3.—Fragment of Jaw of *Stereognathus oolithicus* in matrix. *a, b, c*, molars.

original determination is correct. Possibly a fore-limb from the same formation described as *Theriodon* indicates a similar or allied animal. Not improbably *Tritylodon* indicates a direct link between the multituberculate mammals and the anomodont reptiles of the Permian and Trias. (R. L.*)

MUMMERS, bands of men and women in medieval and later England and elsewhere, who, during periods of public festivity, particularly at Christmas, dressed in fantastic clothes and wearing masks or disguised as animals, serenaded the people outside their houses or joined in the revels within. In a more restricted sense the term is applied to the actors in the old English rural folk-plays of St George, &c.; and "mumming" thus becomes a contemptuous synonym for any form of stage-playing. The origin of the word mummer (older spelling "mommer," Fr. *mommer*) is not satisfactorily explained; but the verb "to mum" means both to mutter and to be silent, and "mummer" apparently comes from one or both of these senses. Mumming seems to have been a survival of the Roman custom of masquerading during the annual orgies of the Saturnalia. "The disguising and mummying that is used in Christemasse tyme," Langley writes in his synopsis of Polydore Virgil, "in the Northe partes came out of the feasts of Pallas, that were done with visars and painted visages, named Quinquatria of the Romaynes." Auban, writing of mumming in Germany, says that "in the Saturnalia there were frequent and luxurious feasting amongst friends, presents were mutually sent, and changes of dress made: that Christians have adopted the same customs, which continue to be used from the Nativity to the Epiphany: that exchanges of dress too, as of old among the Romans, are common, and neighbours by mutual invitation visit each other in the manner which the Germans call mummying." Christmas was the grand season for mumming in England. Some were disguised as bears, others as unicorns, or wore deer's hide and antler's or ram's horns. Mumming led to such outrages that Henry VIII. issued a proclamation declaring the wearing of a mask or disguise a misdemeanour. Stow gives an account of an elaborate mummying held in 1577 by the London citizens to amuse the son of the Black Prince, then living at Kennington (*Surrey*, 1603, p. 97). In Scotland, where mumming still exists at Christmas, Hogmanay, New Year's Day and Handse Monday, mummies are called "guisards." They usually present on these four nights a rude drama called *Galatian*, which, in various versions, is common throughout the Lowlands of Scotland (see Chambers's *Popular Rhymes*, p. 170).

MUMMIUS, LUCIUS (2nd century B.C.), surnamed Achaicus, Roman statesman and general. Consul in 146 B.C. Mummius was appointed to take command of the Achaean War, and having obtained an easy victory over the incapable Diaeus, entered Corinth unopposed. All the men, women, and children were put to the sword, the statues, paintings and works of art were seized and shipped to Rome, and then the place was reduced to ashes. The apparently needless cruelty of Mummius in Corinth, by no means characteristic of him, is explained by Mommsen as due to the instructions of the senate, prompted by the mercantile party, which was eager to get rid of a dangerous commercial rival. According to Polybius, his inability to resist the pressure

of those around him was responsible for it. In the subsequent settlement of affairs, Mummius exhibited considerable administrative powers and a high degree of justice and integrity, which gained him the respect of the inhabitants. He specially abstained from offending their religious susceptibilities. On his return to Rome he was honoured with a triumph. In 142 he was censor with the younger Scipio Africanus, whose severity frequently brought him into collision with his more lenient colleague. Mummius was the first *novus homo* of plebeian origin who received a distinctive cognomen for military services. His indifference to works of art and ignorance of their value is shown by his well-known remark to those who contracted for the shipment of the treasures of Corinth to Rome, that "if they lost or damaged them, they would have to replace them." For the theatrical pageants exhibited by him he erected a theatre with improved acoustical conditions and seats after the Greek model, thus marking a distinct advance in the construction of places of entertainment.

His brother, SPURIUS MUMMIUS, a man of greater refinement and intellectual powers, accompanied Lucius as his legate to Achaë, whence he sent letters to his friends at Rome, describing his experiences in humorous verse. These letters, which were still popular a hundred years later, were the first example of a distinct class of Roman poetry—the poetic epistle. Both he and his brother are alluded to by Cicero as mediocre orators, whose style was simple and old-fashioned, although Lucius, as a Stoic, was more concise.

MUMMY (from the Persian *mumiai*, pitch or asphalt), a dead body, as preserved by the ancient Egyptian method of embalming. The preservative climate of Upper Egypt and the belief of the Egyptians in life after death must be the causes which led them to take unusual care for preserving the bodies of their dead. In prehistoric times in Egypt the dead were laid in the graves on mats in the crouching position common in the burials of primitive peoples, and were supplied with jars of food, flint instruments, &c. Perhaps the attempt was already made to preserve the bodies by drying or otherwise. In a few instances, such bodies, probably more than five thousand years old, have been found with skin and hair well preserved though dried and shrunken; usually everything but the bones has decayed. With the advent of the Dynasties the bodies of some of the principal people are found lying extended at full length. By the time of the Vth Dynasty it was usual to lay the corpse on its left side in the attitude of sleep, and a wooden coffin was often provided upon which were inscribed magic formulae that had already been employed for ages in ritual. In the Middle Kingdom necropolis of Beni Hasan, Garstang found many intact interments in coffins, and in one case the body was well preserved. Several were accompanied by boxes divided into four compartments and inscribed with the names of the four deities who represented the internal organs of the body. This indicates that the custom of taking out these organs and wrapping them separately was already in vogue in the most lavish form of burial. But the parcels, examined by an expert, contained no trace of organic remains, proving how much the Egyptians depended on magic imitations and make-believe. It was not until the New Kingdom that the processes of embalming reached a high degree of elaboration. Later still, in the last millennium B.C., it seems that even the bodies of the poor were pickled. The embalmers were accustomed to keep the corpse in all for seventy days before burial (cf. Gen. 1. 3; Herod. ii. 86), to be soaked, wrapped in linen bandages, and put in the coffin. This is confirmed by the monuments as far back as the age of Rameses II. (c. 1300 B.C.) and may be conjectured to have been established still earlier.

The Egyptians did not stop at the mummification of the human body; sacred animals, birds, reptiles, fishes, and even insects were treated in a similar way, and the meat offerings deposited with the wealthy dead were likewise "preserved." Vast cemeteries of animals which belonged to the revered species have been discovered; more especially may be mentioned that of the cats at Bubastis, the remains of which, charred by some

great fire, until recently filled numberless chambers of crude brick in the ruins at Zagazig. In the hawk cemeteries birds were pickled and buried in long bundles, forming sometimes an assortment that is not without incongruities from the naturalist's point of view. From a few of these bundles may be extracted not only numbers of raptorial birds, large and small, including owls, but also the hawk-like cuckoo, the shrike, and even the swallow. The larger animals were represented in mummies by the head and a selection of the bones. Bones of bulls and male calves, especially crania, were collected and formed into huge ox-like mummies.

What the Egyptians really thought of mummification can only be partially guessed. Custom, changing in some degree from century to century, governed their practice, and no doubt was regulated by the priests. At first the luxury of mummification was reserved for the king, who was identified with Osiris and was buried with an abundance of ritual and magic words. But the king required his courtiers, and his courtiers in turn needed their servants in permanent attendance. Partly in consequence of this, the deification of the king, with all its concomitants, was gradually extended through the ranks of the noble and wealthy until it came within the reach of the humblest, and even animals shared the honour of deification after death. Finally, in a papyrus of the Roman age, the word "god" is practically defined as "buried," i.e. with due rites. Beliefs regarding the gods and life after death were self-contradictory and variable, but none interfered with the custom of preserving the body. It was always the prayer that the soul (*ba*) should be able to revisit the corpse (*khat*), and some inscriptions show an expectation of the body itself being revived, "the mouth speaking," "the legs walking" and everything conforming with its previous terrestrial life. At the same time the *ka* ("life," "activity," and almost "ghost,") which clung to the neighbourhood of the tomb and enjoyed the ghosts of offerings in ghostly fashion, had some of the independent enterprise which the *ba* possessed in abundance. The mummified corpse as a divine thing—not the mere *khat*—was called the *sahu* (an old word meaning "noble") or *ikh*, which in the latter period meant a spirit or demon. As the corpse was found generally to disappear and decay in spite of preservative magic, especially in the early ages, various substitutes were resorted to; statues and statuettes were thought efficacious, but, apart from their costliness, even these were subject to decay or destruction by violence, and in the absence of anything more substantial the Egyptians doubtless reflected that magic words alone in the last resort made everything right.

Under the Old Kingdom the attendance on and services for a dead magnate—the sacrifices and libations at his tomb—were left, together with endowments, to a staff of priests, called "servants of the *ko(ka)*," whose offices were hereditary. This system led to disputes and neglect, and was so unworkable that we find in the texts of the Middle Kingdom the whole responsibility put upon one well-endowed "ko-servant," who passed on his office to a single heir. How these things were managed during the New Kingdom we do not know. In the last thousand years B.C. the life of the Egyptians consisted largely in every kind of religious and superstitious observances. Papyri of the Ptolemaic age or somewhat earlier afford much information about the people of the necropolis. In this age the *choachytæ*, as the Greeks called them ("libation priests," or "shrine-openers" in Egyptian), belonged to an inferior grade of the priesthood, equivalent to the *pastophori* of the deities, and were organized in guilds for the different cemeteries. A single choachyte would have an interest, not always the sole interest, in a large number of mummies, and these interests could be disposed of by will or contract, bought and sold. The *taricheutæ*, or embalmers, had no permanent interest in the mummies they prepared.

Thanks to the great care expended on the preservation of the royal dead, although the mummies of all the other kings have disappeared, a wonderful series of the Theban kings and queens of the New Kingdom from the XVIIth Dynasty to the XXIth

Dynasty has come down to us. It comprises some of the most notable figures in Egyptian history—Ahmose (Amasis) I., who freed Egypt from the Hyksos, Tethmosis I. and III., the conquerors of Syria and makers of the empire, Amenophis III., the great builder, whose likeness is preserved in the colossi of Memnon, probably also his son, Amenophis IV. (Akhenaton), the heretic king, and Seti (Sethos) I. and his son Rameses II. The mummy of Seti I. is in the finest possible preservation, but others, after being brutally plundered, were rewrapped by the piety of later generations.

In Lower Egypt practically all the mummies have perished; but in Upper Egypt, as they were put out of reach of the inundation, the cemeteries, in spite of rifling and burning, yield immense numbers of preserved bodies and skeletons; attention has from time to time been directed to the scientific examination of these in order to ascertain race, cause of death, traces of accident or disease, and the surgical or medical processes which they had undergone during life, &c. This department of research has been greatly developed by Dr Elliott Smith in Cairo. He has examined not only the more recently found of the royal mummies, but also multitudes of skeletons, &c., which have been brought from the official excavations of the government and from other work. His researches, in particular instances, prove their high importance for the history of disease, for characterization of the races inhabiting Egypt, and in other ways. The cemeteries just south of the First Cataract on a first examination reveal a prehistoric race of Egyptian type, a group of male negro mercenaries, a group of male prisoners executed by hanging during the New Kingdom, while from a necropolis of Christian foreigners of about the 6th century comes the first instance of gout in an ancient body from Egypt. Among the prehistoric people are many female skeletons with a fractured right ulna sustained in warding off blows, and some of these women had died while still wearing splints. Circumcision is traceable on all the male bodies which are in a state to show its effects. The royal mummies furnish evidence of age at death as well as of health and physical character. A series of forty-four mummies of priests and priestesses of the XXIIst Dynasty furnished the material for an important monograph. Earlier, the processes of mummification produced a skeleton merely clothed in a dry and shrunken skin. At this time, however, the flesh was replaced by a stuffing of sawdust, sand, or other lasting material, introduced with great skill through a few incisions and apertures, so that the natural forms were completely restored. The heart was left in place, but the liver, lungs, stomach and intestines were pickled and wrapped separately and then restored to the body cavity. Later, the form was reproduced by elaborate external wrappings of the different parts of the body before the final swathing; later still, in the Ptolemaic age, by coarse padding with plenty of linen and pitch. The XXIIst Dynasty marks the highest level of the art. The Christians of the early centuries, looking for corporeal resurrection, avoided the incisions, extraction of organs, &c., practised by their pagan forefathers, and buried the body entire after pickling it in salt. Their stricter leaders, however, objected to a custom which so easily led to the worship of relics and the continuance of pagan observances; and with the advent of Islam embalming fell into disuse.

Outside Egypt mummification was practised amongst the ancient Peruvians, who took advantage of the desiccating

atmosphere and salt soil of their caves for preserving the dead in good condition without any embalming process. Among the Guanches of the Canary Islands, however, the Egyptian methods of emptying the body and padding the skin were closely paralleled.

A word may be added about the use of mummy in medicine. The name, as has been pointed out above, is derived from the Persian *mumiai*, meaning pitch or asphalt, which substance occurs frequently in the prescriptions of the Greek and Roman medical writers. Medieval physicians in the East conceived the happy idea that the highest virtue would exist in that which had been already employed by the Egyptian priests in preserving the human body. Thus the bituminous and fatty matters found about the mummies and their wrappings were employed as a sovereign remedy, particularly for wounds and contusions, and a brisk trade began in these "exudations" of mummies. This led further to the medicinal use of fragments of the mummies themselves; and, finally, the starting-point was lost sight of, so that the dried or prepared flesh of criminals became one of the standard forms of mummy in the pharmacopoeia. It was not till the 18th century that the importance of mummy in all its forms waned, and in some of the least progressive quarters of central Europe it survived even to the middle of the 19th.

See T. J. Pettigrew, *A History of Egyptian Mummies* (London, 1834); G. Elliott Smith, *A Contribution to the Study of Mummification in Egypt* (Cairo, 1906); *The Archaeological Survey of Nubia Bulletins* (Cairo, 1908 seq.); Dr Lortet and M. C. Gaillard, *La Faune momifiée de l'ancienne Egypte* (Lyons, 1905); A. Wiedemann, "Mumie als Heilmittel," in *Zeitschrift des Vereins für rheinische und westfälische Volkskunde* (1906). (F. L. G.)

MUMPS (syn. *Cyanche parotidæa*, *parotitis*; also, "The Branks"), a specific infectious disease characterized by inflammatory swelling of the parotid and other salivary glands, frequently occurring as an epidemic, and affecting mostly young persons. The name "mumps" (O. Eng. "to mump," meaning to sulk) originated, no doubt, in the patient's appearance. The disease generally sets in with symptoms of a cold or catarrh accompanied with slight febrile disturbance; but soon the nature of the ailment is announced by the occurrence of swelling and stiffening in the region of the parotid gland in front of the ear. The swelling speedily increases in size and spreads downwards towards the neck and under the jaw, involving the numerous glands in that locality. The effect is to produce much disfigurement, which becomes still greater should the inflammation spread, as often happens, to the glands on the other side of the face and neck. Pain is present in the swollen parts, but it is seldom severe, nor is there much redness or any tendency to suppuration. There is, however, considerable interference with the acts of mastication and swallowing. After continuing for four or five days the swelling and other symptoms abate, and the parts are soon restored to their normal condition. During the period of convalescence there occasionally occur some swelling and tenderness in other glands, such as the testicles in males (*orchitis*), and the mammae or ovaries (*oöphoritis*) in females, and possibly involvement of the pancreas, but these are of short duration and usually of no serious significance. Mumps is in general a mild disease, and requires little treatment beyond a gentle laxative, the application of warm fomentations to the swollen and painful parts, the use of soft food, and rest.