

LON MILO DUQUETTE

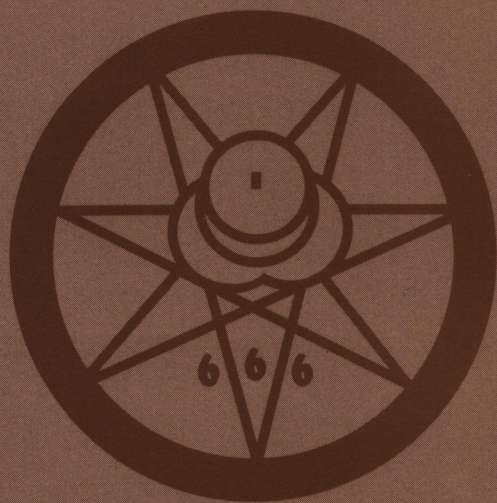

THE  
MAGICK  
OF THELEMA

---

A Handbook of the Rituals of  
Aleister Crowley

THE  
MAGICK  
OF THELEMA

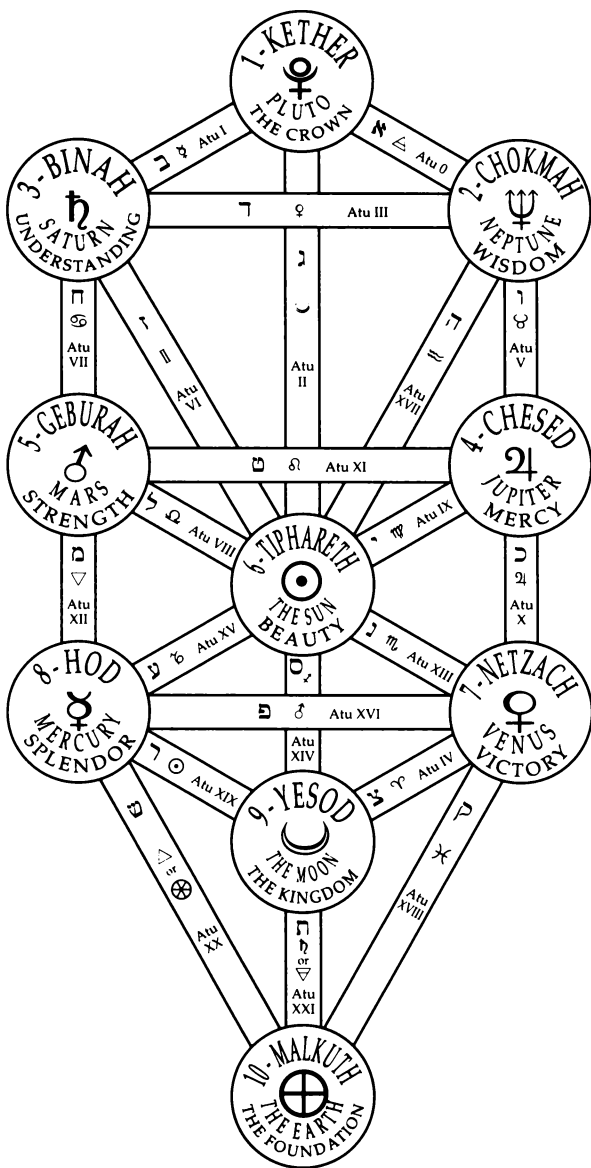

*The Tree of Life. (Source: Crowley: Magick Without Tears, 777 Revised, and The Book of Thoth; reproduced by Hymenaeus Beta, copyright © 1993 O. T. O.)*

# THE MAGICK OF THELEMA

---

A Handbook of the Rituals of  
Aleister Crowley

LON MILO DUQUETTE

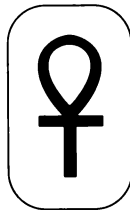

SAMUEL WEISER, INC.

---

York Beach, Maine

First published in 1993 by  
Samuel Weiser, Inc.  
Box 612  
York Beach, Maine 03910

Copyright © 1993 Lon Milo DuQuette  
All rights reserved. No part of this publication may be reproduced or transmitted in any form or by any means, electronic or mechanical, including photocopy, without permission in writing from the publisher. Reviewers may quote brief passages.

Library of Congress Cataloging-in-Publication Data  
DuQuette, Lon Milo

The magick of Thelema : a handbook of the rituals of Aleister Crowley / by Lon Milo DuQuette.

p. cm.

Includes bibliographical references and index.

1. Magic. 2. Occultism. 3. Crowley, Aleister, 1875-1947.

I. Title.

BF1611.D87 1993

133.4'4--dc20

93-10004

CIP

ISBN 0-87728-778-3  
EB

The symbol on the cover is Crowley's personal sigil, "The Mark of the Beast." It depicts the union of the Sun and Moon within the seven-pointed star of Babalon.

Photographs on page 62, 63, 64, and 65 copyright © 1993 Paul Maska.

Typeset in 11 point Palatino

Printed in the United States of America

99 98 97 96 95 94 93  
10 9 8 7 6 5 4 3 2 1

The paper used in this publication meets the minimum requirements of the American National Standard for Permanence of Paper for Printed Library Materials Z39.48-1984.

## DEDICATION

To my wife of twenty-six years,  
Saint Constance of the Well, Our Lady of Perpetual Motion,  
this work is lovingly dedicated.

“There is no bond that can unite the divided but love.”  
—*Liber AL vel Legis*, I. 41.

## TABLE OF CONTENTS

<b>Foreword by Hymenaeus Beta X°</b> .....	ix
<b>Acknowledgments</b> .....	xi
<b>Introduction</b> .....	xiii
CHAPTER ONE	
<b>The Magick of Will</b> .....	1
CHAPTER TWO	
<b>The Evolution of Magical Formulae</b> .....	5
CHAPTER THREE	
<b>The Book of the Law</b> .....	17
CHAPTER FOUR	
<b>The Pentagram Rituals</b> .....	51
CHAPTER FIVE	
<b>The Thelemic Rituals of the Pentagram</b> .....	77
<i>The Star Ruby &amp; Liber V vel Reguli</i>	
CHAPTER SIX	
<b>The Hexagram Rituals</b> .....	113
CHAPTER SEVEN	
<b>The Thelemic Ritual of the Hexagram</b> .....	123
<i>The Star Sapphire</i>	
CHAPTER EIGHT	
<b>Knowledge and Conversation of the Holy Guardian Angel</b> .....	133
<i>Liber Samekh</i>	

CHAPTER NINE

**The Solar Rites** ..... 185  
*Liber Resh & The Mass of the Phoenix*

CHAPTER TEN

**Thelemic Mysticism** ..... 199  
*Liber NV & Liber HAD*

CHAPTER ELEVEN

**Thelemic Orders** ..... 215

CHAPTER TWELVE

**The Religion of Thelema** ..... 225  
*The Mass of Ecclesia Gnostica Catholica*

Bibliography ..... 249

Index ..... 257

About the Author ..... 271



## FOREWORD

Do what thou wilt shall be the whole of the Law.

Aleister Crowley possessed far too much technical knowledge of magick to readily understand the problems of ordinary students. He frequently asked his younger colleagues to help make his teachings more accessible, and once explained that "It's the sort of thing I can't do myself, not knowing the scope of the mind of the 'gentle reader.'"

Like other "gentle readers" who have delved into Crowley's system on their own, Brother DuQuette found many of the gaps and pitfalls in the system by the time-honored method of falling into them, scrambling out, and trying again until he crossed them. The present work incorporates many of the results of his personal work.

What is true of science holds true for scientific illumination. DuQuette is the first to allow that while some of his findings may be replicated by future experimenters, others are subjective personal interpretation. But even the latter are invaluable as suggesting other lines of investigation, and as examples of the kind of personalization of the system that enables the magician to make it his or her own.

DuQuette also drew on recent research by other students that will be formally published in the forthcoming one volume edition of Crowley's *Book Four*. Speaking of Lon Milo DuQuette's mythical eponym, Crowley wrote in Part II of his *Book Four* that "Milo began by carrying a newborn calf; and day by day as it grew into a bull, his strength was found sufficient." It is not stretching the metaphor too far to suggest that the present work will be useful to many students as an introductory guide to those portions of Crowley's *magnum opus* dealing with ceremonial magick.

Occultism frequently gives ample grounds for criticism to its detractors by making insupportable claims for vaguely defined powers, the whole compassed by nonsensical theory. As Israel Regardie did before him, DuQuette avoids this by writing from his own experience, with a healthy leavening of common sense and a refreshing sense of humor.

Love is the law, love under will.

Hymenaeus Beta X°  
Frater Superior, O. T. O.

## ACKNOWLEDGMENTS

I wish first to thank Caliph Hymenaeus Beta, X<sup>o</sup>, Frater Superior of Ordo Templi Orientis, for allowing me access to the Order's archival material and for his fraternal encouragement, counsel, and criticism.

My thanks also go to Soror Meral, of the College of Thelema, Christopher S. Hyatt, of the Israel Regardie Foundation, James Wasserman, Clive Harper, Frater E. A. O. A., Rick Potter, Latin scholar, David Coe, D.G., Bill Heidrick; and to Paul J. Maska for his excellent photographs, and Ed Sentowski for his makeup artistry.

It gives me profound pleasure to thank the dedicated and talented Thelemic ritualists of Heru-ra-ha Lodge O. T. O., and 93 Lodge O. T. O., with whom I have labored, and from whom I have learned for over fifteen years; especially LeRoy Lauer, Doug James, Karen James, Steve Abbott, Judy Abbott, Jim Kababick, David P. Wilson, and Constance Duquette.

Lastly, "...unto them from whose eyes the veil of life hath fallen..." Grady L. McMurtry (Caliph Hymenaeus Alpha X<sup>o</sup>), Francis I. Regardie, Gerald Yorke, and the "prophet of the lovely Star," Aleister Crowley, I offer my perpetual thanks.

The quoted material at the beginning of each chapter is from the works of Aleister Crowley. In case you would like to explore these passages further, the following reference list will be of interest.

Chapter One: *Magick in Theory and Practice* (New York: Magikal Childe, 1990), p. xii. This work was originally published in Paris by Lecram Press in 1929.

Chapter Two: "The Pentagram." From *Thumbs Up! Five Poems by Aleister Crowley*, p. 2. This book was privately printed by the O. T. O. in 1942 "for free distribution among the soldiers and workers of the Forces of Freedom."

Chapter Three: This quote is from The Class A Comment of *The Book of the Law* (reprinted in its entirety in this work).

Chapter Four: *The Equinox*, Vol. I, no. 1 (London: 1909; reprinted York Beach, ME: Samuel Weiser, 1992), p. 17.

Chapter Five: *Liber LXV*, in *The Holy Books of Thelema* (York Beach, ME: Samuel Weiser, 1990), p. 59.

Chapter Six: *Liber DCCXII vel ARARITA* in *The Holy Books of Thelema* (York Beach, ME: Samuel Weiser, 1990), pp. 217, 218.

Chapter Seven: *Chapter 108* in *Liber Aleph* (York Beach, ME: Samuel Weiser, 1991), p. 108.

Chapter Eight: *Magick in Theory and Practice* (New York: Magickal Childe, 1990), p. 11.

Chapter Nine and Ten: These quotes are from *Liber AL vel Legis*, III, xxxviii (reprinted in its entirety in this work).

Chapter Eleven: *Liber LXI vel Causae* in *The Holy Books of Thelema* (York Beach, ME: Samuel Weiser, 1990), p. xii.

Chapter Twelve: *Magick in Theory and Practice* (New York: Magickal Childe, 1990), p. 174.

## INTRODUCTION

*Do what thou wilt shall be the whole of the Law.*

—Liber AL vel Legis I. 40.

Aleister Crowley is dead. He died of natural causes on December 1, 1947 at the age of 72 at his residence at Netherwood, Hastings. His body was discovered by his landlord who reported that, only moments before, he had heard the old man pacing back and forth across the floor of his second story apartment. There was no one with him when the end came; therefore subsequent reports that his last words were "I'm perplexed" are patently false.

Contrary to many reports, he did not die a raving lunatic. He was bright and witty to the end. (Two of his most extraordinarily brilliant works, *The Book of Thoth* and *Magick Without Tears*, were penned in his last years.) He did not die amid squalor and abject poverty. His modest residence in Hastings was, and still is, a charming and reputable country boarding house.

Distortions of the facts surrounding his death are minor compared to those that still surround the events of his life. But it is not the purpose of this work to systematically rebut the mountains of misinformation that still denigrate the reputation of this remarkable man. This has been accomplished admirably in a variety of well researched biographies including three excellent works which I do not hesitate to recommend to the reader:

*The Legend of Aleister Crowley* by Israel Regardie and P. R. Stephensen (Phoenix: Falcon Press, 1986);

*The Legacy of the Beast* by Gerald Suster (York Beach, ME: Samuel Weiser, 1989);

*The Eye in the Triangle* by Israel Regardie (Phoenix: Falcon Press, 1989).

Even though the focus of this book is upon the importance of the ritual works of Aleister Crowley, I would be remiss in my responsibility to the beginning student (not to mention my publisher) if I did not at the outset endeavor to disabuse the reader who has perhaps given credence to the misstatements and downright whoppers that continue to be perpetuated by religious zealots and an assortment of tabloid journalists. My conclusions are the result of over twenty years of research into every aspect of his life; interviews with individuals, both here and abroad, who knew and worked with him, including Major G. L. McMurtry and Dr. Francis (Israel) Regardie; and review of historic documents in the archives of Ordo Templi Orientis, the University of Texas at Austin, the University of Syracuse, and the Gerald Yorke collection currently housed at the Warburg Institute of the University of London.

Let us begin with his reputation as “The Wickedest Man in the World,” a black magician, and a Satanist.<sup>1</sup> Although he seemed to enjoy being accused of such things, especially in print, Crowley was none of the above. True, there is much in the imagery of his writings that is dark and at first glance very frightening. But, when viewed objectively, no more so than that found throughout any number of traditional religious texts, Eastern or Western.

It is clear, even in his earliest works, that he often overestimated the level of sophistication and education of his readers, and that he took fiendish delight in terrifying those who were either too lazy or too slow-witted to understand him. The student must bear this ever in mind if he or she expects to get anything out of his writings. In a footnote to Chapter 12 of *Magick in Theory and Practice* (portions of which are often quoted out of context by detractors to “prove” Crowley’s advocacy of human sacrifice), he explains quite clearly what he is doing:

---

<sup>1</sup> There are those, of course, who consider Martin Luther, John Lennon, and Mister Ed satanists, and ballroom dancing and bingo a form of Devil worship.

There is a traditional saying that whenever an Adept seems to have made a straightforward, comprehensible statement, then is it most certain that He means something entirely different. The Truth is nevertheless clearly set forth in His Words: it is His simplicity that baffles the unworthy. I have chosen the expressions in the Chapter in such a way that it is likely to mislead those magicians who allow selfish interests to cloud their intelligence, but to give useful hints to such as are bound by the proper Oaths to devote their powers to legitimate ends.<sup>2</sup>

He did not sacrifice children nor did he participate in or advocate human sacrifice.<sup>3</sup> The preposterous statement written in the above mentioned chapter, in which it appears he confesses to the sacrifice of over 156 male children in one year, was nothing more than an outrageous literary blind. It is obvious to anyone who carefully reads the chapter and its footnotes that the only thing he was confessing to was his practice of a simple technique of sexual magick whereby he ejaculated 156 times that year without making his partner pregnant.

Today the bookstore shelves are filled with books and manuals on Tantra Yoga that elucidate explicitly upon the same sexual technique and hundreds more. But in 1923, when Crowley wrote the above, such candor in print could not be published. Ironically, talk of human sacrifice, and other such shocking subjects, *could* be. Consequently Crowley clothed many of his teachings in a thin veil of sensational titillation. By doing so he assured himself that

---

<sup>2</sup> The most recent reprinted edition by Magickal Childe Publishing, New York, 1991, p. 100. For full bibliographic information for this and all succeeding texts, please refer to the bibliography in the back of this book.

<sup>3</sup> As a matter of fact, he was never at any time even *charged* with any criminal offence whatsoever. The reason for this is simple; he never committed any crimes to be charged with.

- 1) his works would be understood and appreciated only by the few individuals capable of doing so;
- 2) long after his death his works would continue to generate interest and be published for the benefit of both his admirers and his enemies.

It did not matter to him that his writings would continue to be misunderstood for generations after his death. Neither did it matter to him that only a few individuals at any given time would understand him. It only mattered that the works would survive to reach them.

There is no question that he lived an extremely eccentric lifestyle which caused rise to many wild rumors and speculations, (few of which he was inclined to deny), and often there was at least a scrap of truth in many of the accusations leveled at him. But it must be remembered that what was "scandalous" behavior in Victorian and Edwardian England might not seem very shocking to us today. Some of the more imaginative charges leveled against him (*i.e.*, he was Hitler's guru; he ate babies; he personally decapitated Amelia Earhart in Japan; he was responsible for the sinking of the Titanic, etc.) are, needless to say, totally false.

He despised the hypocrisy and the spiritually restrictive aspects of established religions, including Christianity, and did not deny charges that his philosophy was anti-Christian. However, careful examination of his writings reveals a profound understanding and respect for the pure spiritual impulse that is at the heart of all religions.

He was by no means perfect. He was not good with people and often alienated those who loved him dearest. His bold explorations of human sexuality and drugs (always meticulously recorded and analyzed) are fascinating to study, but were never intended to be casually emulated. I have never encountered anyone who knew him that did not disapprove of some aspect of his character or behavior.



But he is dead. For us, only his works remain as measure of the man, and they are currently more accessible to the general public than at anytime during his life. His influence on the modern world of art, literature, religion, and philosophy is now widely acknowledged even by his most vehement critics.

It is my hope that this little book may help bring the wonder of his genius to a new generation of seekers and to an even broader audience of serious students. But, for those whose belief in a God of goodness hinges upon the reality of a Devil who is equally evil; for the superstitious, the ignorant, the lazy, the immature, the unbalanced, the mentally ill, the paranoid, the faint-hearted; for anyone who for any reason cannot or will not take responsibility for their own actions, their own lives, their own souls; for these people Aleister Crowley is still a *dangerous man*.

*Love is the law, love under will.*

Lon Milo DuQuette  
Vernal Equinox, 1993

## CHAPTER ONE

# THE MAGICK OF WILL

*Magick is the Art and Science of causing change to occur in conformity with Will.*

### Magick in Theory and Practice

The above definition of Magick can be as misleading in its simplicity as it is in its complexity. The key word is of course *Will*, θελημα<sup>1</sup> in Greek, and according to this definition, any willed action is an act of Magick: brushing your teeth, walking the dog, or even paying your taxes.

Conversely any *unwilled* action is an unmagical act: reaching for a cigarette; ordering that fourth Martini; or any *habitual or reactive behavior that overrides the momentum of one's life focus* could fall into the category of an unmagical act.

Try as we might there is no escaping this simple fact: We are all Magicians and we are either competent or incompetent practitioners of our craft.

The great majority of successful Magicians do not even realize (nor should they care) that they are Magicians, or that there is a name for what they do so well. They just go through life striving to cause change to occur in conformity with their Wills and that's that. They have made a science

---

<sup>1</sup> Thelema; by the Greek Qabalah enumerated to 93 as does Αγαπη (Agape) Love.

out of their lifestyle and they execute it with great art. They work hard, but for them the work is not a burden it is a labor of love and a continuing expression of the purpose of their existence.

Obviously most of us do not, without great effort, fall into this fortunate category of human being. Our Magick falls somewhere between competence and incompetence. Occasionally we become aware of what our will is (or might be) and try to work the Magick. But more often than not, we find ourselves simply responding to an endless chain-reaction of external events and circumstances over which we have little or no control.

Out of fear, frustration, or what might be called spiritual fatigue, many of us turn to religions whose champions are more than happy to tell us, in no uncertain terms, exactly where our place in the universe is.

The religions that Westerners most frequently are attracted to (Christianity, with its many sects, Judaism, and Islam) postulate a Supreme Being who personifies and manifests the order of the universe. The mechanism of this order is often termed the "will of God." By surrendering the individual will to will of God, the religious devotee can theoretically harmonize his or her life with that of the Deity's. *Not my will, but Thine be done.*

In order for us to know God's Will, these religions offer, for our great comfort (and often from ancient and "infallible" sources), rules, commandments, and assorted scriptural injunctions to guide the thoughts and behavior of the faithful. As an added safeguard that these scriptures be "correctly" interpreted, a priestcraft of some form or another invariably evolves and assumes the role of a visible mediator between the worshipper and the Deity.<sup>2</sup> For those who

---

<sup>2</sup> This should not be interpreted as a blanket condemnation of "Holy Scripture." Indeed, the Magick of Thelema is based firmly upon its Holy Book, *Liber AL vel Legis*. This text is unique among such writings, however, in that it forbids anyone to interpret its meaning for anyone else, thereby avoiding the pitfalls of doctrine, priestcraft and dogma.

dutifully comply with the dictated formulae and surrender their wills to the prescribed will of God, a great burden is lifted from their shoulders. They no longer feel the need for direct spiritual experience, and faith in the infallibility of the dogmatists makes even intellectual investigation unnecessary. The reward for such spiritual collaborators is the smug comfort of knowing that those who haven't submitted to the formula will suffer after death, and that they who have, will not.

Magick also postulates a universal order—call it God, Nature, the Supreme Being, the Grand Architect of the Universe, the Tao, or just the-way-things-are. But the Magician knows that the pure Will of every man and every woman is already in perfect harmony with the divine Will; in fact they are one and the same. It is the Magician's Great Work to endeavor to remove the obstacles that hinder his or her perfect realization of that Will and then proceed to execute it.

We perceive in the world around us a vast cosmic orderliness (or at least a glorious systematized chaos). Galaxies, stars, planets, atoms, electrons, and other sub-atomic particles all seem to have found their niche in the grand scheme of things and behave themselves accordingly. By realizing our True Wills we find our place...our orbit. By doing our True Will, we have the inertia of the entire Universe to assist us.

The Magician does not necessarily want the burden of existence lifted from his shoulders; he wants to understand why he is carrying it and where.

## CHAPTER TWO

---

# THE EVOLUTION OF MAGICAL FORMULAE

*In the Years of the Primal Course, in the dawn of  
terrestrial birth,  
Man mastered the mammoth and horse; and Man was  
the Lord of the Earth.  
He made him an hollow skin from the heart of an holy  
tree;  
He compassed the earth therein, and Man was the Lord  
of the Sea.  
He controlled the vigour of steam, he harnessed the light-  
ning for hire;  
He drove the celestial team; and Man was the Lord of the  
Fire.  
Deep-mouthed from their thrones deep-seated, the choirs  
of the aeons declare  
The last of the demons defeated, for Man is the Lord  
of the Air.  
Arise, O man, in thy strength! the kingdom is thine  
to inherit,  
Till the high gods witness at length that Man is the  
Lord of his spirit.*

### The Pentagram

A magical formula is a statement of perceived cosmological fact or theory. It can be as simple as an axiom:

*Love thy neighbor as thyself. An apple a day keeps the doctor away.*

It can be a statement or a set of symbols revealing the mechanism of a natural law:

*As above, so below. All is sorrow. Love is the law, love under will.  
E = MC<sup>2</sup>. YHVH. INRI. AUM.*

It can even be a single word that initiates an entire age:

*TAO; ANATTA; IAΩ; Θελημα*

Magical formulae evolve from older magical formulae as humanity's ability to perceive itself and the universe increases. A change in the consciousness of the race necessitates a change in magical formula. It's not that the old formula doesn't work anymore, it's just that the new one works so much better. Obsolete formulae of the past aren't necessarily discarded completely but are often amended or fine-tuned to better harmonize with a new, expanded understanding of natural or spiritual law.

To use an apparently *unmagical* example, an ancient carpenter or craftsman seeking to determine the area of a small circle might venerate the great Magician who revealed to him that the area could be determined by measuring the radius of the circle, then multiplying that figure by itself, then multiplying that figure by the sacred number 3. For the rough calculations required by our primitive ancestors, this crude formula served quite adequately. But for larger, more complex projects (such as temples, pyramids, etc.) requiring precise computations, the world had to wait for the "Magick" of  $\pi$ . Once this new bit of information became general knowledge the world was never the same.

While this is a very crude analogy, I am confident that the reader can see how it applies to our ever evolving perception of ourselves and our place in the universe.

## THE FORMULA OF THE NEW AGE

Great spiritual periods (ages or aeons) are characterized by their magical formula. This is very important and funda-

mental to the understanding of Magick in general and Thelemic Magick in particular, for the planet has just recently (relatively speaking) entered a new period; a new age; a new aeon.

Yes, this is coincidental to what astrologers and song-writers call the Age of Aquarius<sup>1</sup> and what millions of others refer to simply as the New Age. But it would be a mistake to view this new aeon as simply another tick on a great cosmic clock. The Age of Aquarius, profoundly significant as it is, is only one aspect of a far greater new spiritual age. (Such magical aeons do not necessarily coincide with the astrological periods and, according to Crowley<sup>2</sup>, may be of any length.) A more intimate, more magical perspective may be had if, rather than considering the ages as merely astrological epochs, we instead view them as gods.

Crowley recognized in the three principal gods of Egypt Isis, Osiris, and Horus the characteristic formulae of the last three magical aeons.

The present aeon is that of Horus, which has followed the Aeon of Osiris, which followed the Aeon of Isis. Each aeon is characterized by the level of understanding of nature and of self contemporarily prevalent, and dictates the variety of magical and religious expression that dominate these periods.

Here it will be necessary to take a moment to review the myth of Isis, Osiris, and Horus, for it is vitally important to the understanding of the evolution of magical formulae and the Magick of Thelema. Please keep in mind that this is only the briefest sketch of a story that has undergone over four thousand years of revision.

---

<sup>1</sup> The Great Astrological Year lasts approximately 26,000 years and is divided into twelve periods of approximately 2,166 years corresponding to each of the twelve signs of the zodiac. Because the Sun does not quite make it back to its starting point each year, it appears to slowly regress backwards through the zodiac at the rate of one sign every 2,166 years. This is why the Age of Aquarius follows that of Pisces, which followed Aries, etc.

<sup>2</sup> *Magical and Philosophical Commentaries on THE BOOK OF THE LAW* (Montreal: 93 Publishing, 1974), p. 271.

## THE MYTH OF OSIRIS

The Creator, Temu, first appeared (from out of a watery chaos) on a sacred mound. Upon this solid foundation of matter he masturbated, creating two children, brother and sister, Shu and Tefnet. These two in turn created Geb (the Earth-god) and Nut<sup>3</sup> (the Sky-goddess) who united to give birth to Osiris, Isis<sup>4</sup>, Seth<sup>5</sup>, and Nephthys. These nine deities make up the ennead of Heliopolis which appear continually throughout the sacred texts.

Osiris became king of Egypt, supported by his sister-wife Isis. Theirs was a golden reign that raised the Egyptian people from the sub-human depths of anarchy and cannibalism. They initiated the systematic cultivation of the land in harmony with the flooding cycle of the river Nile, and their administration brought prosperity and happiness.

Seth, the brother of Osiris, became increasingly envious of the success of his sibling, and conspired to have him assassinated. Secretly he had an ornate box constructed to the exact measurements of the body of Osiris. He then hosted a lavish party for his brother and announced that he would award the box to anyone who could fit perfectly inside. In what can only be described as an act of divine folly, Osiris volunteered to give it a try. As soon as he was comfortably snuggled inside the perfectly fitting box, the lid was immediately nailed shut by seventy-two of Seth's co-conspirators and the coffin set adrift on the Nile.

Isis, hearing of the murder, immediately set out to find the body. She discovered it at Byblos where it had become imbedded in a tree which had been cut down and used, because of its wondrous aroma, as a column in the palace of the king. She pleaded with the local king for the return of her husband's body and was allowed to take it.

---

<sup>3</sup> Spelled "Nuit" in *Liber AL vel Legis*, chapter I, verse 1.

<sup>4</sup> Later identified with the Greek goddess Demeter.

<sup>5</sup> Set, later identified with Apophis and the Greek devil-god Typhon.



As she was returning with it by boat, she laid down upon the body and kissed it until its phallus became miraculously erect. She mounted her dead husband and conceived the child Horus. (Horus or Hoor also has a brother, Hoor-Paar-Kraat, whom the Greeks called Harpocrates. More on this later.)

Seth, discovering where Isis had hidden the body, stole it, dismembered it, and scattered the fourteen pieces throughout the entire country.

Isis set out again and successfully recovered all the pieces of Osiris, save one<sup>6</sup>, and magically reassembled them, thereby bestowing upon Osiris immortality and rulership of the afterlife. Henceforth pious individuals who faithfully adhered to the complex magical formulae of the cult of Osiris, as outlined in *The Book of the Dead*, would be assured of the same continuity of existence after death.

Their son Horus, to avenge the murder of his father, initiated a mighty struggle against Seth, which according to some stories was successful after three days and according to others is perpetuated to this day.

The images of this simple passion play are imbedded deeply in the collective consciousness of the human race. We see it retold almost verbatim by the Greeks as the story of Demeter and Persephone, and Orpheus and Eurydice. IAO, the great God of the Gnostics, even announces the magical formula of life, death, and resurrection in the letters of its name: Isis (Nature) is ruined by Apophis (the forces of destruction and decay), but is cyclically resurrected in Osiris.

Most striking to the Western mind are the similarities between the story of Osiris and the central myth of Christianity: Through treachery a wise young savior is murdered...nailed to His death; the tree whereon the body is affixed; the mourning devotee who begs the return of His

---

<sup>6</sup> The sacred phallus, which Seth threw in the Nile, and was eaten by three fishes was never recovered.

body in order to give it proper burial; the resurrection of the God which also provides the formula for the eternal salvation of the world, etc. All very Osirian.

But I am getting ahead of myself. To understand where we are, we must first understand where we have been, so let us first examine the conditions that characterized the last two aeons.

## THE AEON OF ISIS

**The Formula of the Great Goddess:** It is difficult to speculate precisely when the aeon of the formula of Isis began, for its foundations were laid in the nebulosity of prehistory. However, we can, with relative confidence, venture to pinpoint its zenith as being approximately 2400 B.C.<sup>7</sup>

This was the Age of the Great Goddess, and nowhere at this time was Her worship more conspicuous than in the Sumerian city of Uruk where the magnificent temple of Innana (Ishtar) dominated civilization's first great city. For us to focus exclusively upon Sumeria, however, would be a grave error for, indeed, the cult of the Great Goddess was truly universal. She was worshipped by countless cultures under myriad names and forms. It would also be a mistake for us to conclude that the magical formula of this period manifested exclusively through the worship of any particular anthropomorphic female deity. For, like every aeon, the magical formula of the Aeon of Isis was founded upon mankind's interpretation of the "perceived facts" of nature, and our Isian-age progenitors perceived nature as a continuous process of spontaneous growth.

In the dim beginnings of the aeon, humans were ignorant of the cause and effect mysteries of sex and birth. Life appeared to come from woman alone. Blood flowed inex-

---

<sup>7</sup> This date, coincidentally, also marked the beginning of the astrological Age of Aries.

plicably from her body with the same cycle as that of the moon. And when the cycle of bleeding was interrupted, her belly swelled for nine moons until she burst with new life. She then continued to nourish this life with her milk, the white blood of her breasts, and without this nourishment, drawn directly from her body, the new life would die.

Nothing could match the power of woman. From her, all life proceeded and without her nourishment, no life could survive. Like the moon itself, she lived a three-fold life cycle of maid, mother, and crone; fertility, sustenance, and wisdom.

Once the child was weaned, the Earth itself became surrogate mother, directly providing the flesh and blood of animals and plants for sustenance. Mother was life. Earth was Mother. God was Woman. Death was a mystery that could not be solved nor overcome.

This fundamental perception of nature persisted long after the mystery of where babies came from had been solved. Matriarchies and cannibalism dominated much of this period, but even after the ascent of the male warrior gods, the essential formula of the Goddess lived on.

There exist to this day tribes of hunter-gatherers<sup>8</sup> whose social and religious lives exemplify the formula of Isis, but the Aeon of Isis survived only as long as the spirit of humanity was dominated by the perception that life and its requisite nourishment came directly from the Earth and from the woman.

A clearer perception of the universe would evolve that would usurp the formula of Isis and initiate a new cultural and religious age. We are painfully familiar with this period for it lasted until the turn of the twentieth century. Its formula is still the consensus of the so-called "Great Religions" and continues to dominate the spiritual lives of the majority of the inhabitants of our planet.

---

<sup>8</sup> Although the systematic destruction of the rainforests is bringing an end to these time capsules of prehistory.

In this age the focus was shifted from the Earth to the Sun as the source of all Life, and from the mysteries of birth to the mysteries of death. We figured out where babies came from; now we were to ponder where we go when we die.

## THE AEON OF OSIRIS

**The Formula of the Dying God:** It could be said that the Aeon of Osiris began when men and women first became cognizant of the Sun, and recognized that the fertility of the Earth (and consequently their lives) depended directly upon the vitalizing power of sunlight. The secret of life was now perceived as a partnership of Sun and Earth, and our ancestors saw this partnership reflected in themselves: man and woman, phallus and kteis, father and mother.

When it became universally acknowledged that without the Sun, the Earth would perish, and without the semen of a man, a woman would remain barren, the great pendulum of racial consciousness and attitude took a radical swing. The formula of Isis was altered: woman *brings forth* life, but Life *comes from* the Sun. God was now Father.

This new "illumination" resulted in unprecedented advances in civilization. Armed with the solar knowledge of the cycles of seasons, Osirian-age farmers began the organized cultivation of crops. Cities arose, and with them the economies and armies of great nation-states. Patriarchies supplanted matriarches as the goddesses of countless cultures became "wives" to the new male deities.

But inherent in this new formula was a terrible mystery; a factor that was not a part of the formula of the innocent Aeon of Isis; a dark reality that would become an all-consuming (and some say, unhealthy) preoccupation of the Aeon of Osiris: death.

It was perceived as an undeniable fact that the Sun, the source of all life, was born each day on the eastern horizon and traveled across the sky, bestowing His warm blessings of light and life upon all the Earth. It was also observed that

this great pangenetor “died” each day in the west, plunging the entire world into a cold darkness—a darkness that evoked introspection and fear. Where did the Sun go? Would a new one ever reappear?

Each night after the death of the Sun, our early Osirian-age ancestor fell into an uneasy slumber, and in that sleep lived another life—a strange life, peopled with other men and women, and filled with impossible wonders and horrors. Animals killed in the hunt, dead relatives, enemies, and comrades, all came alive again in this other world of dream. Was this where the Sun went at night? Was this the Land of the Dead?

Of course the fearful night did not last forever and a “new” Sun appeared with comforting regularity each morning to conquer the darkness and assure the continuity of life. But later more sophisticated Sun watchers would experience an even greater insecurity crisis when they observed the dwindling periods of sunlight (as summer moved toward winter) resulted in the decrease or actual cessation of the fecundity of the Earth. No sunlight, no crops. This was serious.

The daily solar cycle showed them that the Sun is capable of totally disappearing from the sky. But unlike the relatively short period of darkness of the daily cycle, there was no telling how long a great night would last if the Sun ever experienced a *yearly* death. Surely all life would end in the frozen darkness of an eternal (or even a lengthy) night.

Unfounded as these fears were, they were based solidly upon a perceived reality, and the trauma became indelibly imprinted upon the psyche of the human race. This “reality,” in turn, formed the foundation of the magical formula of the Aeon of Osiris, the formula of the Dying God.

The Sun, the Father of all Life, goes through a three-fold cycle of birth (life), death, and resurrection. Humankind, knowing themselves also subject to death, believed that by following the magical or religious formula of the Sun, they too could be made eligible for resurrection. What was this formula?

Everywhere our Osirian-age ancestors looked, they saw the drama of the Dying God enacted. The farmer observed the fertilizing effects that blood and decaying flesh had upon the soil; and that seeds (which came from living plants in the summer and autumn) could lie dead and buried throughout the winter months, and then miraculously resurrect as new plants in the spring. It was an obvious and inescapable truth: without death, there is no life.

Did not the Sun suffer death each night and each winter so it might be reborn? Did not the seed offer itself to the Earth so that it might resurrect as a new plant? After ejaculation did not the penis sacrifice its potency to fertilize the ovum and perpetuate the race?

Life from death was a fact, and to assure that the blessings of life would continue to come out of death, our Osirian-age ancestors believed they must take an active part in the great life/death ritual. To this end they took themselves to mountain tops and high places. They gathered stones and proceeded to build altars and offer up *sacrifice* to the gods.

Obviously the great cultural/religious myth of the Egyptians was literally Osirian in nature, but by the dawn of the astrological Age of Pisces (approximately 260 B.C.), the formula of the Dying God had crystalized itself as the central myth of countless cultures and civilizations. The gods of the great mystery cults—Orpheus, Hercules, Dionysus, Attis, Adonis, and later Christ—all were slain and resurrected. The story of Persephone, the central figure of the Eleusinian Mysteries, which flourished for over two thousand years, is a perfect example of the evolution of the formula of the Great Goddess to that of the Dying God.

These cults were wildly popular. To assure one's own resurrection it was necessary to be an initiate and follow the god's formula of catastrophe, love, death, and resurrection. Partially patterned after these mystery schools, orthodox Christianity arose to become the dominant spiritual and political influence of the world for the last two thousand years.

The formula of sacrifice was born of the mistaken belief that the Sun *came up* in the morning and *went down* in the evening. A more accurate perception of the universe is now enjoyed by humanity. We know the Sun does not come up nor does it go down. It does not travel north in the summer nor does it move toward extinction in the south in the winter. The Sun stays “on” all the time. The light is continuous. The death of the Sun is merely an optical illusion, a shifting of shadow.

So universally accepted is this simple fact of nature that today we seldom give it a second thought. Yet the archetypes that influence the great cultural and religious forces of today were formulated during those eras of profound ignorance and superstition. The stories of the dying Sun and the Dying God were myths created, in part, to help our ancestors overcome their fear of the dark and their fear of death. The perception of the universe that initiated the Aeon of Osiris has been forever changed. The formula has been amended. There is no need to fear the dark. There is no need to fear death.

## THE AEON OF HORUS

**The Formula of the Crowned and Conquering Child:** As the child is the physical and genetic product of both its parents, so too the Aeon of Horus reconciles and transcends the formulae of the two previous Ages. Since the turn of the century, we have seen the fall of colonialism and the destruction of the last vestiges of the overtly patriarchal rule of kings in Europe. The temporal power of the Pope is gone, and the illusion of the omnipotent spiritual power of the Church has become diluted beyond hope of revival.

The earth-mother worshipping formula of the Aeon of Isis (violently repressed during the Aeon of Osiris) has been transformed by the evolution of our consciousness, and resurrected as the earth-respecting environmental movement, the Woman’s Movement, and the resurgence of the cult of the Goddess.

These developments are seen by the established Osirian institutions as blasphemous examples of spiritual anarchy and the unholy degeneration of humanity. They grossly misinterpret their own scriptures to warn of an inevitable cleansing conflagration that will reestablish an even greater Osirian rule.

While a certain amount of conflict probably is inevitable (as it is at the beginning of every age), the result most certainly will not be a return to the formulae of the past. Standing, as we are, upon the threshold of the Aeon of Horus, what we observe happening in the world is rather unsettling. But it is the natural result of the vested interests of the old aeon resisting the establishment of the new. It is very much like the strife families experience when a child grows up and finally leaves home. Eventually the parents accept the inevitable and, in most cases, form a new and supportive relationship with their child.

*We* are the child who has just become self-aware. We still love our mother and father but we know we will never be happy as long as we exist only as an extension of their lives. Now that we are conscious of the continuity of existence, now that we perceive the universe as a process of continual growth, now that we recognize the individual as the basic unit of society, we will never return to the flawed and incomplete perceptions of the past.



## CHAPTER THREE

---

# THE BOOK OF THE LAW

*Do what thou wilt shall be the whole of the Law.  
The study of the Book is forbidden. It is wise to destroy  
this copy after the first reading.  
Whosoever disregards this does so at his own risk and  
peril. These are most dire.  
Those who discuss the contents of this Book are to be  
shunned by all, as centres of pestilence.  
All questions of the Law are to be decided only by appeal  
to my writings, each for himself.  
There is no law beyond Do what thou wilt.  
Love is the law, love under will.*

—The priest of the princes  
Ankh-f-n-khonsu

The above "Comment in Class A" appears at the end of all authorized editions of *The Book of the Law* and is an ominous warning to those who would presume to define or interpret the contents of the primary Holy Book of Thelema.

In preparing the present work for publication, I have endeavored, to the best of my ability, to abide by the above injunction, while at the same time providing a sufficient amount of information to enable the reader to begin his or her own line of exploration. This is a bit like walking a tight-rope. I confess that I am not a high initiate, nor am I an exemplary specimen of the ideal Thelemite. The reader is

honor-bound to disregard anything I say if it appears that I have overstepped my bounds in this regard.

As it is impossible to understand the rituals of Thelema without a basic familiarity with *Liber AL vel Legis*, *The Book of the Law*, it would be unfair to the owners of this handbook if we did not include it in its entirety. The deities and magical formulae revealed in this small volume are the very essence of the Aeon of Horus.

Details of how this unique book came into being are outlined in Crowley's *The Equinox of the Gods*,<sup>1</sup> *The Temple of Solomon the King*,<sup>2</sup> and in a number of other recent publications which the reader is encouraged to research. To help put things in historical perspective, I offer the following brief review of the events that surrounded the reception of *The Book of the Law*.

In 1903 Crowley had all but suspended all magical workings and had taken his new wife Rose<sup>3</sup> on an extended honeymoon to a score of exotic locations including Ceylon and Egypt. In December they discovered Rose was pregnant. Rather than returning to their cold home in Scotland, they chose to travel back to Cairo where the weather was pleasant. Assuming romantic identities, they checked into their hotel-apartment as Prince Chioa Khan (Beast) and Princess Ouarda (Rose) and settled in.

Perhaps out of boredom, Crowley performed the "Preliminary Invocation of the Goetia," purposing to show Rose the sylphs. (It must be remembered that Rose had no training or interest in magick.) She did not see the sylphs, but instead fell into a "strange state of mind." She began repeating as if in a trance, "They are waiting for you...it is all about the Child....All Osiris."<sup>4</sup>

---

<sup>1</sup> *The Equinox of the Gods* (New York: 93 Publishing, 1992).

<sup>2</sup> *The Equinox I* (1-10) (London, 1909; reprinted York Beach, ME: Samuel Weiser, 1992).

<sup>3</sup> Rose Kelly, the sister of his friend Gerald Kelly.

<sup>4</sup> *The Equinox of the Gods*, (New York: 93 Publishing, 1992).

She then informed her husband that the God Horus was angry with him for ignoring Him. Irritated by what he at first thought was Rose's childish behavior, Crowley began to interrogate her as to the technical attributes of this "God." To his great surprise, Rose, who had absolutely no knowledge of Egyptology or Magick, answered even the most technical and esoteric questions with 100 percent accuracy.

The next day they visited Cairo's Boulak museum. It was Crowley's intention that Rose point out this God who wanted to talk with him. He sniggered as she ignored and passed by the most common images of Horus, but he was quite surprised when she excitedly identified an obscure wooden funeral *stélé* of the Twenty-fifth Dynasty as the source of her communications. Even more stunning was the museum exhibit number...666. Crowley could not ignore this curious chain of events. He had the *stélé* reproduced and began systematically working with Rose as his magical assistant. (See color insert, pages 47 and 48.)<sup>5</sup>

Space forbids us to detail what followed, and the reader is again referred to the previously mentioned texts. Suffice to say, that through Rose's unexpected mediumship, contact was established with a praeter human intelligence calling itself *Aiwass*, a messenger Hoor-paar-Kraat,<sup>6</sup> who announced the Equinox of Gods (the changing of the age) and the intention of the "gods" to use Crowley to *receive* a book that was to be the fundamental revelation of the new age.

On March 20, 1904, Crowley performed the Supreme Invocation of Horus which formally initiated the Aeon of Horus. As per instructions, between noon and one o'clock on April 8, 9, and 10, he entered the same temple, sat down at a writing table, and wrote what was dictated to him by

---

<sup>5</sup> The photographs of the front and back of the *Stélé Revealing*, along with Crowley's paraphrase were taken from Volume I, Number VII of *The Equinox* (York Beach, ME: Samuel Weiser, 1990) p. 368.

<sup>6</sup> Horus in his aspect as the innocent babe; often depicted fearlessly standing upon two crocodiles, holding his finger or thumb to his lips.

an audible voice. The results of these three hours of dictation are the three chapters of *The Book of the Law*.

The reader is not asked nor expected to believe the story. Each must judge for himself or herself the value of the book. As I mentioned earlier, it is a fundamental proscription of the text to offer to interpret or even discuss *The Book of the Law*. It is entirely up to each of us to fathom its meaning in relationship to our individual lives.

Note: The reader will notice that *Liber AL vel Legis* is designated as a publication in Class A. Crowley originally categorized works which are "Official publications of A.:A.:" into four<sup>7</sup> classifications:

1) **Class A** consists of books that may be changed not so much as the style of a letter: that is, they represent the utterance of an adept entirely beyond the criticism of even the Visible Head of the Organization.

2) **Class B** consists of books or essays that are the result of ordinary scholarship, enlightened and earnest.

3) **Class C** consists of matter that is to be regarded rather as suggestive than anything else.

4) **Class D** consists of the official rituals and instructions.

Some publications are composite, and pertain to more than one class.<sup>8</sup>

The Thelemic rituals which are the subject of this book are Class D.

---

<sup>7</sup> For reasons that are not altogether clear, Crowley, after writing the *Syllabus*, created a fifth classification, Class E.

<sup>8</sup> See "A Syllabus of the official instructions of A.:A.:," *The Equinox*, Vol. I, No. 10.

# LIBER AL<sup>VEL</sup> LEGIS

SUB FIGURA

CCXX

AS DELIVERED BY

XCIH = 418

TO

DCLXVI

A.:A.: Publication in Class A.



1. Had! The manifestation of Nuit.
2. The unveiling of the company of heaven.
3. Every man and every woman is a star.
4. Every number is infinite; there is no difference.
5. Help me, o warrior lord of Thebes, in my unveiling before the Children of men!
6. Be thou Hadit, my secret centre, my heart & my tongue!
7. Behold! it is revealed by Aiwass the minister of Hoor-paar-kraat.
8. The Khabs is in the Khu, not the Khu in the Khabs.
9. Worship then the Khabs, and behold my light shed over you!
10. Let my servants be few & secret: they shall rule the many & the known.
11. These are fools that men adore; both their Gods & their men are fools.
12. Come forth, o children, under the stars, & take your fill of love!
13. I am above you and in you. My ecstasy is in yours. My joy is to see your joy.
14. Above, the gemmèd azure is  
    The naked splendour of Nuit;  
She bends in ecstasy to kiss  
    The secret ardours of Hadit.

The wingèd globe, the starry blue,  
Are mine, O Ankh-af-na-khonsu!

15. Now ye shall know that the chosen priest & apostle of infinite space is the prince-priest the Beast; and in his woman called the Scarlet Woman is all power given. They shall gather my children into their fold: they shall bring the glory of the stars into the hearts of men.

16. For he is ever a sun, and she a moon. But to him is the winged secret flame, and to her the stooping starlight.

17. But ye are not so chosen.

18. Burn upon their brows, o splendidous serpent!

19. O azure-lidded woman, bend upon them!

20. The key of the rituals is in the secret word which I have given unto him.

21. With the God & the Adorer I am nothing: they do not see me. They are as upon the earth; I am Heaven, and there is no other God than me, and my lord Hadit.

22. Now, therefore, I am known to ye by my name Nuit, and to him by a secret name which I will give him when at last he knoweth me. Since I am Infinite Space, and the Infinite Stars thereof, do ye also thus. Bind nothing! Let there be no difference made among you between any one thing & any other thing; for thereby there cometh hurt.

23. But whoso availeth in this, let him be the chief of all!

24. I am Nuit, and my word is six and fifty.

25. Divide, add, multiply, and understand.

26. Then saith the prophet and slave of the beauteous one: Who am I, and what shall be the sign? So she answered him, bending down, a lambent flame of blue, all-touching, all penetrant, her lovely hands upon the black earth, & her lithe body arched for love, and her soft feet not hurting the little flowers: Thou knowest! And the sign shall be my ecstasy, the consciousness of the continuity of existence, the omnipresence of my body.

27. Then the priest answered & said unto the Queen of Space, kissing her lovely brows, and the dew of her light bathing his whole body in a sweet-smelling perfume of sweat: O Nuit, continuous one of Heaven, let it be ever thus; that men speak not of Thee as One but as None; and let them speak not of thee at all, since thou art continuous!

28. None, breathed the light, faint & faery, of the stars, and two.

29. For I am divided for love's sake, for the chance of union.

30. This is the creation of the world, that the pain of division is as nothing, and the joy of dissolution all.

31. For these fools of men and their woes care not thou at all! They feel little; what is, is balanced by weak joys; but ye are my chosen ones.

32. Obey my prophet! follow out the ordeals of my knowledge! seek me only! Then the joys of my love will redeem ye from all pain. This is so: I swear it by the vault of my body; by my sacred heart and tongue; by all I can give, by all I desire of ye all.

33. Then the priest fell into a deep trance or swoon, & said unto the Queen of Heaven; Write unto us the ordeals; write unto us the rituals; write unto us the law!



34. But she said: the ordeals I write not: the rituals shall be half known and half concealed: the Law is for all.

35. This that thou writest is the threefold book of Law.

36. My scribe Ankh-af-na-khonsu, the priest of the princes, shall not in one letter change this book; but lest there be folly, he shall comment thereupon by the wisdom of Ra-Hoor-Khu-it.

37. Also the mantras and spells; the obeah and the wanga; the work of the wand and the work of the sword; these he shall learn and teach.

38. He must teach; but he may make severe the ordeals.

39. The word of the Law is  $\theta\epsilon\lambda\eta\mu\alpha$ .

40. Who calls us Thelemites will do no wrong, if he look but close into the word. For there are therein Three Grades, the Hermit, and the Lover, and the man of Earth. Do what thou wilt shall be the whole of the Law.

41. The word of Sin is Restriction. O man! refuse not thy wife, if she will! O lover, if thou wilt, depart! There is no bond that can unite the divided but love: all else is a curse. Accurséd! Accurséd! be it to the aeons! Hell.

42. Let it be that state of manyhood bound and loathing. So with thy all; thou hast no right but to do thy will.

43. Do that, and no other shall say nay.

44. For pure will, unassuaged of purpose, delivered from the lust of result, is every way perfect.

45. The Perfect and the Perfect are one Perfect and not two; nay, are none!

46. Nothing is a secret key of this law. Sixty-one the Jews call it; I call it eight, eighty, four hundred & eighteen.

47. But they have the half: unite by thine art so that all disappear.

48. My prophet is a fool with his one, one, one; are not they the Ox, and none by the Book?

49. Abrogate are all rituals, all ordeals, all words and signs. Ra-Hoor-Khuit hath taken his seat in the East at the Equinox of the Gods; and let Asar be with Isa, who also are one. But they are not of me. Let Asar be the adorant, Isa the sufferer; Hoor in his secret name and splendour is the Lord initiating.

50. There is a word to say about the Hierophantic task. Behold! There are three ordeals in one, and it may be given in three ways. The gross must pass through fire; let the fine be tried in intellect, and the lofty chosen ones in the highest. Thus ye have star & star, system & system; let not one know well the other!

51. There are four gates to one palace; the floor of that palace is of silver and gold; lapis lazuli & jasper are there; and all rare scents; jasmine & rose, and the emblems of death. Let him enter in turn or at once the four gates; let him stand on the floor of the palace. Will he not sink? Amn. Ho! warrior, if thy servant sink? But there are means and means. Be goodly therefore: dress ye all in fine apparel; eat rich foods and drink sweet wines and wines that foam! Also, take your fill and will of love as ye will, when, where and with whom ye will! But always unto me.

52. If this be not aright; if ye confound the space-marks, saying: They are one; or saying, They are many; if the ritual be not ever unto me: then expect the direful judgments of Ra Hoor Khuit!

53. This shall regenerate the world, the little world my sister, my heart & my tongue, unto whom I send this kiss. Also, o scribe and prophet, though thou be of the princes, it shall not assuage thee nor absolve thee. But ecstasy be thine and joy of earth: ever To me! To me!

54. Change not as much as the style of a letter; for behold! thou, o prophet, shalt not behold all these mysteries hidden therein.

55. The child of thy bowels, *he* shall behold them.

56. Expect him not from the East, nor from the West; for from no expected house cometh that child. Aum! All words are sacred and all prophets true; save only that they understand a little; solve the first half of the equation, leave the second unattacked. But thou hast all in the clear light, and some, though not all, in the dark.

57. Invoke me under my stars! Love is the law, love under will. Nor let the fools mistake love; for there are love and love. There is the dove, and there is the serpent. Choose ye well! He, my prophet, hath chosen, knowing the law of the fortress, and the great mystery of the House of God.

All these old letters of my Book are aright; but  $\Psi$  is not the Star. This also is secret: my prophet shall reveal it to the wise.

58. I give unimaginable joys on earth: certainty, not faith, while in life, upon death; peace unutterable, rest, ecstasy; nor do I demand aught in sacrifice.

59. My incense is of resinous woods & gums; and there is no blood therein: because of my hair the trees of Eternity.

60. My number is 11, as all their numbers who are of us. The Five Pointed Star, with a Circle in the Middle, & the circle is

Red. My colour is black to the blind, but the blue & gold are seen of the seeing. Also I have a secret glory for them that love me.

61. But to love me is better than all things: if under the night-stars in the desert thou presently burnest mine incense before me, invoking me with a pure heart, and the Serpent flame therein, thou shalt come a little to lie in my bosom. For one kiss wilt thou then be willing to give all; but whoso gives one particle of dust shall lose all in that hour. Ye shall gather goods and store of women and spices; ye shall wear rich jewels; ye shall exceed the nations of the earth in splendour & pride; but always in the love of me, and so shall ye come to my joy. I charge you earnestly to come before me in a single robe, and covered with a rich headdress. I love you! I yearn to you! Pale or purple, veiled or voluptuous, I who am all pleasure and purple, and drunkenness of the innermost sense, desire you. Put on the wings, and arouse the coiled splendour within you: come unto me!

62. At all my meetings with you shall the priestess say—and her eyes shall burn with desire as she stands bare and rejoicing in my secret temple—To me! To me! calling forth the flame of the hearts of all in her love-chant.

63. Sing the rapturous love-song unto me! Burn to me perfumes! Wear to me jewels! Drink to me, for I love you! I love you!

64. I am the blue-lidded daughter of Sunset; I am the naked brilliance of the voluptuous night-sky.

65. To me! To me!

66. The Manifestation of Nuit is at an end.

1. Nu! the hiding of Hadit.
2. Come! all ye, and learn the secret that hath not yet been revealed. I, Hadit, am the complement of Nu, my bride. I am not extended, and Khabs is the name of my House.
3. In the sphere I am everywhere the centre, as she, the circumference, is nowhere found.
4. Yet she shall be known & I never.
5. Behold! the rituals of the old time are black. Let the evil ones be cast away; let the good ones be purged by the prophet! Then shall this Knowledge go aright.
6. I am the flame that burns in every heart of man, and in the core of every star. I am Life, and the giver of Life, yet therefore is the knowledge of me the knowledge of death.
7. I am the Magician and the Exorcist. I am the axle of the wheel, and the cube in the circle. "Come unto me" is a foolish word: for it is I that go.
8. Who worshipped Heru-pa-kraath have worshipped me; ill, for I am the worshipper.
9. Remember all ye that existence is pure joy; that all the sorrows are but as shadows; they pass & are done; but there is that which remains.
10. O prophet! thou hast ill will to learn this writing.
11. I see thee hate the hand & the pen; but I am stronger.
12. Because of me in Thee which thou knewest not.

13. For why? Because thou wast the knower, and me.

14. Now let there be a veiling of this shrine: now let the light devour men and eat them up with blindness!

15. For I am perfect, being Not; and my number is nine by the fools; but with the just I am eight, and one in eight: Which is vital, for I am none indeed. The Empress and the King are not of me; for there is a further secret.

16. I am The Empress & the Hierophant. Thus eleven, as my bride is eleven.

17. Hear me, ye people of sighing!  
    The sorrows of pain and regret  
    Are left to the dead and the dying,  
    The folk that not know me as yet.

18. These are dead, these fellows; they feel not. We are not for the poor and sad: the lords of the earth are our kinsfolk.

19. Is a God to live in a dog? No! but the highest are of us. They shall rejoice, our chosen: who sorroweth is not of us.

20. Beauty and strength, leaping laughter and delicious languor, force and fire, are of us.

21. We have nothing with the outcast and the unfit: let them die in their misery. For they feel not. Compassion is the vice of kings: stamp down the wretched & the weak: this is the law of the strong: this is our law and the joy of the world. Think not, o king, upon that lie: That Thou Must Die: verily thou shalt not die, but live. Now let it be understood: If the body of the King dissolve, he shall remain in pure ecstasy for ever. Nuit! Hadit! Ra-Hoor-Khuit! The Sun, Strength & Sight, Light; these are for the servants of the Star & the Snake.

22. I am the Snake that giveth Knowledge & Delight and bright glory, and stir the hearts of men with drunkenness. To worship me take wine and strange drugs whereof I will tell my prophet, & be drunk thereof! They shall not harm ye at all. It is a lie, this folly against self. The exposure of innocence is a lie. Be strong, o man! lust, enjoy all things of sense and rapture: fear not that any God shall deny thee for this.

23. I am alone: there is no God where I am.

24. Behold! these be grave mysteries; for there are also of my friends who be hermits. Now think not to find them in the forest or on the mountain; but in beds of purple, caressed by magnificent beasts of women with large limbs, and fire and light in their eyes, and masses of flaming hair about them; there shall ye find them. Ye shall see them at rule, at victorious armies, at all the joy; and there shall be in them a joy a million times greater than this. Beware lest any force another, King against King! Love one another with burning hearts; on the low men trample in the fierce lust of your pride, in the day of your wrath.

25. Ye are against the people, O my chosen!

26. I am the secret Serpent coiled about to spring: in my coiling there is joy. If I lift up my head, I and my Nuit are one. If I droop down mine head, and shoot forth venom, then is rapture of the earth, and I and the earth are one.

27. There is great danger in me; for who doth not understand these runes shall make a great miss. He shall fall down into the pit called Because, and there he shall perish with the dogs of Reason.

28. Now a curse upon Because and his kin!

29. May Because be accurséd for ever!

30. If Will stops and cries Why, invoking Because, then Will stops & does nought.

31. If Power asks why, then is Power weakness.

32. Also reason is a lie; for there is a factor infinite & unknown; & all their words are skew-wise.

33. Enough of Because! Be he damned for a dog!

34. But ye, o my people, rise up & awake!

35. Let the rituals be rightly performed with joy & beauty!

36. There are rituals of the elements and feasts of the times.

37. A feast for the first night of the Prophet and his Bride!

38. A feast for the three days of the writing of the Book of the Law.

39. A feast for Tahuti and the child of the Prophet—secret, O Prophet!

40. A feast for the Supreme Ritual, and a feast for the Equinox of the Gods.

41. A feast for fire and a feast for water; a feast for life and a greater feast for death!

42. A feast every day in your hearts in the joy of my rapture!

43. A feast every night unto Nu, and the pleasure of uttermost delight!

44. Aye! feast! rejoice! there is no dread hereafter. There is the dissolution, and eternal ecstasy in the kisses of Nu.



45. There is death for the dogs.

46. Dost thou fail? Art thou sorry? Is fear in thine heart?

47. Where I am these are not.

48. Pity not the fallen! I never knew them. I am not for them. I console not: I hate the consoled & the consoler.

49. I am unique & conqueror. I am not of the slaves that perish. Be they damned & dead! Amen. (This is of the 4: there is a fifth who is invisible, & therein am I as a babe in an egg.)

50. Blue am I and gold in the light of my bride: but the red gleam is in my eyes; & my spangles are purple & green.

51. Purple beyond purple: it is the light higher than eyesight.

52. There is a veil: that veil is black. It is the veil of the modest woman; it is the veil of sorrow, & the pall of death: this is none of me. Tear down that lying spectre of the centuries: veil not your vices in virtuous words: these vices are my service; ye do well, & I will reward you here and hereafter.

53. Fear not, o prophet, when these words are said, thou shalt not be sorry. Thou art emphatically my chosen; and blessed are the eyes that thou shalt look upon with gladness. But I will hide thee in a mask of sorrow: they that see thee shall fear thou art fallen: but I lift thee up.

54. Nor shall they who cry aloud their folly that thou meanest nought avail; thou shall reveal it: thou avalest: they are the slaves of because: They are not of me. The stops as thou wilt; the letters? change them not in style or value!

55. Thou shalt obtain the order & value of the English Alphabet; thou shalt find new symbols to attribute them unto.

56. Begone! ye mockers; even though ye laugh in my honour ye shall laugh not long: then when ye are sad know that I have forsaken you.

57. He that is righteous shall be righteous still; he that is filthy shall be filthy still.

58. Yea! deem not of change: ye shall be as ye are, & not other. Therefore the kings of the earth shall be Kings for ever: the slaves shall serve. There is none that shall be cast down or lifted up: all is ever as it was. Yet there are masked ones my servants: it may be that yonder beggar is a King. A King may choose his garment as he will: there is no certain test: but a beggar cannot hide his poverty.

59. Beware therefore! Love all, lest perchance is a King concealed! Say you so? Fool! If he be a King, thou canst not hurt him.

60. Therefore strike hard & low, and to hell with them, master!

61. There is a light before thine eyes, o prophet, a light undesired, most desirable.

62. I am uplifted in thine heart; and the kisses of the stars rain hard upon thy body.

63. Thou art exhaust in the voluptuous fullness of the inspiration; the expiration is sweeter than death, more rapid and laughterful than a caress of Hell's own worm.

64. Oh! thou art overcome: we are upon thee; our delight is all over thee: hail! hail: prophet of Nu! prophet of Had! prophet of Ra-Hoor-Khu! Now rejoice! now come in our splendour & rapture! Come in our passionate peace, & write sweet words for the Kings!

65. I am the Master: thou art the Holy Chosen One.

66. Write, & find ecstasy in writing! Work, & be our bed in working! Thrill with the joy of life & death! Ah! thy death shall be lovely: whoso seeth it shall be glad. Thy death shall be the seal of the promise of our agelong love. Come! lift up thine heart & rejoice! We are one; we are none.

67. Hold! Hold! Bear up in thy rapture; fall not in swoon of the excellent kisses!

68. Harder! Hold up thyself! Lift thine head! breathe not so deep—die!

69. Ah! Ah! What do I feel? Is the word exhausted?

70. There is help & hope in other spells. Wisdom says: be strong! Then canst thou bear more joy. Be not animal; refine thy rapture! If thou drink, drink by the eight and ninety rules of art: if thou love, exceed by delicacy; and if thou do aught joyous, let there be subtlety therein!

71. But exceed! exceed!

72. Strive ever to more! and if thou art truly mine—and doubt it not, an if thou art ever joyous!—death is the crown of all.

73. Ah! Ah! Death! Death! thou shalt long for death. Death is forbidden, o man, unto thee.

74. The length of thy longing shall be the strength of its glory. He that lives long & desires death much is ever the King among the Kings.

75. Aye! listen to the numbers & the words:

76. 4 6 3 8 A B K 2 4 A L G M O R 3 Y X 2 4 8 9 R P S T O V A L.  
What meaneth this, o prophet? Thou knowest not; nor shalt thou know ever. There cometh one to follow thee: he shall expound it. But remember, o chosen one, to be me; to follow the love of Nu in the star-lit heaven; to look forth upon men, to tell them this glad word.

77. O be thou proud and mighty among men!

78. Lift up thyself! for there is none like unto thee among men or among Gods! Lift up thyself, o my prophet, thy stature shall surpass the stars. They shall worship thy name, foursquare, mystic, wonderful, the number of the man; and the name of thy house 418.

79. The end of the hiding of Hadit; and blessing & worship to the prophet of the lovely Star!



1. Abrahadabra! the reward of Ra Hoor Khut.
2. There is division hither homeward; there is a word not known. Spelling is defunct; all is not aught. Beware! Hold! Raise the spell of Ra-Hoor-Khuit!
3. Now let it be first understood that I am a god of War and of Vengeance. I shall deal hardly with them.
4. Choose ye an island!
5. Fortify it!
6. Dung it about with enginery of war!
7. I will give you a war-engine.

8. With it ye shall smite the peoples; and none shall stand before you.

9. Lurk! Withdraw! Upon them! this is the Law of the Battle of Conquest: thus shall my worship be about my secret house.

10. Get the stéle of revealing itself; set it in thy secret temple—and that temple is already aright disposed—& it shall be your Kiblah for ever. It shall not fade, but miraculous colour shall come back to it day after day. Close it in locked glass for a proof to the world.

11. This shall be your only proof. I forbid argument. Conquer! That is enough. I will make easy to you the abstruc-tion from the ill-ordered house in the Victorious City. Thou shalt thyself convey it with worship, o prophet, though thou likest it not. Thou shalt have danger & trouble. Ra-Hoor-Khu is with thee. Worship me with fire & blood; worship me with swords & with spears. Let the woman be girt with a sword before me: let blood flow to my name. Trample down the Heathen; be upon them, o warrior, I will give you of their flesh to eat!

12. Sacrifice cattle, little and big: after a child,

13. But not now.

14. Ye shall see that hour, o blessèd Beast, and thou the Scarlet Concubine of his desire!

15. Ye shall be sad thereof.

16. Deem not too eagerly to catch the promises; fear not to undergo the curses. Ye, even ye, know not this meaning all.

17. Fear not at all; fear neither men nor Fates, nor gods, nor anything. Money fear not, nor laughter of the folk folly, nor

any other power in heaven or upon the earth or under the earth. Nu is your refuge as Hadit your light; and I am the strength, force, vigour, of your arms.

18. Mercy let be off: damn them who pity! Kill and torture; spare not; be upon them!

19. That stélé they shall call the Abomination of Desolation; count well its name, & it shall be to you as 718.

20. Why? Because of the fall of Because, that he is not there again.

21. Set up my image in the East: thou shalt buy thee an image which I will show thee, especial, not unlike the one thou knowest. And it shall be suddenly easy for thee to do this.

22. The other images group around me to support me: let all be worshipped, for they shall cluster to exalt me. I am the visible object of worship; the others are secret; for the Beast & his Bride are they: and for the winners of the Ordeal x. What is this? Thou shalt know.

23. For perfume mix meal & honey & thick leavings of red wine: then oil of Abramelin and olive oil, and afterward soften & smooth down with rich fresh blood.

24. The best blood is of the moon, monthly: then the fresh blood of a child, or dropping from the host of heaven: then of enemies; then of the priest or of the worshippers: last of some beast, no matter what.

25. This burn: of this make cakes & eat unto me. This hath also another use; let it be laid before me, and kept thick with perfumes of your orison: it shall become full of beetles as it were and creeping things sacred unto me.

26. These slay, naming your enemies; & they shall fall before you.

27. Also these shall breed lust & power of lust in you at the eating thereof.

28. Also ye shall be strong in war.

29. Moreover, be they long kept, it is better; for they swell with my force. All before me.

30. My altar is of open brass work: burn thereon in silver or gold!

31. There cometh a rich man from the West who shall pour his gold upon thee.

32. From gold forge steel!

33. Be ready to fly or to smite!

34. But your holy place shall be untouched throughout the centuries: though with fire and sword it be burnt down & shattered, yet an invisible house there standeth, and shall stand until the fall of the Great Equinox; when Hrumachis shall arise and the double-wanded one assume my throne and place. Another prophet shall arise, and bring fresh fever from the skies; another woman shall awake the lust & worship of the Snake; another soul of God and beast shall mingle in the globèd priest; another sacrifice shall stain the tomb; another king shall reign; and blessing no longer be poured To the Hawk-headed mystical Lord!

35. The half of the word of Heru-ra-ha, called Hoor-pa-kraat and Ra-Hoor-Khut.

36. Then said the prophet unto the God:

37. I adore thee in the song—

I am the Lord of Thebes, and I  
The inspired forth-speaker of Mentu;  
For me unveils the veiled sky,  
The self-slain Ankh-af-na-khonsu  
Whose words are truth. I invoke, I greet  
Thy presence, O Ra-Hoor-Khuit!

Unity uttermost showed!  
I adore the might of Thy breath,  
Supreme and terrible God,  
Who makest the gods and death  
To tremble before Thee:—  
I, I adore thee!

Appear on the throne of Ra!  
Open the ways of the Khu!

Lighten the ways of the Ka!  
The ways of the Khabs run through  
To stir me or still me!  
Aum! let it fill me!

38. So that thy light is in me; & its red flame is as a sword in my hand to push thy order. There is a secret door that I shall make to establish thy way in all the quarters, (these are the adorations, as thou hast written), as it is said:

The light is mine; its rays consume  
Me: I have made a secret door  
Into the House of Ra and Tum,  
Of Kephra and of Ahathoor.  
I am thy Theban, O Mentu,  
The prophet Ankh-af-na-khonsu!

By Bes-na-Maut my breast I beat;  
By wise Ta-Nech I weave my spell.



Show thy star-splendour, O Nuit!  
Bid me within thine House to dwell,  
O wingèd snake of light, Hadit!  
Abide with me, Ra-Hoor-Khuit!

39. All this and a book to say how thou didst come hither and a reproduction of this ink and paper for ever—for in it is the word secret & not only in the English—and thy comment upon this the Book of the Law shall be printed beautifully in red ink and black upon beautiful paper made by hand; and to each man and woman that thou meetest, were it but to dine or to drink at them, it is the Law to give. Then they shall chance to abide in this bliss or no; it is no odds. Do this quickly!

40. But the work of the comment? That is easy; and Hadit burning in thy heart shall make swift and secure thy pen.

41. Establish at thy Kaaba a clerk-house: all must be done well and with business way.

42. The ordeals thou shalt oversee thyself, save only the blind ones. Refuse none, but thou shalt know & destroy the traitors. I am Ra-Hoor-Khuit; and I am powerful to protect my servant. Success is thy proof: argue not; convert not; talk not over much! Them that seek to entrap thee, to overthrow thee, them attack without pity or quarter; & destroy them utterly. Swift as a trodden serpent turn and strike! Be thou yet deadlier than he! Drag down their souls to awful torment: laugh at their fear: spit upon them!

43. Let the Scarlet Woman beware! If pity and compassion and tenderness visit her heart; if she leave my work to toy with old sweetnesses; then shall my vengeance be known. I will slay me her child: I will alienate her heart: I will cast her out from men: as a shrinking and despised harlot shall she crawl through dusk wet streets, and die cold and an-hungred.

44. But let her raise herself in pride! Let her follow me in my way! Let her work the work of wickedness! Let her kill her heart! Let her be loud and adulterous! Let her be covered with jewels, and rich garments, and let her be shameless before all men!

45. Then will I lift her to pinnacles of power: then will I breed from her a child mightier than all the kings of the earth. I will fill her with joy: with my force shall she see & strike at the worship of Nu: she shall achieve Hadit.

46. I am the warrior Lord of the Forties: the Eighties cower before me, & are abased. I will bring you to victory & joy: I will be at your arms in battle & ye shall delight to slay. Success is your proof; courage is your armour; go on, go on, in my strength; & ye shall turn not back for any!

47. This book shall be translated into all tongues: but always with the original in the writing of the Beast; for in the chance shape of the letters and their position to one another: in these are mysteries that no Beast shall divine. Let him not seek to try: but one cometh after him, whence I say not, who shall discover the Key of it all. Then this line drawn is a key: then this circle squared in its failure is a key also. And Abrahadabra. It shall be his child & that strangely. Let him not seek after this; for thereby alone can he fall from it.

48. Now this mystery of the letters is done, and I want to go on to the holier place.

49. I am in a secret fourfold word, the blasphemy against all gods of men.

50. Curse them! Curse them! Curse them!

51. With my Hawk's head I peck at the eyes of Jesus as he hangs upon the cross.

52. I flap my wings in the face of Mohammed & blind him.
53. With my claws I tear out the flesh of the Indian and the Buddhist, Mongol and Din.
54. Bahlasti! Ompehda! I spit on your crapulous creeds.
55. Let Mary inviolate be torn upon wheels: for her sake let all chaste women be utterly despised among you!
56. Also for beauty's sake and love's!
57. Despise also all cowards; professional soldiers who dare not fight, but play; all fools despise!
58. But the keen and the proud, the royal and the lofty; ye are brothers!
59. As brothers fight ye!
60. There is no law beyond Do what thou wilt.
61. There is an end of the word of the God enthroned in Ra's seat, lightening the girders of the soul.
62. To Me do ye reverence! to me come ye through tribulation of ordeal, which is bliss.
63. The fool readeth this Book of the Law, and its comment; & he understandeth it not.
64. Let him come through the first ordeal, & it will be to him as silver.
65. Through the second, gold.
66. Through the third, stones of precious water.

67. Through the fourth, ultimate sparks of the intimate fire.
68. Yet to all it shall seem beautiful. Its enemies who say not so, are mere liars.
69. There is success.
70. I am the Hawk-Headed Lord of Silence & of Strength; my nemyss shrouds the night-blue sky.
71. Hail! ye twin warriors about the pillars of the world! for your time is nigh at hand.
72. I am the Lord of the Double Wand of Power; the wand of the Force of Coph Nia—but my left hand is empty, for I have crushed an Universe; & nought remains.
73. Paste the sheets from right to left and from top to bottom: then behold!
74. There is a splendour in my name hidden and glorious, as the sun of midnight is ever the son.
75. The ending of the words is the Word Abrahadabra.

The Book of the Law is Written  
and Concealed.  
Aum. Ha.

## THE COMMENT

Do what thou wilt shall be the whole of the Law.

The study of the Book is forbidden. It is wise to destroy this copy after the first reading.

Whosoever disregards this does so at his own risk and peril.  
These are most dire.

Those who discuss the contents of this Book are to be shunned by all, as centres of pestilence.

All questions of the Law are to be decided only by appeal to my writings, each for himself.

There is no law beyond Do what thou wilt.

Love is the law, love under will.

The priest of the princes  
Ankh-f-n-khonsu

A PARAPHRASE OF THE INSCRIPTIONS UPON  
THE OBVERSE OF THE STÉLÉ OF REVEALING

Above, the gemmèd azure is  
The naked splendour of Nuit ;  
She bends in ecstasy to kiss  
The secret ardours of Hadit.  
The wingèd globe, the starry blue  
Are mine, o Ankh-f-n-Khonsu.

I am the Lord of Thebes, and I  
The inspired forth-speaker of Mentu ;  
For me unveils the veiled sky,  
The self-slain Ankh-f-n-Khonsu  
Whose words are truth. I invoke, I greet  
Thy presence, o Ra-Hoor-Khuit !

Unity uttermost showed !  
I adore the might of Thy breath,  
Supreme and terrible God,  
Who makest the gods and death  
To tremble before Thee :—  
I, I adore thee !

Appear on the throne of Ra !  
Open the ways of the Khu !  
Lighten the ways of the Ka !  
The ways of the Khabs run through  
To stir me or still me !  
Aum ! let it kill me !

The Light is mine ; its rays consume  
Me : I have made a secret door  
Into the House of Ra and Tum,  
Of Khephra, and of Ahathoor.  
I am thy Theban, o Mentu,  
The prophet Ankh-f-n-Khonsu !

By Bes-na-Maut my breast I beat ;  
By wise Ta-Nech I weave my spell.  
Show thy star-splendour, O Nuith !  
Bid me within thine House to dwell,  
O wingèd snake of light, Hadith !  
Abide with me, Ra-Hoor-Khuit !



Handwritten text in a stylized, possibly cursive or shorthand script, arranged in 12 horizontal lines within a rounded rectangular frame. The characters are dark and set against a light background with horizontal red lines separating the lines of text.



A PARAPHRASE OF THE HIEROGLYPHS OF THE  
11 LINES UPON THE REVERSE OF THE STELE

Saith of Mentu the truth-telling brother  
Who was master of Thebes from his birth :  
O heart of me, heart of my mother !  
O heart which I had upon earth !  
Stand not thou up against me a witness !  
Oppose me not, judge, in my quest !  
Accuse me not now of unfitness  
Before the Great God, the dread Lord of the West !  
For I fastened the one to the other  
With a spell for their mystical girth,  
The earth and the wonderful West,  
When I flourished, o earth, on thy breast !

The dead man Ankh-f-n-Khonsu  
Saith with his voice of truth and calm :  
O thou that hast a single arm !  
O thou that glitterest in the moon !  
I weave thee in the spinning charm ;  
I lure thee with the billowy tune.

The dead man Ankh-f-n-Khonsu  
Hath parted from the darkling crowds,  
Hath joined the dwellers of the light,  
Opening Duant, the star-abodes,  
Their keys receiving.  
The dead man Ankh-f-n-Khonsu  
Hath made his passage into night,  
His pleasure on the earth to do  
Among the living.

## CHAPTER FOUR

---

# THE PENTAGRAM RITUALS

*...Equilibrium is the basis of the Work. If thou thyself hast not a sure foundation, whereon wilt thou stand to direct the forces of Nature?*

*...Establish thyself firmly in the equilibrium of forces, in the centre of the Cross of the Elements, that Cross from whose centre the Creative Word issued in the birth of the dawning Universe.*

*Be thou therefore prompt and active as the Sylphs, but avoid frivolity and caprice; be energetic and strong like the Salamanders, but avoid irritability and ferocity; be flexible and attentive to images like the Undines, but avoid idleness and changeability; be laborious and patient like the Gnomes, but avoid grossness and avarice.*

*So shalt thou gradually develop the powers of thy soul, and fit thyself to command the Spirits of the elements, For wert thou to summon the Gnomes to pander to thine avarice, thou wouldst no longer command them, but they would command thee. Wouldst thou abuse the pure beings of the woods and mountains to fill thy coffers and satisfy thy hunger of Gold? Wouldst thou debase the Spirits of Living Fire to serve thy wrath and hatred?*

*Wouldst thou violate the purity of the Souls of the Waters to pander to thy lust of debauchery? Whouldst thou force the Spirits of the Evening Breeze to minister to thy folly and caprice? Know that with such desires thou canst but attract the Weak, not the Strong, and in that case the Weak will have power over thee.*

### Liber Librae

The first task of the Magician is to master his or her immediate environment. "If thou thyself hast not a sure foundation, whereon wilt thou stand to direct the forces of Nature?"<sup>1</sup> On the mundane plane this means the ability to provide materially for yourself (and your family if that is your situation) in such a manner as to allow you to also pursue your spiritual disciplines. This is no mean task, and I doff my magical cap to anyone who can achieve such a lifestyle.

Our immediate environment is the phenomenal universe, the microcosm, the "little universe," of which the elemental world forms the foundation. The key to the mastery of this world is the Pentagram.

Obviously the "magical" elements are not those that appear on the periodic table of elements of modern chemistry (although they could be called the building blocks of matter). Neither are they fire, water, air, and earth as is commonly understood (although their fundamental natures are manifested perfectly in their literal counterparts).

Perhaps the simplest way for us to understand the elements is to think of them as the sum of all energies, powers, and properties of the universe categorized by characteristics into four general classes: Fire, Water, Air, and Earth.

For example, if a modern physicist were to use the picturesque language of the ancients to describe the four

---

<sup>1</sup> Aleister Crowley, *The Equinox*, Vol. I, No. 1 (London: 1909; reprinted York Beach, ME: Samuel Weiser, 1992), p. 17.

fundamental forces of nature, he might say the strong force is Fire, the electromagnetic force is Water, the weak force is Air, and the gravitational force is Earth. Or the chemist might classify nitrogen, hydrogen, oxygen, and carbon in the same order because of the characteristics these elements exhibit.

The Qabalist (and consequently the Magician) sees the elements as reflections of the four qabalistic worlds<sup>2</sup> and the four letters of the Tetragrammaton IHVH, (יחיה)—Yod, the Father-Fire; Heh, the Mother-Water; Vau, the Son-Air; and Heh (final), the Daughter-Earth. These in turn are represented in the tarot as the four suits: Wands-Fire, Cups-Water, Swords-Air, and Disks-Earth.

The reader may be asking at this point why the Pentagram, a *five* pointed figure, would be the key to the mastery of the *four* Elements. The answer lies in the dual operation performed by a “quintessential” fifth element. This element is simultaneously responsible for 1) binding the other elements together to form the infinite variety of the universe, and 2) keeping them separated enough to maintain their essential individual characteristics (see figure 1, p. 54). This fifth element is known in Western Hermeticism as Spirit, and the Qabalists represent it by the letter Shin (שׁ). When inserted in the ineffable name IHVH (Jehovah) it becomes IShVH (Jeheshua). We will later see how this dual nature of Spirit manifests as two types of Pentagram, active and passive.

The perpetual combination and recombination of these elements is the very process of “creation.” From the very beginning of the Magician’s career, he or she must consciously take part in this divine juggling<sup>3</sup> act and endeavor to correct any elemental imbalance in his or her life. This is not easy; but without this fundamental balance, we can never

<sup>2</sup> Atziluth, the archetypal world of pure Deity; Briah, the creative-archangelic world; Yetzirah, the formative-angelic world; and Assiah, the elemental world of substance.

<sup>3</sup> In many tarot decks The Magician card is called The Juggler.

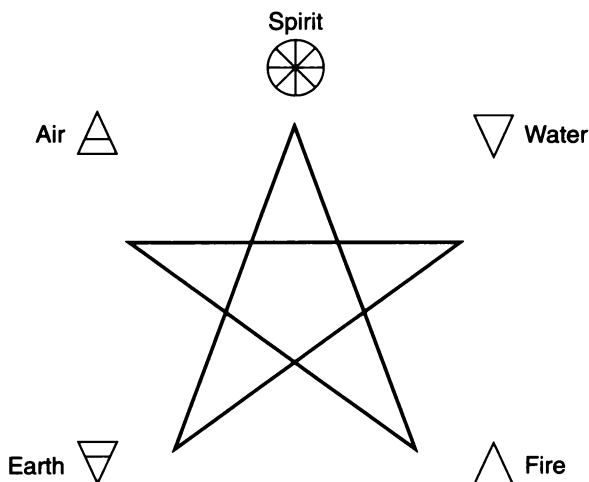

Figure 1. *The Pentagram.*

hope to successfully conquer what lies beyond the world of the elements.

To reconcile the magical formulae of the classic Pentagram rituals with those of the Aeon of Horus, Crowley designed two rituals: *Liber XXV*,<sup>4</sup> *The Star Ruby* and *Liber V vel Reguli*. Both ceremonies are short and simple in construction, and can be memorized and performed almost immediately. The beginning student, however, is encouraged to be intimately familiar with the *traditional* Pentagram rituals before exclusively adopting these two ceremonies as his or her own. The reasons should be obvious.

1) Like every Thelemic Ritual we will discuss, the components of the *Star Ruby* and *Reguli* (God names, gestures, words, signs, etc.) conform to the formulae of the new aeon. These, as we have discussed above, evolved from the formulae of the previous aeons. If the Magician does not have a basic grasp of the old formulae there is little chance he or she will understand the subtleties of the new.

<sup>4</sup> 25 being the square of 5.

2) To successfully invoke or banish the various elements, the Magician needs to know how to correctly “draw” twelve different Pentagrams: one each to banish and invoke each of the four elements, and one each to banish and invoke each of the two varieties (active and passive) of Spirit (see figure 2). To be prepared to wield the power of the Pentagram in the rituals of the *Star Ruby* and *Reguli*, it is absolutely necessary that the Magician have a total and unambiguous mastery and understanding of these twelve diagrams.

As you can see, a simple rule of thumb is invoke *toward* and banish *away* from the element in question.

For practical workings these Pentagrams must not only be memorized but imprinted firmly upon the unconscious mind. It is not an exaggeration to warn that you must be able to draw the appropriate Pentagrams in your sleep—for once you have seriously embarked upon magical practices, you may be called upon to do just that.

Those familiar with the tarot will recall that, in traditional decks, the four Kerubic Beasts of Ezekiel are placed in exactly the same positions in the corners of The Wheel of Fortune and the World cards. The Lion (Leo-Fire) in the lower

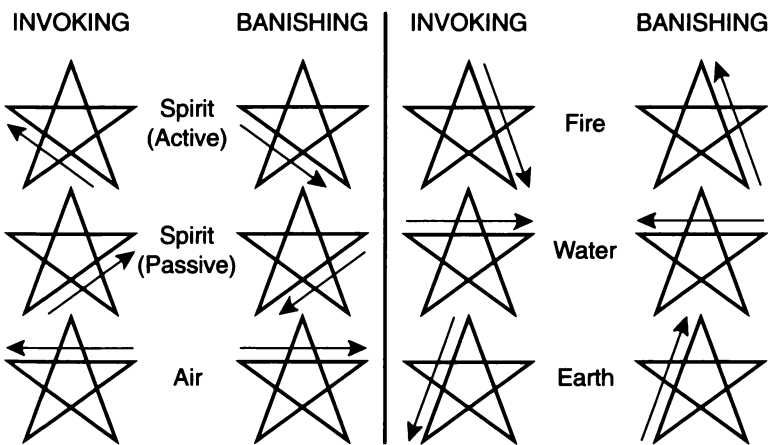

Figure 2. Invoking and Banishing Pentagrams.

right-hand corner, the Eagle (Scorpio-Water) in the upper right-hand corner, the Man (Aquarius-Air) in the upper left-hand corner, and the Bull (Taurus-Earth) in the lower left-hand corner. When first studying the Pentagram it is helpful to visually create the Wheel of Fortune card in the mind's eye, and simply "draw" the appropriate star upon it, rather than trying to memorize all the varieties of Pentagram.

In the *Star Ruby*, Crowley assumes that the Magician has mastered all the Pentagrams so thoroughly that he or she can simply create a Pentagram "...aright in thy forehead" and hurl it toward the appropriate quarter. It is only reasonable to conclude that if you aren't truly the master of the Pentagram, the star you hurl forth from your forehead will be anemic and ineffectual. To prepare for such command of the elements it is necessary to memorize and perfect the two fundamental rituals from which the *Star Ruby* and *Reguli* are derived; the Lesser Ritual of the Pentagram, and the Greater Ritual of the Pentagram. The magical education these two ceremonies provide is the key to the power of the Thelemic rituals which follow.

## THE LESSER RITUAL OF THE PENTAGRAM

Crowley had great respect for the simple Pentagram ritual. In a footnote to *Palace of the World*,<sup>5</sup> he wrote the following:

Those who regard this ritual as a mere device to invoke or banish spirits, are unworthy to possess it. Properly understood, it is the Medicine of Metals and the Stone of the Wise.

The Lesser Ritual of the Pentagram should proceed any magical working or divinatory exercise. It is the magical

---

<sup>5</sup> See *The Works of Aleister Crowley, The Temple of the Holy Ghost, Vol I.* (Homewood, IL: Yoga Publishing, 1978), p. 204.

equivalent of cleaning, vacuuming, and dusting the temple before operating. Only one type of Pentagram is used (Banishing Earth), and the ceremony is very brief. It provides, perhaps for the first time, the opportunity for the Magician to create a magical environment.

This simple ritual is useful in many other ways as well. It grounds the Magician and establishes a protective circle of operation. If done regularly the Magician will develop his or her powers of visualization and concentration by drawing the Pentagrams and invoking the archangelic guardians.

Note: The direction in which the Magician moves in a ritual is very important. The basic rule of thumb is: move with the Sun (clockwise) to invoke, move against the Sun (counter-clockwise) to banish. Clockwise is referred to as *deosil*, and counter-clockwise is called *widdershins*. Although the above formula is never abrogated, there are many rituals which appear, at first glance, to ignore the rules. Even the simple Lesser Banishing Ritual of the Pentagram instructs the Magician to move *deosil* around the circle. A little meditation upon this seeming contradiction will reveal to the student that the four quarters are properly banished by drawing the Banishing Earth Pentagrams, but the circle remains sealed and guarded by the four archangels who are invoked into their places by the *deosil* movement of the Magician.

In more complex rituals, the logic behind the dictated direction of movement will be harder to fathom, but it is very important for each Magician to reason out to his or her satisfaction the "method" behind the "madness."



# THE LESSER RITUAL OF THE PENTAGRAM<sup>6</sup>

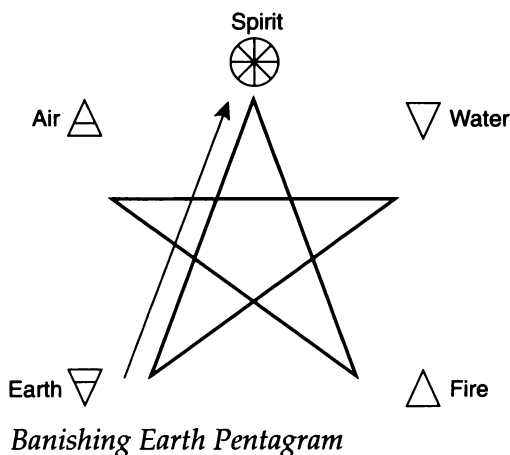

1. Touching the forehead say **Ateh** ( Unto Thee).
2. Touching the breast say **Malkuth** ( The Kingdom).
3. Touching the right shoulder, say **ve-Geburah** (and the Power).
4. Touching the left shoulder, say **ve-Gedulah** (and the Glory).
5. Clasping the hand upon the breast, say **le-OLAHM, AMEN**, (To the Ages, Amen).<sup>7</sup>

<sup>6</sup> From Crowley's *Liber O*, part IV, in *Magick in Theory and Practice* (New York: Magickal Childe, 1990), p. 379.

<sup>7</sup> 1-5 is referred to as the Qabalistic Cross. The Magician actually indicates the three pillars of the Tree of Life upon his or her body. This affirms the Magician's identity as a microcosmic representation of God and announces that fact to the world.—*Ed.*

6. Turning to the East, make a pentagram (that of Earth) with the proper weapon (usually the Wand). Say (i.e., vibrate) **IHVH** (Ye-ho-wau).

7. Turning to the South, the same, but say **ADNI** (Adonai).

8. Turning to the West, the same, but say **AHIH** (Eheieh).

9. Turning to the North, the same, but say **AGLA** (Aglā).

10. Extend the arms in the form of a cross say (see Sign of Osiris Slain in figure 3 on page 62),

11. **Before me Raphael;**

12. **Behind me Gabriel;**

13. **On my right hand, Michael.**

14. **On my left hand, Auriel;**<sup>8</sup>

15. **For about me flames the Pentagram,**

---

<sup>8</sup> 6-14 the Divine Names are taken from traditional qabalistic sources; IHVH, the Tetragrammaton; ADNI, often translated "Lord," used as a synonym for the Holy Guardian Angel; AHIH, "I Am." AGLA is a notariqon of "Ateh Gibor Le-Olahm Adonai" (Thou art mighty forever my Lord). These names govern their respective Archangels; Raphael (God has healed); Gabriel (God is my strength); Michael (who is as God); and Auriel (light of God). These Archangels, in turn, rule a host of Angels and lesser spiritual entities of the Elements.—*Ed.*

**16. And in the Column stands the six-rayed Star.<sup>9</sup>**

17-21. Repeat the Qabalistic Cross (1 to 5)

**VIBRATION OF THE DIVINE NAMES**

Once the Lesser Banishing ritual of the Pentagram has been committed to memory the Magician should then learn to “vibrate” the Divine Names in the quarters rather than simply say them. Crowley gave detailed instructions in Part III of *Liber O* from which we quote:

- a) Stand with arms outstretched.<sup>10</sup>
- b) Breathe in deeply through the nostrils, imagining the name of the God desired entering with the breath.
- c) Let that name descend slowly from the lungs to the heart, the solar plexus, the navel, the generative organs, and so to the feet.
- d) The moment that it appears to touch the feet, quickly advance the left foot about 12 inches, throw forward the body, and let the hands (drawn back

---

<sup>9</sup> The Hexagram. “It flames both above and beneath the magus, who is thus in a cube of 4 pentagrams and 2 hexagrams, 32 points in all.”—Crowley, *The Palace of the World*.

By creating the four pentagrams at the quarters and positioning the four archangels to stand as guardians, the Magician has sealed the circle, and created a new magical environment. The microcosm (the “little” world of Five) is now held at bay outside and beyond. A vacuum is formed within the circle (which has become a column extending infinitely above and below). As Magick and Nature abhor vacuums, this environment is immediately filled by the inrush of the macrocosm (the “big” world of Six, represented by the hexagram). It is from this superior position the Magician sets to work.—*Ed.*

<sup>10</sup> This injunction does not apply to gods like Phthah or Harpocrates whose natures do not accord with this gesture.



Mourning of Isis (6)



Osiris Risen (x)



Apophis-Typhon (v)



Osiris Slain

Figure 3a. L. V. X. Signs.



Puer (N)

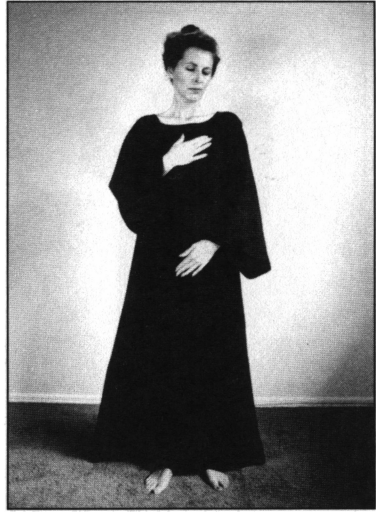

Puella



Mulier (X)

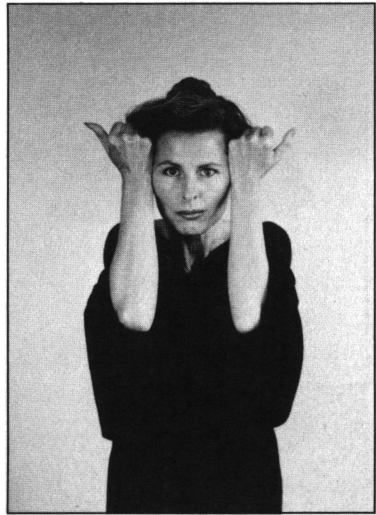

Vir (O)

Figure 3b. N. O. X. Signs.



4° = 7<sup>o</sup> (fire)  
Thoum-aesh-neith



3° = 8<sup>o</sup> (water)  
Auromoth



2° = 9<sup>o</sup> (air)  
Shu



1° = 10<sup>o</sup> (earth)  
Set

Figure 3c. Signs of the Grades.



Rending of the Veil  
(Spirit-active)

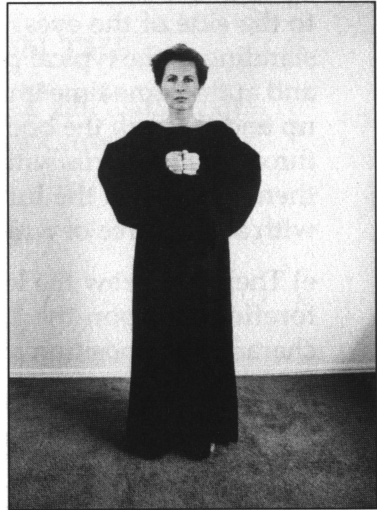

Closing of the Veil  
(Spirit-passive)



Sign of Horas  
(the Enterer)



Mater Triumphans  
(Set Triumphant)

Figure 3d. Signs of the Grades (continued).

to the side of the eyes) shoot out, so that you are standing in the typical position of the God Horus<sup>11</sup>, and at the same time imagine the Name as rushing up and through the body, while you breathe it out through the nostrils with the air which has been till then retained in the lungs. All this must be done with all the force of which you are capable.

e) Then withdraw the left foot, and place the right forefinger<sup>12</sup> upon the lips, so that you are in the characteristic position of the God Harpocrates.

f) It is a sign that the student is performing this correctly when a single "Vibration" entirely exhausts his physical strength. It should cause him to grow hot all over or to perspire violently, and it should so weaken him that he will find it difficult to remain standing.

It is a sign of success, though only by the student himself is it perceived, when he hears the name of God vehemently roared forth, as if by the concourse of ten thousand thunders; and it should appear to him as if that Great Voice proceeded from the Universe, and not from himself.

---

<sup>11</sup> This gesture is the "Sign of Horus" or the "Sign of the Enterer."—Ed.

<sup>12</sup> Or the thumb, the fingers being closed. The thumb symbolizes spirit, the forefinger the element of water. (Editor's note: the "Sign of Harpocrates" also called the "Sign of Silence.")



# NOTES ON THE RITUAL OF THE PENTAGRAM

by Aleister Crowley

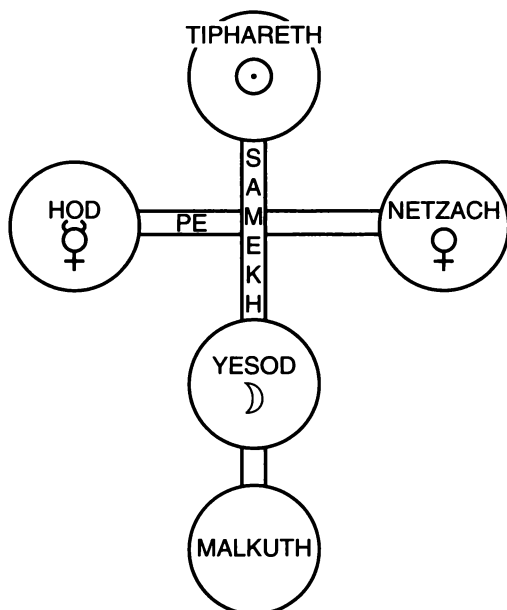

You are supposed to be standing at the intersection of the paths of Samekh and Pé. You are facing Tiphareth (the Sun), thus on your right hand is Netzach (Venus) on your left hand Hod (Mercury), and behind you Yesod (the Moon).

You take one step with the right heel in the hollow of the left foot towards Tiphareth and vibrate the Divine Name as given in the ritual. You then carry round the point of the Wand towards Netzach, then take a step again (always recovering after each for-

ward step so that you remain in the centre) and vibrating the Divine Name as before.

Continue the process facing Yesod and vibrating; then Hod, and vibrating; but carry the point of the Wand round to Tiphareth so as to complete the circle.

As you vibrate the Divine Name the angels, as given in the ritual, appear, (note well that they should appear and if the ritual is properly performed do appear).

You are thus standing in a Column which is protected by your microcosmic invocation. The consequent result, being macrocosmic response, is that without any effort on your part the hexagram or sixfold star appears both above and below you. (Note the equilibration  $5 = 6$ .)

In this way you are completely shut off from the outer and Qliphotic parts of the universe.

Get well into your mind the realization of this Column with its surrounding pentagrams and its hexagrams above and below you. Continuous practice is essential if you are to perform this ritual as you should.

It is particularly important not to slur any part of it; to visualize clearly and cleanly the forces invoked, with the exception of the Divine Being, who will not appear, in the ordinary course of events, for such slight cause.

You can figure out for yourself the forms of the angels, or rather archangels. For instance, Raphael commencing with an "R" will have a head of solar glory and the Pé which follows shows that the rest of him is martial: the "A" which concludes the

name (in the case of most angelic beings) indicates that they wield the sword and the balance.



Once the Lesser Ritual of the Pentagram and the vibrations of the God Names have been perfected the student should then master all the variations<sup>13</sup> of the Greater Ritual of the Pentagram. Unlike the Lesser Pentagram Ritual which provides a simple cleansing and centering function, this ceremony taps a far deeper strata of the elemental world and is the key to the opening and closing of what is known as the Elemental Watchtowers of the Universe. The basic formula embodied in the Greater Ritual also provides the fundamental knowledge necessary for the practice of other branches of the art, including Enochian Magick and Goetia.

The version appearing below is the simplest format constructed from the information outlined in Crowley's *Liber O*. More elaborate versions utilizing additional material such as Enochian words and the Kerubic symbols of the zodiac can be found in numerous other texts, but we feel the student would be best served by mastering the essentials first.

The first thing one notices about the Greater Pentagram Ritual is its similarity to the Lesser Ritual. It opens with the same Qabalistic Cross and ends with the same invocation of the Archangels. But here the similarity ends.

Each quarter is ruled by a different element (East-Air, South-Fire, West-Water, and North Earth<sup>14</sup>) and each is activated by two Pentagrams.

The first is a Spirit Pentagram [an active Pentagram in the quarters of the active elements of Air (East) and Fire

---

<sup>13</sup> With the Greater Pentagram Ritual, it is possible to Invoke or Banish any of the five elements by the correct use of the appropriate pentagrams.

<sup>14</sup> These are the traditional microcosmic attributions determined by the terrestrial winds.

(South); and a passive Pentagram in the quarters of the passive elements of Water (West) and Earth (North)]. By correctly creating this Pentagram, the Magician unlocks the door to the elemental universe and announces to the spiritual inhabitants of each quarter his or her authority to command them.

The second is the elemental Pentagram of the quarter (Air in the East, Fire in the South, Water in the West, and Earth in the North). By correctly creating this Pentagram, the Magician exercises that authority to either invoke or banish the elemental spirits of the quarter.

After each of these Pentagrams is "drawn," the Magician then symbolically proclaims his or her dominion of the quarter by making the proper sign or gesture appropriate to the element in question. These gestures (which are described in the text of the ritual) are the characteristic Signs of the Grades of the original Golden Dawn Degree structure (see figure 3 on page 62):

(The Grade of the Portal, is particularly attributed to the element of Spirit; it refers to the Sun; the paths of Samech, Resh and Tzaddi are attributed to this Degree. See "777" lines 6 and 31 bis).

(The Grade of  $4^\circ = 7^\square$  is particularly attributed to the element Fire; it refers to the Planet Venus; the paths of Qoph, Ayin and Pé are attributed to this degree. For other attributions see "777" lines 7 and 31).

(The Grade of  $3^\circ = 8^\square$  is particularly attributed to the element of water; it refers to the planet Mercury; the paths of Resh and Shin are attributed to this degree. For other attributions see "777" lines 8 and 23).

(The Grade of  $2^\circ = 9^\square$  is particularly attributed to the element Air; it refers to the Moon, the path of Tau is attributed to this degree For other attributions see "777" lines 9 and 11).

(The Grade of 1° = 10<sup>□</sup> is particularly attributed to the element of Earth. See “777” lines 10 and 32 Bis).<sup>15</sup>

It is important to always remember that, on the magical plane, symbols are living things, and living things are symbols. Therefore it is essential that the signs be made properly and with the full intent of the Magician of transforming his or her body into a living symbol. In the Greater Ritual of the Pentagram, these signs are indicative of the elements, but in more advanced rituals they can represent even greater and more profound concepts.

The version which follows is formatted for a general invocation of each element in its appropriate quarter. A comparable banishing ceremony is accomplished by following the same procedure but utilizing Banishing Pentagrams. Even though a great deal of elemental energy is generated by this ritual, it is done safely because the active and passive nature of the elements and their position in the circle tend to balance each other off quite nicely. (Active Air in the East is balanced by passive Water in the West, active Fire in the South is balanced by passive Earth in the North.)

---

<sup>15</sup> *Liber O*, Part IV.

# THE GREATER RITUAL OF THE PENTAGRAM

1. Touching the forehead say **Ateh** (Unto Thee).
2. Touching the breast say **Malkuth** (The Kingdom).
3. Touching the right shoulder, say **ve-Geburah** (and the Power).
4. Touching the left shoulder, say **ve-Gedulah** (and the Glory).
5. Clasp the hand upon the breast, say **le-OLAHM, AMEN** (To the Ages, Amen).
6. In the East make Invoking Equilibrated Active Pentagram of Spirit.
7. Vibrate **Eheieh**.
8. Give Active sign of the Portal.<sup>16</sup>
9. Make Invoking Pentagram of Air.
10. Vibrate **YHVH**.
11. Give the signs of  $2^\circ = 9^\square$ . [Stretch both arms upwards and outwards, the elbows bent at right angles, the hands bent back, the palms upwards as if supporting a weight.]

---

<sup>16</sup> The Signs of the Portal: Extend the hands in front of you, palms outwards, separate them as if in the act of rending asunder a veil or curtain (actives), and then bring them together as if closing it up again and let them fall to the side (passives).

12. Travel deosil (clockwise) and carry point to the South and make Invoking Equilibrated Active Pentagram of Spirit.

13. Vibrate **Eheieh**.

14. Give active sign of the Portal.

15. Make Invoking Pentagram of Fire.

16. Vibrate **Elohim**.<sup>17</sup>

17. Give signs of  $4^\circ = 7^\square$ . [Raise the arms above the head and join the hands, so that the tips of the fingers and of the thumbs meet, formulating a triangle.]

18. Travel deosil and carry point to the West and make Invoking Equilibrated Passive Pentagram of Spirit.

19. Vibrate **Agla**.

20. Give passive sign of the Portal.

21. Make Invoking Pentagram of Water.

22. Vibrate **AI**.<sup>18</sup>

---

<sup>17</sup> Divine Name representing the forces of creation (Genesis I, 1). Often mistranslated as the singular, "God," (*i.e.* "In the beginning God created..."), it is more accurately rendered "gods, male and female" for in Hebrew it is a *feminine* noun (ELOH) ending with a *masculine* plural (IM). Elohim thus is descriptive of female potency mated with a masculine idea. Without such a union offspring, and consequently creation, would be impossible.

<sup>18</sup> Divine Name representing the fourth Sefirah, Chesed, in the highest of the four Qabalistic worlds, Atziluth; often translated God the Creator; root of Eloah, Elohim, Allah, etc.

23. Give sign of  $3^\circ = 8^\square$ . [Raise the arms until the elbows are on a level with the shoulders, bring the hands across the chest, touching the thumbs and tips of fingers so as to form a triangle apex downwards.]
24. Travel deosil and carry point to the North and make Invoking Equilibrated Passive Pentagram of Spirit.
25. Vibrate **Agla**.
26. Give passive sign of the Portal.
27. Make Invoking Pentagram of Earth.
28. Vibrate **Adonai**.
29. Give sign of  $1^\circ = 10^\square$ . [Advance the right foot, stretch out the right hand upwards and forwards, the left hand downwards and backwards, the palms open.]
30. Travel deosil and return point to the East.
31. Repeat 1-5.



Ceremonies to invoke or banish a specific element can be constructed by opening and closing as above, but instead of going through the entire sequence of actions, the Magician simply turns to the appropriate quarter and proceeds with the Pentagrams, Signs, and Names applicable to the desired element.

As the Magician's understanding of the theories and processes evolves, he or she will design more complex and elaborate variations of the Greater Pentagram Ritual to access the elemental energies for more specific magical purposes, such as the consecration of the magical weapons or the charging of talismans.



## CHAPTER FIVE

---

# THE THELEMIC RITUALS OF THE PENTAGRAM

*Stooping down, dipping my wings, I came unto the darkly-splendid abodes. There in that formless abyss was I made a partaker of the Mysteries Averse.*

Liber LXV

As stated earlier, mastery of the Lesser and Greater Rituals of the Pentagram provides the Magician with the key to the microcosmic, elemental universe. Logically one would think the next task would be to gain mastery of the macrocosmic universe represented in nature by the seven planets of the ancients. In Western Hermeticism this “Greater World” is symbolically depicted as a hexagram with the Sun in the center and the six remaining planets—Saturn, Jupiter, Mars, Venus, Mercury, and Luna—positioned at each point. Mastery of the Hexagram rituals has traditionally been the next step in the Magician’s career.<sup>1</sup>

The influence of the elemental formula does not end at the borders of the microcosm. Indeed, it continues to be

---

<sup>1</sup> My original plan for the format of this book was to introduce the hexagram rituals at this point for the benefit the novice. I reconsidered so as to continue, without interruption, the train of thought established in the previous chapter. My apologies to beginning students who may wish to now turn to Part I of Chapter Six and briefly acquaint themselves with the traditional hexagram rituals before continuing on.

infused into all levels of consciousness. The most striking example of this elemental influence upon the macrocosm can be found in the Enochian magical records of Dr. John Dee.

In the Enochian view of the universe, each of the thirty Aethyrs, or macrocosmic heavens<sup>2</sup>, is ruled by three Governors.<sup>3</sup> Curiously, the names of these celestial Governors are derived from the four microcosmic elemental tablets of the system, demonstrating a continuing and fundamental influence of the elemental formulae throughout the macrocosm.

Clearly there exists an untapped form of universal Pentagram which operates simultaneously upon both the microcosmic *and* macrocosmic planes, and that the newly released energies of the new aeon make magical access to these formulae now possible. To activate this vastly higher order of elemental power, Crowley created two rituals: 1) *Liber XXV, The Star Ruby*, and 2) *Liber V, vel Reguli*. As Thelemic hybrids of the Lesser and Greater Pentagram Rituals, they function as ceremonial exercises to invoke the energies of the Aeon of Horus.

In these two ceremonies the focus of the Magician's consciousness is shifted from the Earth to the Sun; from the human to the Divine. No longer do we view ourselves as standing upon the surface of the Earth (with its four quarters ruled by the terrestrial winds), or even at the intersection of Samekh and Pé. We now identify ourselves with the Sun, surrounded by the zodiacal belt.

In both rituals the divine names attributed to the four quarters have become overtly Thelemic. *The Star Ruby* retains the same active/passive positions established in the Greater Ritual of the Pentagram; the active/male deities (Therion

---

<sup>2</sup> The 30 Aethyrs roughly correspond, in groups of 3, to the 10 Sephiroth, of the Tree of Life. For the Enochian Magician, exploration of the Aethyrs is comparable to the Pathworkings of the Qabalistic Magician.

<sup>3</sup> With the exception of the 30th Aethyr, Tex, which has four Governors.

and Hadit) are positioned in the active quarters (East and South, and the passive/female deities (Babalon and Nuit) are positioned in the passive quarters (West and North).

In *Liber V vel Reguli* the zodiacal landmarks of the four quarters are the fixed or Kerubic signs: Taurus/Earth in the East; Aquarius/Air in the North; Scorpio/Water in the West; and Leo/Fire in the South.<sup>4</sup> Of the triplicity of signs, the Fixed signs are the most characteristically representative of the elements.<sup>5</sup>

## THELEMIC HOLY WORDS AND DIVINE NAMES

Before we proceed to the rituals themselves, let us take just a few moments and examine the various Holy Words and Divine Names unique to the Magick of Thelema.

To fathom transcendental concepts, one must possess transcendental illumination. Consequently the Holy Words and Divine Names of the Thelemic pantheon defy adequate literary definition. As the Magician's initiatory career evolves, so too will his or her capacity to understand and exploit the divine principles represented by the words. I do not presume to offer, nor am I capable of establishing, orthodox definitions of these terms. I have even been counseled (by those whose opinions I highly respect) that *anything* I say on the matter will be pitifully inadequate, and will ultimately serve only to limit the reader's understanding. While I wholeheartedly agree this is true, I am also convinced that the reader, if warned that the notes that follow are the flawed, incomplete, and inaccurate thoughts of one who has not yet

---

<sup>4</sup> This clockwise zodiacal arrangement will be explained in the section concerning *Liber V vel Reguli*.

<sup>5</sup> It should be pointed out that the Zodiacal landmarks utilized in the traditional Hexagram rituals are the Cardinal signs; Aries/Fire in the East; Cancer/Water in the North; Libra/Air in the West; and Capricorn/Earth in the South. More on this in Chapter Six.

achieved any significant level of illumination, he or she may nevertheless appreciate a starting point for further study and meditation.

## NUIT

See *Liber AL vel Legis* (especially Chapter I).

The First Deity of the Thelemic Trinity; traditionally the Egyptian Goddess of the night sky. She is the "...star-goddess, who is the category of unlimited possibility."<sup>6</sup> Upon the *Stélé* of Revealing, and in Egyptian art, She is depicted as an azure goddess, tall and slender, arching over the earth. (similar in appearance to the Greek letter Ω.) She is conceptualized as the infinity of an ultimately *expanded* universe (the circumference of the circle). All things, therefore, are contained within her body. Qabalists may wish to consider the similarities to the Second Veil of the Negative proceeding Kether, AIN SOPH (No Limit).

## HADIT

See *Liber AL vel Legis* (especially Chapter II).

The Second Deity of the Thelemic Trinity. Lover of Nuit. He is depicted on the *Stélé* of Revealing as a winged globe at the heart of Nuit. He is conceptualized as the infinity of an ultimately *contracted* universe; the point in the center of the circle. He is "...the ubiquitous point of view, the only philosophically tenable conception of Reality."<sup>7</sup> (Perhaps the concept of the pre "Big-Bang" negative singularity postulated by modern physics.) Qabalists may wish to consider the similarities to the First Veil of the Negative proceeding Kether, AIN (Nothing).

## RA HOOR KHUIT

See *Liber AL vel Legis* (especially Chapter III).

<sup>6</sup> See *The Book of Thoth* (York Beach, ME: Samuel Weiser, 1974).

<sup>7</sup> *Ibid.*

The Third Deity of the Thelemic Trinity. The Crowned and Conquering Child of the union of Nuit and Hadit. As Nuit's expansion and Hadit's contraction are both infinite, so too must be their points of contact. This infinite contact creates the basis of possible vibration, (their Child Horus); the field of operation in which the universe can manifest. "He is, however, known under his special name, Heru-ra-ha. A double god; his extraverted form is Ra-hoor-khuit; and his passive or introverted form Hoor-pa-kraat."<sup>8</sup> Spelling variations found in *Liber AL vel Legis* include Ra Hoor Khut and Ra Hoor Khu, and are indicative of important facets of the Deity.

Qabalists may wish to consider the similarities to the Third Veil of the Negative proceeding Kether, AIN SOPH AUR (Limitless Light); also Kether itself. In one respect He is the fundamental archetype of the God-Man, and the Holy Guardian Angel.

## THERION AND BABALON

See *Liber AL vel Legis* (especially references to the Beast & Scarlet Woman).

It is clear that from an early age Crowley was spiritually and psychologically traumatized as the result of his family's fanatical embrace of Christian fundamentalism. It was perhaps inevitable that an individual of Crowley's genius would eventually rebel against the stifling restrictions, and the threats of eternal torment with which such cults terrorize their members. His childhood identification with the Beast 666 and his "Devil be my God" bravado was his youthful declaration of independence, and for the rest of his life he would continue to enjoy shocking the shockable with such sacrileges. We must point out, however, that there are profound magical and qabalistic significances to these "blasphemies" that Crowley so cavalierly embraced in his youth,

---

<sup>8</sup> *Ibid.*

and these immeasurably overshadow his mischievous pre-occupation with thumbing his nose at Christianity.

The use of the names Therion (Greek for Beast) and Babalon (the Scarlet Woman or Great Whore) is not unique in the annals of religious nomenclature. Together they make their first and most notoriously misunderstood appearance in *The Book of the Revelation of John*, the finale of the New Testament. A superficial review of this book, presents us with what appears at first glance to be two shady, if not downright “evil,” characters. But looks can be deceiving, and as is often the case with books of the Bible, the villain of the exoteric story is frequently revealed to be the hero of the esoteric interpretation.

There is no need to enter into the argument as to whether “Beast” refers to the man Aleister Crowley, or to the “office” of the Beast, or to some universal principal. At one time or another before his death, Crowley wrote that they were all of the above.<sup>9</sup> For our purposes we will simply attempt to introduce the concepts by drawing parallels to ideas with which the reader may already be acquainted:

**Therion/Babalon as Chokmah/Binah**—To the student of the Qabalah the easiest way to begin to understand Therion and Babalon is to conceptualize them as personifications of the second and third Sephiroth of the Tree of Life, Chokmah and Binah, respectively.

The second Sephirah, Chokmah represents the original concept of duality, and as such is the chaotic despoiler of the perfect unity of the first Sephirah, Kether. Chaos is another title of Chokmah and in certain Thelemic ritual is identified with Therion. Chokmah is also the Divine Will, the Logos, the Word whose vibration is the creative essence of universe. As the supernal Father, Chokmah/Therion is the archetype of the lingam, the universal Male. As TO MEGA THERION<sup>10</sup>

---

<sup>9</sup> See *Magick Book Four, Liber ABA* (York Beach, ME: Samuel Weiser, 1993).

<sup>10</sup> The Great Beast.

(his motto as Magus 9° = 2□), Crowley is considered by Thelemites to be the Logos of the Aeon of Horus.

The third Sephirah, Binah represents the original reconciliation and balance of the Divine Self (Kether) and the reflected Not Self (Chokmah). She is viewed as the all-receptive mate of Chokmah and when they are united the primal unity of Kether is realized. As Binah/Babalon resides just above the Abyss, She eventually receives unto Herself the totality of the life of the evolving universe. This universal life is symbolized as the "blood of the Saints" which She gathers up into Her great cup (the Holy Graal). This She shares with the Beast, and they unite in drunken ecstasy. Thus she is called the Great Whore for in her "shamelessness" she receives all and refuses none.

**Therion/Babalon as Shiva/Shakti**—To the student of the Yoga or Tantric Buddhism, the easiest way to think about Therion and Babalon is to conceptualize them as the two polar streams of creation, Shiva—the Divine Will, the Logos, who manifests in creative union with His divine consort, Shakti—the Divine Power and the underlying and secret force permeating all of creation.

Babalon/Shakti is the passive, negative stream of nature. She is magnetic and attracts to Herself, the potentiality of energy. This she absorbs and stores up (the Holy Graal, the Cup of Babalon). When the negative/feminine Shakti comes into proper contact with the positive/masculine Shiva, a dynamic reaction occurs triggering the transcendence of their individual polarity, transforming them into Brahma, the changeless One. This is a most important aspect of Therion and Babalon because it relates to natural energies and forces residing in our own bodies.

Slumbering in the form of a coiled serpent at the base of the human spine is the Kundalini, a remnant of the universal Shakti. She has been separated and exiled from Her Lord Shiva (who resides in the human skull) by the very process of creation. The task of the Kundalini Yogi is to awaken this sleeping Goddess and direct her ascent up the spine to eventual union with Her Lord in the cranium.

But one does not have to be a Yogi or a Qabalist or a Ceremonial Magician to achieve transcendental states of consciousness in the ecstasy of lovemaking or to temporarily annihilate the ego in orgasm. These are fundamental male/female realities of existence and consciousness, and they are an integral part of cosmos from the lowest hell to the highest heaven. More on this in Chapter Six.

## AIWASS

See *Liber AL vel Legis*, Chapter I.

Alternate spelling AIWAZ. The “minister of Hoor-paar-kraat.”<sup>11</sup> Praeter human intelligence who dictated the three chapters of *Liber AL vel Legis*. Aiwass is considered messenger of the Gods of the Aeon of Horus. Crowley would eventually identify Aiwass as his own Holy Guardian Angel. I was told by both Israel Regardie and Grady McMurtry that Crowley acknowledged Aiwass in the Qabalistic Cross portion of the Pentagram rituals as follows:

1. Touching the forehead say **Ateh** (Unto Thee),
2. Touching the heart say **Aiwass**,
3. Touching the genitals say **Malkuth** (The Kingdom),
4. Touching the right shoulder, say **ve-Geburah** (and the Power),
5. Touching the left shoulder, say **ve-Gedulah** (and the Glory).
6. Clasping the hand upon the breast, say **le-OLAHM, AMEN**, (To the Ages, Amen).

## PAN

Greek for “All.” Originally the lusty and mischievous rustic God of Thracian shepherds; His audacious and colorful personality captured the imagination of the entire Hellenistic

---

<sup>11</sup> The Lord of Silence.



world, and established for Pan a permanent place in Greek mythology. Pan is, however, more than a playful imp. Even in the ancient myths one can see an underlying profundity to his escapades that hint that Pan may be a deity of a far greater order than His Olympian contemporaries. His name suggests that He is the Great All; the God who transcends the gods. The “Comedy of Pan” is the singular reality of life itself. For those of us who have not yet achieved the levels of illumination necessary to perceive this greater reality, life is a dizzying mixture of pleasure and pain, joy and sorrow. Finding one’s True Will is the key to embracing, then transcending these dualities and becoming an ecstatic and enthusiastic player in the great Comedy of Pan.<sup>12</sup> IO PAN is the traditional invocation of Pan. *I* (the lingam) joined with *O* (the yoni) is a simple yet explicit invitation for the God who transcends duality to couple with the devotee.

#### ANKH-AF-NA KHONSU

See *Liber AL vel Legis*, Chapters I & III.

Egyptian priest of the XXVth Dynasty.<sup>13</sup> The *Stélé* of Revealing is the funerary tablet of Ankh-af-na-Khonsu who reportedly painted it himself upon stuccoed wood. He is depicted on the *stélé* standing at the table of offerings before the God, Ra-Hoor-Khuit. Crowley claimed that as Ankh-af-na-Khonsu, in a previous incarnation, he was responsible for initiating the Aeon of Osiris.

#### LASH TAL

See essay following *Liber V vel Reguli*.

#### AGAPE

Love; in Greek enumerates to 93.

<sup>12</sup> See *Liber Aleph* (York Beach, ME: Samuel Weiser, 1991), Chap. 197.

<sup>13</sup> Crowley believed it to be the Twenty-Sixth Dynasty, but modern research indicates as above. See “The Holy Books of Thelema”, in *Equinox Vol. III, no. 9*. (York Beach, ME: Samuel Weiser, 1983).

## AUMGN

Thelemic expansion of OM (AUM) the creative vibration that sustains the Universe. By replacing *M* with the compound letters MGN (again 93), Crowley felt the word more accurately represented the true processes of the cycle of the universe.<sup>14</sup>

## FIAOF

Thelemic expansion of IAO. Spelled א י ו פ in Hebrew and FIAOF in Greek (both 93). By adding a *F* as prefix and suffix of IAO, Crowley considered it to be "...a proper hieroglyph of the Ritual of Self-Initiation in this Aeon of Horus."<sup>15</sup>

## ABRAHADABRA

The great Magick Word of the Aeon of Horus. Volumes of commentaries could be written on this word alone, and so I will not project even the pretense of thoroughness in my comments. References to ABRAHADABRA are found throughout Crowley's works but the reader is especially encouraged to study "An Essay Upon Number" found in 777.<sup>16</sup>

Briefly, its eleven letters (five identical and six diverse) are illustrative of the Great Work accomplished. It joins *that which is above to that which is below*—the microcosmic world of 5 to the macrocosmic world of 6.

It enumerates to 418 the same as the Hebrew letter Cheth spelled in full. The Path of Cheth crosses the Abyss, joining the fifth Sephirah, Geburah, with the third Sephirah, Binah (the abode of Babalon). The tarot card attributed to Cheth is the Charioteer who bears the Holy Graal across the Abyss where it becomes the Cup of Babalon.

There are other names and words unique to Thelemic Magick which we will discuss in later chapters. As I

<sup>14</sup> See *Liber Samekh* (York Beach, ME: Samuel Weiser, 1979). For an entire essay on AUMGN see *Magick*, Chap. 7 part V.

<sup>15</sup> *Ibid.* Chap. 5.

<sup>16</sup> (York Beach, ME: Samuel Weiser, 1982).

explained earlier, these are not orthodox (or even adequate) definitions.

## THELEMIC PENTAGRAM RITUAL I

### The Star Ruby

There are at least four published versions of *The Star Ruby*. Most of them vary only slightly from one another. For our purposes we will use the version which appears in *BOOK IV, Part Three: Magick in Theory and Practice*.<sup>17</sup> We have numbered each line for reference purposes.

It must be noted that the oldest version, which appeared in the 1913 first edition of *The Book of Lies*,<sup>18</sup> employs Greek Divine Names and other variations that differ considerably from later versions. Crowley revised the ritual in the 1920s to conform with *Liber V vel Reguli*, and to express his expanded understanding of Thelemic cosmology. We have included the information from this first version in the footnotes of the text and strongly recommend that it be carefully studied.

*The Star Ruby* differs from the traditional Pentagram rituals in many other ways besides the Divine Names (*i.e.*, parts of the ceremony are in Greek, the Pentagrams are imagined, not drawn, the Magician moves widdershins around the circle, etc.). Perhaps the most significant innovation is the introduction of the invocation of Pan by the application of the N.O.X. formula. This, more than any other part of the ritual, elevates *The Star Ruby* above a simple banishing ritual by integrating the formula of the Supernal Triad.<sup>19</sup> The reader is encouraged to carefully study the notes which follow the text of the ritual for greater insight on this most important aspect of Thelemic Magick.

<sup>17</sup> (York Beach, ME: Samuel Weiser, 1993).

<sup>18</sup> (York Beach, ME: Samuel Weiser, 1986).

<sup>19</sup> Kether, Chokmah, and Binah, the first, second, and third Sephiroth located above the Abyss. Binah is referred to as the "Night of Pan" and the home of the Supernal Babalon.

Referring to the Greek words employed in *The Star Ruby*, Crowley wrote, "The secret sense of these words is to be sought in the numeration thereof." To help the student with further research, we have included a table outlining the numerical equivalents of the Greek Alphabet (see Table 1).

Table 1. Numerical Equivalents of the Greek Alphabet.

Greek Alphabet (Upper case, lower case)		Numerical Value
A, α	=	1
B, β	=	2
Γ, γ	=	3
Δ, δ	=	4
E, ε	=	5
F	=	6
Z, ζ	=	7
H, η	=	8
Θ, θ	=	9
I, ι	=	10
K, κ	=	20
Λ, λ	=	30
M, μ	=	40
N, ν	=	50
Ξ, ξ	=	60
O, ο	=	70
Π, π	=	80
Ϟ	=	90
P, ρ	=	100
Σ, σ, ς	=	200
T, τ	=	300
Y, υ	=	400
Φ, φ	=	500
X, χ	=	600
Ψ, ψ	=	700
Ω, ω	=	800
Ϡ	=	900

**LIBER XXV**  
**THE STAR RUBY**  
A.: A.: publication in Class D.

1. Facing East, in the centre, draw deep deep deep thy breath, closing thy mouth with thy right forefinger prest against thy lower lip. Then dashing down the hand with a great sweep back and out, expelling forcibly thy breath, cry ΑΠΟ ΠΑΝΤΟΣ ΚΑΚΟΔΑΙΜΟΝΟΣ.
2. With the same forefinger touch thy forehead, and say ΣΟΙ, thy member, and say Ω ΦΑΛΛΕ, thy right shoulder, and say ΙΣΧΥΡΟΣ, thy left shoulder, and say ΕΥΧΑΡΙΣΤΟΣ; then clasp thine hands, locking the fingers, and cry ΙΑΩ.
3. Advance to the East. Imagine strongly a Pentagram, aright, in thy forehead. Drawing the hands to the eyes, fling it forth, making the sign of Horus and roar ΘΗΠΙΟΝ.<sup>20</sup> Retire thine hand in the sign of Hoor-paar-Kraat.<sup>21</sup>
4. Go round to the North and repeat; but say **NUIT**.<sup>22</sup>
5. Go round to the West and repeat; but whisper **BABALON**.<sup>23</sup>
6. Go round to the South and repeat; but bellow **HADIT**.<sup>24</sup>
7. Completing the circle widdershins, retire to the centre and raise thy voice in the Paian, with these words ΙΩ ΠΑΝ, with the signs of N.O.X.

---

<sup>20</sup> *The Book of Lies* has "ΧΑΟΣ" (Chaos).

<sup>21</sup> *The Book of Lies* has "Hoor pa kraat."

<sup>22</sup> *The Book of Lies* has "but scream BABALON."

<sup>23</sup> *The Book of Lies* has "but say ΕΡΩΣ" (Eros).

<sup>24</sup> *The Book of Lies* has "ΥΨΧΗ" (Psyche).

8. Extend the arms in the form of a Tau and say low but clear:

ΠΡΟ ΜΟΥ ΙΥΓΓΕΣ  
ΟΠΙΣΩ ΜΟΥ ΤΕΛΕΤΑΡΧΑΙ  
ΕΠΙ ΔΕΞΙΑ ΣΥΝΟΧΕΙΣ  
ΕΠΑΡΙΣΤΕΡΑ ΔΑΙΜΟΝΕΣ  
ΦΛΕΓΕΙ ΓΑΡ ΠΕΡΙ ΜΟΥ Ο ΑΣΤΗΡ ΤΩΝ ΠΕΝΤΕ  
ΚΑΙ ΕΝ ΤΗ ΣΤΗΛΗ Ω ΑΣΤΗΡ ΤΩΝ ΕΞ ΕΣΤΗΚΕ.

9. Repeat the Cross Qabalistic, as above, and end as thou didst begin (1 and 2).



#### AUTHOR'S NOTES ON THE STAR RUBY

**LIBER XXV, THE STAR RUBY:** 25 is the square of 5 (the Pentagram). The Fifth Sephirah is Geburah, whose color is red.

1) **APO PANTOS KAKODAIMONOS** (Away every evil Spirit!).

2) **SOI** (Unto you). **O FALLE** (O Phallus). **ISCHUROS** (Strong; Strength). **EUCHARISTOS** (Eucharist; mystic feast; thanksgiving). **I-A-O** (IAO, triune God of the Gnostics; co-defined with INRI in various rituals as a formula of resurrection; Isis (Nature) is ruined by Apophis (forces of destruction/decay) then reborn as the resurrected Osiris).

3) **THERION:** "*The Sign of Hoor-paar-Kraat*": Right forefinger or thumb to lips. See Chapter Five. "*The Sign of Horus*" also known as the "*Sign of the Enterer*." It is described earlier in instructions on vibration of God Names.

4) **NUIT:** See Chapter Five.

5) **BABALON:** See Chapter Five.

6) **HADIT**: See Chapter Five.

7) **IO PAN**: An Invocation of the Great All. See Chapter Five.

**N.O.X.**: The Night of Pan. Contrasted with L.V.X. (Light in Extension), N.O.X. could be characterized as *Light Withdrawn*. It is the negative pulse of the creation/dissolution cycle, much like the Vendantist concept of Pralaya, the universal sleep that precedes and follows creation. Perhaps the most significant characteristic of the magical formulae of the Aeon of Horus is the recognition of this fundamental fact of life, and the joint application of L.V.X. and N.O.X. in the initiatory career of the Magician.

“The Signs of N.O.X.” are named Puella, Puer, Vir, and Mulier:

**Puella** (girl). Standing with the feet together, head bowed, left hand shielding the Muladhara Cakra (area of the groin), and right hand shielding the breast (attitude of the Venus de Medici).

**Puer** (boy). Standing with feet together and head erect. Let right hand (the thumb between the index and medius fingers) be raised, the forearm vertical at a right angle with the upper arm, which is horizontally extended in the line joining the shoulders. Let the left hand, the thumb extended forwards and the fingers clenched, rest at the junction of the thighs (attitude of the Gods Mentu, Khem, etc.).

**Vir** (man). The feet being together. The hands, with clenched fingers and thumbs thrust out forwards, are held to the temples; the head is then bowed and pushed out, as if to symbolize the butting of an horned beast (attitude of Pan, Bacchus, etc.).

**Mulier** (wife). The feet are widely separated, and the arms raised so as to suggest a crescent. The head is thrown back (attitude of Baphomet, Isis in Welcome, the microcosm of Vitruvius).

- 8) **PRO MOU IUGGES** (Before me the Iynges<sup>25</sup>);  
**OPISO MOU TELETARCAI** (behind me the Teletarch[ae]);  
**EPI DEXIA SYNOCEIS** (on my right hand the Synoches);  
**EPARISTERA DAIMONES** (on my left, the daemons<sup>26</sup>);  
**FLEGEI GAR PERI MOU O ASTHR TON PENTE** (for  
about me flames the Star of Five).  
**KAI EN THI STHLHI** (and in the column);  
**O ASTHR TON EX ESTHKE** (stands the Star of Six).



## THELEMIC PENTAGRAM RITUAL II

### Liber V vel Reguli

Now we come to a Thelemic Pentagram ritual about which there is considerable disagreement and controversy. Unthreateningly described as “*an incantation proper to invoke the Energies of the Aeon of Horus, adapted for the daily use of the Magician of whatever grade,*” its ambiguities and mysteries nevertheless continue to challenge and intrigue students.

Crowley’s published comments on *Reguli* are sparse, so I have been fortunate to have been allowed access to Crowley’s notes and several unpublished versions of the ritual which have been helpful in writing this chapter.

Crowley introduces *Reguli* as “the Ritual of the Mark of the Beast,” which to a great many people, especially those who think they understand the Book of the Revelation of

<sup>25</sup> According to the Chaldean Oracles of Zoroaster, each individual, prior to any theurgic ritual, must gain consciousness of the “*agathosdaimon,*” a personal guardian spirit or angel who functions as the mediator between the aspirant and the gods. These guides are called “*Iunges*” or “*Ferryman.*” Literally “*wrynecks,*” traditionally the birds of the abyss. Iunges, Synoches, and Teletarchae comprise the three celestial Intelligences or Archangels of Chaldean cosmology.

<sup>26</sup> Diamonos. The geniuses of Platonist philosophy.



John, has a decidedly sinister ring to it. But, as is usually the case with the nomenclature of Thelemic Magick, the expression that evokes fear and loathing in the hearts of the profane, is revealed to the wise to be a profound and spiritually *wholesome* arcanum.

To the Qabalist, the Mark of the Beast (Rev. 13:16) is the New Testament development of the Mark of Cain (Gen. 4:15), which, contrary to popular religious interpretation, is not the brand of a cursed sinner, but instead represents the radiant seal of illumination in the forehead of the Initiate. Graphically, the Mark of the Beast is represented in its most simple form as the Sun and Moon<sup>27</sup> united (☺) and, among other things, is the symbol of Babalon and the Beast conjoined, and the Great Work accomplished.

Therefore, as... *an incantation proper to invoke the Energies of the Aeon of Horus...* the Ritual of the Mark of the Beast, if properly executed, serves to rewire the psychic body of the Magician to accommodate these higher spiritual energies. In fact, the overt employment of the various chakras makes *Reguli* as much a yogic exercise as a ritual of ceremonial Magick.

While roughly adhering to the basic format of the Pentagram rituals and *The Star Ruby*, there are some fundamental and drastic differences that distinguish *Liber V vel Reguli*. Some of these are obvious. Others I feel need to be addressed.

## THE FIRST GESTURE

The Qabalistic Cross opening found in the previous rituals affirms the three columns of the Tree of Life: the Middle Pillar (Ateh-Malkuth), the Pillar of Severity (Geburah), and the Pillar of Mercy (Gedulah). In *Reguli* this has been replaced by

---

<sup>27</sup> See *The Book of the Law*, I, xvi. Crowley developed a more elaborate version which he used as one of his seals. In that version one easily sees (no apologies to Freud) an aerial view of the male genitalia.

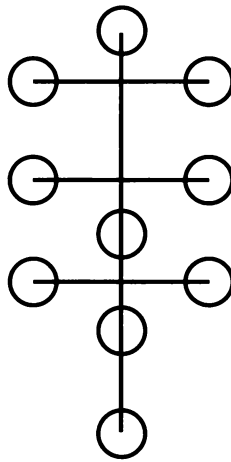

A)

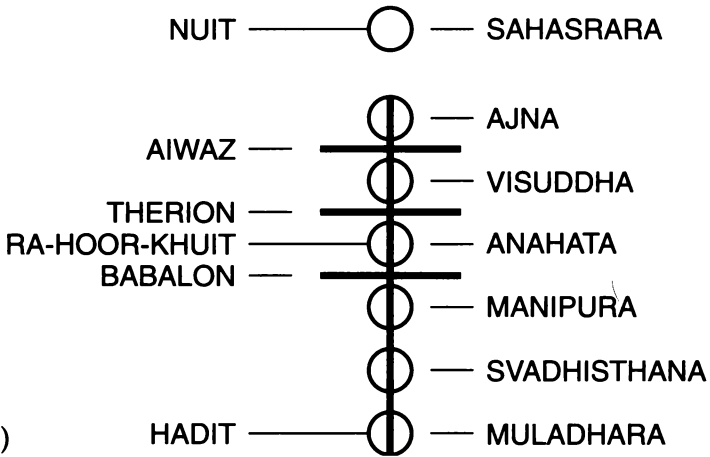

B)

Figure 4. The vertical and horizontal components of the enchantment correspond to the Thelemic pantheon and relate directly to the Tree of Life and the Seven Chakras. a) Sigil of the Grand Hierophant projected on the Tree of Life; b) The Sigil of the Grand Hierophant created by the Vertical and Horizontal Components of the Enchantment projected upon the seven Chakras.

the “Vertical Component of the Enchantment,” which affirms the Middle Pillar; and the three “Horizontal Components of the Enchantment,” which affirms the three horizontal Paths which join the Pillar of Severity to the Pillar of Mercy. “Thus shall he formulate the Sigil of the Grand Hierophant.”

Incorporation of the horizontal Paths is perhaps the most notable innovation of *Reguli* and sets it apart, fundamentally, from all other rituals of the Pentagram. This is especially significant in light of the fact that Crowley maintained that the Aeon of Horus activated the Path of Teth<sup>28</sup> (the horizontal Path between fifth Sephirah, Geburah, and the fourth Sephirah, Chesed) on the Universal Tree of Life. (See figure 4.)

## THE SECOND GESTURE

Like the Lesser and the Greater Rituals of the Pentagram, the Pentagrams in *Reguli* are drawn in the air. But unlike any of the previous ceremonies, the Pentagrams employed in *Reguli* are described as “averse.”

Crowley was a master of the English language and *averse* is a very curious word for him to use. What is an averse Pentagram? Is it upside down? If so, *inverted* would be a much more accurate word. Is it upright with the elemental positions reversed? Unfortunately Crowley published no precise definition.

In 1978, I asked Israel Regardie what he thought Crowley meant. To my disappointment he told me that he didn’t know for certain, but believed Crowley may have simply wished to shock and outrage the members of the Golden

---

<sup>28</sup> Teth, the 19th Path of the Tree of Life—attributed to Leo (the Beast) and to the tarot card Strength. In pre-Thelemic decks the card depicts a woman holding the mouth of a lion. In Crowley’s version of the card, which is titled Lust, the woman is Babalon and She sits astride the Beast (Babalon and the Beast conjoined).

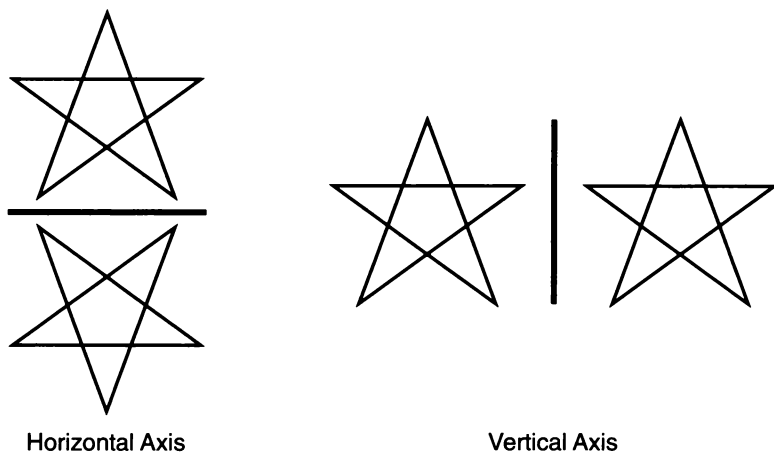

Figure 5. *Averse Pentagrams.*

Dawn whose fear of the *inverted* Pentagram bordered on phobia.<sup>29</sup> Regardie recommended that I use the traditional upright invoking Pentagrams. Other Crowley experts have been even less helpful on the subject, suggesting everything from reversed upright Pentagrams to upside-down Pentagrams formulated in the mind and hurled forth as in *The Star Ruby*.

The dictionary defines *averse* as... “turned away or backward.” In botany it refers to leaves which are turned away from the axis or main stem as opposed to *adverse* in which the leaves turn toward the axis. By this definition we might conclude that two Pentagrams, one upright and one inverted, joined horizontally at the axis of their bases, could *both* be considered *averse* to each other; we could also conclude (though with less conviction) that two upright Pentagrams, mirroring each other right to left are also *averse* (see figure 5).

Following the qabalistic axiom of polarities (we are negative to the plane above us, and positive to the plane below

<sup>29</sup> “...it is an evil symbol, affirming the empire of matter over that Divine Spirit which should govern it. See that thou doest it not.” See *The Golden Dawn*, Vol. IV (River Falls, WI: Hazel Hills, 1969), p. 9.

us), we might wish to follow this line of reasoning a bit further. The two Pentagrams with the horizontal axis could be projected upon the Tree of Life as shown in figure 6.

Granted this arrangement leaves poor Malkuth dangling, (a position not without qabalistic precedence) but everything else fits quite nicely. Using the Path of Teth as the base line, all three horizontal paths so important to *Liber V vel Reguli* are represented. Also note the two tetrahedrons formed by this arrangement.

Another method is to project all four Averse Pentagrams upon the tree as shown in figure 7 on page 98. Here we see that the Path of Teth, is unique among the three horizontal paths. Like a looking-glass, it is the point of reflection; the pivotal axis to all four averse Pentagrams.

Once the four are superimposed upon the Tree, we discover that they form a double version of Crowley's Unicursal Hexagram, the Hexagram of the Beast, which is traced in line 20 of the Second Gesture of *Reguli* (see figure 8 on page 99).

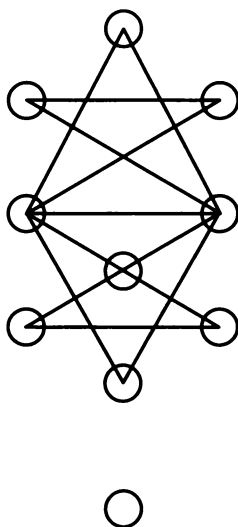

Figure 6. Two Pentagrams with the horizontal axis upon the Tree of Life.

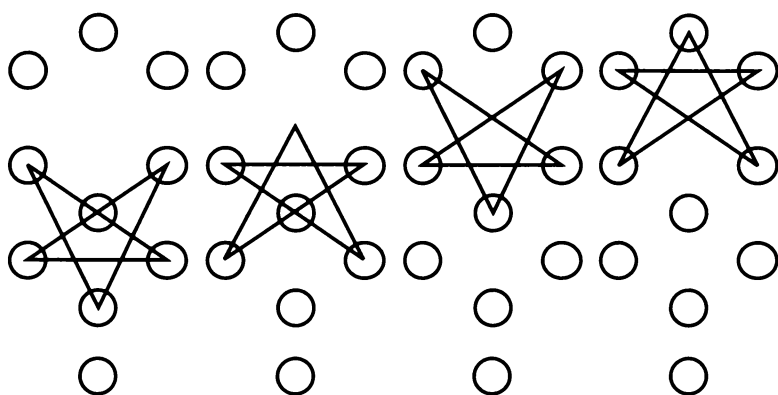

Figure 7. Four averse Pentagrams upon the Tree of Life.

The student wishing to pursue this line of speculation further can construct Pentagrams based on the Universe card, the five of disks from Crowley's Thoth<sup>30</sup> Tarot deck, the elemental format of those used in the Greater Ritual of the Pentagram, or by projecting the Pentagrams upon the Tree of Life, according to the elemental rulership of the Sephiroth. Viewed in relation to other Thelemic rituals, especially *The Star Sapphire*, there are even subtler and more complex considerations to be weighed, including the concept of employing the N.O.X. formula to access an averse (or reversed) Tree of Life.

Speculation on this matter could continue indefinitely, and I am not at all sure *that* wasn't Crowley's intention. Over the last twenty years, as my understanding and appreciation of Thelemic rituals has grown, my opinion on this subject has changed at least a dozen times. Confusion over this point, however, did not prevent me from learning the ritual and working with it on a daily basis. It is only by working the rituals, that any significant degree of understanding can

<sup>30</sup> *The Book of Thoth* (York Beach, ME: Samuel Weiser, 1974), pp. 230, 243.

develop. If you wait until you are positive you understand all aspects of the ceremony before beginning to work, you will never begin to work.

All conjecture aside, the whole question of the averse Pentagrams seems to finally have been put to rest by a manuscript bearing Crowley's handwritten notes and drawings, recently found at the George Arents Research Library at Syracuse University. This typescript, whose provenance has been tentatively attributed to 1928, includes the entire text of *Liber V vel Reguli*, complete with drawings of the various Pentagrams and symbols. It reveals without ambiguity that the averse Pentagram is simply the standard Pentagram turned upside down (see figure 9 on page 100).

The elements remain in their same positions, and directions for invoking and banishing are exactly as they would be if you drew a standard, upright Pentagram on a piece of paper, and then simply turned the paper upside down.

Now we know for certain what the averse Pentagrams are, but why do we use them? A clue to our answer might be

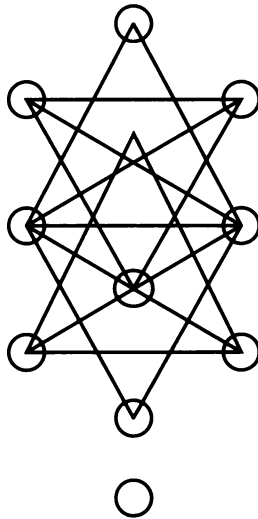

Figure 8. Four averse Pentagrams forming Unicursal Hexagrams.

found in *Reguli's* unique positioning of the four fixed signs of the zodiac.

Traditionally the zodiac is thought of as a belt on twelve constellations, or signs through which the sun passes (from the earth's point of view) in a counterclockwise yearly journey. We could make a traditional magical circle of the zodiacal belt, by placing Taurus in the East, Leo in the North, Scorpio in the West and Aquarius in the South (see figure 10).

As we will see in *Reguli*, however, this is not the case; Taurus is still in the East, and Scorpio is still in the West, but the positions of Leo and Aquarius are reversed. In other words, for this ritual, the signs of the zodiac are now running clockwise. Has Crowley turned the belt of the zodiac upside down? No. He has turned the *Magician* upside down.

As I have mentioned earlier, in the Thelemic rituals of the Pentagram the Magician no longer thinks of himself or herself as standing upon the surface of the Earth (geocentric), but rather, identifies with the Sun (heliocentric). From the Sun's point of view there is no up or down. In order to help liberate the Magician from the old aeon illusion of restricted orientation, Crowley now positions us upside down in the center of the zodiacal belt. In this position the zodiac now appears to run clockwise and, from the point of

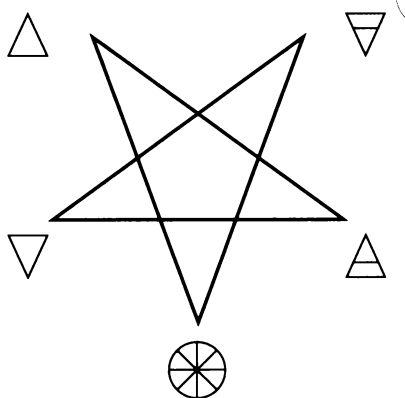

Figure 9. Averse Pentagram.



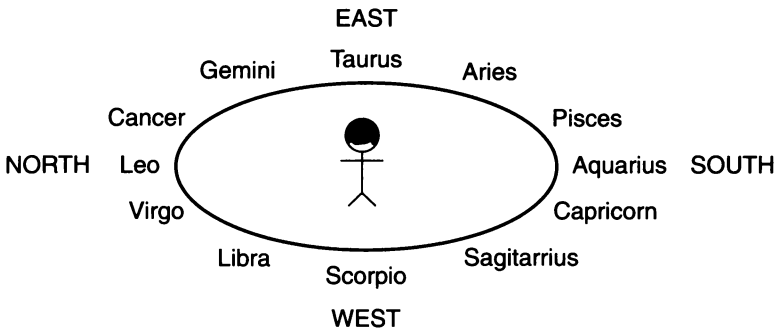

Figure 10. Traditional view of the zodiac as a magical circle. There are fixed signs in the quarters. The Magician is facing Taurus (east).

view of microcosmic orientation, the Pentagrams we would draw from this position are naturally averse. If it were possible for you to actually perform *Liber V vel Reguli* while standing on your head, then (from your upside-down point of view) the zodiac would run counter-clockwise, and the Pentagrams would be upright.

Perhaps, for some, the averse Pentagram will continue to be the frightful symbol of the triumph of matter over spirit (as the aspirants of the Golden Dawn are warned). In *Reguli*, however, it is not a case of matter triumphing over Spirit, rather, it is a case of Spirit descending into matter.<sup>31</sup>

I have incorporated Crowley's notes and drawings from the above mentioned manuscript in the text of *Reguli* below. I have also included, as footnotes, his comments from another manuscript. My own comments as editor are identified as such.

<sup>31</sup> "Now is the Pillar established in the Void; now is Asi fulfilled of Asar; now is Hoor let down into the Animal Soul of Things like a fiery star that falleth upon the darkness of the earth." LIBER CORDI SCINC TISER PENTE vel LXV, Chapter V. In *Holy Books of Thelema* (York Beach, ME: Samuel Weiser, 1990) p. 76.

## LIBER V VEL REGULI.

A.: A.: publication in Class D. Being the Ritual of the Mark of the Beast; an incantation proper to invoke the Energies of the Aeon of Horus, adapted for the daily use of the Magician of whatever grade.

### THE FIRST GESTURE.

The Oath of the Enchantment, which is called The Elevenfold Seal.

*The Animadversion* ♀ towards the Aeon.

1. Let the Magician, robed and armed as he may deem to be fit, turn his face toward Boleskine,<sup>32</sup> that is the House of The Beast 666.
2. Let him strike the battery 1-3-3-3-1.
3. Let him put the Thumb of his right hand between its index and medius, and make the gestures hereafter following.

*The Vertical Component of the Enchantment.*

1. Let him describe a circle about his head, crying NUTH!<sup>33</sup>
2. Let him draw the Thumb vertically downward, and touch the root of his phallus, crying HADITH!<sup>34</sup>

---

<sup>32</sup> Boleskine House is on Loch Ness, 17 miles from Inverness, Latitude 57.14 N. Longitude 4.28 W.

<sup>33</sup> (Nuit above head) Brain (Brahmarandra).

<sup>34</sup> Seed (Muladara).

3. Let him, retracing the line, touch the centre of his breast, and cry RA-HOOR-KHUIT!<sup>35</sup>

*The Horizontal Components of the Enchantment.*

1. Let him touch the Centre of his Forehead, his mouth, and his larynx, crying AIWAZ!<sup>36</sup>

2. Let him draw his Thumb from right to left across his face at the level of the nostrils.

3. Let him touch the Centre of his Breast, and his Solar Plexus, crying THERION!<sup>37</sup>

4. Let him draw his Thumb from left to right across his breast, at the level of the sternum.

5. Let him touch his Navel, and the Root of his Phallus, crying BABALON!<sup>38</sup>

6. Let him draw his Thumb from right to left across his abdomen, at the level of the hips.

[Thus shall he formulate the Sigil of the Grand Hierophant, but dependent from the Circle.]

*The Asseveration of the Spells.*

1. Let the Magician clasp his hands upon his Wand, his fingers and thumbs interlaced, crying LASH TAL: THELEMA: FIAOF: AGAPE: AUMGN.

---

<sup>35</sup> Force & Fire (Anahata).

<sup>36</sup> Silence & Speech (Ajna & Visuddhi).

<sup>37</sup> (Manipura or also Anahata?).

<sup>38</sup> (\*Svadisthana, the Womb) \*or could R.H.K.—the Lord of the system in visible form—be the two halves of the brain? I think so: then 666 is Anahata.

[Thus shall be declared the Words of Power whereby the Energies of the Aeon of Horus work his Will in the world.]

*The Proclamation of the Accomplishment.*

1. Let the Magician strike the Battery: 3-5-3, crying **ABRAHADABRA**.<sup>39</sup>

## THE SECOND GESTURE.

*The Enchantment.*

1. Let the Magician, still facing Boleskine, advance to the circumference of his Circle.

2. Let him turn himself towards the left, and pace with the stealth and swiftness of a tiger the precincts of his circle, until he complete one revolution thereof.

3. Let him give the Sign of Horus (or the Enterer)<sup>40</sup> as he passeth, so to project the Force that radiateth from Boleskine before him.

4. Let him pace his Path until he comes to the North; there let him halt, and turn his face to the North.

5. Let him trace with his wand the Averse Pentagram proper to invoke Air (Aquarius) .

6. Let him bring the Wand to the centre of the Pentagram and call upon Nuith!

7. Let him make the sign called Puella, standing with feet together, head bowed, his left hand shielding his phallus, and his right hand shielding his breast (attitude of the Venus de Medici).

---

<sup>39</sup> Manipura is the Word of The Aeon itself.

<sup>40</sup> See Chapter Four.—*Ed.*

8. Let him turn again to the left, and pursue his Path as before, projecting the Force from Boleskine as he passeth; let him halt when he next cometh to the South, and face outward.

9. Let him trace the Averse Pentagram that invoketh Fire (Leo) .

10. Let him point his Wand to the Centre of the Pentagram, and cry **HADITH!**

11. Let him give the Sign Puer, standing with feet together, and head erect. Let his right hand [the thumb between index and medius] be raised, the forearm vertical at a right angle with the upper arm, which is horizontally extended in the line joining the shoulders. Let his left hand, the thumb extended forwards, and the fingers clenched, rest at the junction of the thighs [attitude of the Gods Mentu, Khem, etc.].

12. Let him proceed as before; then in the East, let him make the Averse Pentagram that invoketh Earth (Taurus) .

13. Let him point his Wand to the Centre of the Pentagram, and cry **THERION!**

14. Let him give the sign called Vir, the feet being together. The hands, with clenched fingers and thumbs thrust out forwards, are held to the temples; the head is then bowed and pushed out, as if to symbolize the butting of an horned beast (attitude of Pan, Bacchus, etc.) (Frontispiece, Eqx. I – III).

15. Proceeding as before, let him make in the West the Averse Pentagram whereby Water is invoked .<sup>41</sup>

16. Pointing the Wand to the Centre of the Pentagram, let him call upon **BABALON!**

17. Let him give the sign Mulier. The Feet are widely separated, and the arms raised so as to suggest a crescent. The

---

<sup>41</sup> Scorpio.—*Ed.*

head is thrown back [attitude of Baphomet, Isis in Welcome, the Microcosm of Vitruvius]. (See Book 4, Part II.)

18. Let him break into the dance, tracing a centripetal spiral widdershins, enriched by revolutions upon his axis as he passeth each quarter, until he come to the centre of the circle. There let him halt, facing Boleskine.

19. Let him raise the Wand, trace The Mark of the Beast<sup>42</sup>, and cry **AIWAZ!**

20. Let him trace the Invoking Hexagram of The Beast .

21. Let him lower the Wand, striking the Earth therewith.

22. Let him give the sign of Mater Triumphans<sup>43</sup> [The feet are together; the left arm is curved as if it supported a child; the thumb and index of the right hand pinch the nipple of the left breast, as if offering it to that child]. Let him utter the word **THELEMA!**

23. Perform the Spiral Dance, moving deosil and whirling widdershins. Each time on passing the West extend the Wand to the Quarter in question, and bow:

- a. **Before me the powers of LA!** [to West].
- b. **Behind me the powers of AL!** [to East].
- c. **On my right hand the powers of LA!** [to North].
- d. **On my left hand the powers of AL!** [to South].
- e. **Above me the powers of ShT!** [leaping in the air].
- f. **Beneath me the powers of ShT!** [striking the ground].
- g. **Within me the powers!** [in the attitude of Ptah erect, the feet together, the hands clasped upon the vertical Wand].

---

<sup>42</sup> The Mark of the Beast is , where Sol is Hadit, Luna is Nuith and the Testes 666 and 156.

<sup>43</sup> Also called "Isis Rejoicing."—Ed.

**h. About me flames my Father's Face, the Star of Force and Fire.**

**i. And in the Column stands His six-rayed Splendour!**

[This dance may be omitted, and the whole Utterance chanted in the attitude of Ptah.]

### **THE FINAL GESTURE.**

This is identical with the First Gesture.

[Here followeth an impression of the ideas implied in the Paean.]<sup>44</sup>

I also am a Star in Space, unique and self-existent, an individual essence incorruptible; I also am one Soul; I am identical with All and None. I am in All, and all in me; I am, apart from all and lord of all, and one with all.

I am a God, I very God of very God; I go upon my way to work my Will; I have made Matter and Motion for my mirror; I have decreed for my delight that Nothingness should figure itself as twain, that I might dream a dance of names and natures, and enjoy the substance of simplicity by watching the wanderings of my shadows. I am not that which is not; I know not that which knows not; I love not that which loves not. For I am Love, whereby division dies in delight; I am Knowledge, whereby all parts, plunged in the whole, perish and pass into perfection; and I am that I am, the being wherein Being is lost in Nothing, nor deigns to be but by its Will to unfold its nature, its need to express its perfection in all possibilities, each phase a partial phantasm, and yet inevitable and absolute.

---

<sup>44</sup> The complete version of this essay may be found in *Magick Book Four Part IV* (York Beach, ME: Samuel Weiser, 1993).—Ed.

I am Omniscient, for naught exists for me unless I know it. I am Omnipotent, for naught occurs save by Necessity, my Soul's expression through my Will to be, to do, to suffer the symbols of itself. I am Omnipresent, for naught exists where I am not, who fashioned Space as a condition of my consciousness of myself, who am the centre of all, and my circumference the frame of mine own fancy.

I am the All, for all that exists for me is a necessary expression in thought of some tendency of my nature, and all my thoughts are only the letters of my Name.

I am the One, for all that I am is not the absolute All, and all my all is mine and not another's; mine, who conceive of others like myself in essence and truth, yet unlike in expression and illusion.

I am the None, for all that I am is the imperfect image of the perfect; each partial phantom must perish in the clasp of its counterpart; each form fulfil itself by finding its equated opposite, and satisfying its need to be the Absolute by the attainment of annihilation.

The Word, LASH TAL includes all this.

LA—Naught.

AL—Two.

L is "Justice", the Kteis fulfilled by the Phallus, "Naught and Two" because the Plus and the Minus have united in "love under will."

A is "the Fool", Naught in Thought (Parzival), Word (Harpocrates), and Action (Bacchus). He is the boundless air, the wandering Ghost, but with "possibilities." He is the Naught that the Two have made by "love under will."

LA thus represents the Ecstasy of Nuit and Hadit conjoined, lost in love, and making themselves Naught thereby. Their child is begotten and conceived, but is in the phase of Naught also, as yet. LA is thus the Universe in that phase, with its potentialities of manifestation.

AL, on the contrary, though it is essentially identical with LA, shows the Fool manifested through the Equilibrium of Contraries. The weight is still nothing, but it is expressed



as if it were two equal weights in opposite scales. The indicator still points to zero.

*ShT* is equally 31 with *LA* and *AL*, but it expresses the secret nature which operates the Magick or the transmutations.

*ShT* is the formula of this particular aeon; another aeon might have another way of saying 31.

*Sh* is Fire as *T* is Force; conjoined they express Ra-Hoor-Khuit.

"The Angel"<sup>45</sup> represents the Stélé 666, showing the Gods of the Aeon, while "Strength"<sup>46</sup> is a picture of Babalon and The Beast, the earthly emissaries of those Gods.

*ShT* is the dynamic equivalent of *LA* and *AL*. *Sh* shows the Word of the Law, being triple, as 93 is thrice 31. *T* shows the formula of Magick declared in that Word; the Lion, the Serpent, the Sun, Courage and Sexual Love are all indicated by the card.

In *LA* note that Saturn or Satan is exalted in the House of Venus or Astarte, and it is an airy sign. Thus *L* is Father-Mother, Two and Naught, and the Spirit (Holy Ghost) of their Love is also Naught. Love is AHBH, 13, which is AChD, Unity, 1, Aleph, who is The Fool who is Naught, but none the less an Individual One, who (as such) is not another, yet unconscious of himself until his Oneness expresses itself as a duality.

Any impression or idea is unknowable in itself. It can mean nothing until brought into relation with other things. The first step is to distinguish one thought from another; this is the condition of recognizing it. To define it, we must perceive its orientation to all our other ideas. The extent of our knowledge of any one thing varies therefore with the number of ideas with which we can compare it. Every new fact not only adds itself to our universe, but increases the value of what we already possess.

---

<sup>45</sup> This is the Tarot Key XX, Judgement, titled "Aeon" in the Crowley Thoth deck.—Ed.

<sup>46</sup> This is the Tarot Key XI, titled "Lust" in the Crowley Thoth deck.—Ed.

In *AL* this "The" or "God" arranges for "Countenance to behold countenance, by establishing itself as an equilibrium, *A* the One-Naught conceived as *L* the Two-Naught. This *L* is the Son-Daughter Horus-Harpocrates just as the other *L* was the Father-Mother Set-Isis. Here then is Tetragrammaton once more, but expressed in identical equations in which every term is perfect in itself as a mode of Naught.

*ShT* supplies the last element; making the Word of either five or six letters, according as we regard *ShT* as one letter or two. Thus the Word affirms the Great Work accomplished:  $5^{\circ} = 6^{\square}$ .

*ShT* is moreover a necessary resolution of the apparent opposition of *LA* and *AL*; for one could hardly pass to the other without the catalytic action of a third identical expression whose function should be to transmute them. Such a term must be in itself a mode of Naught, and its nature cannot encroach on the perfections of Not-Being, *LA*, or of Being, *AL*. It must be purely Nothing-Matter, so as to create a Matter-in-Motion which is a function of "Something."

Thus *ShT* is Motion in its double phase, an inertia composed of two opposite currents, and each current is also thus polarized. *Sh* is Heaven and Earth, *T* Male and Female; *ShT* is Spirit and Matter; one is the Word of Liberty and Love flashing its Light to restore Life to Earth; the other is the act by which Life claims that Love is Light and Liberty. And these are Two-in-One, the divine letter of Silence-in-Speech whose symbol is the Sun in the arms of the Moon.

But *Sh* and *T* are alike formulae of force in action as opposed to entities; they are not states of existence, but modes of motion. They are verbs, not nouns.

*Sh* is the Holy Spirit as a "tongue of fire" manifest in triplicity, and is the child of Set-Isis as their Logos or Word uttered by their "Angel." The card is XX, and 20 is the value of Yod (the secret seed of all things, the Virgin, the Hermit, Mercury, the Angel or Herald) expressed in full as IVD. *Sh* is the Spiritual congress of Heaven and Earth.

But *T* is the Holy Spirit in action as a "roaring lion" or as the "old Serpent" instead of as an "Angel of Light." The

twins of Set-Isis, harlot and beast, are busy with that sodomitic and incestuous lust which is the traditional formula for producing demi-gods, as in the cases of Mary and the Dove; Leda and the Swan, etc. The card is XI, the number of Magick AVD: Aleph the Fool impregnating the woman according to the word of Yod, the Angel of the Lord! His sister had seduced her brother Beast, shaming the Sun with her sin; she has mastered the Lion and enchanted the Serpent. Nature is outraged by Magick; man is bestialized and woman defiled. The conjunction produces a monster; it affirms regression of types. Instead of a man-God conceived of the Spirit of God by a virgin in innocence, we are asked to adore the bastard of a whore and a brute, begotten in shamefullest sin and born in most blasphemous bliss.

## CHAPTER SIX

---

# THE HEXAGRAM RITUALS

*0. O my God! One is Thy Beginning! One is Thy Spirit, and Thy Permutation One!*

*1. Let me extol Thy perfections before men.*

*2. In the Image of a Sixfold Star that flameth across the Vault inane, let me re-veil Thy perfections.*

*3. Thou hast appeared unto me as an aged God, a venerable God, the Lord of Time, bearing a sharp sickle.*

*4. Thou hast appeared unto me as a jocund and ruddy God, full of Majesty, a King, a Father in his prime. Thou didst bear the sceptre of the Universe, crowned with the Wheel of Spirit.*

*5. Thou hast appeared unto me with sword and spear, a warrior God in flaming armour among Thine horsemen.*

*6. Thou hast appeared unto me as a young and brilliant God, a god of music and beauty, even as a young god in his strength, playing upon the lyre.*

*7. Thou hast appeared unto me as the white foam of Ocean gathered into limbs whiter than the foam, the limbs of a miracle of women, as a goddess of extreme love, bearing the girdle of gold.*

8. *Thou hast appeared to me as a young boy mischievous and lovely, with Thy winged globe and its serpents set upon a staff.*

9. *Thou hast appeared to me as an huntress among Thy dogs, as a goddess virginal chaste, as a moon among the faded oaks of the wood of years.*

10. *But I was deceived by none of these. All these I cast aside, crying: Begone! So that all these faded from my vision.*

11. *Also I welded together the Flaming Star and the Sixfold Star in the forge of my soul, and behold! a new star 418 that is above all these.*

12. *Yet even so was I not deceived; for the crown hath twelve rays.*

13. *And these twelve rays are one.*

—Liber DCCCXII vel ARARITA

Once the Magician has become adept in the execution of the microcosmic rituals of the Pentagram, the next step, according to tradition, is to master the rituals of the Signet Star of the macrocosm, the Hexagram. The Thelemic ritual of the Hexagram is *Liber XXXVI, The Star Sapphire* which first appeared in the 1913 first edition of *The Book of Lies*. As we will see later, this ritual is much more than the conventional Ritual of the Hexagram, super-charged with Thelemic components. In fact there are many who consider it Crowley's greatest contribution to Western Hermeticism.

But before examining *The Star Sapphire* we need a fundamental understanding of classic rituals of the Hexagram. To this end we will first examine the Lesser Ritual of the

Hexagram and Crowley's comments on the Greater Ritual of the Hexagram as they appear in *Liber O*, Part IV.<sup>1</sup> For the most part, the rituals are self explanatory, so I have kept my introductory comments brief.

The Golden Dawn defined the Hexagram as "...a powerful symbol representing the operation of the Seven Planets under the presidency of the Sephiroth, and of the seven-lettered Name ARARITA...a divine name...formed of the Hebrew initials of the sentences: **One is his beginning. One is his individuality. His permutation is one.**"<sup>2</sup>

Perhaps the most concise definition of ARARITA can be found in the English translation of the last words of *The Star Sapphire*: "Six in One through the names of Seven in One, Ararita."<sup>3</sup> Concerning this sevenfold word Crowley wrote in his 1909 privately printed edition of *θηλημα*;

The use of this Name and Formula is to equate and identify every idea with its opposite; thus being released from the obsession of thinking any one of them as <<true>> (and therefore binding); one can withdraw oneself from the whole sphere of the Ruach.<sup>4</sup>

The Hexagram itself is illustrative of the union of opposites. In its classic form it combines the red upright triangle of Fire with the blue triangle of Water which has its apex pointing downward. (We will learn in the next chapter this is not the case in *The Star Sapphire*.)

---

<sup>1</sup> *Magick* (York Beach, ME: Samuel Weiser, 1989).

<sup>2</sup> *Ibid.*

<sup>3</sup> *Ibid.*

<sup>4</sup> See *The Holy Books of Thelema* (York Beach, ME: Samuel Weiser, 1990), p. xxxiv.

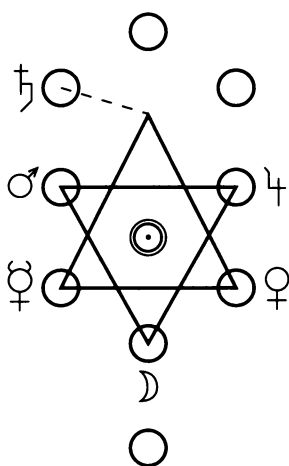

Figure 11. The Hexagram projected upon the Tree of Life.

As we see in figure 11, when projected upon the Tree of Life, the Hexagram includes Sephiroth three<sup>5</sup> through nine. Daath-Binah notwithstanding, this area of the Tree of Life is attributed to the third qabalistic world, Yetzirah, and the Vav of the Tetragrammaton. If we recall the allegory of the Tetragrammaton, Princess/Heh-final, (anesthetized and exiled in the microcosmic world of 5), must be awakened by the kiss of Prince/Vav (her brother-lover-emissary of the macrocosmic world of 6). Their union eventually results in the Princess becoming the Supernal Queen/Heh and the Prince becoming King/Yod. The spiritual roles these four characters play will become profoundly important to the understanding of *The Star Sapphire*.

Vav = 6 and, in this place, representative of the Holy Guardian Angel. The first phase of the Great Work is to unite

<sup>5</sup> The third Sephirah, Binah, representing Saturn, is not actually touched by the uppermost point of the Hexagram, which reaches up to the Abyss and touches the false Sephirah Daath. Nevertheless qabalists are satisfied with this surrogate relationship as Daath is not an inappropriate stand-in for the inscrutabilities of Binah and the Supernal Triad.

the 5 of the Magician with the 6 of the H.G.A.; and the first step in doing that is to "... equate and identify every idea with its opposite...."<sup>6</sup> Regular performance of the Lesser Ritual of the Pentagram followed by the Lesser Ritual of the Hexagram is the symbolic enactment of this process, and continues to be an excellent ceremonial routine even for the most advanced Magician.

In the Rituals of the Hexagram, the Magician stands as the Sun surrounded by the belt of the zodiac. The zodiacal landmarks of the quarters are the Cardinal Signs which are oriented on the solar axes of the equinoxes and solstices: Aries-Fire in the East; Capricorn-Earth in the South; Libra-Air in the West; and Cancer-Water in the North. Standing at the intersection, and representing a vertical line running perpendicular to the two lines of the cross, the Magician sets to work from a position of supreme balance.

The rituals begin with the analysis of the Key Word INRI<sup>7</sup> from the 5<sup>o</sup> = 6<sup>o</sup> ceremony of the Golden Dawn. Considered by the Adepts of the Aeon of Osiris to be the "new, improved" magical formula of the day, the latinized/Christian formula of resurrection (INRI) is seen to conceal the great formulae of the Egyptians and the Gnostics (IAO). As the Qabalistic Cross section of the Pentagram Ritual affirms the Magician's identity as a perfect reflection of the Tree of Life, this section of the Hexagram Ritual is the Magician's assertion that he or she is an integral part of the evolving magical formula of the universe.

Only the traditional versions of the Hexagram (see figure 12 on p. 118) were used to illustrate *Liber O*. For zodiacal and planetary work, as outlined in Crowley's comments on the Greater Hexagram Ritual, one could just as easily employ Unicursal Hexagrams (see figure 12). This is a par-

---

<sup>6</sup> Ibid.

<sup>7</sup> Initials of Jesus Nazaraeus Rex Judaeorum; but also, Igni Natura Renovata Integra: Isis Naturae Regina Ineffabilis, and a host of other sentences.



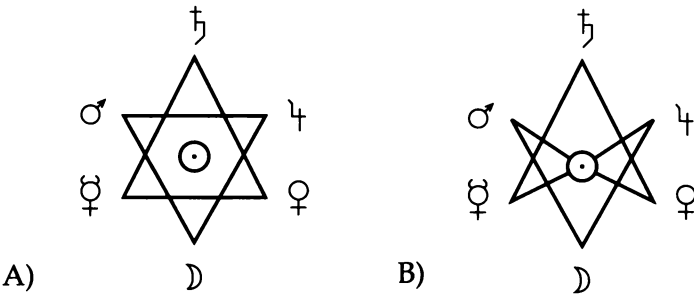

Figure 12. Hexagrams: a) Traditional; b) Unicursal.

ticularly Thelemic form of the Hexagram and will play a large part in our study of the Holy Hexagram of the *Star Sapphire*. Table 2 shows the various Unicursal Hexagrams.

Table 2. Unicursal Hexagrams

Planet	Invoking	Banishing
Saturn (♄)		
Jupiter (♃)		
Mars (♂)		
Venus (♀)		
Mercury (☿)		
Moon (☾)		
Sun (☉)		

# THE LESSER RITUAL OF THE HEXAGRAM

This ritual is to be performed after the "Lesser Ritual of the Pentagram."

1. Stand upright, feet together, left arm at side, right across body, holding Wand or other weapon upright in the median line. Then face East and say:

2. **I.N.R.I.**

**Yod, Nun, Resh, Yod.**

**Virgo, Isis, Mighty Mother.**

**Scorpio, Apophis, Destroyer.**

**Sol, Osiris, Slain and Risen.**

**Isis, Apophis, Osiris IAΩ.**

3. Extend the arms in the form of a cross, and say, **The Sign of Osiris Slain.** (See figure 3 on page 62.)

4. Raise the right arm to point upwards, keeping the elbow square, and lower the left arm to point downwards, keeping the elbow square, while turning the head over the left shoulder looking down so that the eyes follow the left forearm, and say, **The Sign of the Mourning of Isis.** (See figure 3 on page 62.)

5. Raise the arms at an angle of sixty degrees to each other above the head, which is thrown back, and say, **The Sign of Apophis and Typhon.** (See figure 3 on page 62.)

6. Cross the arms on the breast, and bow the head and say, **The Sign of Osiris Risen.** (See figure 3 on page 62.)

7. Extend the arms again as in (3) and cross them again as in (6), saying **L.V.X., the Light of the Cross.**

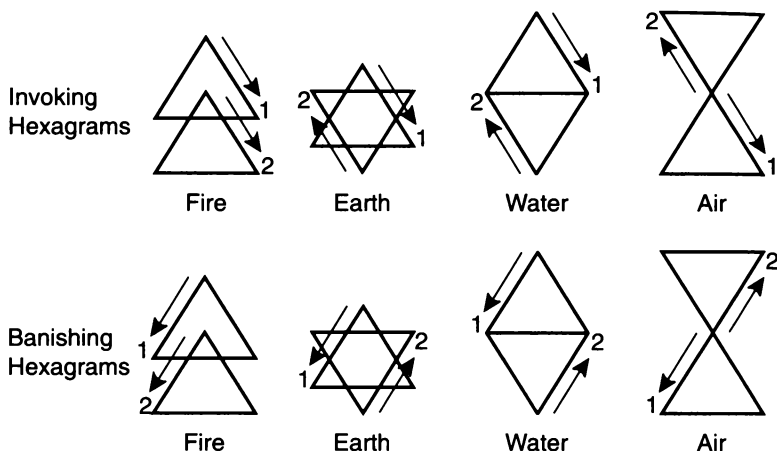

Figure 13. *Elemental Hexagrams* adapted from Liber O, Part IV.

8. With the magical weapon trace the Hexagram of Fire (see figure 13) in the East, saying, **ARARITA** (אָרָרִיטָא). This word consists of the initials of a sentence which means "One is His beginning: One is His Individuality: His Permutation is One."

This Hexagram consists of two equilateral triangles, both apices pointing upward. Begin at the top of the upper triangle and trace it in a dextro-rotary direction. The top of the lower should coincide with the central point of the upper triangle.

9. Trace the Hexagram of Earth (see figure 13) in the South, saying **ARARITA**. This Hexagram has the apex of the lower triangle pointing downwards, and it should be capable of inscription in a circle.

10. Trace the Hexagram of Air (see figure 13) in the West, saying **ARARITA**. This Hexagram is like that of Earth; but the bases of the triangles coincide, forming a diamond.

11. Trace the Hexagram of Water (see figure 13) in the North, saying **ARARITA**. This Hexagram has the lower triangle placed above the upper, so that their apices coincide.
12. Repeat (1-7).

The Banishing Ritual is identical, save that the direction of the Hexagrams must be reversed (see figure 13).

To invoke or banish planets or zodiacal signs, the hexagram of Earth alone is used. Draw the Hexagram beginning from the point which is attributed to the planet you are dealing with (see "777," col. xxxiii). Thus to invoke Jupiter begin from the right hand point of the lower triangle, dextro-rotary and complete; then trace the upper triangle from its left hand point and complete.

Trace the astrological sigil of the planet in the center of your hexagram.<sup>8</sup>

For the Zodiac use the hexagram of the planet which rules the sign you require ("777," col. xxxviii) but draw the astrological sigil of the sign, instead of that of the planet.

For Caput and Cauda Draconis use the lunar hexagram with the sigil of ☾ or ☽.

To banish, reverse the hexagram.

In all cases use a conjuration first with Ararita, and next with the name of the God corresponding to the planet or sign you are dealing with.<sup>9</sup>

The Hexagrams pertaining to the planets are shown in figure 14 on page 122.

<sup>8</sup> Note the double sets of numbers for the Solar Hexagrams. To invoke or banish the Sun, all six planetary hexagrams are drawn in their regular planetary order.—*Ed.*

<sup>9</sup> The Traditional God Names of the Planets are as follows: ☿-YHVH ELOHIM; ♃-EL, ♂-ELOHIM GIBOR; ☊-YHVH ELOAH VE-DAATH; ♀-YHVH TZABAOTH; ♁-ELOHIM TZABAOTH; and ♃-SHADDAI EL CHAI.—*Ed.*

Invoking		Banishing
	Saturn (♄)	
	Jupiter (♃)	
	Mars (♂)	
	Venus (♀)	
	Mercury (♿)	
	Moon (☾)	
	Sun (☉)	

Figure 14. Planetary Hexagrams adapted from Liber O, Part IV.

# THE THELEMIC RITUAL OF THE HEXAGRAM

*Thus far then concerning the Pentagram, how it is the Cross, and its Virtue in the Highest; but the Hexagram is for the most Part a Detail of the Formula of the Rose and Cross. Already have I shewed unto thee how the Most Holy Trinity is the Yang; but the Spirit, and the Water (or Fluid) and the Blood, that bear Witness in the Inferior, are of the Yin. Thus the Operation of the Hexagram lieth wholly within the Order of one Plane, uniting indeed any Soul with its Image, but not transcendently, for its Effect is Cosmos, the Vau that springeth from the Union of the Yod and the Hé.*

—Liber Aleph

*The Star Sapphire* first appeared in 1913 as Chapter 36 of *The Book of Lies*. Like *The Star Ruby* and the rest of the material in that little book, it reflects the extraordinarily high level of illumination that characterize Crowley's work of that period. It contained the following commentary:

The Star Sapphire corresponds with the Star-Ruby of Chapter 25; 36 being the square of 6, as 25 is of 5.

This chapter gives the real and perfect Ritual of the Hexagram.

It would be improper to comment further upon an official ritual of the A.: A.:

As I believe that a book about Thelemic Rituals would be incomplete without a basic introduction to *The Star Sapphire*, I feel it necessary to risk the condemnation of those who maintain that *any* discussion of the ritual in print is improper. Since the mid 1970s, at least a dozen works have been published that have touched upon the subject of this ritual. While many have been well-intentioned efforts, others have contained what I consider to be gross distortions and dubious interpretations. After reading them, I understand the wisdom of Crowley's commentary. Be that as it may, I think it is important that I offer a brief introduction and a few notes.

Crowley's autohagiography would have us believe that *The Star Sapphire* was hastily written as the Thelemic version of the Hexagram Ritual, and that he had no idea of any deeper implications. He relates how he received an unexpected visit from Theodor Reuss, the head of Ordo Templi Orientis, who accused him of publishing the Order's central secret, a technique of Sexual Magic. When Crowley protested he did no such thing, and that he didn't even know any secret of Sexual Magic, Reuss produced a copy of *The Book of Lies* and pointed to Chapter 36, *The Star Sapphire*.

Scholars debate the veracity of this story, but there is little dispute that this ceremony can easily be interpreted as a sex Magick ritual. Be that as it may, I take exception to those who, with knowing winks and nudges, would have us believe that *The Star Sapphire*, or *Liber XV*, or a host of other Crowley rituals, are merely elaborate blinds for a variety of exotic sex acts.

All Magick is sexual. Indeed, all life is sexual. It is either overt or implied, invoked or directed, stored or released. The Mass of the Roman Catholic Church is every bit as much a pantomime of the sex act as the "Great Rite" of the witches. The real question is "what is sex symbolic of?"

*The Star Sapphire* is written as if it could be a complex choreographed act of ceremonial lovemaking. After all, the Hexagram is symbolic of the union of opposites. In this ritual,

the real challenge of the Magician lies in the ability to concentrate, to visualize, receive, direct, and exchange the energies represented by the various "Holy Hexagrams." This work is performed on the magical plane which can be accessed by any number of techniques including (but not limited to) sex. Whenever opposites are transcended and perfect union is realized, a greater "something" is achieved. In lovemaking it is the ecstasy of orgasm; in initiation it can be the Knowledge and Conversation of the Holy Guardian Angel.

I encourage the student who has mastered the traditional Hexagram rituals, to learn *The Star Sapphire*. Practice it as a non-sexual exercise, by drawing the Unicursal or traditional Hexagrams (see figures 13 and 14 on pages 120 and 122 for examples). Study and meditate upon the implications of the signs, the words, and most importantly, the meanings of the four "Holy Hexagrams." Your labor will be well repaid.



In Chapter 69 of *The Book of Lies*, Crowley gives us the only explicit definition of the Holy Hexagram ever published. We reproduce it and Crowley's commentary and hope the reader will find it useful.

ΚΕΦΑΛΗ ΞΘ<sup>1</sup>

## THE WAY TO SUCCEED— AND THE WAY TO SUCK EGGS!

This is the Holy Hexagram.

Plunge from the height, O God, and interlock  
with Man!

Plunge from the height, O Man, and interlock  
with Beast!

The Red Triangle is the Descending Tongue of  
grace; the Blue Triangle is the ascending  
tongue of prayer.

This Interchange, the Double Gift of Tongues, the Word of Double Power—**ABRAHADABRA!**—is the sign of the **GREAT WORK**, for the **GREAT WORK** is accomplished in Silence, And behold is not that Word equal to Cheth, that is Cancer whose Sigil is ☉?

This Work also eats up itself, accomplishes its own end, nourishes the worker, leaves no seed, is perfect in itself.

Little children, love one another!

### COMMENTARY (ΞΘ)<sup>2</sup>

The key to the understanding of this chapter is given in the number and the title, the former being intelligible to all

---

<sup>1</sup> See *The Holy Books of Thelema* (York Beach, ME: Samuel Weiser, 1990), Chapter 69.

<sup>2</sup> *Ibid.*

nations who employ Arabic figures, the latter only to experts in deciphering English puns.

The chapter alludes to Levi's drawing of the Hexagram, and is a criticism of, or improvement upon, it. In the ordinary Hexagram, the Hexagram of nature, the red triangle is upward, like fire, and the blue triangle, downward, like water. In the magical Hexagram this is reversed: the descending red triangle is that of Horus, a sign specially revealed by him personally, at the Equinox of the Gods. (It is the flame descending upon the altar, and licking up the burnt offering.) The blue triangle represents the aspiration, since blue is the colour of devotion, and the triangle, kinetically considered, is the symbol of directed force.

In the first three paragraphs this formation of the hexagram is explained; it is a symbol of the mutual separation of the Holy Guardian Angel and his client. In the interlocking is indicated the completion of the work.

Paragraph 4 explains in slightly different language what we have said above, and the scriptural image of tongues is introduced.

In paragraph 5 the symbolism of tongues is further developed. Abrahadabra is our primal example of an interlocked word. We assume that the reader has thoroughly studied that word in Liber D., etc. The sigil of Cancer links up this symbolism with the number of the chapter.

The remaining paragraphs continue the Gallic symbolism.

# LIBER XXXVI

## THE STAR SAPPHIRE.

A.: A.: publication in Class D.

1. Let the Adept be armed with his Magick Rood [and provided with his Mystic Rose].

2. In the centre, let him give the L.V.X. signs; or if he know them, if he will and dare do them, and can keep silent about them, the signs of N.O.X. being the signs of Puer, Vir, Puella, Mulier. Omit the sign I.R.<sup>3</sup>

3. Then let him advance to the East, and make the Holy Hexagram, saying: **Pater et Mater unus deus Ararita.**

4. Let him go round to the South, make the Holy Hexagram and say: **Mater et Filius unus deus Ararita.**

5. Let him go round to the West, make the Holy Hexagram and say: **Filius et Filia unus deus Ararita.**

6. Let him go round to the North, make the Holy Hexagram and then say: **Filia et Pater unus deus Ararita.**

7. Let him then return to the Centre, and so to the Centre of All [making the "Rosy Cross" as he may know how] saying **Ararita Ararita Ararita.**

8. [In this the Signs shall be those of Set Triumphant or of Baphomet. Also shall Set appear in the Circle. Let him drink of the Sacrament and let him communicate the same.]

---

<sup>3</sup> Isis Rejoicing, which is the same as Mater Triumphans of Reguli.—*Ed.*

9. Then let him say: **Omnia in Duos: Duo in Unum: Unus in Nihil: Haec nec Quatuor nec Omnia nec Duo nec Unus nec Nihil Sunt.**

10. **Gloria Patri et Matri et Filio et Filiae et Spiritui Sancto externo et Spiritui Sancto interno ut erat est erit in saecula Saeculorum sex un uno per nomen Septem in uno Ararita.**

11. Let him then repeat the signs of L.V.X. but not the signs of N.O.X.: for it is not he that shall arise in the Sign of Isis Rejoicing.



#### AUTHOR'S COMMENTS, TRANSLATIONS, AND NOTES

1. The Magick Rood is the Wand of the Magician; the Lance of the Priest; symbolic of the Lingam. His Mystic Rose is the Cup of the Priestess, symbolic of the Yoni.

2. The L.V.X. signs are to be used in the standard version of *The Star Sapphire*. But the ritual can also be executed employing the N.O.X. signs if the Magician is at the point of his or her initiatory career where it is appropriate and necessary. Since this is less often the case we are warned by the powers of the sphinx "...if he know them, if he will and dare do them, and can keep silent about them..." The Sign of Isis Rejoicing is omitted as it has no correspondent among the Signs of L.V.X. (See figure 3 on page 62 for the Signs of the Grades and the Signs of N.O.X.)

3. The Holy Hexagram of Fire. The transcendence of opposites which occurs at the union of Yod and Heh.

**Pater et Mater unus deus Ararita** ("Father and Mother one god Ararita").

4. The Holy Hexagram of Earth. The transcendence of opposites which occurs at the union of Heh and Vav.

**Mater et Filius unus deus Ararita** ("Mother and Son one god Ararita").

5. The Holy Hexagram of Air. The transcendence of opposites which occurs at the union of Vav and Heh-final.

**Filius et Filia unus deus Ararita** ("Son and Daughter one god Ararita").

6. The Holy Hexagram of Water. The transcendence of opposites which occurs at the union of Heh-final and Yod.

**Filia et Pater unus deus Ararita** ("Daughter and Father one god Ararita").

7. The "Rosy Cross" is the union of the Magick Rood and the Mystic Rose. It can be appropriately symbolized in this ritual as the Unicursal Hexagram with the small five-petal rose in the center.

8. The Sign of Set Triumphant could be interpreted as the Sign of Mater Triumphans. The product of the union is then treated as a Eucharist.

9. **Omnia in Duos** (All in Two) **Duo in Unum** (Two in One) **Unus in Nihil** (One in Nothingness) **Haec nec Quatuor nec Omnia nec Duo nec Unus nec Nihil Sunt** ("These are neither Four nor All nor Two nor One nor Nothing.").

10. **Gloria Patri et Matri et Filio et Filiae et Spiritui Sancto externo et Spiritui Sancto interno ut erat est erit in saecula Saeculorum sex un uno per nomen Septem in uno Ararita** ("Glory be to the Father and to the Mother and to the Son

and Daughter, and to the Holy Spirit without and within, which was, is, and shall be, world without end. Six in One through the names of the Seven in One, Ararita.”)

11. The N.O.X. signs are inappropriate at this point for the Epiphany has occurred as the result of the creation of the Rosy Cross.

## CHAPTER EIGHT

---

# KNOWLEDGE AND CONVERSATION OF THE HOLY GUARDIAN ANGEL

*...The Single Supreme Ritual is the attainment of the Knowledge and Conversation of the Holy Guardian Angel. It is the raising of the complete man in a vertical straight line.*

*Any deviation from this line tends to become black magic. Any other operation is black magic...if the magician needs to perform any other operation than this, it is only lawful in so far as it is a necessary preliminary to That One Work.*

—Magick

No aspect of the Magick of Thelema is more important than the Knowledge and Conversation of the Holy Guardian Angel. It is the classic and universal personal religious experience. Until attained, no vision, ritual, invocation, evocation, conjuration, divination, yogic discipline, or magical practice can be truly efficacious or trustworthy.

It is the unacknowledged central truth underlying the world's so-called "great religions" and the key to the understanding of the myths upon which they are founded. The Holy Guardian Angel is the divine object of devotion of the Bhakti Yogi; Krishna to the Hindu, and Christ to the Christian. No matter by what name or in what form, the Holy Guardian Angel transfigures the devotee and bestows bliss and an

expanded consciousness which is prerequisite to any further spiritual experience or attainment. The Concept of the "H.G.A." is ancient, but the term—Holy Guardian Angel—as it is used in Magick is relatively new.

In 1888 Golden Dawn Adept S. L. MacGregor-Mathers translated an extraordinary fifteenth-century grimoire called *The Book of the Sacred Magic of Abra-Melin, the Mage*. Purportedly written in 1458 by Abraham the Jew, (an enigmatic character not without historical credentials in Central European court intrigues), this remarkable work proved to be quite unlike any other magical text.

While contemporary grimoires sent would-be Magicians on endless scavenger hunts (tracking down bats' blood, eye of newt, etc.), in order to summon the power to bewitch the neighbor's cow or repel the evil eye, *Abra-Melin* introduces a novel idea. In order to receive real magical power, the Magician must first actually become an individual of superior spiritual integrity. To exercise god-like powers, one must be god-like. Pious affirmations, and the parroting of pre-composed magical incantations are useless unless the Magician be truly a holy person. This simple yet profound theory was a radical departure from the primitive techniques of medieval European Magick, and elevated the art to a level comparable to the yogic sciences of the East.

*The Book of the Sacred Magic of Abra-Melin, the Mage* postulates that every individual has a Holy Guardian Angel; a spiritual Being unique to each of us. This Being, whose true nature can only be adequately explained by itself, is more than a projection of our perfected Self. Indeed, until we have united with this being, we do not even possess the "equipment" necessary to comprehend its nature.

By assuming an attitude not unlike that of a love-sick suitor (who can do nothing but pine for his beloved), we trigger within ourselves an arsenal of inherent emotional responses which can be focused and amplified to such a degree that union with this abstract lover is actually achieved.



In the language of the Qabalist, we are the Heh Final (5) of the Tetragrammaton, and the Holy Guardian Angel is the Vav (6). The H. G. A. is the Prince who awakens the sleeping Princess. Once this union is realized, both we and our Angel are transformed into a higher spiritual Being who is capable of truly mastering the unbalanced forces of the lower worlds. Only then are we eligible to receive personal spiritual guidance from the only reliable source in the universe... ourselves.

The qabalistic environment of the H. G. A. is the sixth Sefirah, Tiphereth. In the A ∴ A ∴ graded system of initiation, it represents the attainment of 5° = 6°, the grade of Adeptus Minor.

The Abra-Melin operation is simple yet arduous. A house or a secured rustic environment is required. The Magician must be sufficiently independent, and self-reliant enough to continue the operation without interruption for six consecutive months. Every two months the regimen of prayer, fasting, and devotional activities increases in length and intensity, until near the end of the operation, the Magician is in a state of perpetual, all-consuming hunger for the Angel.

Shortly after the Angel's arrival, the Magician is instructed to call forth the "Four Great Princes of Evil," and compel their obedience and extract oaths of allegiance. The next day the same is done with the Eight Sub-Princes and so on until the entire population of the infernal realms have sworn their obedience and allegiance to the new "H.G.A.ized" Magician.

I am often asked why the first thing the Magician does after six months of pious aspiration for the "higher" spiritual reality, is to summon the denizens of Hell. The answer is simple. You are not operating in a vacuum. As above, so below. Your Angel has descended to vouchsafe you the grace of union. In order to complete the circuit and assure an uninterrupted flow of this divine current, you must in turn descend and transmit that same grace to the world beneath

you. If you fail to redeem, control, and train the menagerie of your lower nature, those “demons” will resurface as soon as the glow of the Angel’s presence has faded, and literally “play Hell” with you. In corporate terms, the workers will eventually revolt if management does not share with them the benefits of increased profits.

Individuals who admit to attempting the Sacred Magic of Abra-Melin, the Mage are rare. It is rarer still to find credible individuals who maintain that they have successfully executed the formal procedure. Israel Regardie once told me that, with the exception of Crowley, he knew of no one who successfully concluded an Abra-Melin operation.

Crowley made two attempts before successfully completing it. He purchased Boleskine House on the shore of Loch Ness for the expressed purpose of performing the operation. He was interrupted first in 1900, to go to Mather’s aid in Paris during the period of the collapse of the Golden Dawn, then in 1903, to marry his first wife, Rose Kelly.

When he finally succeeded, it was under the most unbelievably difficult circumstances. In 1906, while walking across China, he *mentally* performed the Invocation of the Holy Guardian Angel. The entire procedure was internalized; the temple, the furniture, the accoutrements—all visualized and projected upon the screen of his mind and held there by intense concentration. The invocations and the prayers were mentally rehearsed day after day. So focused was his concentration that at one point it took him several moments to realize that he and his pony had both fallen over a small cliff.

His success proved to him that the basic formulae and procedures of the Abra-Melin operation were viable. It also became clear that as long as the general program of “invoking often” and “enflaming” oneself in prayer was strictly followed, the particulars of the ceremony could vary considerably from those laid down in the 1458 text. It was during this period that he developed the techniques that would form the basis of what he would consider “the most powerful and exalted of all my magical instructions,” *Liber Samekh*.

On the Tree of Life, the Path of Samekh is the second segment of the Middle Pillar and connects the ninth Sephirah, Yesod (the Moon), and the sixth Sephirah, Tiphereth (the Sun). In Hebrew the letter Samekh enumerates to 60 and means a prop or a tent peg or pole. In the traditional tarot, Samekh is the Sagittarius card, Temperance, which shows Michael, the Archangel of Tiphereth, reconciling opposites by pouring Water on a Fire symbol (a lion) and Fire upon a Water symbol (an eagle). Above the Angel is the rainbow, the Biblical symbol of God's covenant with man. This rainbow represents the Veil of Paroketh which separates Sephiroth 10, 9, 8, and 7 from the rest of the Tree of Life. The Path of Samekh, like the arrow of Sagittarius, pierces the rainbow Veil of Paroketh and shoots up the middle pillar to Tiphereth, the abode of the Holy Guardian Angel.

The version of *Liber Samekh* with which we are most familiar was prepared in 1921 for the benefit of Abbey of Thelema<sup>1</sup> resident Frater Progradior (Frank Bennett). Crowley had genuine affection for this courageous Australian who had traveled to Cefalu for spiritual instruction. One afternoon while walking together to the beach, Crowley, in the course of casual conversation, said something to Bennett that instantly unknotted a personal unresolved internal conflict that had frustrated his spiritual advancement for nearly thirty years. This event triggered a trance-like state of exaltation which lasted three days.

Crowley was so pleased with Bennett's receptivity to the program that he wanted to present him with a master ritual for the invocation of the Holy Guardian Angel. *Liber Samekh* is that gift.

The scaffolding of the ceremony is Charles Wycliffe Goodwin's 1852 translation of a *Fragment of a Graeco-Egyptian*

---

<sup>1</sup> In April 1920, Crowley established a Thelemic monastery (theoretically based upon Rabelais' Abbey of Thelema) just outside of the small Sicilian beach community of Cefalu. Money problems, scandal, and an expulsion order from Mussolini put an end to the Abbey in May of 1923.

*Work upon Magic*, which Mathers included as a preliminary invocation in his translation of the *Lesser Key of Solomon, the Goetia*. It was informally known in the Golden Dawn as the “Bornless Ritual.” To this Crowley added an interpretation of the Barbarous Names “Entymologically or Qabalistically determined and paraphrased in English.”

So much for the skeleton of the ritual. Its soul is the running commentary and visualization instructions of Points II and III. Here we find detailed directions relevant to the Magician’s internalized processes. In no other work is Crowley so explicit as to what should be going on in the mind of the Magician. The ritual is performed entirely on the magical plane in the Magician’s “Body of Light.” Everything is visualized and Crowley is clear on every point.

Also buried in the comments are treasures of magical data found nowhere else in Crowley’s writings—fundamental definitions of terms, concrete explanations of abstract concepts, and other gems that serve to fill many holes in the magical education of even the most knowledgeable student.

My only criticism of *Liber Samekh* deals not with the ritual but its original format. I must confess when I first began to study it, I concluded I would never be able to construct a workable ritual from the material. Important comments and directions vital to the understanding of the ceremony are distractingly scattered throughout the two essays (Points II and III) at the end of the ritual itself, and there are other aspects of its organization that make initial study awkward and time consuming. Several years ago I decided to do something about it and organized two versions of *Liber Samekh* in my magical diary as follows:

- 1) A Study Version—which includes Point I exactly as the original but underneath each section and each line of the text, I copied the descriptive comments from Point II. This enabled my poor linear brain to actually see what Crowley is talking about.

2) A Working Version—which serves as a practical script, displaying only the words, directions, and diagrams necessary to actually memorize and begin rehearsing the ceremony.

I have taken the liberty of presenting *Liber Samekh* as I have described above. For those who may object that this is a blasphemous act of savage editing, I assure them that not one word of *Liber Samekh* has been removed, and that each comment from Point II is placed precisely where it is referenced by Crowley to Point I.

The Working Ritual which follows is clearly titled as an edited text and the accompanying comments and diagrams are suggested from Crowley's notes.

Before we procede to examine *Liber Samekh*, I feel it is necessary to say a few words about Crowley's intepretation of the Barbarous Names which were part of the original *Fragment of a Graeco-Egyptian Work upon Magic*.

Theoretically such "magick words" are efficacious *because* they are unintelligible. The rational mind is transcended, and the magical plane is accessed as the Magician babbles a string of strange sounding words and phrases. Interpreting the words would seem to defeat this process, and there are many practitioners who feel this was an unnecessary exercise on Crowley's part.

Personally, being familiar with Crowley's analysis of the Names has neither helped nor hindered my appreciation of the ritual. The Names still sound wierd and mysterious and establish a powerful and irrational magical environment.

If any harm has been done by Crowley's treatment of the Names, it has not to been to the serious student but to the diletante who, thumbing through the text, sees things like "*Thou Satan-Sun...*" and "*Satan, my Lord! The Lust of the Goat!*" More than one "cult crime expert" has quoted this section (out of context) on television talk shows in an attempt to prove Crowley was an evil satanist.

For the dear reader who has come with me thus far, I think it is hardly necessary for me to take any more time

defending Crowley's honor. A careful study of his work does an infinitely better job than I ever could. Even a beginning student of the Qabalah can easily see how Crowley arrived at the various compound meanings to the Names. He analyzed them by letter as if each were spelled in Hebrew. To each Hebrew letter is attributed a meaning, a number, a tarot trump, and a host of other qabalistic correspondences. **A** = Aleph = the letter of breath; **R** = Resh = the Sun card; therefore **AR** = "O breathing, flowing Sun."

Satan usually pops up when the letter **O** takes center stage. **O** = Ayin = the Eye = Capricorn, the Goat = the Devil card. **OOO** = "Satan, thou Eye, thou Lust!" repeated three times. It's as simple as that.

As for an initiated interpretation of the word Satan, Crowley gives us the following from Chapter Five of *Magick in Theory and Practice*.

"O—The exalted "Devil" (also the other secret Eye) by the formula of the Initiation of Horus elsewhere described in detail. This "Devil" is called Satan or Shaitan, and regarded with horror by people who are ignorant of his formula, and, imagining themselves to be evil, accuse Nature herself of their own phantasmal crime. Satan is Saturn, Set, Abrasax, Adad, Adonis, Attis, Adam, Adonai, etc. The most serious charge against him is only that he is the Sun in the South. The Ancient Initiates, dwelling as they did in lands whose blood was the water of the Nile or the Euphrates, connected the South with life-withering heat, and cursed that quarter where the solar darts were deadliest. Even in the legend of Hiram, it is at high noon that he is stricken down and slain. Capricornus is moreover the sign which the Sun enters when he reaches his extreme Southern declination at the Winter Solstice, the season of the death of vegetation, for the folk of the Northern hemisphere. This gave them a second cause of cursing the South. A third; the tyranny of hot, dry, poisonous winds; the menace of deserts of oceans dreadful because mysterious and impassable, these also were connected in their minds with the South.

But to us, aware of astronomical facts, this antagonism to the South is a silly superstition which the accidents of their local conditions suggested to our animistic ancestors. We see no enmity between Right and Left, Up and Down, and similar pairs of opposites. These antitheses are real only as a statement of relation; they are the conventions of an arbitrary device for representing our ideas in a pluralistic symbolism based on duality. "Good" must be defined in terms of human ideals and instincts. "East" has no meaning except with reference to the earth's internal affairs; as an absolute direction in space it changes a degree every four minutes. "Up" is the same for no two men, unless one chance to be in the line joining the other with the centre of the earth. "Hard" is the private opinion of our muscles. "True" is an utterly unintelligible epithet which has proved refractory to the analysis of our ablest philosopher.

"We have therefore no scruple in restoring the "devil-worship" of such ideas as those which the laws of sound, and the phenomena of speech and hearing, compel us to connect with the group of "Gods" whose names are based upon ShT or D, vocalized by the free breath A. For these Names imply the qualities of courage, frankness, energy, pride, power and triumph; they are the words which express the creative and paternal will.

"Thus "the Devil" is Capricornus, the Goat who leaps upon the loftiest mountains, the Godhead which, if it become manifest in man, makes him Aegipan, the All.

"The Sun enters this sign when he turns to renew the year in the North. He is also the vowel O, proper to roar, to boom, and to command, being a forcible breath controlled by the firm circle of the mouth.

"He is the Open Eye of the exalted Sun, before whom all shadows flee away: also that Secret Eye, which makes an image of its God, the Light, and gives it power to utter oracles, enlightening the mind.

“Thus, he is Man made God, exalted, eager; he has come consciously to his full stature, and so is ready to set out on his journey to redeem the world. But he may not appear in this true form; the Vision of Pan would drive men mad with fear. He must conceal Himself in his original guise.”



I hope that the reader will find the following more user friendly versions of *Liber Samekh* helpful adjuncts to their study of this most important ritual work.



**LIBER SAMEKH  
THEURGIA GOETIA SUMMA  
(CONGRESSUS CUM DAEMONE)  
SUB FIGURA DCCC**

being the Ritual employed by the Beast 666 for the Attainment of the Knowledge and Conversation of his Holy Guardian Angel during the Semester of His performance of the Operation of the Sacred Magick of ABRAMELIN THE MAGE.

(Prepared An XVII Sol in Virgo at the Abbey of Thelema in Cephalaedium by the Beast 666 in service to FRATER PROGRADIOR.)

OFFICIAL PUBLICATION of A ∴ A ∴. Class D for the Grade of Adeptus Minor.

POINT  
I

EVANGELII TEXTUS REDACTUS

POINT  
II

ARS CONGRESSUS CUM DAEMONE

*The Invocation*

Magically restored, with the significance of the BARBAROUS NAMES Etymologically or Qabalistically determined and paraphrased in English.

### **Section A: The Oath.**

[Let the Adeptus Minor be standing in his circle on the square of Tiphereth, armed with his Wand and Cup; but let him perform the Ritual throughout in his Body of Light. He may burn the Cakes of Light, or the Incense of Abramelin; he may be prepared by Liber CLXXV, the reading of Liber LXV, and by the practices of Yoga. He may invoke HADIT by “wine and strange drugs” if he so will.<sup>2</sup> He prepares the circle by the usual formulae of Banishing and Consecration, etc.

He recites Section A as a rehearsal before His Holy Guardian Angel of the attributes of that Angel. Each phrase must be realized with full concentration of force, so as to make Samadhi as perfectly as possible upon the truth proclaimed.]

#### **1. Thee I invoke, the Bornless One.**

[He identifies his Angel with the Ain Soph, and the Kether thereof; one formulation of Hadit in the boundless Body of Nuith.]

#### **2. Thee, that didst create the Earth and the Heavens.**

#### **3. Thee, that didst create the Night and the Day.**

#### **4. Thee, that didst create the darkness and the Light.**

[He asserts that His Angel has created (for the purpose of self-realization through projection in conditioned Form) three pairs of opposites: a) The Fixed and the Volatile; b) The Unmanifested and the Manifest; and c) the Unmoved and the Moved. Otherwise, the Negative and the Positive in respect of Matter, Mind and Motion.]

---

<sup>2</sup> Any such formula should be used only when the adept has full knowledge based on experience of the management of such matters.

**5. Thou art ASAR UN-NEFER (Myself made perfect):  
Whom no man hath seen at any time.**

[He acclaim his Angel as "Himself Made Perfect"; adding that this Individuality is inscrutable and inviolable. In the Neophyte Ritual of G .: D .: (as it is printed in *The Equinox I, II*, for the old aeon) the Hierophant is the perfected Osiris, who brings the candidate, the natural Osiris, to identity with himself. But in the new Aeon the Hierophant is Horus (Liber CCXX, I. 49) therefore the Candidate will be Horus too. What then is the formula of the initiation of Horus? It will no longer be that of the Man, through Death. It will be the natural growth of the Child. His experiences will no more be regarded as catastrophic. Their hieroglyph is the Fool: the innocent and impotent Harpocrates Babe becomes the Horus Adult by obtaining the Wand. "Der reine Thor" seizes the Sacred Lance. Bacchus becomes Pan. The Holy Guardian Angel is the Unconscious Creature Self—the Spiritual Phallus. His knowledge and Conversation contributes occult puberty. It is therefore advisable to replace the name Asar Un-nefer by that of Ra-Hoor-Khuit at the outset, and by that of one's own Holy Guardian Angel when it has been communicated.]

**6. Thou art IA-BESZ (the Truth in Matter).**

[He hails Him as BESZ, the Matter that destroys and devours Godhead, for the purpose of the Incarnation of any God.]

**7. Thou art IA-APOPHRASZ (the Truth in Motion).**

[He hails Him as APOPHRASZ, the Motion that destroys and devours Godhead, for the purpose of the Incarnation of any God. The combined action of these two DEVILS is to allow the God upon whom they prey to enter into enjoyment of existence through the Sacrament of dividual "Life" (Bread—the flesh of BESZ) and "Love" (Wine—the blood or venom of APOPHRASZ).]

**8. Thou has distinguished between the Just and the Unjust.**

[He acclaim His Angel as having "eaten of the Fruit of the Tree of Knowledge of Good and Evil"; otherwise having become wise (in the Dyad, Chokmah) to apprehend the formula of Equilibrium which is now His own, being able to apply Himself accurately to His self-appointed environment.]

**9. Thou didst make the Female and the Male.**

[He acclaim His Angel as having laid down the Law of Love as the Magical formula of the Universe, that He may resolve the phenomenal again into its noumenal phase by uniting any two opposites in ecstatic passion.]

**10. Thou didst produce the Seeds and the Fruit.**

[He acclaim His Angel as having appointed that this formula of Love should effect not only the dissolution of the separateness of the Lovers into His own impersonal Godhead, but their co-ordination in a "Child" quintessentialized from its parents to constitute a higher order of Being than theirs, so that each generation is an alchemical progress towards perfection in the direction of successive complexities. As Line 9 asserts Involution, Line 10 asserts Evolution.]

**11. Thou didst form Men to love one another, and to hate one another.**

[He acclaim His Angel as having devised this method of self-realization; the object of Incarnation is to obtain its reactions to its relations with other incarnated Beings and to observe theirs with each other.]

**Section Aa.**

**1. I am ANKH-F-N-KHONSU thy Prophet, unto Whom Thou didst commit Thy Mysteries, the Ceremonies of KHEM.**

[The Adept asserts his right to enter into conscious communication with His Angel, on the ground that that Angel has Himself taught him the Secret Magick by which he may make the proper link. "Mosheh"<sup>3</sup> is M H, the formation, in Jechidah, Chiah, Neschamah, Ruach,—the Sephiroth from Kether to Yesod—since 45 is  $\Sigma$  1-9 while Sh, 300, is  $\Sigma$  1-24, which superadds to these Nine an extra Fifteen numbers. (See in Liber D the meanings and correspondences of 9, 15, 24, 45, 300, 345.)

45 is moreover A D M, man. "Mosheh" is thus the name of man as a God-concealing Form. But in the Ritual let the Adept replace this "Mosheh" by his own motto as Adeptus Minor. For "Ishrael" let him prefer his own Magical Race, according to the obligations of his Oaths to Our Holy Order! (The Beast 666 Himself used "Ankh-f-n-khonsu" and 'Khem' in this section.)]

**2. Thou didst produce the moist and the dry, and that which nourisheth all created Life.**

[The Adept reminds his Angel that He has created That One Substance of which Hermes hath written in the Table of Emerald, whose virtue is to unite in itself all opposite modes of Being, thereby to serve as a Talisman charged with the Spiritual Energy of Existence, an Elixir or Stone composed of the physical basis of Life. This Commemoration is placed between the two personal appeals to the Angel, as if to claim privilege to partake of this Eucharist which createth, sustaineth and redeemeth all things.]

**3. Hear Thou Me, for I am the Angel of PTAH-APO-PHRASZ-RA (vide the Rubric): this is Thy True Name, handed down to the Prophets of KHEM.**

<sup>3</sup> In the 1904 version of the Preliminary Invocation of the Goetia (the text that forms the basis of *Liber Samekh*) the name "Mosheh" was used instead of Ankh-f-n-khonsu, and "Ishrael" instead of Khem.—*Ed.*

[He now asserts that he is himself the “Angel” or messenger of his Angel; that is, that he is a mind and body whose office is to receive and transmit the Word of his Angel. He hails his Angel not only as “un-nefer” the Perfection of “Asar” himself as a man, but as Ptah-Apophrasz-Ra, the identity (Hadit) wrapped in the Dragon (Nuith) and thereby manifested as a Sun (Ra-Hoor-Khuit). The “Egg” (or Heart) “girt with a Serpent” is a cognate symbol; the idea is thus expressed later in the ritual. (See Liber LXV which expands this to the uttermost.)]

### Section B: Air.

[The Adept passes from contemplation to action in the sections now following B to Gg. He is to travel astrally around the circle, making the appropriate pentagrams, sigils, and signs. His direction is widdershins. He thus makes three curves, each covering three-fourths of the circle. He should give the sign of the Enterer on passing the Kiblah, or Direction of Boleskine. This picks up the Force naturally radiating from that point<sup>4</sup> and projects it in the direction of the path of the Magician. The sigils are those given in *The Equinox* Vol. I, No. 7, Plate X outside the square; the signs those shewn in Vol. I, No. 2, Plate “The Signs of the Grades”. In these invocations he should expand his girth and his stature to the utmost,<sup>5</sup> assuming the form and the consciousness of the Elemental God of the quarter. After this, he begins to vibrate the “Barbarous Names” of the Ritual.

Now let him not only fill his whole being to the uttermost with the force of the Names; but let him formulate his Will, understood thoroughly as the dynamic aspect of his Creative Self, in an appearance symbolically apt, I say not in the form of a Ray of Light, of a Fiery Sword, or of aught

<sup>4</sup> This is an assumption based on *Liber Legis II*, 78 and III, 34.

<sup>5</sup> Having experience of success in the practices of Liber 536, βατραχο-φρενοθεοχοσμομαχια.

save that bodily Vehicle of the Holy Ghost which is sacred to BAPHOMET, by its virtue that concealeth the Lion and the Serpent that His Image may appear adorably upon the Earth for ever.

Let then the Adept extend his Will beyond the Circle in this imagined Shape and let it radiate with the Light proper to the Element invoked, and let each Word issue along the shaft with passionate impulse, as if its voice gave command thereto that it should thrust itself leapingly forward. Let also each Word accumulate authority, so that the Head of the Shaft may plunge twice as far for Second Word as for the First, and Four Times for the Third as the Second, and thus to the end. Moreover, let the Adept fling forth his whole consciousness thither. Then at the final Word, let him bring rushing back his Will within himself, steadily streaming, and let him offer himself to its points, as Artemis to PAN, that this perfectly pure concentration of the Element purge him thoroughly, and possess him with its passion.

In this Sacrament being wholly at one with that Element, let the Adept utter the Charge "Hear me, and make", etc. with strong sense that this unity with that quarter of the Universe confers upon him the fullest freedom and privilege appurtenant thereto.]

**Hear Me:**

**AR** (O breathing, flowing Sun!)

**ThIAF<sup>6</sup>** (O Sun IAF! O Lion-Serpent Sun, The Beast that whirlst forth, a thunderbolt, begetter of Life!)

**RhEIBET** (Thou that flowest! Thou that goest!)

**A-TheLE-BER-SET** (Thou Satan-Sun Hadith that goest without Will!)

---

<sup>6</sup> The letter F is used to represent the Hebrew Vau and the Greek Digamma; its sound lies between those of the English long *o* and long *oo*, as in Rope and Tooth.

**A** (Thou Air! Breath! Spirit! Thou without bound or bond!)

**BELAThA** (Thou Essence, Air Swift-streaming, Elasticity!)

**ABEU** (Thou Wanderer, Father of All!)

**EBEU** (Thou Wanderer, Spirit of All!)

**Phi-ThETA-SOE** (Thou Shining Force of Breath! Thou Lion-Serpent Sun! Thou Saviour, save!)

**IB** (Thou Ibis, secret solitary Bird, inviolate Wisdom, whose Word is Truth, creating the World by its Magick!)

**ThIAF** (O Sun IAF! O Lion-Serpent Sun, The Beast that whirlst forth, a thunderbolt, begetter of life!)

(The conception is of Air, glowing, inhabited by a Solar-Phallic Bird, 'the Holy Ghost' of a Mercurial Nature.)

**Hear Me, and make all Spirits subject unto Me; so that every Spirit of the Firmament and of the Ether: upon the Earth and under the Earth, on dry land and in the water; of Whirling Air, and of rushing Fire, and every Spell and Scourge of God may be obedient unto Me.**

[Let the Adept take note of the wording of the Charge. The "Firmament" is the Ruach, the 'mental plane'; it is the realm of Shu, or Zeus, where revolves the Wheel of the Gunas, the Three forms<sup>7</sup> of Being. The Aethyr is the "akasha", the

---

<sup>7</sup> They correspond to the Sulphur, Salt, and Mercury of Alchemy; to Rajas, Tamas, and Sattvas in the Hindu system; and are rather modes of action than actual qualities even when conceived as latent. They are the apparatus of communication between the planes; as such, they are conventions. There is no absolute validity in any means of mental apprehension; but unless we make these spirits of the Firmament subject unto us by establishing right relation (within the possible limits) with the Universe, we shall fall into error when we develop our new instrument of direct understanding. It is vital that the Adept should train his intellectual faculties to the truth, in the measure of their capacity. To despise the mind on account



“Spirit”, the Aethyr of physics, which is the framework on which all forms are founded; it receives, records and transmits all impulses without itself suffering mutation thereby. The “Earth” is the sphere wherein the operation of these “fundamental” and aethyric forces appears to perception. “Under the Earth” is the world of those phenomena which inform those perceived projections, and determine their particular character. “Dry land” is the place of dead “material things”, dry (i.e., unknowable) because unable to act on our minds. “Water” is the vehicle whereby we feel such things; “air” their menstruum wherein these feelings are mentally

---

of its limitations is the most disastrous blunder; it is the common cause of the calamities which strew so many shores with the wreckage of the Mystic Armada. Bigotry, Arrogance, Bewilderment, all forms of mental and moral disorder, so often observed in people of great spiritual attainment, have brought the Path itself into discredit; almost all such catastrophes are due to trying to build the Temple of the Spirit without proper attention to the mental laws of structure and the physical necessities of foundation. The mind must be brought to its utmost pitch of perfection, but according to its own internal properties; one cannot feed a microscope on mutton chops. It must be regarded as a mechanical instrument of knowledge, independent of the personality of its possessor. One must treat it exactly as one treats one’s electroscope or one’s eyes; one influence of one’s wishes. A physician calls in a colleague to attend to his own family, knowing that personal anxiety may derange his judgment. A microscopist who trusts his eyes when his pet theory is at stake may falsify the facts, and find too late that he has made a fool of himself.

In the case of initiation itself, history is scarred with the wounds inflicted by this Dagger. It reminds us constantly of the danger of relying upon the intellectual faculties. A judge must know the law in every point, and be detached from personal prejudices, and incorruptible, or iniquity will triumph. Dogma, with persecution, delusion, paralysis of progress, and many another evil, as its satraps, has always established a tyranny when Genius has proclaimed it. Islam making a bonfire of written Wisdom, and Haeckel forging biological evidence; physicists ignorant of radioactivity disputing the conclusions of geology, and theologians impatient of truth struggling against the tide of thought; all such must perish at the hands of their own error in making their minds, internally defective or externally deflected, the measure of the Universe.

apprehended. It is called "whirling" because of the instability of thought, and the fatuity of reason, on which we are yet dependent for what we call "life". "Rushing Fire" is the world in which wandering thought burns up to swift-darting Will. These four stages explain how the non-Ego is transmuted into the Ego. A "Spell" of God is any form of consciousness, and a "Scourge" any form of action.

The Charge, as a whole, demands for the Adept the control of every detail of the Universe which His Angel has created as a means of manifesting Himself to Himself. It covers command of the primary projection of the Possible in individuality, in the antithetical artifice which is the device of Mind, and in a balanced triplicity of modes or states of being whose combinations constitute the characteristics of Cosmos. It includes also a standard of structure, a rigidity to make reference possible. Upon these foundations of condition which are not things in themselves, but the cannon to which things conform, is builded the Temple of Being, whose materials are themselves perfectly mysterious, inscrutable as the Soul, and like the Soul imagining themselves by symbols which we may feel, perceive, and adapt to our use without ever knowing the whole Truth about them. The Adept sums up all these items by claiming authority over every form of expression possible to Existence, whether it be a "spell" (idea) or a "scourge" (act) of "God", that is, of himself. The Adept must accept every "spirit", every "spell", every "scourge", as part of his environment, and make them all "subject to" himself; that is, consider them as contributory causes of himself. They have made him what he is. They correspond exactly to his own faculties. They are all—ultimately—of equal importance. The fact that he is what he is proves that each item is equilibrated. The impact of each new impression affects the entire system in due measure. He must therefore realize that every event is subject to him. It occurs because he had need of it. Iron rusts because the molecules demand oxygen for the satisfaction of their tendencies. They do not crave hydrogen; therefore combina-

tion with that gas is an event which does not happen. All experiences contribute to make us complete in ourselves. We feel ourselves subject to them so long as we fail to recognize this; when we do, we perceive that they are subject to us. And whenever we strive to evade an experience, whatever it may be, we thereby do wrong to ourselves. We thwart our own tendencies. To live is to change; and to oppose change is to revolt against the law which we have enacted to govern our lives. To resent destiny is thus to abdicate our sovereignty and to invoke death. Indeed, we have decreed the doom of death for every breach of the law of life. And every failure to incorporate any impression starves the particular faculty which stood in need of it.

This Section B invokes Air in the East, with a shaft of golden glory.]

### **Section C: Fire.**

[The adept now invokes Fire in the South; flame red are the rays that burst from his Verendum.]

### **I invoke Thee, the Terrible and Invisible God: Who dwellest in the Void Place of the Spirit:**

**AR-O-GO-GO-RU-ABRAO** (Thou spiritual Sun! Satan, Thou Eye, Thou Lust! Cry aloud! Cry aloud! Whirl the Wheel, O my Father, O Satan, O Sun!)

**SOTOU** (Thou, the Saviour!)

**MUDORIO** (Silence! Give me Thy Secret!)

**PhALARThAO** (Give me suck, Thou Phallus, Thou Sun!)

**OOO** (Satan, thou Eye, thou Lust! Satan, thou Eye, thou Lust! Satan, thou Eye, thou Lust!)

**AEPE** (Thou self-caused, self-determined, exalted, Most High!)

**The Bornless One** (Vide Supra).

(The conception is of Fire, glowing, inhabited by a Solar-Phallic Lion of a Uranian nature.)

**Hear Me, and make all Spirits subject unto Me; so that every Spirit of the Firmament and of the Ether: upon the Earth and under the Earth, on dry Land and in the Water: of Whirling Air, and of rushing Fire, and every Spell and Scourge of God may be obedient unto Me.**

**Section D: Water.**

[He invokes Water in the West, his Wand billowing forth blue radiance.]

**Hear Me:**

**RU-ABRA-IAF**<sup>8</sup> (Thou the Wheel, thou the Womb, that containeth the Father IAF!)

**MRIODOM** (Thou the Sea, the Abode!)

**BABALON-BAL-BIN-ABAFT** (Babalon! Thou Woman of Whoredom! Thou, Gate of the Great God ON! Thou Lady of the Understanding of the Ways!)

**ASAL-ON-AI** (Hail Thou, the unstirred! Hail, sister and bride of ON, of the God that is all and is none, by the Power of Eleven!)

**APhEN-IAF** (Thou Treasure of IAO!)

**I** (Thou Virgin twin-sexed! Thou Secret Seed! Thou inviolate Wisdom!)

**PhOTETH** (Abode of the Light)

---

<sup>8</sup> See, for the formula of IAF, or rather FIAOF, *Book 4 Part III, Chapter V*. The form FIAOF will be found preferable in practice.

**ABRASAX** (...of the Father, the Sun, of Hadith, of the spell of the Aeon of Horus!)

**AEOOU** (Our Lady of the Western Gate of Heaven!)

**ISChURE** (Mighty art Thou!)

**Mighty and Bornless One** (Vide Supra!)

(The conception is of Water, glowing, inhabited by a Solar-Phallic Dragon-Serpent, of a Neptunian nature.)

**Hear Me: and make all Spirits subject unto Me: so that every Spirit of the Firmament and of the Ether: upon the Earth and under the Earth: on dry Land and in the Water: of Whirling Air, and of rushing Fire: and every Spell and Scourge of God may be obedient unto Me.**

#### **Section E: Earth.**

[He goes to the North to invoke Earth; flowers of green flame flash from his weapon. As practice makes the Adept perfect in this Work it becomes automatic to attach all these complicated ideas and intentions to their correlated words and acts. When this is attained he may go deeper into the formula by amplifying its correspondences. Thus, he may invoke water in the manner of water, extending his will with majestic and irresistible motion, mindful of its impulse gravitation, yet with a suave and tranquil appearance of weakness. Again, he may apply the formula of water to its peculiar purpose as it surges back into his sphere, using it with conscious skill for the cleansing and calming of the receptive and emotional elements in his character, and for the solution or sweeping away of those tangled weeds of prejudice which hamper him from freedom to act as he will. Similar applications of the remaining invocations will occur to the Adept who is ready to use them.]

**I invoke Thee:**

**MA** (O Mother! O Truth!)

**BARRAIO** (Thou Mass!<sup>9</sup>)

**IOEL** (Hail, Thou that art!)

**KOThA** (Thou hollow one!)

**AThOR-e-BAL-O** (Thou Goddess of Beauty and Love, whom Satan, beholding, desireth!)

**ABRAFT** (The Fathers, male-female, desire Thee!)

(The conception is of Earth, glowing, inhabited by a Solar-Phallic Hippopotamus<sup>10</sup> of a Veneral nature.)

**Hear Me: and make all Spirits subject unto Me: so that every Spirit of the Firmament and of the Ether: upon the Earth and under the Earth: on dry Land and in the Water: of Whirling Air, and of rushing Fire: and every Spell and Scourge of God may be obedient unto Me.**

### **Section F: Spirit.**

[The Adept now returns to the Tiphereth square of his Tau, and invokes Spirit, facing toward Boleskine, by the active Pentagrams, the sigil called the Mark of the Beast, and the Signs of L.V.X. He then vibrates the Names extending his will in the same way as before, but vertically upward. At the same time he expands the Source of that Will—the secret symbol of Self—both about him and below, as if to affirm that Self, duplex as is its form, reluctant to acquiesce in its failure to coincide with the Sphere of Nuith. Let him now

---

<sup>9</sup> "Mass," in the sense of the word which is used by physicists. The impossibility of defining it will not deter the intrepid initiate (in view of the fact that the fundamental conception is beyond the normal categories of reason).

<sup>10</sup> Sacred to AHAThOOR. The idea is that of the Female conceived as invulnerable, reposeful, of enormous swallowing capacity, etc.

imagine, at the last Word, that the Head of his will, where his consciousness is fixed, opens its fissure (the Brahmarandra-Cakra, at the junction of the cranial sutures) and exudes a drop of clear crystalline dew, and that this pearl is his Soul, a virgin offering to his Angel, pressed forth from his being by the intensity of his Aspiration.]

**Hear Me:**

**AFT** (Male-Female Spirits!)

**ABAFT** (Male-Female Sires!)

**BAS-AUMGN** (Ye that are Gods, going forth, uttering AUMGN. The Word that goeth from (A) Free Breath, (U) through Willed Breath, (M) and Stopped Breath, (GN) to Continuous Breath; thus symbolizing the whole course of spiritual life. A is the formless Hero; U is the six-fold solar sound of physical life, the triangle of Soul being entwined with that of Body; M is the silence of "death"; GN is the nasal sound of generation & knowledge.)

**ISAK** (Identical Point!)

**SA-BA-FT** (Nuith! Hadith! Ra-Hoor-Khuit! Hail, Great Wild Beast! Hail, IAO!)

**Section Ff.**

[With these words the Adept does not withdraw his will within him as in the previous Sections. He thinks of them as a reflection of Truth on the surface of the dew, where his Soul hides trembling. He takes them to be the first formation in his consciousness of the nature of His Holy Guardian Angel.]

**1. This is the Lord of the Gods:**

[The "Gods" include all the conscious elements of his nature.]

**2. This is the Lord of the Universe:**

[The 'Universe' includes all possible phenomena of which he can be aware.]

**3. This is He whom the Winds fear.**

[The "Winds" are his thoughts, which have prevented him from attaining to his Angel.]

**4. This is He, Who having made Voice by His commandment is Lord of all Things; King, Ruler and Helper. Hear Me, and make all Spirits subject unto Me: so that every Spirit of the Firmament and of the Ether: upon the Earth and under the Earth: on dry Land and in the Water: of Whirling Air, and of rushing Fire: and every Spell and Scourge of God may be obedient unto Me.**

[His Angel has made "Voice", the magical weapon which produces "Words", and these words have been the wisdom by which He hath created all things. The "Voice" is necessary as the link between the Adept and his Angel. The Angel is "King", the One who "can", the "source of authority and the fount of honour"; also the King (or King's Son) who delivers the Enchanted Princess, and makes her his Queen. He is "Ruler", the "unconscious Will"; to be thwarted no more by the ignorant and capricious false will of the conscious man. And He is "Helper", the author of the infallible impulse that sends the Soul sweeping along the skies on its proper path with such impetus that the attraction of alien orbs is no longer sufficient to swerve it. The "Hear me" clause is now uttered by the normal human consciousness, withdrawn to the physical body; the Adept must deliberately abandon his attainment, because it is not yet his whole being which burns up before the Beloved.]

**Section G: Spirit.**

[The Adept, though withdrawn, shall have maintained the Extension of his Symbol. He now repeats the signs as before,



save that he makes the Passive Invoking Pentagram of Spirit. He concentrates his consciousness within his Twin-Symbol of Self, and endeavours to send it to sleep. But if the operation be performed properly, his Angel shall have accepted the offering of Dew, and seized with fervour upon the extended symbol of Will towards Himself. This then shall He shake vehemently with vibrations of love reverberating with the Words of the Section. Even in the physical ears of the adept there shall resound an echo thereof, yet he shall not be able to describe it. It shall seem both louder than thunder, and softer than the whisper of the night-wind. It shall at once be inarticulate, and mean more than he hath ever heard.

Now let him strive with all the strength of his Soul to withstand the Will of his Angel, concealing himself in the closest cell of the citadel of consciousness. Let him consecrate himself to resist the assault of the Voice and the Vibration until his consciousness faint away into Nothing. For if there abide unabsorbed even one single atom of the false Ego, that atom should stain the virginity of the True Self and profane the Oath; then that atom should be so inflamed by the approach of the Angel that it should overwhelm the rest of the mind, tyrannize over it, and become an insane despot to the total ruin of the realm.

But, all being dead to sense, who then is able to strive against the Angel? He shall intensify the stress of His Spirit so that His loyal legions of Lion-Serpents leap from the ambush, awakening the adept to witness their Will and sweep him with them in their enthusiasm, so that he consciously partakes their purpose, and sees in its simplicity the solution of all his perplexities. Thus then shall the Adept be aware that he is being swept away through the column of his Will Symbol, and that His Angel is indeed himself, with intimacy so intense as to become identity, and that not in a single Ego, but in every unconscious element that shares in that manifold uprush.

This rapture is accompanied by a tempest of brilliant light, almost always, and also in many cases by an outburst

of sound, stupendous and sublime in all cases, though its character may vary within wide limits.<sup>11</sup>

The spate of stars shoots from the head of the Will-Symbol, and is scattered over the sky in glittering galaxies. This dispersion destroys the concentration of the adept, whose mind cannot master such multiplicity of majesty; as a rule, he simply sinks stunned into normality, to recall nothing of his experience but a vague though vivid impression of complete release and ineffable rapture. Repetition fortifies him to realize the nature of his attainment; and his Angel, the link once made, frequents him, and trains him subtly to be sensitive to his Holy presence, and persuasion. But it may occur, especially after repeated success, that the Adept is not flung back into his mortality by the explosion of the Starspate, but identified with one particular "Lion-Serpent", continuing conscious thereof until it finds its proper place in Space, when its secret self flowers forth as a truth, which the Adept may then take back to earth with him.

This is but a side issue. The main purpose of the Ritual is to establish the relation of the subconscious self with the Angel in such a way that the Adept is aware that his Angel is the Unity which expresses the sum of the Elements of that Self, that his normal consciousness contains alien enemies introduced by the accidents of environment, and that his Knowledge and Conversation of His Holy Guardian Angel destroys all doubts and delusions, confers all blessings, teaches all truth, and contains all delights. But it is important that the Adept should not rest in mere inexpressible realization of his rapture, but rouse himself to make the relation submit to analysis, to render it in rational terms, and thereby enlighten his mind and heart in a sense as superior to fanatical enthusiasm as Beethoven's music is to West African war-drums.]

---

<sup>11</sup> These phenomena are not wholly subjective; they may be perceived, though often under other forms, by even the ordinary man.

**Hear Me:**

**IEOU** (Indwelling Sun of Myself)

**PUR** (Thou Fire! Thou Sixfold Star initiator compassed about with Force and Fire!)

**IOU** (Indwelling Soul of Myself)

**PUR** [Vide Supra]

**IAFTh** (Sun-lion Serpent, hail! All Hail, thou Great Wild Beast, thou IAO!)

**IAEO** (Breaths of my Soul, breaths of mine Angel.)

**IOOU** (Lust of my Soul, lust of mine Angel!)

**ABRASAX** [Vide Supra]

**SABRIAM** (Ho for the Sangraal! Ho for the Cup of Babalon! Ho for mine Angel pouring Himself forth within my Soul!)

**OO** (The Eye! Satan, my Lord! The Lust of the Goat!)

**FF** (Mine Angel! Mine initiator! Thou one with me—the Sixfold Star!)

**AD-ON-A-I**<sup>12</sup> (My Lord! My secret self beyond self, Hadith, All Father! Hail, ON, thou Sun, thou Life of Man, thou Fivefold Sword of Flame! Thou Goat exalted upon Earth in Lust, thou Snake extended upon Earth in life! Spirit most holy! Seed most wise! Innocent babe. Inviolat Maid! Begetter

---

<sup>12</sup> In Hebrew, ADNI, 65. The Gnostic Initiates transliterated it to imply their own secret formulae; we follow so excellent an example. ON is an Arcanum of Arcana; its significance is taught, gradually in the O.T.O. Also AD is the paternal formula, Hadit; ON is its complement NUIT; the final Yod signifies “mine” etymologically and essentially the Mercurial (transmitted) hermaphroditic virginal seed—The Hermit of the Taro—The use of the name is therefore to invoke one’s own inmost secrecy, considered as the result of the conjunction of Nuit and Hadit. If a second A is included, its import is to affirm the operation of the Holy Ghost and the formulation of the Babe in the Egg, which precedes the appearance of the Hermit.

of Being! Soul of all Souls! Word of all Words, Come forth,  
most hidden Light!)

**EDE** (Devour thou me!)

**EDU** (Thou dost devour Me!)

**ANGELOS TON ThEON** (Thou Angel of the Gods!)

**ANLALA** (Arise thou in Me, free flowing, Thou who art  
Naught, who art Naught, and utter thy Word!)

**LAI** (I also am Naught! I Will Thee! I behold Thee! My  
nothingness!)

**GAIA** (Leap up, thou Earth!) [This is also an agonizing  
appeal to the Earth, the Mother; for at this point of the cere-  
mony the Adept should be torn from his mortal attachments,  
and die to himself in the orgasm of his operation.<sup>13</sup>]

**AEPE** (Thou Exalted One! It [i.e., the spiritual "semen", the  
Adept's secret ideas, drawn irresistibly from their "Hell"<sup>14</sup>  
by the love of his Angel] leaps up; it leaps forth!<sup>15</sup>)

**DIATHARNA THORON** (Lo! the outsplashing of the seeds  
of Immortality!)

### **Section Gg: The Attainment.**

[The adept should have realized that his Act of Union with  
the angel implies (1) the death of his old mind save in so far  
as his unconscious elements preserve its memory when they  
absorb it, and (2) the death of his unconscious elements them-  
selves. But their death is rather a going forth to renew their  
life through love. He then, by conscious comprehension of

---

<sup>13</sup> A thorough comprehension of psycho-analysis will contribute notably to  
the proper appreciation of this Ritual.

<sup>14</sup> It is said among men that the word Hell deriveth from the word "helan,"  
to hele or conceal, in the tongue of the Anglo-Saxons. That is, it is the con-  
cealed place, which since all things are in thine own self, is the uncon-  
scious, *Liber CXI (Aleph)* chap. Δ ζ.

<sup>15</sup> But compare the use of the same word in section C.

them separately and together, becomes the "Angel" of his Angel, as Hermes is the Word of Zeus, whose own voice is Thunder. Thus in this section the adept utters articulately so far as words may, what his Angel is to Himself. He says this, with his Scin-Laeca wholly withdrawn into his physical body, constraining His Angel to indwell his heart.]

**1. I am He! the Bornless Spirit! having sight in the feet: Strong, and the Immortal Fire!**

["I am He" asserts the destruction of the sense of separateness between self and Self. It affirms existence, but of the third person only. "The Bornless Spirit" is free of all space, "having sight in the feet" that they may choose their own path. "Strong" is GBR, the Magician escorted by the Sun and the Moon (See Liber D and *Liber 777*). The "Immortal Fire" is the creative Self; impersonal energy cannot perish, no matter what forms it assumes. Combustion is Love.]

**2. I am He! the Truth!**

["Truth" is the necessary relation of any two things; therefore, although it implies duality, it enables us to conceive of two things as being one thing such that it demands to be defined by complementals. Thus, an hyperbola is a simple idea, but its construction exacts two curves.]

**3. I am He! Who hate that evil should be wrought in the World!**

[The Angel, as the adept knows him, is a being in Tiphereth, which obscures Kether. The Adept is not officially aware of the higher Sephiroth. He cannot perceive, like the Ipsissimus, that all things soever are equally illusion and equally Absolute. He is in Tiphereth, whose office is Redemption, and he deplores the events which have caused the apparent Sorrow from which he has just escaped. He is also aware, even in the height of his ecstasy, of the limits and defects of his attainment.]

**4. I am He, that lighteneth and thundereth!**

[This refers to the phenomena which accompany his Attainment.]

**5. I am He, from whom is the Shower of the Life of Earth!**

[This means the recognition of the Angel as the True Self of his subconscious self, the hidden Life of his physical life.]

**6. I am He, whose mouth ever flameth!**

[The Adept realizes every breath, every word of his Angel as charged with creative fire. Tiphereth is the Sun, and the Angel is the spiritual Sun of the Soul of the Adept.]

**7. I am He, the Begetter and Manifester unto the Light!**

[Here is summed the entire process of bringing the conditioned Universe to knowledge of itself through the formula of generation;<sup>16</sup> a soul implants itself in sense-hoodwinked body and reason-fettered mind, makes them aware of their Inmate, and thus to partake of its own consciousness of the Light.]

**8. I am He, The Grace of the Worlds!**

["Grace" has here its proper sense of "Pleasantness". The existence of the Angel is the justification of the device of creation.<sup>17</sup>]

**9. "The Heart Girt with a Serpent" is my name!**

[This line must be studied in the light of Liber LXV (*The Equinox* XI, p. 65).<sup>18</sup>]

---

<sup>16</sup> That is, Yod Hé realizing Themselves, Will and Understanding, in the twins Vau Hé, Mind and Body.

<sup>17</sup> But see also the general solution of the Riddle of Existence in *The Book of the Law* and its Comment—Part IV of *Book 4*.

<sup>18</sup> Commonly identified as *The Equinox* Vol. III. No. 1 (*The Blue Equinox*) (York Beach, ME: Samuel Weiser, 1973).—*Ed.*

### **Section H: The "Charge to the Spirit."**

[This recapitulation demands the going forth together of the Adept and his Angel "to do their pleasure on the Earth among the living."]

**Come thou forth, and follow me: and make all Spirits subject unto Me so that every Spirit of the Firmament, and of the Ether, upon the Earth and under the Earth: on dry Land, or in the Water: of Whirling Air or of rushing Fire, and every Spell and Scourge of God, may be obedient unto me!**

### **Section J: The Proclamation of the Beast 666.**

**IAF: SABAF**

**Such are the Words!**

[The Beast 666 having devised the present method of using this Ritual, having proved it by his own practice to be of infallible puissance when properly performed, and now having written it down for the world, it shall be an ornament for the Adept who adopts it to cry Hail to His name at the end of his work. This shall moreover encourage him in Magick, to recall that indeed there was One who attained by its use to the Knowledge and Conversation of His Holy Guardian Angel, the which forsook him no more, but made Him a Magus, the Word of the Aeon of Horus!

For know this, that the Name IAF in its most secret and mighty sense declareth the Formula of the Magick of the BEAST whereby he wrought many wonders. And because he doth will that the whole world shall attain to this Art, He now hideth it herein so that the worthy may win to His Wisdom.

Let I and F face all;<sup>19</sup> yet ward their A from attack. The Hermit to himself, The Fool to foes, The Hierophant to

---

<sup>19</sup> If we adopt the new orthography VIAOV (*Book 4 Part III, Chap. V*) we must read "The Sun-6-the Son," etc., for "all"; and elaborate this interpretation here given in other ways, accordingly. Thus O (or F) will now be "The Fifteen by function" instead of "Five," etc., and "in act free, firm, aspiring, ecstatic," rather than "gentle," etc., as in the present text.

friends, Nine by nature, Naught by attainment, Five by function. In speech swift, subtle and secret; in thought creative, unbiased, unbounded; in act gentle, patient and persistent. Hermes to hear, Dionysus to touch, Pan to behold.

A Virgin, a Babe, and a Beast!

A Liar, an Idiot, and a Master of Men!

A kiss, a guffaw, and a bellow; he that hath ears to hear, let him hear!

Take ten that be one, and one that is one in three, to conceal them in six!

Thy Wand to all Cups, and thy Disk to all Swords, but betray not thine Egg!

Moreover also is IAF verily 666 by virtue of Number; and this is a mystery of Mysteries; Who knoweth it, he is adept of adepts, and Mighty among Magicians!

Now this word SABAF, being by number Three score and Ten,<sup>20</sup> is a name of Ayin, the Eye, and the Devil our Lord, and the Goat of Mendes. He is the Lord of the Sabbath of the Adepts, and is Satan, therefore also the Sun, whose number of Magick is 666, the seal of His servant the BEAST.

But again SA is 61, AIN, the Naught of Nuith; BA means go, for HADIT; and F is their Son the Sun who is Ra—Hoor—Khuit.

So then let the Adept set his sigil upon all the words he hath writ in the Book of the Works of his Will.

<sup>20</sup> There is an alternative spelling TzBA—F where the Root, “an Host,” has the value of 93. The Practicus should revive this Ritual throughout in the Light of his personal researches in the Qabalah, and thus make it his own peculiar property. The spelling here suggested implies that he who utters the Word affirms his allegiance to the symbols 93 and 6; that he is a warrior in the army of Will and of the Sun. 93 is also the number of AIWAZ and 6 of The Beast.

<sup>21</sup> The consonants of LOGOS, “Word,” add (Hebrew values) to 93. And EPH, “Words” (whence ‘Epic’) has also that value: EIAE TA EPIH might be the phrase here intended: its number is 418. This would then assert the accomplishment of the Great Work; this is the natural conclusion of the Ritual. Cf. CCXX. III. 75.



And let him then end all, saying, Such are the Words!<sup>21</sup> For by this he maketh proclamation before all them that be about his Circle that these Words are true and puissant, binding what he would bind, and loosing what he would loose.

Let the Adept perform this Ritual aright, perfect in every part thereof, once daily for one moon, then twice, at dawn and dusk, for two moons, next, thrice, noon added, for three moons, afterwards, midnight making his course, for four moons four times every day. Then let the Eleventh Moon be consecrated wholly to this Work; let him be instant in continual ardour, dismissing all but his sheer needs to eat and sleep.<sup>22</sup> For know that the true Formula<sup>23</sup> whose virtue sufficed the Beast in this Attainment, was thus:

---

<sup>22</sup> These needs are modified during the process of Initiation both as to quantity and quality. One should not become anxious about one's physical or mental health on a priori grounds, but pay attention only to indubitable symptoms of distress should such arise.

<sup>23</sup> The Oracles of Zoroaster utter this:

"And when, by often invoking, all the phantasms are vanished, thou shalt see that Holy and Formless Fire, that Fire which darts and flashes through all the Depths of the Universe; hear thou the Voice of the Fire!

"A similar Fire flashingly extending through the rushings of Air, or a Fire formless whence cometh the Image of a voice, or even a flashing Light abounding, revolving, whirling forth, crying aloud. Also there is the vision of the fire-flashing Courser of Light, or also a Child, borne aloft on the shoulders of the Celestial Steed, fiery, or clothed with gold, or naked, or shooting with the bow shafts of light, and standing on the shoulders of the horse, then if thy meditation prolongeth itself, thou shalt unite all these symbols into the Form of a Lion."

This passage—combined with several others—is paraphrased in poetry by Aleister Crowley in his *Tannäuser*. From *The Works of Aleister Crowley* (Foyers, England: Society for the Propagation of Religious Truth, 1905-7; reprinted by Yoga Publications Society in Homewood, IL in 1978).

"And when, invoking often, thou shalt see  
That formless Fire; when all the earth is shaken,  
The stars abide not, and the moon is gone,  
All Time crushed back into Eternity,

*continued on next page*

The Universe by earthquake overtaken;  
 Light is not, and the thunders roll,  
 The World is done:  
 When in the darkness Chaos rolls again  
 In the excited brain:  
 Then, O then call not to thy view that visible  
 Image of Nature; fatal is her name!  
 It fitteth not thy Body to behold  
 That living light of Hell,  
 The unluminous, dead flame,  
 Until that body from the crucible  
 Hath passed, pure gold!  
 For, from the confines of material space,  
 The twilight-moving place,  
 The gates of matter, and the dark threshold,  
 Before the faces of the Things that dwell  
 In the Abodes of Night,  
 Spring into sight  
 Demons, dog-faced, that show no mortal sign  
 Of Truth, but desecrate the Light Divine,  
 Seducing from the sacred mysteries.  
 But, after all these Folk of Fear are driven  
 Before the avenging levin  
 That rives the opening skies,  
 Behold that Formless and that Holy Flame  
 That hath no name;  
 The Fire that darts and flashes, writhes and creeps  
 Snake-wise in royal robe  
 Wound round that vanished glory of the globe,  
 Unto that sky beyond the starry deeps,  
 Beyond the Toils of Time,—then formulate  
 In thine own mind, luminous, concentrate,  
 The Lion of the Light, a child that stands  
 On the vast shoulders of the Steed of God:  
 Or winged, or shooting flying shafts, or shod  
 With the flame-sandals.  
     Then, lift up thine hands!  
 Centre thee in thine heart one scarlet thought  
 Limpid with brilliance of the Light above!  
 Draw into naught  
 All life, death, hatred, love:  
 All self concentrated in the sole desire—  
 Hear thou the Voice of Fire!"

## INVOKE OFTEN<sup>24</sup>

So may all men come at last to the Knowledge and Conversation of the Holy Guardian Angel: thus sayeth the Beast, and prayeth His own Angel that this book be as a burning Lamp, and as a living Spring, for Light and Life to them that read therein.

666

### POINT III

#### SCHOLION ON SECTIONS G & Gg

The Adept who has mastered this Ritual, successfully realizing the full import of this controlled rapture, ought not to allow his mind to loosen its grip on the astral imagery of the Star-spate, Will-Symbol, or Soul-symbol, or even to forget its duty to the body and the sensible surroundings. Nor should he omit to keep his Body of Light in close touch with the phenomena of its own plane, so that its privy consciousness may fulfil its proper functions of protecting his scattered ideas from obsession.

But he should have acquired, by previous practice, the faculty of detaching these elements of his consciousness from their articulate centre, so that they become (temporarily) independent responsible units, capable of receiving communications from headquarters at will, but perfectly able 1) to take care of themselves without troubling their chief, and 2) to report to him at the proper time. In a figure, they must be like subordinate officers, expected to display self-reliance, initiative, and integrity in the execution of the Orders of the Day.

---

<sup>24</sup> See *The Equinox* I, VIII, 22.

The Adept should therefore be able to rely on these individual minds of his to control their own conditions without interference from himself for the time required, and to recall them in due course, receiving an accurate report of their adventures.

This being so, the Adept will be free to concentrate his deepest self, that part of him which unconsciously orders his true Will, upon the realization of his Holy Guardian Angel. The absence of his bodily, mental and astral consciousness is indeed cardinal to success, for it is their usurpation of his attention which has made him deaf to his Soul, and his preoccupation with their affairs that has prevented him from perceiving that Soul.

The effect of the Ritual has been:

- a) to keep them so busy with their own work that they cease to distract him;
- b) to separate them so completely that his soul is stripped of its sheaths;
- c) to arouse in him an enthusiasm so intense as to intoxicate and anesthetize him, that he may not feel and resent the agony of this spiritual vivisection, just as bashful lovers get drunk on the wedding night, in order to brazen out the intensity of shame which so mysteriously coexists with their desire;
- d) to concentrate the necessary spiritual forces from every element, and fling them simultaneously into the aspiration towards the Holy Guardian Angel; and
- e) to attract the Angel by the vibration of the magical voice which invokes Him.

The method of the Ritual is thus manifold.

There is firstly an analysis of the Adept, which enables him to calculate his course of action. He can decide what must

be banished, what purified, what consecrated. He can then concentrate his will upon its one essential element, overcoming its resistance—which is automatic, like a physiological reflex—by destroying inhibitions through his ego-overwhelming enthusiasm.<sup>25</sup> The other half of the work needs no such complex effort; for his Angel is simple and unperplexed, ready at all times to respond to rightly ordered approach.

But the results of the Ritual are too various to permit of rigid description. One may say that, presuming the union to be perfect, the Adept need not retain any memory soever of what has occurred. He may be merely aware of a gap in his conscious life, and judge of its contents by observing that his nature has been subtly transfigured. Such an experience might indeed be the proof of perfection.

If the Adept is to be any wise conscious of his Angel it must be that some part of his mind is prepared to realize the rapture, and to express it to itself in one way or another. This involves the perfection of that part, its freedom from prejudice and the limitations of rationality so-called.

For instance: one could not receive the illumination as to the nature of life which the doctrine of evolution should shed, if one is passionately persuaded that humanity is essentially not animal, or convinced that causality is repugnant

---

<sup>25</sup> A high degree of initiation is required. This means that the process of analysis must have been carried out very thoroughly. The Adept must have become aware of his deepest impulses, and understood their true significance. The "resistance" here mentioned is automatic; it increases indefinitely against direct pressure. It is useless to try to force oneself in these matters; the uninitiated Aspirant, however eager he may be, is sure to fail. One must know how to deal with each internal idea as it arises.

It is impossible to overcome one's inhibitions by conscious effort; their existence justifies them. God is on their side, as on that of the victim in Browning's *Instans Tyrannus*. A man cannot compel himself to love, however much he may want to, on various rational grounds. But on the other hand, when the true impulse comes, it overwhelms all its critics; they are powerless either to make or break a genius; it can only testify to the fact that it has met its master.

to reason. The Adept must be ready for the utter destruction of his point of view on any subject, and even that of his innate conception of the forms and laws of thought.<sup>26</sup> Thus he may find that his Angel consider his "business" or his "love" to be absurd trifles; also that human ideas of "time" are invalid, and human "laws" of logic applicable only to the relations between illusions.

Now the Angel will make contact with the Adept at any point that is sensitive to His influence. Such a point will naturally be one that is salient in the Adept's character, and also one that is, in the proper sense of the word, pure.<sup>27</sup>

Thus an artist, attuned to appreciate plastic beauty is likely to receive a visual impression of his Angel in a physical form which is sublimely quintessential of his ideal. A musician may be rapt away by majestic melodies such as he never hoped to hear. A philosopher may attain apprehension of tremendous truths, the solution of problems that had baffled him all his life.

Conformably with this doctrine, we read of illuminations, experienced by simple-minded men, such as a workman who "saw God" and likened Him to "a quantity of little pearls." Again, we know that ecstasy, impinging upon unbalanced minds, inflames the idolized idea, and produces fanatical faith fierce even to frenzy, with intolerance and insanely disordered energy which is yet so powerful as to effect the destinies of empires.

---

<sup>26</sup> Of course, even false tenets and modes of the mind are in one sense true. It is only their appearance which alters. Copernicus did not destroy the facts of nature, or change the instruments of observation. He merely effected a radical simplification of science. Error is really a "fool's knot." Moreover, the very tendency responsible for the entanglement is one of the necessary elements of the situation. Nothing is "wrong" in the end; and one cannot reach the "right" point of view without the aid of one's particular "wrong" point. If we reject or alter the negative of a photograph we shall not get a perfect positive.

<sup>27</sup> This means, free from ideas, however excellent in themselves, which are foreign to it. For instance, literary interest has no proper place in a picture.

But the phenomena of the Knowledge and Conversation of the Holy Guardian Angel are a side issue; the essence of the Union is the intimacy. Their intimacy (or rather identity) is independent of all partial forms of expression; at its best it is therefore as inarticulate as Love.

The intensity of the consummation will more probably compel a sob or a cry, some natural physical gesture of animal sympathy with the spiritual spasm. This is to be criticized as incomplete self-control. Silence is nobler.

In any case the Adept must be in communion with his Angel, so that his Soul is suffused with sublimity, whether intelligible or not in terms of intellect. It is evident that the stress of such spiritual possession must tend to overwhelm the soul, especially at first. It actually suffers from the excess of its ecstasy, just as extreme love produces vertigo. The soul sinks and swoons. Such weakness is fatal alike to its enjoyment and its apprehension. "Be strong! then canst thou bear more rapture!" sayeth the Book of the Law.<sup>28</sup>

The Adept must therefore play the man, arousing himself to harden his soul.

To this end, I, the Beast have made trial and proof of divers devices. Of these the most potent is to set the body to strive with the soul. Let the muscles take grip on themselves as if one were wrestling. Let the jaw and mouth, in particular, be tightened to the utmost. Breathe deeply, slowly, yet strongly. Keep mastery over the mind by muttering forcibly and audibly. But lest such muttering tend to disturb communion with the Angel, speak only His Name. Until the Adept have heard that Name, therefore, he may not abide in the perfect possession of his Beloved. His most important task is thus to open his ears to the voice of his Angel, that he may know him, how he is called. For hearken! this Name, understood rightly and fully, declareth the nature of the Angel in every point, wherefore also that Name is

---

<sup>28</sup> *Liber AL vel Legis*, II, 61-68, where the details of the proper technique are discussed.

the formula of the perfection to which the Adept must aspire, and also of the power of Magick by virtue whereof he must work.

He then that is as yet ignorant of that Name, let him repeat a word worthy of this particular Ritual. Such are Abrahadabra, the Word of the Aeon, which signifieth "The Great Work accomplished"; and Aumgn interpreted in Part III of *Book 4*;<sup>29</sup> and the name of THE BEAST, for that His number showeth forth this Union with the Angel, and His Work is no other than to make all men partakers of this Mystery of the Mysteries of Magick.

So then saying this word or that, let the Adept wrestle with his Angel and withstand Him, that he may constrain Him to consent to continue in communion until the consciousness becomes capable of clear comprehension, and of accurate transmission<sup>30</sup> of the transcendent Truth of the Beloved to the heart that holds him.

The firm repetition of one of these Words ought to enable the Adept to maintain the state of Union for several minutes, even at first.

In any case he must rekindle his ardour, esteeming his success rather as an encouragement to more ardent aspiration than as a triumph. He should increase his efforts.

---

<sup>29</sup> The essence of this matter is that the word AUM, which expresses the course of Breath (spiritual life) from free utterance through controlled concentration to Silence, is transmuted by the creation of the compound letter MTN to replace M: that is, Silence is realised as passing into continuous ecstatic vibration, of the nature of "Love" under "Will" as shewn by MTN = 40 + 3 + 50 = 93 ΑΓΑΠΗ, ΘΕΛΗΜΑ, etc., and the whole word has the value of 100, Perfection Perfected, the Unity in completion, and equivalent to KP the conjunction of the essential male and female principles.

<sup>30</sup> The "normal" intellect is incapable of these functions; a superior faculty must have been developed. As Zoroaster says: "Extend the void mind of thy soul to that Intelligible that thou mayst learn the Intelligible, because it subsisteth beyond Mind. Thou wilt not understand It as when understanding some common thing."



Let him beware of the 'lust of result', of expecting too much, of losing courage if his first success is followed by a series of failures.

For success makes success seem so incredible that one is apt to create an inhibition fatal to subsequent attempts. One fears to fail; the fear intrudes upon the concentration and so fulfils its own prophecy. We know how too much pleasure in a love affair makes one afraid to disgrace oneself on the next few occasions; indeed, until familiarity has accustomed one to the idea that one's lover has never supposed one to be more than human. Confidence returns gradually. Inarticulate ecstasy is replaced by a more sober enjoyment of the elements of the fascination.

Just so one's first dazzled delight in a new landscape turns, as one continues to gaze, to the appreciation of exquisite details of the view. At first they were blurred by the blinding rush of general beauty; they emerge one by one as the shock subsides, and passionate rapture yields to intelligent interest.

In the same way the Adept almost always begins by torrential lyrics panting out mystical extravagances about "ineffable love," "unimaginable bliss," "inexpressible infinities of illimitable utterness."<sup>31</sup> He usually loses his sense of proportion, of humour, of reality, and of sound judgment. His ego is often inflated to bursting point, till he would be abjectly ridiculous if he were not so pitifully dangerous to himself and others. He also tends to take his new-found "truths of illumination" for the entire body of truth, and insists that they must be as valid and vital for all men as they happen to be for himself.

It is wise to keep silence about those things "unlawful to utter" which one may have heard "in the seventh heaven". This may not apply to the sixth.

---

<sup>31</sup> This corresponds to the emotional and metaphysical fog which is characteristic of the emergence of thought from homogeneity. The clear and concise differentiation of ideas marks the adult mind.

The Adept must keep himself in hand, however tempted to make a new heaven and a new earth in the next few days by trumpeting his triumphs. He must give time a chance to redress his balance, sore shaken by the impact of the Infinite.

As he becomes adjusted to intercourse with his Angel, he will find his passionate ecstasy develop a quality of peace and intelligibility which adds power, while it informs and fortifies his mental and moral qualities instead of obscuring and upsetting them. He will by now have become able to converse with his Angel, impossible as it once seemed; for he now knows that the storm of sound which he supposed to be the Voice was only the clamour of his own confusions. The "infinity" nonsense was born of his own inability to think clearly beyond his limits, just as a Bushman, confronted by numbers above five, can only call them "many."

The truth told by the Angel, immensely as it extends the horizon of the Adept, is perfectly definite and precise. It does not deal in ambiguities and abstractions. It possesses form, and confesses law, in exactly the same way and degree as any other body of truth. It is to the truth of the material and intellectual spheres of man very much what the Mathematics of Philosophy with its "infinite series" and "Cantorian continuity" is to school-boy arithmetic. Each implies the other, though by that one may explore the essential nature of existence, and by this a pawnbroker's profits.

This then is the true aim of the Adept in this whole operation, to assimilate himself to his Angel by continual conscious communion. For his Angel is an intelligible image of his own true Will, to do which is the whole of the law of his Being.

Also the Angel appeareth in Tiphereth, which is the heart of the Ruach, and thus the Centre of Gravity of the Mind. It is also directly inspired from Kether, the ultimate Self, through the Path of the High Priestess, or initiated intuition. Hence the Angel is in truth the Logos or articulate

expression of the whole Being of the Adept, so that as he increases in the perfect understanding of His name, he approaches the solution of the ultimate problem, Who he himself truly is.

Unto this final statement the Adept may trust his Angel to lead him; for the Tiphereth-consciousness alone is connected by paths with the various parts of his mind.<sup>32</sup> None therefore save He hath the knowledge requisite for calculating the combinations of conduct which will organize and equilibrate the forces of the Adept, against the moment when it becomes necessary to confront the Abyss. The Adept must control a compact and coherent mass if he is to make sure of hurling it from him with a clean-cut gesture.

I, The Beast 666, lift up my voice and swear that I myself have been brought hither by mine Angel. After that I had attained unto the Knowledge and Conversation of Him by virtue of mine ardour towards Him, and of this Ritual that I bestow upon men my fellows, and most of His great Love that He beareth to me, yea, verily, He led me to the Abyss; He bade me fling away all that I had and all that I was; and He forsook me in that Hour. But when I came beyond the Abyss, to be reborn within the womb of BABALON, then came he unto me abiding in my virgin heart, its Lord and Lover!

Also He made me a Magus, speaking through His Law, the Word of the new Aeon, the Aeon of the Crowned and Conquering Child.<sup>33</sup> Thus he fulfilled my will to bring full freedom to the race of Men.

Yea, he wrought also in me a Work of Wonder beyond this, but in this matter I am sworn to hold my peace.

---

<sup>32</sup> See the maps "Minutum Mundum" in *The Equinox* 1, 2 and 3, and the general relations detailed in Liber 777.

<sup>33</sup> For the account of these matters see *The Equinox*, Vol. I, "The Temple of Solomon the King," Liber 418, *Liber Aleph*, John St. John, The Urn, and Book 4, Part IV [*The Book of the Law*, with its comment, in preparation].

The following is an example of a working script of *Liber Samekh*, which includes only the words, directions, and diagrams necessary to memorize and rehearse the ceremony. I remind the leader that this is my own innovation of the ritual. It should not be confused with Crowley's original *Liber Samekh* or be construed as an official document.

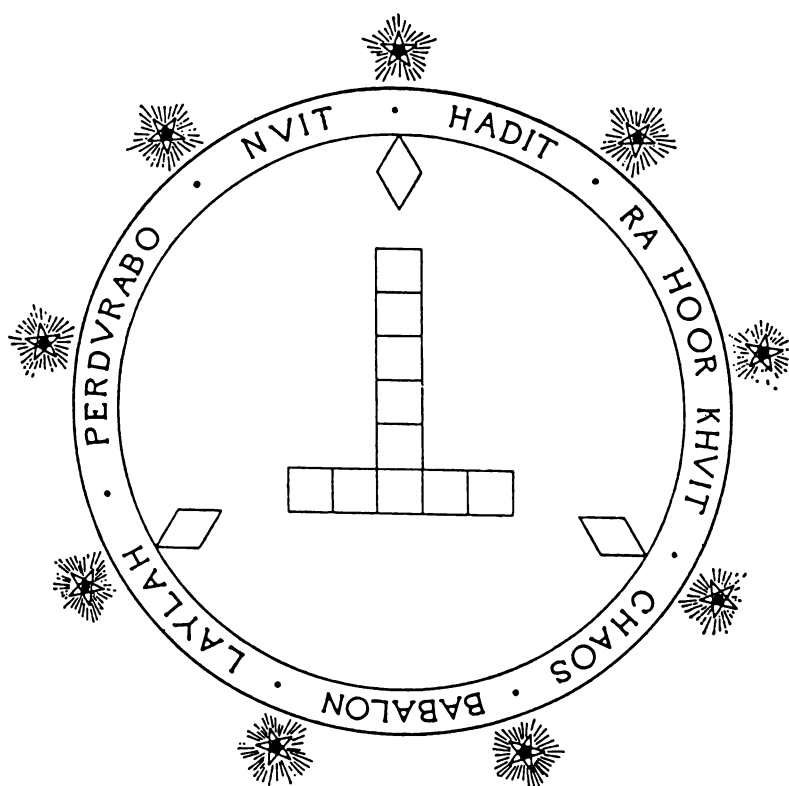

*The circle*

*A figure from Aleister Crowley's Magick (York Beach, ME: Samuel Weiser, 1974), p. 51.*

# CEREMONY OF THE INVOCATION OF THE HOLY GUARDIAN ANGEL

Constructed by L. M. D.<sup>34</sup>

based upon the text and notes of  
Aleister Crowley's  
**Liber Samekh.**

The preamble: he makes a general concentration of all his magical forces and a declaration of his will.

The Ar Thiao section. He travels to the infinite East among the hosts of angels summoned by the words. A sort of "Rising on the Planes" but in a horizontal direction.

The same remarks apply to the next three section in the other quarters.

At the great invocation following he extends the Shivalingam to infinite height, each letter of each word representing an exaltation of it by geometrical progression. Having seen this satisfactorily, he prostrates himself in adoration.

When consciousness begins to return, he uses the final formula to raise that consciousness in the Shivalingam, springing to his feet at the moment of uniting himself with it, and lastly uttering that supreme song of the initiate beginning: "I am He, the Bornless Spirit, having sight in the feet; strong and the Immortal Fire!"

(Thus performed, the invocation means about half an hour of the most intense magical work

---

<sup>34</sup> Comments and directions of the present author in [brackets].—*Ed.*

imaginable—a minute of it would represent the equivalent of about twelve hours of Asana.)<sup>35</sup>

Equinox Vol. 1 No. VIII.

“Let the Adept perform this Ritual aright, perfect in every part thereof, once daily for one moon, then twice, at dawn and dusk, for two moons, next, thrice, noon added, for three moons, afterwards, midnight making his course, for four moons four times every day. Then let the Eleventh Moon be consecrated wholly to this Work; let him be instant in continual ardour, dismissing all but his sheer needs to eat and sleep. For know that the true Formula whose virtue sufficed the Beast in this Attainment, was thus: INVOKE OFTEN.”

[Prior to the Invocation, the temple is banished, purified, and consecrated as the Adept has skill to execute. Upon the temple floor is inscribed a circle surrounding the inverted Tau Cross of the Sephiroth. The Adept is dressed as an Adeptus Minor, armed with Wand and Cup and stands in the circle upon the square of Tiphereth. The entire ritual is performed throughout in his Body of Light.]

## THE OATH

**Thee I invoke, the Bornless One.**

**Thee, that didst create the Earth and the Heavens.**

**Thee, that didst create the Night and the Day.**

**Thee, that didst create the darkness and the Light.**

**Thou art RA-HOOR-KHUIT, Myself made Perfect: Whom  
no man hath seen at any time.**

**Thou art IA-BESZ**

**Thou art IA-APOPHRASZ**

---

<sup>35</sup> Aleister Crowley, *The Equinox*, Vol. I No. VIII (York Beach, ME: Samuel Weiser, 1992), p. 18.

**Thou has distinguished between the Just and the Unjust.  
Thou didst make the Female and the Male.  
Thou didst produce the Seeds and the Fruit.  
Thou didst form Men to love one another, and to hate one another.**

**I am \_\_\_\_\_<sup>36</sup> thy Prophet, unto Whom Thou didst commit Thy Mysteries, the Ceremonies of THELEMA.  
Thou didst produce the moist and the dry, and that which nourisheth all created Life.**

**Hear Thou Me, for I am the Angel of NU, the Angel of HAD, the Angel of RA-HOOR-KHU: this is Thy True Name, handed down to the Prophets of THELEMA.  
[Pass widdershins to East. Make invoking Pentagrams (active Spirit and Air) with appropriate signs, sigil, and words.]**



Sign of the Rending  
of the Veil



2° = 9° Sign

**Hear Me:**

**AR ThIAF RhEIBET A-ThELE-BER-SET A BELATHA  
ABEU EBEU PhI-ThETA-SOE IB ThIAF**

**Hear Me, and make all Spirits subject unto Me; so that every Spirit of the Firmament and of the Ether: upon the Earth and under the Earth, on dry land and in the water; of Whirling Air, and of rushing Fire, and every Spell and Scourge of God may be obedient unto Me. [Pass widdershins to South. Make invoking Pentagrams (active Spirit and Fire) with appropriate signs, sigil, and words.]**

<sup>36</sup> The Motto of the Adeptus Minor.



Sign of the Rendering  
of the Veil



4° = 7° Sign

**I invoke Thee, the Terrible and Invisible God: Who dwellest in the Void Place of the Spirit:**

**AR-O-GO-GO-RU-ABRAO SOTOU MUDORIO**

**PhALARThAO OOO AEPE**

**The Bornless One.**

**Hear Me, and make all Spirits subject unto Me; so that every Spirit of the Firmament and of the Ether: upon the Earth and under the Earth, on dry land and in the water; of Whirling Air, and of rushing Fire, and every Spell and Scourge of God may be obedient unto Me. [Pass widdershins to West. Make invoking Pentagrams (passive Spirit and Water) with appropriate signs, sigil, and words.]**



Sign of the Closing  
of the Veil



3° = 8° Sign

**Hear Me:**

**RU-ABRA-IAF MRIODOM**

**BABALON-BAL-BIN-ABAFT. ASAL-ON-AI APhEN-IAF**

**I PhOTETH ABRASAK AEOOU ISChURE**

**Mighty and Bornless One!**

**Hear Me, and make all Spirits subject unto Me: so that every Spirit of the Firmament and of the Ether: upon the Earth and under the Earth: on dry Land and in the Water: of Whirling Air, and of rushing Fire: and every Spell and Scourge of God may be obedient unto Me. [Pass widdershins to North. Make invoking Pentagrams (passive Spirit and Earth) with appropriate signs, sigil, and words.]**





Sign of the Closing  
of the Veil



1° = 10<sup>o</sup> Sign

**I invoke Thee:**

**MA BARRAIO IOEL KOTHA ATHOR-e-BAL-O ABRAFT**  
Hear Me, and make all Spirits subject unto Me: so that every Spirit of the Firmament and of the Ether: upon the Earth and under the Earth: on dry Land and in the Water: of Whirling Air, and of rushing Fire: and every Spell and Scourge of God may be obedient unto Me. [Pass widdershins and return to Square of Tiphereth. Make invoking Pentagram of Spirit active with appropriate word and sign; trace the Mark of the Beast and give L.V.X. signs.]



Sign of the Rending  
of the Veil



Signs of L.V.X.

**Hear me:**

**AFT ABAFT BAS-AUMGN. ISAK SA-BA-FT** [Fall prostrate in adoration].

**This is the Lord of the Gods:**

**This is the Lord of the Universe:**

**This is He whom the Winds fear.**

**This is He, Who having made Voice by His commandment is Lord of all Things; King, Ruler and Helper.**

**Hear Me, and make all Spirits subject unto Me: so that every Spirit of the Firmament and of the Ether: upon the Earth and under the Earth: on dry Land and in the Water: of Whirling Air, and of rushing Fire: and every Spell and Scourge of God may be obedient unto Me. [Make invoking Pentagram of Spirit passive with appropriate word and sign; trace the Mark of the Beast and give L.V.X. signs.]**



Sign of the Closing  
of the Veil



Signs of L.V.X.

**Hear Me:**

**IEOU PUR IOU PUR IAFTh IAEO IOOU ABRASAX  
SABRIAM OO FF AD-ON-A-I EDE EDU ANGELOS TON  
THEON ANLALA LAI GAIA AEPE DIATHARNA  
THORON [Resume standing].**

**I am He! the Bornless Spirit! having sight in the feet:  
Strong, and the Immortal Fire!**

**I am He! the Truth!**

**I am He! Who hate that evil should be wrought in the  
World!**

**I am He, that lighteneth and thundereth!**

**I am He, from whom is the Shower of the Life of Earth!**

**I am He, whose mouth ever flameth!**

**I am He, the Begetter and Manifester unto the Light!**

**I am He, The Grace of the Worlds!**

**"The Heart Girt with a Serpent" is my name!**

**Come thou forth, and follow me: and make all Spirits sub-  
ject unto Me so that every Spirit of the Firmament, and of  
the Ether, upon the Earth and under the Earth: on dry Land,  
or in the Water: of Whirling Air or of rushing Fire, and  
every Spell and Scourge of God, may be obedient unto me!**

**IAF: SABAF  
Such are the Words!**

## CHAPTER NINE

# THE SOLAR RITES

*There is a secret door that I shall make to establish thy way in all the quarters, (these are the adorations, as thou hast written)....*

Liber AL vel Legis, III, xxxviii.

Within a religious context, the Magick of Thelema could accurately be described as Solar worship. The only thing new and revolutionary about it is the “worshiper’s” relation to the Sun. It doesn’t take very long for the modern student of comparative religion to see the countless similarities and parallels inherent in the world’s so-called Great Religions. We might even say (if we allow ourselves the emancipation of a truly open mind), that the religions of the past are really only aspects of *one* religion whose universal object of worship is the Sun, and whose ceremonies, observances, and holy days are based upon the recurring yearly passion play that is the solar calendar.

Terrestrial life pantomimes the Sun’s life-creating qualities in the reproductive capabilities of the each organism. Our ancestors drew a direct parallel between the Sun and the phallus, and between sunlight, blood, and semen. This correlation assumes increasingly profound dimensions as we apply our greater understanding of astronomy, physics, and medicine to this great evolving religion.

The simple "truth" of the death of the Sun was destroyed by the "truth" of the heliocentric system, which is destroyed by the "truth" that our solar system revolves around a central *something* which may very well be a black and inscrutable negative dimension. Theoretically all of this originated as a compact, pre-existent, negative singularity (which for some reason could not contain itself), and in all likelihood will someday withdraw everything back into nothingness.

Meanwhile we are discovering that everything we were, are, and shall be is encoded upon a chemical "chip" called DNA, which impresses itself upon our cells, and flows like an eternal river through the blood of infinite generations whose most important function is to serve as organic "ark" for this evolving superlife.

All of the Thelemic rituals express the formulae of the new solar consciousness, but two in particular incorporate the Sun itself as the central element of ceremony: *Liber Resh* and *The Mass of the Phoenix*.

*Resh* is a simple series of four adorations which are performed at dawn, noon, sunset, and midnight. These are formatted as classic Egyptian adorations, but customized to satisfy Crowley's idea of the new magical formulae. *Resh* serves as an excellent form of background concentration which requires us to acknowledge our magical relationship with the Sun at least four times in our busy day.

The object of this practice is firstly to remind the aspirant at regular intervals of the Great Work; secondly, to bring him into conscious personal relation with the centre of our system; and thirdly, for advanced students, to make actual magical contact with the spiritual energy of the sun and thus to draw actual force from him.<sup>1</sup>

---

<sup>1</sup> *The Confessions of Aleister Crowley* (London: Penguin/Arkana, 1989).

*The Mass of the Phoenix* is a Eucharistic ceremony created to be celebrated at sunset in order to fortify the Magician's awareness of the Sun during its nighttime journey. Like *The Star Ruby* and *The Star Sapphire*, it first appeared in print in *The Book Of Lies* where it was positioned as Chapter 44.<sup>2</sup>

Because there appears to be an element of self-mutilation in *The Mass of the Phoenix*, there continues to be considerable misunderstanding about the ritual, and outrageous statements by extremists on both ends of the magical spectrum have caused many serious students to avoid it altogether. Crowley wrote in chapter 20 of *Magick in Theory and Practice*, that the *Mass of the Phoenix* "...should be performed daily at sunset by every magician." Did he really expect us to risk our health by slashing our chests open each evening?

I confess that as an overzealous young fool, I celebrated *The Mass of the Phoenix* by using a surgeon's scalpel in place of the Burin to ..."make the proper sign." To my amazement the blade painlessly disappeared almost entirely into the flesh of my chest before I realized what was happening. The cut was extremely clean, and for a moment there was no bleeding whatsoever. Then it came...quickly running in a thick stream over the front of my body. Determined to complete the ceremony, I tried to "*Staunch the blood*" with the Cake of Light,<sup>3</sup> only to have it disintegrate in my fingers in a flood of warm blood. The sun was half obscured by the horizon, and its soft orange light bathed my blood-soaked chest and fingers. I bolted for the bathroom as I nervously parroted "...with mirth I now go forth, and with thanksgiving, to do my pleasure on the earth among the legions of the living." I was frightened, agitated, injured, and embarrassed. I did *not* feel very spiritual.

---

<sup>2</sup> 44 = DM = Blood (Hebrew)

<sup>3</sup> See *Liber AL vel Legis*, III, 23.

**Let the blood of my sacrifice wash you clean of any temptation to do such a stupid thing to yourself!**

It is obvious from the text that the Magician is to actually draw blood in order to consecrate the Cake of Light before consuming it. But nowhere is it indicated that pain, scarring, or injury is a required element of the ceremony. It is a Eucharist, not a ritual of self-mutilation.

An excellent way to “make the proper sign”<sup>4</sup> is to use a machinist’s scribe (a rod of steel tapered to an extremely sharp point). It is easy to sterilize and, if one is careful, it is possible to lightly scratch the symbol on the flesh. This will remain visible for several hours. By applying just a little more pressure to a small area of the scratch, the tool will break the skin just enough for a tiny drop of blood to rise to the surface. This fulfils the literal interpretation of the ritual without harm to the Magician, and allows him or her to concentrate on the real purpose of the ceremony, namely a solar Eucharist.

The ideal setting for *The Mass of the Phoenix* is outdoors, or before a window opened to accommodate a view of the setting Sun. The ritual is so brief that the Magician can begin as the Sun first touches the horizon and have time to “charge” the blood on the chest with the last rays of the setting Sun. This solar-consecrated Holy Blood is then trapped in the Cake of Light and eaten by the Magician. When the Mass is over, the essence of the Sun is safely sheltered until dawn in the body of the Magician. If performed regularly and over a period of time, the body of the Magician will be renewed, cell by cell, by this divine solar nourishment.

It is rare for someone to have a lifestyle which would accommodate the perpetual celebration of *The Mass of the*

---

<sup>4</sup> A cross or X within a circle, or the “Mark of the Beast” are both appropriate signs.

*Phoenix*, but it is an excellent component in the daily regimen of a Magical Retirement. *Liber Resh* is so short that it can be performed, at least in an informal format, almost anywhere, and Crowley urged his students to never omit its observance.<sup>5</sup>

---

<sup>5</sup> He also insisted upon doing "Will" before the major meal of the day.

Do what thou wilt shall be the whole of the Law.

What is thy Will?

It is my will to eat and drink.

To what end?

That my body may be fortified thereby.

To what end?

That I may accomplish the Great Work.

Love is the law, love under will

Fall to.

*From Magick in Theory on Practice* (New York: Magickal Childe, 1990), pp. 102, 103. Originally printed in Paris by Lecram Press, 1929.

**LIBER RESH**  
**VEL**  
**HELIOS**  
**SUB FIGURA CC.<sup>6</sup>**

0. These are the adorations to be performed by aspirants to the A.: A.:

1. Let him greet the Sun at dawn, facing East, giving the sign of his grade. And let him say in a loud voice: **Hail unto Thee who art Ra in Thy rising, even unto Thee who art Ra in Thy strength, who travellest over the Heavens in Thy bark at the Uprising of the Sun. Tahuti standeth in His splendour at the prow, and Ra-Hoor abideth at the helm. Hail unto Thee from the Abodes of Night!**

2. Also at Noon, let him greet the Sun, facing South giving the sign of his grade. And let him say in a loud voice: **Hail unto Thee who art Ahathoor in Thy triumphing, even unto Thee who art Ahathoor in Thy beauty, who travellest over the Heavens in Thy bark at the Mid-course of the Sun. Tahuti standeth in His splendour at the prow, and Ra-Hoor abideth at the helm. Hail unto Thee from the Abodes of Morning!**

3. Also at Sunset, let him greet the Sun, facing West giving the sign of his grade. And let him say in a loud voice: **Hail unto Thee who art Tum in Thy setting, even unto Thee who art Tum in Thy joy, who travellest over the Heavens in Thy bark at the Down-going of the Sun. Tahuti standeth in His splendour at the prow, and Ra-Hoor abideth at the helm. Hail unto Thee from the Abodes of Day!**

---

<sup>6</sup> LIBER RESH can be found in Crowley's *The Equinox*, Volume I, No. 6 (York Beach, ME: Samuel Weiser, 1990).



4. Lastly, at Midnight, let him greet the Sun, facing North giving the sign of his grade. And let him say in a loud voice: **Hail unto Thee who art Khephra in Thy hiding, even unto Thee who art Khephra in Thy silence, who travellest over the Heavens in Thy bark at the Midnight Hour of the Sun. Tahuti standeth in His splendour at the prow, and Ra-Hoor abideth at the helm.**

**Hail unto Thee from the Abodes of Evening!**

5. And after each of these invocations thou shalt give the sign of silence, and afterward thou shalt perform the adoration that is taught thee by thy Superior. And then do thou compose Thyself to holy meditation.

6. Also it is better if in these adorations thou assume the God-form of Whom thou adorest, as if thou didst unite with Him in the adoration of That which is beyond Him.

7. Thus shalt thou ever be mindful of the Great Work which thou hast undertaken to perform, and thus shalt thou be strengthened to pursue it unto the attainment of the Stone of the Wise, the Summum Bonum, True Wisdom and Perfect Happiness.



## AUTHOR'S NOTES AND COMMENTS

1. The imagery is that of the Egyptian Solar barge (bark), which every evening at sunset, carries the glorified Osiris from the western horizon through the land of the Dead, and brings the eternal Sun safely under the Earth to dawn on the eastern horizon each morning as Ra.

**Tahuti** (Thoth), the Ibis-headed psychopomp of the Egyptians, is stationed at the prow, and Horus, the Son of the Sun, acts as divine helmsman.

2. **Ahathoor**—the Egyptian Venus whose month of November (Scorpio) marks the cross quarter of the year when darkness triumphs over the light.

3. **Tum, Tmu**—God of the West, the setting Sun—God of the Sun at night.

4. **Khephra**—As the Egyptian desert scarab perpetually rolls a ball of dung in which her eggs are stored, so too Khephra, the celestial scarab, rolls the sphere of the Sun across the heavens.

5. According to some accounts, Crowley taught residents of the Abbey of Thelema to recite the following portions of The Book of the Law as the adorations:

Unity uttermost showed!

I adore the might of Thy breath,  
Supreme and terrible God,  
Who makest the gods and death  
To tremble before Thee:—  
I, I adore thee!

Appear on the throne of Ra!

Open the ways of the Khu!  
Lighten the ways of the Ka!  
The ways of the Khabs run through  
To stir me or still me!  
Aum! let it fill me!

The light is mine; its rays consume

Me: I have made a secret door  
Into the House of Ra and Tum,  
Of Khephra and of Ahathoor.  
I am thy Theban, O Mentu,  
The prophet Ankh-af-na khonsu!

By Bes-na-Maut my breast I beat;  
By wise Ta-Nech I weave my spell.  
Show thy star-splendour, O Nuit!  
Bid me within thine House to dwell,  
O wingèd snake of light, Hadit!  
Abide with me, Ra-Hoor-Khuit!<sup>7</sup>

6. This is a particularly effective exercise, especially for the Magician who is learning (or already proficient in) the assumption of god-forms.

---

<sup>7</sup> From *Liber AL vel Legis*, chap. III, verses 37 and 38.

# LIBER XLIV

## THE MASS OF THE PHOENIX

The Magician, his breast bare, stands before an altar on which are his Burin, Bell, Thurible, and two of the Cakes of Light. In the Sign of the Enterer he reaches West across the Altar, and cries:

**Hail Ra, that goest in Thy bark  
Into the caverns of the Dark!**

He gives the sign of Silence, and takes the Bell, and Fire, in his hands.

**East of the Altar see me stand  
With Light and Musick in mine hand!**

He strikes Eleven times upon the Bell 333-55555-333 and places the Fire in the Thurible.

**I strike the Bell: I light the Flame:  
I utter the mysterious Name.  
ABRAHADABRA**

He strikes Eleven times upon the Bell.

**Now I begin to pray: Thou Child,  
Holy Thy name and undefiled!  
Thy reign is come; Thy will is done.  
Here is the Bread; here is the Blood.  
Bring me through midnight to the Sun!  
Save me from Evil and from Good!  
That Thy one crown of all the Ten  
Even now and here be mine. AMEN.**

He puts the first Cake on the Fire of the Thurible.

**I burn the Incense-cake, proclaim  
These adorations of Thy name.**

He makes them<sup>8</sup> as in Liber Legis, and strikes again Eleven times upon the Bell. With the Burin he then makes upon his breast the proper sign.

**Behold this bleeding breast of mine  
Gashed with the sacramental sign!**

He puts the second Cake to the wound.

**I stanch the blood; the wafer soaks  
It up, and the high priest invokes!**

He eats the second Cake.

**This Bread I eat. This Oath I swear  
As I enflame myself with prayer:  
"There is no grace: there is no guilt:  
This is the Law: DO WHAT THOU WILT!"**

He strikes Eleven times upon the Bell, and cries

**ABRAHADABRA.  
I entered in with woe; with mirth  
I now go forth, and with thanksgiving,  
To do my pleasure on the earth  
Among the legions of the living.**

He goeth forth.

---

<sup>8</sup> The Adorations. See line 5 of *Liber Resh*.—Ed.

# ΚΕΦΑΛΗ ΕΒ<sup>9</sup>

## TWIG?

The Phoenix hath a Bell for Sound; Fire for Sight; a Knife for Touch; two cakes, one for taste, the other for smell.

He standeth before the Altar of the Universe at Sunset, when Earth-life fades.

He summons the Universe, and crowns it with MAGICK Light to replace the sun of natural light.

He prays unto, and gives homage to, Ra-Hoor-Khuit; to Him he then sacrifices.

The first cake, burnt, illustrates the profit drawn from the scheme of incarnation.

The second, mixt with his life's blood and eaten, illustrates the use of the lower life to feed the higher life.

He then takes the Oath and becomes free—unconditioned—the Absolute.

Burning up in the Flame of his Prayer, and born again—the Phoenix!

---

<sup>9</sup> Chapter 62 of *The Book of Lies* (York Beach, ME: Samuel Weiser, 1981), p. 134. "This chapter is itself a comment of Chapter 44." (*The Mass of the Phoenix* also found in *The Book of Lies*.)

## CHAPTER TEN

---

# THELEMIC MYSTICISM

*The other images group around me to support me: let all be worshipped, for they shall cluster to exalt me. I am the visible object of worship; the others are secret; for the Beast & his Bride are they: and for the winners of the Ordeal x. What is this? Thou shalt know.*

Liber AL vel Legis III., 22

Finally we come to two extraordinary works which are unique among the Class D Rituals. In fact, all the rituals we have discussed so far could be considered as preparatory exercises to the High Magick embodied in them. *Liber NV* and *Liber HAD*<sup>1</sup> are the instructional papers for the invocations of the highest concepts of Thelemic cosmology, Nuit and Hadit.

While these invocations are obviously magical in their execution, they are undeniably mystical in their essence, for they require that the Magician not only *do* something but *be* something. Quite simply put, to invoke Nuit, the Magician must be Hadit; and to invoke Hadit, one must be Nuit.

This is a pretty tall order, and most likely will not become the all-consuming preoccupation of most of the current inhabitants of our planet. *Liber NV* and *Liber Had* are for the "winners of the Ordeal x."<sup>2</sup>

---

<sup>1</sup> Both appeared originally in *The Equinox*, Vol. I, no. 7.

<sup>2</sup> "The Ordeal x is dealt with in private." *The Equinox*, Vol. I, no. 10.

**LIBER NV**  
**Sub Figura XI**  
**A.: A.:**  
**Publication in Class D**  
**(for Winners of the Ordeal X).**

000. This is the Book of the Cult of the Infinite Without.

00. The Aspirant is Hadit. Nuit is the infinite expansion of the Rose; Hadit the infinite concentration of the Rood.

*(Instruction of V.V.V.V.V.).*

0. First let the Aspirant learn in his heart the First Chapter of *The Book of the Law*.

*(Instruction of V.V.V.V.V.)*

1. Worship, i.e., identify thyself with, the Khabs, the secret Light within the Heart. Within this, again, unextended, is Hadit.

*This is the first practice of Meditation (ccxx. I. 6 and 21).*

2. Adore and understand the Rim of the Stélé of Revealing.

**Above, the gemmèd azure is**  
**The naked splendour of Nuit;**  
**She bends in ecstasy to kiss**  
**The secret ardours of Hadit.**

*This is the first practice of Intelligence (ccxx. I. 14).*

3. Avoid any act of choice or discrimination.

*This is the first practice of Ethics (ccxx. I. 22).*

4. Consider of six and fifty that  $50 \div 6 = 0.12$ .

0 the circumference, Nuit.

• the centre, Hadit.



1 the unity proceeding, Ra-Hoor-Khuit.

2 the world of illusion.

Nuit thus comprehends All in None.

Also  $50 + 6 = 56 = 5 + 6 = 11$ , the key of all Rituals.

And  $50 \times 6 = 300$ , the Spirit of the Child within.

(Note  $NF_{15} = 72$ , the Shemhamphorash and the Quinaries of the Zodiac, etc.)

*This is the second practice of Intelligence (ccxx. I. 24, 25).*

5. The Result of this Practice is the Consciousness of the Continuity of Existence, the Omnipresence of the Body of Nuit.

In other words, the Aspirant is conscious only of the Infinite Universe as a single Being.

[Note for this the importance of Paragraph 3.—Ed.]<sup>3</sup>

*This is the first Indication of the Nature of the Result (ccxx. I. 26).*

6. Meditate upon Nuit as the Continuous One resolved into None and Two as the phases of her being. [For the Universe being self-contained must be capable of expression by the formula  $(n - n) = 0$ . For if not, let it be expressed by the formula  $n - m = p$ . That is, the Infinite moves otherwise than within itself, which is absurd.—Ed.]

*This is the second practice of Meditation (ccxx. I. 27).*

7. Meditate upon the facts of Samadhi on all planes, the liberation of heat in chemistry, joy in natural history, Ananda in religion, when two things join to lose themselves in a third.

*This is the third practice of Meditation (ccxx. I. 28, 29, 30).*

8. Let the Aspirant pay utmost reverence to the Authority of the A ∴ A ∴ and follow Its instructions, and let him swear a great Oath of Devotion unto Nuit.

---

<sup>3</sup> All bracketed editor's comments found within the texts of Liber NV and Liber HAD are Crowley's.

*This is the second practice of Ethics (ccxx. I. 32).*

9. Let the Aspirant beware of the slightest exercise of his will against another being. Thus, lying is a better posture than sitting or standing, as it opposes less resistance to gravitation. Yet his first duty is to the force nearest and most potent; *e.g.* he may rise to greet a friend.

*This is the third practice of Ethics (ccxx. I. 41).*

10. Let the Aspirant exercise his will without the least consideration for any other being. This direction cannot be understood, much less accomplished, until the previous practice has been perfected.

*This is the fourth practice of Ethics (ccxx. I. 42, 43, 44).*

11. Let the Aspirant comprehend that these two practices are identical.

*This is the third practice of Intelligence (ccxx. I. 45).*

12. Let the Aspirant live the Life Beautiful and Pleasant. For this freedom hath he won. But let each act, especially of love, be devoted wholly to his true mistress, Nuit.

*This is the fifth practice of Ethics (ccxx. I. 51, 52, 61, 63).*

13. Let the Aspirant yearn toward Nuit under the stars of Night, with a love directed by his Magical Will, not merely proceeding from the heart.

*This is the first practice of Magick Art (ccxx. I. 57).*

14. The Result of this Practice in the subsequent life of the Aspirant is to fill him with unimaginable joys: to give him certainty concerning the nature of the phenomenon called death; to give him peace unutterable, rest, and ecstasy.

*This is the second Indication of the Nature of the Result (ccxx. I. 58).*

15. Let the Aspirant prepare a perfume of resinous woods and gums, according to his inspiration.

*This is the second practice of Magick Art (ccxx. I. 59).*

16. Let the Aspirant prepare a Pantacle, as follows:

Inscribe a circle within a Pentagram, upon a ground square or of such other convenient shape as he may choose. Let the circle be scarlet, the Pentagram black, the ground royal blue studded with golden stars.

Within the circle, at its centre, shall be painted a sigil that shall be revealed to the Aspirant by Nuit Herself.

And this Pentacle shall serve for a Telesmatic Image, or as an Eidolon, or as a Focus for the mind.

*This is the third practice of Magick Art (ccxx. I. 60).*

17. Let the Aspirant find a lonely place, if possible a place in the Desert of Sand, or if not, a place unfrequented, and without objects to disturb the view. Such are moorlands, fens, the open sea, broad rivers, and open fields. Also, and especially, the summits of mountains.

There let him invoke the Goddess as he hath Wisdom and Understanding so to do. But let this Invocation be that of a pure heart, *i.e.* a heart wholly devoted to Her, and let him remember that it is Hadit Himself in the most secret place thereof that invoceth. Then let this serpent Hadit burst into flame.

*This is the fourth practice of Magick Art (ccxx. I. 61).*

18. Then shall the Aspirant come a little to lie in her bosom.

*This is the third Indication of the Nature of the Result (ccxx. I. 61).*

19. Let the Aspirant stand upon the edge of a precipice in act or in imagination. And let him imagine and suffer the fear of falling.

Next let him imagine with this aid that the Earth is falling, and he with it, or he from it; and considering the infinity of space, let him excite the fear within him to the point of ecstasy, so that the most dreadful dream of falling that he hath ever suffered be as nothing in comparison.

*This is the fourth practice of Meditation (Instruction of V.V.V.V.V.)*

20. Thus having understood the nature of this Third Indication, let him in his Magick Rite fall from himself into Nuit, or expand into Her, as his imagination may compel him.

And at that moment, desiring earnestly the Kiss of Nuit, let him give one particle of dust, *i.e.*, let Hadit give himself up utterly to Her.

*This is the fifth practice of Magick Art (ccxx. I. 61).*

21. Then shall he lose all in that hour.

*This is the fourth Indication of the Nature of the Result (ccxx. I. 61).*

22. Let the Aspirant prepare a lovesong of rapture unto the Goddess, or let him be inspired by Her unto this.

*This is the sixth practice of Magick Art (ccxx. I. 63).*

23. Let the Aspirant be clad in a single robe. An “abbai” of scarlet wrought with gold is most suitable. [The abbai is not unlike the Japanese kimono. It must fold simply over the breast without belt or other fastening.—Ed.]

*This is the seventh practice of Magick Art (ccxx. I. 61).*

24. Let the Aspirant wear a rich head-dress. A crown of gold adorned with sapphires or diamonds with a royal blue cap of maintenance, or nemmes, is most suitable.

*This is the eighth practice of Magick Art (ccxx. I. 61).*

25. Let the Aspirant wear many jewels such as he may possess.

*This is the ninth practice of Magick Art (ccxx. I. 63).*

26. Let the Aspirant prepare an Elixir or libation as he may have wit to do.

*This is the tenth practice of Magick Art (ccxx. I. 63).*

27. Let the Aspirant invoke, lying supine, his robe spread out as it were a carpet.

*This is the eleventh practice of Magick Art (Instruction of V.V.V.V.V.)*

28. Summary. Preliminaries.

These are the necessary possessions.

1. The Crown or head-dress.
2. The Jewels.
3. The Pantacle.
4. The Robe.
5. The Song or Incantation.
6. The Place of Invocation.
7. The Perfume.
8. The Elixir.

29. Summary continued. Preliminaries.

These are the necessary comprehensions.

1. The Natures of Nuit and Hadit, and their relation.
2. The Mystery of the Individual Will.

30. Summary continued. Preliminaries.

These are the meditations necessary to be accomplished.

1. The discovery of Hadit in the Aspirant, and identification with Him.

2. The Continuous One.
3. The value of the Equation  $n + (-n)$ .
4. Cremnophobia.

31. Summary continued. Preliminaries.

These are the Ethical Practices to be accomplished.

1. Assertion of the Kether-point-of-view.
2. Reverence to the Order.
3. Abolition of human will.
4. Exercise of true will.
5. Devotion to Nuit throughout a beautified life.

32. Summary continued. The Actual Rite.

1. Retire to desert with crown and other insignia and implements.
2. Burn perfume.
3. Chant incantation.
4. Drink unto Nuit of the Elixir.
5. Lying supine, with eyes fixed on the stars, practice the sensation of falling into nothingness.
6. Being actually within the bosom of Nuit, let Hadit surrender Himself.

33. Summary concluded. The Results.

1. Expansion of consciousness to that of the Infinite.
2. "Loss of all" the highest mystical attainment.
3. True Wisdom and Perfect Happiness.

# LIBER HAD

## Sub Figura DLV

A.: A.:

### Publication in Class D

(for Winners of the Ordeal X).

000. This is the Book of the Cult of the Infinite Within.

00. The Aspirant is Nuit. Nuit is the infinite expansion of the Rose; Hadit the infinite concentration of the Rood. (*Instruction of V.V.V.V.V.*)

0. First let the Aspirant learn in his heart the Second Chapter of *The Book of the Law*. (*Instruction of V.V.V.V.V.*)

1. Worship, *i.e.*, identify thyself with, Nuit, as a lambent flame of blue, all-touching all-penetrant, her lovely hands upon the black earth, and her lithe body arched for love, and her soft feet not hurting the little flowers, even as She is imaged in the Stélé of Revealing.

*This is the first practice of Meditation (ccxx. I. 26).*

2. Let him further identify himself with the heart of Nuit, whose ecstasy is in that of her children, and her joy to see their joy, who sayeth: I love you! I yearn to you. Pale or purple, veiled or voluptuous, I who am all pleasure and purple, and drunkenness of the innermost sense, desire you. Put on the wings, and arouse the coiled splendour within you. Come unto me! . . . Sing the rapturous love-song unto me! Burn to me perfumes! Wear to me jewels! Drink to me, for I love you! I love you! I am the blue-lidded daughter of Sunset; I am the naked brilliance of the voluptuous night-sky. To me! To me!

*This is the second practice of Meditation (ccxx. I. 13, 61, 63, 64, 65).*

3. Let the Aspirant apply himself to comprehend Hadit as an unextended point clothed with Light ineffable. And let him beware lest he be dazzled by that Light.

*This is the first practice of Intelligence (ccxx. II. 2).*

4. Let the Aspirant apply himself to comprehend Hadit as the ubiquitous centre of every sphere conceivable.

*This is the second practice of Intelligence (ccxx. II. 3).*

5. Let the Aspirant apply himself to comprehend Hadit as the soul of every man, and of every star, conjoining this in his Understanding with the Word (ccxx. I. 2): "Every man and every woman is a star." Let this conception be that of Life, the giver of Life, and let him perceive that therefore the knowledge of Hadit is the knowledge of death.

*This is the third practice of Intelligence (ccxx. II. 6).*

6. Let the Aspirant apply himself to comprehend Hadit as the Magician or maker of Illusion, and the Exorcist or destroyer of Illusion, under the figure of the axle of the Wheel, and the cube in the circle. Also as the Universal Soul of Motion. [This conception harmonises Thoth and Harpocrates in a very complete and miraculous manner. Thoth is both the Magus of Taro (see *Liber 418*) and the Universal Mercury; Harpocrates both the destroyer of Typhon and the Babe on the Lotus. Note that the "Ibis position" formulates this conception most exactly.—Ed.]

*This is the fourth practice of Intelligence (ccxx. II. 7).*

7. Let the Aspirant apply himself to comprehend Hadit as the perfect, that is Not, and solve the mystery of the numbers of Hadit and his components by his right Ingenium.

*This is the fifth practice of Intelligence (ccxx. II. 15, 16).*



8. Let the Aspirant, bearing him as a great King, root out and destroy without pity all things in himself and his surroundings which are weak, dirty, or diseased, or otherwise unworthy. And let him be exceeding proud and joyous.

*This is the first practice of Ethics (ccxx. II. 18, 19, 20, 21).*

9. Let the Aspirant apply himself to comprehend Hadit as the Snake that giveth Knowledge and Delight and bright glory, who stirreth the hearts of men with drunkenness. This snake is blue and gold; its eyes are red, and its spangles green and ultra-violet. (That is, as the most exalted form of the Serpent Kundalini.)

*This is the sixth practice of Intelligence (ccxx. II. 22, 50, 51).*

10. Let him further identify himself with this Snake.

*This is the second practice of Meditation (ccxx. II. 22).*

11. Let the Aspirant take wine and strange drugs, according to his knowledge and experience, and be drunk thereof. [The Aspirant should be in so sensitive a condition that a single drop, perhaps even the smell, should suffice.—Ed.]

*This is the first practice of Magick Art (ccxx. II. 22).*

12. Let the Aspirant concentrate his consciousness in the Rood Cross set up upon the Mountain, and identify himself with It. Let him be well aware of the difference between Its own soul, and that thought which it habitually awakes in his own mind.

*This is the third practice of Meditation, and as it will be found, a comprehension and harmony and absorption of the practices of Intelligence (ccxx. II. 22).*

13. Let the Aspirant apply himself to comprehend Hadit as the Unity which is the Negative. [Ain Elohim.—Ed.]

*This is the seventh practice of Intelligence (ccxx. II. 23).*

14. Let the Aspirant live the life of a strong and beautiful being, proud and exalted, contemptuous of and fierce toward all that is base and vile.

*This is the second practice of Ethics (ccxx. II. 24, 25, 45-49, 52, 56-60).*

15. Let the Aspirant apply himself to comprehend Hadit according to this 26th verse of the Second Chapter of The Book of the Law. And this shall be easy for him if he have well accomplished the Third Practice of Meditation.

*This is the eighth practice of Intelligence (ccxx. II. 26).*

16. Let the Aspirant destroy Reason in himself according to the practice in Liber CDLXXIV.<sup>4</sup>

*This is the fourth practice of Meditation (ccxx. II. 27-33).*

17. Let the Aspirant observe duly the Feasts appointed by the A.: A.: and perform such rituals of the elements as he possesseth, invoking them duly in their season.

*This is the second practice of Magick Art (ccxx. II. 35-43).*

18. Let the Aspirant apply himself to comprehend Hadit as a babe in the egg of the Spirit [Akasha.—Ed.] that is invisible within the 4 elements.

*This is the ninth practice of Intelligence (ccxx. II. 49).*

19. The Aspirant seated in his Asana will suddenly commence to breathe strangely, and this without the Operation of

---

<sup>4</sup> *Liber Os Abyssi* Vel DAATH. In *The Equinox*, Vol. 1, no. 7 (York Beach, ME: Samuel Weiser, 1992), p. 77.

his will; the Inspiration will be associated with the thought of intense excitement and pleasure, even to exhaustion; and the Expiration very rapid and forceful, as if this excitement were suddenly released.

*This is the first and last Indication of the Sign of the Beginning of this Result (ccxx. II. 63).*

20. A light will appear to the Aspirant, unexpectedly. Hadit will arise within him, and Nuit concentrate Herself upon him from without. He will be overcome, and the Conjunction of the Infinite Without with the Infinite Within will take place in his soul, and the One be resolved into the None.

*This is the first Indication of the Nature of the Result (ccxx. II. 61, 62, 64).*

21. Let the Aspirant strengthen his body by all means in his power, and let him with equal pace refine all that is in him to the true ideal of Royalty. Yet let his formula, as a King's ought, be Excess.

*This is the third practice of Ethics (ccxx. II. 70, 71).*

22. To the Aspirant who succeeds in this practice the result goes on increasing until its climax in his physical death in its due season. This practice should however, prolong life.

*This is the second Indication of the Nature of the Result (ccxx. II. 66, 72-74).*

23. Let the Adept aspire to the practice of Liber XI. and preach to mankind.

*This is the fourth Practice of Ethics (ccxx. II. 76).*

24. Let the Adept worship the Name, foursquare, mystic, wonderful, of the Beast, and the name of His house; and give blessing and worship to the prophet of the lovely Star.

*This is the fifth practice of Ethics (ccxx. II. 78, 79).*

25. Let the Aspirant expand his consciousness to that of Nuit, and bring it rushing inward. It may be practised by imagining that the Heavens are falling, and then transferring the consciousness to them.

*This is the fifth practice of Meditation. (Instruction of V.V.V.V.V.)*

26. Summary. Preliminaries.

These are the necessary possessions.

1. Wine and strange drugs.

27. Summary continued. Preliminaries.

These are the necessary comprehensions.

1. The nature of Hadit (and of Nuit, and the relations between them).

28. Summary continued. Preliminaries.

These are the meditations necessary to be accomplished.

1. Identification with Nuit, body and spirit.
2. Identification with Hadit as the Snake.
3. Identification with Hadit as the Rood Cross.
4. Destruction of Reason.
5. The Falling of the Heavens.

29. Summary continued. Preliminaries.

These are the Ethical Practices to be accomplished.

1. The destruction of all unworthiness in one's self and one's surroundings.
2. Fulness, almost violence, of life.

30. Summary continued. Preliminaries.

These are the Magick Arts to be practised.

1. During the preparation, perform the Invocations of the Elements.
2. Observe the Feasts appointed by the A ∴ A ∴

31. Summary continued. The actual Practice.

1. Procure the suitable intoxication;
2. As Nuit, contract thyself with infinite force upon Hadit.

32. Summary continued. The Results.

1. Peculiar automatic breathing begins.
2. A light appears.
3. Samadhi of the two Infinities within aspirant.
4. Intensification of 3 on repetition.
5. Prolongation of life.
6. Death becomes the climax of the practice.

33. Summary concluded.

These are the practices to be performed in token of Thanksgiving for success.

1. Aspiration to Liber XI.
2. Preaching of  $\theta\epsilon\lambda\eta\mu\alpha$  to mankind.
3. Blessing and Worship to the prophet of the lovely Star.

## CHAPTER ELEVEN

---

# THELEMIC ORDERS

*2. In all systems of religion is to be found a system of Initiation, which may be defined as the process by which a man comes to learn that unknown Crown.*

*3. Though none can communicate either the knowledge or the power to achieve this, which we may call the Great Work, it is yet possible for initiates to guide others.*

—Liber LXI vel Causae

Before I began to organize the material for this handbook of rituals, I looked back over 20 years to when my struggle to study the Magick of Thelema began. It was as if I was thrust into post graduate work without ever finishing grammar school. I was singularly fortunate to make contact with several of Crowley's personal students who were kind enough to answer my questions and offer encouragement and invaluable suggestions. I learned that there is a step-by-step approach to the subjects, and I have endeavored to organize the material in this text along the same linear scale. Even though this is by no means a complete compendium of the rituals of Aleister Crowley, I am hopeful that it will be a valuable tool for both beginning and advanced students.

Because of my association with Crowley contemporaries, I am often asked if it is necessary to affiliate with an organization in order to become a Thelemic Magician. This question invariably disappoints me because it reveals that the querent is fundamentally ignorant of what it means to be a Thelemite.

No! One does *not* have to join any organization, society, order, club, association, fraternity, collegium, lodge, chapter, temple, coven, tribe, party, league, fellowship, union, guild, team, troop, or pact to be a Thelemite or practice Thelemic Magick.

*There is no law beyond Do what thou wilt.* The very term, "Thelemic organization," seems to be an oxymoron. A collection of militant individualists all endeavoring to do their own will—this sounds like a recipe for chaos; and in many instances it is precisely that. Yet Crowley seemed inspired by the thought of a New Aeon society that could merge the precepts of complete personal liberty with the necessities of self-imposed spiritual disciplines. He experimented along various lines but finally settled on two "Orders" which he hoped would flourish in the millennia following his death: the A.: A.: and the O.T.O.

## A.: A.:

The A.: A.:<sup>1</sup> was founded in 1907 by Crowley and George Cecil Jones. Based upon the classic Rosicrucian grade system of the Golden Dawn, the A.: A.: requires the Magician to actually achieve the states of consciousness and powers embodied in each of the ten Sephiroth (*i.e.*, the Magician is only an Adeptus Minor when he or she has actually achieved the Knowledge and Conversation of the Holy Guardian Angel).

The A.: A.: is not a lodge system, and is entirely secret. It is a testing order, not a teaching order. The Aspirant officially knows only one person in the Order, his or her superior. Each Magician is, for the most part, left alone to do the work as he or she sees fit. Ideally, contact with the superior is brief and infrequent, and can be characterized as being suggestive rather than instructive. Advancement to the next grade is simply a seal upon attainment.

---

<sup>1</sup> It is commonly believed that A.: A.: stands for Argenteum Astrum (Silver Star). I have been informed in no uncertain terms that this is not the case.

The superior is at least one grade ahead of the Aspirant and is theoretically capable of recognizing the initiatory level of his or her student. The superior is answerable to their superior, etc. After a certain level of attainment has been successfully achieved and recognized, the Aspirant can then take on a student and become part of the chain. While Crowley was alive, it was obvious who was at the top of this chain, and though the practical did not always align with the ideal, one could be reasonably confident in the system. Since his death, matters have become more confusing. The present situation is basically this:

Today there remain a number of individuals who had a formal A.: A.: relationship with Crowley or one of several of Crowley's students. Some of these individuals have chosen to continue to take on students, who in turn have taken on students, etc., etc. As the nature of these relationships is secret. There is no way, short of affiliation, to gauge the quality of the magical work done.

There are also a number of publicly advertised A.: A.:s (and groups hinting they are the "doorway" to the A.: A.:) which one may contact simply by answering their magazine ads. As Crowley stressed the privacy of the system, and particularly prohibited the exchange of any money (on pain of immediate expulsion) in connection with the A.: A.:, I tend to view such groups with a level of skepticism.

While I have no reason to doubt the sincerity or the competence of the individuals in either of the above categories, I must caution the reader against putting too much emphasis upon pedigrees and paperwork. The real work is always accomplished by the Aspirant alone. More often than not the student learns *in spite* of the teacher's effort to help, not as the result of it.

Answers will come as soon as the student is wise enough to formulate the questions. There is no reason to wait for an adept to appear and make the Great Work easier for you. Anyone who is serious about A.: A.: affiliation can immediately begin the work by reviewing the prescribed



material,<sup>2</sup> mapping out a regimen of study and practice and setting to work. If there is any validity to the concept of Secret Chiefs, such a display of determined sincerity will most certainly attract their attention and form the required inner plane contact. A bit of patience and tenacity is often required to locate a flesh and blood contact, but rest assured, they are out there. The reader is cautioned, however, against casually boasting of one's "A.: A.:" position or achievements if one is not indeed affiliated with the A.: A.:. Such pretense is likely to create a stumbling block to bona fide affiliation, and is also just bad manners.

Excerpts from *One Star in Sight*<sup>3</sup> follow, which provide a basic outline of the structure and duties of the graded system of the A.: A.:.

*The order of the S.S.*

Ipsissimus	10° = 1 <sup>o</sup>
Magus	9° = 2 <sup>o</sup>
Magister Templi	8° = 3 <sup>o</sup>

*The order of the R.C.*

(Babe of the Abyss—the link)

Adeptus Exemptus	7° = 4 <sup>o</sup>
Adeptus Major	6° = 5 <sup>o</sup>
Adeptus Minor	5° = 6 <sup>o</sup>

*The Order of the G.D.*

(Dominus Liminis—the link)

Philosophus	4° = 7 <sup>o</sup>
-------------	---------------------

<sup>2</sup> Israel Regardie conveniently compiled most of the necessary material, including the various Oaths and Tasks of the Grades, in *Gems from the Equinox* (Phoenix, AZ: Falcon Press, 1982).

<sup>3</sup> *Magick* (York Beach, ME: Samuel Weiser, 1989).

Practicus	3° = 8 <sup>o</sup>
Zelator	2° = 9 <sup>o</sup>
Neophyte	1° = 10 <sup>o</sup>
Probationer	0° = 0 <sup>o</sup>

**Student**—His business is to acquire a general intellectual knowledge of all systems of attainment, as declared in the prescribed books. (See curriculum.)

**Probationer**—His principal business is to begin such practices as he may prefer, and to write a careful record of the same for one year.

**Zelator**—His main work is to achieve complete success in Asana and Pranayama. He also begins to study the formula of the “Rosy Cross.”

**Practicus**—Is expected to complete his intellectual training, and in particular to study the Qabalah.

**Philosophus**—Is expected to complete his moral training. He is tested in Devotion to the Order.

**Dominus Liminis**—Is expected to show mastery of Pratyahara and Dharana.

**Adeptus (without)**—Is expected to perform the Great Work and to attain the Knowledge and Conversation of the Holy Guardian Angel.

**Adeptus (within)**—Is admitted to the practice of the formula of the Rosy Cross on entering the College of the Holy Ghost.

**Adeptus (Major)**—Obtains a general mastery of practical Magick, though without comprehension.

**Adeptus (Exemptus)**—Completes in perfection all these matters. He then either (a) becomes a Brother of the Left Hand Path or (b) is stripped of all his attainments and of himself as well, even of Holy Guardian Angel, and becomes a Babe of the Abyss, who, having transcended the Reason,

does nothing but grow in the womb of its mother. It then finds itself a Magister Templi.

**Magister Templi** (Master of the Temple)—Whose functions are fully described in Liber 418, as is this whole initiation from Adeptus Exemptus. See also "Aha!". His principal business is to tend his "Garden" of disciples and to obtain a perfect understanding of the Universe. He is a Master of Samadhi.

**Magus**—Attains to wisdom, declares his Law (see Liber I, vel Magi) and is a Master of all Magick in its greatest and highest sense.

**Ipsissimus**—Is beyond all this and beyond all comprehension of those lower degrees.



In the mid 1940s, Karl Germer, a key administrative officer of the O.T.O., wrote Crowley asking for a definitive statement regarding the difference between the A.: A.: and the O.T.O. The following is Crowley's reply.

The difference between the A.: A.: and the O.T.O. is very clear and simple. The A.: A.: is a sempiternal institution, and entirely secret. There is no communication between its members. Theoretically, a member knows only the superior who introduced him, and any person whom he himself has introduced. The Order is run on purely spiritual lines.

The object of membership is also entirely simple. The first objective is the Knowledge and Conversation of the Holy Guardian Angel. The next objective, omitting considerations for the present of the VI = V, and VII = IV degrees, is the crossing of the Abyss, and the attainment of mastership of the Temple. This is described very fully especially in Liber 418. Much less is written about the V = VI degree, i.e., the Knowledge and Conversation, because it is too secret and

individual. It is impossible to lay down conditions, or to describe the experiences involved in detail.

The O.T.O. has nothing to do with this, except that the BOOK OF THE LAW and the Word of the Aeon are essential principles of membership. In all other respects, it stands by itself as a body similar to Freemasonry, but involving acceptance of a social and economic system which is intended to put the world on its feet. There is also, of course, the secret of the IX<sup>o</sup> which is, so to say, the weapon which they may use to further these purposes.

666, September 16, 1946

## O.T.O.

In contrast to the A.: A.:, the O.T.O. (Ordo Templi Orientis) operates publicly and semi-publicly in a manner not dissimilar to modern Freemasonry. In fact, its founding father, Karl Kellner was a high-grade German Mason, who patterned the basic degree structure of the Order after the Blue Lodge, Royal Arch, Council Prince of Jerusalem, Rose-Croix and Kadosch degrees of continental Freemasonry.

Kellner traveled widely and was fascinated with the magical practices of the East and Near East. Reportedly, during one of his Burtonesque pilgrimages, he met three Adepts who progressively revealed to him a series of powerful magical techniques of a sexual nature. When he digested the full implications of this information, Kellner saw that this "Secret of Secrets" was the key which unlocked the mysteries of both Freemasonry and Christian Mysticism. He wasted no time in incorporating this revelation in the higher degrees of his local lodge. In 1902 the existence of the O.T.O. was revealed in *Oriflamme*, a German Masonic publication, and it was announced that the Order taught the "secret of sexual magic."

Crowley was given leadership of the O.T.O. in the English speaking world in 1912 and reworked the Degree

Rituals to conform with the *Liber AL* and the Law of Thelema. An excellent history of the Order is outlined in *The Equinox* Vol. III., Number 10<sup>4</sup> and I encourage anyone interested in the O.T.O. to review it.

Ordo Templi Orientis is more active today than it ever was during Crowley's lifetime. It has official bodies in 17 countries and provides Degree Initiations, Gnostic Masses, and an assortment of public and semi-public events including Crowley's Rites of Eleusis. The O.T.O. is without question the most visible Thelemic organization on earth.

There is no doubt that the series of dramatic rituals which comprise the O.T.O. Initiatory Degrees can have a lasting and profound magical effect upon the candidate. It is also true that fellowship with other Thelemites can be a rewarding and satisfying experience. But, as we mentioned above in our comments about the A.: A.:, the real work is done by the individual. No one can reveal to you a *real* secret. No one can project enlightenment upon you. If you expect affiliation with any organization is going to lighten your magical work load, you are mistaken; and if you are waiting for a teacher who embodies perfection, or a group in which there are no jerks, you will wait forever.

Below is a portion of one of Crowley's letter which first appeared in *Magick Without Tears* (Hampton, NJ: Thelema, 1954) which briefly outlines the system of the O.T.O.

...What is a Dramatic Ritual? It is a celebration of the Adventure of the God whom it is intended to invoke. (*The Bacchae* of Euripides is a perfect example of this.) Now, in the O.T.O., the object of the ceremony being the Initiation of the Candidate, it is he whose Path in Eternity is displayed in dramatic form.

What is the Path?

---

<sup>4</sup> (New York: Thelema Publications, 1986).

1. The Ego is attracted to the Solar System.
2. The Child experiences Birth.
3. The Man experiences Life.
4. He experiences Death.
5. He experiences the World beyond Death.
6. This entire cycle of Point-Events is withdrawn into Annihilation.

In the O.T.O. these successive stages are represented as follows:

1. 0° (Minerval)
2. I° (Initiation)
3. II° (Consecration)
4. III° (Devotion)
5. IV° (Perfection, or Exaltation)
6. P.I. (Perfect Initiate)

Of these Events or Stations upon the Path all but three (II°) are single critical experiences. We, however, are concerned mostly with the very varied experiences of Life.

All subsequent Degrees of the O.T.O. are accordingly elaboration of the II°, since in a single ceremony it is hardly possible to sketch, even in the briefest outline, the Teaching of Initiates with regard to Life. The Rituals V°-IX° are then instructions to the Candidate how he should conduct himself; and they confer upon him, gradually the Magical Secrets which make him Master of Life.



While Ordo Templi Orientis is a magical and fraternal organization, within the Order's matrix can be found a jewel which offers all aspirants a unique and beautiful medium for Thelemic religious expression. It is the central ritual of the O.T.O., public and private—The Mass of Ecclesia Gnostica Catholica.

## CHAPTER TWELVE

---

# THE RELIGION OF THELEMA

*One of the simplest and most complete Magick ceremonies is the Eucharist. It consists in taking common things, transmuting them into things divine, and consuming them.*

—Magick in Theory and Practice.

It is no accident that I have chosen to make *Liber XV* the final chapter of this handbook of the rituals of Aleister Crowley. Anyone who has had the privilege of celebrating the Gnostic Mass will understand that I have saved the best for last. This eucharistic ceremony exquisitely expresses the purest elements of Thelemic cosmology and philosophy; and it does so in such a manner that it can be appreciated by the broadest possible spectrum of truth seekers.

The “Law is for all” and as fascinating as the study of Thelemic Magick may be for many of us, the fact remains that the vast majority of the population will never be attracted to the theories and techniques we have discussed in the previous chapters of this book. Nor does their disinterest in the technical aspects of Magick exclude them from embracing the Law of Thelema, or applying the formulae of the New Aeon to their lives.

Like the Roman or Orthodox Mass of the Aeon of Osiris, *Liber XV* serves to bring the community together to affirm a

common creed, and provides an opportunity for all to participate directly in the magical formulae of the Age. Today, largely due to the growth of the O.T.O., the Gnostic Mass is regularly celebrated world-wide. It is used to observe the feast days of *The Book of the Law*, and to mark the Thelemic community's births, rites of passage, marriages, and deaths. For the Initiate, *Liber XV* is a treasure-house of technical information relating to a supreme technique of High Magick; but for all of us, it is a joyous feast, an act of worship, and the celebration of a miracle.



**LIBER XV**  
**O.T.O.**  
**ECCLESIAE GNOSTICAE**  
**CATHOLICAE CANON MISSAE**  
*Edited from the Ancient Documents in*  
*Assyrian and Greek by The Master Therion<sup>1</sup>*

**I**

**OF THE FURNISHINGS OF THE TEMPLE**

In the East, that is, in the direction of Boleskine, which is situated on the South-Eastern shore of Loch Ness in Scotland, two miles east of Foyers, is a shrine or High Altar. Its dimensions should be 7 feet in length, 3 feet in breadth, 44 inches in height.<sup>2</sup> It should be covered with a crimson altar-cloth, on which may be embroidered fleur-de-lys in gold, or a sun-blaze, or other suitable emblem.

On each side of it should be a pillar or obelisk, with countercharges in black and white.

Below it should be the dais of three steps, in black and white squares.

Above it is the super-altar, at whose top is the Stélé of Revealing in reproduction, with four candles on each side of it. Below the Stélé is a place for *The Book of the Law*, with six candles on each side of it. Below this again is the Holy Graal, with roses on each side of it. There is room in front of the Cup for the Paten. On each side beyond the roses are two great candles.

---

<sup>1</sup> Written in 1915 while visiting Moscow. The Master Therion is of course Aleister Crowley.—*Ed.*

<sup>2</sup> These are the dimensions of the sarcophagus in the King's Chamber of the Great Pyramid at Giza.—*Ed.*

All this is enclosed within a great Veil.

Forming the apex of an equilateral triangle whose base is a line drawn between the pillars, is a small black square altar, of superimposed cubes.

Taking this altar as the middle of the base of a similar and equal triangle, at the apex of this second triangle is a small circular font.

Repeating, the apex of a third triangle is an upright tomb.

## II

### OF THE OFFICERS OF THE MASS

The PRIEST: Bears the Sacred Lance, and is clothed at first in a plain white robe.

The PRIESTESS: Should be actually *Virgo Intacta* or specially dedicated to the service of the Great Order. She is clothed in white, blue, and gold. She bears the Sword from a red girdle, and the Paten and Hosts, or Cakes of Light.

The DEACON: He is clothed in white and yellow. He bears *The Book of the Law*.

Two CHILDREN: They are clothed in white and black. One bears a pitcher of water and a cellar of salt, the other a censer of fire and a casket of perfume.

## III

### OF THE CEREMONY OF THE INTROIT

The DEACON, opening the door of the Temple, admits the congregation and takes his stand between the small altar and the font. (There should be a doorkeeper to attend to the admission.) The DEACON advances and bows before the open shrine where the Graal is exalted. He kisses The Book of

the Law, three times, opens it, and places it upon the super-altar. He turns West.

**The DEACON: Do what thou wilt shall be the whole of the Law. I proclaim the Law of Light, Life, Love, and Liberty in the name of IAΩ.**

**The CONGREGATION: Love is the law, love under will.**

The DEACON goes to his place between the altar of incense and the font, faces East, and gives the step and sign of a Man and a Brother. All imitate him.<sup>3</sup>

**The DEACON and all the PEOPLE: I believe in one secret and ineffable LORD; and in one Star in the Company of Stars of whose fire we are created, and to which we shall return; and in one Father of Life, Mystery of Mystery, in His name CHAOS, the sole viceregent of the Sun upon the Earth; and in one Air the nourisher of all that breathes.**

**And I believe in one Earth, the Mother of us all, and in one Womb wherein all men are begotten, and wherein they shall rest, Mystery of Mystery, in Her name BABALON.**

**And I believe in the Serpent and the Lion, Mystery of Mystery, in His name BAPHOMET.**

**And I believe in one Gnostic and Catholic Church of Light, Life, Love and Liberty, the Word of whose Law, is ΘΕΛΗΜΑ.**

**And I believe in the communion of Saints.**

**And, forasmuch as meat and drink are transmuted in us daily into spiritual substance, I believe in the Miracle of the Mass.**

**And I confess one Baptism of Wisdom whereby we accomplish the Miracle of Incarnation.**

---

<sup>3</sup> Many of the steps and signs are for the benefit of O.T.O. initiates only and need not concern nonmembers.—*Ed.*

**And I confess my life one, individual, and eternal that was, and is and is to come.**

AYMΓN. AYMΓN. AYMΓN.

Music is now played. The child enters with the ewer and the salt. The VIRGIN enters with the Sword and the Paten. The child enters with the censer and the perfume. They face the DEACON, deploying into line, from the space between the two altars.

### ***The VIRGIN: Greeting of Earth and Heaven!***

All give the Hailing sign of a Magician,<sup>4</sup> the DEACON leading.

The PRIESTESS, the negative child on her left, the positive child on her right, ascends the steps of the High Altar. They await her below. She places the Paten before the Graal. Having adored it, she descends, and with the children following her, the positive next her, she moves in a serpentine manner involving 3 1/2 circles of the Temple. (Deosil about altar, widdershins about font, deosil about altar and font, widdershins about altar, and so to the Tomb in the West.) She draws her Sword and pulls down the Veil therewith.

***The PRIESTESS: By the power of † Iron, I say unto thee, Arise. In the name of our Lord † the Sun, and of our Lord † ...that thou mayst administer the virtues to the Brethren.***

She sheathes the Sword.

---

<sup>4</sup> The Hailing Sign of a Magician: Press the right hand to form a square. Throw the left hand up, perpendicularly [upward] to form a square. Throw the left hand up, with the left arm horizontal from the shoulder to the elbow, and perpendicular from the elbow to the ends of the fingers, with the thumb and forefinger forming a square.

The PRIEST, issuing from the Tomb, holding the Lance erect with both hands, right over left, against his breast, takes the first three regular steps. He then gives the Lance to the PRIESTESS, and gives the three penal signs. He then kneels and worships the Lance with both hands. Penitential music.

**The PRIEST: I am a man among men.**

He takes again the Lance, and lowers it. He rises.

**The PRIEST: How should I be worthy to administer the virtues to the Brethren?**

The PRIESTESS takes from the child the water and the salt, and mixes them in the font.

**The PRIESTESS: Let the salt of Earth admonish the water to bear the virtue of the Great Sea. (Genuflects.) Mother, be thou adored.**

She returns to the West. † on PRIEST with open hand doth she make, over his forehead, breast, and body.

**Be the PRIEST pure of body and soul!**

The PRIESTESS takes the censer from the child, and places it on the small altar. She puts incense therein.

**Let the Fire and the Air make sweet the world! (Genuflects.) Father be thou adored.**

She returns West, and makes † with the censer before the PRIEST, thrice as before.

**Be the PRIEST fervent of body and soul!**

The children resume their weapons as they are done with.

The DEACON now takes the consecrated Robe from High Altar, and brings it to her. She robes the PRIEST in his Robe of scarlet and gold.

**Be the flame of the Sun thine ambience, O thou PRIEST of the SUN!**

The DEACON brings the crown from the High Altar. (The crown may be of gold or platinum, or of electrum magicum; but with no other metals save the small proportions necessary to a proper alloy. It may be adorned with divers jewels, at will. But it must have the Uraeus serpent twined about it, and the cap of maintenance must match the scarlet of the Robe. Its texture should be velvet.)

**Be the Serpent thy crown, O thou PRIEST of the LORD!**

Kneeling, she takes the Lance, between her open hands, and runs them up and down upon the shaft eleven times, very gently.

**Be the LORD present among us!**

ALL give the Hailing Sign.

*The PEOPLE:* So mote it be.

#### IV

### OF THE CEREMONY OF THE OPENING OF THE VEIL

*The PRIEST:* Thee therefore whom we adore we also invoke.

**By the power of the lifted Lance!**

He raises the Lance. ALL repeat Hailing Sign. A phrase of triumphant music. The PRIEST takes the PRIESTESS by her right hand with his left, keeping the Lance raised.

**I, PRIEST and KING, take thee Virgin pure without spot; I upraise thee; I lead thee to the East; I set thee upon the summit of the Earth.**

He thrones the PRIESTESS upon the altar. The DEACON and the children follow, they in rank, behind him. The PRIESTESS takes *The Book of the Law*, resumes her seat, and

holds it open on her breast with her two hands, making a descending triangle with thumbs and forefingers. The PRIEST gives the lance to the DEACON to hold, and takes the ewer from the child, and sprinkles the PRIESTESS, making five crosses, forehead, shoulders, and thighs. The thumb of the PRIEST is always between his index and medius, whenever he is not holding the Lance. The PRIEST takes the censer from the child, and makes five crosses, as before. The children replace their weapons on their respective altars. The PRIEST kisses The Book of the Law three times. He kneels for a space in adoration, with joined hands, knuckles closed, thumb in position aforesaid. He rises, and draws the veil over the whole altar. All rise and stand to order. The PRIEST takes the lance from the DEACON, and holds it as before, as Osiris or Pthah. He circumambulates the Temple three times, followed by the DEACON and the children as before. (These, when not using their hands, keep their arms crossed upon their breasts.) At the last circumambulation they leave him, and go to the place between the font and the small altar, where they kneel in adoration, their hands joined palm to palm, and raised above their heads. All imitate this motion. The PRIEST returns to the East, and mounts the first step of the altar.

***The PRIEST: O circle of Stars whereof our Father is but the younger brother, marvel beyond imagination, soul of infinite space, before whom Time is Ashamed, the mind bewildered, and the understanding dark, not unto Thee may we attain, unless Thine image be Love. Therefore by seed and root and stem and bud and leaf and flower and fruit do we invoke Thee.***

**Then the priest answered & said unto the Queen of Space, kissing her lovely brows, and the dew of her light bathing his whole body in a sweet-smelling perfume of sweat: O Nuit, continuous one of Heaven, let it be ever thus; that men speak not of Thee as One but as None; and let them speak not of thee at all, since thou art continuous!**

During this speech the PRIESTESS must have divested herself completely of her robe. See CCXX I: 62.

***The PRIESTESS:*** But to love me is better than all things: if under the night-stars in the desert thou presently burnest mine incense before me, invoking me with a pure heart, and the Serpent flame therein, thou shalt come a little to lie in my bosom. For one kiss wilt thou then be willing to give all; but whoso gives one particle of dust shall lose all in that hour. Ye shall gather goods and store of women and spices; ye shall wear rich jewels; ye shall exceed the nations of the earth in splendour and pride; but always in the love of me, and so shall ye come to my joy. I charge you earnestly to come before me in a single robe, and covered with a rich head-dress. I love you! I yearn to you! Pale or purple, veiled or voluptuous, I who am all pleasure and purple, and drunkenness of the innermost sense, desire you. Put on the wings, and arouse the coiled splendour within you: come unto me! To me! To Me! Sing the rapturous love-song unto me! Burn to me perfumes! Wear to me jewels! Drink to me, for I love you! I love you. I am the blue-lidded daughter of Sunset; I am the naked brilliance of the voluptuous night-sky. To me! To me!

The PRIEST mounts the second step.

***The PRIEST:*** O secret of secrets that art hidden in the being of all that lives, not Thee do we adore, for that which adoreth is also Thou. Thou art That, and That am I.

I am the flame that burns in every heart of man, and in the core of every star. I am Life, and the giver of Life; yet therefore is the knowledge of me the knowledge of death. I am alone; there is no God where I am.

The DEACON and all rise to their feet, with the Hailing sign.

***The DEACON:*** But ye, O my people rise up and awake. Let the rituals be rightly performed with joy and beauty.



**There are rituals of the elements and feasts of the times.  
A feast for the first night of the Prophet and his Bride.  
A feast for the three days of the writing of the Book of  
the Law.  
A feast for Tahuti and the child of the Prophet—secret O  
Prophet!  
A feast for the Supreme Ritual, and a feast for the Equinox  
of the Gods.  
A feast for fire and a feast for water; a feast for life and a  
greater feast for death.  
A feast every day in your hearts in the joy of my rapture.  
A feast every night unto Nu, and the pleasure of uttermost  
delight.**

The PRIEST mounts the third step.

*The* PRIEST: Thou that art One, our Lord in the Universe  
the Sun, our Lord in ourselves whose name is Mystery of  
Mystery, uttermost being whose radiance enlightening the  
worlds is also the breath that maketh every God even and  
Death to tremble before Thee—By the Sign of Light †  
appear Thou glorious upon the throne of the Sun.

Make open the path of creation and of intelligence  
between us and our minds. Enlighten our understanding.

Encourage our hearts. Let thy light crystalize itself in  
our blood, fulfilling us of Resurrection.

A ka dua  
Tuf ur biu  
bi a'a chefu  
Dudu nur af an nuteru.<sup>5</sup>

*The* PRIESTESS: There is no law beyond Do what thou  
wilt.

---

<sup>5</sup> "Unity uttermost showed! I adore the might of Thy breath, supreme and  
terrible God, who makest the Gods and Death to tremble before Thee: I, I  
adore Thee!"

The PRIEST parts the veil with his lance. During the previous speeches the PRIESTESS has, if necessary, as in savage countries, resumed her robe.

**The PRIEST:** ΙΩ ΙΩ ΙΩ ΙΑΩ ΣΑΒΑΟ ΚΥΡΙΗ ΑΒΡΑΣΑΧ ΚΥΡΙΗ ΜΕΙΘΡΑΣ ΚΥΡΙΗ ΦΑΛΛΗ. ΙΩ ΠΑΝ, ΙΩ ΠΑΝ ΠΑΝ ΙΩ ΙΣΧΥΡΟΣ, ΙΩ ΑΘΑΝΑΤΟΝ ΙΩ ΑΒΡΟΤΟΝ ΙΩ ΙΑΩ. ΧΑΙΡΕ ΦΑΛΛΗ ΧΑΙΡΕ ΠΑΝΦΑΓΗ ΧΑΙΡΕ ΠΑΝΓΕΝΕΤΟΡ. ΑΓΙΟΣ, ΑΓΙΟΣ, ΑΓΙΟΣ ΙΑΩ.<sup>6</sup>

The PRIESTESS is seated with the Paten in her right hand and the cup in her left. The PRIEST presents the Lance, which she kisses eleven times. She then holds it to her breast, while the PRIEST, falling at her knees, kisses them, his arms stretched along her thighs. He remains in this adoration while the DEACON intones the Collects. All stand to order, with the Dieu Garde, that is, feet square, hands, with linked thumbs, held loosely. This is the universal position when standing, unless other direction is given.

## V

### OF THE OFFICE OF THE COLLECTS WHICH ARE ELEVEN IN NUMBER

#### *The Sun*

**The DEACON:** Lord visible and sensible of whom this earth is but a frozen spark turning about thee with annual and diurnal motion, source of light, source of life, let thy

---

<sup>6</sup> IO IO IO IAO SABAO, Lord ABRASAX, Lord MITHRAS, Lord PHALLUS. IO PAN, IO PAN PAN, IO powerful, IO deathless, IO woundless, IO IAO. Hail PHALLUS, hail all-devourer, hail father of all. Holy, Holy, Holy, IAO.

perpetual radiance hearten us to continual labour and enjoyment; so that as we are constant partakers of thy bounty we may in our particular orbit give out light and life, sustenance and joy to them that revolve about us without diminution of substance or effulgence for ever.

*The PEOPLE:* So mote it be.

*The Lord*

*The DEACON:* Lord secret and most holy, source of life, source of love, source of liberty, be thou ever constant and mighty within us, force of energy, fire of motion; with diligence let us ever labour with thee, that we may remain in thine abundant joy.

*The PEOPLE:* So mote it be.

*The Moon*

*The DEACON:* Lady of night, that turning ever about us art now visible and now invisible in thy season, be thou favourable to hunters, and lovers, and to all men that toil upon the earth, and to all mariners upon the sea.

*The PEOPLE:* So mote it be.

*The Lady*

*The DEACON:* Giver and receiver of joy, gate of life and love, be thou ever ready, thou and thine handmaiden, in thine office of gladness.

*The PEOPLE:* So mote it be.

*The Saints*

**The DEACON:** Lord of Life and Joy, that art the might of man, that art the essence of every true god that is upon the surface of the Earth, continuing knowledge from generation unto generation, thou adored of us upon heaths and in woods, on mountains and in caves, openly in the market-places and secretly in the chambers of our houses, in temples of gold and ivory and marble as in these other temples of our bodies, we worthily commemorate them worthy that did of old adore thee and manifest thy glory unto men,

At each name the DEACON signs † with thumb between index and medius. At ordinary mass it is only necessary to commemorate those whose names are italicized, with word as shown.

*Laotze and Siddartha and Krishna and Tahuti, Mosheh, Dionysus, Mohammed and To Mega Therion, with these also Hermes, Pan, Priapus, Osiris and Melchizedek, Khem and Amoun and Mentu, Heracles, Orpheus and Odysseus; with Vergilius, Catullus, Martialis, Rabelais, Swinburne, and many an holy bard; Apollonius Tyanaeus, Simon Magus, Manes, Pythagoras, Basilides, Valentinus, Bardesanes and Hippolytus, that transmitted the Light of the Gnosis to us their successors and their heirs; with Merlin, Arthur, Kamuret, Parzival, and many another, prophet, priest and king, that bore the Lance and Cup, the Sword and Disk, against the Heathen; and these also, Carolus Magnus and his paladins, with William of Schyren, Frederick of Hohenstaufen, Roger Bacon, Jacobus Burgundus Molensis the Martyr, Christian Rosencrentz, Ulrich von Hutten, Paracelsus, Michael Maier, Roderic Borgia Pope Alexander the Sixth, Jacob Boehme, Francis Bacon Lord Verulam, Andrea, Robertus de Fluctibus, Johannes Dee, Sir Edward Kelly, Thomas Vaughan, Elias Ashmole, Molinos, Adam Weishaupt, Wolfgang von Goethe, Ludovicus Rex Bavariae, Richard Wagner, Alphonse Louis Constant, Friedrich*

**Nietzche, Hargrave Jennings, Karl Kellner, Forlong dux, Sir Richard Payne Knight, Paul Gaugin, Sir Richard Francis Burton, Doctor Gerard Encausse, Doctor Theodor Reuss, and Sir Aleister Crowley—Oh Sons of the Lion and the Snake! with all thy saints we worthily commemorate them worthy that were and are and are to come.**

**May their Essence be her present, potent, puissant and paternal to perfect this feast!**

*The PEOPLE: So mote it be.*

### *The Earth*

**The DEACON: Mother of fertility on whose breast lieth water, whose cheek is caressed by air, and in whose heart is the sun's fire, womb of all life, recurring grace of seasons, answer favorable the prayer of labour, and to pastors and husbandmen be thou propitious.**

*The PEOPLE: So mote it be.*

### *The Principles*

**The DEACON: Mysterious Energy, triform, mysterious Matter, in fourfold and sevenfold division, the interplay of which things weave the dance of the Veil of Life upon the Face of the Spirit, let there be Harmony and Beauty in your mystic loves, that in us may be health and wealth and strength and divine pleasure according to the Law of Liberty; let each pursue his Will as a strong man that rejoiceth in his way, as the course of a Star that blazeth for ever among the joyous company of Heaven.**

*The PEOPLE: So mote it be.*

### *Birth*

**The DEACON:** Be the hour auspicious, and the gate of life open in peace and in well-being, so that she that beareth children may rejoice, and the babe catch life with both hands.

**The PEOPLE:** So mote it be.

### *Marriage*

**The DEACON:** Upon all that this day unite with love under will let fall success; may strength and skill unite to bring forth ecstasy, and beauty answer beauty.

**The PEOPLE:** So mote it be.

### *Death<sup>7</sup>*

**The DEACON:** Term of all that liveth, whose name is inscrutable, be favourable unto us in thine hour.

**The PEOPLE:** So mote it be.

### *The End*

**The DEACON:** Unto them from whose eyes the veil of life hath fallen may there be granted the accomplishment of their true Wills; whether they will absorption in the Infinite, or to be united with their chosen and preferred, or to be in contemplation, or to be at peace, or to achieve the

---

<sup>7</sup> "All stand, Head erect, Eyes open." *Magick in Theory and Practice*.

**labour and heroism of incarnation on this planet or another, or in any Star, or aught else, unto them may there be grated the accomplishment of their wills; yea, the accomplishment of their wills. AUMGN. AUMGN. AUMGN.**

*The PEOPLE: So mote it be.*

## VI

### OF THE CONSECRATION OF THE ELEMENTS

The PRIEST makes five crosses.  $+3+1+2$  on paten and cup;  $+4$  on paten alone;  $+$  on cup alone.

***The PRIEST: Life of man upon earth, fruit of labour, sustenance of endeavour, thus be thou nourishment of the Spirit!***

He touches the Host with the Lance.

**By the virtue of the Rod  
Be this bread the Body of God!**

He takes the Host.

TOYTO EETI TO ΣΟΜΑ ΜΟΥ.<sup>8</sup>

He kneels, adores, rises turns shows Host to the PEOPLE, turns, replaces Host, and adores. Music. He takes the Cup.

***Vehicle of the joy of Man upon earth, solace of labour, inspiration of endeavour, thus be thou ecstasy of the Spirit!***

He touches the Cup with the Lance.

**By the virtue of the Rod  
Be this wine the Blood of God!**

He takes the Cup.

---

<sup>8</sup> This is my body.

TOYTO ΕΣΤΙ ΤΟ ΠΟΤΗΡΙΟΝ ΤΟΥ ΑΙΜΑΤΟΣ ΜΟΥ.<sup>9</sup>

He kneels, adores, rises turns shows Cup to the PEOPLE, turns, replaces Cup, and adores. Music.

**For this is the Covenant of Resurrection.**

He makes the five crosses on the PRIESTESS.

**Accept, O LORD, this sacrifice of life and joy, true warrants of the Covenant of Resurrection.**

The PRIEST offers the Lance to the PRIESTESS, who Kisses it; he then touches her between the breasts and upon the body. He then flings out his arms upward, as comprehending the whole shrine.

**Let this offering be borne upon the waves of Aethyr to our Lord and Father the Sun that travelleth over the Heavens in his name ON.**

He closes his hands, kisses the PRIESTESS between the breasts, and makes three great crosses over the Paten, the Cup, and himself. He strikes his breast. All repeat this action.

**Hear ye all, saints of the true church of old time now essentially present, that of ye we claim heirship, with ye we claim communion, from ye we claim benediction in the name of ΙΑΩ.**

He makes three crosses on Paten and Cup together. He uncovers the Cup, genuflects, takes the Cup in his left hand and the Host in his right. With the Host he makes the five crosses on the Cup

+1  
+3    +2  
+5    +4

---

<sup>9</sup> This is the cup of my blood.



He elevates the Host and Cup. The Bell strikes.

ΑΓΙΟΣ ΑΓΙΟΣ ΑΓΙΟΣ ΙΑΩ.<sup>10</sup>

He replaces the Host and the Cup, and adores.

## VII

### OF THE OFFICE OF THE ANTHEM

*The* PRIEST:

Thou who art I, beyond all I am,  
Who hast no nature and no name,  
Who art, when all but thou are gone,  
Thou, centre and secret of the Sun,  
Thou, hidden spring of all things known  
And unknown, Thou aloof, alone,  
Thou, the true fire within the reed  
Brooding and breeding, source and seed  
Of life, love, liberty, and light,  
Thou beyond speech and beyond sight,  
Thee I invoke, my faint fresh fire  
Kindling as mine intents aspire.  
Thee I invoke, abiding one,  
Thee, centre and secret of the Sun,  
And that most holy mystery  
Of which the vehicle am I.  
Appear, most awful and most mild,  
As it is lawful, in thy child!

*The* CHORUS:

For of the Father and the Son  
The Holy Spirit is the norm;

---

<sup>10</sup> Holy, Holy, Holy, IAO!

**Male-female, quintessential, one,  
Man-being veiled in woman-form.  
Glory and worship in the highest,  
Thou Dove, mankind that deifiest,  
Being that race, most royally run  
To spring sunshine through winter storm.  
Glory and worship be to Thee,  
Sap of the world-ash, wonder-tree!**

*First Semichorus, MEN:*

**Glory to thee from gilded tomb!**

*Second Semichorus, WOMEN:*

**Glory to thee from waiting womb!**

**MEN:**

**Glory to thee from earth unploughed!**

**WOMEN:**

**Glory to thee from virgin vowed!**

**MEN:**

**Glory to thee, true Unity  
Of the eternal Trinity!**

**WOMEN:**

**Glory to thee, thou sire and dam  
And self of I am that I am!**

**MEN:**

**Glory to thee, beyond all term,  
Thy spring of sperm, thy seed and germ!**

**WOMEN:**

**Glory to thee, eternal Sun,  
Thou One in Three, Thou Three in One!**

**CHORUS:**

**Glory and worship be to Thee,  
Sap of the world-ash, wonder- tree!**

These words are to form the substance of the anthem; but the whole or any part thereof shall be set to music, which may be as elaborate as art can devise. But even should other anthems be authorized by the Father of the Church, this shall hold its place as the first of its kind, the father of all others.

**VIII**

**OF THE MYSTIC MARRIAGE AND  
CONSUMMATION OF THE ELEMENTS**

The **PRIEST** takes the Paten between the index and medius of the right hand. The **PRIESTESS** clasps the Cup in her right hand.

*The **PRIEST**: Lord most secret, bless this spiritual food unto our bodies, bestowing upon us health and wealth and strength and joy and peace, and that fulfillment of will and love under will that is perpetual happiness.*

He makes **+** with Paten and kisses it. He uncovers the Cup, genuflects, rises. Music. He takes the Host, and breaks it over the Cup. He replaces the right-hand portion in the Paten. He breaks off a particle of the left-hand portion.

ΤΟΥΤΟ ΕΣΤΙ ΤΟ ΣΠΕΡΜΑ ΜΟΥ. Ο ΠΑΤΗΡ ΕΣΤΙΝ Ο ΗΥΙΟΣ ΔΙΑ ΤΟ ΠΝΕΥΜΑ ΑΓΙΟΝ. ΑΥΜΓΝ. ΑΥΜΓΝ. ΑΥΜΓΝ.<sup>11</sup>

He replaces the left-hand part of the Host. The **PRIESTESS** extends the Lance-point with her left hand to receive the

---

<sup>11</sup> This is my seed. The Father is the Son as the Holy Ghost. AUMGN, AUMGN, AUMGN.

particle. The PRIEST clasps the Cup in his left hand. Together they depress the Lance-point in the Cup.

***The PRIEST and the PRIESTESS: HPIAIY.***<sup>12</sup>

The PRIEST<sup>13</sup> takes the Lance. The PRIESTESS covers the Cup. The PRIEST genuflects, rises bows, joins hands. He strikes his breast.

***The PRIEST: O Lion and O Serpent that destroy the destroyer, be mighty among us.***

***O Lion and O Serpent that destroy the destroyer, be mighty among us.***

***O Lion and O Serpent that destroy the destroyer, be mighty among us.***

The PRIEST joins hands upon the breast of the PRIESTESS, and takes back his Lance. He turns to the People, lowers and raises the Lance, and makes † upon them.

***Do what thou wilt shall be the whole of the Law.***

***The PEOPLE: Love is the law, love under will.***

He lowers the Lance, and turns East. The PRIESTESS takes the Lance in her right hand. With her left hand she offers the Paten. The PRIEST kneels.

***The PRIEST: In my mouth be the essence of the life of the Sun!***

He takes the Host with the right hand, makes † with it on

---

<sup>12</sup> HRILIU. The sound of mating doves. The cry of ecstasy.—*Ed.*

<sup>13</sup> I believe this should be "PRIESTESS takes the Lance."—*Ed.*

the Paten, and consumes it. Silence. The PRIESTESS takes, uncovers, and offers the Cup, as before.

***The PRIEST: In my mouth be the essence of the joy of the earth!***

He takes the Cup, makes † on the PRIESTESS, drains it and returns it. Silence. He rises, takes the Lance, and turns to the PEOPLE.

***The PRIEST: There is no part of me that is not of the Gods.***

Those of the PEOPLE who intend to communicate, and no other should be present, having signified their intention, a whole Cake of Light, and a whole goblet of wine, have been prepared for each one. The DEACON marshals them; they advance one by one to the altar. The children take the Elements and offer them. The PEOPLE communicate as did the PRIEST, uttering the same words in an attitude of Resurrection: "There is no part of me that is not of the Gods." The exceptions to this part of the ceremony are when it is of the nature of a celebration, in which case none but the PRIEST communicate; or part of the ceremony of marriage, when none other, save the two to be married, partake; part of the ceremony of baptism, when only the child baptised partakes; and of Confirmation at puberty, when only the persons confirmed partake. The Sacrament may be reserved by the PRIEST, for administration to the sick in their homes.

The PRIEST closes all within the veil. With the Lance he makes † on the people thrice, thus.

***The PRIEST: † The LORD bless you.***

***† The LORD enlighten your minds and comfort your hearts and sustain your Bodies.***

**✝ The LORD bring you to the accomplishment of your true Wills, the Great Work, the Summun Bonum, True Wisdom and Perfect Happiness.**

He goes out, the DEACON and children following, into the Tomb of the West. Music. (Voluntary.)

NOTE: The PRIESTESS and other officers never partake of the Sacrament, they being as it were part of the PRIEST himself.

NOTE: Certain secret Formulae of this Mass are taught to the PRIEST in his Ordination.

/

## BIBLIOGRAPHY

Budge, E. A. Wallis. *The Book of the Dead*. New York: Dover, 1967.

———. *Osiris, The Egyptian Religion of Resurrection*. New Hyde Park, NY: University Books, 1961.

Campbell, Joseph. *The Power of Myth*. New York: Doubleday, 1988.

———. *The Hero with a Thousand Faces*. New York: Meridian, 1956.

Cammell, Charles Richard. *Aleister Crowley—The Man: The Mage: The Poet*. New Hyde Park, NY: University Books, 1962.

Cassaubon, Meric. *A True and Faithful Relation of What Passed For Many Years Between Dr. John Dee and Some Spirits*. London, 1659. Reprint. London: Askin, 1974. Reprint, with introduction by Lon Milo DuQuette. New York: Magickal Child Publishing Inc., 1992.

Crowley, Aleister. *Book Four, Parts I, II, III, IV*. Ed. Hymenaeus Beta. York Beach, ME: Samuel Weiser, 1993.

———. *The Book of Lies*. York Beach, ME: Samuel Weiser, 1992.

———. *The Book of Thoth. A Short Essay on the Tarot of the Egyptians*. The Master Therion. London: O.T.O., 1944. *The Equinox* III (5). Facsimile edition. York Beach, ME: Samuel Weiser, 1991.

———. *The Complete Astrological Writings*. Ed. John Symonds and Kenneth Grant. London: Gerald Duckworth & Co., 1974.

———. *The Confessions of Aleister Crowley*. London: Penguin/Arkana, 1989.

———. *Crowley On Christ*. First published in typewritten form as a limited edition of 200 copies as *The Gospel According to St. Bernard Shaw*, 1953. Rev. 2d edition, Ed. Francis King. London: C. W. Daniel Co., 1972.

———. *Eight Lectures on Yoga*. Mahatma Guru Sri Paramahansa Shivaji. London: O.T.O., 1939. *The Equinox* III (4). Rev. 2d edition. Ed. Hymenaeus Beta Scottsdale, AZ: New Falcon Publications, 1991; New York: 93 Publishing, 1992.

———. (Series Editor, 1909-1944). *The Equinox*.. Volume I appeared semiannually from spring 1909 to fall 1913. Volume II was not published. Vol. III(1), Spring 1919, Detroit was the last regular serial number issued. Volume III(2) was not published, but like the whole of Volume II, it is included in the series numbering as if issued. Subsequent numbers appeared irregularly; most are monographs best known by their book title. Numbers subsequent to Volume III(5) were edited and issued posthumously. Last number issued was Volume III(10). While numbers of a Volume V and a Volume VII have been issued, these are considered apocryphal continuations of the original serial.

*The Equinox* I(1). London, Spring 1909. Reprint. York Beach, ME: Samuel Weiser, 1992.

*The Equinox* I(2). London, Fall 1909. Reprint. York Beach, ME: Samuel Weiser, 1992.

*The Equinox* I(3). London, Spring 1910. Reprint. York Beach, ME: Samuel Weiser, 1992.

*The Equinox* I(4). London, Fall 1910. Reprint. York Beach, ME: Samuel Weiser, 1992.

*The Equinox* I(5). London, Spring 1911. Reprint. York Beach, ME: Samuel Weiser, 1992.

*The Equinox* I(6). London, Fall 1911. Reprint. York Beach, ME: Samuel Weiser, 1992.

*The Equinox* I(7). London, Spring 1912. Ed. Mary d'Este Sturges. Reprint. York Beach, ME: Samuel Weiser, 1992.

*The Equinox* I(8). London, Fall 1912. Ed. Soror Virakam. Reprint. York Beach, ME: Samuel Weiser, 1992.



*The Equinox* I(9). London, Spring 1913. Reprint. York Beach, ME: Samuel Weiser, 1992.

*The Equinox* I(10). London, Fall 1913. Reprint. York Beach, ME: Samuel Weiser, 1992.

*The Equinox* III(1) (*The Blue Equinox*). Detroit, Spring 1919. Reprint. York Beach, ME: Samuel Weiser, 1992.

*The Equinox* III(3). Fall 1936, *The Equinox of the Gods*. See entry under book title.

*The Equinox* III(4). Spring 1939, *Eight Lectures on Yoga*. See entry under book title.

*The Equinox* III(5). Spring 1944, *The Book of Thoth*. See entry under book title.

*The Equinox* III(6). Fall 1961, *Liber Aleph*. See entry under book title.

*The Equinox* III(7). Fall 1971, *Shih Yi*. See entry under book title.

*The Equinox* III(8). Spring 1975, *The Tao Teh King*. See entry under book title.

*The Equinox* III(9). Spring 1983, [Thelema] ΘΕΛΗΜΑ: *The Holy Books of Thelema*. See entry under book title.

*The Equinox* III(10). New York, Spring 1986. Reprint. York Beach, ME: Samuel Weiser, 1990.

———. *The Equinox of the Gods*. London: O.T.O.; 1936. *The Equinox* III(3). Corrected facsimile editions. Scottsdale, AZ: New Falcon Publications, 1991, and New York, 93 Publishing, 1992. Although it is not so designated in its title, Crowley identified this work as *Book Four, Part IV*. No author appears on the title page.

———. *The Goetia of Solomon the King*. Ed. Aleister Crowley. Foyers, England: Society for the Propagation of Religious Truth, 1904. Reprint. New York: Magickal Child Publications, 1992.

———. *The Heart of the Master*. London: O.T.O., 1938. Reprint. Scottsdale, AZ: New Falcon Publications, 1992.

———. *Konx Om Pax*. Foyers, England: Society for the Propagation of Religious Truth, 1907. Reprint, with Introduction by Martin P. Starr. Chicago: The Teitan Press, 1990.

———. *Liber Aleph vel CXI. The Book of Wisdom or Folly*. Eds. Karl Germer and Marcelo Motta. Barstow, CA: Thelema Publishing, 1961. *The Equinox* III(6) Rev. 2d edition. Ed. Hymenaeus Beta. York Beach, ME: Samuel Weiser, 1991, and New York: 93 Publishing, 1991.

———. *Little Essays Toward Truth*. London: O.T.O., 1936. Reprint. Scottsdale, AZ: New Falcon Publications, 1991.

———. *Magick*. Eds. John Symonds and Kenneth Grant. London: Routledge & Kegan Paul, 1973; and York Beach, ME: Samuel Weiser, 1974.

———. *Magick In Theory and Practice*. Paris: Lecram Press, 1929. Reprint. New York: Magickal Childe Publications, 1990.

———. *Magical and Philosophical Commentaries of THE BOOK OF THE LAW*. Eds. John Symonds & Kenneth Grant. Quebec: 93 Publishing, 1974.

———. *Magick Without Tears*. Ed. Israel Regardie. Scottsdale AZ: New Falcon Publications, 1991.

———. *The Qabalah of Aleister Crowley*. York Beach, ME: Samuel Weiser, 1973.

———. *Shih Yi*. Ed. H. Parsons Smith. Oceanside, CA: Thelema Publications, 1971. *The Equinox* III(7).

———. *The Tao Teh King*. Ed. H. Parsons Smith. Oceanside, CA: Thelema Publications, 1971. *The Equinox* III(8).

——— (received by). [Thelema] ΘΕΛΗΜΑ: *The Holy Books of Thelema*. Eds. Hymenaeus Alpha and Hymenaeus Beta. York Beach, ME: Samuel Weiser, 1983. *The Equinox* III(9). Corrected 2nd. printing Samuel Weiser, 1990, and New York: 93 Publishing, 1990.

———. *The Works of Aleister Crowley*. Ed. I. Back. Foyers, England: Society for the Propagation of Religious Truth, 1905-7. Reprint. Homewood, IL: Yoga Publication Society, [c.1978].

Douglas, Nick, (with Penny Slinger). *Sexual Secrets*. Rochester, VT: Destiny Books, 1989.

DuQuette, Lon Milo (with C. S. Hyatt). *Aleister Crowley's Illustrated Goetia*. Scottsdale, AZ: New Falcon Publications, 1992.

———. (with C. S. Hyatt). *Enochian World of Aleister Crowley*. Scottsdale, AZ: New Falcon Publications, 1991.

Eliade, Mircea. *A History of Religious Ideas, 3 Volumes*. Chicago: University of Chicago Press, 1984.

Forlong, James George Roche, Maj.-Gen. *Rivers of Life, or, Sources and streams of the faiths of man in all lands; showing the evolution of faiths from the rudest symbolisms to the latest spiritual developments*. London: B. Quaritch, 1883.

Fuller, J.F.C. *The Star in the West*. New York: The Walter Scott Publishing Co. Ltd., 1907. Reprint. Mokolumne Hill, CA: Health Research, 1969.

Godwin, Joscelyn. *Mystery Religions in the Ancient World*. London: Thames and Hudson, 1981.

Graves, Robert. *The White Goddess*. New York: Farrar, Straus and Giroux, 1978.

Hermes, Trismegistus. *The Pyramander of Hermes*. Ed. W. Wynn Westcott. *Collectanea Hermetica*, vol. 2. London and New York: Theosophical Pub. Society, 1894.

Huysmans, Joris-Karl. *En Route*. Trans. David Blow. Sawtry, England: Dedalus, 1989.

———. *La Bas {Lower Depths}*. London: Dedalus, 1986.

James, William. *The Varieties of Religious Experience*. London: Longmans, 1910.

Julianus. *The Chaldean Oracles*. Trans. Ruth Majereik. London and New York: Brill, 1989.

———. *The Chaldean Oracles of Zoroaster*. Ed. W. Wynn Westcott. *Collectanea Hermetica*, vol. 6. Wellingborough, England: Aquarian Press, 1983.

Jung, Carl G. *Man and His Symbols*. London: Aldus Books, 1964.

King, Francis. *The Magical World of Aleister Crowley*. New York: Coward, McCann & Geoghegan, 1978.

Levi, Eliphas. *The Key of the Mysteries*. Trans. Aleister Crowley. (York Beach, ME: Samuel Weiser, 1973.

———. *The History of Magic*. Trans. Arthur Edward Waite. London: Rider, 1957.

———. *Transcendental Magic: Its Doctrine and Ritual*. Trans. Arthur Edward Waite. York Beach, ME: Samuel Weiser, 1970.

Mathers, S.L. MacGregor. Trans. *The Book of The Sacred Magic Of Abra-Melin, The Mage*. New York: Dover Publications, 1975.

———. Trans. *The Kabbalah Unveiled*. York Beach, ME: Samuel Weiser, 1974.

Regardie, Israel. *The Eye in the Triangle*. Phoenix: Falcon Press, 1989.

———. *The Golden Dawn*. 6th edition. St. Paul: Llewellyn Publications, 1992.

——— and P.R. Stephensen. *The Legend of Aleister Crowley*. Phoenix: Falcon Press, 1986.

Seckler, Phyllis. *In the Continuum, Vol 1-V*. Oroville, CA: Seckler, 1973-1993.

Stirling, William. *The Canon*. London: R.I.L.K.O., 1974.

Suarès, Carlo. *The Sepher Yetsira*. Trans. Micheline & Vincent Stuart. Boulder, CO & London: Shambhala, 1976.

Suster, Gerald. *The Legacy of the Beast*. York Beach, ME: Samuel Weiser, 1989.

Turner, Robert. *Elizabethan Magic*. Longmead, Shaftesbury, Dorset, England: Element Books Ltd., 1989.

Wilhelm, Richard. *The Secret of the Golden Flower*. Trans. Cary F. Baynes. New York: Wehmn, 1955.

Von Eckartshausen, Karl. *The Cloud Upon the Sanctuary*. Kingston, NY: Societas Rosicruciana In America, 1952.

Yuteswar Gurum (Sri) Jnanavatar Swami. *The Holy Science*. Ranchi, Bihar, India: Yogoda Satsanga Society of India, 1963.

## Index

- ΑΠΟ ΠΑΝΤΟΣ  
    ΚΑΚΟΔΑΙΜΟΝΟΣ, 89  
ΕΥΧΑΡΙΣΤΟΣ, 89  
ΙΣΧΗΥΡΟΣ, 89  
ΚΕΦΑΛΗ ΕΒ, 197  
    θημα, 25  
ΩΦΑΛΛΕ, 89  
ΣΟΙ, 89
- A.: A., 103, 191, 202, 211, 214,  
    216, 220  
abbai, 205  
Abbey of Thelema, 137, 143,  
    193  
abdomen, 104  
Abomination of Desolation, 38  
Abra-Melin, 134, 136  
Abrahadabra, 36, 42, 44, 86,  
    105, 126, 127, 174, 195, 196  
Abraham the Jew, 134  
Abrasax, 140, 155, 161  
Abyss, 83, 86, 177, 220  
AChD, 110  
Adad, 140  
Adam, 140  
Adeptus, 219  
    Exemptus, 218  
    Major, 218  
    Minor, 135, 143, 144, 147,  
        180, 216, 218  
ADNI, 60  
Adonai, 75, 140  
Adonis, 14, 140  
adorations, 191, 195  
Aegipan, 141  
    aeon, 54  
        of Horus, 15, 16, 18, 19, 54,  
            78, 84, 86, 91, 92, 93, 103,  
            105, 137, 165  
        of Isis, 10, 11, 12, 15  
        of Osiris, 12, 13, 15, 85, 117  
        of the Crowned and  
            Conquering Child, 177  
Aethyr, 78, 150, 242  
Agape, 85, 104  
Age of Aquarius, 7  
Age of Pisces, 14  
AGLA, 60, 74, 75  
Ahathoor, 40, 191, 193  
AHBH, 110  
AHIH, 60  
Ain, 80, 166  
Ain Elohim, 210  
Ain soph, 80, 144  
Ain soph aur, 81  
Aiwass, 19, 22, 84  
Aiwaz, 84, 94, 104, 107  
Ajna, 94  
akasha, 150, 211  
Al, 74, 107, 109, 111  
Aleph, 110  
Amoun, 238  
Anatta, 6  
Anahata, 94  
Ananda, 202  
Andrea, 238  
Angel 68, 111, 137, 147, 159,  
    163, 164, 171, 172, 173, 176  
    of Light, 111  
    of the Lord, 112  
Animadversion, 103

- Ankh-af-na-khonsu, 23, 25,  
     40, 85, 193  
 Ankh-f-n-khonsu, 45, 146, 147  
 anthropomorphic female deity,  
     10  
 Apollonius Tyanaeus, 238  
 Apophis, 9, 90, 119  
 Apophrasz, 145, 148  
 Aquarius, 105  
 Ararita, 115, 120, 121, 129, 130,  
     131  
 archangels, 57, 68, 69  
     of Tiphereth, 137  
 Arents Research Library, 99  
 Artemis, 149  
 Arthur, 238  
 Asana, 180, 211  
 Asar, 26  
 Asar Un-Nefer, 145  
 Ashmole, Elias, 238  
 Asseveration of the Spells, 104  
 Astarte, 110  
 astrological sigil, 121  
 Ateh, 59, 73, 84  
 Ateh-Malkuth, 93  
 Attis, 14, 140  
 Aum, 6, 86  
 Aumgn, 86, 104, 174  
 Auriel, 60  
 Ayin, 70  
  
 Ba, 166  
 Babalon, 79, 81, 82, 83, 86, 89,  
     90, 93, 94, 104, 106, 110,  
     154, 177, 229  
 Babe on the Lotus, 209  
 Bacchae of Euripides, 222  
 Bacchus, 91, 106, 145  
 Bacon, Francis, Lord Verulam,  
     238  
 Bacon, Roger, 238  
 Bahlasti, 43  
 Baphomet, 91, 107, 129, 149,  
     229  
 Baptism, 229, 247  
 Barbarous Names, 138, 143,  
     148  
 Bardesanes, 238  
 Basilides, 238  
 Bavariae, Ludovicus Rex, 238  
 Beast, 23, 37, 38, 42, 81, 82, 93,  
     110, 112, 143, 147, 149, 165,  
     166, 167, 169, 173, 174, 177,  
     199  
 bell, 195, 197  
 Bennett, Frank, 137  
 Bes-na-Maut, 40, 194  
 Besz, 145  
 Bhakti Yogi, 133  
 Bible, 82  
 birth, 13  
 black magic, 133  
 blood, 38  
 Body of Light, 138, 144, 169,  
     180  
     of Nuith, 144  
 Boehme, Jacob, 238  
 Boleskine, 103, 105, 106, 107,  
     136, 148, 156, 227  
*Book of the Law*, 17, 41, 43, 44  
 Book of the Revelation of John,  
     82, 92  
*Book of Thoth*, xiii  
 Bornless One, 144, 180  
 Bornless Spirit, 163  
 Borgia, Roderic Pope  
     Alexander the Sixth, 238  
 Boulak museum, 19  
 Brahma, 83  
 Brahmarandra-Cakkra, 157  
 bread, 145

- Bride, 32, 38, 199  
 Buddhist, 43  
 bull, 56  
 burin, 187, 195  
 Burton, Sir Richard Francis, 239  
 Byblos, 8
- Cairo, 18  
 Cake of Light, 144, 187, 188, 195, 228, 247  
 Caput, 121  
 carbon, 53  
 Cardinal Signs, 117  
 Carolus Magnus, 238  
 Catullus, 238  
 Cauda Draconis, 121  
 Cefalu, 137  
 Cephalaeidum, 143  
 Ceremony of the Introit, 228  
 Ceremony of the Invocation of the Holy Guardian Angel, 179  
 Ceremony of the Opening of the Veil, 232  
 Ceylon, 18  
 chakras, 93, 95  
 Chaos, 82, 216, 229  
 Charioteer, 86  
 Cheth, 86, 126  
 Chiah, 147  
 China, 136  
 Chokmah, 82, 83  
 Christ, 14, 133  
 Christian fundamentalism, 81  
 Christian Mysticism, 221  
 Christian Rosencreutz, 238  
 Christianity, xvi, 2, 14, 82
- Confirmation, 247  
 consciousness, 149, 157, 159  
 Consecration of the Elements, 241  
 consecration of the magical weapons, 75  
 Constant, Alphonse Louis, 238  
 Consummation of the Elements, 245  
 courage, 110  
 covenant, 137  
 Cremnophobia, 207  
 crone, 11  
 Cross of the Elements, 51  
 Cross Qabalistic, 90  
 Crowley, Sir Aleister, 239  
 crown, 195, 205, 206, 232  
 Crowned and Conquering Child, 81  
 cult of Osiris, 9  
 cult of the Goddess, 15  
 Cup, 51, 140, 238  
   of Babalon, 83, 161  
   of the Priestess, 130
- Daath-Binah, 116  
 daemons, 92  
 death, 12, 13, 14, 29, 35  
 Dee, John, 78, 238  
 Degree Initiations, 222  
 Demeter, 9  
 deosil, 57, 74, 75  
 Devil, 140, 141, 166  
 devil-worship, 141  
 dew, 24, 157, 159  
 dictation, 20  
 Dieu Garde, 236  
 Din, 43



- Dionysus, 14, 166, 238  
 direction, 57  
 disk 166, 238  
 Divine Name, 68, 79, 87  
 Divine Will, 82, 83  
 Dominus Liminis, 219  
 Double Gift of Tongues, 126  
 Double Wand of Power, 44  
 dove, 112  
 dragon, 148  
 Dragon-Serpent, 155  
 dying god, 14, 15
- eagle, 137  
 Earhart, Amelia, xvi  
 Earth, 53  
 Ecclesiae Gnosticae Catholicae  
     Canon Missae, 227  
 egg, 148, 166  
 Egypt, 18  
 Eheieh, 73  
 Eidolon, 204  
 eight, 26  
 eighty, 26  
 electromagnetic force, 53  
 electrum magicum, 232  
 elemental spirits, 70  
 elemental tablets, 78  
 Elemental Watchtowers, 69  
 elemental world, 52  
 Eleusinian Mysteries, 14  
 eleven, 30  
 Elevenfold Seal, 103  
 elixir 147, 206, 207  
 Elohim, 74  
 Encasse, Doctor Gerard, 239  
 Enchanted Princess, 158  
 Enchantment, 105
- Enochian Magick, 69, 78  
 Enochian words, 69  
 environmental movement, 15  
 Epiphany, 132  
 Equilibrium of Contraries, 109  
*Equinox of the Gods*, 26, 32,  
     127  
 equinoxes, 117  
 Eucharist, 90, 131, 188  
 Euphrates, 140  
 Eurydice, 9  
 evil spirit, 90  
 Exorcist 29, 209
- father, 12, 13, 82, 113  
 Father-Mother, 110, 111  
 fear of death, 15  
 feast, 211, 214, 235  
     of the times, 32  
 FIAOF, 86, 104  
 Final Gesture, 108  
 Fivefold Sword of Flame, 161  
 Five Pointed Star, 27  
 Flaming Star, 114  
 Fluctibus, Robertus, 238  
 Fool, 109, 145  
 Forlong dux, 239  
 Formula  
     magical, 5, 6, 9, 10, 146  
     of Isis, 10, 11, 12  
     of the Crowned and  
         Conquering Child, 15  
     of the Dying God, 12  
     of the Great Goddess, 10, 14  
     of the New Age, 6  
 four adorations, 186  
 four gates, 26  
 Four Great Princes of Evil, 135

- four hundred & eighteen, 26  
 four Kerubic Beasts of Ezekiel,  
     55  
 Foyers, 227  
 Freemasonry, 221
- Gabriel, 60  
 Gaugin, Paul, 239  
 Geb, 8  
 Geburah, 59, 73, 84, 86, 90, 93  
 Gedulah, 59, 73, 84, 93  
 geocentric, 100  
 Gerald Yorke collection, xiv  
 gestures, 54, 70  
 gnomes, 51  
 Gnostic Masses, 222, 225  
 Gnostics, 9  
 goat of Mendes, 166  
 God names, 54, 69, 90  
 God-Man, 81  
 Goddess, 205  
 gods of Egypt, 7  
 Gods of the Aeon, 110  
 God's Will, 2  
 Goethe, Wolfgang, 238  
 Goetia, 69  
 gold, 232  
 Golden Dawn, 70, 95, 115, 117,  
     134, 138, 216  
 Goodwin, Charles Wycliffe,  
     137  
 Governors, 78  
 Grade of 1° = 10<sup>o</sup>, 71  
 Grade of 2° = 9<sup>o</sup>, 70  
 Grade of 3° = 8<sup>o</sup>, 70  
 Grade of 4° = 7<sup>o</sup>, 70  
 Grade of the Portal, 70  
 Grand Architect of the  
     Universe, 3
- gravitational force, 53  
 Great Equinox, 39  
 Great Sea, 231  
 Great Whore, 82, 83  
 Great Wild Beast, 161  
 Great Work, 3, 86, 93, 111, 116,  
     126, 174, 186, 192, 217, 248  
 Greater Ritual of the  
     Hexagram, 115  
 Greater Ritual of the  
     Pentagram, 56, 69, 71, 73,  
     75, 78, 98, 195  
 Greek Alphabet, 88  
 groin, 91
- Had, 22, 34, 181  
 Hadit, 22, 23, 29, 30, 36, 38, 41,  
     42, 79, 80, 81, 89, 91, 94,  
     109, 144, 148, 166, 194, 199,  
     201, 204, 205, 206, 207, 208,  
     209, 210, 212, 213  
 Hadith, 103, 106, 149, 155, 157,  
     161  
 Hailing sign of a Magician, 230  
 Harpocrates, 9, 66, 109, 145,  
     209  
 Hawk-Headed Lord of Silence  
     & of Strength, 44  
 heathen, 238  
 Hebrew letter, 140  
 Heh, 53, 130, 131, 135  
 Heh-final, 131  
 heliocentric, 100  
 Helios, 191  
 Heracles, 238  
 herald, 111  
 Hercules, 14  
 Hermes, 147, 163, 166, 238  
 Hermit, 25, 111, 165

- Heru-pa-kraath, 29  
 Heru-ra-ha, 39, 81  
 hexagram, 77, 120  
   of the Beast, 77, 97, 113  
   Ritual, 117  
   unicursal, 97, 117, 125, 131  
 Hierophant, 26, 30, 145, 165  
 Hippolytus, 238  
 Hiram, 140  
 Hitler, xvi  
 Hod, 67  
 Hohenstaufen, Frederick of,  
   238  
 Holy Blood, 188  
 Holy Ghost, 110, 149, 150  
 Holy Graal, 83, 86, 227, 230  
 Holy Guardian Angel, 81, 84,  
   116, 127, 133, 134, 143, 144,  
   145, 157, 170  
 Holy Hexagram, 118, 125, 126,  
   129  
   of Air, 131  
   of Earth, 131  
   of Fire, 130  
   of Water, 131  
 holy place, 39  
 Holy Spirit, 111, 243  
 holy words, 79  
 Hoor, 9, 26  
 Hoor-pa-kraat, 39, 81  
 Hoor-paar-Kraat, 9, 19, 84  
 Horizontal Components of the  
   Enchantment, 104  
 Horus, 7, 9, 19, 81, 127, 145  
 Horus-Harpocrates, 111  
 House of God, 27  
 House of The Beast 666, 103  
 Hrumachis, 39  
 human sacrifice, xiv, xv  
 Hutten, Ulrich, 238  
 hydrogen, 53  
 Ia-Apophrasz, 145, 180  
 Ia-Besz, 145, 180  
 IAF SABAF, 165, 166, 184  
 IAO, 9, 86, 90, 154, 157  
 IHVH, 53, 60  
 illumination, 171  
 incantation, 92, 93, 206, 207  
 Incense of Abramelin, 144  
 Indian, 43  
 Initiation of the Candidate,  
   222  
 Innana, 10  
 INRI, 6, 90, 117, 119  
 Invocation, 180, 204, 206  
 Invocation of the Holy  
   Guardian Angel, 136, 137  
 invokes Spirit, 156  
 Invoking Hexagram of The  
   Beast, 107  
 Io Pan, 91  
 Ipsissimus, 163, 218, 220  
 Isa, 26  
 Ishtar, 10  
 Isis, 7, 8, 9, 90, 91, 119  
 Isis in Welcome, 107  
 Islam, 2  
 Iynges, 92  
 Jechidah, 147  
 Jehovah, 53  
 Jennings, Hargrave, 239  
 Jesus, 42  
 Jones, George Cecil, 216  
 Judaism, 2  
 Jupiter, 77, 121  
 justice, 109

- Ka, 40, 193  
 Kaaba, 41  
 Kamuret, 238  
 Kellner, Karl, 221, 239  
 Kelly, Edward, 238  
 Kephra, 40  
 Kerubic symbols, 69  
 Kether, 80, 81, 82, 83, 144, 163, 176, 207  
 Khabs, 22, 29, 40, 193, 201  
 Khem, 91, 106, 146, 147, 238  
 Khephra, 192, 193  
 Khu, 22, 40, 193  
 Kiblah, 37, 148  
 King, 30, 31, 34, 35, 39, 113, 158, 210, 212  
 knife, 197  
 Knight, Sir Richard Payne, 239  
 Knowledge and Conversation of the Holy Guardian Angel, 125, 133, 160, 165, 169, 173, 216, 220  
 Krishna, 133, 238  
 kteis, 12, 109  
 Kundalini, 83  
  
 L.V.X., 61, 91, 119, 129, 130, 156, 183  
 LA, 107, 109, 111  
 Lance, 238  
 Laotze, 238  
 LASHtAL, 85, 104, 109  
 Law of Thelema, 225  
 Leda, 112  
 Lesser Ritual of the Hexagram, 114, 117, 119  
 Lesser Ritual of the Pentagram, 56, 59, 69, 117  
 Levi's Hexagram, 127  
  
 Liber, 127, 418, 220  
 Liber CLXXV, 144  
 Liber HAD, 208  
 Liber LXV, 144, 148, 164  
 Liber NV, 201  
 Liber Resh, 186, 191  
 Liber Samekh, 138, 143, 178  
 Liber V vel Reguli, 78, 92, 93, 99, 103  
 Liber XLIV, 195  
 Liber XV, 227  
 Liber XXV, The Star Ruby 78  
 Light of the Cross, 119  
 Light of the Gnosis, 238  
 Light Withdrawn, 91  
 Limitless Light, 81  
 lingam, 85, 130  
 Lion, 55, 110, 112, 137, 149, 229, 246  
 Lion-Serpent, 159, 160  
 Loch Ness, 136, 227  
 Logos of the Aeon of Horus, 83  
 Lord of Thebes, 40  
 Lord of Time, 113  
 love, 163, 173  
     sexual, 86, 110  
     song, 28, 201, 205, 208, 234  
 Lover, 25  
 Luna, 77  
  
 macrocosm, 78, 114  
 magical aeons, 7  
 magical circle, 100  
 magical race, 147  
 Magick, 1, 3  
     Rood, 129, 130  
     sexual, xv, xvii, 121, 124, 128, 221  
*Magick without Tears*, xiii

- Magister Templi, 218, 220  
 Magus 177, 218, 220  
 Magus of Taro, 209  
 Magus, Simon, 238  
 maid, 11  
 Maier, Michael, 238  
 Malkuth, 59, 73, 84, 97  
 man, 12  
 man of Earth, 25  
 man-god, 112  
 Manes, 238  
 Manipura, 94  
 mantras, 25  
 Mark of Cain, 93  
 Mark of the Beast, 93, 107, 156,  
 183  
 Mars, 77  
 Martialis, 238  
 Mary, 43, 112  
 Mass of Ecclesia Gnostica  
 Catholica, 223  
 Mass of the Phoenix, 186, 195  
 Mass of the Roman Catholic  
 Church, 124  
 Master of Life, 223  
 Mater Triumphans, 107  
 Mathers, S. L. MacGregor, 134  
 Matter-in-Motion, 111  
 McMurtry, Major G.L., xiv, 77  
 Medicine of Metals, 56  
 Melchizedek, 238  
 Mentu, 40, 91, 106, 193, 238  
 Mercury, 67, 70, 77, 111  
 Merlin, 238  
 Michael, 60, 137  
 microcosm, 52, 77  
 Microcosm of Vitruvius, 91,  
 107  
 Middle Pillar, 93, 137  
 Miracle of the Mass, 229  
 Mohammed, 43, 238  
 Molensis, Jacobus Burgundus,  
 238  
 Molinos, 238  
 Mongol, 43  
 moon, 23, 67, 111, 137, 163  
 Mosheh, 147, 238  
 mother, 11, 12  
 motion, 111  
 Muladhara Cakra, 91  
 Mulier, 91, 106  
 mystery of schools, 14  
 Mystic Marriage, 245  
 Mystic Rose, 129, 130  
 myth of Christianity, 9  
 Myth of Osiris, 8  
 N.O.X., 61, 87, 89, 91, 98, 129,  
 130, 132  
 naught, 110  
 navel, 104  
 Neophyte, 219  
 Ritual, 145  
 Nephthys, 8  
 Neschamah, 147  
 Netzach, 67  
 new aeon, 7, 78, 145, 177, 216,  
 225  
 Nietzsche, Friedrich, 238  
 Night of Pan, 91  
 Nile river, 8, 140  
 nitrogen, 53  
 No Limit, 80  
 Not-Being, 111  
 Nothing, 80  
 Nothing-Matter, 111  
 Nu, 29, 32, 34, 36, 38, 42, 181,  
 235  
 Nuit 22, 23, 24, 28, 30, 31, 41,

- 79, 80, 81, 89, 90, 94, 109,  
194, 199, 201, 202, 203, 205,  
206, 207, 208, 212, 213, 214,  
233
- NUTH, 103, 105, 148, 157, 166  
number, 140  
Nun, 119  
Nut, 8
- O.T.O. (*see* Ordo Templi  
Orientis)  
Oath of the Enchantment, 103  
Odysseus, 238  
Official publications of  
    A.: A.:, 20  
Olahm, 59, 73, 84  
Ompehda, 43  
On, 161, 242  
Ordeal x, 38, 199  
order of the G.D., 218  
order of the R.C., 218  
order of the S.S., 218  
Ordo Templi Orientis, xiv, 216,  
    220, 221  
Orpheus, 9, 14, 238  
Osiris, 7, 8, 9, 18, 90, 119, 145,  
    192, 233, 238  
oxygen, 53
- Pan, 84, 87, 91, 106, 145, 149,  
    166, 238  
Pantacle, 204, 206  
Paracelsus, 238  
Parzival, 109, 238  
Path of Cheth, 86  
Path of Samekh, 137  
Path of Teth, 95, 97  
Path of the High Priestess, 176
- Pentagram, 52, 53, 56, 60, 78,  
    89, 95, 99, 105, 106, 156,  
    204  
    active, 69  
    averse, 82, 83, 84  
    banishing, 55  
    inverted, 96  
    invoking, 144, 145  
    of Air, 73  
    of Earth, 75  
    of Fire, 74  
    of Water, 74  
    passive, 70, 74, 75  
    Spirit, 69, 73, 74  
    Ritual, 51, 84, 87, 93, 117  
perfume, 38, 204, 206, 207, 208,  
    233, 234  
Persephone, 9, 14  
Pé, 67, 68, 70, 78  
phallus, 12, 90, 104, 109, 145,  
    153, 185  
Philosophus, 218, 219  
Phoenix, 197  
Pillar of Mercy, 93  
Pillar of Severity, 93  
platinum, 232  
Pope, 15  
power, 32  
Practicus, 219  
pralaya, 91  
Preliminary Invocation of the  
    Goetia, 18  
Priapus, 238  
Prince, 135  
Prince Chioa Khan (Beast), 18  
Prince/Vav, 116  
Princess, 135  
Princess Ouarda (Rose), 18  
Princess/Heh, 116  
Probationer, 219

- Proclamation of the  
 Accomplishment, 105  
 Frater Progradior, 137, 143  
 prophet, 24, 27, 29, 31, 32, 33,  
 34, 36, 37, 39, 40, 146, 212,  
 235  
 psychopomp, 192  
 Ptah, 107  
 Ptah-Apo-Phrasz-Ra, 147  
 Pthah, 233  
 Puella, 91, 105  
 Puer, 91, 106  
 Pythagoras, 238
- qabalistic correspondences,  
 140  
 Qabalistic Cross, 61, 69, 84, 93,  
 117  
 Qoph, 70  
 Queen, 158  
 of Heaven, 24  
 of Space, 24, 233  
 Quinaries of the Zodiac, 202
- Ra, 40, 43, 191, 192, 193, 195  
 Ra Hoor Khu, 81  
 Ra Hoor Khuit, 26, 80  
 Ra Hoor Khut, 36, 81  
 Ra-Hoor, 191  
 Ra-Hoor-Khu, 34, 37, 181  
 Ra-Hoor-Khu-it, 25  
 Ra-Hoor-Khuit, 26, 30, 40, 41,  
 81, 85, 94, 104, 145, 148,  
 157, 166, 180, 194, 197, 202  
 Ra-Hoor-Khut, 39  
 Rabelais, 238  
 rainbow, 137  
 Raphael, 60, 68  
 redemption, 163  
 Regardie, Israel, xiii, xiv, 84,  
 95, 136  
 Religion of Thelema, 225  
 Resh, 70, 119, 186  
 resurrection, 10, 13, 14, 242,  
 247  
 Reuss, Doctor Theodor, 124,  
 239  
 Rising on the Planes, 179  
 Rites of Eleusis, 222  
 Ritual  
 Bornless Ritual, 138  
 Class A, 20  
 Class B, 20  
 Class C, 20  
 Class D, 20, 103, 143, 199, 201  
 Dramatic, 222  
 employed by the Beast 666,  
 143  
 of Self-Initiation, 86  
 of the elements, 32  
 of the Hexagram, 123  
 of the Mark of the Beast, 92,  
 103  
 of the Pentagram, 114  
 of the Star Ruby, 56  
 Thelemic rituals, 20  
 Rood Cross, 210, 213  
 Rose, 18, 136, 201, 208  
 Rosicrucian grade system, 216  
 Rosy Cross, 131, 132  
 Ruach, 115, 147, 150, 176  
 runes, 31
- SABAF, 166  
 Sacrament, 129, 145, 149, 247,  
 248  
 sacramental sign, 196

- sacred lance, 145, 228  
 sacrifice, 15, 27, 37, 39, 188, 242  
     to the gods, 14  
 SAHASRARA, 94  
 salamanders, 51  
 Samadhi, 144, 202, 214  
 Samech, 70  
 Samekh, 67, 78  
 Sangraal, 161  
 Satan, 110, 139, 140, 149, 153,  
     166  
 Saturn, 77, 110, 140  
 scarab, 193  
 scarlet concubine, 37  
 scarlet woman, 23, 41, 82  
 scents, 26  
 Schyren, William of, 238  
 Scin-Laeca, 163  
 seal of illumination, 93  
 Secret Chiefs, 218  
 secret seed, 111  
 Self, 159, 163, 176  
 self-mutilation, 187  
 Sephirah, 82  
 Sephiroth, 115, 216  
 Serpent, 31, 41, 83, 110, 112,  
     148, 149, 204, 229, 246  
     flame, 28  
     Kundalini, 210  
 Set, 129, 140  
 Set-Isis, 111, 112  
 Seth, 8, 9  
 Sh, 110  
 Shakti, 83  
 Shemhamphorash, 202  
 Shin, 53, 70  
 Shiva, 83  
 Shivalingam, 179  
 ShT, 107, 110, 111, 141  
 Shu, 8, 150  
 Siddartha, 238  
 sigil of Cancer, 127  
 Sigil of the Grand Hierophant,  
     95, 104  
 sign, 54  
     of 2° = 9°, 73  
     of 3° = 8°, 75  
     of 4° = 7°, 74  
     of Apophis and Typhon, 119  
     of Hoor-paar-Kraat, 89  
     of Horus, 89, 90, 105  
     of Isis Rejoicing, 130  
     of Mater Triumphans, 131  
     of Osiris Risen, 119  
     of Osiris Slain, 119  
     of Set, 131  
     of silence, 192, 195  
     of the Enterer, 90, 105, 148,  
         195  
     of the Grades, 70, 148  
     of the Mourning of Isis, 119  
     of the Portal, 73, 74, 75  
 Sin, 25  
 six-rayed Star, 61  
 Sixfold Star, 113, 114, 161  
 Sixty-one, 26  
 snake, 31, 39  
 Sol, 119  
 solar axes, 117  
 solar cycle, 13  
 solar plexus, 104  
 solar worship, 185  
 solstices, 117  
 Son-Daughter, 111  
 Soul-symbol, 169  
 Souls of the Waters, 52  
 spells, 25  
 Sphere of Nuith, 156



- spiral dance, 107  
 Spirit 53, 151  
 Spirit descending into matter, 101  
 Spirit of God, 112  
 Spirit of the Child, 202  
 Spirits of Living Fire, 51  
 Spirits of the elements, 51  
 Spirits of the Evening Breeze, 52  
 Spiritual congress, 111  
 spiritual fatigue, 2  
 Star of Force and Fire, 108  
 Star Ruby, 78, 87, 89, 90, 93, 96, 123, 187  
 Star Sapphire, 98, 114, 115, 116, 118, 123, 129, 187  
 Star-spate, 160, 169  
 Stélé of Revealing, 19, 37, 38, 80, 85, 110, 201, 208, 227  
 Stephensen, P.R., xiii  
 Stone of the Wise, 56, 192  
 strong force, 53  
 Student, 219  
 Sumeria, 10  
 Summum Bonum, 192, 248  
 sun, 13, 15, 23, 57, 67, 70, 78, 100, 110, 111, 112, 137, 141, 148, 149, 163, 164, 166, 185, 192  
 Sun-lion Serpent, 161  
 Supernal Queen/Heh, 116  
 Supernal Triad, 87  
 Supreme Being, 3  
 Supreme Ritual, 32, 235  
 surrogate mother, 11  
 Suster, Gerald, xiii  
 Svadhithana, 94  
 Swan, 112  
 Swinburne, 238  
 sword, 25, 53, 166, 228, 238  
 Sylphs, 18, 51  
 Synoches, 92  
 Ta-Nech, 40, 194  
 Table of Emerald, 147  
 Tahuti, 32, 191, 192, 235, 238  
 Talisman, 147  
     charging, 75  
 Tantra Yoga, xv  
 Tantric Buddhism, 83  
 Tao, 3, 6  
 tarot, 53, 55  
     Empress, 30  
     trump, 140  
 Tau, 70, 156  
 Tau Cross of the Sephiroth, 180  
 Tefnet, 8  
 Teletarch, 92  
 Temperance, 137  
 Temu, 8  
 terrestrial winds, 78  
 Tetragrammaton, 111, 116, 135  
     IHVH, 53  
*The Eye in the Triangle*, xiii  
*The Legend of Aleister Crowley*, xiii  
 Theban, 40, 193  
 Thebes, 22  
 Thelema, 1, 6, 25, 27, 104, 107, 111, 115, 126, 229  
 Thelemic  
     Holy Words and Divine Names, 79  
     Magick, 93  
     Mysticism, 199

- Orders, 215
- pantheon, 79
- Ritual of the Hexagram, 123
- Rituals of the Pentagram, 77, 92
- Trinity, 80, 81
- Thelemites, 25
- Therion, 78, 81, 82, 83, 90, 94, 106
- Thoth, 192, 209
- Three Grades, 25
- three-fold life cycle, 11, 13
- thurible, 195
- Tiphereth, 67, 135, 137, 144, 156, 163, 164, 176, 180, 183
- Tmu, 193
- To Mega Therion, 238
- Tomb of the West, 231, 248
- tongue of fire, 111
- transcendental states of
  - consciousness, 84
- transmutations, 110
- Tree of Knowledge of Good and Evil, 146
- Tree of Life, 82, 93, 97, 98, 116, 117, 137
- triangle of Fire, 115
- triangle of Water, 115
- True Will, 3, 85
- Tum, 40, 191, 193
- TWIG?, 197
- Two-in-One, 111
- Tzaddi, 70
  
- unconscious Will, 158
- undines, 51
- universal order, 3
  
- unwilled action, 1
- uraeus serpent, 232
- Uruk, 10
  
- Valentinus, 238
- Vau, 53
- Vaughan, Thomas, 238
- Vav, 116, 131, 135
- Veil of Paroketh, 137
- Vel Reguli, 103
- Venus, 67, 77, 110, 193
- Venus de Medici, 105
- Vergilius, 238
- Vertical Component of the
  - Enchantment, 103
- Vibration of the Divine
  - Names, 61
- Victorious City, 37
- Vir, 91, 106
- Virgin, 111
- Virgo, 119
- Virgo Intacta, 228
- Vision of Pan, 142
- Visuddha, 94
  
- Wagner, Richard, 238
- wand, 25, 53, 130, 166
- wanga, 25
- warrior Lord of the Forties, 42
- watery chaos, 8
- Way to Succeed, 126
- Way to Suck Eggs, 126
- weak force, 53
- Weishaupt, Adam, 238
- Wheel of Fortune, 55
- Wheel of Spirit, 113

- Wheel of the Gunas, 150  
widdershins, 57, 87, 107, 181,  
182, 183  
Will, 3, 32, 157, 159, 160, 166,  
169  
willed action, 1  
wine, 145  
Winter Solstice, 140  
woman, 12  
Woman's Movement, 15  
Word, 54, 110, 111  
  of Double Power, 126  
  of Power, 105  
  of the Aeon, 174, 221  
world-ash, 244, 245  
worm, 34  
yearly death, 13  
Yesod, 67, 137  
Yetzirah, 116  
YHVH, 6, 73  
Yod, 53, 111, 119, 130, 131  
yoni, 85, 130  
Zelator, 219  
Zeus, 150, 163  
zodiac, 100, 117

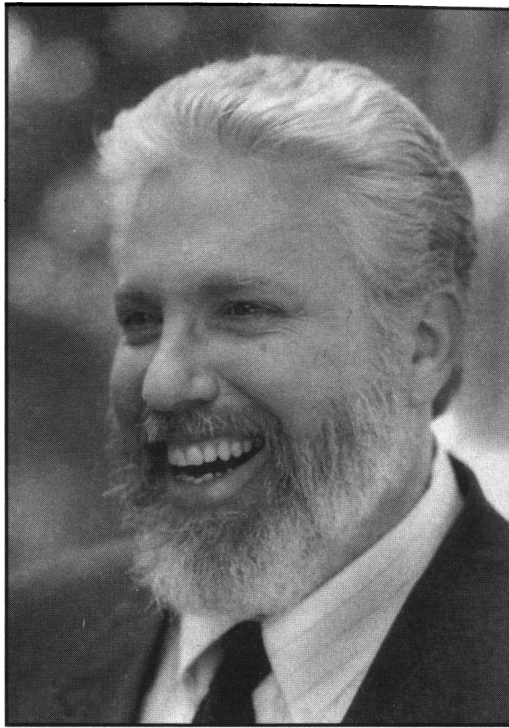

Paul J. Maska

Since 1975, Lon Milo DuQuette has been a national administrative officer of Ordo Templi Orientis, giving him access to the published and unpublished literary treasures of the Order's archives and associated private collections. As Lodge Master of one of the largest local O.T.O. bodies in the world, he is considered one of the finest Thelemic ritualists of the day.

A native Californian, he worked as a studio musician and contract artist for CBS Records in the early 1970s and recorded on the Epic label while studying at the Lee Strassberg Theatrical Institute in Hollywood. His early passion for Yoga and Eastern Mysticism inspired him to study the equivalent of spiritual disciplines of the West, and led him inevitably to the writings of Aleister Crowley and the work of the O.T.O.

He lives in Newport Beach California with his wife and their son. He is an administrator of a small southern California investment firm.

# Magick

Magick has been called the "Yoga of the West," and never before has interest in the subject been greater. Today one cannot embark upon even the most superficial study of the subject without encountering the works and personality of Aleister Crowley (1875-1947). His impact upon Western spiritual tradition is incalculable, yet beginning students frequently find it difficult, if not impossible, to grasp the post-graduate level of Crowley's writings. Now Crowley scholar Lon Milo DuQuette shares the insights of over twenty years of research and practice in what can be described as a "Crowley primer."

Using simple, straightforward language (uncharacteristic in books of this nature), DuQuette traces the evolution of modern Ceremonial Magick and painlessly discusses the foundations and intricacies of Crowley's thought. He then challenges the reader to put this knowledge into practice by offering initiated commentaries upon Crowley's most popular and celebrated rituals.

*The Magick of Thelema* is without question the most unintimidating, amusing and user-friendly guide to the works of Aleister Crowley ever written. It is truly *A Handbook of the Rituals of Aleister Crowley* and as such is an indispensable addition to every magickal library.

Foreword by Hymenaeus Beta X<sup>o</sup>



SAMUEL WEISER, INC.  
——— Box 612 ———  
York Beach, ME 03910

*Cover Design by  
Sarah Foley Lamont*